

LC4H Counters

**UL File No.: E122222
C-UL File No.: E122222**

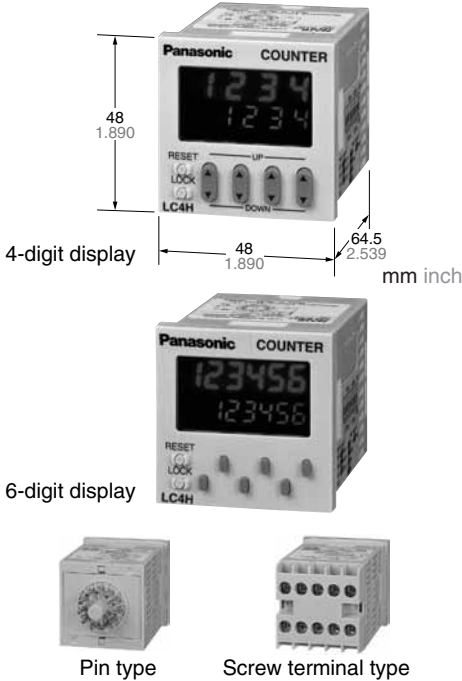

Features

- Bright and Easy-to-Read Display**
A brand new bright 2-color backlight LCD display. The easy-to-read screen in any location makes checking and setting procedures a cinch.
- Simple Operation**
Seesaw buttons make operating the unit even easier than before.
- Short Body of only 64.5 mm 2.539 inch (screw type) or 70.1 mm 2.760 inch (pin type)**
With a short body, it easily installs in even narrow control panels.
- Conforms to IP66's Weather Resistant Standards**
The water-proof panel keeps out water and dirt for reliable operation even in poor environments.

5. Screw terminal and Pin Type are Both Standard Options

The two terminal types are standard options to support either front panel installation or embedded installation.

6. Changeable Panel Cover

Also offers a black panel cover to meet your design considerations.

7. 4-digit or 6-digit display

Two sizes of displays are offered for you to choose the one that suits your needs.

8. Compliant with UL, c-UL and CE.

RoHS Directive compatibility information
<http://www.nais-e.com/>

Product types

| Digit | Count speed | Output mode | Output | Operating voltage | Power down insurance | Terminal type | Part number | |
|-------|--|--|----------------|-------------------|----------------------|----------------|-----------------|-----------------|
| 4 | 30 Hz (cps)/ 5 KHz (Kcps) switchable | <ul style="list-style-type: none"> Maintain output/hold count Maintain output/over count I Maintain output/over count II One shot/over count One shot/recount I One shot/recount II One shot/hold count (7 modes) | Relay (1c) | 100 to 240 V AC | Available | 8 pins | LC4H-R4-AC240V | |
| | | | | | | | 11 pins | LC4H-R4-AC240V |
| | | | | | | | Screw terminal | LC4H-R4-AC240VS |
| | | | | | | | 8 pins | LC4H-R4-AC24V |
| | | | | | | | 11 pins | LC4H-R4-AC24V |
| | | | | | | | Screw terminal | LC4H-R4-AC24VS |
| | | | | | | 8 pins | LC4H-R4-DC24V | |
| | | | | | | 11 pins | LC4H-R4-DC24V | |
| | | | | | | Screw terminal | LC4H-R4-DC24VS | |
| | | | | | | 8 pins | LC4H-T4-AC240V | |
| | | | | | | 11 pins | LC4H-T4-AC240V | |
| | | | | | | Screw terminal | LC4H-T4-AC240VS | |
| 6 | | | Relay (1c) | 100 to 240 V AC | Available | 8 pins | LC4H-R6-AC240V | |
| | | | | | | | 11 pins | LC4H-R6-AC240V |
| | | | | | | | Screw terminal | LC4H-R6-AC240VS |
| | | | | | | | 8 pins | LC4H-R6-AC24V |
| | | | | | | | 11 pins | LC4H-R6-AC24V |
| | | | | | | | Screw terminal | LC4H-R6-AC24VS |
| | | | | | | 8 pins | LC4H-R6-DC24V | |
| | | | | | | 11 pins | LC4H-R6-DC24V | |
| | | | | | | Screw terminal | LC4H-R6-DC24VS | |
| | | | | | | 8 pins | LC4H-T6-AC240V | |
| | | | | | | 11 pins | LC4H-T6-AC240V | |
| | | | | | | Screw terminal | LC4H-T6-AC240VS | |
| | | 8 pins | LC4H-T6-AC24V | | | | | |
| | | 11 pins | LC4H-T6-AC24V | | | | | |
| | | Screw terminal | LC4H-T6-AC24VS | | | | | |
| | | 8 pins | LC4H-T6-DC24V | | | | | |
| | | 11 pins | LC4H-T6-DC24V | | | | | |
| | | Screw terminal | LC4H-T6-DC24VS | | | | | |

* A rubber gasket (ATC18002) and a mounting frame (AT8-DA4) are included.

LC4H-L Counters

UL File No.: E122222
C-UL File No.: E122222



AEL11 Series
(4-digit display)



AEL13 Series
(6-digit display)



Pin type



Screw terminal type

Features

- 1. Low Price**
All this at an affordable price to provide you with unmatched cost performance.
- 2. Display is a bright reflective-type LCD.**
- 3. Inherits all of the characteristics of the LC4H digital timer.**
 - Seesaw switches ensure easy operation.
 - IP66 environmental protection.
 - Shortened body (pin type: 70.1 mm 2.760 inch, screw type: 64.5 mm 2.539 inch underhead).
- 4. Compliant with UL, c-UL and CE.**

Product types

| Digit | Count speed | Output mode | Output | Operating voltage | Power down insurance | Terminal type | Part number | |
|-------|--|--|-----------------|-------------------|----------------------|----------------|------------------|------------------|
| 4 | 30 Hz (cps)/ 5 KHz (Kcps) switchable | <ul style="list-style-type: none"> • Maintain output/hold count • Maintain output/over count I • Maintain output/over count II • One shot/over count • One shot/recount I • One shot/recount II • One shot/hold count (7 modes) | Relay (1c) | 100 to 240 V AC | Available | 8 pins | LC4HL8-R4-AC240V | |
| | | | | | | | 11 pins | LC4HL-R4-AC240V |
| | | | | | | | Screw terminal | LC4HL-R4-AC240VS |
| | | | | | | | 8 pins | LC4HL8-R4-AC24V |
| | | | | | | | 11 pins | LC4HL-R4-AC24V |
| | | | | | | | Screw terminal | LC4HL-R4-AC24VS |
| | | | | | | 8 pins | LC4HL8-R4-DC24V | |
| | | | | | | 11 pins | LC4HL-R4-DC24V | |
| | | | | | | Screw terminal | LC4HL-R4-DC24VS | |
| | | | | | | 8 pins | LC4HL8-T4-AC240V | |
| | | | | | | 11 pins | LC4HL-T4-AC240V | |
| | | | | | | Screw terminal | LC4HL-T4-AC240VS | |
| 6 | | | Relay (1c) | 100 to 240 V AC | | 8 pins | LC4HL8-R6-AC240V | |
| | | | | | | | 11 pins | LC4HL-R6-AC240V |
| | | | | | | | Screw terminal | LC4HL-R6-AC240VS |
| | | | | | | | 8 pins | LC4HL8-R6-AC24V |
| | | | | | | | 11 pins | LC4HL-R6-AC24V |
| | | | | | | | Screw terminal | LC4HL-R6-AC24VS |
| | | | | | | 8 pins | LC4HL8-R6-DC24V | |
| | | | | | | 11 pins | LC4HL-R6-DC24V | |
| | | | | | | Screw terminal | LC4HL-R6-DC24VS | |
| | | | | | | 8 pins | LC4HL8-T6-AC240V | |
| | | | | | | 11 pins | LC4HL-T6-AC240V | |
| | | | | | | Screw terminal | LC4HL-T6-AC240VS | |
| | | 8 pins | LC4HL8-T6-AC24V | | | | | |
| | | 11 pins | LC4HL-T6-AC24V | | | | | |
| | | Screw terminal | LC4HL-T6-AC24VS | | | | | |
| | | 8 pins | LC4HL8-T6-DC24V | | | | | |
| | | 11 pins | LC4HL-T6-DC24V | | | | | |
| | | Screw terminal | LC4HL-T6-DC24VS | | | | | |

* A rubber gasket (ATC18002) and a mounting frame (AT8-DA4) are included.

Part names

• 4-digit display type

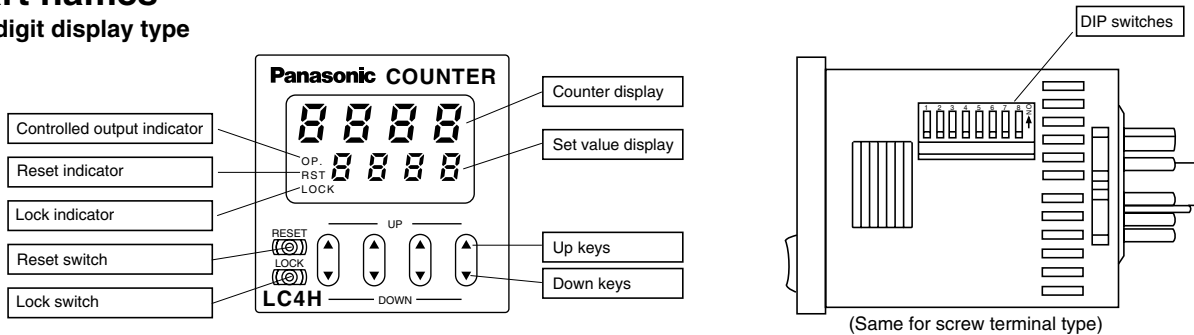

• 6-digit display type

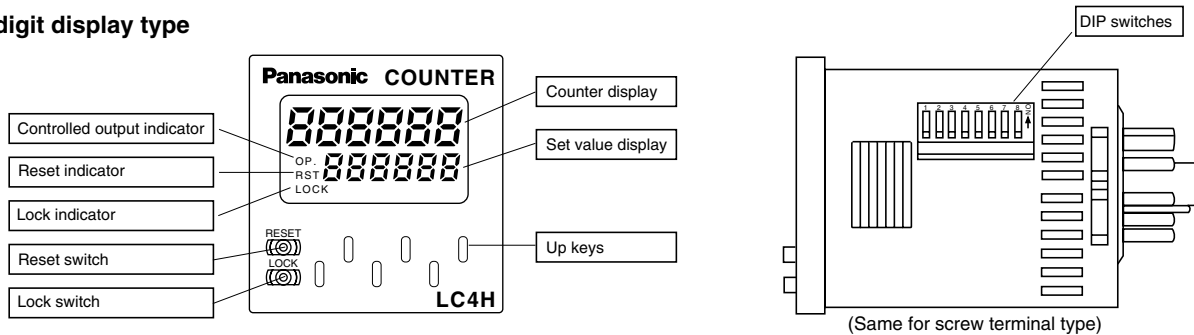

Specifications

| Item | Relay output type | | Transistor output type | | |
|---|---|--|---|---|---------------|
| | AC type | DC type | AC type | DC type | |
| Rating | Rated operating voltage | 100 to 240 V AC, 24 V AC | 12 to 24 V DC | 100 to 240 V AC, 24 V AC | 12 to 24 V DC |
| | Rated frequency | 50/60 Hz common | | 50/60 Hz common | |
| | Rated power consumption | Max. 10 V A | Max. 3 W | Max. 10 V A | Max. 3 W |
| | Rated control capacity | 5 A 250 V AC (resistive load) | | 100 mA 30 V DC | |
| | Input mode | Addition (UP)/Subtraction (DOWN)/Direction (DIR)/Individuality (IND)/Phase (PHASE) 5 modes selectable by DIP switch | | | |
| | Max. counting speed | 30 Hz/5 kHz (selectable by DIP switch) | | | |
| | Counting input (Input 1, 2) | Min. input signal width: 16.7 ms at 30 Hz/0.1 ms at 5 kHz, ON time: OFF time = 1:1 | | | |
| | Reset input | Min. input signal width: 1 ms, 20 ms (selected by DIP switch) | | | |
| | Lock input | Min. input signal width: 20 ms | | | |
| | Input signal | Contact or Open collector input/Input impedance: 1 kΩ or less, Input residual voltage: 2 V or less, Open impedance: 100 kΩ or more, Max. energized voltage: 40 V DC | | | |
| | Output mode | HOLD-A/HOLD-B/HOLD-C/SHOT-A/SHOT-B/SHOT-C/SHOT-D (7 modes selectable by DIP switch) | | | |
| | One shot output time | Approx. 1 s | | | |
| | Indication | 7-segment LCD, Counter value (backlight red LED), Setting value (backlight yellow LED) | | | |
| | Digit | 4-digit display type -999 to 9999 (-3 digits to +4 digits) (0 to 9999 for setting) | | | |
| 6-digit display type -99999 to 999999 (-5 digits to 6 digits) (0 to 999999 for setting) | | | | | |
| Memory | EEP-ROM (Overwriting times: 10 ⁵ ope. or more) | | | | |
| Contact | Contact arrangement | 1 Form C | | 1 Form A (Open collector) | |
| | Initial contact resistance | 100 mΩ (at 1 A 6 V DC) | | — | |
| | Contact material | Ag alloy/Au flush | | — | |
| Life | Mechanical (contact) | 2 × 10 ⁷ ope. (Except for switch operation parts) | | — | |
| | Electrical (contact) | 10 ⁵ ope. (At rated control voltage) | | 10 ⁷ ope. (At rated control voltage) | |
| Electrical | Allowable operating voltage range | 85 to 110 % of rated operating voltage | | | |
| | Break down voltage (Initial value) | Between live and dead metal parts: 2,000 Vrms for 1 min (11-pin type) Between input and output: 2,000 Vrms for 1 min Between open contacts: 1,000 Vrms for 1 min | | Between live and dead metal parts: 2,000 Vrms for 1 min (11-pin type) Between input and output: 2,000 V AC for 1 min | |
| | Insulation resistance (At 500 V DC) (Initial value) | Between live and dead metal parts: Min. 100 MΩ (11-pin type) Between input and output: Min. 100 MΩ Between open contact: Min. 100 MΩ | | Between live and dead metal parts: Min. 100 MΩ (11-pin type) Between input and output: Min. 100 MΩ | |
| | Temperature rise | Max. 65° C (under the flow of nominal operating current at nominal voltage) | | | |
| Mechanical | Vibration resistance | Functional | 10 to 55 Hz (1 cycle/min), single amplitude: 0.35 mm (10 min on 3 axes) | | |
| | | Destructive | 10 to 55 Hz (1 cycle/min), single amplitude: 0.75 mm (1 h on 3 axes) | | |
| | Shock resistance | Functional | Min. 98 m 321.522 ft./s ² (4 times on 3 axes) | | |
| | | Destructive | Min. 294 m 964.567 ft./s ² (5 times on 3 axes) | | |
| Operating conditions | Ambient temperature | -10° C to 55° C +14° F to +131° F | | | |
| | Ambient humidity | Max. 85 % RH (non-condensing) | | | |
| | Air pressure | 860 to 1,060 h Pa | | | |
| | Ripple rate | — | 20 % or less | — | 20 % or less |
| Connection | 8-pin/11-pin/screw terminal | | | | |
| Protective construction | IP66 (front panel with a rubber gasket) | | | | |

LC4H/-L

Applicable standard

| Safety standard | EN61812-1 | Pollution Degree 2/Overvoltage Category II |
|-----------------|--|--|
| EMC | (EMI)EN61000-6-4 Radiation interference electric field strength Noise terminal voltage (EMS)EN61000-6-2 Static discharge immunity | EN55011 Group1 ClassA EN55011 Group1 ClassA |
| | RF electromagnetic field immunity EFT/B immunity Surge immunity Conductivity noise immunity Power frequency magnetic field immunity Voltage dip/Instantaneous stop/Voltage fluctuation immunity | EN61000-4-2 4 kV contact 8 kV air EN61000-4-3 10 V/m AM modulation (80 MHz to 1 GHz) 10 V/m pulse modulation (895 MHz to 905 MHz) EN61000-4-4 2 kV (power supply line) 1 kV (signal line) EN61000-4-5 1 kV (power line) EN61000-4-6 10 V/m AM modulation (0.15 MHz to 80 MHz) EN61000-4-8 30 A/m (50 Hz) EN61000-4-11 10 ms, 30% (rated voltage) 100 ms, 60% (rated voltage) 1,000 ms, 60% (rated voltage) 5,000 ms, 95% (rated voltage) |

Dimensions

mm inch

General tolerance: ± 1.0 ± 0.039

• 4-digit display type

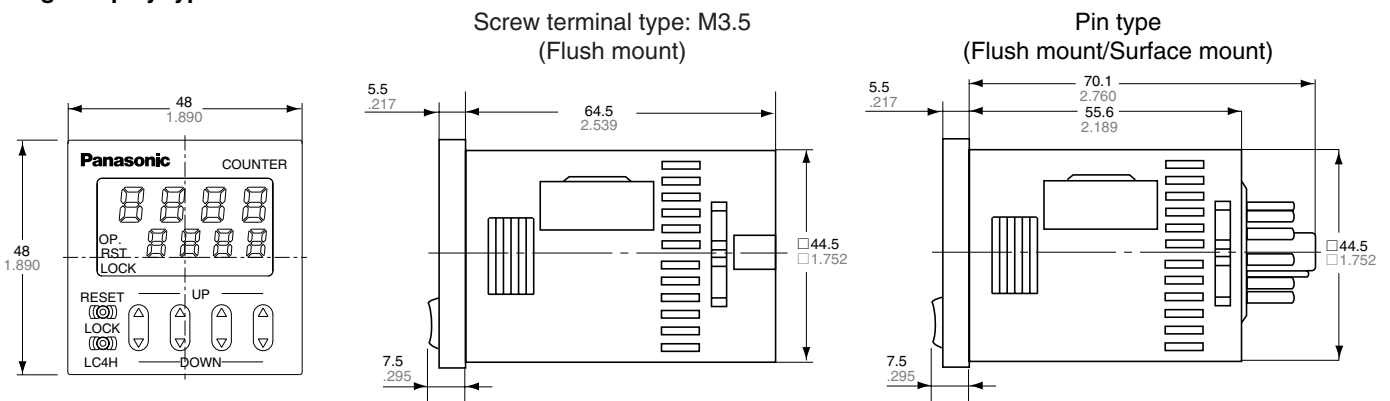

• 6-digit display type

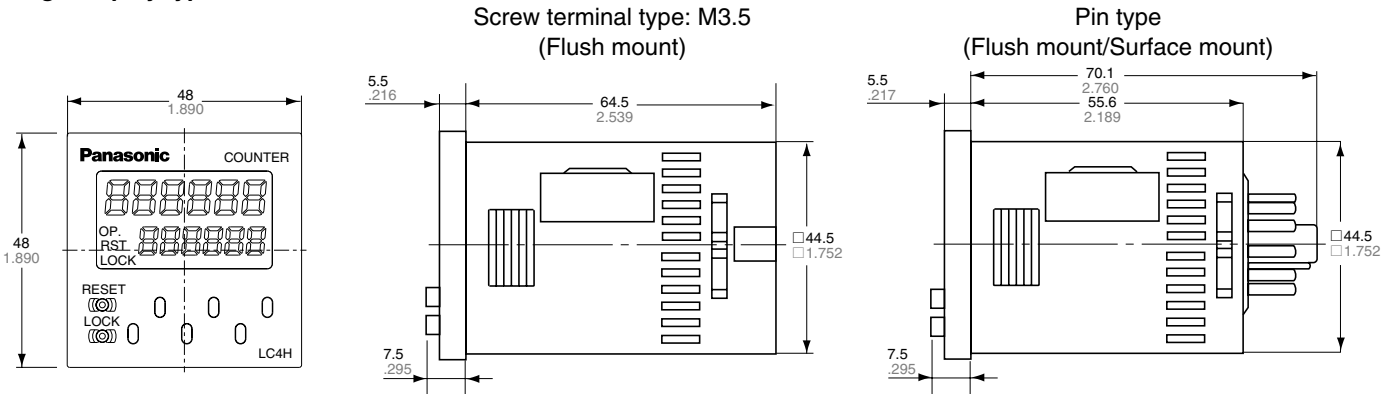

• Dimensions for flush mounting (with adapter installed)

Screw terminal type: M3.5

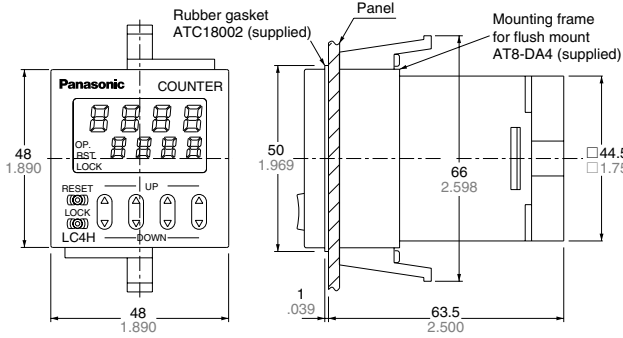

Pin type

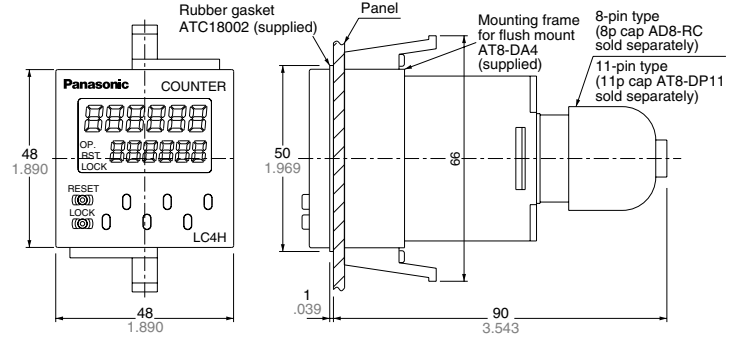

• Dimensions for front panel installations

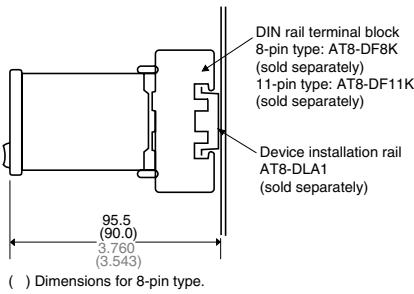

• Installation panel cut-out dimensions

The standard panel cut-out dimensions are shown below. Use the mounting frame (AT8-DA4) and rubber gasket (ATC18002).

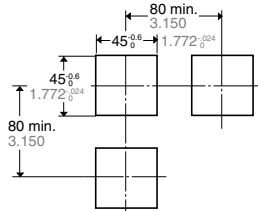

• For connected installations

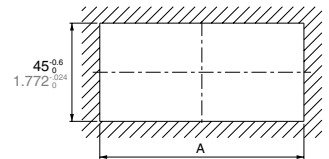

$$A = (48 \times n - 2.5) \text{ } ^{-0.6}$$

Note 1: The installation panel thickness should be between 1 and 5 mm .039 and .197 inch.

Note 2: For connected installations, the waterproofing ability between the unit and installation panel is lost.

Terminal layouts and Wiring diagrams

• 8-pin type

Relay output type

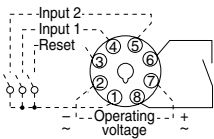

Transistor output type

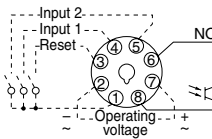

• 11-pin type

Relay output type

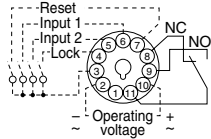

Transistor output type

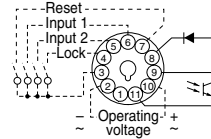

• Screw terminal type

Relay output type

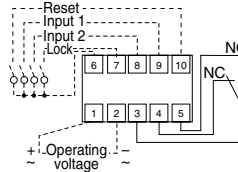

Transistor output type

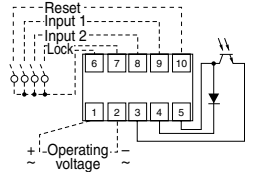

Note) For connecting the output leads of the transistor output type, refer to 5) Transistor output on page 141.

Setting the operation mode and set value

Setting procedure 1) Setting the operation mode (input mode and output mode)

Set the input and output modes with the DIP switches on the side of the counter.

DIP switches

| | Item | DIP switch | |
|---|----------------------------------|------------------|-------|
| | | OFF | ON |
| 1 | Output mode | Refer to table 1 | |
| 2 | | | |
| 3 | | | |
| 4 | Minimum reset input signal width | 20 ms | 1 ms |
| 5 | Maximum counter speed | 30 Hz | 5 kHz |
| 6 | Input mode | Refer to table 2 | |
| 7 | | | |
| 8 | | | |

Table 1: Setting the output mode

| DIP switch No. | | | Output mode |
|----------------|-----|-----|----------------|
| 1 | 2 | 3 | |
| ON | ON | ON | SHOT-A |
| OFF | OFF | OFF | SHOT-B |
| ON | OFF | OFF | SHOT-C |
| OFF | ON | OFF | SHOT-D |
| ON | ON | OFF | HOLD-A |
| OFF | OFF | ON | HOLD-B |
| ON | OFF | ON | HOLD-C |
| OFF | ON | ON | — (See note 1) |

Table 2: Setting the input mode

| DIP switch No. | | | Input mode |
|----------------|-----|-----|-------------------|
| 6 | 7 | 8 | |
| ON | ON | ON | Addition input |
| OFF | OFF | OFF | Subtraction input |
| ON | OFF | OFF | Directive input |
| OFF | ON | OFF | Independent input |
| ON | ON | OFF | Phase input |
| OFF | OFF | ON | — (See note 1) |
| ON | OFF | ON | — (See note 1) |
| OFF | ON | ON | — (See note 1) |

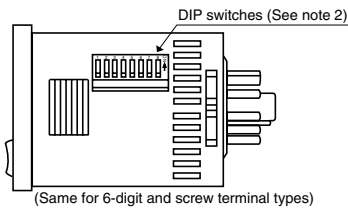

- Notes: 1) The counter and set value displays will display DIP Err.
 2) Set the DIP switches before installing the counter on the panel.
 3) When the DIP SW setting is changed, turn off the power once.
 4) The DIP switches are set as ON before shipping.

Setting procedure 2) Setting the set value

Set the set value with the UP and DOWN keys on the front of the counter.

Front display section

• 4-digit display type

- ① Counter display
 - ② Set value display
 - ③ Controlled output indicator
 - ④ Reset indicator
 - ⑤ Lock indicator
 - ⑥ UP keys
- Changes the corresponding digit of the set value in the addition direction (upwards).

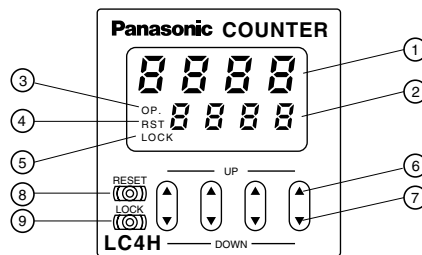

- ⑦ DOWN keys
- Changes the corresponding digit of the set value in the subtraction direction (downwards).
- ⑧ RESET switch
- Resets the counting value and the output.
- ⑨ LOCK switch
- Locks the operation of all keys on the counter.

• 6-digit display type

- ① Counter display
- ② Set value display
- ③ Controlled output indicator
- ④ Reset indicator
- ⑤ Lock indicator

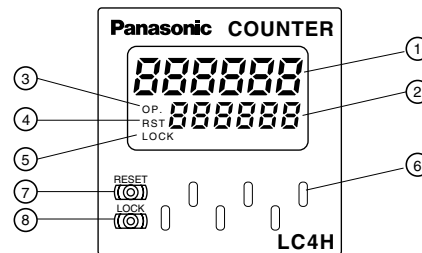

- ⑥ UP keys
- Changes the corresponding digit of the set value in the addition direction (upwards).
- ⑦ RESET switch
- Resets the counting value and the output.
- ⑧ LOCK switch
- Locks the operation of all keys on the counter.

• Changing the set value

1. It is possible to change the set value with the up and down keys (4-digit type only) even during counting. However, be aware of the following points.

1) If the set value is changed to less than the count value with counting set to the addition direction, counting will continue until it reaches full scale (9999 with the 4-digit type and 999999 with the 6-digit type), returns to zero, and then reaches the new set value. If the set value is changed to a value above the count value, counting will continue until the count value reaches the new set value.

2) Suppose that the counter is preset to count down. Whether a preset count-down value is smaller or larger than the count value, the counter counts down to "0(Zero)".

2. If the set value is changed to "0," the unit will not complete count-up. It starts counting up when the counting value comes to "0 (Zero)" again.

1) Up-count (addition) input when counting is set to the addition direction, counting will continue until full scale is reached (9999 with the 4-digit type and 999999 with the 6-digit type), return to zero, and then complete count-up.

2) Down-count (subtraction) input when counting is set to the subtraction direction, counting will continue until full scale is reached (-999 with the 4-digit type and -999999 with the 6-digit type), and then the display will change to - - - - with the 4-digit type and - - - - - with the 6-digit type. The counting value does not become "0" and so the counter does not count up.

3) For directive, independent, and phase input, when the counting value increases or decreases from the value "0" and then returns back to the value "0," count-up is completed.

LC4H/-L

2. Output mode

For the output mode, you can choose one of the following seven modes

- Maintain output/hold count HOLD-A
- Maintain output/over count I HOLD-B
- Maintain output/over count II HOLD-C
- One shot/over count SHOT-A
- One shot/recount I SHOT-B
- One shot/recount II SHOT-C
- One shot/hold count SHOT-D

| Output mode | Operation | (Example when input mode is either addition or subtraction) |
|--|---|---|
| Maintain output Hold count HOLD-A | Output control is maintained after count-up completion and until resetting. During that time, the count display does not change from that at count-up completion. | <p>* n: Set value</p> |
| Maintain output Over count I HOLD-B | Output control is maintained after count-up completion and until resetting. However, counting is possible despite completion of count-up. | <p>* n: Set value</p> |
| Maintain output Over count II HOLD-C | Output control is maintained after count-up completion and until the next signal enters. However, counting is possible despite completion of count-up. | <p>* n: Set value</p> |
| One shot Over count SHOT-A | Output control is maintained after count-up completion for a fixed time (approx. 1 sec). Counting is possible despite completion of count-up. | <p>* n: Set value</p> |
| One shot Recount I SHOT-B | Output control is maintained after count-up completion for a fixed time (approx. 1 sec). Counting is possible despite completion of count-up. However, reset occurs simultaneous with completion of count-up. While output is being maintained, restarting of the count is not possible | <p>* n: Set value</p> |
| One shot Recount II SHOT-C | Output control is maintained after count-up completion for a fixed time (approx. 1 sec). Counting is possible despite completion of count-up. However, reset occurs simultaneous with output OFF. | <p>* n: Set value</p> |
| One shot Hold count SHOT-D | Output control is maintained after count-up completion for a fixed time (approx. 1 sec). During that time, the count display does not change from that at count-up completion. Reset occurs simultaneous with output OFF. | <p>* n: Set value</p> |

UL File No.: E122222
C-UL File No.: E122222



4-digit type



6-digit type



11 pin type



Screw terminal type

RoHS Directive compatibility information
<http://www.nais-e.com/>

Features

- Bright and Easy-to-Read Display**
A brand new bright 2-color backlight LCD display. The easy-to-read screen in any location makes checking and setting procedures a cinch.
- Easy to use, simple operation, simple settings**
 - Operation modes (input/output modes) can be set easily, using DIP switches on the side panel.
 - Values can be set easily, using key switches on the front panel.
- Pre-scaling function provided**
A pre-scaling function enables conversion of lengths and volumes to any desired values, and displays the results.
- Built-in power supply for high-capacitance sensor**
An internal power supply drives a 12 VDC, 100 mA high-capacitance sensor. (AC power supply types only)
Photoelectric switches, proximity switches and encoders can be directly connected.
- Dual-path AC sensor can be connected.**

6. Basic insulation between the power supply and the input terminal (only for the sensor type model with power supply)

There is no need for caution when connecting between terminals.

7. Conforms to IP66's Weather Resistant Standards

The water-proof panel keeps out water and dirt for reliable operation even in poor environments.

8. 4-digit or 6-digit display

Two sizes of displays are offered for you to choose the one that suits your needs.

9. Screw terminal and Pin Type are Both Standard Options

The two terminal types are standard options to support either front panel installation or embedded installation.

10. Compliant with UL, c-UL and CE.

11. Low Price
All this at an affordable price to provide you with unmatched cost performance.

Product types

| Digit | Count speed | Operation mode | Output | Operation voltage | Power for sensor | Terminal | Part No. |
|-------|------------------------|--|------------|------------------------|------------------|----------------|--------------------|
| 4 | 30 Hz/5 KHz switchable | <ul style="list-style-type: none"> Maintain output/hold count Maintain output/over count I Maintain output/over count II One shot/over count One shot/recount I One shot/recount II One shot/hold count (7 modes) | Relay | 100 to 240 V AC | 12 V DC 100mA | 11 pins | LC4H-PS-R4-AC240V |
| | | | | 12 to 24 V DC /24 V AC | None | Screw terminal | LC4H-PS-R4-AC240VS |
| | | | Transistor | 12 to 24 V DC /24 V AC | None | 11 pins | LC4H-S-R4-24V |
| | | | | 12 to 24 V DC /24 V AC | None | Screw terminal | LC4H-S-R4-24VS |
| 6 | 30 Hz/5 KHz switchable | <ul style="list-style-type: none"> Maintain output/hold count Maintain output/over count I Maintain output/over count II One shot/over count One shot/recount I One shot/recount II One shot/hold count (7 modes) | Relay | 100 to 24 V AC | 12 V DC 100mA | 11 pins | LC4H-PS-R6-AC240V |
| | | | | 12 to 24 V DC /24 V AC | None | Screw terminal | LC4H-PS-R6-AC240VS |
| | | | Transistor | 12 to 24 V DC /24 V AC | None | 11 pins | LC4H-S-R6-24V |
| | | | | 12 to 24 V DC /24 V AC | None | Screw terminal | LC4H-S-R6-24VS |

Notes) 1. Rubber packing (ATC18002) and an mounting frame (AT8-DA4) are included.
2. 100 to 240 VAC Tr outputs (11-pin terminal, screw-tightening terminal) types are also supported.

LC4H-S

Part names

• 4-digit display type

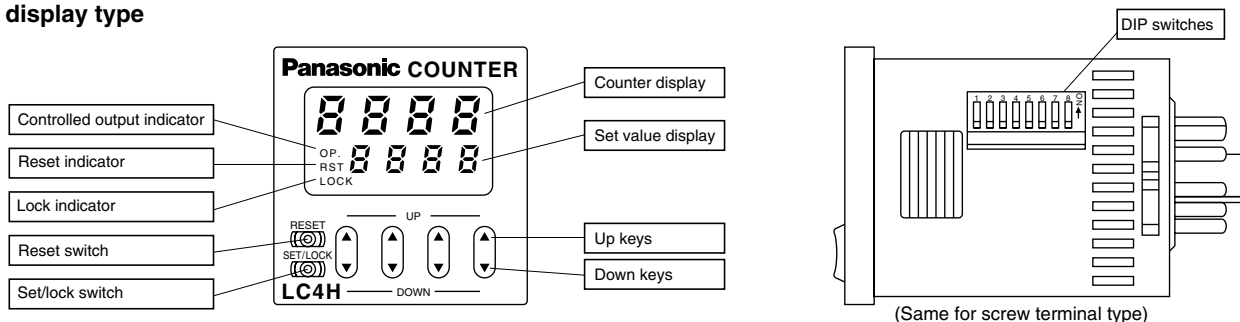

• 6-digit display type

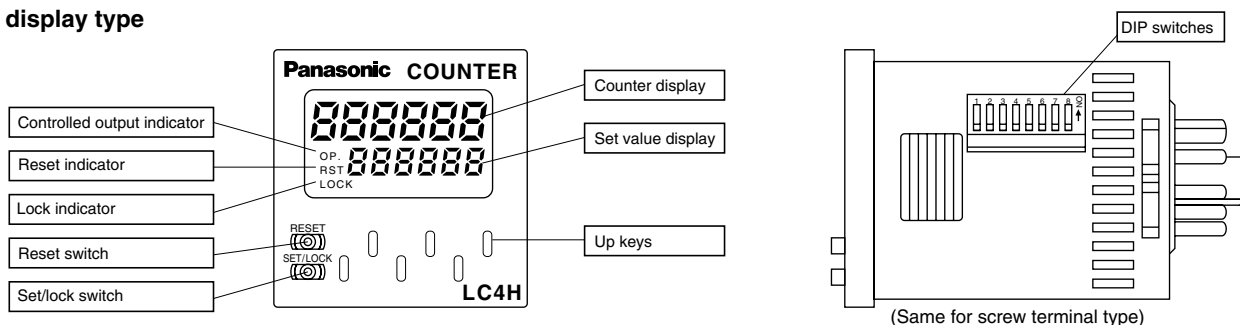

Specifications

| Item | | Relay output type | | Transistor output type |
|-------------------------|---|---|---|---|
| | | AC type | DC/AC type | DC/AC type |
| Rating | Rated operating voltage | 100 to 240 V | 12 to 24 V DC/24 V AC | 12 to 24 V DC/24 V AC |
| | Rated frequency | 50/60 Hz common | | |
| | Rated power consumption | Max. 10 V A | Max. 3 W | |
| | Rated control capacity | 5 A 250 V AC (resistive load) | | 100 mA, 30 V DC |
| | Input mode | Addition (UP)/Subtraction (DOWN)/Direction (DIR)/Individuality (IND)/Phase (PHASE) 5 modes selectable by DIP switches | | |
| | Max. counting speed | 30 Hz, 5 kHz (selectable by DIP switches) | | |
| | Counting input (input 1, input 2) | 16.7 ms at 30 Hz/0.1 ms at 5 kHz ON time: OFF time = 1:1 | | |
| | Reset input | Min. input signal width: 1 ms, 20 ms (selected by DIP switches) | | |
| | Lock input | Min. input signal width: 20 ms | | |
| | Input signal | Contact, Open collector input/DC two-wire system sensor Input impedance: 1 kΩ or less, Input residual voltage: 2 V or less, Open impedance: 100 kΩ or less, Max. energized voltage: 40 V DC | | |
| | Output mode | HOLD-A, HOLD-B, HOLD-C, SHOT-A, SHOT-B, SHOT-C, SHOT-D, 7 modes selectable by DIP switches | | |
| | One shot output time | 1 s, 0.5s, 0.2s, 0.1s, 0.05, 0.01s | | |
| | Indication | 7-segment LCD, Counter value (backlight red LED), Setting value (backlight yellow LED) | | |
| | Digit | 4-digit display type -999 to 9999 (0 to 9999 for setting) 6-digit display type -99999 to 999999 (0 to 999999 for setting) | | |
| | Decimal point | Can be set to three digits | | |
| | Pre-scaling | 0.001 to 9.999 (4-digit type), 0.001 to 99.999 (6-digit type) | | |
| | Memory | EEP-ROM (Overwriting times: 10 ⁵ ope. or more) | | |
| Power for senser | 12 V DC (±10%) 100 mA Max. | — | | |
| Contact | Contact arrangement | 1 Form C | | 1 Form A (Open collector) |
| | Initial contact resistance | 100 mΩ (at 1 A 6 V DC) | | — |
| | Contact material | Ag alloy/Au flush | | — |
| Life | Mechanical (contact) | 2 × 10 ⁷ ope. (Except for switch operation parts) | | — |
| | Electrical (contact) | 10 ⁵ ope. (At rated control voltage) | | 10 ⁷ ope. (At rated control voltage) |
| Electrical | Operating voltage range | 85 to 264 V AC | 10.8 to 26.4 V DC, 20.4 to 26.4 V AC | |
| | Initial withstand voltage | Between live and dead metal parts: 2,000 Vrms for 1 min (pin type) Between input and output: 2,000 Vrms for 1 min | | |
| | Initial insulation resistance (At 500 V DC) | Between live and dead metal parts: Min. 100 MΩ (pin type) Between input and output: Min. 100 MΩ | | |
| | Temperature rise | Max. 65° C (under the flow of nominal operating current at nominal voltage) | | |
| Mechanical | Vibration resistance | Functional | 10 to 55 Hz (1 cycle/min), single amplitude: 0.35 mm (10 min on 3 axes) | |
| | | Destructive | 10 to 55 Hz (1 cycle/min), single amplitude: 0.75 mm (1 h on 3 axes) | |
| | Shock resistance | Functional | Min. 98 m/s ² (4 times on 3 axes) | |
| | | Destructive | Min. 294 m/s ² (5 times on 3 axes) | |
| Operating conditions | Ambient temperature | -10° C to 55° C +14° F to +131° F | | |
| | Ambient humidity | Max. 85 % RH (non-condensing) | | |
| | Air pressure | 860 to 1,060 h Pa | | |
| Connection | 11-pin/screw terminal | | | |
| Protective construction | IP66 (front panel with a rubber gasket) | | | |

Applicable standard

| Safety standard | EN61812-1 | Pollution Degree 2/Overvoltage Category II |
|-----------------|--|--|
| EMC | (EMI)EN61000-6-4 Radiation interference electric field strength Noise terminal voltage (EMS)EN61000-6-2 Static discharge immunity | EN55011 Group1 ClassA EN55011 Group1 ClassA |
| | RF electromagnetic field immunity EFT/B immunity Surge immunity Conductivity noise immunity Power frequency magnetic field immunity Voltage dip/Instantaneous stop/Voltage fluctuation immunity | EN61000-4-2 4 kV contact 8 kV air EN61000-4-3 10 V/m AM modulation (80 MHz to 1 GHz) 10 V/m pulse modulation (895 MHz to 905 MHz) EN61000-4-4 2 kV (power supply line) 1 kV (signal line) EN61000-4-5 1 kV (power line) EN61000-4-6 10 V/m AM modulation (0.15 MHz to 80 MHz) EN61000-4-8 30 A/m (50 Hz) EN61000-4-11 10 ms, 30% (rated voltage) 100 ms, 60% (rated voltage) 1,000 ms, 60% (rated voltage) 5,000 ms, 95% (rated voltage) |

Dimensions

mm inch
General tolerance: ±1.0 ±.039

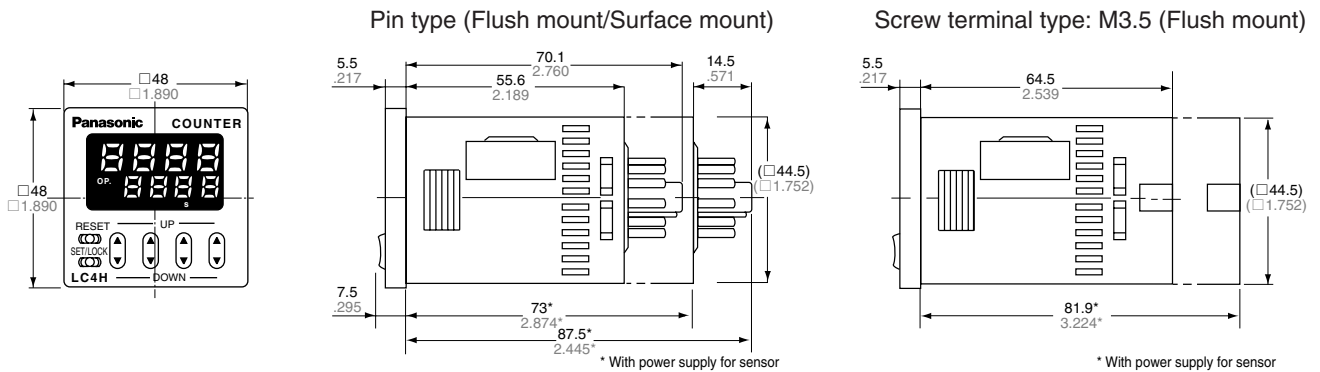

• Dimensions for flush mounting (with adapter installed)

Screw terminal type

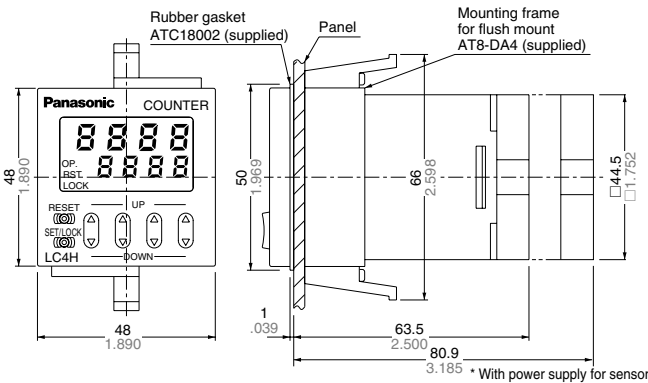

Pin type

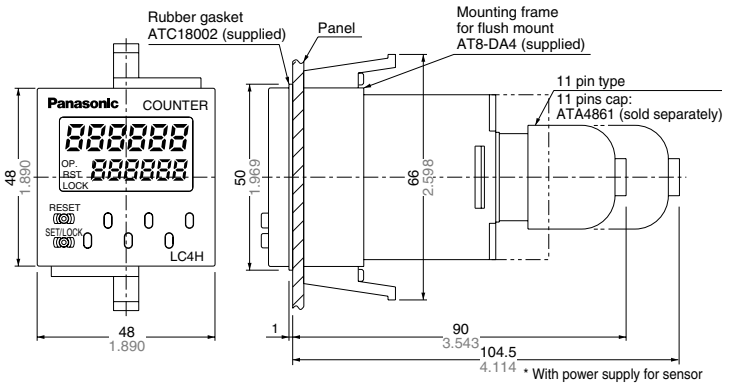

• Dimensions for front panel installations

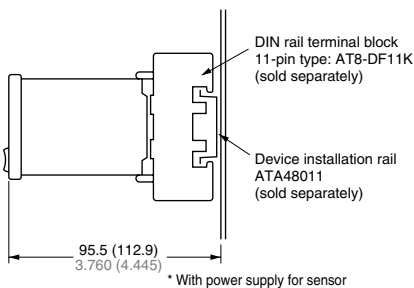

• Installation panel cut-out dimensions

The standard panel cut-out dimensions are shown below. Use the mounting frame (AT8-DA4) and rubber gasket (ATC18002).

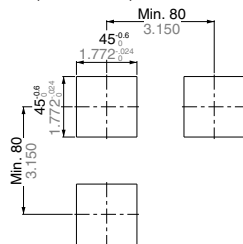

• For connected installations

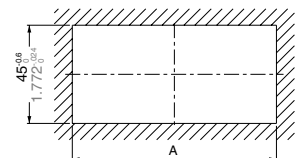

When n units are attached in a continuous series, the dimension of (A) is:

$$A = (48 \times n - 2.5) \text{ } ^{\pm .6}$$

Note 1: The installation panel thickness should be between 1 and 5 mm .039 and .197 inch.

Note 2: For connected installations, the waterproofing ability between the unit and installation panel is lost.

LC4H-S

Terminal layouts and Wiring diagrams

• Pin type

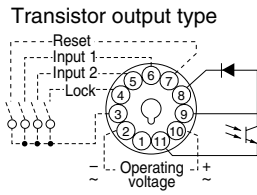
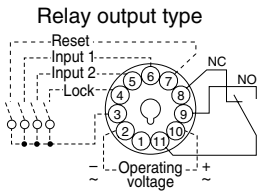

* With power supply for sensor

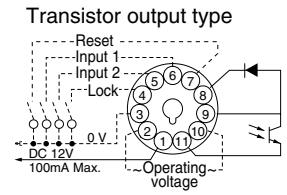
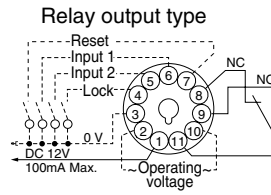

• Screw terminal type

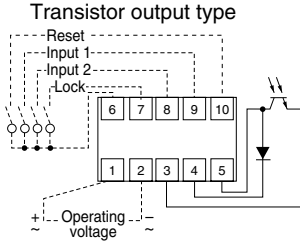
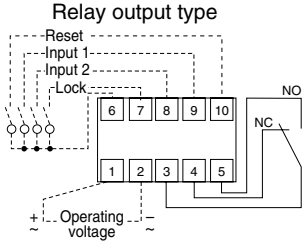

* With power supply for sensor

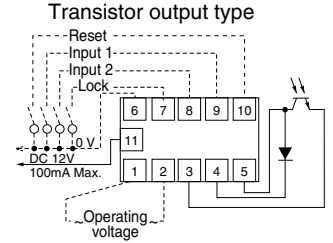
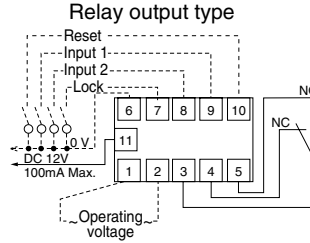

Note) For connecting the output leads of the transistor output type, refer to 5) Transistor output on page 141.

Setting the operation mode and counter

Setting procedure 1) Setting the operation mode (input mode and output mode)

Set the input and output modes with the DIP switches on the side of the counter.

DIP switches

| Item | DIP switch | | |
|------|----------------------------------|-------|-------|
| | OFF | ON | |
| 1 | Refer to table 1 | | |
| 2 | | | |
| 3 | | | |
| 4 | Minimum reset input signal width | 20 ms | 1 ms |
| 5 | Maximum counter setting | 30 Hz | 5 kHz |
| 6 | Refer to table 2 | | |
| 7 | | | |
| 8 | | | |

Table 1: Setting the output mode

| DIP switch No. | | | Output mode |
|----------------|-----|-----|----------------|
| 1 | 2 | 3 | |
| ON | ON | ON | SHOT-A |
| OFF | OFF | OFF | SHOT-B |
| ON | OFF | OFF | SHOT-C |
| OFF | ON | OFF | SHOT-D |
| ON | ON | OFF | HOLD-A |
| OFF | OFF | ON | HOLD-B |
| ON | OFF | ON | HOLD-C |
| OFF | ON | ON | — (See note 1) |

Table 2: Setting the input mode

| DIP switch No. | | | Input mode |
|----------------|-----|-----|-------------------|
| 6 | 7 | 8 | |
| ON | ON | ON | Addition input |
| OFF | OFF | OFF | Subtraction input |
| ON | OFF | OFF | Directive input |
| OFF | ON | OFF | Independent input |
| ON | ON | OFF | Phase input |
| OFF | OFF | ON | — (See note 1) |
| ON | OFF | ON | — (See note 1) |
| OFF | ON | ON | — (See note 1) |

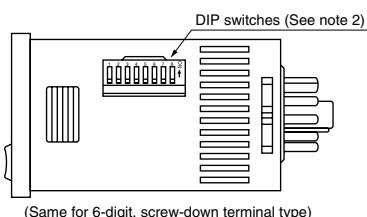

- Notes: 1) The counter and set value displays will display DIP Err.
 2) Set the DIP switches before installing the counter on the panel.
 3) When the DIP SW setting is changed, turn off the power once.
 4) The DIP switches are set as ON before shipping.

Setting procedure 2) Setting the set value

Set the set value with the UP and DOWN keys on the front of the counter.

Front display section

• 4-digit display type

- ① Counter display
 - ② Set value display
 - ③ Controlled output indicator
 - ④ Reset indicator
 - ⑤ Lock indicator
 - ⑥ UP keys
- Changes the corresponding digit of the set value in the addition direction (upwards)

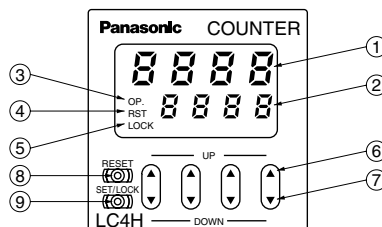

- ⑦ DOWN keys
- Changes the corresponding digit of the set value in the subtraction direction (downwards)
- ⑧ RESET switch
- Resets the counting value and the output
- ⑨ SET/LOCK switch
- This is used to handle pre-scaling values, one-shot times, decimal point position settings, and key lock operations (to disable Up key, Down key, and Reset key operations).

• 6-digit display type

- ① Counter display
- ② Set value display
- ③ Controlled output indicator
- ④ Reset indicator
- ⑤ Lock indicator

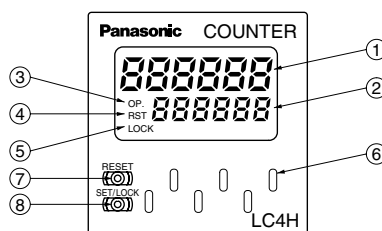

- ⑥ UP keys
- Changes the corresponding digit of the set value in the addition direction (upwards)
- ⑦ RESET switch
- Resets the counting value and the output
- ⑧ SET/LOCK switch
- This is used to handle pre-scaling values, one-shot times, decimal point position settings, and key lock operations (to disable Up key, Down key, and Reset key operations).

Setting procedure 3) Setting the input mode

The input mode is set using the key switch in the [Display] section on the front of the counter.

• Decimal point position setting mode

- ① Holding down the [SET/LOCK] key, press the key for the second digit to access the decimal point position setting mode.

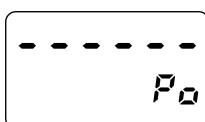

Example) 6-digit type
 Decimal point position setting mode display
 (Example shows default value displayed)

- ② When the setting mode has been accessed, release the [SET/LOCK] key.

- ③ The decimal point is set using the [UP] and [DOWN] keys to specify the 2nd, 3rd, and 4th digits (this applies only to 4-digit models). (The 1st digit is set using the [UP] key or [DOWN] key in settings where there is no decimal point (this applies only to 4-digit models).)

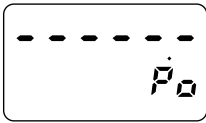

Example) 6-digit type
Example shows 2nd digit displayed using [UP] key

- ④ Press the [RESET] key to set the displayed decimal point position and return to normal operation.

• Setting the pre-scaling value

- ① Holding down the [SET/LOCK] key, press the key for the first digit to access the pre-scaling value setting mode.

Example) 4-digit type



Example) 6-digit type



Pre-scaling value setting mode displayed
(Example shows default values displayed)

- ② When the setting mode has been accessed, release the [SET/LOCK] key.
③ Use the [UP] or [DOWN] key to set the pre-scaling value (this applies only to 4-digit models).
Select either: 0.001 to 9.999 (4-digit) or 0.001 to 99.999 (6-digit)
④ Press the [RESET] key to set the displayed pre-scaling value and return to normal operation.

• Setting the one-shot output time

- ① Holding down the [SET/LOCK] key, press the key for the third digit to access the one-shot output time setting mode.

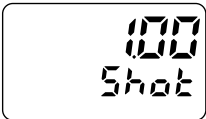

Example) 6-digit type
One-shot output time setting mode displayed
(Example shows default value displayed)

- ② When the setting mode has been accessed, release the [SET/LOCK] key.
③ Each time the 1st-digit [UP] key is pressed, the one-shot output time changes in the following sequence, moving to the right:

→ 1 s → 0.5 s → 0.2 s → 0.1 s → 0.05 s → 0.01 s →

(With a 4-digit type, the [DOWN] key can also be used to move to the left.)

- ④ Press the [RESET] key to set the displayed one-shot output time and return to normal operation.

Changing the set value

1. It is possible to change the set value with the up and down keys (4-digit type only) even during counting. However, be aware of the following points.

1) If the set value is changed to less than the count value with counting set to the addition direction, counting will continue until it reaches full scale (9999 with the 4-digit type and 999999 with the 6-digit type), returns to zero, and then reaches the new set value. If the set value is changed to a value above the count value, counting will continue until the count value reaches the new set value.

2) Suppose that the counter is preset to count down. Whether a preset count-down value is smaller or larger than the count value, the counter counts down to "0 (zero)".

2. If the set value is changed to "0," the unit will not complete count-up. It starts counting up when the counting value comes to "0 (zero)" again.

1) Up-count (addition) input
When counting is set to the addition direction, counting will continue until full scale is reached (9999 with the 4-digit type and 999999 with the 6-digit type), return to zero, and then complete count-up.

2) Down-count (subtraction) input
When counting is set to the subtraction direction, counting will continue until full scale is reached (-999 with the 4-digit type and -99999 with the 6-digit type), and then the display will change to - - - - with the 4-digit type and - - - - - with the 6-digit type.

The counting value does not become "0 (zero)" and so the counter does not count up.

3) Directive, independent, and phase inputs

The counting value is counted up or down to any number other than "0" once. When it comes to "0 (zero)" again, the counter starts counting up.

CAUTIONS FOR USE

For more information regarding the cautions for use of LC4H series counter, refer to page 140 "PRECAUTIONS IN USING THE LC4H SERIES".

Operation mode

1. Input mode

For the input mode, you can choose one of the following five modes

- Addition UP
- Subtraction DOWN
- Directive DIR
- Independent IND
- Phase PHASE

| Input mode | Operation | *Minimum input signal width 30 Hz: 16.7 ms; 5 kHz: 0.1 ms |
|---|---|---|
| Addition UP | IN1 or IN2 works as an input block (gate) for the other input. | <p>• Example where IN1 is the counting input and IN2 is the input block (gate).</p> <p>Counting (addition) 0 1 2 3 --- n-3 n-2 n-1 n</p> <p>Counting (subtraction) n n-1 n-2 n-3 --- 3 2 1 0</p> <p>ΔReset ΔCount-up completed</p> |
| Subtraction DOWN | | <p>• Example where IN2 is the counting input and IN1 is the input block (gate).</p> <p>Counting (addition) 0 1 2 3 4 --- n-1 n</p> <p>Counting (subtraction) n n-1 n-2 n-3 n-4 --- 1 0</p> <p>ΔReset ΔCount-up completed</p> |
| Directive DIR | IN1 is the counting input and IN2 is the addition or subtraction directive input. IN2 adds at L level and subtracts at H level. | <p>* "A" must be more than the minimum input signal width.</p> <p>Counting 0 1 2 3 4 3 2 1 0 1 2 3 4</p> <p>ΔReset</p> |
| Independent IND | IN1 is addition input and IN2 is subtraction input. | <p>* IN1 and IN2 are completely independent, so there is no restriction on signal timing.</p> <p>Counting 0 1 2 3 4 3 2 1 2 1 2 3</p> <p>ΔReset</p> |
| Phase PHASE | Addition when the IN1 phase advances beyond IN2, and subtraction when the IN2 phase advances beyond IN1. | <p>* "B" must be more than the minimum input signal width.</p> <p>Counting 0 1 2 3 2 1 0</p> <p>ΔReset</p> |

LC4H-S

2. Output mode

For the output mode, you can choose one of the following seven modes

- Maintain output/hold count HOLD-A
- Maintain output/over count I HOLD-B
- Maintain output/over count II HOLD-C
- One shot/over count SHOT-A
- One shot/recount I SHOT-B
- One shot/recount II SHOT-C
- One shot/hold count SHOT-D

| Output mode | Operation | (Example when input mode is either addition or subtraction) |
|--|--|---|
| Maintain output Hold count HOLD-A | Output control is maintained after count-up completion and until resetting. During that time, the count display does not change from that at count-up completion. | <p>* n: Set value</p> |
| Maintain output Over count I HOLD-B | Output control is maintained after count-up completion and until resetting. However, counting is possible despite completion of count-up. | <p>* n: Set value</p> |
| Maintain output Over count II HOLD-C | Output control is maintained after count-up completion and until the next signal enters. However, counting is possible despite completion of count-up. | <p>* n: Set value</p> |
| One shot Over count SHOT-A | Output control is maintained after count-up completion for one shot output time. Counting is possible despite completion of count-up. | <p>* n: Set value</p> |
| One shot Recount I SHOT-B | Output control is maintained after count-up completion for one shot output time. Counting is possible despite completion of count-up. However, reset occurs simultaneous with completion of count-up. While output is being maintained, restarting of the count is not possible. | <p>* n: Set value</p> |
| One shot Recount II SHOT-C | Output control is maintained after count-up completion for one shot output time. Counting is possible despite completion of count-up. However, reset occurs simultaneous with output OFF. | <p>* n: Set value</p> |
| One shot Hold count SHOT-D | Output control is maintained after count-up completion for one shot output time. During that time, the count display does not change from that at count-up completion. Reset occurs simultaneous with output OFF. | <p>* n: Set value</p> |

Input connections

• Signal input type

1) Open collector

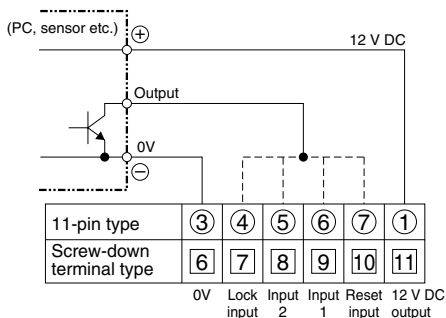

2) For voltage output

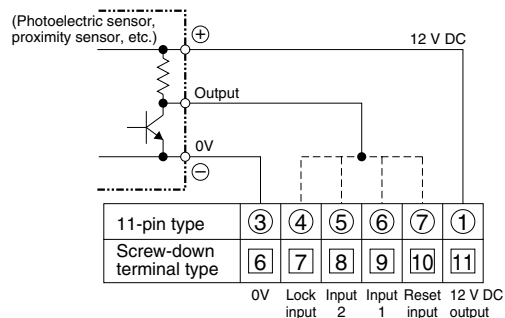

3) Contact input

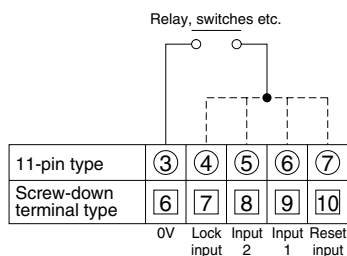

4) For a rotary encoder

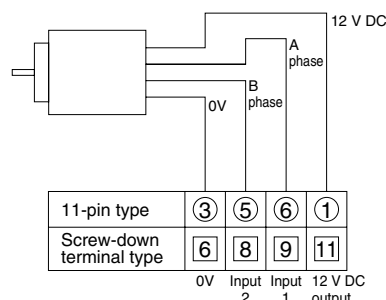

Input 1, input 2, and reset input specifications

- Impedance during short-circuit: 1 kΩ max. (At 0 Ω, the outflow current is approximately 12 mA.)
- Residual voltage during short-circuit: 2 V max.
- Impedance when released: 100 kΩ min.
- Max. applied voltage: 40 VDC max.

Lock input specifications

- Impedance during short-circuit: 1 kΩ max. (At 0 Ω, the outflow current is approximately 1.5 mA.)
- Residual voltage during short-circuit: 2 V max.
- Impedance when released: 100 kΩ min.
- Max. applied voltage: 40 DVC max.
- The contact relay should be one which can open/close 5 V, 1.5 mA.

* There is no 12 V DC with 12 - 24 V DC/24 V AC types.

5) For a dual-line sensor

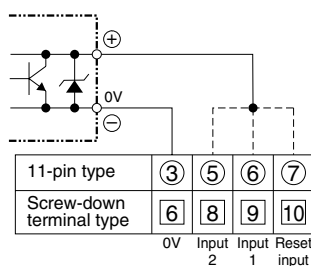

Dual-line sensor specifications

- Leakage current: 1.5 mA max.
- Breaker capacitance: 5 mA min.
- Residual voltage: 3.0 V max.
- Usable voltage: Runs on 10 VDC

* If a dual-line sensor is connected to a 12 - 24 VDC/24 VAC type, 24 VDC (21.6 to 26.4 VDC) and 24 VAC (21.6 to 26.4 VAC) should be applied to the power supply voltage of the counter.

What is the prescale function?

The prescale function converts the count into an actual value (amount) and displays it.

Example

For a device that outputs 500 pulses when 1 m has been fed:

1. Set decimal position to the last 3rd place.
2. Set the prescale value to 0.002 (1/500).

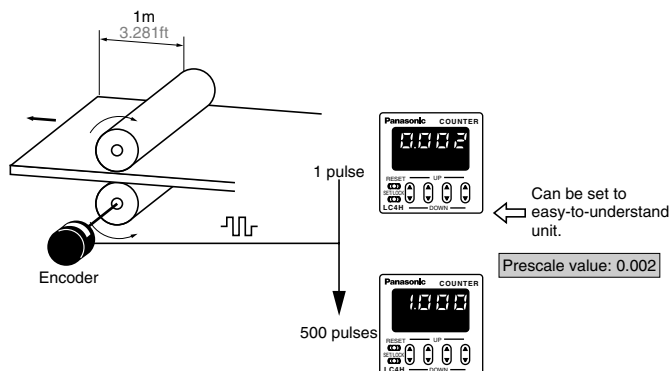

UL File No.: E122222
C-UL File No.: E122222



Features

1. Two-stage presetting (upper and lower limits)

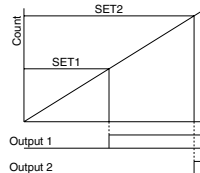

2. Bright and Easy-to-Read Display

A brand new bright 2-color backlight LCD display. The easy-to-read screen in any location makes checking and setting procedures a cinch.

3. Simple Operation

Seesaw buttons make operating the unit even easier than before.

4. Short Body of only 64.5 mm 2.539 inch (screw type) or 70.1 mm 2.760 inch (pin type)

With a short body, it easily installs in even narrow control panels.

5. Conforms to IP66's Weather Resistant Standards

The water-proof panel keeps out water and dirt for reliable operation even in poor environments.

6. Screw terminal and Pin Type are Both Standard Options

The two terminal types are standard options to support either front panel installation or embedded installation.

7. Changeable Panel Cover

Also offers a black panel cover to meet your design considerations.

8. Compliant with UL, c-UL and CE.

9. Low Price

All this at an affordable price to provide you with unmatched cost performance.

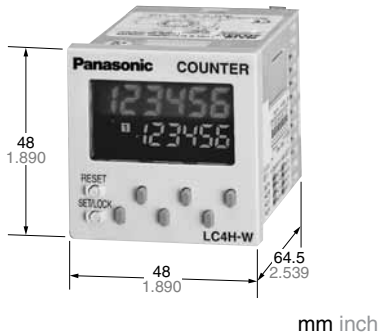

11-pin type



Screw terminal type

RoHS Directive compatibility information
<http://www.nais-e.com/>

Product types

| Digit | Count speed | Output mode | | Output | Operating voltage | Power down insurance | Terminal type | Part number |
|-------|--|--|--|--------------------|-------------------|----------------------|----------------|-------------------|
| | | Output 1 | Output 2 | | | | | |
| 6 | 30 Hz (cps)/ 5 KHz (Kcps) switchable | <ul style="list-style-type: none"> Maintain output/over count I Maintain output/over count II Maintain output/over count III One shot/over count (4 modes) | <ul style="list-style-type: none"> Maintain output/hold count Maintain output/over count I Maintain output/over count II Maintain output/over count III One shot/over count One shot/recount I One shot/recount II One shot/hold count (8 modes) | Relay (1a+1a) | 100 to 240 V AC | Available | 11 pins | LC4H-W-R6-AC240V |
| | | | | | 24V AC | | Screw terminal | LC4H-W-R6-AC240VS |
| | | | | | 12 to 24 V DC | | 11 pins | LC4H-W-R6-AC24V |
| | | | | | | | Screw terminal | LC4H-W-R6-AC24VS |
| | | | | | 100 to 240 V AC | | 11 pins | LC4H-W-R6-DC24V |
| | | | | | | | Screw terminal | LC4H-W-R6-DC24VS |
| | | | | Transistor (1a+1a) | 100 to 240 V AC | | 11 pins | LC4H-W-T6-AC240V |
| | | | | | 24V AC | | Screw terminal | LC4H-W-T6-AC240VS |
| | | | | | 12 to 24 V DC | | 11 pins | LC4H-W-T6-AC24V |
| | | | | | | | Screw terminal | LC4H-W-T6-AC24VS |
| | | | | | 12 to 24 V DC | | 11 pins | LC4H-W-T6-DC24V |
| | | | | | | | Screw terminal | LC4H-W-T6-DC24VS |

* A rubber gasket (ATC18002) and a mounting frame (AT8-DA4) are included.

Part names

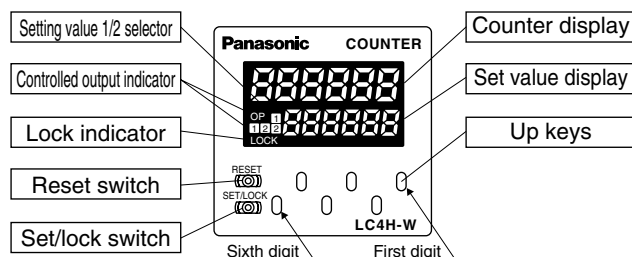

UP keys : Used to set the corresponding digits for the count-up mode.

RESET key : Used to reset counting and its output.

SET/LOCK key : Used to select between the Setting 1 display and Setting 2 display and to lock the keys (UP and RESET keys not responsive to touch). Used also to set and confirm the input mode.

Specifications

| Item | | Relay output type | | Transistor output type | |
|-------------------------|---|---|---|---|---------------|
| | | AC type | DC type | AC type | DC type |
| Rating | Rated operating voltage | 100 to 240 V AC 24 V AC | 12 to 24 V DC | 100 to 240 V AC 24 V AC | 12 to 24 V DC |
| | Rated frequency | 50/60 Hz common | — | 50/60 Hz common | — |
| | Rated power consumption | Max. 10 V A | Max. 3 W | Max. 10 V A | Max. 3 W |
| | Rated control capacity | 3 A, 250 V AC (resistive load) | | 100 mA, 30 V DC | |
| | Input mode | Addition (UP)/Subtraction (DOWN)/Direction (DIR)/Individuality (IND)/Phase (PHASE) (5 modes selectable by DIP switch) | | | |
| | Counting speed | 30 Hz(cps)/5 KHz(cps) (selectable by DIP switch) | | | |
| | Counting input (Input 1, 2) | Min. input signal width: 16.7 ms at 30 Hz(cps)/0.1 ms at 5 KHz(cps) ON time: OFF time = 1:1 | | | |
| | Reset input | Min. input signal width: 1 ms, 20 ms (selected by DIP switch) | | | |
| | Input signal | Contact or Open collector input/Input impedance: 1 kΩ or less, Input residual voltage: 2 V or less, Open impedance: 100 kΩ or more, Max. energized voltage: 40 V DC | | | |
| | Output mode | Output 1. HOLD-B, C, D SHOT-A (4 modes) Output 2. HOLD-A, B, C SHOT-A, B, C, D (8 modes) (selectable by DIP switch) | | | |
| | One shot output time | Approx. 1 s | | | |
| | Indication | 7-segment LCD, Counter value (backlight red LED), Setting value (backlight yellow LED) | | | |
| | Digit | -99999 to 999999 (-5 digits to 6 digits) (0 to 999999 for setting) | | | |
| | Memory | EEP-ROM (Overwriting times: 10 ⁵ ope. or more) | | | |
| Contact | Contact arrangement | 1 Form A + 1 Form A | | 1 Form A + 1 Form A (Open collector) | |
| | Contact resistance (Initial value) | 100 mΩ (at 1 A 6 V DC) | | — | |
| | Contact material | Ag alloy/Au flush | | — | |
| Life | Mechanical (contact) | Min. 2 × 10 ⁷ ope. | | — | |
| | Electrical (contact) | Min. 10 ⁵ ope. (At rated control voltage) | | Min. 10 ⁷ ope. (At rated control voltage) | |
| Electrical | Allowable operating voltage range | 85 to 110 % of rated operating voltage | | | |
| | Break down voltage (Initial value) | Between live and dead metal parts: 2,000 Vrms for 1 min (pin type) Between input and output: 2,000 Vrms for 1 min Between open contacts: 1,000 Vrms for 1 min | | Between live and dead metal parts: 2,000 Vrms for 1 min Between input and output: 2,000 V AC for 1 min | |
| | Insulation resistance (At 500 V DC) (Initial value) | Between live and dead metal parts: Min. 100 MΩ (pin type) Between input and output: Min. 100 MΩ Between open contact: Min. 100 MΩ | | Between live and dead metal parts: Min. 100 MΩ (pin type) Between input and output: Min. 100 MΩ | |
| | Temperature rise | Max. 65°C (under the flow of nominal operating current at nominal voltage) | | — | |
| Mechanical | Vibration resistance | Functional | 10 to 55 Hz (1 cycle/min), single amplitude: 0.35 mm (10 min on 3 axes) | | |
| | | Destructive | 10 to 55 Hz (1 cycle/min), single amplitude: 0.75 mm (1 h on 3 axes) | | |
| | Shock resistance | Functional | Min. 98 m/s ² (4 times on 3 axes) | | |
| | | Destructive | Min. 294 m/s ² (5 times on 3 axes) | | |
| Operating conditions | Ambient temperature | -10°C to 55°C +14°F to +131°F | | | |
| | Ambient humidity | Max. 85 % RH (non-condensing) | | | |
| | Air pressure | 860 to 1,060 h Pa | | | |
| | Ripple rate | — | 20 % or less | — | 20 % or less |
| Connection | 11-pin/screw terminal | | | | |
| Protective construction | IP66 (front panel with a rubber gasket) | | | | |

Applicable standard

| Safety standard | EN61812-1 | Pollution Degree 2/Overvoltage Category II |
|-----------------|---|--|
| EMC | (EMI)EN61000-6-4 Radiation interference electric field strength | EN55011 Group1 ClassA EN55011 Group1 ClassA |
| | Noise terminal voltage (EMS)EN61000-6-2 Static discharge immunity | EN61000-4-2 4 kV contact 8 kV air |
| | RF electromagnetic field immunity | EN61000-4-3 10 V/m AM modulation (80 MHz to 1 GHz) 10 V/m pulse modulation (895 MHz to 905 MHz) |
| | EFT/B immunity | EN61000-4-4 2 kV (power supply line) 1 kV (signal line) |
| | Surge immunity | EN61000-4-5 1 kV (power line) |
| | Conductivity noise immunity | EN61000-4-6 10 V/m AM modulation (0.15 MHz to 80 MHz) |
| | Power frequency magnetic field immunity | EN61000-4-8 30 A/m (50 Hz) |
| | Voltage dip/Instantaneous stop/Voltage fluctuation immunity | EN61000-4-11 10 ms, 30% (rated voltage) 100 ms, 60% (rated voltage) 1,000 ms, 60% (rated voltage) 5,000 ms, 95% (rated voltage) |

LC4H-W

Dimensions

• LC4H-W electrical counter

mm inch
General tolerance: ± 1.0 ± 0.039

Screw terminal type (Flush mount): M3.5

Pin type (Flush mount/Surface mount)

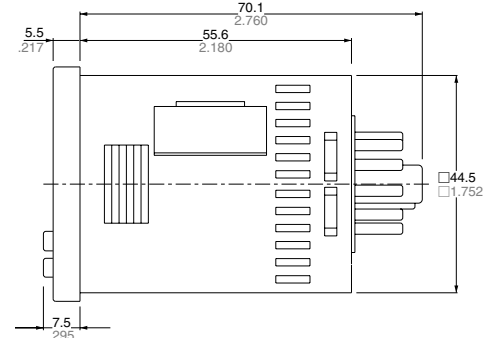
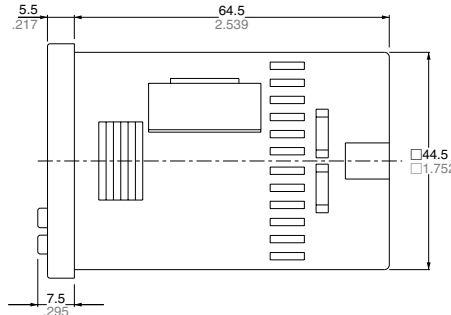
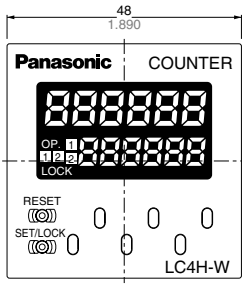

• Dimensions for flush mounting (with adapter installed)

Screw terminal type

Pin type

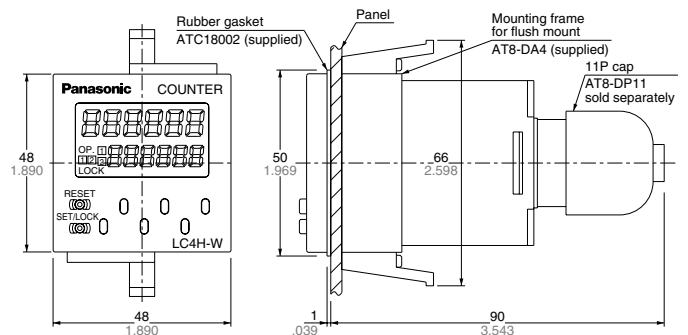
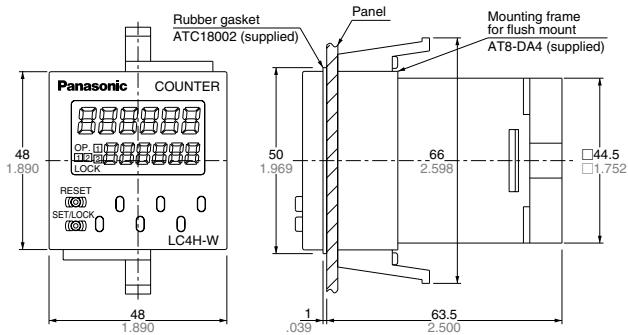

• Dimensions for front panel installations

• Installation panel cut-out dimensions

• For connected installations

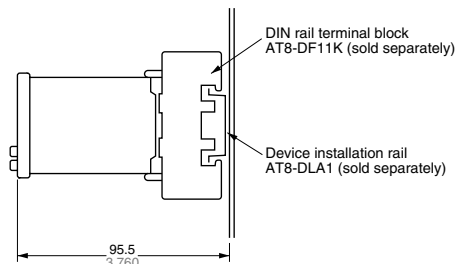

The standard panel cut-out dimensions are shown below. Use the mounting frame (AT8-DA4) and rubber gasket (ATC18002).

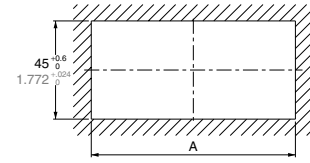
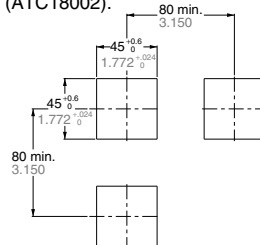

When n units are attached in a continuous series, the dimension of (A) is:

$$A = (48 \times n - 2.5)^{+0.6}$$

Note 1): The installation panel thickness should be between 1 and 5 mm (.039 and .197 inch).

2): For connected installations, the waterproofing ability between the unit and installation panel is lost.

Terminal layouts and Wiring diagrams

• Pin type

Relay output type

Transistor output type

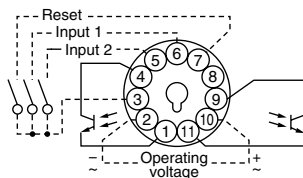
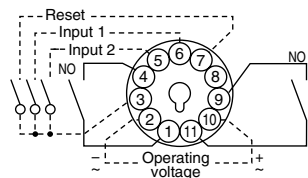

• Screw terminal type

Relay output type

Transistor output type

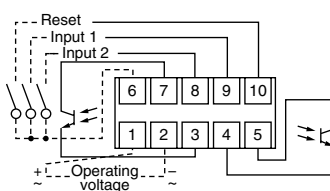
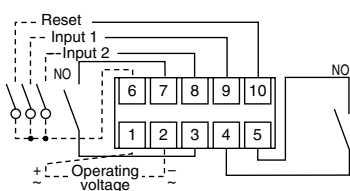

Note) For connecting the output leads of the transistor output type, refer to 5) Transistor output on page 141.

Setting the operation mode and counter

Setting procedure 1) Setting the output mode (output 1, 2)

Set the output 1 and output 2 with the DIP switches on the side of the counter.

The minimum input signal width and maximum counting speed for the reset are set at the same time.

DIP switches

| Item | OFF | ON | |
|------|----------------------------------|------|------|
| 1 | | | |
| 2 | | | |
| 3 | | | |
| 4 | Minimum reset input signal width | 20ms | 1ms |
| 5 | Maximum counter setting | 30Hz | 5kHz |
| 6 | | | |
| 7 | | | |
| 8 | | | |

Table 1

| DIP switch No. | | | Output mode (Output 1) |
|----------------|-----|-----|------------------------|
| 1 | 2 | 3 | |
| ON | ON | ON | — (See note 1) |
| OFF | OFF | OFF | HOLD-B |
| ON | OFF | OFF | HOLD-C |
| OFF | ON | OFF | HOLD-D |
| ON | ON | OFF | SHOT-A |
| OFF | OFF | ON | — (See note 1) |
| ON | OFF | ON | — (See note 1) |
| OFF | ON | ON | — (See note 1) |

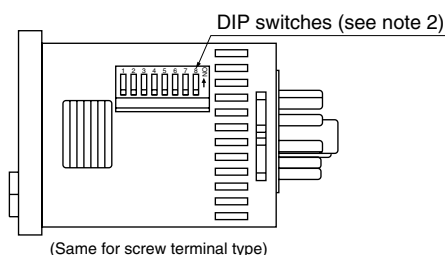

Table 2

| DIP switch No. | | | Output mode (Output 2) |
|----------------|-----|-----|------------------------|
| 6 | 7 | 8 | |
| ON | ON | ON | HOLD-A |
| OFF | OFF | OFF | HOLD-B |
| ON | OFF | OFF | HOLD-C |
| OFF | ON | OFF | HOLD-D |
| ON | ON | OFF | SHOT-A |
| OFF | OFF | ON | SHOT-B |
| ON | OFF | ON | SHOT-C |
| OFF | ON | ON | SHOT-D |

- Notes: 1) The counter and set value displays will display DIP Err.
 2) Set the DIP switches before installing the counter on the panel.
 3) When the DIP SW setting is changed, turn off the power once.
 4) The DIP switches are set as ON before shipping.

Setting procedure 2) Setting the set value

Set the set value with the UP keys on the front of the counter.

Front display section

- Counter display
- Set value display
- Controlled output indicator
- Setting 1/2 selection display (*Note)
- Lock indicator

*Note:
 Pressing the [SET/LOCK] key switches the display between the set value 1 and 2 displays.
 Display either set value [1] or [2], and set the value.

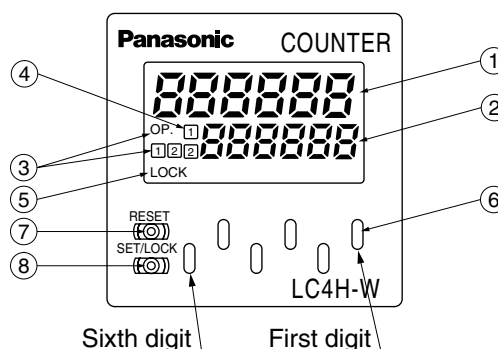

- UP keys
 [Changes the corresponding digit of the set value in the addition direction (upwards)]
- RESET switch
 Resets the counting value and the output
- SET/LOCK switch
 Used to select between the Setting 1 display and Setting 2 display, to set and confirm the input mode, and to lock the keys (UP and RESET keys not responsive to touch).

Procedure 3) Setting the input mode

Set the input mode using the key and switch in the front display section on the counter front.

- Hold down the SET/LOCK key and press the UP key for the first digit. The setting mode is accessed.
- Now release the SET/LOCK key.
- Press the UP key for the first digit and the input position changes counterclockwise.

Example)
 Input mode displayed (UP: addition mode)

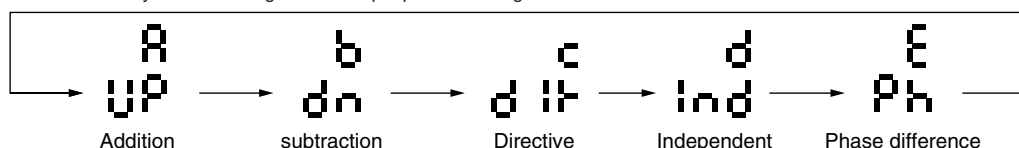
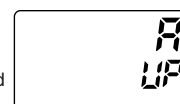

- Press the RESET key and the input mode being displayed is set. The display then goes back to normal.

• Checking the input mode

Hold down the SET/LOCK key and press the UP key for the second digit. The input mode is displayed for about 2 seconds and then the display goes back to normal. (During these 2 seconds, all operations other than the display are being performed.)

• Locking the keys

Hold down the SET/LOCK key and press the UP key for the sixth digit. The keys will lock. This means that the UP and RESET keys do not respond to touch. To unlock the keys, hold down the SET/LOCK key and press the UP key for the sixth digit again.

* The input mode, maximum counting speed and minimum reset signal width cannot be preset independently for Setting 1 and Setting 2.

• Selecting the Setting 1 or Setting 2 display

Press the SET/LOCK key and the display changes between Setting 1 and Setting 2. (This operation does not affect overall operation.)

• Changing the setting

1. While the counter is working, the UP key can be used to change the setting. Keep the following points in mind, however.

- Suppose that a preset count-up value is smaller than the displayed count value. The counter counts up to the full scale mark (999999), goes back to "0", and counts up again to the preset number. When the preset count-up value is larger than the displayed count value, the counter counts up to the preset value.
- Suppose that the counter is preset to count down. Whether a preset count-down value is smaller or larger than the count value, the counter counts down to "0".

2. When the preset value is "0", the counter does not start in the count-up mode. It starts counting up when the count value comes to "0" again.

- Up-count input
 The counter counts up to the full scale mark (999999), goes back to "0" and starts counting up again.
- Down-count input
 The counter counts down to the full scale mark (-99999) and the display reads = = = = = . The count value does not become "0" and so the counter does not count up.
- Direction input, individual input, and phase input
 The preset value is counted up or down to any number other than "0" once. When it comes to "0" again, the counter starts counting up.

LC4H-W

Operation modes

1. Input mode

① For the input mode, you can choose one of the following five modes.

- Addition UP
- Subtraction DOWN
- Directive DIR
- Independent IND
- Phase PHASE

② After the counter has been reset, setting 2 is displayed in the count-down mode. "0" appears instead in all other modes.

| Input mode | Operation | *Minimum input signal width 30 Hz: 16.7 ms; 5 kHz: 0.1 ms |
|---|---|---|
| Addition UP | IN1 or IN2 works as an input block (gate) for the other input. | <p>• Example where IN1 is the counting input and IN2 is the input block (gate).</p> |
| Subtraction DOWN | | <p>• Example where IN2 is the counting input and IN1 is the input block (gate).</p> <p>* "A" must be more than the minimum input signal width. *n: Set value 2</p> |
| Directive DIR | IN1 is the counting input and IN2 is the addition or subtraction directive input. IN2 adds at L level and subtracts at H level. | <p>* "A" must be more than the minimum input signal width. *n: Set value 2</p> |
| Independent IND | IN1 is addition input and IN2 is subtraction input. | <p>* IN1 and IN2 are completely independent, so there is no restriction on signal timing.</p> |
| Phase PHASE | Addition when the IN1 phase advances beyond IN2, and subtraction when the IN2 phase advances beyond IN1. | <p>* "B" must be more than the minimum input signal width.</p> |

2. Output mode

For the set value 1, you can choose one of the following four modes.

- Maintain output/over count I HOLD-B
- Maintain output/over count II HOLD-C
- Maintain output/over count III HOLD-D
- One shot/over count SHOT-A

For the set value 2, you can choose one of the following eight modes.

- Maintain output/hold count HOLD-A
- Maintain output/over count I HOLD-B
- Maintain output/over count II HOLD-C
- Maintain output/over count III HOLD-D
- One shot/over count SHOT-A
- One shot/recount I SHOT-B
- One shot/recount II SHOT-C
- One shot/hold count SHOT-D

• Output mode for set value 1

| Output mode | Operation | (Example when input mode is either addition or subtraction) |
|--|--|---|
| Maintain output Over count I HOLD-B | Output control is maintained after count-up completion and until resetting. However, counting is possible despite completion of count-up. | <p>* n: Set value 1</p> |
| Maintain output Over count II HOLD-C | Output control is maintained after count-up completion and until the next signal enters. However, counting is possible despite completion of count-up. | <p>* n: Set value 1</p> |
| Maintain output Over count III HOLD-D | If the count value is greater than or equal to the preset value when counting up, the control output is held. The count operation is possible anyway. | <p>* n: Set value 1</p> |
| One shot Over count SHOT-A | Output control is maintained after count-up completion for a fixed time (approx. 1 sec). Counting is possible despite completion of count-up. | <p>* n: Set value 1</p> |

LC4H-W

• Output mode for set value 2

| Output mode | Operation | (Example when input mode is either addition or subtraction) |
|--|--|---|
| Maintain output Hold count HOLD-A | Output control is maintained after count-up completion and until resetting. During that time, the count display does not change from that at count-up completion. | <p>* n: Set value 2</p> |
| Maintain output Over count I HOLD-B | Output control is maintained after count-up completion and until resetting. However, counting is possible despite completion of count-up. | <p>* n: Set value 2</p> |
| Maintain output Over count II HOLD-C | Output control is maintained after count-up completion and until the next signal enters. However, counting is possible despite completion of count-up. | <p>* n: Set value 2</p> |
| Maintain output Over count III HOLD-D | If the count value is greater than or equal to the preset value when counting up, the counter starts counting up again. The count operation is possible anyway. | <p>* n: Set value 2</p> |
| One shot Over count SHOT-A | Output control is maintained after count-up completion for a fixed time (approx. 1 sec). Counting is possible despite completion of count-up. | <p>* n: Set value 2</p> |
| One shot Recount I SHOT-B | Output control is maintained after count-up completion for a fixed time (approx. 1 sec). Counting is possible despite completion of count-up. However, reset occurs simultaneous with completion of count-up. While output is being maintained, restarting of the count is not possible. | <p>* n: Set value 2</p> |

| Output mode | Operation | (Example when input mode is either addition or subtraction) |
|-------------------------------|---|---|
| One shot Recount II SHOT-C | Output control is maintained after count-up completion for a fixed time (approx. 1 sec). Counting is possible despite completion of count-up. However, reset occurs simultaneous with output OFF. | <p>* n: Set value 2</p> |
| One shot Hold count SHOT-D | Output control is maintained after count-up completion for a fixed time (approx. 1 sec). During that time, the count display does not change from that at count-up completion. Reset occurs simultaneous with output OFF. | <p>* n: Set value 2</p> |

| | | Output mode for set value 1 | | | |
|-----------------------------|------------------|--|--------|--|--------|
| | | HOLD-C | HOLD-D | HOLD-B | SHOT-A |
| Output mode for set value 2 | SHOT-A | As usual (this combination unchanged) | | As usual (this combination unchanged) | |
| | SHOT-B | | | | |
| | SHOT-C SHOT-D | | | | |

Note) When control output 1 is on, the output mode of setting 2 (SHOT-A, B, C, D) is also on and output 1 changes as shown in the above table.

3. Count-up

(1) In control output 1, when the count value is equal to the preset value 1, it is counted. (However, if the output mode of the preset value 1 is HOLD-D, it is counted when the count value is greater than or equal to the preset value 1, regardless of the input mode.)

(2) In control output 2, when the count value is equal to 0 in the count-down input mode, it is counted. In the other modes, when the count value is equal to the preset value 2, it is counted. (However, if the output mode of the preset value 2 is HOLD-D, it is counted when the count value is greater than or equal to the preset value 2, regardless of the input mode.)

(3) It is not counted even when the counting conditions are satisfied right after resetting. It can be counted from when the count value changes.

PRECAUTIONS IN USING THE LC4H SERIES

Precautions during usage

1. Terminal wiring

1) When wiring the terminals, refer to the terminal layout and wiring diagrams and be sure to perform the wiring properly without errors.

2) When using the instrument with an flush mounting, the screw-down terminal type is recommended. For the pin type, use either the rear terminal block (AT78041) or the 8P cap (AD8-RC) for the 8-pin type, and the rear terminal block (AT78051) or the 11P cap (AT8-DP11) for the 11-pin type. Avoid soldering directly to the round pins on the unit. When using the instrument with a front panel installation, use the DIN rail terminal block (AT8-DF8K) for the 8-pin type and the DIN rail terminal block (AT8-DF11K) for the 11-pin type.

3) After turning the counter off, make sure that any resulting induced voltage or residual voltage is not applied to power supply terminals ② through ⑦ (8-pin type), ② through ⑩ (11-pin type) or ① and ② (screw terminal type). (If the power supply wire is wired parallel to the high voltage wire or power wire, an induced voltage may be generated between the power supply terminals.)
4) Have the power supply voltage pass through a switch or relay so that it is applied at one time. If the power supply is applied gradually, the counting may malfunction regardless of the settings, the power supply reset may not function, or other such unpredictable occurrence may result.

2. Input connections (except LC4H-S/AC type)

The power circuit has no transformer (power and input terminals are not insulated). When an input signal is fed to two or more counters at once, do not arrange the power circuit in an independent way.

If the counter is powered on and off independently as shown in Fig. A, the counter's internal circuitry may get damaged. Be careful never to allow such circuitry. (Figs. A, B and C show the circuitry for the 11-pin type.)

(Fig. A)

Input contact or transistor

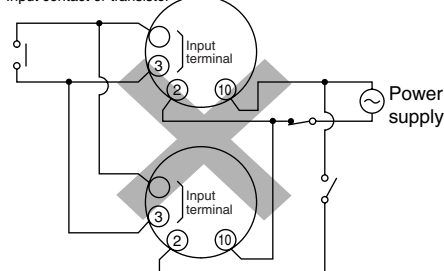

If independent power circuitry must be used, keep the input contacts or transistors separate from each other, as shown in Fig. B.

(Fig. B)

Input contact or transistor

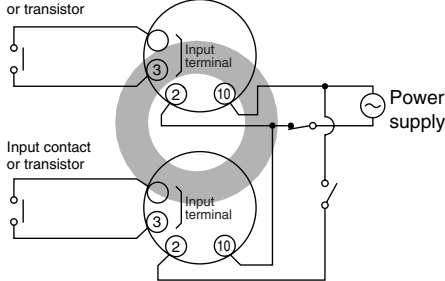

When power circuitry is not independent, one input signal can be fed to two or more counters at once, as shown in Fig. C.

(Fig. C)

Input contact or transistor

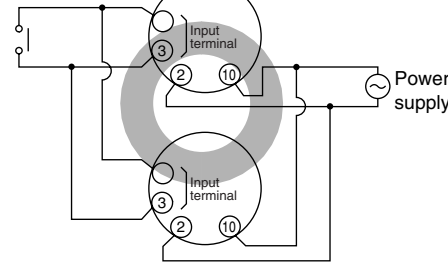

3. Input and output

1) Signal input type

(1) Contact point input

Use highly reliable metal plated contacts. Since the contact point's bounce time leads directly to error in the count value, use contacts with as short a bounce time as possible. In general, select Input 1 and Input 2 to have a maximum counting speed of 30 Hz and to be reset with a minimum input signal width of 20 ms.

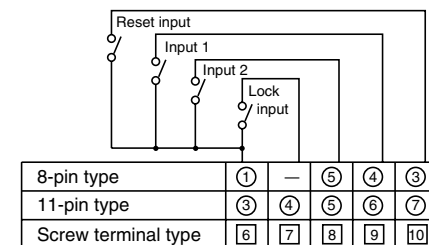

Note: The LC4H-W does not have the lock input ④, ⑦.

(2) Non-contact point input

Connect with an open collector. Use transistors whose characteristics satisfy the criteria given below.

$V_{CE0} = 20 \text{ V min.}$

$I_C = 20 \text{ mA min.}$

$I_{CBO} = 6\mu\text{A max.}$

Also, use transistors with a residual voltage of less than 2 V when the transistor is on.

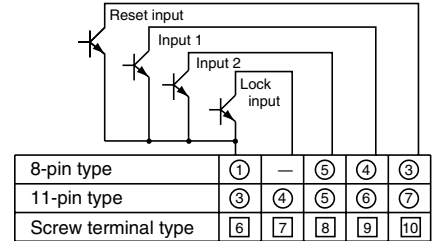

Note: The LC4H-W does not have the lock input ④, ⑦.

* The short-circuit impedance should be less than 1 k Ω .

[When the impedance is 0 Ω , the current coming from the input 1 and input 2 terminals is approximately 12 mA, and from the reset input and lock input terminals is approximately 1.5 mA.]

Also, the open-circuit impedance should be more than 100 k Ω .

* As shown in the diagram below, from a non-contact point circuit (proximity switches, photoelectric switches, etc.) with a power supply voltage of between 12 and 40 V, the signal can be input without using an open collector transistor. In the case of the diagram below, when the non-contact point transistor Q switches from off to on (when the signal voltage goes from high to low), the signal is input.

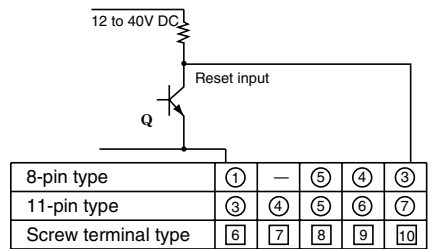

(The above example is for reset input)

2) The input mode and output mode change depending on the DIP switch settings. Therefore, before making any connections, be sure to confirm the operation mode and operation conditions currently set.

PRECAUTIONS IN USING THE LC4H SERIES

3) The LC4H series use power supply without a transformer (power and input terminals are not insulated). In connecting various kinds of input signals, therefore, use a power transformer in which the primary side is separated from the ungrounded secondary side as shown in Fig. A, for the power supply for a sensor and other input devices so that short-circuiting can be prevented.

Once the wiring to be used is completely installed and prior to installing this counter, confirm that there is complete insulation between the wires connected to the power terminals (2 each) and the wires connected to each input terminal. If the power and input lines are not insulated, a short-circuit may occur inside the counter and result in internal damage. In addition, when moving your equipment to a new installation location, confirm that there is no difference in environmental conditions as compared to the previous location.

(except LC4H-S/AC type)

(Fig. A) Good example

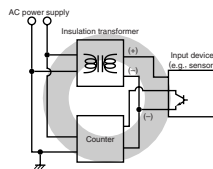

(Fig. B) Bad example

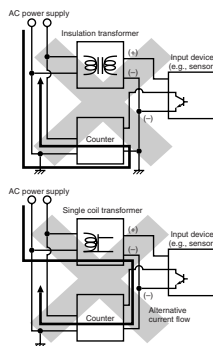

4) The input signal is applied by the shorting of each input terminal with the common terminal (terminal ① for 8-pin type, terminal ③ for 11-pin type and terminal ⑥ for screw terminal types). Never connect other terminals or voltages higher than 40 V DC, because it may destroy the internal circuitry.

5) Transistor output

(1) Since the transistor output is insulated from the internal circuitry by a photocoupler, it can be used as an NPN output or PNP (equal value) output. (The above example is 11-pin type)

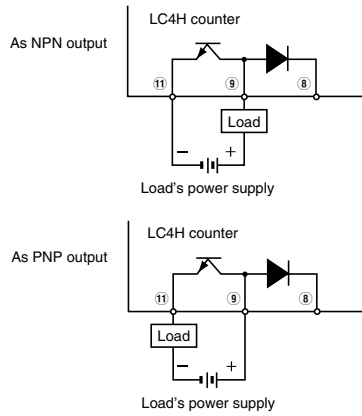

Note: With the LC4H 8-pin type and the LC4H-W, there is no diode between points ⑧ and ⑨.

(2) Use the diode connected to the output transistor's collector for absorbing the reverse voltage from induced loads. (LC4H only)

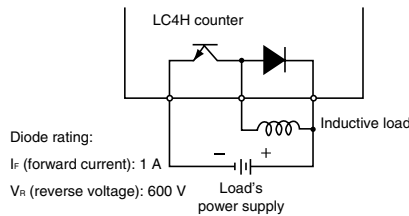

6) When wiring, use shielded wires or metallic wire tubes, and keep the wire lengths as short as possible.

4. Output mode setting

The output mode can be set with the DIP switches on the side of the counter. Make the DIP switch settings before installing the counter on the panel.

5. Conditions of usage

- 1) Avoid locations subject to flammable or corrosive gases, excessive dust, oil, vibrations, or excessive shocks.
- 2) Since the cover of the unit is made of polycarbonate resin, avoid contact with or use in environments containing methyl alcohol, benzene, thinners, and other organic solvents; and ammonia, caustic sodas, and other alkaline substances.
- 3) If power supply surges exceed the values given below, the internal circuits may become damaged. Be sure to use surge absorbing element to prevent this from happening.
- 4) Regarding external noise, the values

| Operating voltage | Surge voltage (peak value) |
|------------------------|----------------------------|
| AC type | 6,000V |
| DC type 24V AC type | 1,000V |

• Surge wave form

[$\pm (1.2 \times 50)$ ms uni-polar full wave voltage]

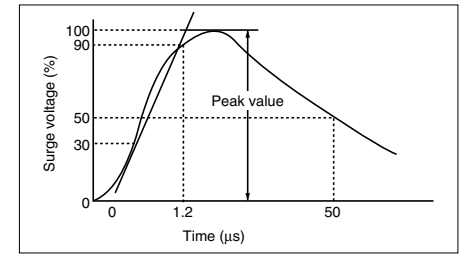

below are considered the noise-resistant voltages. If voltages rise above these values, malfunctions or damage to the internal circuitry may result, so take the necessary precautions.

Noise wave form (noise simulator)

| | Power supply terminals | | Input terminals |
|---------------|------------------------|------------------------|-----------------|
| | AC type | DC type 24V AC type | |
| Noise voltage | 1,500V | 1,000V | 600V |

Rise time: 1 ns

Pulse width: 1 μ s, 50 ns

Polarity: \pm

Cycle: 100 cycles/second

5) When connecting the operation power supply, make sure that no leakage current enters the counter. For example, when performing contact protection, if set up like that of diagram A, leaking current will pass through C and R, enter the unit, and cause incorrect operation.

Diagram B shows the correct setup.

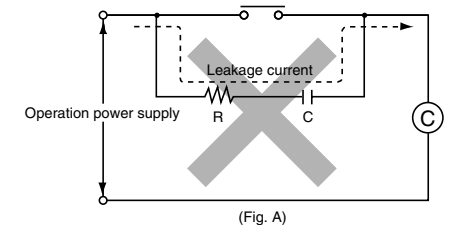

(Fig. A)

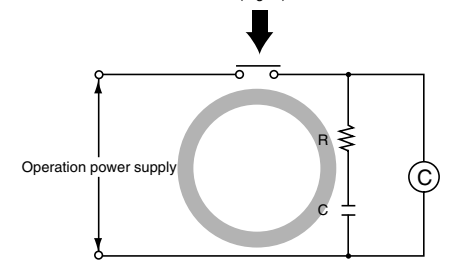

(Fig. B)

6) Long periods of continuous operation in the count-up completed condition (one month or more) will result in the weakening of the internal electrical components from the generated heat and, therefore, should be avoided. If you do plan to use the unit for such continuous operation, use in conjunction with a relay as shown in the circuit in the diagram below.

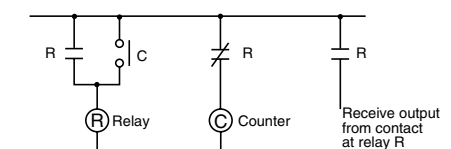

PRECAUTIONS IN USING THE LC4H SERIES

6. Self-diagnosis function

If a malfunction occurs, one of the following displays will appear.

| Display | Contents | Output condition | Restoration procedure | Preset values after restoration |
|----------------------------|--|------------------|--|---|
| - - - - or - - - - - | Minimum value went below -999 or -99999. See note 1. | No change | Enter reset or RESET key. | No change |
| d IPFFt | Incorrect DIP switch setting. | | Restart unit (correct DIP switch settings) | |
| Err-00 | Malfunctioning CPU. | OFF | Enter reset, RESET key, or restart unit. | The values at start-up before the CPU malfunction occurred. |
| Err-01 | Malfunctioning memory. See note 2. | | | 0 |

Note 1: When the counter value goes below the minimum value during any of the subtraction, directive, independent, or phase input modes.

Note 2: Includes the possibility that the EEPROM's life has expired.

7. Compliance with the CE marking

When using in applications to which EN61812-1 applies, abide by the following conditions.

- Overvoltage category II, pollution level 2 (for sensor type model with power supply)

1. Connections between the power supply and input/output have basic insulation. Use a device with basic insulation to connect to the I/O terminals. (for sensor type model without power supply)

1) This counter employs a power supply without a transformer, so the power and input signal terminals are not insulated.

- (1) When a sensor is connected to the input circuit, install double insulation on the sensor side.
- (2) In the case of contact input, use dual-insulated relays, etc.
 - The load connected to the output contact should have basic insulation. This counter is protected with basic insulation and can be double-insulated to meet EN/IEC requirements by using basic insulation on the load.
 - Applied voltage should be protected with an overcurrent protection device (example: 250 V 1A fuse, etc.) that conforms to the EN/IEC standards.

2) You must use a terminal block or socket for installing the pin-type counter. Do not touch the terminal section or other parts of the timer unit while an electric current is applied. Before installation or removal, confirm that there is no voltage being applied to any of the terminals.

3) Do not use this timer with a safety circuit. For example, when using a timer in a heater circuit, etc., provide a protection circuit on the machine side.