

Ordering number C11552_BARBARA-S

Family	Barbara	FWHM	17 degrees
Type	Reflector	Efficiency	90 %
LED	BXRA ES Rectangle	cd/lm	5.060
Color	Metal	Gerber File	Available
Diameter	70 mm		
Height	44.7 mm		
Style	Round		
Optic Material	PC		
Holder Material	-		
Fastening	Glue		
Status	Ready		

Ordering number C11553_BARBARA-W

Family	Barbara	FWHM	37 degrees
Type	Reflector	Efficiency	90 %
LED	BXRA ES Rectangle	cd/lm	2.010
Color	Metal	Gerber File	Available
Diameter	70 mm		
Height	44.7 mm		
Style	Round		
Optic Material	PC		
Holder Material	-		
Fastening	Glue		
Status	Ready		

Ordering number C13032_BARBARA-WW

Family	Barbara	FWHM	60 degrees
Type	Reflector	Efficiency	89 %
LED	BXRA ES Rectangle	cd/lm	1.000
Color	Metal	Gerber File	Available
Diameter	70 mm		
Height	44.7 mm		
Style	Round		
Optic Material	PC		
Holder Material	-		
Fastening	Glue		
Status	Ready		

Ordering number C12955_BARBARA-XW

Family	Barbara	FWHM	75 degrees
Type	Reflector	Efficiency	93 %
LED	BXRA ES Rectangle	cd/lm	0.550
Color	White	Gerber File	Available
Diameter	70 mm		
Height	44.7 mm		
Style	Round		
Optic Material	PC		
Holder Material	-		
Fastening	Glue		
Status	Ready		



PRODUCT DATASHEET
Barbara series
last update 4/10/2012



NOTE: The typical divergence will be changed by different color, chip size and chip position tolerance. The typical total divergence is the full angle measured where the luminous intensity is half of the peak value.



PRODUCT DATASHEET

Barbara series

last update 4/10/2012



GENERAL INFORMATION

- Product series especially designed & optimized for BXRA ES Rectangle series of LEDs.
- Special care taken to make light distribution as uniform as possible.
- Reflector is made of aluminium coated PC (120 degrees of Celcius / 248 degrees of Fahrenheit) with protective lacquer (110 degrees of Celcius / 230 degrees of Fahrenheit).
- Fastening to PCB with appropriate adhesive. By clicking link below you can find Ledil recommended glue options.
http://www.ledil.com/datasheets/DataSheet_GLUES.pdf

NOTE 1: We advise customer to ensure the suitability and sufficiency of the bond in the end product. For example, mechanical stress, vibration and holes on the surface of the circuit board weaken the strength of the glue.

NOTE 2: All surfaces where glue is applied must be clean, dry and free from grease and dirt. If cleaning of PCB surfaces is needed, please follow strictly the cleaning instructions of your LED manufacturer -this is important as cleaning shall under no circumstances damage LEDs or other electronics components on the PCB.

Further note that optical components shall not be cleaned with any chemicals - only micro fiber cloth may be used to remove fingerprints or other traces from handling.

Relative intensity of C12955_BARBARA-XW_(BXRA_ES)

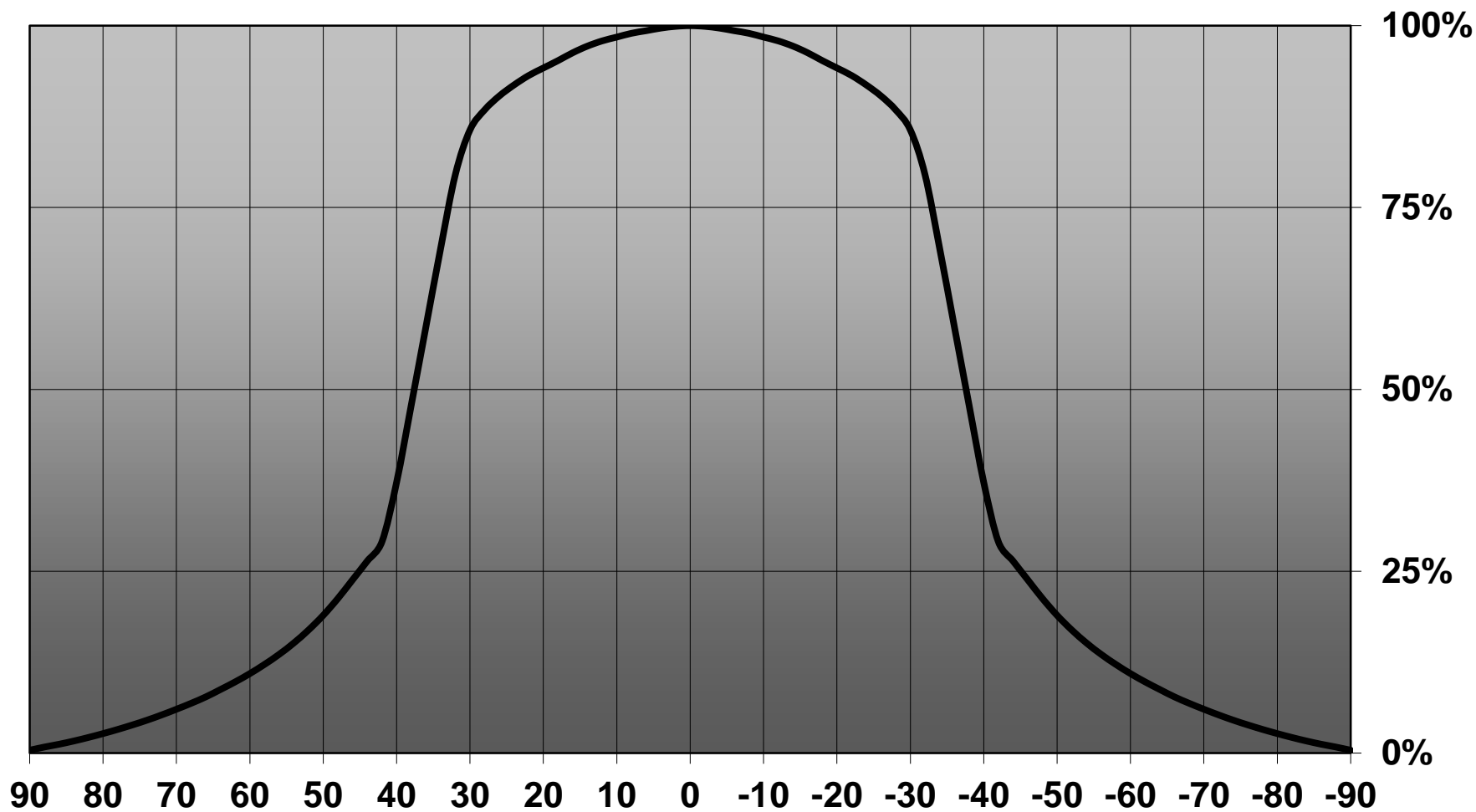

D

C

B

A

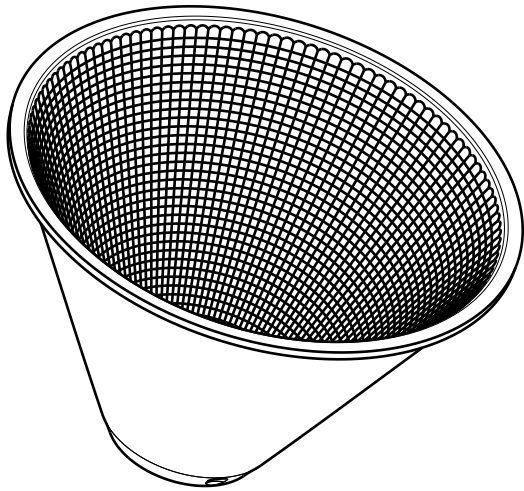

Isometric view

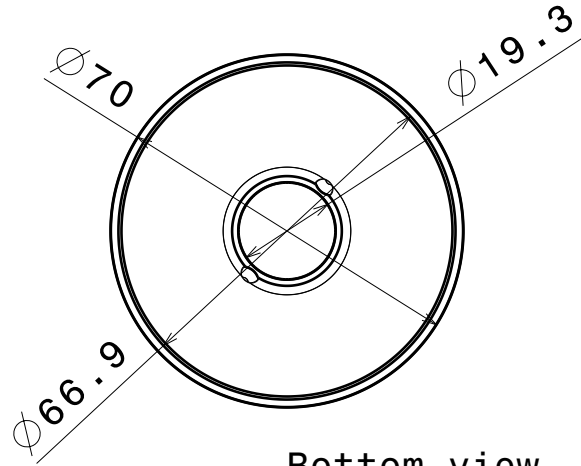

Bottom view

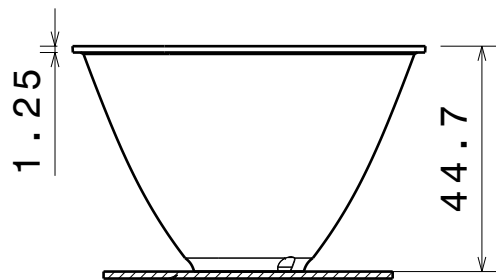

LED PCB

Front view

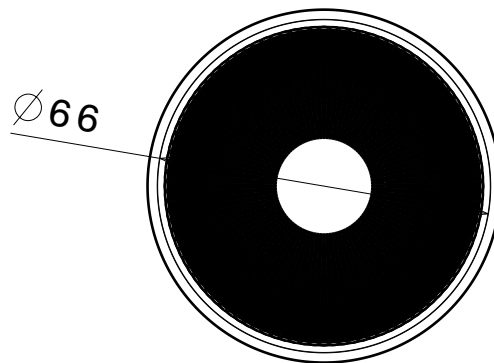

Top view

Material: PC with Metal coating and clear lacquer

This drawing is our property.
It can't be reproduced
or communicated without
our written agreement.



Ledil Oy
Salorankatu 10
FIN-24100 SALO
Finland

DRAWING TITLE

Datasheet Barbara Reflector series

DRAWN BY
ah

DATE
3.1.2012

CHECKED BY
sn

DATE
3.1.2012

SIZE
A4

DRAWING NUMBER

REV
2

DESIGNED BY
ol

DATE
23.06.2010

SCALE 2:3 WEIGHT (g)

SHEET 1/1

D

A

4

4

3

3

2

2

1

1

Luminaire: Ledil Oy C13032-Barbara-WW (Bridgelux BXRA-NO802) Efficiency=89%
Lamps: 1 x Bridgelux BXRA-NO802 237lm @ 250mA

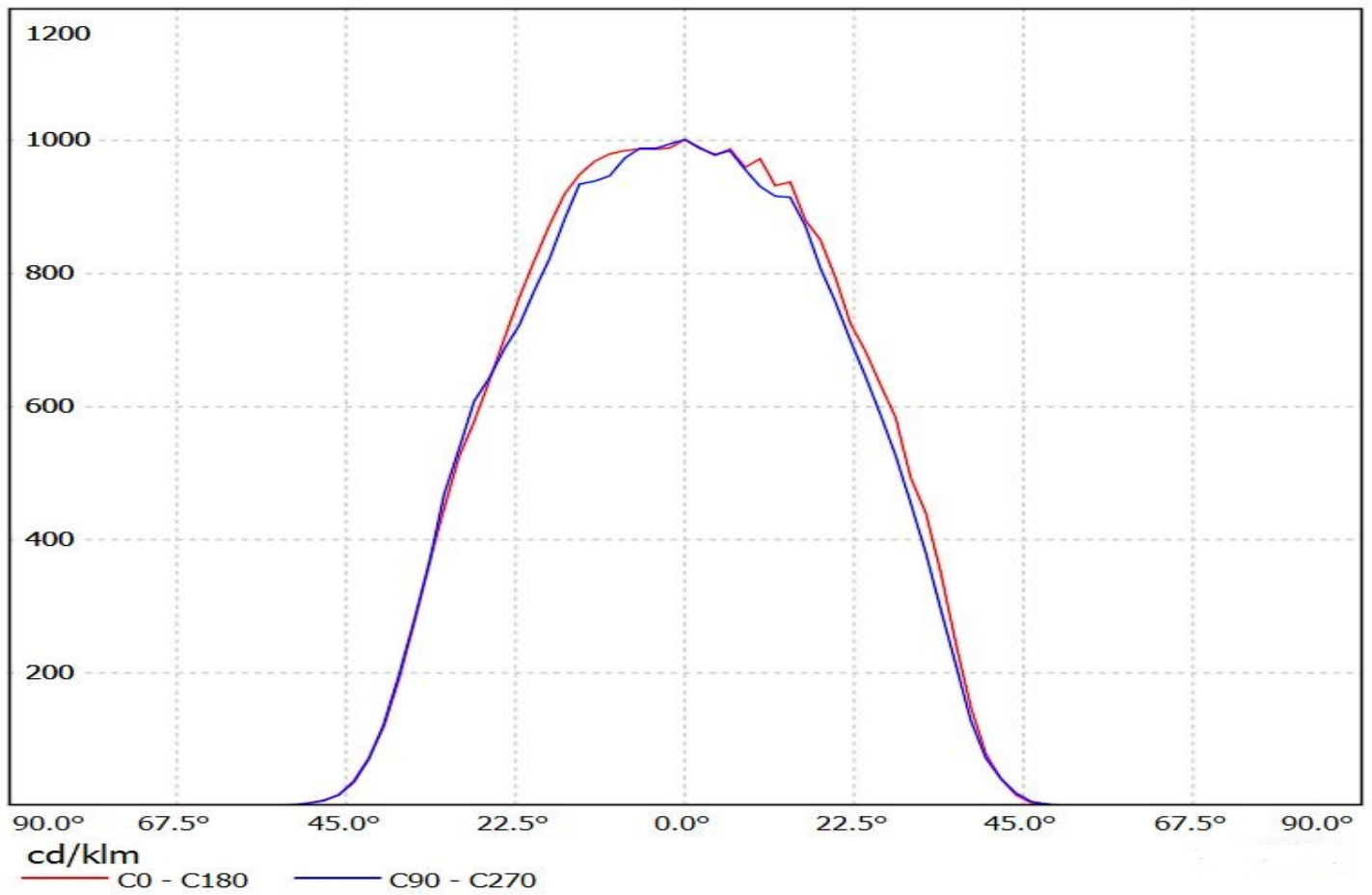

Luminaire: Ledil Oy C13032-Barbara-WW (Bridgelux BXRA-NO802) Efficiency=89%
Lamps: 1 x Bridgelux BXRA-NO802 237lm @ 250mA

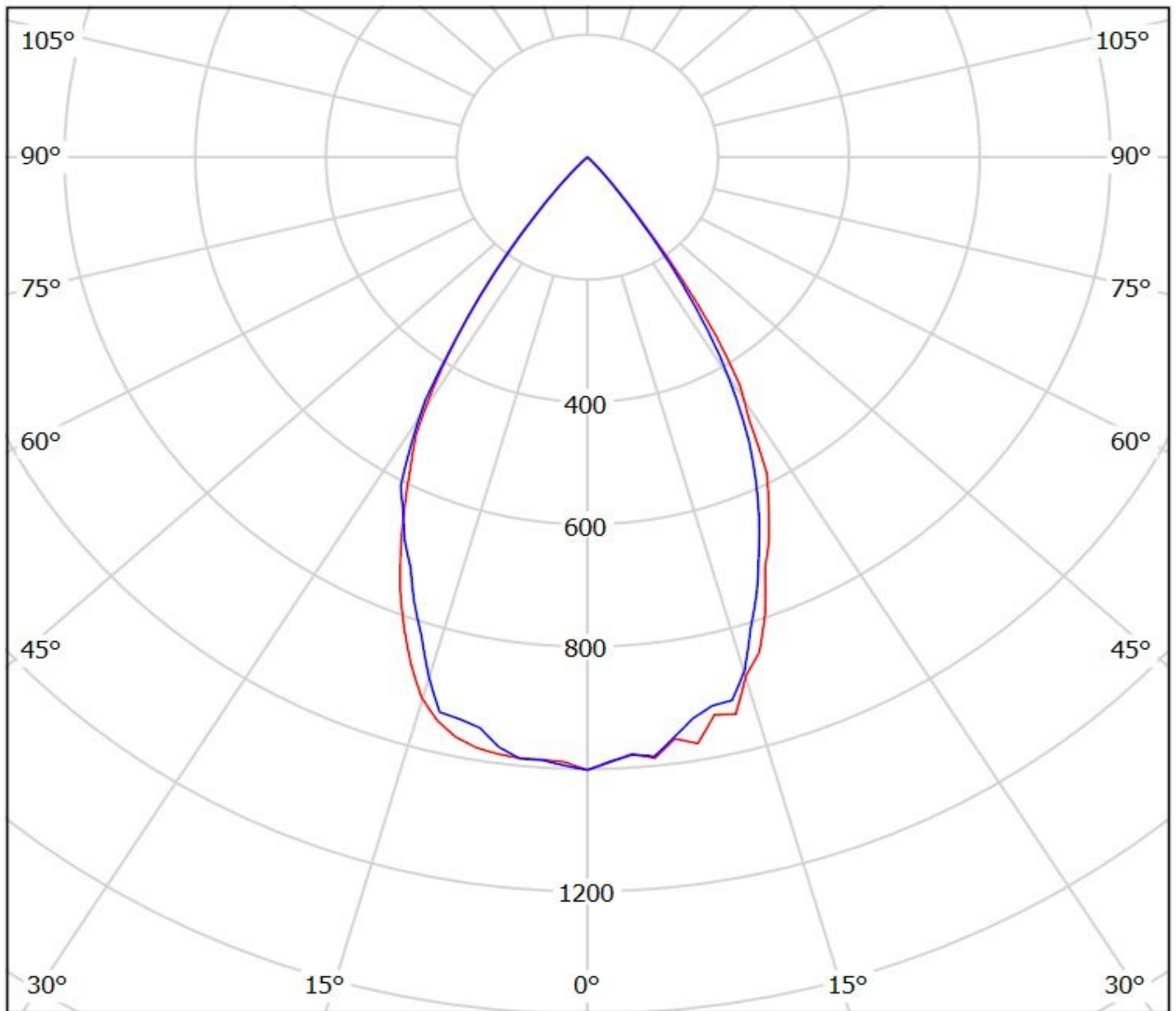

cd/klm

— C0 - C180 — C90 - C270