

NEW

10+Gbps 0.5mm pitch Stacking Connectors

FX10 Series

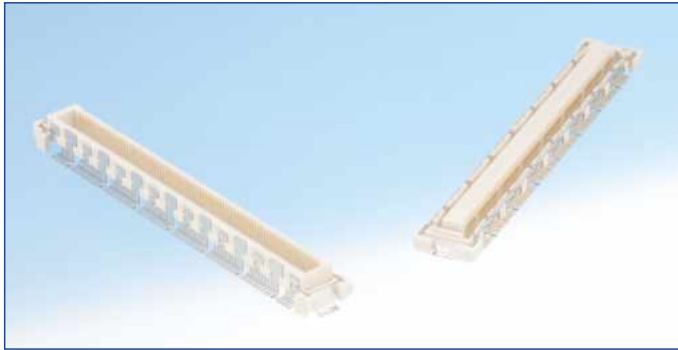

With GND Plate Type

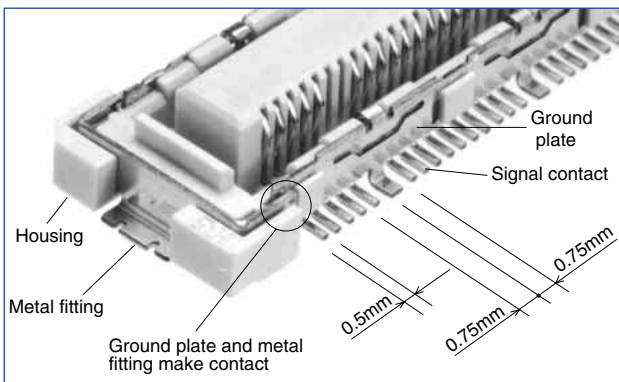

Cut Section

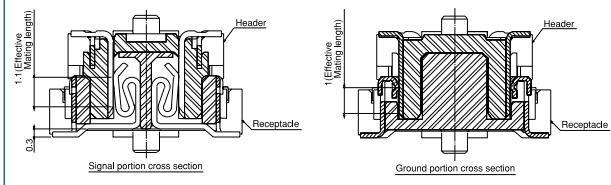

Mechanical Features

- 0.5mm Pitch
- Stacking Height : 4 ~ 8mm
- Number of Contacts
With ground plate type : 80 / 100 / 120 / 140
Without ground plate type : 96 / 120 / 144 / 168
- Improved Transmission Efficiency Between Boards

Transmission characteristics have been improved through a design that fixes ground plates to both sides of the header and receptacle.

10 Signal:1 Ground Arrangement

Signal and ground are arranged in a ratio of 10:1 with the ground plate SMT connected to the board. The ground stability achieved serves to reduce noise.

Metal Fittings for Added Solder Weld Strength

Metal fittings provide greater adhesion to the board, protecting against peeling. The unique connector design provides a connection between the fitting and the ground plate for a stronger ground.

Suited to High-Density Applications

The signal contact pitch of 0.5 mm produces a smaller connector utilizing less board area for mounting.

High contact reliability

Effective mating length is 1.1 mm for signal contacts.

Optional Ground Plate

An alternate style without the ground plate is available. The space provided by the ground plate removal has been filled with additional signal contacts.

Signal Integrity Features

Insertion-Loss-to-Crosstalk-Ratio(ICR)

The insertion-loss-to-crosstalk-ratio (ICR) with five-aggressor differential FEXT meets the extrapolated IEEE 802.3ap specification for 10+Gbps with plenty of margin.

Differential Impedance

The differential impedance is within 100 +/- 10 ohms at 30ps rise time (20% to 80%).

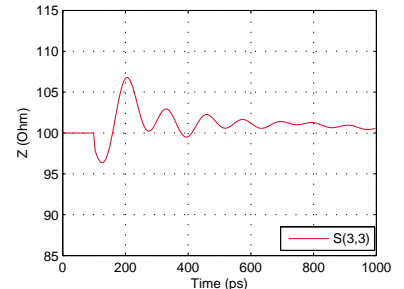
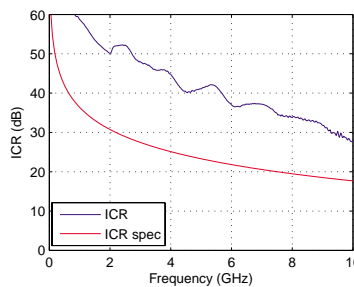

Stack Height

With ground plate

			Under development			
Headers	FX10#-*P/*-SV	FX10#-*P/*-SV1	FX10#-*P/*-SV2	FX10#-*P/*-SV3	FX10#-*P/*-SV4	
Receptacles	FX10#-*S/*-SV	4mm	5mm	6mm	7mm	8mm

Without ground plate

			Under development			
Headers	FX10#-*P-SV	FX10#-*P-SV1	FX10#-*P-SV2	FX10#-*P-SV3	FX10#-*P-SV4	
Receptacles	FX10#-*S-SV	4mm	5mm	6mm	7mm	8mm

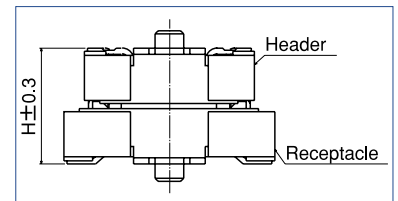

FX10 Series 10+Gbps 0.5mm pitch Stacking Connectors

Product Specifications

Rating	Rated current Rated voltage	0.3 A (Note 1) 50 V AC	Operating temperature range Operating humidity range	-55 to 85°C Relative humidity 95% max (No condensation)	Storage temperature range Storage humidity range	-10 to +60°C (Note 1) 40 to 70% (Note 1)
--------	--------------------------------	---------------------------	---	---	---	---

Item	Requirements	Conditions
1. Insulation resistance	100 M ohm min	Measured at 100 V DC
2. Voltage resistance	No flashover or breakdown	150 V AC applied for one minute
3. Contact resistance	60 m ohm max	Measured at 100 mA
4. Vibration	No electrical discontinuity for 1 μs min No damage, cracks, or parts looseness	Frequency: 10 to 55 Hz, amplitude of 0.75 mm in 3 directions, 10 cycles each
5. Shock	No electrical discontinuity for 1 μs min No damage, cracks, or parts looseness	Acceleration of 490 m/s ² , 11 ms duration, sine half-wave waveform, for 3 cycles in the both directions of each of the 3 axes
6. Damp heat (Steady state)	Contact resistance of 70 m ohm max, insulation resistance of 100 M ohm min, no damage, cracks, or parts looseness	Temperature of 40°C, humidity of 90 to 95%, duration 96 h
7. Temperature cycle	Contact resistance of 70 m ohm max, insulation resistance of 100 M ohm min, no damage, cracks, or parts looseness	Temperature: -55°C → 15 to 35°C → 85°C → 15 to 35°C Time: 30 min. → 2 to 3 min. → 30 min. → 2 to 3 min. for 5 cycles
8. Durability	Contact resistance of 70 m ohm max No damage, cracks, or parts looseness	50 times
9. Resistance to soldering heat	No melting of resin portion which affects performance	Reflow: At the recommended temperature profile Soldering iron temperature: 360°C for 5 seconds

Note 1: The term storage refers to an unused products prior to board mounting (including packing materials) that is being kept for a long period. The operating temperature and humidity range are suited to the non-conducting condition following board assembly.

Note 2: Information contained in this catalog represents general requirements for this Series. Contact us for the drawings and specifications for a specific part number shown.

Materials

Part	Material	Process	Notes
Insulator	LCP	Beige	UL94V-0
Contacts	Phosphor bronze	Header Contact Area: Gold plating Lead Area: Tin plating	_____
		Receptacle Contact Area: Gold plating Lead Area: Flash plating	
Ground plate	Phosphor bronze	Tin plating	_____
Metal fitting	Phosphor bronze	Tin plating	_____

Ordering Information

①
②
③
④
⑤
⑥
⑦

FX10 # - * P / * - SV 1 ()**

① Series name : FX10	⑤ Contact form SV : Straight SMT
② Form symbol A : With guide post B : Without guide post	⑥ Product height Blank : Standard 1 : Standard + 1mm 2 : Standard + 2mm(Under development) 3 : Standard + 3mm(Under development) 4 : Standard + 4mm(Under development)
③ Number of contacts With ground plate Signal/Ground: 80/8, 100/10, 120/12, 140/14 Without ground plate Signal: 96, 120, 144, 168	⑦ Packaging classification / Au plating Blank, (71) : Tray packaging / AuP 0.1 μm (21), (91) : Embossed tape packaging / AuP 0.1 μm (83) : Tray packaging / AuP 0.76 μm (93) : Embossed tape packaging / AuP 0.76 μm
④ Connector type P : Header S : Receptacle	

Signal integrity

Pin assignment

To match 100 ohm differential impedance and to reduce crosstalk, a staggered GSGSG pin assignment is recommended. (G=ground and S=signal)

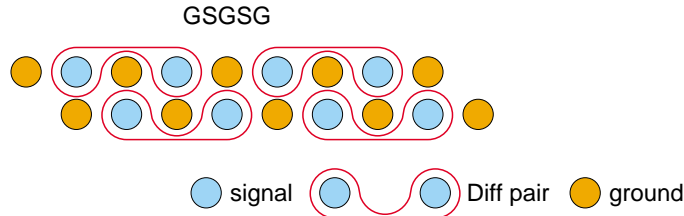

Impedance

The differential impedance is 100 +/- 10 ohm for FX10 at 30 ps rise time (20% to 80%).

4 mm (without GND)

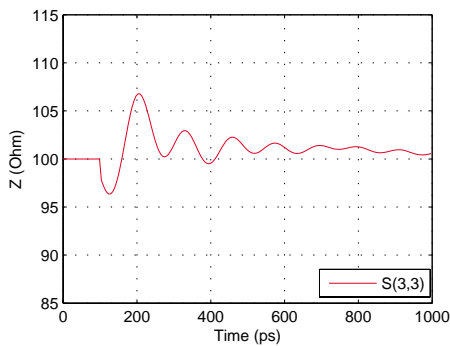

5 mm (without GND)

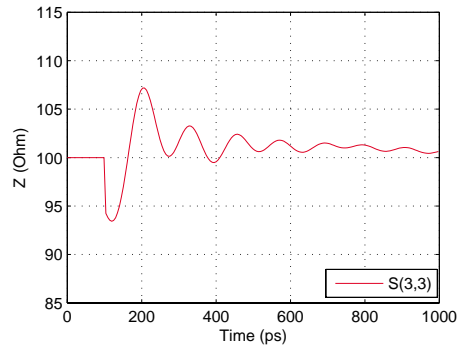

4 mm (with GND)

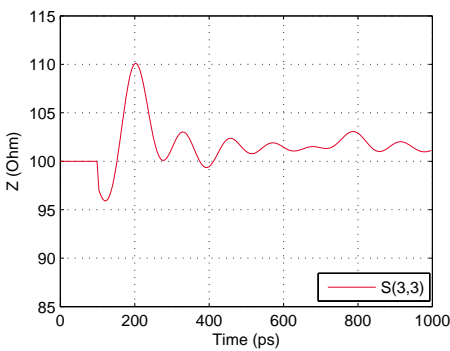

5 mm (with GND)

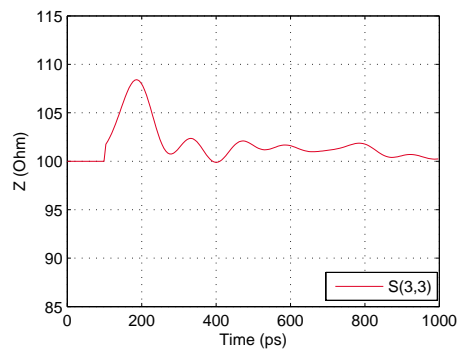

Propagation delay

The propagation delay is 62 and 67 ps for FX10 of 4mm and 5mm height (with and without GND), respectively.

FX10 Series 10+Gbps 0.5mm pitch Stacking Connectors

● Insertion loss

The differential insertion loss crosses 1 dB at 10.8 and 9.2 GHz for FX10 of 4mm and 5mm height, respectively.

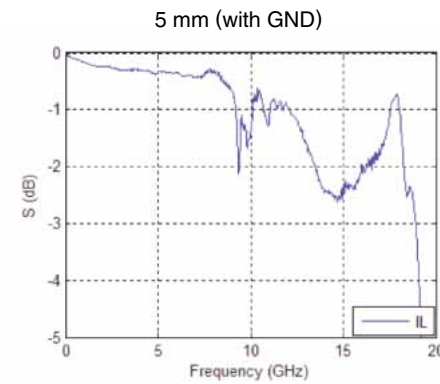
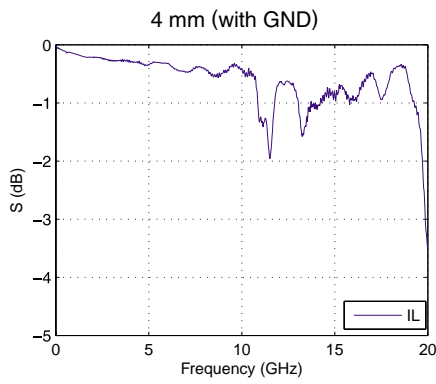
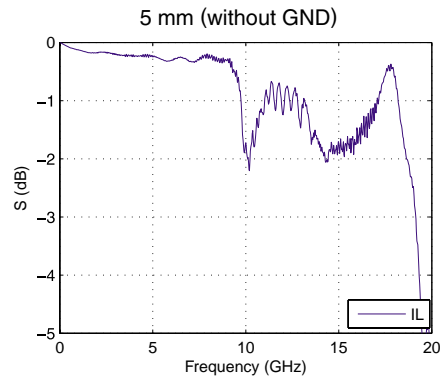
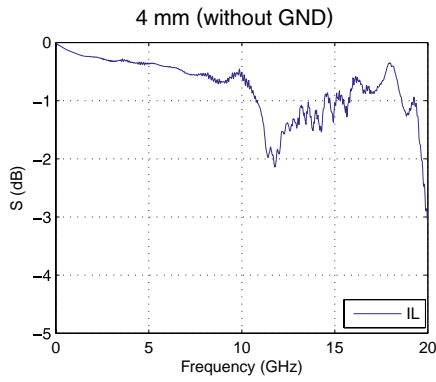

● Return loss

The differential return loss meets the IEEE 802.3ap specification to 20+ and 13.5 GHz for FX10 of 4mm and 5mm height, respectively.

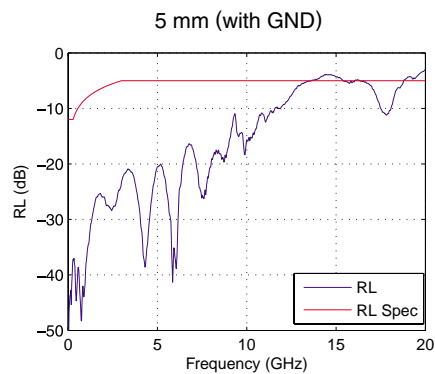
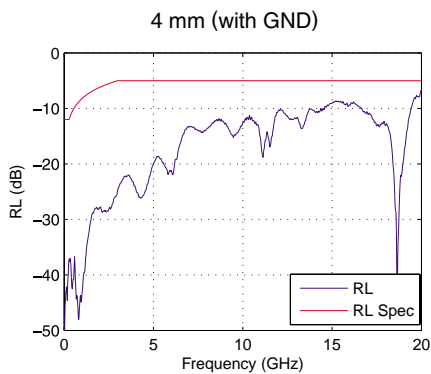
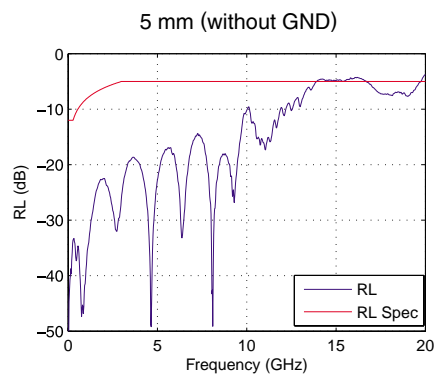
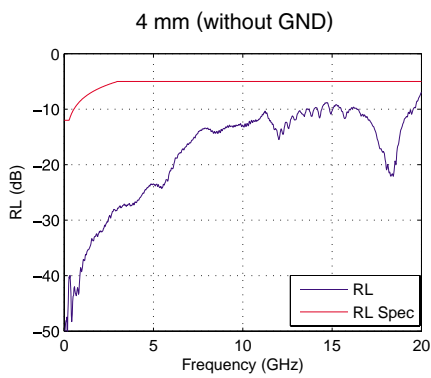

● Near-end crosstalk (NEXT)

The staggered GSGSG pin assignment results in low differential NEXT between neighboring pairs.

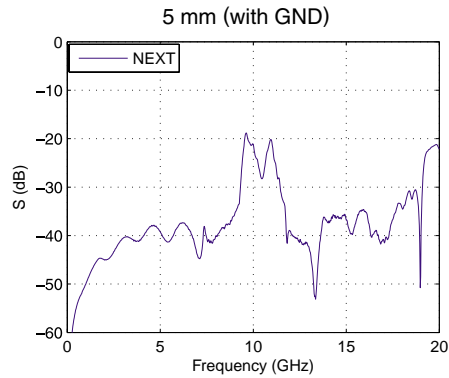
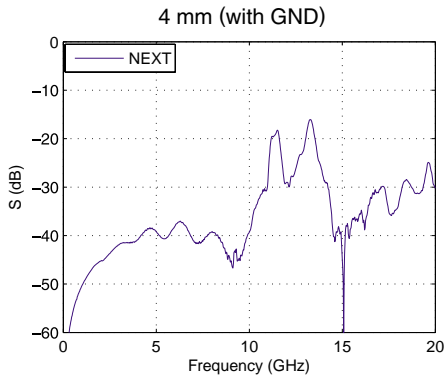
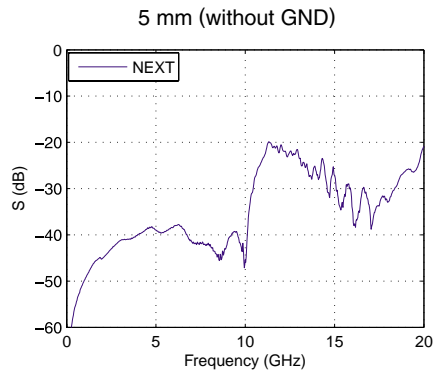
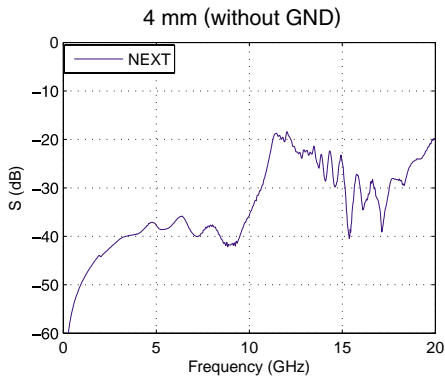

● Far-end crosstalk (FEXT)

The staggered GSGSG pin assignment results in low differential FEXT between neighboring pairs.

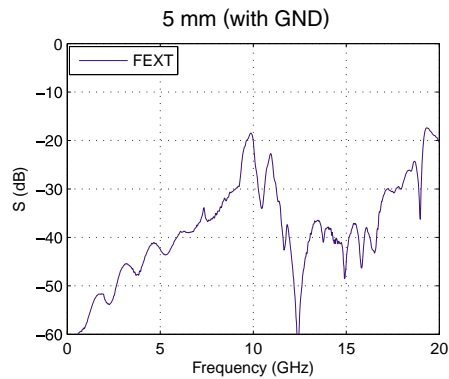
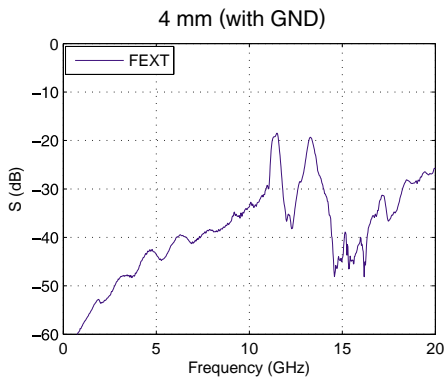
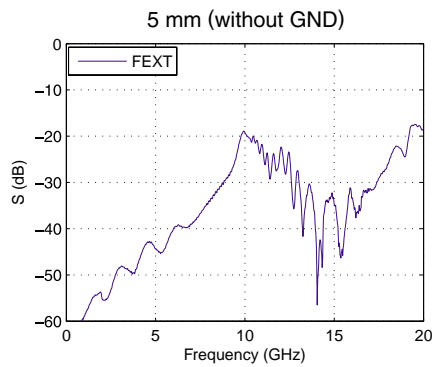
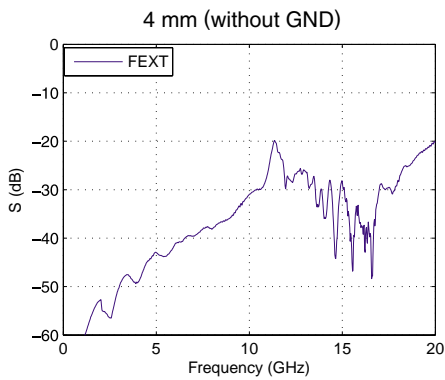

● **Insertion-loss-to-crosstalk ratio (ICR)**

The insertion-loss-to-crosstalk ratio (ICR) with five-aggressor differential FEXT meets the extrapolated IEEE 802.3ap specification to 6.25+ Gbps with plenty of margin.

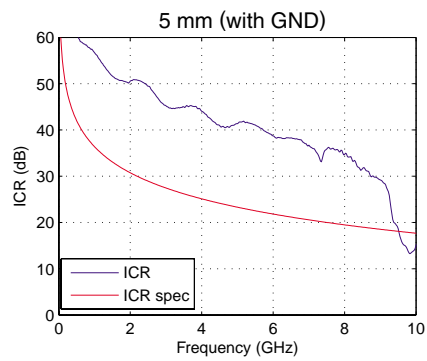
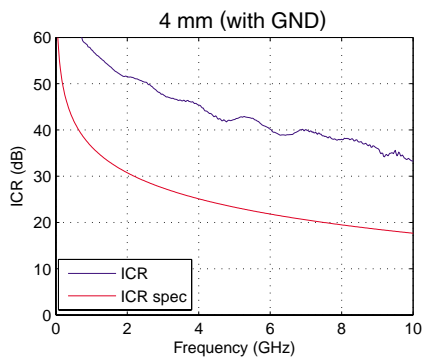
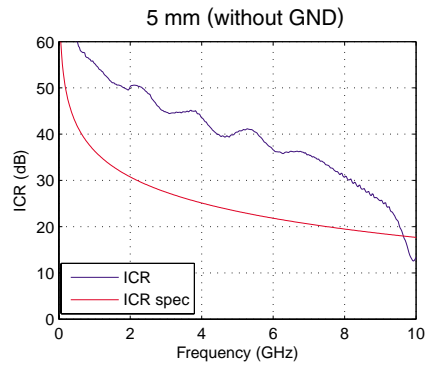
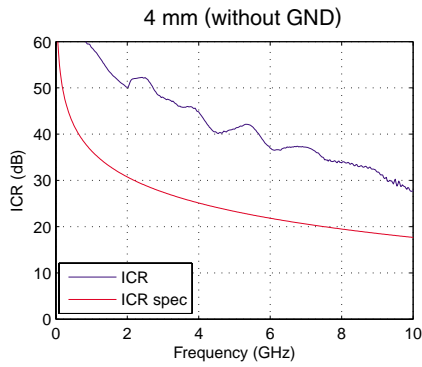

■Headers with ground plate

●4mm Stacking Height

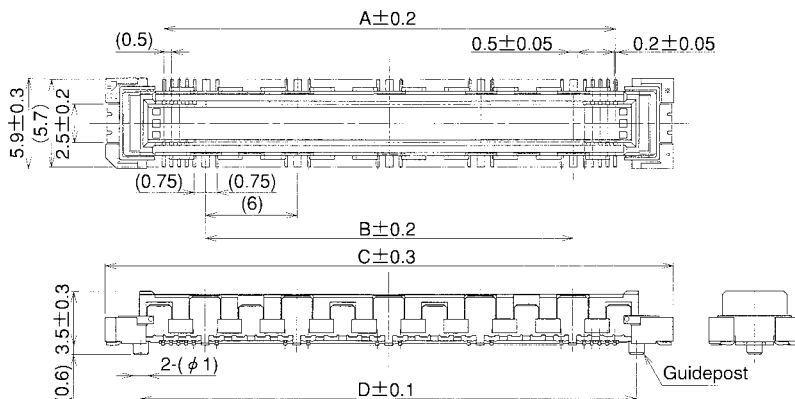

Unit: mm

Part No.	CL No.	Number of Contacts		A	B	C	D	E	F	Remarks	RoHS
		Signal	Ground								
FX10A- 80P/ 8-SV(**)	CL570-0001-5-**	80	8	23.5	18	31.1	26.4	31.5	28.3	With guideposts	YES
FX10A-100P/10-SV(**)	CL570-0002-8-**	100	10	29.5	24	37.1	32.4	37.5	34.3		
FX10A-120P/12-SV(**)	CL570-0003-0-**	120	12	35.5	30	43.1	38.4	43.5	40.3		
FX10A-140P/14-SV(**)	CL570-0004-3-**	140	14	41.5	36	49.1	44.4	49.5	46.3		
FX10B- 80P/ 8-SV(**)	CL570-0021-2-**	80	8	23.5	18	31.1	—	31.5	28.3	Without guideposts	
FX10B-100P/10-SV(**)	CL570-0022-5-**	100	10	29.5	24	37.1	—	37.5	34.3		
FX10B-120P/12-SV(**)	CL570-0023-8-**	120	12	35.5	30	43.1	—	43.5	40.3		
FX10B-140P/14-SV(**)	CL570-0024-0-**	140	14	41.5	36	49.1	—	49.5	46.3		

[Specifications number] - ** , (** *)

(71): Tray packaging / AuP 0.1 μ m

(91): Embossed tape packaging / AuP 0.1 μ m

(83): Tray packaging / AuP 0.76 μ m

(93): Embossed tape packaging / AuP 0.76 μ m

Note 1: There is no polarity in terms of board mounting for this product.

Note 2: The coplanarity of this product's SMT leads is 0.1mm or less.

Note 3: Please order embossed tape packaged items by the reel. (One reel holds 1,000 pieces.)

◆Recommended Land Pattern Dimensions (Metal Mask Dimensions)

Recommended metal mask thickness: 0.15 mm

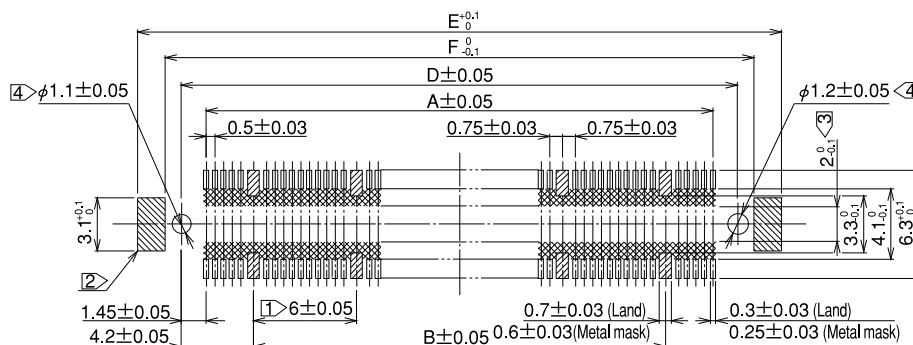

Note ① Cross-hatched portions, totaling n places, indicate the ground circuits.

Note ② Cross-hatched portions, 2 places on both sides, indicate the metal fittings.

Note ③ The cross-hatched area  inside the SMT land may come into contact with the connector contacts and thus care should be taken that the pattern does not extend beyond the SMT land width.

Note ④ Not required in products without guideposts.

FX10 Series 10+Gbps 0.5mm pitch Stacking Connectors

Headers with ground plate

5mm Stacking Height

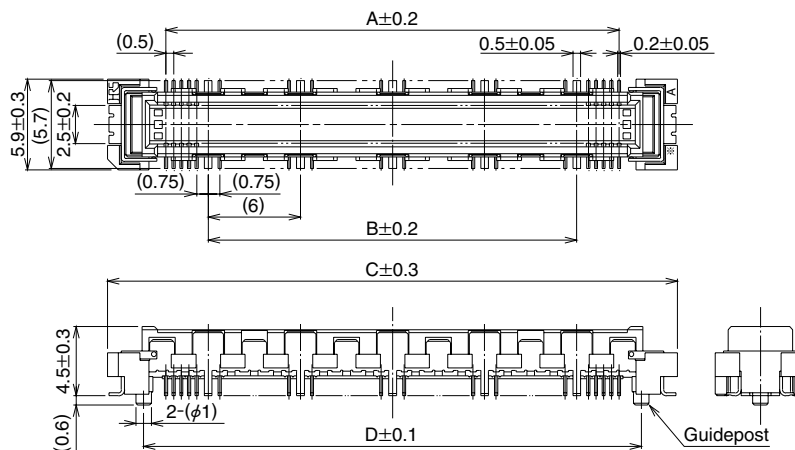

Unit: mm

Part No.	CL No.	Number of Contacts		A	B	C	D	E	F	Remarks	RoHS
		Signal	Ground								
FX10A- 80P/ 8-SV1(**)	CL570-0101-0-**	80	8	23.5	18	31.1	26.4	31.5	28.3	With guideposts	YES
FX10A-100P/10-SV1(**)	CL570-0102-2-**	100	10	29.5	24	37.1	32.4	37.5	34.3		
FX10A-120P/12-SV1(**)	CL570-0103-5-**	120	12	35.5	30	43.1	38.4	43.5	40.3		
FX10A-140P/14-SV1(**)	CL570-0104-8-**	140	14	41.5	36	49.1	44.4	49.5	46.3		
FX10B- 80P/ 8-SV1(**)	CL570-0121-7-**	80	8	23.5	18	31.1	—	31.5	28.3	Without guideposts	
FX10B-100P/10-SV1(**)	CL570-0122-0-**	100	10	29.5	24	37.1	—	37.5	34.3		
FX10B-120P/12-SV1(**)	CL570-0123-2-**	120	12	35.5	30	43.1	—	43.5	40.3		
FX10B-140P/14-SV1(**)	CL570-0124-5-**	140	14	41.5	36	49.1	—	49.5	46.3		

[Specifications number] -*, (**)

(71): Tray packaging / AuP 0.1 μ m

(91): Embossed tape packaging / AuP 0.1 μ m

(83): Tray packaging / AuP 0.76 μ m

(93): Embossed tape packaging / AuP 0.76 μ m

Note 1: There is no polarity in terms of board mounting for this product.

Note 2: The coplanarity of this product's SMT leads is 0.1 mm or less.

Note 3: Please order embossed tape packaged items by the reel. (One reel holds 1,000 pieces.)

Recommended Land Pattern Dimensions (Metal Mask Dimensions)

Recommended metal mask thickness: 0.15 mm

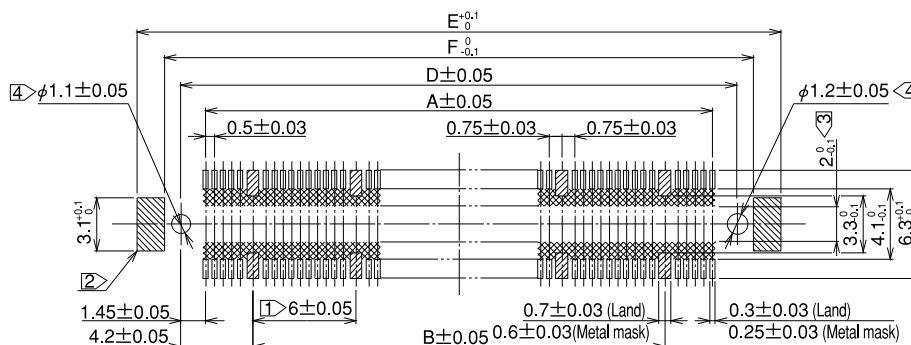

Note ① Cross-hatched portions, totaling n places, indicate the ground circuits.

② Cross-hatched portions, 2 places on both sides, indicate the metal fittings.

③ The cross-hatched area inside the SMT land may come into contact with the connector contacts and thus care should be taken that the pattern does not extend beyond the SMT land width.

④ Not required in products without guideposts.

■Receptacles with ground plate

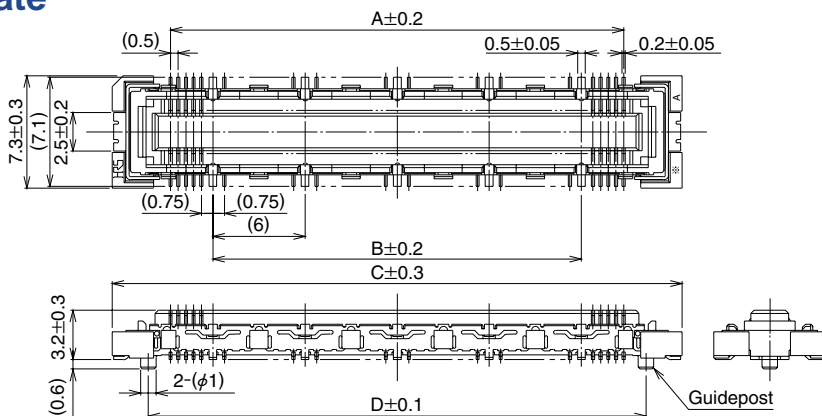

Unit: mm

Part No.	CL No.	Number of Contacts		A	B	C	D	E	F	Remarks	RoHS
		Signal	Ground								
FX10A- 80S/ 8-SV(**)	CL570-0201-4-**	80	8	23.5	18	31.1	26.4	31.5	28.3	With guideposts	YES
FX10A-100S/10-SV(**)	CL570-0202-7-**	100	10	29.5	24	37.1	32.4	37.5	34.3		
FX10A-120S/12-SV(**)	CL570-0203-0-**	120	12	35.5	30	43.1	38.4	43.5	40.3		
FX10A-140S/14-SV(**)	CL570-0204-2-**	140	14	41.5	36	49.1	44.4	49.5	46.3		
FX10B- 80S/ 8-SV(**)	CL570-0221-1-**	80	8	23.5	18	31.1	—	31.5	28.3	Without guideposts	
FX10B-100S/10-SV(**)	CL570-0222-4-**	100	10	29.5	24	37.1	—	37.5	34.3		
FX10B-120S/12-SV(**)	CL570-0223-7-**	120	12	35.5	30	43.1	—	43.5	40.3		
FX10B-140S/14-SV(**)	CL570-0224-0-**	140	14	41.5	36	49.1	—	49.5	46.3		

[Specifications number] - ** , (** *)

(71): Tray packaging / AuP 0.1μm

(91): Embossed tape packaging / AuP 0.1μm

(83): Tray packaging / AuP 0.76μm

(93): Embossed tape packaging / AuP 0.76μm

Note 1: There is no polarity in terms of board mounting for this product.

Note 2: The coplanarity of this product's SMT leads is 0.1 mm or less.

Note 3: Please order embossed tape packaged items by the reel. (One reel holds 1,000 pieces.)

◆Recommended Land Pattern Dimensions (Metal Mask Dimensions)

Recommended metal mask thickness: 0.15 mm

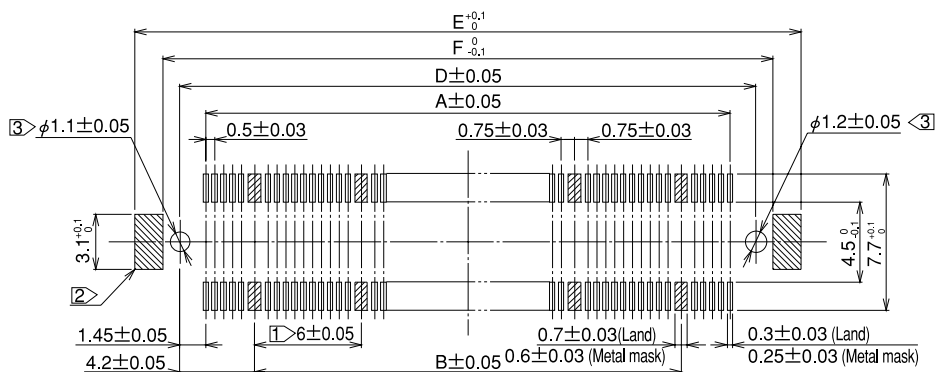

Note ① Cross-hatched portions, totaling n places, indicate the ground circuits.

Note ② Cross-hatched portions, 2 places on both sides, indicate the metal fittings.

Note ③ Not required in products without guideposts.

FX10 Series 10+Gbps 0.5mm pitch Stacking Connectors

Headers without ground plate

4mm Stacking Height

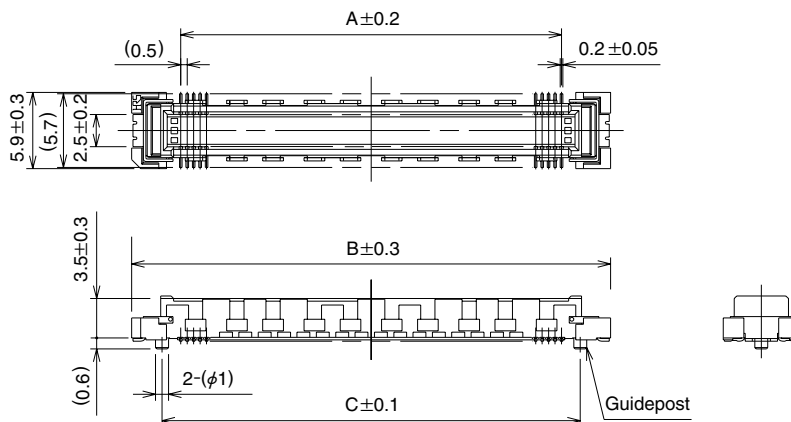

Unit: mm

Part No.	CL No.	Number of Contacts	A	B	C	D	E	Remarks	RoHS
		Signal							
FX10A- 96P-SV(**)	CL570-0041-0-**	96	23.5	31.1	26.4	31.5	28.3	With guideposts	YES
FX10A-120P-SV(**)	CL570-0042-2-**	120	29.5	37.1	32.4	37.5	34.3		
FX10A-144P-SV(**)	CL570-0043-5-**	144	35.5	43.1	38.4	43.5	40.3		
FX10A-168P-SV(**)	CL570-0044-8-**	168	41.5	49.1	44.4	49.5	46.3		
FX10B- 96P-SV(**)	CL570-0051-3-**	96	23.5	31.1	—	31.5	28.3	Without guideposts	
FX10B-120P-SV(**)	CL570-0052-6-**	120	29.5	37.1	—	37.5	34.3		
FX10B-144P-SV(**)	CL570-0053-9-**	144	35.5	43.1	—	43.5	40.3		
FX10B-168P-SV(**)	CL570-0054-1-**	168	41.5	49.1	—	49.5	46.3		

[Specifications number] -*, (**)

(71): Tray packaging / AuP 0.1μm

(91): Embossed tape packaging / AuP 0.1μm

(83): Tray packaging / AuP 0.76μm

(93): Embossed tape packaging / AuP 0.76μm

Note 1: There is no polarity in terms of board mounting for this product.

Note 2: The coplanarity of this product's SMT leads is 0.1 mm or less.

Note 3: Please order embossed tape packaged items by the reel. (One reel holds 1,000 pieces.)

Recommended Land Pattern Dimensions (Metal Mask Dimensions)

Recommended metal mask thickness: 0.15 mm

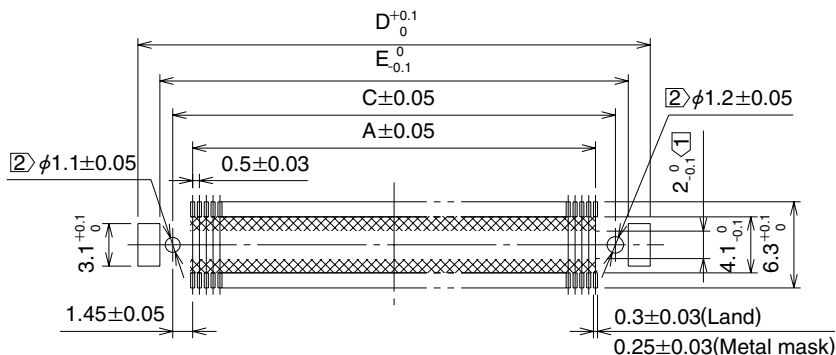

Note ① The cross-hatched area inside the SMT land may come into contact with the connector contacts and thus care should be taken that the pattern does not extend beyond the SMT land width.

Note ② Not required in products without guideposts.

■Headers without ground plate

●5mm Stacking Height

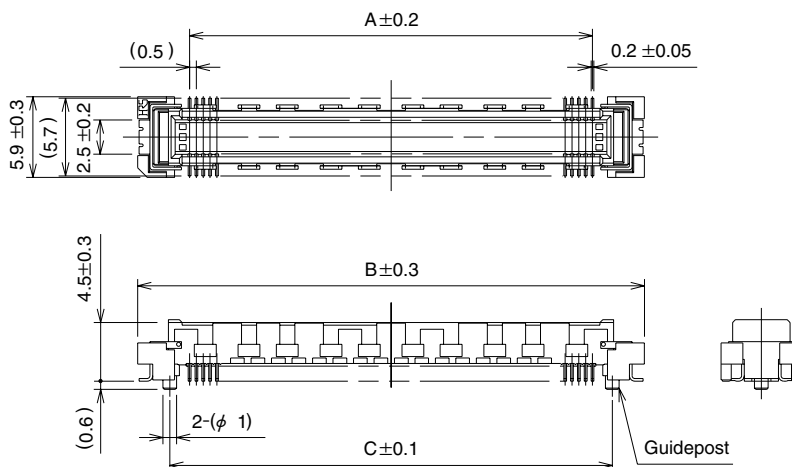

Unit: mm

Part No.	CL No.	Number of Contacts	A	B	C	D	E	Remarks	RoHS
		Signal							
FX10A- 96P-SV1(**)	CL570-0141-4-***	96	23.5	31.1	26.4	31.5	28.3	With guideposts	YES
FX10A-120P-SV1(**)	CL570-0142-7-***	120	29.5	37.1	32.4	37.5	34.3		
FX10A-144P-SV1(**)	CL570-0143-0-***	144	35.5	43.1	38.4	43.5	40.3		
FX10A-168P-SV1(**)	CL570-0144-2-***	168	41.5	49.1	44.4	49.5	46.3		
FX10B- 96P-SV1(**)	CL570-0151-8-***	96	23.5	31.1	—	31.5	28.3	Without guideposts	
FX10B-120P-SV1(**)	CL570-0152-0-***	120	29.5	37.1	—	37.5	34.3		
FX10B-144P-SV1(**)	CL570-0153-3-***	144	35.5	43.1	—	43.5	40.3		
FX10B-168P-SV1(**)	CL570-0154-6-***	168	41.5	49.1	—	49.5	46.3		

[Specifications number] - * *, (**)

(71): Tray packaging / AuP 0.1μm

(91): Embossed tape packaging / AuP 0.1μm

(83): Tray packaging / AuP 0.76μm

(93): Embossed tape packaging / AuP 0.76μm

Note 1: There is no polarity in terms of board mounting for this product.

Note 2: The coplanarity of this product's SMT leads is 0.1 mm or less.

Note 3: Please order embossed tape packaged items by the reel. (One reel holds 1,000 pieces.)

◆Recommended Land Pattern Dimensions (Metal Mask Dimensions)

Recommended metal mask thickness: 0.15 mm

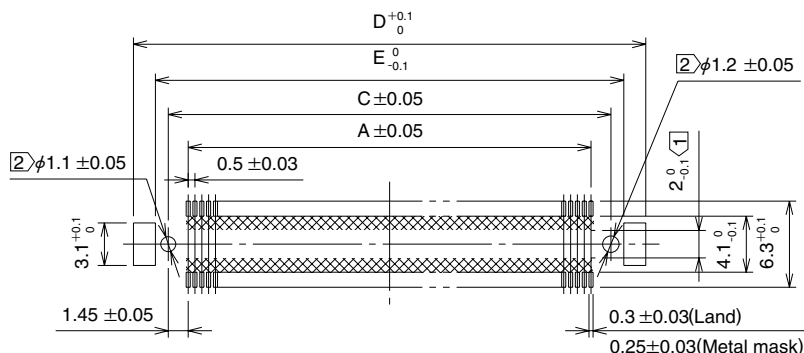

Note ① The cross-hatched area inside the SMT land may come into contact with the connector contacts and thus care should be taken that the pattern does not extend beyond the SMT land width.

Note ② Not required in products without guideposts.

FX10 Series 10+Gbps 0.5mm pitch Stacking Connectors

Receptacles without ground plate

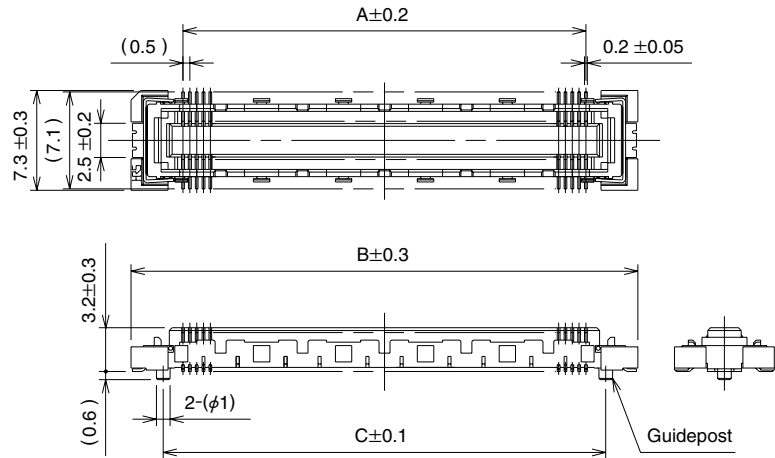

Unit: mm

Part No.	CL No.	Number of Contacts	A	B	C	D	E	Remarks	RoHS
		Signal							
FX10A- 96S-SV(**)	CL570-0241-9-**	96	23.5	31.1	26.4	31.5	28.3	With guideposts	YES
FX10A-120S-SV(**)	CL570-0242-1-**	120	29.5	37.1	32.4	37.5	34.3		
FX10A-144S-SV(**)	CL570-0243-4-**	144	35.5	43.1	38.4	43.5	40.3		
FX10A-168S-SV(**)	CL570-0244-7-**	168	41.5	49.1	44.4	49.5	46.3		
FX10B- 96S-SV(**)	CL570-0251-2-**	96	23.5	31.1	—	31.5	28.3	Without guideposts	
FX10B-120S-SV(**)	CL570-0252-5-**	120	29.5	37.1	—	37.5	34.3		
FX10B-144S-SV(**)	CL570-0253-8-**	144	35.5	43.1	—	43.5	40.3		
FX10B-168S-SV(**)	CL570-0254-0-**	168	41.5	49.1	—	49.5	46.3		

[Specifications number] -** , (**)

(71): Tray packaging / AuP 0.1μm

(91): Embossed tape packaging / AuP 0.1μm

(83): Tray packaging / AuP 0.76μm

(93): Embossed tape packaging / AuP 0.76μm

Note 1: There is no polarity in terms of board mounting for this product.

Note 2: The coplanarity of this product's SMT leads is 0.1 mm or less.

Note 3: Please order embossed tape packaged items by the reel. (One reel holds 1,000 pieces.)

Recommended Land Pattern Dimensions (Metal Mask Dimensions)

Recommended metal mask thickness: 0.15 mm

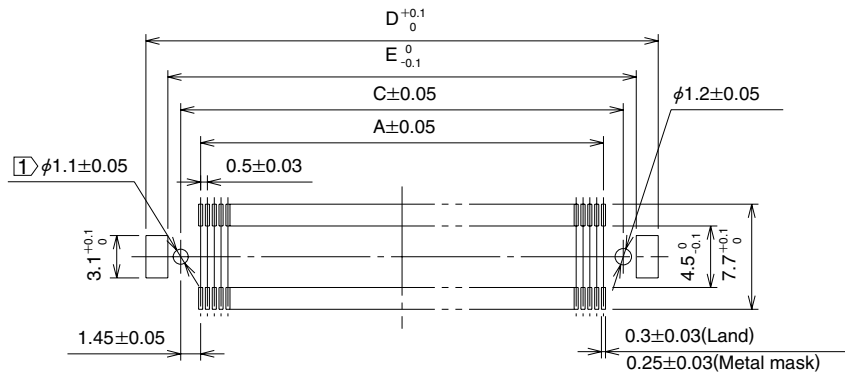

Note ① Not required in products without guideposts.

◆Embossed Carrier Tape Dimensions

●Headers

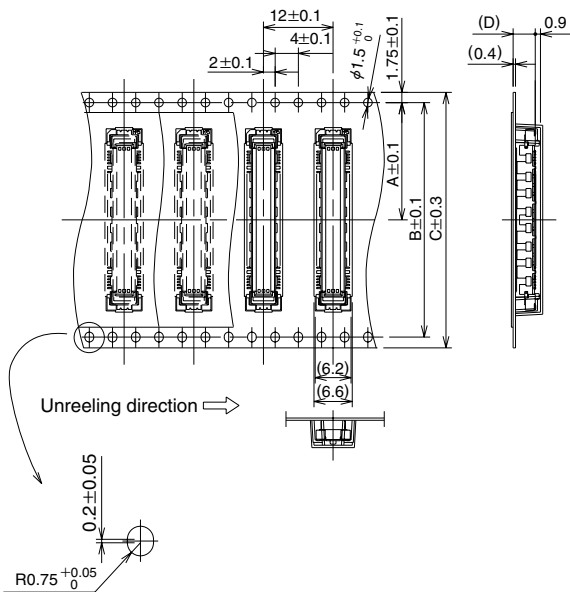

●Receptacles

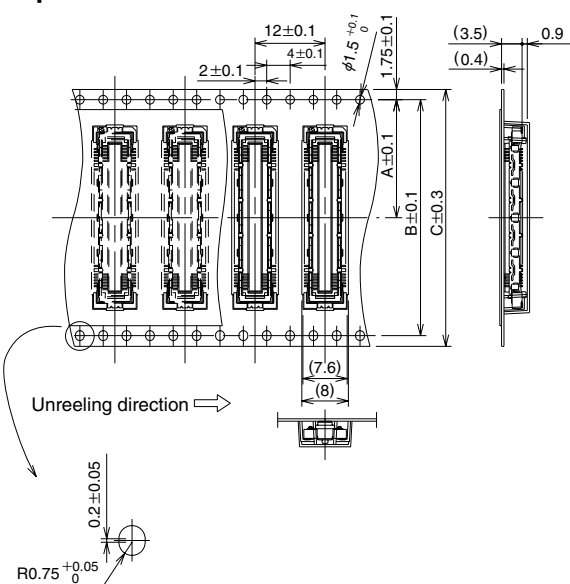

●Reel Dimensions

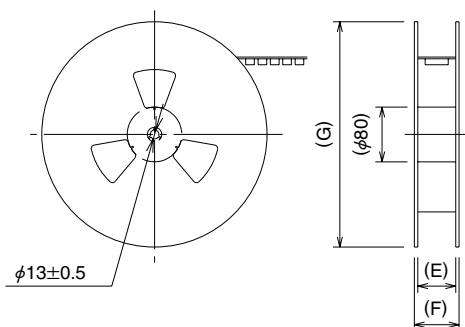

Unit: mm

Insertion Connector	A	B	C	D	E	F	G
FX10#- 80P/ 8-SV	20.2	40.4	44	3.8	45.5	50.5	330
FX10#-100P/10-SV	26.2	52.4	56		59	64	
FX10#-120P/12-SV	34.2	68.4	72		76.5	81.5	
FX10#- 96P -SV	20.2	40.4	44		45.5	50.5	
FX10#-120P -SV	26.2	52.4	56		59	64	
FX10#-144P -SV	34.2	68.4	72		76.5	81.5	
FX10#- 80P/ 8-SV1	20.2	40.4	44	4.8	45.5	50.5	370
FX10#-100P/10-SV1	26.2	52.4	56		59	64	
FX10#-120P/12-SV1	34.2	68.4	72		76.5	81.5	
FX10#- 96P -SV1	20.2	40.4	44		45.5	50.5	
FX10#-120P -SV1	26.2	52.4	56		59	64	
FX10#-144P -SV1	34.2	68.4	72		76.5	81.5	

Note: There is no polarity in terms of embossed tape packaging for this product.

Unit: mm

Insertion Connector	A	B	C	E	F	G
FX10#- 80S/ 8-SV	20.2	40.4	44	45.5	50.5	330
FX10#-100S/10-SV	26.2	52.4	56	59	64	
FX10#-120S/12-SV	34.2	68.4	72	76.5	81.5	
FX10#- 96S -SV	20.2	40.4	44	45.5	50.5	
FX10#-120S -SV	26.2	52.4	56	59	64	
FX10#-144S -SV	34.2	68.4	72	76.5	81.5	

Note: There is no polarity in terms of embossed tape packaging for this product.

◆ Recommended Temperature Profile

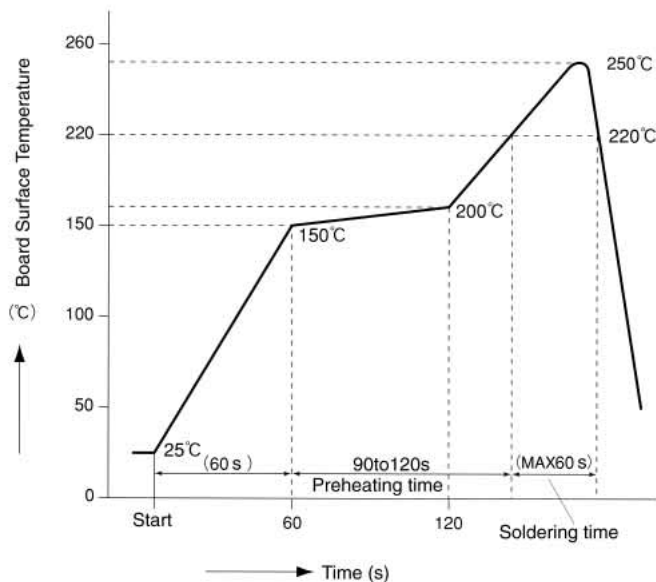

HRS test Conditions

Test board Glass epoxy 161mm×100mm×1.6mm thick
 Solder method :Reflow
 Solder composition :Paste,
 96.5%Sn/3%Ag/0.5%Cu
 Metal mask :0.15mm thick
 Reflow cycles :2 cycles

The temperature profile is based on the above conditions. In individual applications the actual temperature may vary, depending on solder paste type, volume/thickness and board size/thickness. Consult your solder paste and equipment manufacturer for specific recommendations.

◆ Washing Conditions

Organic Solvent Cleaning

Solvent	Room temperature washing	Heated washing
IPA (Isopropyl alcohol)	Yes	Yes
HCFC (Hydrochlorofluorocarbon)	Yes	Yes

Water Type Cleaning

When using water based cleaning agents (e.g., terpene, and alkali saponifiers), select the cleaning agent based on the documentation issued by the various manufacturers of cleaning agents which describes the effects on metals and resins. Be careful that parts are not left with moisture remaining on them.

Cleaning Precautions

Residual flux or cleaning agent on the contacts when washing with organic solvents or water type cleaners can give rise to the deterioration of electrical performance. In this regard it is important to check whether a thorough washing has been performed.

◆ Connector Handling Precautions

1. Allowable Creepage Dimensions at Time of Mating

The effective mating length of this product is 1.1 mm for the signal portion and 1 mm for the ground portion. The creepage of the header and receptacle at the time of mating should be within 0.5 mm of the completely mating condition.

2. Retension of Boards

Avoid the support of boards by connectors alone and adopt a locking measure that does not rely on the connectors.

3. Solder Repair

Flux may rise as far as the contact portion of the connector depending on the flux coating and other factors at the time of repair. This will cause poor contact reliability; therefore, before use, the aforementioned washing conditions should be taken into consideration prior to connector washing.

4. Miscellaneous

·Note that excessive twisting while inserting or withdrawing connectors will cause damage.

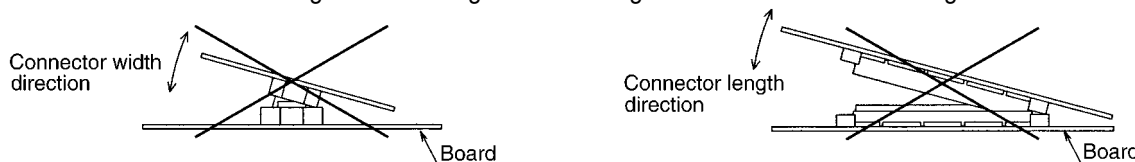

·The shade of the molded items may vary somewhat depending on the manufacturing lot; however, this does not affect performance.

0.5mm Pitch Connectors with Ground Plate for Board-to-Board Connections

FX10 Series

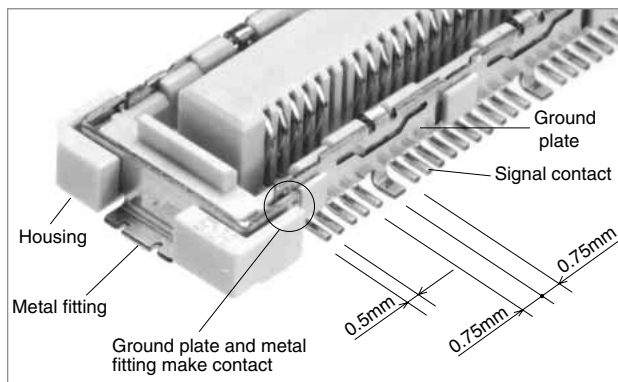
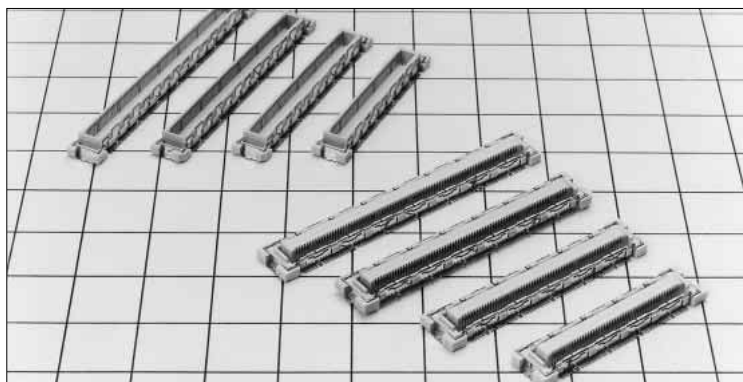

■ Features

1. Improved Transmission Efficiency Between Boards

Transmission characteristics have been improved through a design that fixes ground plates to both sides of the header and receptacle.

2. 10 Signal:1 Ground Arrangement

Signal and ground are arranged in a ratio of 10:1 with the ground plate SMT connected to the board. The ground stability achieved serves to reduce noise.

3. Metal Fittings for Added Solder Weld Strength

Metal fittings provide greater adhesion to the board, protecting against peeling. The unique connector design provides a connection between the fitting and the ground plate for a stronger ground.

4. Suited to High-Density Applications

The signal contact pitch of 0.5 mm produces a smaller connector utilizing less board area for mounting.

5. High contact reliability

Effective mating length is 1.1 mm for signal contacts.

6. Optional Ground Plate

An alternate style without the ground plate is available. The space provided by the ground plate removal has been filled with additional signal contacts.

7. Board-To-Board Dimensions of 4mm and 5 mm Are Available

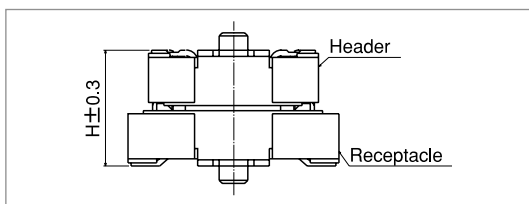

● Cross-Section of Mating

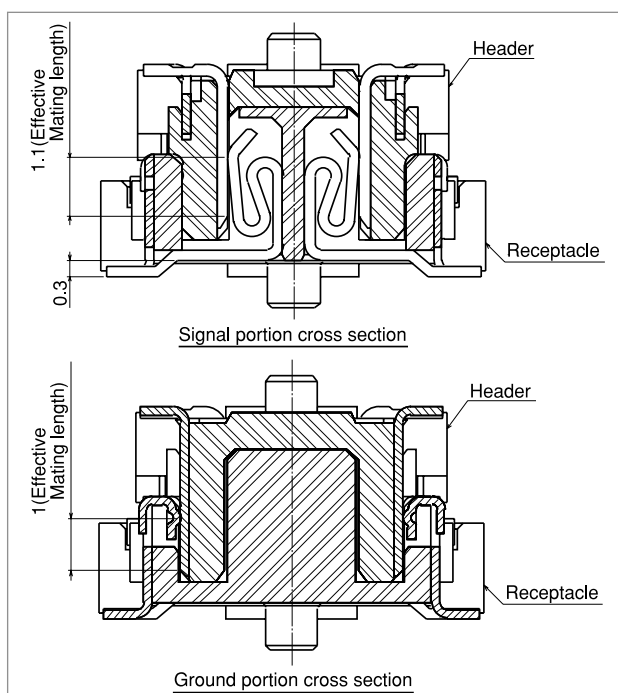

◆ Stack Height

● With ground plate

	Headers	FX10#-*P/*-SV	FX10#-*P/*-SV1
Receptacles		4mm	5mm
	FX10#-*S/*-SV		

● Without ground plate

	Headers	FX10-*P-SV	FX10-*P-SV1
Receptacles		4mm	5mm
	FX10-*S-SV		

■ Applications

Notebook computers, PDA, and other miniature electronic equipment.

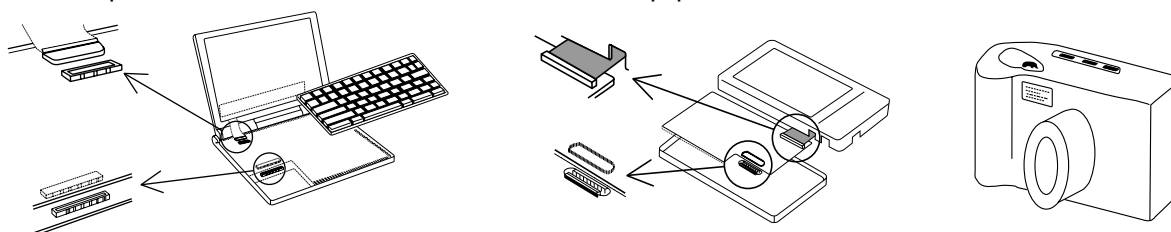

■ Product Specifications

Rating	Rated current Rated voltage	0.3 A (Note 1) 50 V AC	Operating temperature range Operating humidity range	-55 to 85°C Relative humidity 95% or less (No condensation)	Storage temperature range Storage humidity range	-10 to +60°C (Note 1) 40 to 70% (Note 1)
--------	--------------------------------	---------------------------	---	---	---	---

Item	Requirements	Conditions
1. Insulation resistance	100 MΩ or greater	Measured at 100 V DC
2. Voltage resistance	No flashover or breakdown	150 V AC applied for one minute
3. Contact resistance	60 mΩ or less	Measured at 100 mA
4. Vibration	No electrical discontinuity for 1μs or greater No damage, cracks, or parts looseness	Frequency: 10 to 55 Hz, amplitude of 0.75 mm in 3 directions, 10 cycles each
5. Shock	No electrical discontinuity for 1μs or longer No damage, cracks, or parts looseness	Acceleration of 490 m/s ² , 11 ms duration, sine half-wave waveform, for 3 cycles in the both directions of each of the 3 axes
6. Damp heat (Steady state)	Contact resistance of 70 mΩ or less, insulation resistance of 100 MΩ or greater, no damage, cracks, or parts looseness	Temperature of 40°C, humidity of 90 to 95%, duration 96 h
7. Temperature cycle	Contact resistance of 70 mΩ or less, insulation resistance of 100 MΩ or greater, no damage, cracks, or parts looseness	Temperature: -55°C → 15 to 35°C → 85°C → 15 to 35°C Time: 30 min. → 2 to 3 min. → 30 min. → 2 to 3 min. for 5 cycles
8. Durability	Contact resistance of 70 mΩ or less No damage, cracks, or parts looseness	50 times
9. Resistance to soldering heat	No melting of resin portion which affects performance	Reflow: At the recommended temperature profile Soldering iron temperature: 360°C for 5 seconds

Note 1: The term storage refers to an unused products prior to board mounting (including packing materials) that is being kept for a long period. The operating temperature and humidity range are suited to the non-conducting condition following board assembly.

Note 2: The aforementioned specifications are representative of this series. For information on specific parts, confirm with Sales Office.

Note 3: Information contained in this catalog represents general requirements for this Series. Contact us for the drawings and specifications for a specific part number shown.

■ Materials

Part	Material	Process	Notes
Insulator	LCP	Beige	UL94V-0
Contacts	Phosphor bronze	Header	Engagement Area: Gold plating of 0.1μm Termination Area: Tin plating
		Receptacle	Engagement Area: Gold plating of 0.1μm Termination Area: Flash plating
Ground plate	Phosphor bronze	Tin plating	————
Metal fitting	Phosphor bronze	Tin plating	————

■ Product Number Configuration

FX10 **#** - ***** **P** / ***** - **SV** **1** (******)

①
②
④
⑤
⑥
⑦

<p>① Series name: FX10</p> <p>② Form Symbol A: With guide post B: Without guide post</p> <p>③ Number of contacts <input type="checkbox"/> With ground plate Signal/Ground: 80/8, 100/10, 120/12, 140/14 <input type="checkbox"/> Without ground plate Signal: 96, 120, 144, 168</p> <p>④ Connector type P: Header S: Receptacle</p>	<p>⑤ Contact form SV: Straight SMT</p> <p>⑥ Product height Blank: Standard 1 : Standard + 1mm</p> <p>⑦ Packaging classification Blank(71): Tray packaging (21), (91): Embossed tape packaging</p>
---	---

■Headers with ground plate

●5mm Stacking Height

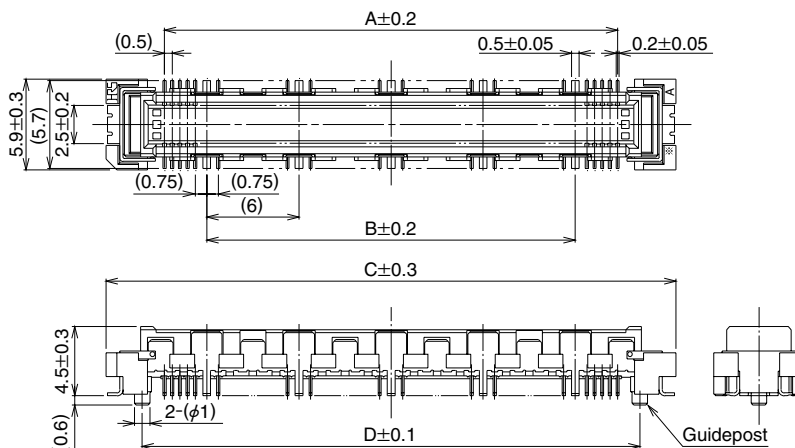

Unit: mm

Part No.	CL No.	Number of Contacts		A	B	C	D	E	F	Remarks	RoHS
		Signal	Ground								
FX10A- 80P/ 8-SV1(71)	CL570-0101-0-71	80	8	23.5	18	31.1	26.4	31.5	28.3	With guideposts	YES
FX10A-100P/10-SV1(71)	CL570-0102-2-71	100	10	29.5	24	37.1	32.4	37.5	34.3		
FX10A-120P/12-SV1(71)	CL570-0103-5-71	120	12	35.5	30	43.1	38.4	43.5	40.3		
FX10A-140P/14-SV1(71)	CL570-0104-8-71	140	14	41.5	36	49.1	44.4	49.5	46.3		
FX10B- 80P/ 8-SV1(71)	CL570-0121-7-71	80	8	23.5	18	31.1	—	31.5	28.3	Without guideposts	
FX10B-100P/10-SV1(71)	CL570-0122-0-71	100	10	29.5	24	37.1	—	37.5	34.3		
FX10B-120P/12-SV1(71)	CL570-0123-2-71	120	12	35.5	30	43.1	—	43.5	40.3		
FX10B-140P/14-SV1(71)	CL570-0124-5-71	140	14	41.5	36	49.1	—	49.5	46.3		

[Specifications number] - * *, (* *)
 (71): Tray packaging
 (91): Embossed tape packaging

Note 1: There is no polarity in terms of board mounting for this product.

Note 2: The coplanarity of this product's SMT leads is 0.1 mm or less.

Note 3: Please order embossed tape packaged items by the reel. (One reel holds 1,000 pieces.)

◆Recommended Land Pattern Dimensions (Metal Mask Dimensions)

Recommended metal mask thickness: 0.15 mm

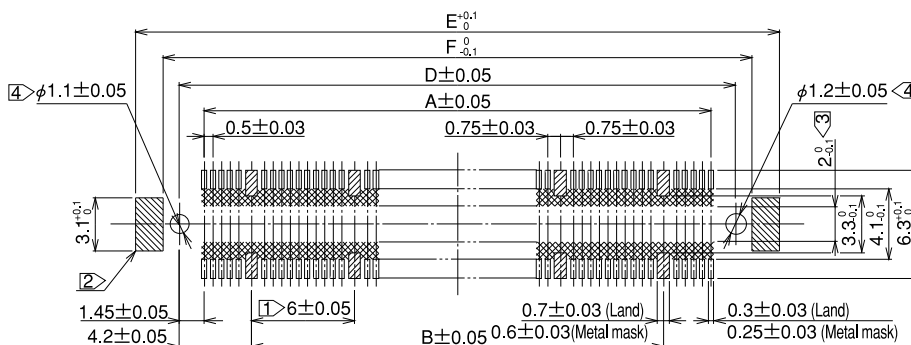

Note ① Cross-hatched portions, totaling n places, indicate the ground circuits.

② Cross-hatched portions, 2 places on both sides, indicate the metal fittings.

③ The cross-hatched area inside the SMT land may come into contact with the connector contacts and thus care should be taken that the pattern does not extend beyond the SMT land width.

④ Not required in products without guideposts.

FX10 Series 0.5mm Pitch Connectors with Ground Plate for Board-to-Board Connections

Receptacles with ground plate

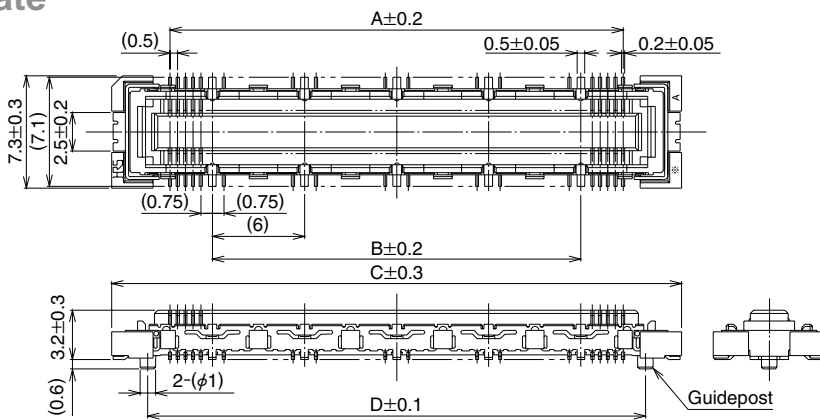

Unit: mm

Part No.	CL No.	Number of Contacts		A	B	C	D	E	F	Remarks	RoHS
		Signal	Ground								
FX10A- 80S/ 8-SV(71)	CL570-0201-4-71	80	8	23.5	18	31.1	26.4	31.5	28.3	With guideposts	YES
FX10A-100S/10-SV(71)	CL570-0202-7-71	100	10	29.5	24	37.1	32.4	37.5	34.3		
FX10A-120S/12-SV(71)	CL570-0203-0-71	120	12	35.5	30	43.1	38.4	43.5	40.3		
FX10A-140S/14-SV(71)	CL570-0204-2-71	140	14	41.5	36	49.1	44.4	49.5	46.3		
FX10B- 80S/ 8-SV(71)	CL570-0221-1-71	80	8	23.5	18	31.1	—	31.5	28.3	Without guideposts	
FX10B-100S/10-SV(71)	CL570-0222-4-71	100	10	29.5	24	37.1	—	37.5	34.3		
FX10B-120S/12-SV(71)	CL570-0223-7-71	120	12	35.5	30	43.1	—	43.5	40.3		
FX10B-140S/14-SV(71)	CL570-0224-0-71	140	14	41.5	36	49.1	—	49.5	46.3		

[Specifications number]- **,(**)
 (71): Tray packaging
 (91): Embossed tape packaging

Note 1: There is no polarity in terms of board mounting for this product.

Note 2: The coplanarity of this product's SMT leads is 0.1 mm or less.

Note 3: Please order embossed tape packaged items by the reel. (One reel holds 1,000 pieces.)

Recommended Land Pattern Dimensions (Metal Mask Dimensions)

Recommended metal mask thickness: 0.15 mm

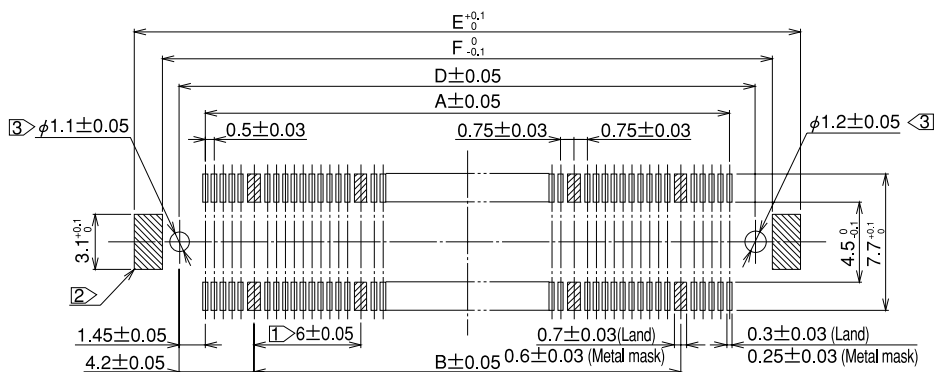

Note ① Cross-hatched portions, totaling n places, indicate the ground circuits.

Note ② Cross-hatched portions, 2 places on both sides, indicate the metal fittings.

Note ③ Not required in products without guideposts.

■ Headers without ground plate

●4mm Stacking Height

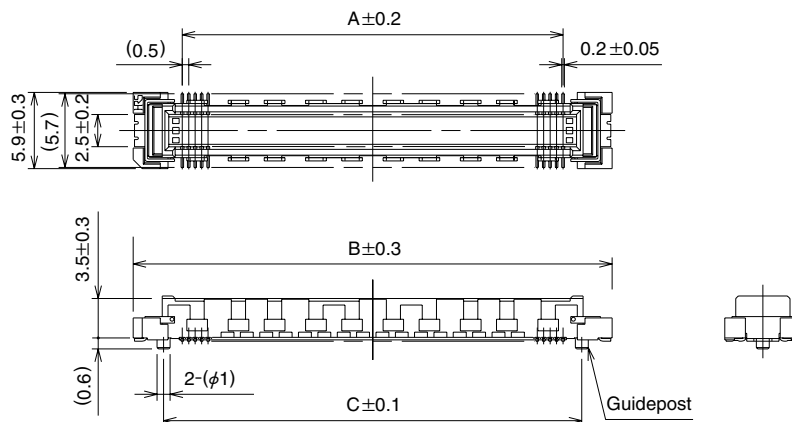

Unit: mm

Part No.	CL No.	Number of Contacts	A	B	C	D	E	Remarks	RoHS
		Signal							
FX10A- 96P-SV(71)	CL570-0041-0-71	96	23.5	31.1	26.4	31.5	28.3	With guideposts	YES
FX10A-120P-SV(71)	CL570-0042-2-71	120	29.5	37.1	32.4	37.5	34.3		
FX10A-144P-SV(71)	CL570-0043-5-71	144	35.5	43.1	38.4	43.5	40.3		
FX10A-168P-SV(71)	CL570-0044-8-71	168	41.5	49.1	44.4	49.5	46.3		
FX10B- 96P-SV(71)	CL570-0051-3-71	96	23.5	31.1	—	31.5	28.3	Without guideposts	
FX10B-120P-SV(71)	CL570-0052-6-71	120	29.5	37.1	—	37.5	34.3		
FX10B-144P-SV(71)	CL570-0053-9-71	144	35.5	43.1	—	43.5	40.3		
FX10B-168P-SV(71)	CL570-0054-1-71	168	41.5	49.1	—	49.5	46.3		

[Specifications number]- **>(* *)
 (71): Tray packaging
 (91): Embossed tape packaging

Note 1: There is no polarity in terms of board mounting for this product.

Note 2: The coplanarity of this product's SMT leads is 0.1 mm or less.

Note 3: Please order embossed tape packaged items by the reel. (One reel holds 1,000 pieces.)

◆Recommended Land Pattern Dimensions (Metal Mask Dimensions)

Recommended metal mask thickness: 0.15 mm

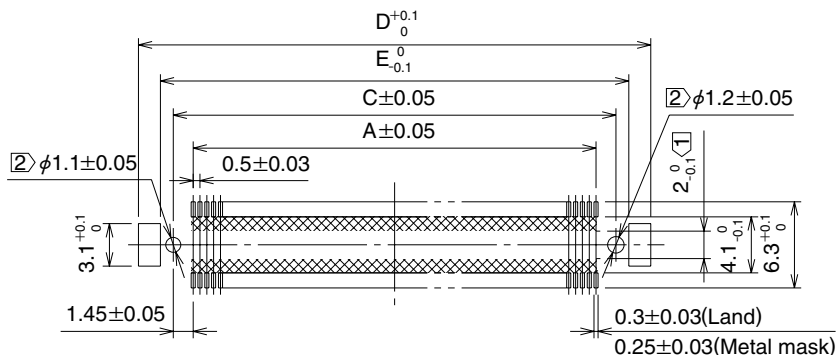

Note ① The cross-hatched area inside the SMT land may come into contact with the connector contacts and thus care should be taken that the pattern does not extend beyond the SMT land width.

Note ② Not required in products without guideposts.

FX10 Series 0.5mm Pitch Connectors with Ground Plate for Board-to-Board Connections

Headers without ground plate

5mm Stacking Height

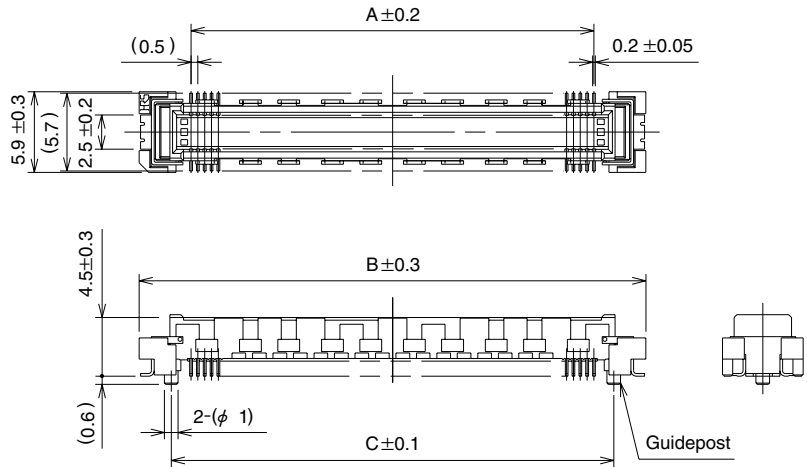

Unit: mm

Part No.	CL No.	Number of Contacts	A	B	C	D	E	Remarks	RoHS
		Signal							
FX10A- 96P-SV1(71)	CL570-0141-4-71	96	23.5	31.1	26.4	31.5	28.3	With guideposts	YES
FX10A-120P-SV1(71)	CL570-0142-7-71	120	29.5	37.1	32.4	37.5	34.3		
FX10A-144P-SV1(71)	CL570-0143-0-71	144	35.5	43.1	38.4	43.5	40.3		
FX10A-168P-SV1(71)	CL570-0144-2-71	168	41.5	49.1	44.4	49.5	46.3		
FX10B- 96P-SV1(71)	CL570-0151-8-71	96	23.5	31.1	—	31.5	28.3	Without guideposts	
FX10B-120P-SV1(71)	CL570-0152-0-71	120	29.5	37.1	—	37.5	34.3		
FX10B-144P-SV1(71)	CL570-0153-3-71	144	35.5	43.1	—	43.5	40.3		
FX10B-168P-SV1(71)	CL570-0154-6-71	168	41.5	49.1	—	49.5	46.3		

[Specifications number]- **>(* *)
 (71): Tray packaging
 (91): Embossed tape packaging

Note 1: There is no polarity in terms of board mounting for this product.

Note 2: The coplanarity of this product's SMT leads is 0.1 mm or less.

Note 3: Please order embossed tape packaged items by the reel. (One reel holds 1,000 pieces.)

Recommended Land Pattern Dimensions (Metal Mask Dimensions)

Recommended metal mask thickness: 0.15 mm

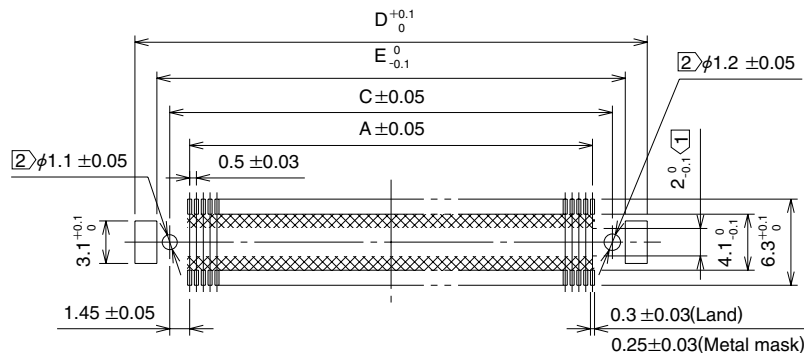

Note ① The cross-hatched area inside the SMT land may come into contact with the connector contacts and thus care should be taken that the pattern does not extend beyond the SMT land width.

Note ② Not required in products without guideposts.

■ Receptacles without ground plate

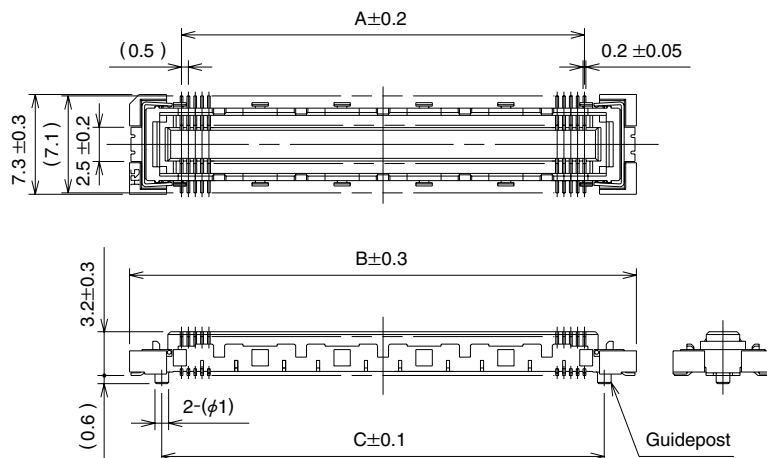

Unit: mm

Part No.	CL No.	Number of Contacts	A	B	C	D	E	Remarks	RoHS
		Signal							
FX10A- 96S-SV(**)	CL570-0241-9-**-	96	23.5	31.1	26.4	31.5	28.3	With guideposts	YES
FX10A-120S-SV(**)	CL570-0242-1-**-	120	29.5	37.1	32.4	37.5	34.3		
FX10A-144S-SV(**)	CL570-0243-4-**-	144	35.5	43.1	38.4	43.5	40.3		
FX10A-168S-SV(**)	CL570-0244-7-**-	168	41.5	49.1	44.4	49.5	46.3		
FX10B- 96S-SV(**)	CL570-0251-2-**-	96	23.5	31.1	—	31.5	28.3	Without guideposts	
FX10B-120S-SV(**)	CL570-0252-5-**-	120	29.5	37.1	—	37.5	34.3		
FX10B-144S-SV(**)	CL570-0253-8-**-	144	35.5	43.1	—	43.5	40.3		
FX10B-168S-SV(**)	CL570-0254-0-**-	168	41.5	49.1	—	49.5	46.3		

[Specifications number]- **,(**)

Blank: Tray packaging

(21) : Embossed tape packaging

Note 1: There is no polarity in terms of board mounting for this product.

Note 2: The coplanarity of this product's SMT leads is 0.1 mm or less.

Note 3: Please order embossed tape packaged items by the reel. (One reel holds 1,000 pieces.)

◆ Recommended Land Pattern Dimensions (Metal Mask Dimensions)

Recommended metal mask thickness: 0.15 mm

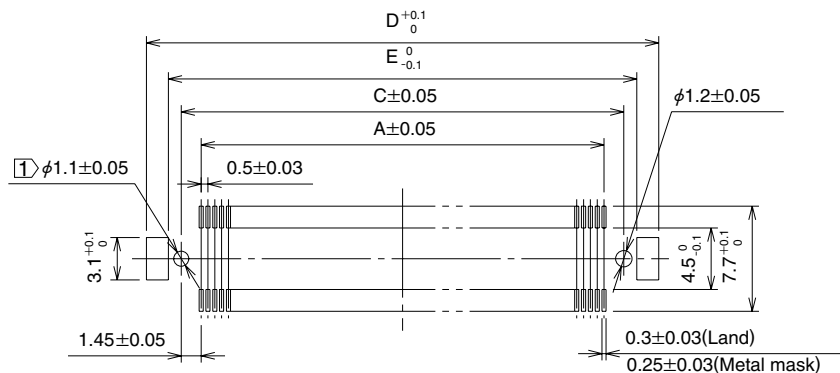

Note ① Not required in products without guideposts.

FX10 Series 0.5mm Pitch Connectors with Ground Plate for Board-to-Board Connections

◆ Embossed Carrier Tape Dimensions

● Headers

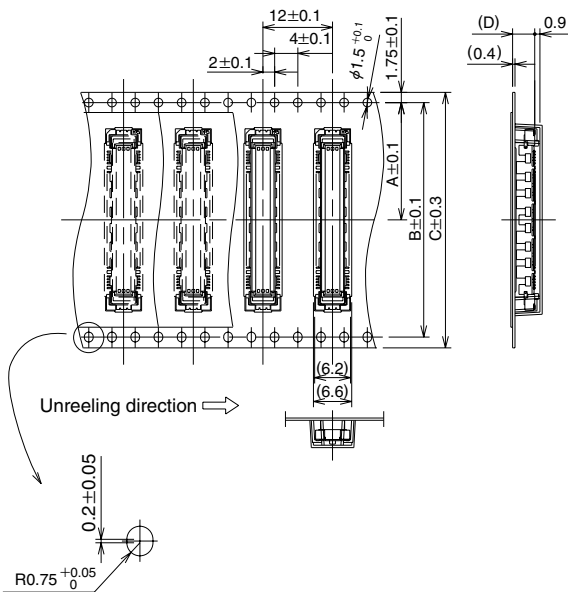

● Receptacles

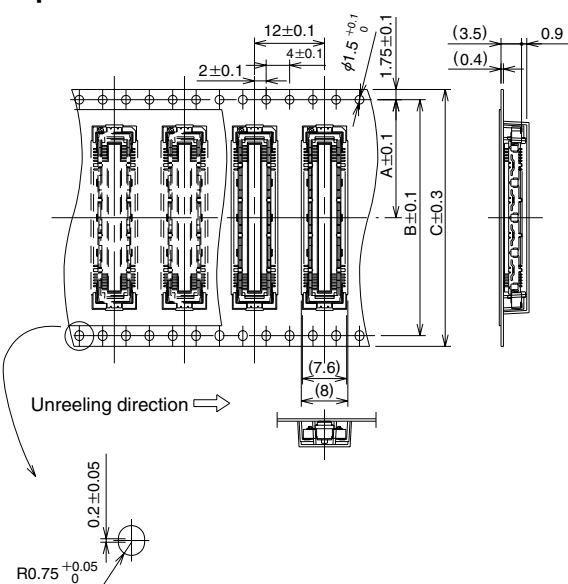

● Reel Dimensions

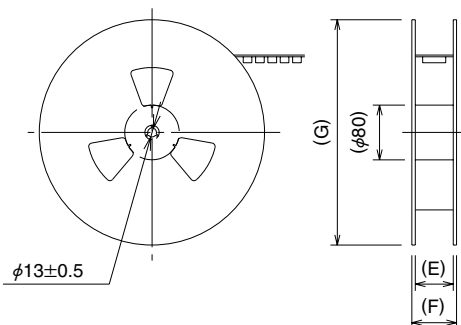

Unit: mm

Insertion Connector	A	B	C	D	E	F	G
FX10#- 80P/ 8-SV1	20.2	40.4	44	3.8	45.5	50.5	330
FX10#-100P/10-SV1	26.2	52.4	56		59	64	
FX10#-120P/12-SV1					76.5	81.5	
FX10#-140P/14-SV1	34.2	68.4	72		45.5	50.5	
FX10#-196P/ -SV1	20.2	40.4	44		4.8	370	
FX10#-120P/ -SV1	26.2	52.4	56				
FX10#-144P/ -SV1				76.5			81.5
FX10#-168P/ -SV1	34.2	68.4	72	45.5			50.5
FX10#- 80P/ 8-SV1	20.2	40.4	44	4.8	370		
FX10#-100P/10-SV1	26.2	52.4	56			59	64
FX10#-120P/12-SV1						76.5	81.5
FX10#-140P/14-SV1	34.2	68.4	72			45.5	50.5
FX10#-196P/ -SV1	20.2	40.4	44			4.8	370
FX10#-120P/ -SV1	26.2	52.4	56				
FX10#-144P/ -SV1				76.5	81.5		
FX10#-168P/ -SV1	34.2	68.4	72	45.5	50.5		

Note: There is no polarity in terms of embossed tape packaging for this product.

Unit: mm

Insertion Connector	A	B	C	E	F	G	
FX10#- 80P/ 8-SV1	20.2	40.4	44	45.5	50.5	330	
FX10#-100P/10-SV1	26.2	52.4	56	59	64		
FX10#-120P/12-SV1				76.5	81.5		
FX10#-140P/14-SV1	34.2	68.4	72	45.5	50.5		
FX10#-196P/ -SV1	20.2	40.4	44	4.8	370		
FX10#-120P/ -SV1	26.2	52.4	56				59
FX10#-144P/ -SV1						76.5	81.5
FX10#-168P/ -SV1	34.2	68.4	72			45.5	50.5

Note: There is no polarity in terms of embossed tape packaging for this product.

◆ Recommended Temperature Profile

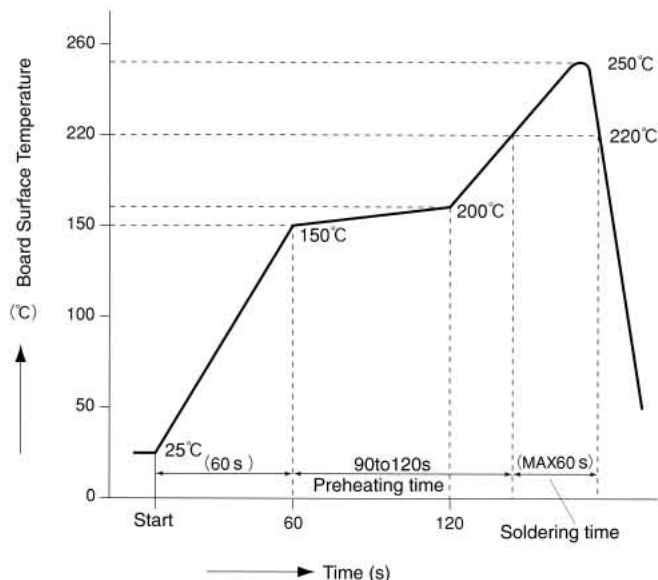

HRS test Conditions

Test board Glass epoxy 161mm×100mm×1.6mm thick
 Solder method :Reflow
 Solder composition :Paste,
 96.5%Sn/3%Ag/0.5%Cu
 Metal mask :0.15mm thick
 Reflow cycles :2 cycles

The temperature profile is based on the above conditions. In individual applications the actual temperature may vary, depending on solder paste type, volume/thickness and board size/thickness. Consult your solder paste and equipment manufacturer for specific recommendations.

◆ Washing Conditions

Organic Solvent Washing

Solvent	Room temperature washing	Heated washing
IPA (Isopropyl alcohol)	Yes	Yes
HCFC (Hydrochlorofluorocarbon)	Yes	Yes

Water Type Washing

When using water type cleaning agents (e.g., terpene, and alkali saponifiers), select the cleaning agent based on the documentation issued by the various manufacturers of cleaning agents which describes the effects on metals and resins. Be careful that parts are not left with moisture remaining on them.

Washing Precautions

Residual flux or cleaning agent on the contacts when washing with organic solvents or water type cleaners can give rise to the deterioration of electrical performance. In this regard it is important to check whether a thorough washing has been performed.

◆ Connector Handling Precautions

1. Allowable Creepage Dimensions at Time of Mating

The effective mating length of this product is 1.1 mm for the signal portion and 1 mm for the ground portion. The creepage of the header and receptacle at the time of mating should be within 0.5 mm of the completely mating condition.

2. Retension of Boards

Avoid the support of boards by connectors alone and adopt a locking measure that does not rely on the connectors.

3. Solder Repair

Flux may rise as far as the contact portion of the connector depending on the flux coating and other factors at the time of repair. This will cause poor contact reliability; therefore, before use, the aforementioned washing conditions should be taken into consideration prior to connector washing.

4. Miscellaneous

·Note that excessive twisting while inserting or withdrawing connectors will cause damage.

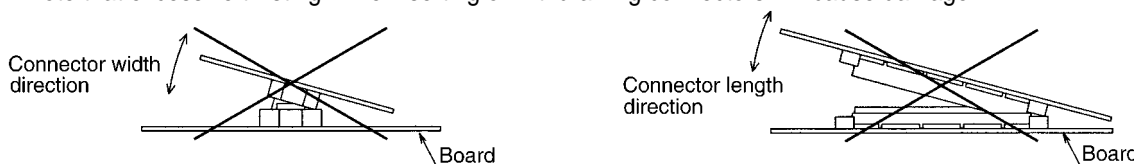

·The shade of the molded items may vary somewhat depending on the manufacturing lot; however, this does not affect performance.