

Power supplies

Version 2023



Weidmüller 

Orange Selection

Quick and easy planning

As a planning engineer, do you want to select products easily and receive them quickly? From a partner you can rely on? Then plan with the Orange Selection from Weidmüller in the future. The Orange Selection items are always available, carefully selected and the portfolio consists of more than 1,500 items to fully cover your standard needs.

If your order is placed before 3:00 pm, we guarantee that your order will be on its way the very next working day.

For even more efficient planning and production processes, we will of course provide all articles in digital form. CAD, ETIM and eClass data are available in our online product catalogue **catalog.weidmueller.com**

We have summarised all the advantages of the Orange Selection on our website.

Check it out: **www.weidmueller.com/orange-selection**



Power supplies

Catalogue 4.3

Power supplies

Switched-mode power supply units

Electronic load monitoring

Uninterruptible power supplies

DC/DC converters

Redundancy- and diode modules

Communication modules

Appendix

Service and support

Glossary/Technical appendix

Index

Index Type / Index Order No.
Addresses worldwide

Power supplies – Overview

connectPower 1ph PROtop



- Single-phase switched-mode power supply module
- High MTBF values
- Cl. I Div. 2 + ATEX
- Power category 72...960 W
- Output 12, 24 and 48 V DC

connectPower 3ph PROtop



- Multiphase switched-mode power supply module
- 3× 320...575 V AC or 2× 360...575 V AC
- 450...800 V DC
- UL approval
- Power category 120...960 W

connectPower PROtop DCDC



- DCL technology for excellent dynamic range
- Operating modes: single / parallel operation and adjustable short-circuit behaviour (continuous current or switch-off)
- High durability up to 15 years, MTBF > 1.000.000 hours

connectPower PROtop UW



- DCL technology for excellent dynamic range
- Operating modes: single / parallel operation and adjustable short-circuit behaviour (continuous current or switch-off)
- High durability up to 15 years, MTBF > 1.000.000 hours

connectPower 1ph PROmax



- Single-phase switched-mode power supply module
- Slim design
- High efficiency
- Power category from 70...960 W
- International approvals

connectPower 3ph PROmax



- 3-phase switched-mode power supply module
- Slim design
- High efficiency
- Power category 120...960 W
- Wide range of approvals

connectPower 1ph PROeco



- Single-phase switched-mode power supply modules
- Slim design
- Large temperature range from -25 °C to 70 °C
- Three-coloured LED indicators for simple error detection
- Advanced visual warning at 90 % rated output current
- International approvals

connectPower 3ph PROeco



- 3-phase switched-mode power supply modules
- Slim design
- Large temperature range from -25 °C to 70 °C
- Three-coloured LED indicators for simple error detection
- Advanced visual warning at 90 % rated output current
- International approvals

connectPower PRObas



- Single-phase switched-mode power supply modules
- Compact design
- Flexible mounting
- High efficiency
- Robust & reliable

connectPower PRO-PM



- Wall mounting
- Flat design
- Metal housing
- Power category 25...350 W
- Universal input and output voltages

connectPower 1ph INSTA POWER



- Single-phase switched-mode power supply modules for the distribution board
- Compact form
- Power category 16 and 96 W
- Input and output voltage 5...48 V
- International approvals

topGUARD



- Electronic load monitoring
- Integrated potential distribution
- IO Link capable
- CANopen capable
- Status notification LEDs

maxGUARD

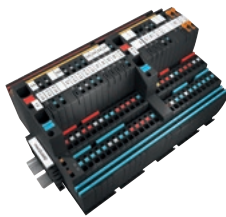

- Electronic load monitoring
- Status notification LEDs and potential-free contact
- Reset input
- Compact design

connectPower UPS control units



- Two 24 V models in 10 A/20 A and 40 A
- Temperature-compensated charging feature, for a long battery life
- Integrated battery diagnostics including continuous availability test
- Status relay and additional transistor outputs for remote monitoring
- Convenient LED displays for easy error analysis

connectPower Battery modules



- Maintenance-free, lead-acid batteries from 1.3 Ah to 17 Ah
- Integrated temperature sensor for an extended service life
- Integrated fuse for reliable activation
- Buffer times up to 40 A / 30 min or 10 A / 90 min
- Robust metal housing for wall mounting

connectPower Buffer modules



- Buffer time: 320 ms @ 20 A or 230 ms @ 40 A
- Wide-ranging approvals and broad temperature range
- Status indicator via LEDs and signal connections
- Space-saving and maintenance-free
- Suitable for parallel connection

connectPower DC/DC converters



- Compact form
- Metal housing
- International approvals
- High degree of efficiency
- DCL peak load reserve up to 600%

connectPower Redundancy modules



- Fast status diagnosis via LED display and status relay
- Universally applicable due to wide range of variants (max. up to 80 A output current)
- Wide range of approvals (e.g. cULus, Class I, Div. 2, ATEX and IECEx)

Power supplies – Overview

connectPower Diode modules



- Diode module for 100 % decoupling of switching power supplies
- Optimal power doubling
- Max. up to 40 A Output current
- International approvals

Communication modules



- Tool-free assembly
- Protection class IP20
- Flexible to adapt PROtop and topGUARD to different communication protocols
- Available in CANopen and IO-Link

Service and support

Service connects – worldwide

Page V.2



- Service connects – worldwide
- Engineering services and customised products
- easyConnect – Your Industrial Service Platform
- Support Center
- Additional support services
- Weidmüller Configurator











Digital ordering options

Page V.10







Purchasing made easy:

- Weidmüller eShop
- OCI interface
- EDI interface

Series / family		Input side		Output side				Additional functions				Recommendation for application						Order No.																
Page	Description	Phases	AC input voltage [V]	DC input voltage [V]	Rated voltage [V]	Rated current [A]	Power rating [W]	Derating at [°C]	Load reserve	Type of contact	Temperature range [°C]	Efficiency [%]	MTBF time [Mh]	Surge category	Approvals	Field cabinets	Small and series machine construction	Machine construction and plant manufacture	Simple process applications	Process industry	Energy technology	Power distribution	Marine engineering											
PR0max A.42	PRO MAX 72W 24V 3A	1	85...277	80...370	24	3	72	> 60	130 % permanently with ≤ 40 °C	CO	-25...+70	90	> 0.5	III	  CI1Div2   EAC  Semi F47 									1478100000										
	PRO MAX 120W 24V 5A				24	5	120					90				1478110000																		
	PRO MAX 180W 24V 7.5A				24	7.5	180					90				1478120000																		
	PRO MAX 240W 24V 10A				24	10	240					91				1478130000																		
	PRO MAX 480W 24V 20A				24	20	480					91				1478140000																		
	PRO MAX 960W 24V 40A				24	40	960					91.5				1478150000																		
	PRO MAX 70W 5V 14A				5	14	70					86				1478210000																		
	PRO MAX 72W 12V 6A				12	6	72					89				1478220000																		
	PRO MAX 120W 12V 10A				12	10	120					89				1478230000																		
	PRO MAX 240W 48V 5A				48	5	240					91				1478240000																		
	PRO MAX 480W 48V 10A				48	10	480					91.5				1478200000																		
	PRO MAX 960W 48V 20A				48	20	960					92.5				1478270000																		
	PRO MAX3 120W 24V 5A				2/3	3 x 320-3 x 575/ 2 x 360-2 x 575	450...800 (max. 500 acc. to UL508)					24				5	120	90	1478170000															
	PRO MAX3 240W 24V 10A											24				10	240	91	1478180000															
	PRO MAX3 480W 24V 20A											24				20	480	91.5	1478190000															
PRO MAX3 960W 24V 40A	24	40	960	92.5				1478200000																										
PR0eco A.54	PRO ECO 72W 24V 3A	1	85...264	80...370	24	3	72	> 40	NO	-25...+70	87	> 0.5	II	  LISTED EAC 										1469470000										
	PRO ECO 120W 24V 5A				24	5	120				87				1469480000																			
	PRO ECO 240W 24V 10A				24	10	240				90				1469490000																			
	PRO ECO 480W 24V 20A				24	20	480				91				1469510000																			
	PRO ECO 960W 24V 40A				24	40	960				93				1469520000																			
	PRO ECO 72W 12V 6A				12	6	72				90				1469570000																			
	PRO ECO 120W 12V 10A				12	10	120				90				1469580000																			
	PRO ECO 240W 48V 5A				48	5	240				90				1469590000																			
	PRO ECO 480W 48V 10A				48	10	480				90				1469610000																			
	PRO ECO3 120W 24V 5A				2/3	3 x 320-3 x 575/ 2 x 360-2 x 575	450...800 (max. 500 acc. to UL508)				24				5	120	89	1469530000																
	PRO ECO3 240W 24V 10A										24				10	240	93	1469540000																
	PRO ECO3 480W 24V 20A										24				20	480	94	1469550000																
	PRO ECO3 960W 24V 40A										24				40	960	95.3	1469560000																
	PR0bas A.56				PRO BAS 30W 24V 1.3A	1	85...264 (Derating @ 100 V AC)				110...370 V DC (Derating @ < 120 V DC)				24	1.3	30	> 55	/	-25...+70	89	> 0.5	II	  LISTED										2838500000
					PRO BAS 30W 12V 2.6A										12	2.6	30				89				2838510000									
PRO BAS 30W 5V 6A		5	6	30	87			2838400000																										
PRO BAS 60W 24V 2.5A		24	2.5	60	90			2838410000																										
PRO BAS 60W 12V 5A		12	5	60	90			2838420000																										
PRO BAS 90W 24V 3.8A		24	3.8	90	89.4			2838430000																										
PRO BAS 120W 24V 5A		24	5	120	90			2838440000																										
PRO BAS 120W 12V 10A		12	10	120	90			2838450000																										
PRO BAS 240W 24V 10A		24	10	240	94			2838460000																										
PRO BAS 240W 48V 5A		48	5	240	95			2838470000																										
PRO BAS 480W 24V 20A		24	10	480	95			2838480000																										
PRO BAS 480W 48V 10A		48	20	480	95			2838490000																										

Find the perfect product to meet your requirement

Our extensive portfolio of power supplies at a glance

Series / family		Input side		Output side				Additional functions				Recommendation for application						Order No.																				
Page	Description	Phases	AC input voltage [V]	DC input voltage [V]	Rated voltage [V]	Rated current [A]	Power rating [W]	Derating at [°C]	Load reserve	Type of contact	Temperature range [°C]	Efficiency [%]	MTBF time [Mh]	Surge category	Approvals	Field cabinets	Small and series machine construction	Machine construction and plant manufacture	Simple process applications	Process industry	Energy technology	Power distribution	Marine engineering															
PRO-PM A.76	PRO PM 100W 12V 8.5A	1	90...264	/	12	8.5	100	> 50	/	/	-20...+70	84	/	II	 	●	●	●							2660200285													
	24				4.5	100	86					●				●	●																2660200286					
	48				2.3	100	86					●				●	●																		2660200287			
	12				12.5	150	84					●				●	●																		2660200288			
	24				6.5	150	86					●				●	●																			2660200289		
	48				3.3	150	86					●				●	●																				2660200290	
	12				21	250	84					●				●	●																				2660200291	
	24				10.5	250	86					●				●	●																					2660200292
	48				5.2	250	86					●				●	●																					2660200293
	24				14.6	350	86					●				●	●																					2660200294
	48				7.3	350	86					●				●	●																					2660200295
	12				3	35	84					●				●	●																					2660200278
	24				1.5	35	86					●				●	●																					2660200279
	48				0.75	35	86					●				●	●																					2660200280
	5				7	35	82					●				●	●																					2660200277
	12				6	75	84					●				●	●																					2660200282
	24				3.2	75	86					●				●	●																					2660200283
	48				1.6	75	86					●				●	●																					2660200284
	5				14	75	82					●				●	●																					2660200281
	INSTA POWER A.90				PRO INSTA 16W 24V 0.7A	1	85...264 (Derating @ 100 V AC)					95...370				24	0.7	16	> 55	/	/	-25...+70	82.5	750,000	II	   Cl. 1 Div.2 NEC Cl.2 (only 2580260000)	●	●	●								2580180000	
12		2.6	30	85	●			●	●																										2580220000			
24		1.3	30	86	●			●	●																											2580190000		
5		6	30	82	●			●	●																												2580210000	
12		5	60	86	●			●	●																												2580240000	
24		2.5	60	89	●			●	●																												2580230000	
24		3.8	90	87	●			●	●																												2580250000	
24		4	96	87	●			●	●																												2580260000	
48		2	96	89	●			●	●																												2580270000	

Note: Product overview for the maxGUARD product range in chapter B.

Series / family		Input side	Output side			Additional functions						Recommendation for application						Order No.						
Page	Description	DC input voltage [V]	Rated voltage [V]	configurable range [V]	Rated current [A]	Power rating [W]	Type of contact	Parallel connection option	Side-by-side connectivity	Temperature range [°C]	Efficiency [%]	MTBF time [Mh]	Surge category	Approvals	Field cabinets	Small and series machine construction	Machine construction and plant manufacture	Simple process applications	Process industry	Energy technology	Power distribution	Marine engineering		
USV	C.2	CP DC UPS 24V 20A/10A CP DC UPS 24V 40A	20-30	U _{in} -0.3 VU _{in} -0.3 V		10 / 20	240 / 480	NO / SSC	/	●	-25 ... +70	> 98	> 1	III		●	●	●	●				●	1370050010
						40	960									●	●	●	●	●	1370040010			
	C.2	PRO DC BUFFER 24V 20A PRO DC BUFFER 24V 40A	24	22	22 V / Vin-1 V DC	20	480	NO	Yes	●	-25 ... +70	> 98 buffer mode	2.5	III	 	●	●	●	●				●	2786240000
						40	960									●	●	●	●	●	2786250000			
	C.2	DURA ECO LA-BAT 24V 1.2AH DURA ECO LA-BAT 24V 3.4AH DURA ECO LA-BAT 24V 7AH DURA ECO LA-BAT 24V 12AH DURA ECO LA-BAT 24V 17AH	24	24		10 A / 7.8 min	1,2 Ah	/	≤ 2	●	Charge: -15 ... +50°C, Discharge: -20 ... +60°C			III	 	●	●	●	●				●	2789890000
						10 A / 11.3 min	3.4 Ah									●	●	●	●	●	2789900000			
						10 A / 26.5 min	7 Ah									●	●	●	●	●	2789910000			
						10 A / 51 min	12 Ah									●	●	●	●	●	2789920000			
						10 A / 81 min	17 Ah									●	●	●	●	●	2789930000			
DC/DC	D.2	PRO DCDC 120W 24V 5A PRO DCDC 240W 24V 10A PRO DCDC 480W 24V 20A	18...31.2	24	22.5...29.5	5	120	/	●		> 92	> 1	III	 	●	●	●	●				●	2001800000	
						10	240								NO	≤ 5	●	-25 ... +70	> 92	●	●	●	●	2001810000
						20	480								NO	●	> 93	●	●	●	●	●	2001820000	
DM / RM	E.2	PRO RM 10 PRO RM 20 PRO RM 40	10...32	U _{in} -0.13 VU _{in} -0.13 V	2 × 12 A (-40 °C ~ +45 °C), 2 × 10 A (+45 °C ~ +60 °C), 2 × 7.5 A (+70 °C)	480	NO	yes	●	-40 ... +70	> 98	0.005	III	 	●	●	●	●	●	●	●	●	2486090000	
				U _{in} -0.2 V	2 × 24 A (-40 °C ~ +45 °C), 2 × 20 A (+45 °C ~ +60 °C), 2 × 15 A (+70 °C)	960									●	●	●	●	●	●	●	2486100000		
				U _{in} -0.27 V	3 × 48 A (-40 °C ~ +45 °C), 2 × 40 A (+45 °C ~ +60 °C), 2 × 30 A (+70 °C)	1920									●	●	●	●	●	●	●	2486110000		
	E.6	PRO DM 10 PRO DM 20	0...60	U _{in} -0.7 VU _{in} -0.7 V	2 × 12 A (-40 °C ~ +45 °C), 2 × 10 A (+45 °C ~ +60 °C), 2 × 7.5 A (+70 °C), 2 × 12 A (-40 °C ~ +45 °C), 2 × 10 A (+45 °C ~ +60 °C), 2 × 7.5 A (+70 °C)	480	/	yes	●	-40 ... +70	> 97	0.44	III	 	●	●	●	●	●	●	●	●	2486070000	
					2 × 24 A (-40 °C ~ +45 °C), 2 × 20 A (+45 °C ~ +60 °C), 2 × 15 A (+70 °C), 2 × 24 A (-40 °C ~ +45 °C), 2 × 20 A (+45 °C ~ +60 °C), 2 × 15 A (+70 °C)	960									●	●	●	●	●	●	●	●	2486080000	

Switched-mode power supply units

Switched-mode power supply units	Overview	A.2
	connectPower PROtop	A.4
	connect Power PROtop DCDC	A.26
	connect Power PROtop UW	A.34
	connectPower PROmax	A.42
	connectPower PROeco	A.54
	connectPower PRObas	A.66
	connectPower PRO-PM	A.76
	connectPower INSTA POWER	A.90

Optimum power supply for automation technology

The switch-mode power supplies feature a high efficiency, compact dimensions and minimal heat generation.

They are an excellent and reliable solution for providing power in all automation applications – safely providing 24 V DC voltage.

The different product series are optimised for the automation industry: they feature Ex approvals for the processing industry, a flat shape perfect for distribution tasks within buildings and provide decentralised control voltages.

All-purpose usage: with a wide range of AC/DC inputs, single-, double- or three-phase versions and a wide temperature range. Additional performance increases

are possible using simple parallel connection. Weidmüller switch-mode power supplies are reliable usable for all applications because of their high efficiency and their resistance to both short circuits and overloads.

Weidmüller offers a system of one- and three-phase switch-mode power supplies especially for the PROtop family. These can be expanded with additional modules to create whole system solutions. The optimal fitting system can be assembled for any type of application: with redundancy circuits containing decoupled outputs, monitoring of the output voltage or triggering of circuit breakers.



AC/DC**International use**

A wide-range input (both DC as well as AC voltages can be used; no switching required) and extensive approvals (UL/CSA and GL (EMC 1 – bridge)).

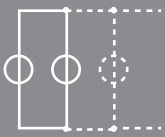
**Parallel connection**

Module power can be increased by connecting up to five power supplies in parallel without diode module.

**Narrow**

Space-saving configuration in the switching cabinet through very narrow housing construction and side-by-side connectability.

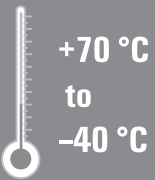
**Robust**

Wide temperature range from -40 °C ... +70 °C.

**Wide choice**

The right power supply for every application: 1-phase 3 A, 5 A, 7.5 A, 10 A, 20 A, 40 A and 3-phase 5 A, 10 A, 20 A, 40 A.

connectPower**connectPower PROtop****connectPower PROtop DCDC****connectPower PROtop UW****connectPower PROmax****connectPower PROeco****connectPower PRObas****connectPower PRO-PM****connectPower INSTA POWER**

High-end-power supplies and future proofed PROtop: Reliable, powerful, efficient and communication-capable

Production processes constantly need to be made more efficient. As well as performance, energy efficiency and sustainability are also playing an increasingly important role in cutting-edge industry. PROtop power supplies combine excellent performance data with exemplary sustainability, which has a positive impact on the productivity of the entire production facility.

PROtop offers a number of advantages that give you a real competitive edge. These include the permanent reduction of energy costs thanks to high efficiencies as well as the increase in plant availability due to long service life and high MTBF values. In addition, there is a high functional density due to the extremely space-saving designs.

PROtop can achieve significant savings compared to conventional power supply units. Its increased efficiency saves an average of 50 kWh per day in a medium-sized production facility with approx. 100 PROtop power supplies working in three-shift operation. This adds up to over 15,000 kWh a year and also improves the facility's carbon footprint. The service life, which is twice as long as that of standard power supplies, also sustainably reduces the costs of repurchase and exchange.

Also in the protection class IP65 available





Direct parallel switching without diode modules thanks to integrated ORing MOSFETs for reduced system costs



Sustainable and innovative device concept

- Optimum efficiency levels (up to 95.3%) for sustainable energy savings
- High MTBF values (> 1,000,000 h) for permanently high system availability

Communication modules can be adapted without tools.



Outstanding peak load reserves

- High dynamic range thanks to unique DCL (dynamic current limiting) technology
- Continuous peak load reserves from millisecond to second range
- Ideal for reliably triggering circuit breakers or for powerful motor starts



Highly future-proof

- Complete data transparency through to the cloud
- Remote controllability for integration into machine control systems
- CANopen and IO-Link communication protocols

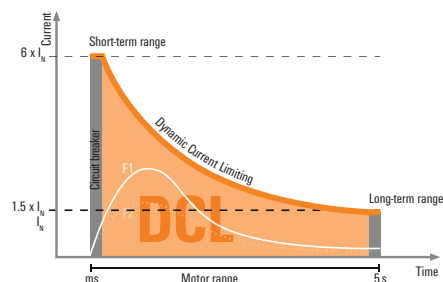

connectPower PROtop

connectPower PROtop

- DCL technology for an excellent dynamic range
- High energy efficiency (up to 95.4 % efficiency)
- Mode of operation: single or parallel operation and adjustable short-circuit response (continuous current or switch-off)
- Useful life of up to 10 years, MTBF > 1 000 000 h.
- Extremely slim design
- Time-saving PUSH IN connection technology



Derating curve

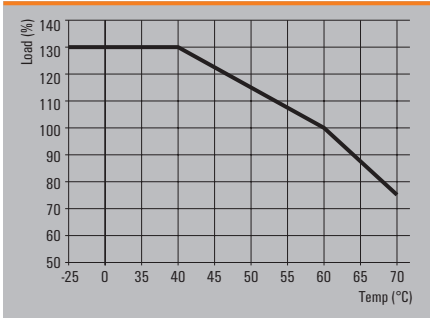

Technical data

General data	
Insulation voltage input / earth	3.2 kV
Insulation voltage output / earth	0.5 kV
Insulation voltage, input/output	3.5 kV
Earth leakage current, max.	3.5 mA
Series switching capability	Yes
Ambient temperature (operational) / Storage temperature	-25 °C...70 °C / -40 °C...85 °C
Humidity at operating temperature	5...95 %, no condensation
Protection class / Pollution degree	I, with PE connection / 2
Housing version	Metal, corrosion resistant
Mounting position, installation notice	Horizontal on DIN rail TS 35, top and bottom 50 mm clearance for free air flow, 10 mm clearance to neighbouring active subassemblies with full load, 5 mm with passive neighbouring subassemblies, direct row mounting with 90% rated load
Conformal coating	No
EMC / shock / vibration	
Interference immunity test acc. to	EN 55032:2015, EN 55024:2010/A1:2015, EN 55035:2017, EN 61000-3-2:2014, EN 61000-6-1:2007, EN 61000-6-2:2005, EN 61000-6-3:2007/A1:2011, EN 61000-6-4:2007/A1:2011
Shock	30 g in all directions
Resistance to vibration	2.3 g (on DIN rail), 4 g (with direct mounting)
Electrical safety (applied standards)	
Electrical machine equipment	Acc. to EN60204
Safety transformers for switch-mode power supplies	According to EN 61558-2-16
For use with electronic equipment	Acc. to EN50178 / VDE0160
Safety extra-low voltage	SELV acc. to IEC 60950-1, PELV according to EN 60204-1
Protective separation / protection against electrical shock	VDE0100-410 / acc. to DIN57100-410
Protection against dangerous shock currents	Acc. to VDE0106-101

connectPower PROtop

- 1-phase power supplies

PRO TOP1 72 W 24 V 3 A



Similar to illustration

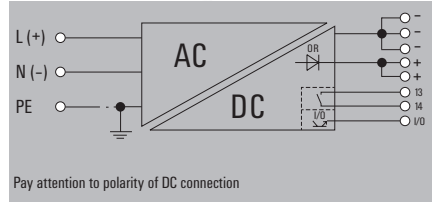

PRO TOP1 120 W 24 V 5 A



Similar to illustration

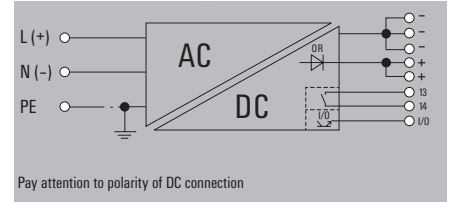

Technical data

Input	
Rated input voltage	110...240 V AC / 120...340 V DC
Input voltage range AC	85...277 V AC
Frequency range AC	45...65 Hz
DC input voltage range	80 ... 410 V DC
Input fuse (internal) / Inrush current	Yes / max. 5 A
Output	
Rated output voltage	24 V DC ± 1 %
Output voltage	22.5...28.8 V adjustable with potentiometer or communication module
DCL - peak load reserve	150 % (5 s); 400 % (15 ms)
Residual ripple, breaking spikes	< 50 mVss @ U _{Nom} , Full Load
Reserve capacity @ U _{Nominal}	130% permanent at ≤ 40°C, 150 % (5 s)
Nominal output current for U _{Nom}	3 A @ 60 °C
MTBF	
According to Standard	SN 29500
Operating time (hours), min.	2.3Mh
Ambient temperature	25°C
Input voltage	230V
Output power	72W
Duty cycle	100%
General data	
Derating	> 60°C (2.5% / 1°C)
Series switching capability	Yes
Degree of efficiency	89%
Power factor (approx.)	> 0.5
AC failure bridging time @ I _{Nom}	> 20 ms @ 230 V AC / > 20 ms @ 115 V AC
LED green/red	Green: Operation (failure-free), Flashing green: advance warning >90%, Green/red flashing: output switched off (switch-off mode), Flashing red: overload/error
Parallel connection option	yes, max 10
Depth x width x height	125 / 35 / 130 mm
Net weight	650 g
Approvals	
Approvals	ABS; BURVER; cULus; cULusEX; DETNORVER; EAC; LLOYDSREG; RINA; RS; TUEV
Connection data	
Connection system	PUSH IN with actuator
Number of terminals	3 for L/N/PE
Wire cross-section, rigid min/max	0.5 / 1.5 mm ²
Wire cross-section, flexible min/max	0.5 / 2.5 mm ²
Wire cross-section, AWG/kcmil min/max	20 / 12
Note	

Ordering data

Type	Qty.	Order No.
PRO TOP1 72W 24V 3A	1	2466850000

Current technical data at catalog.weidmueller.com

Input	
Rated input voltage	110...240 V AC / 120...340 V DC
Input voltage range AC	85...277 V AC
Frequency range AC	45...65 Hz
DC input voltage range	80 ... 410 V DC
Input fuse (internal) / Inrush current	Yes / max. 5 A
Output	
Rated output voltage	24 V DC ± 1 %
Output voltage	22.5...28.8 V adjustable with potentiometer or communication module
DCL - peak load reserve	150 % (5 s); 600 % (15 ms)
Residual ripple, breaking spikes	< 50 mVss @ U _{Nom} , Full Load
Reserve capacity @ U _{Nominal}	130% permanent at ≤ 40°C, 150 % (5 s)
Nominal output current for U _{Nom}	5 A @ 60 °C
MTBF	
According to Standard	SN 29500
Operating time (hours), min.	1.9Mh
Ambient temperature	25°C
Input voltage	230V
Output power	120W
Duty cycle	100%
General data	
Derating	> 60°C (2.5% / 1°C)
Series switching capability	Yes
Degree of efficiency	91%
Power factor (approx.)	> 0.85
AC failure bridging time @ I _{Nom}	> 20 ms @ 230 V AC / > 20 ms @ 115 V AC
LED green/red	Green: Operation (failure-free), Flashing green: advance warning >90%, Green/red flashing: output switched off (switch-off mode), Flashing red: overload/error
Parallel connection option	yes, max 10
Depth x width x height	125 / 35 / 130 mm
Net weight	850 g
Approvals	
Approvals	ABS; BURVER; cULus; cULusEX; DETNORVER; EAC; LLOYDSREG; RINA; RS; TUEV
Connection data	
Connection system	PUSH IN with actuator
Number of terminals	3 for L/N/PE
Wire cross-section, rigid min/max	0.5 / 1.5 mm ²
Wire cross-section, flexible min/max	0.5 / 2.5 mm ²
Wire cross-section, AWG/kcmil min/max	20 / 12
Note	

Type	Qty.	Order No.
PRO TOP1 120W 24V 5A	1	2466870000

Current technical data at catalog.weidmueller.com

connectPower PROtop

connectPower PROtop

- 1-phase power supplies

PRO TOP1 240 W 24 V 10 A

PRO TOP1 480 W 24 V 20 A



Similar to illustration



Similar to illustration

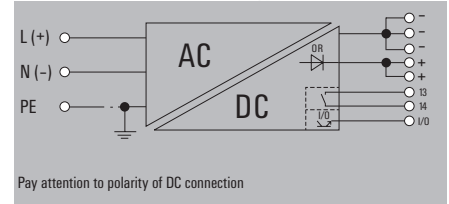
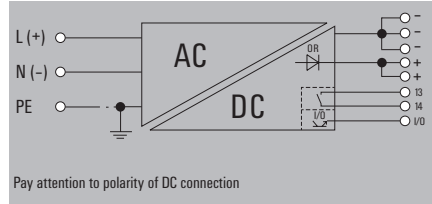

Technical data

Input	
Rated input voltage	110...240 V AC / 120...340 V DC
Input voltage range AC	85...277 V AC
Frequency range AC	45...65 Hz
DC input voltage range	80 ... 410 V DC
Input fuse (internal) / Inrush current	Yes / max. 5 A
Output	
Rated output voltage	24 V DC ± 1 %
Output voltage	22.5...28.8 V adjustable with potentiometer or communication module
DCL - peak load reserve	150 % (5 s); 600 % (15 ms)
Residual ripple, breaking spikes	< 50 mVss @ U _{Nom} , Full Load
Reserve capacity @ U _{Nominal}	130% permanent at ≤ 40°C, 150 % (5 s)
Nominal output current for U _{Nom}	10 A @ 60 °C
MTBF	
According to Standard	SN 29500
Operating time (hours), min.	1.6Mh
Ambient temperature	25°C
Input voltage	230V
Output power	240W
Duty cycle	100%
General data	
Derating	> 60°C (2.5% / 1°C)
Series switching capability	Yes
Degree of efficiency	92 %
Power factor (approx.)	> 0.9
AC failure bridging time @ I _{Nom}	> 20 ms @ 230 V AC / > 20 ms @ 115 V AC
LED green/red	Green: Operation (failure-free), Flashing green: advance warning >90%, Green/red flashing: output switched off (switch-off mode), Flashing red: overload/error
Parallel connection option	yes, max 10
Depth x width x height	125 / 39 / 130 mm
Net weight	1050 g
Approvals	
Approvals	ABS; BURVER; cULus; cULusEX; DETNORVER; EAC; LLOYDSREG; RINA; RS; TUEV
Connection data	
Connection system	PUSH IN with actuator
Number of terminals	3 for L/N/PE
Wire cross-section, rigid min/max	0.5 / 1.5 mm ²
Wire cross-section, flexible min/max	0.5 / 2.5 mm ²
Wire cross-section, AWG/kcmil min/max	20 / 12
Note	

Rated input voltage	110...240 V AC / 120...340 V DC
Input voltage range AC	85...277 V AC
Frequency range AC	45...65 Hz
DC input voltage range	80 ... 410 V DC
Input fuse (internal) / Inrush current	Yes / max. 5 A
Rated output voltage	24 V DC ± 1 %
Output voltage	22.5...28.8 V adjustable with potentiometer or communication module
DCL - peak load reserve	150 % (5 s); 600 % (15 ms)
Residual ripple, breaking spikes	< 50 mVss @ U _{Nom} , Full Load
Reserve capacity @ U _{Nominal}	130% permanent at ≤ 40°C, 150 % (5 s)
Nominal output current for U _{Nom}	10 A @ 60 °C
According to Standard	SN 29500
Operating time (hours), min.	1.6Mh
Ambient temperature	25°C
Input voltage	230V
Output power	240W
Duty cycle	100%
Derating	> 60°C (2.5% / 1°C)
Series switching capability	Yes
Degree of efficiency	92 %
Power factor (approx.)	> 0.9
AC failure bridging time @ I _{Nom}	> 20 ms @ 230 V AC / > 20 ms @ 115 V AC
LED green/red	Green: Operation (failure-free), Flashing green: advance warning >90%, Green/red flashing: output switched off (switch-off mode), Flashing red: overload/error
Parallel connection option	yes, max 10
Depth x width x height	125 / 39 / 130 mm
Net weight	1050 g
Approvals	
Approvals	ABS; BURVER; cULus; cULusEX; DETNORVER; EAC; LLOYDSREG; RINA; RS; TUEV
Connection data	
Connection system	PUSH IN with actuator
Number of terminals	3 for L/N/PE
Wire cross-section, rigid min/max	0.5 / 1.5 mm ²
Wire cross-section, flexible min/max	0.5 / 2.5 mm ²
Wire cross-section, AWG/kcmil min/max	20 / 12
Note	

Rated input voltage	110...240 V AC / 120...340 V DC
Input voltage range AC	85...277 V AC
Frequency range AC	45...65 Hz
DC input voltage range	80 ... 410 V DC
Input fuse (internal) / Inrush current	Yes / max. 5 A
Rated output voltage	24 V DC ± 1 %
Output voltage	22.5...28.8 V adjustable with potentiometer or communication module
DCL - peak load reserve	150 % (5 s); 500 % (15 ms)
Residual ripple, breaking spikes	< 50 mVss @ U _{Nom} , Full Load
Reserve capacity @ U _{Nominal}	130% permanent at ≤ 40°C, 150 % (5 s)
Nominal output current for U _{Nom}	20 A @ 60 °C
According to Standard	SN 29500
Operating time (hours), min.	1.2Mh
Ambient temperature	25°C
Input voltage	230V
Output power	480W
Duty cycle	100%
Derating	> 60°C (2.5% / 1°C)
Series switching capability	Yes
Degree of efficiency	93%
Power factor (approx.)	> 0.9
AC failure bridging time @ I _{Nom}	> 20 ms @ 230 V AC / > 20 ms @ 115 V AC
LED green/red	Green: Operation (failure-free), Flashing green: advance warning >90%, Green/red flashing: output switched off (switch-off mode), Flashing red: overload/error
Parallel connection option	yes, max 10
Depth x width x height	125 / 68 / 130 mm
Net weight	1520 g
Approvals	
Approvals	ABS; BURVER; cULus; cULusEX; DETNORVER; EAC; LLOYDSREG; RINA; RS; TUEV
Connection data	
Connection system	PUSH IN
Number of terminals	3 for L/N/PE
Wire cross-section, rigid min/max	0.2 / 10
Wire cross-section, flexible min/max	0.2 / 6
Wire cross-section, AWG/kcmil min/max	20 / 8
Note	

Ordering data

Type	Qty.	Order No.
PRO TOP1 240W 24V 10A	1	2466880000

Type	Qty.	Order No.
PRO TOP1 240W 24V 10A	1	2466880000

Type	Qty.	Order No.
PRO TOP1 480W 24V 20A	1	2466890000

Note

Current technical data at catalog.weidmueller.com

Current technical data at catalog.weidmueller.com

connectPower PROtop

- 1-phase power supplies

PRO TOP1 960 W 24 V 40 A



Similar to illustration

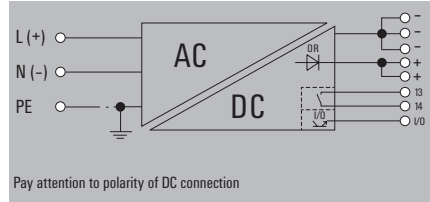

PRO TOP1 120 W 12 V 10 A



Similar to illustration

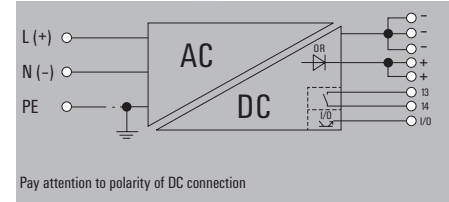

Technical data

Input	
Rated input voltage	110...240 V AC / 120...340 V DC
Input voltage range AC	85...277 V AC
Frequency range AC	45...65 Hz
DC input voltage range	80 ... 410 V DC
Input fuse (internal) / Inrush current	Yes / max. 15 A
Output	
Rated output voltage	24 V DC ± 1 %
Output voltage	22.5...28.8 V adjustable with potentiometer or communication module
DCL - peak load reserve	150 % (5 s); 400 % (15 ms)
Residual ripple, breaking spikes	< 50 mVss @ U _{Nom} , Full Load
Reserve capacity @ U _{Nominal}	130% permanent at ≤ 40°C, 150 % (5 s)
Nominal output current for U _{nom}	40 A @ 60 °C
MTBF	
According to Standard	SN 29500
Operating time (hours), min.	1Mh
Ambient temperature	25°C
Input voltage	230V
Output power	960W
Duty cycle	100%
General data	
Derating	> 60°C (2.5% / 1°C)
Series switching capability	Yes
Degree of efficiency	94%
Power factor (approx.)	> 0.9
AC failure bridging time @ I _{nom}	> 20 ms @ 230 V AC / > 20 ms @ 115 V AC
LED green/red	Green: Operation (failure-free), Flashing green: advance warning I>90%, Green/red flashing: output switched off (switch-off mode), Flashing red: overload/error
Parallel connection option	yes, max 10
Depth x width x height	125 / 124 / 130 mm
Net weight	3245 g
Approvals	
Approvals	ABS; BURVER; cULus; cULusEX; DETNORVER; EAC; LLOYDSREG; RINA; RS; TUEV
Connection data	
Connection system	PUSH IN
Number of terminals	3 for L/N/PE
Wire cross-section, rigid min/max	0.75 / 16 mm ²
Wire cross-section, flexible min/max	0.75 / 16 mm ²
Wire cross-section, AWG/kcmil min/max	20 / 4
Note	

Ordering data

Type	Qty.	Order No.
PRO TOP1 960W 24V 40A	1	2466900000

Note

Type	Qty.	Order No.
PRO TOP1 960W 24V 40A	1	2466900000

Current technical data at catalog.weidmueller.com

Type	Qty.	Order No.
PRO TOP1 120W 12V 10A	1	2466910000

Current technical data at catalog.weidmueller.com

connectPower PROtop

connectPower PROtop

- 1-phase power supplies

PRO TOP1 480 W 48 V 10 A

PRO TOP1 960 W 48 V 20 A



Similar to illustration



Similar to illustration

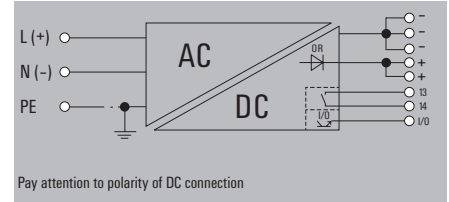
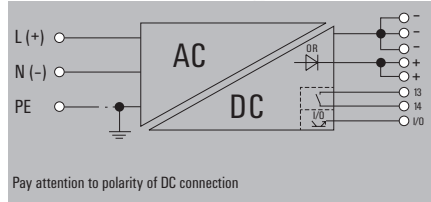

Technical data

Input	
Rated input voltage	110...240 V AC / 120...340 V DC
Input voltage range AC	85...277 V AC
Frequency range AC	45...65 Hz
DC input voltage range	80 ... 410 V DC
Input fuse (internal) / Inrush current	Yes / max. 5 A
Output	
Rated output voltage	48 V DC ± 1 %
Output voltage	45...56 V adjustable with potentiometer or communication module
DCL - peak load reserve	150 % (5 s); 500 % (15 ms)
Residual ripple, breaking spikes	< 100 mV _{pp}
Reserve capacity @ U _{Nominal}	130% permanent at ≤ 40°C, 150 % (5 s)
Nominal output current for U _{nom}	10 A @ 60 °C
MTBF	
According to Standard	SN 29500
Operating time (hours), min.	1.1Mh
Ambient temperature	25°C
Input voltage	230V
Output power	480W
Duty cycle	100%
General data	
Derating	> 60°C (2.5% / 1°C)
Series switching capability	No
Degree of efficiency	93%
Power factor (approx.)	> 0.9
AC failure bridging time @ I _{nom}	> 20 ms @ 230 V AC / > 20 ms @ 115 V AC
LED green/red	Green: Operation (failure-free), Flashing green: advance warning I>90%, Green/red flashing: output switched off (switch-off mode), Flashing red: overload/error
Parallel connection option	yes, max 10
Depth x width x height	125 / 68 / 130 mm
Net weight	1520 g
Approvals	
Approvals	ABS; BURVER; cULus; cULusEX; DETNORVER; EAC; LLOYDSREG; RINA; RS; TUEV
Connection data	
Connection system	PUSH IN
Number of terminals	3 for L/N/PE
Wire cross-section, rigid min/max	0.2 / 10 mm ²
Wire cross-section, flexible min/max	0.2 / 6 mm ²
Wire cross-section, AWG/kcmil min/max	20 / 8
Note	

Input	
Rated input voltage	110...240 V AC / 120...340 V DC
Input voltage range AC	85...277 V AC
Frequency range AC	45...65 Hz
DC input voltage range	80 ... 410 V DC
Input fuse (internal) / Inrush current	Yes / max. 5 A
Output	
Rated output voltage	48 V DC ± 1 %
Output voltage	45...56 V adjustable with potentiometer or communication module
DCL - peak load reserve	150 % (5 s); 500 % (15 ms)
Residual ripple, breaking spikes	< 100 mV _{pp}
Reserve capacity @ U _{Nominal}	130% permanent at ≤ 40°C, 150 % (5 s)
Nominal output current for U _{nom}	10 A @ 60 °C
MTBF	
According to Standard	SN 29500
Operating time (hours), min.	1.1Mh
Ambient temperature	25°C
Input voltage	230V
Output power	480W
Duty cycle	100%
General data	
Derating	> 60°C (2.5% / 1°C)
Series switching capability	No
Degree of efficiency	93%
Power factor (approx.)	> 0.9
AC failure bridging time @ I _{nom}	> 20 ms @ 230 V AC / > 20 ms @ 115 V AC
LED green/red	Green: Operation (failure-free), Flashing green: advance warning I>90%, Green/red flashing: output switched off (switch-off mode), Flashing red: overload/error
Parallel connection option	yes, max 10
Depth x width x height	125 / 68 / 130 mm
Net weight	1520 g
Approvals	
Approvals	ABS; BURVER; cULus; cULusEX; DETNORVER; EAC; LLOYDSREG; RINA; RS; TUEV
Connection data	
Connection system	PUSH IN
Number of terminals	3 for L/N/PE
Wire cross-section, rigid min/max	0.2 / 10 mm ²
Wire cross-section, flexible min/max	0.2 / 6 mm ²
Wire cross-section, AWG/kcmil min/max	20 / 8
Note	

Input	
Rated input voltage	110...240 V AC / 120...340 V DC
Input voltage range AC	85...277 V AC
Frequency range AC	45...65 Hz
DC input voltage range	80 ... 410 V DC
Input fuse (internal) / Inrush current	Yes / max. 15 A
Output	
Rated output voltage	48 V DC ± 1 %
Output voltage	45...56 V adjustable with potentiometer or communication module
DCL - peak load reserve	150 % (5 s); 400 % (15 ms)
Residual ripple, breaking spikes	< 100 mV _{pp}
Reserve capacity @ U _{Nominal}	130% permanent at ≤ 40°C, 150 % (5 s)
Nominal output current for U _{nom}	20 A @ 60 °C
MTBF	
According to Standard	SN 29500
Operating time (hours), min.	1Mh
Ambient temperature	25°C
Input voltage	230V
Output power	960W
Duty cycle	100%
General data	
Derating	> 60°C (2.5% / 1°C)
Series switching capability	No
Degree of efficiency	94%
Power factor (approx.)	> 0.9
AC failure bridging time @ I _{nom}	> 20 ms @ 230 V AC / > 20 ms @ 115 V AC
LED green/red	Green: Operation (failure-free), Flashing green: advance warning I>90%, Green/red flashing: output switched off (switch-off mode), Flashing red: overload/error
Parallel connection option	yes, max 10
Depth x width x height	125 / 124 / 130 mm
Net weight	3215 g
Approvals	
Approvals	ABS; BURVER; cULus; cULusEX; DETNORVER; EAC; LLOYDSREG; RINA; RS; TUEV
Connection data	
Connection system	PUSH IN
Number of terminals	3 for L/N/PE
Wire cross-section, rigid min/max	0.75 / 16 mm ²
Wire cross-section, flexible min/max	0.75 / 16 mm ²
Wire cross-section, AWG/kcmil min/max	20 / 4
Note	

Ordering data

Type	Qty.	Order No.
PRO TOP1 480W 48V 10A	1	2467030000
Note		
Current technical data at catalog.weidmueller.com		

Type	Qty.	Order No.
PRO TOP1 960W 48V 20A	1	2466920000
Note		
Current technical data at catalog.weidmueller.com		

Type	Qty.	Order No.
PRO TOP1 960W 48V 20A	1	2466920000
Note		
Current technical data at catalog.weidmueller.com		

connectPower PROtop

- 1-phase power supplies with output-side screw flange

PRO TOP1 72W 24V 3A F

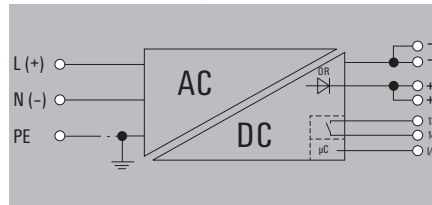

PRO TOP1 120W 12V 10A F

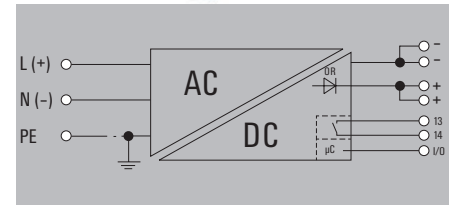

Technical data

Input	
Rated input voltage	110...240 V AC / 120...340 V DC
Input voltage range AC	85...277 V AC
Frequency range AC	45...65 Hz
DC input voltage range	80 ... 410 V DC
Input fuse (internal) / Inrush current	Yes / max. 5 A
Output	
Rated output voltage	24 V DC ± 1 %
Output voltage	22.5...28.8 V adjustable with potentiometer or communication module
DCL - peak load reserve	150 % (5 s); 400 % (15 ms)
Residual ripple, breaking spikes	< 50 mVss @ U _{Nom} , Full Load
Reserve capacity @ U _{Nominal}	130% permanent at ≤ 40°C, 150 % (5 s)
Nominal output current for U _{Nom}	3 A @ 60 °C
MTBF	
According to Standard	SN 29500
Operating time (hours), min.	2.3Mh
Ambient temperature	25°C
Input voltage	230V
Output power	72W
Duty cycle	100%
General data	
Derating	> 60°C (2.5% / 1°C)
Series switching capability	Yes
Degree of efficiency	89%
Power factor (approx.)	> 0.5
AC failure bridging time @ I _{nom}	> 20 ms @ 230 V AC / > 20 ms @ 115 V AC
LED green/red	Green: Operation (failure-free), Flashing green: advance warning I>90%, Green/red flashing: output switched off (switch-off mode), Flashing red: overload/error
Parallel connection option	yes, max 10
Depth x width x height	125 / 35 / 130 mm
Net weight	650 g
Approvals	
Approvals	ABS; BURVER; cULus; cULusEX; DETNORVER; EAC; LLOYDSREG; RINA; RS; TUEV
Connection data	
Connection system	PUSH IN with actuator
Number of terminals	3 for L/N/PE
Wire cross-section, rigid min/max	0.5 / 1.5 mm ²
Wire cross-section, flexible min/max	0.5 / 2.5 mm ²
Wire cross-section, AWG/kcmil min/max	20 / 12
Note	

Rated input voltage	110...240 V AC / 120...340 V DC
Input voltage range AC	85...277 V AC
Frequency range AC	45...65 Hz
DC input voltage range	80 ... 410 V DC
Input fuse (internal) / Inrush current	Yes / max. 5 A
Rated output voltage	24 V DC ± 1 %
Output voltage	22.5...28.8 V adjustable with potentiometer or communication module
DCL - peak load reserve	150 % (5 s); 400 % (15 ms)
Residual ripple, breaking spikes	< 50 mVss @ U _{Nom} , Full Load
Reserve capacity @ U _{Nominal}	130% permanent at ≤ 40°C, 150 % (5 s)
Nominal output current for U _{Nom}	3 A @ 60 °C
According to Standard	SN 29500
Operating time (hours), min.	2.3Mh
Ambient temperature	25°C
Input voltage	230V
Output power	72W
Duty cycle	100%
Derating	> 60°C (2.5% / 1°C)
Series switching capability	Yes
Degree of efficiency	89%
Power factor (approx.)	> 0.5
AC failure bridging time @ I _{nom}	> 20 ms @ 230 V AC / > 20 ms @ 115 V AC
LED green/red	Green: Operation (failure-free), Flashing green: advance warning I>90%, Green/red flashing: output switched off (switch-off mode), Flashing red: overload/error
Parallel connection option	yes, max 10
Depth x width x height	125 / 35 / 130 mm
Net weight	650 g
Approvals	ABS; BURVER; cULus; cULusEX; DETNORVER; EAC; LLOYDSREG; RINA; RS; TUEV
Connection system	PUSH IN with actuator
Number of terminals	3 for L/N/PE
Wire cross-section, rigid min/max	0.5 / 1.5 mm ²
Wire cross-section, flexible min/max	0.5 / 2.5 mm ²
Wire cross-section, AWG/kcmil min/max	20 / 12

Rated input voltage	110...240 V AC / 120...340 V DC
Input voltage range AC	85...277 V AC
Frequency range AC	45...65 Hz
DC input voltage range	80 ... 410 V DC
Input fuse (internal) / Inrush current	Yes / max. 5 A
Rated output voltage	12 V DC ± 1 %
Output voltage	11...15 V adjustable with potentiometer or communication module
DCL - peak load reserve	150 % (5 s); 400 % (15 ms)
Residual ripple, breaking spikes	< 50 mVss @ U _{Nom} , Full Load
Reserve capacity @ U _{Nominal}	130% permanent at ≤ 40°C, 150 % (5 s)
Nominal output current for U _{Nom}	10 A @ 60 °C
According to Standard	SN 29500
Operating time (hours), min.	1.5Mh
Ambient temperature	25°C
Input voltage	230V
Output power	120W
Duty cycle	100%
Derating	> 60°C (2.5% / 1°C)
Series switching capability	Yes
Degree of efficiency	90%
Power factor (approx.)	> 0.85
AC failure bridging time @ I _{nom}	> 20 ms @ 230 V AC / > 20 ms @ 115 V AC
LED green/red	Green: Operation (failure-free), Flashing green: advance warning I>90%, Green/red flashing: output switched off (switch-off mode), Flashing red: overload/error
Parallel connection option	yes, max 10
Depth x width x height	125 / 35 / 130 mm
Net weight	850 g
Approvals	ABS; BURVER; cULus; cULusEX; DETNORVER; EAC; LLOYDSREG; RINA; RS; TUEV
Connection system	PUSH IN with actuator
Number of terminals	3 for L/N/PE
Wire cross-section, rigid min/max	0.5 / 1.5 mm ²
Wire cross-section, flexible min/max	0.5 / 2.5 mm ²
Wire cross-section, AWG/kcmil min/max	20 / 12

Ordering data

Type	Qty.	Order No.
PRO TOP1 72W 24V 3A F	1	2568970000

Type	Qty.	Order No.
PRO TOP1 72W 24V 3A F	1	2568970000

Type	Qty.	Order No.
PRO TOP1 120W 12V 10A F	1	2569000000

Note

Current technical data at catalog.weidmueller.com

Current technical data at catalog.weidmueller.com

connectPower PROtop

connectPower PROtop

- 1-phase power supplies with output-side screw flange

PRO TOP1 120W 24V 5A F

PRO TOP1 240W 24V 10A F

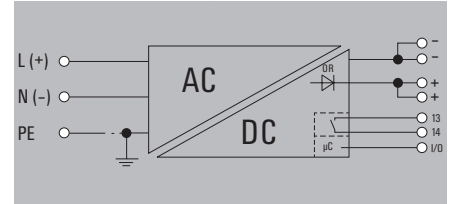
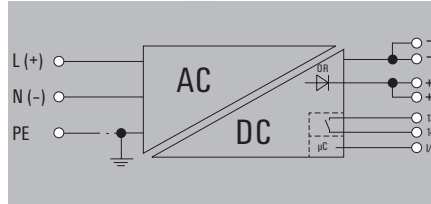

Technical data

Input	
Rated input voltage	110...240 V AC / 120...340 V DC
Input voltage range AC	85...277 V AC
Frequency range AC	45...65 Hz
DC input voltage range	48...410 V DC (Derating 40% @ 48 V DC)
Input fuse (internal) / Inrush current	Yes / max. 5 A
Output	
Rated output voltage	24 V DC ± 1 %
Output voltage	22.5...28.8 V adjustable with potentiometer or communication module
DCL - peak load reserve	150 % (5 s); 600 % (15 ms)
Residual ripple, breaking spikes	< 50 mVss @ U _{Nom} , Full Load
Reserve capacity @ U _{Nominal}	130% permanent at ≤ 40°C, 150 % (5 s)
Nominal output current for U _{Nom}	5 A @ 60 °C
MTBF	
According to Standard	SN 29500
Operating time (hours), min.	1.9Mh
Ambient temperature	25°C
Input voltage	230V
Output power	120W
Duty cycle	100%
General data	
Derating	> 60°C (2.5% / 1°C)
Series switching capability	Yes
Degree of efficiency	91%
Power factor (approx.)	> 0.85
AC failure bridging time @ I _{Nom}	> 20 ms @ 230 V AC / > 20 ms @ 115 V AC
LED green/red	Green: Operation (failure-free), Flashing green: advance warning >90%, Green/red flashing: output switched off (switch-off mode), Flashing red: overload/error
Parallel connection option	yes, max 10
Depth x width x height	125 / 35 / 130 mm
Net weight	850 g
Approvals	
Approvals	ABS; BURVER; cULus; cULusEX; DETNORVER; EAC; LLOYDSREG; RINA; RS; TUEV
Connection data	
Connection system	PUSH IN with actuator
Number of terminals	3 for L/N/PE
Wire cross-section, rigid min/max	0.5 / 1.5 mm ²
Wire cross-section, flexible min/max	0.5 / 2.5 mm ²
Wire cross-section, AWG/kcmil min/max	20 / 12
Note	

Rated input voltage	110...240 V AC / 120...340 V DC
Input voltage range AC	85...277 V AC
Frequency range AC	45...65 Hz
DC input voltage range	48...410 V DC (Derating 40% @ 48 V DC)
Input fuse (internal) / Inrush current	Yes / max. 5 A
Output	
Rated output voltage	24 V DC ± 1 %
Output voltage	22.5...28.8 V adjustable with potentiometer or communication module
DCL - peak load reserve	150 % (5 s); 600 % (15 ms)
Residual ripple, breaking spikes	< 50 mVss @ U _{Nom} , Full Load
Reserve capacity @ U _{Nominal}	130% permanent at ≤ 40°C, 150 % (5 s)
Nominal output current for U _{Nom}	5 A @ 60 °C
MTBF	
According to Standard	SN 29500
Operating time (hours), min.	1.9Mh
Ambient temperature	25°C
Input voltage	230V
Output power	120W
Duty cycle	100%
General data	
Derating	> 60°C (2.5% / 1°C)
Series switching capability	Yes
Degree of efficiency	91%
Power factor (approx.)	> 0.85
AC failure bridging time @ I _{Nom}	> 20 ms @ 230 V AC / > 20 ms @ 115 V AC
LED green/red	Green: Operation (failure-free), Flashing green: advance warning >90%, Green/red flashing: output switched off (switch-off mode), Flashing red: overload/error
Parallel connection option	yes, max 10
Depth x width x height	125 / 35 / 130 mm
Net weight	850 g
Approvals	
Approvals	ABS; BURVER; cULus; cULusEX; DETNORVER; EAC; LLOYDSREG; RINA; RS; TUEV
Connection data	
Connection system	PUSH IN with actuator
Number of terminals	3 for L/N/PE
Wire cross-section, rigid min/max	0.5 / 1.5 mm ²
Wire cross-section, flexible min/max	0.5 / 2.5 mm ²
Wire cross-section, AWG/kcmil min/max	20 / 12
Note	

Rated input voltage	110...240 V AC / 120...340 V DC
Input voltage range AC	85...277 V AC
Frequency range AC	45...65 Hz
DC input voltage range	80 ... 410 V DC
Input fuse (internal) / Inrush current	Yes / max. 5 A
Output	
Rated output voltage	24 V DC ± 1 %
Output voltage	22.5...28.8 V adjustable with potentiometer or communication module
DCL - peak load reserve	150 % (5 s); 600 % (15 ms)
Residual ripple, breaking spikes	< 50 mVss @ U _{Nom} , Full Load
Reserve capacity @ U _{Nominal}	130% permanent at ≤ 40°C, 150 % (5 s)
Nominal output current for U _{Nom}	10 A @ 60 °C
MTBF	
According to Standard	SN 29500
Operating time (hours), min.	1.6Mh
Ambient temperature	25°C
Input voltage	230V
Output power	240W
Duty cycle	100%
General data	
Derating	> 60°C (2.5% / 1°C)
Series switching capability	Yes
Degree of efficiency	92 %
Power factor (approx.)	> 0.9
AC failure bridging time @ I _{Nom}	> 20 ms @ 230 V AC / > 20 ms @ 115 V AC
LED green/red	Green: Operation (failure-free), Flashing green: advance warning >90%, Green/red flashing: output switched off (switch-off mode), Flashing red: overload/error
Parallel connection option	yes, max 10
Depth x width x height	125 / 39 / 130 mm
Net weight	1050 g
Approvals	
Approvals	ABS; BURVER; cULus; cULusEX; DETNORVER; EAC; LLOYDSREG; RINA; RS; TUEV
Connection data	
Connection system	PUSH IN with actuator
Number of terminals	3 for L/N/PE
Wire cross-section, rigid min/max	0.5 / 1.5 mm ²
Wire cross-section, flexible min/max	0.5 / 2.5 mm ²
Wire cross-section, AWG/kcmil min/max	20 / 12
Note	

Ordering data

Type	Qty.	Order No.
PRO TOP1 120W 24V 5A F	1	2568980000

Type	Qty.	Order No.
PRO TOP1 120W 24V 5A F	1	2568980000

Type	Qty.	Order No.
PRO TOP1 240W 24V 10A F	1	2568990000

Note

Current technical data at catalog.weidmueller.com

Current technical data at catalog.weidmueller.com

connectPower PROtop

- 3-phase power supplies

PRO TOP3 120 W 24 V 5 A

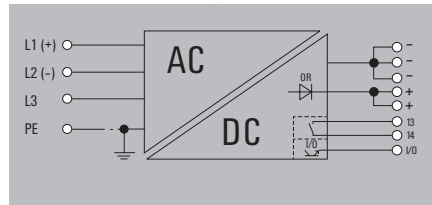

PRO TOP3 240 W 24 V 10 A

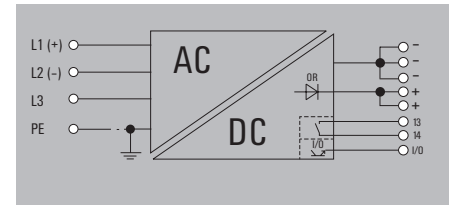

Technical data

Input	
Rated input voltage	3x 400...3x 500 V AC (wide-range input)
Input voltage range AC	3 x 320...3 x 575 V AC / 2 x 360...2 x 575 V AC
Frequency range AC	45...65 Hz
DC input voltage range	450...800 V DC (max. 500 V DC acc. to UL508)
Input fuse (internal) / Inrush current	No / Max. 10 A
Output	
Rated output voltage	24 V DC ± 1 %
Output voltage	22.5...28.8 V adjustable with potentiometer or communication module
DCL - peak load reserve	150 % (5 s); 600 % (15 ms)
Residual ripple, breaking spikes	< 50 mVss @ U _{Nom} , Full Load
Reserve capacity @ U _{Nominal}	130% permanent at ≤ 40°C, 150 % (5 s)
Nominal output current for U _{Nom}	5 A @ 60 °C
MTBF	
According to Standard	SN 29500
Operating time (hours), min.	2Mh
Ambient temperature	25°C
Input voltage	400V
Output power	120W
Duty cycle	100%
General data	
Derating	> 60°C (2.5% / 1°C)
Series switching capability	Yes
Degree of efficiency	89%
Power factor (approx.)	> 0.4 @ 3x400 V AC
AC failure bridging time @ I _{Nom}	> 20 ms @ 230 V AC / > 20 ms @ 115 V AC
LED green/red	Green: Operation (failure-free), Flashing green: advance warning >90%, Green/red flashing: output switched off (switch-off mode), Flashing red: overload/error
Parallel connection option	yes, max 10
Depth x width x height	125 / 39 / 130 mm
Net weight	967 g
Approvals	
Approvals	ABS; BURVER; cULus; cULusEX; DETNORVER; EAC; LLOYDSREG; RINA; RS; TUEV
Connection data	
Connection system	PUSH IN with actuator
Number of terminals	4 for L1/L2/L3/PE
Wire cross-section, rigid min/max	0.5 / 1.5 mm ²
Wire cross-section, flexible min/max	0.5 / 2.5 mm ²
Wire cross-section, AWG/kcmil min/max	20 / 12
Note	

Rated input voltage	3x 400...3x 500 V AC (wide-range input)
Input voltage range AC	3 x 320...3 x 575 V AC / 2 x 360...2 x 575 V AC
Frequency range AC	45...65 Hz
DC input voltage range	450...800 V DC (max. 500 V DC acc. to UL508)
Input fuse (internal) / Inrush current	No / Max. 10 A
Rated output voltage	24 V DC ± 1 %
Output voltage	22.5...28.8 V adjustable with potentiometer or communication module
DCL - peak load reserve	150 % (5 s); 600 % (15 ms)
Residual ripple, breaking spikes	< 50 mVss @ U _{Nom} , Full Load
Reserve capacity @ U _{Nominal}	130% permanent at ≤ 40°C, 150 % (5 s)
Nominal output current for U _{Nom}	5 A @ 60 °C
According to Standard	SN 29500
Operating time (hours), min.	2Mh
Ambient temperature	25°C
Input voltage	400V
Output power	120W
Duty cycle	100%
Derating	> 60°C (2.5% / 1°C)
Series switching capability	Yes
Degree of efficiency	89%
Power factor (approx.)	> 0.4 @ 3x400 V AC
AC failure bridging time @ I _{Nom}	> 20 ms @ 230 V AC / > 20 ms @ 115 V AC
LED green/red	Green: Operation (failure-free), Flashing green: advance warning >90%, Green/red flashing: output switched off (switch-off mode), Flashing red: overload/error
Parallel connection option	yes, max 10
Depth x width x height	125 / 39 / 130 mm
Net weight	967 g
Approvals	ABS; BURVER; cULus; cULusEX; DETNORVER; EAC; LLOYDSREG; RINA; RS; TUEV
Connection system	PUSH IN with actuator
Number of terminals	4 for L1/L2/L3/PE
Wire cross-section, rigid min/max	0.5 / 1.5 mm ²
Wire cross-section, flexible min/max	0.5 / 2.5 mm ²
Wire cross-section, AWG/kcmil min/max	20 / 12

Rated input voltage	3x 400...3x 500 V AC (wide-range input)
Input voltage range AC	3 x 320...3 x 575 V AC / 2 x 360...2 x 575 V AC
Frequency range AC	45...65 Hz
DC input voltage range	450...800 V DC (max. 500 V DC acc. to UL508)
Input fuse (internal) / Inrush current	No / Max. 10 A
Rated output voltage	24 V DC ± 1 %
Output voltage	22.5...28.8 V adjustable with potentiometer or communication module
DCL - peak load reserve	150 % (5 s); 600 % (15 ms)
Residual ripple, breaking spikes	< 50 mVss @ U _{Nom} , Full Load
Reserve capacity @ U _{Nominal}	130% permanent at ≤ 40°C, 150 % (5 s)
Nominal output current for U _{Nom}	10 A @ 60 °C
According to Standard	SN 29500
Operating time (hours), min.	1.4Mh
Ambient temperature	25°C
Input voltage	400V
Output power	240W
Duty cycle	100%
Derating	> 60°C (2.5% / 1°C)
Series switching capability	Yes
Degree of efficiency	93%
Power factor (approx.)	> 0.75 @ 3x400 V AC
AC failure bridging time @ I _{Nom}	> 20 ms @ 230 V AC / > 20 ms @ 115 V AC
LED green/red	Green: Operation (failure-free), Flashing green: advance warning >90%, Green/red flashing: output switched off (switch-off mode), Flashing red: overload/error
Parallel connection option	yes, max 10
Depth x width x height	125 / 50 / 130 mm
Net weight	1120 g
Approvals	ABS; BURVER; cULus; cULusEX; DETNORVER; EAC; LLOYDSREG; RINA; RS; TUEV
Connection system	PUSH IN with actuator
Number of terminals	4 for L1/L2/L3/PE
Wire cross-section, rigid min/max	0.5 / 1.5 mm ²
Wire cross-section, flexible min/max	0.5 / 2.5 mm ²
Wire cross-section, AWG/kcmil min/max	20 / 12

Ordering data

Type	Qty.	Order No.
PRO TOP3 120W 24V 5A	1	2467060000

Type	Qty.	Order No.
PRO TOP3 240W 24V 10A	1	2467080000

Type	Qty.	Order No.
PRO TOP3 240W 24V 10A	1	2467080000

Note

Current technical data at catalog.weidmueller.com

Current technical data at catalog.weidmueller.com

connectPower PROtop

connectPower PROtop

- 3-phase power supplies

PRO TOP3 480 W 24 V 20 A

PRO TOP3 960 W 24 V 40 A

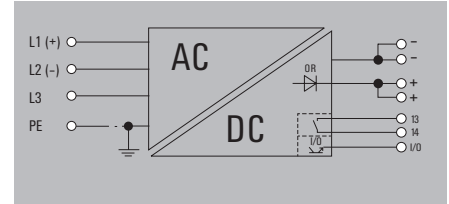
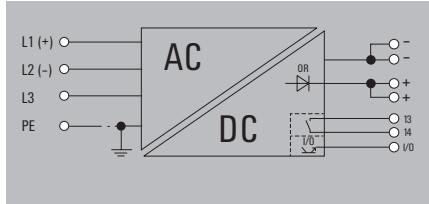

Technical data

Input	
Rated input voltage	3x 400...3x 500 V AC (wide-range input)
Input voltage range AC	3 x 320...3 x 575 V AC / 2 x 360...2 x 575 V AC
Frequency range AC	45...65 Hz
DC input voltage range	450...800 V DC (max. 500 V DC acc. to UL508)
Input fuse (internal) / Inrush current	No / Max. 10 A
Output	
Rated output voltage	24 V DC ± 1 %
Output voltage	22.5...28.8 V adjustable with potentiometer or communication module
DCL - peak load reserve	150 % (5 s); 500 % (15 ms)
Residual ripple, breaking spikes	< 50 mVss @ U _{Nom} , Full Load
Reserve capacity @ U _{Nominal}	130% permanent at ≤ 40°C, 150 % (5 s)
Nominal output current for U _{Nom}	20 A @ 60 °C
MTBF	
According to Standard	SN 29500
Operating time (hours), min.	1Mh
Ambient temperature	25°C
Input voltage	400V
Output power	480W
Duty cycle	100%
General data	
Derating	> 60°C (2.5% / 1°C)
Series switching capability	Yes
Degree of efficiency	94%
Power factor (approx.)	> 0.75 @ 3x400 V AC
AC failure bridging time @ I _{Nom}	> 20 ms @ 230 V AC / > 20 ms @ 115 V AC
LED green/red	Green: Operation (failure-free), Flashing green: advance warning I>90%, Green/red flashing: output switched off (switch-off mode), Flashing red: overload/error
Parallel connection option	yes, max 10
Depth x width x height	125 / 68 / 130 mm
Net weight	1650 g
Approvals	
Approvals	ABS; BURVER; cULus; cULusEX; DETNORVER; EAC; LLOYDSREG; RINA; RS; TUEV
Connection data	
Connection system	PUSH IN
Number of terminals	4 for L1/L2/L3/PE
Wire cross-section, rigid min/max	0.2 / 10 mm ²
Wire cross-section, flexible min/max	0.2 / 6 mm ²
Wire cross-section, AWG/kcmil min/max	20 / 8
Note	

Input	
Rated input voltage	3x 400...3x 500 V AC (wide-range input)
Input voltage range AC	3 x 320...3 x 575 V AC / 2 x 360...2 x 575 V AC
Frequency range AC	45...65 Hz
DC input voltage range	450...800 V DC (max. 500 V DC acc. to UL508)
Input fuse (internal) / Inrush current	No / Max. 10 A
Output	
Rated output voltage	24 V DC ± 1 %
Output voltage	22.5...28.8 V adjustable with potentiometer or communication module
DCL - peak load reserve	150 % (5 s); 400 % (15 ms)
Residual ripple, breaking spikes	< 50 mVss @ U _{Nom} , Full Load
Reserve capacity @ U _{Nominal}	130% permanent at ≤ 40°C, 150 % (5 s)
Nominal output current for U _{Nom}	40 A @ 60 °C
MTBF	
According to Standard	SN 29500
Operating time (hours), min.	1Mh
Ambient temperature	25°C
Input voltage	400V
Output power	960W
Duty cycle	100%
General data	
Derating	> 60°C (2.5% / 1°C)
Series switching capability	Yes
Degree of efficiency	95,3 %
Power factor (approx.)	> 0.75 @ 3x400 V AC
AC failure bridging time @ I _{Nom}	> 20 ms @ 230 V AC / > 20 ms @ 115 V AC
LED green/red	Green: Operation (failure-free), Flashing green: advance warning I>90%, Green/red flashing: output switched off (switch-off mode), Flashing red: overload/error
Parallel connection option	yes, max 10
Depth x width x height	175 / 89 / 130 mm
Net weight	2490 g
Approvals	
Approvals	ABS; BURVER; cULus; cULusEX; DETNORVER; EAC; LLOYDSREG; RINA; RS; TUEV
Connection data	
Connection system	PUSH IN
Number of terminals	4 (++ / -)
Wire cross-section, rigid min/max	0.2 / 10
Wire cross-section, flexible min/max	0.2 / 6
Wire cross-section, AWG/kcmil min/max	20 / 8
Note	

Input	
Rated input voltage	3x 400...3x 500 V AC (wide-range input)
Input voltage range AC	3 x 320...3 x 575 V AC / 2 x 360...2 x 575 V AC
Frequency range AC	45...65 Hz
DC input voltage range	450...800 V DC (max. 500 V DC acc. to UL508)
Input fuse (internal) / Inrush current	No / Max. 10 A
Output	
Rated output voltage	24 V DC ± 1 %
Output voltage	22.5...28.8 V adjustable with potentiometer or communication module
DCL - peak load reserve	150 % (5 s); 400 % (15 ms)
Residual ripple, breaking spikes	< 50 mVss @ U _{Nom} , Full Load
Reserve capacity @ U _{Nominal}	130% permanent at ≤ 40°C, 150 % (5 s)
Nominal output current for U _{Nom}	40 A @ 60 °C
MTBF	
According to Standard	SN 29500
Operating time (hours), min.	1Mh
Ambient temperature	25°C
Input voltage	400V
Output power	960W
Duty cycle	100%
General data	
Derating	> 60°C (2.5% / 1°C)
Series switching capability	Yes
Degree of efficiency	95,3 %
Power factor (approx.)	> 0.75 @ 3x400 V AC
AC failure bridging time @ I _{Nom}	> 20 ms @ 230 V AC / > 20 ms @ 115 V AC
LED green/red	Green: Operation (failure-free), Flashing green: advance warning I>90%, Green/red flashing: output switched off (switch-off mode), Flashing red: overload/error
Parallel connection option	yes, max 10
Depth x width x height	175 / 89 / 130 mm
Net weight	2490 g
Approvals	
Approvals	ABS; BURVER; cULus; cULusEX; DETNORVER; EAC; LLOYDSREG; RINA; RS; TUEV
Connection data	
Connection system	PUSH IN
Number of terminals	4 (++ / -)
Wire cross-section, rigid min/max	0.75 / 16
Wire cross-section, flexible min/max	0.75 / 16
Wire cross-section, AWG/kcmil min/max	20 / 4
Note	

Ordering data

Type	Qty.	Order No.
PRO TOP3 480W 24V 20A	1	2467100000
Note		
Current technical data at catalog.weidmueller.com		

Type	Qty.	Order No.
PRO TOP3 960W 24V 40A	1	2467120000
Note		
Current technical data at catalog.weidmueller.com		

Type	Qty.	Order No.
PRO TOP3 960W 24V 40A	1	2467120000
Note		
Current technical data at catalog.weidmueller.com		

connectPower PROtop

- 3-phase power supplies

PRO TOP3 480 W 48 V 10 A

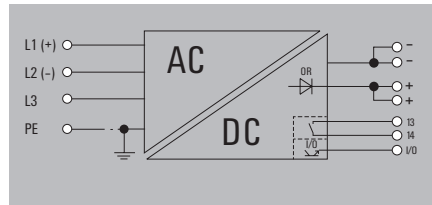

PRO TOP3 960 W 48 V 20 A

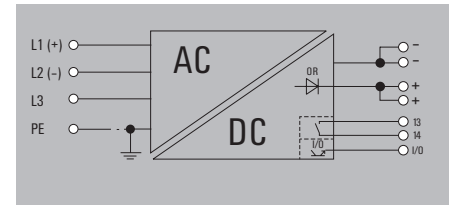

Technical data

Input	
Rated input voltage	3x 400...3x 500 V AC (wide-range input)
Input voltage range AC	3 x 320...3 x 575 V AC / 2 x 360...2 x 575 V AC
Frequency range AC	45...65 Hz
DC input voltage range	450...800 V DC (max. 500 V DC acc. to UL508)
Input fuse (internal) / Inrush current	No / Max. 10 A
Output	
Rated output voltage	48 V DC ± 1 %
Output voltage	45...56 V adjustable with potentiometer or communication module
DCL - peak load reserve	150 % (5 s); 500 % (15 ms)
Residual ripple, breaking spikes	< 50 mVss @ U _{Nom} , Full Load
Reserve capacity @ U _{Nominal}	130% permanent at ≤ 40°C, 150 % (5 s)
Nominal output current for U _{Nom}	10 A @ 60 °C
MTBF	
According to Standard	SN 29500
Operating time (hours), min.	1.1Mh
Ambient temperature	25°C
Input voltage	400V
Output power	480W
Duty cycle	100%
General data	
Derating	> 60°C (2.5% / 1°C)
Series switching capability	No
Degree of efficiency	94%
Power factor (approx.)	> 0.75 @ 3x400 V AC
AC failure bridging time @ I _{Nom}	> 20 ms @ 230 V AC / > 20 ms @ 115 V AC
LED green/red	Green: Operation (failure-free), Flashing green: advance warning I>90%, Green/red flashing: output switched off (switch-off mode), Flashing red: overload/error
Parallel connection option	yes, max 10
Depth x width x height	125 / 68 / 130 mm
Net weight	1645 g
Approvals	
Approvals	ABS; BURVER; cULus; cULusEX; DETNORVER; EAC; LLOYDSREG; RINA; RS; TUEV
Connection data	
Connection system	PUSH IN
Number of terminals	4 for L1/L2/L3/PE
Wire cross-section, rigid min/max	0.2 / 10
Wire cross-section, flexible min/max	0.2 / 6
Wire cross-section, AWG/kcmil min/max	20 / 8
Note	

Ordering data

Type	Qty.	Order No.
PRO TOP3 480W 48V 10A	1	2467150000

Current technical data at catalog.weidmueller.com

Input	
Rated input voltage	3x 400...3x 500 V AC (wide-range input)
Input voltage range AC	3 x 320...3 x 575 V AC / 2 x 360...2 x 575 V AC
Frequency range AC	45...65 Hz
DC input voltage range	450...800 V DC (max. 500 V DC acc. to UL508)
Input fuse (internal) / Inrush current	No / Max. 10 A
Output	
Rated output voltage	48 V DC ± 1 %
Output voltage	45...56 V adjustable with potentiometer or communication module
DCL - peak load reserve	150 % (5 s); 500 % (15 ms)
Residual ripple, breaking spikes	< 50 mVss @ U _{Nom} , Full Load
Reserve capacity @ U _{Nominal}	130% permanent at ≤ 40°C, 150 % (5 s)
Nominal output current for U _{Nom}	10 A @ 60 °C
MTBF	
According to Standard	SN 29500
Operating time (hours), min.	1.1Mh
Ambient temperature	25°C
Input voltage	400V
Output power	480W
Duty cycle	100%
General data	
Derating	> 60°C (2.5% / 1°C)
Series switching capability	No
Degree of efficiency	94%
Power factor (approx.)	> 0.75 @ 3x400 V AC
AC failure bridging time @ I _{Nom}	> 20 ms @ 230 V AC / > 20 ms @ 115 V AC
LED green/red	Green: Operation (failure-free), Flashing green: advance warning I>90%, Green/red flashing: output switched off (switch-off mode), Flashing red: overload/error
Parallel connection option	yes, max 10
Depth x width x height	125 / 68 / 130 mm
Net weight	1645 g
Approvals	
Approvals	ABS; BURVER; cULus; cULusEX; DETNORVER; EAC; LLOYDSREG; RINA; RS; TUEV
Connection data	
Connection system	PUSH IN
Number of terminals	4 for L1/L2/L3/PE
Wire cross-section, rigid min/max	0.2 / 10
Wire cross-section, flexible min/max	0.2 / 6
Wire cross-section, AWG/kcmil min/max	20 / 8
Note	

Type	Qty.	Order No.
PRO TOP3 480W 48V 10A	1	2467150000

Current technical data at catalog.weidmueller.com

Input	
Rated input voltage	3x 400...3x 500 V AC (wide-range input)
Input voltage range AC	3 x 320...3 x 575 V AC / 2 x 360...2 x 575 V AC
Frequency range AC	45...65 Hz
DC input voltage range	450...800 V DC (max. 500 V DC acc. to UL508)
Input fuse (internal) / Inrush current	No / Max. 10 A
Output	
Rated output voltage	48 V DC ± 1 %
Output voltage	45...56 V adjustable with potentiometer or communication module
DCL - peak load reserve	150 % (5 s); 400 % (15 ms)
Residual ripple, breaking spikes	< 50 mVss @ U _{Nom} , Full Load
Reserve capacity @ U _{Nominal}	130% permanent at ≤ 40°C, 150 % (5 s)
Nominal output current for U _{Nom}	20 A @ 60 °C
MTBF	
According to Standard	SN 29500
Operating time (hours), min.	1.2Mh
Ambient temperature	25°C
Input voltage	400V
Output power	960W
Duty cycle	100%
General data	
Derating	> 60°C (2.5% / 1°C)
Series switching capability	No
Degree of efficiency	95,3 %
Power factor (approx.)	> 0.75 @ 3x400 V AC
AC failure bridging time @ I _{Nom}	> 20 ms @ 230 V AC / > 20 ms @ 115 V AC
LED green/red	Green: Operation (failure-free), Flashing green: advance warning I>90%, Green/red flashing: output switched off (switch-off mode), Flashing red: overload/error
Parallel connection option	yes, max 10
Depth x width x height	175 / 89 / 130 mm
Net weight	2490 g
Approvals	
Approvals	ABS; BURVER; cULus; cULusEX; DETNORVER; EAC; LLOYDSREG; RINA; RS; TUEV
Connection data	
Connection system	PUSH IN
Number of terminals	4 for L1/L2/L3/PE
Wire cross-section, rigid min/max	0.75 / 16
Wire cross-section, flexible min/max	0.75 / 16
Wire cross-section, AWG/kcmil min/max	20 / 4
Note	

Type	Qty.	Order No.
PRO TOP3 960W 48V 20A	1	2467170000

Current technical data at catalog.weidmueller.com

connectPower PROtop

connectPower PROtop

- DCL technology for an excellent dynamic range
- High energy efficiency (up to 95.4 % efficiency)
- Mode of operation: single or parallel operation and adjustable short-circuit response (continuous current or switch-off)
- Useful life of up to 10 years, MTBF > 1 000 000 h.
- Extremely slim design
- Time-saving PUSH IN connection technology



Derating curve

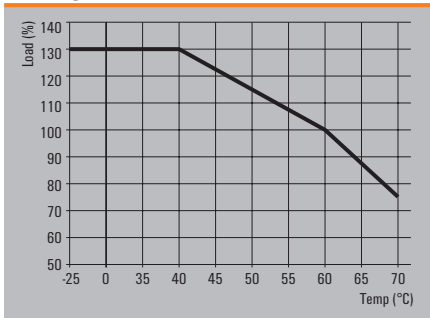

Technical data

General data	
Insulation voltage input / earth	3.2 kV
Insulation voltage output / earth	0.5 kV
Insulation voltage, input/output	3.5 kV
Earth leakage current, max.	3.5 mA
Series switching capability	Yes
Ambient temperature (operational) / Storage temperature	-40 °C...70 °C / -40 °C...85 °C
Humidity at operating temperature	5...100 % no condensation
Protection class / Pollution degree	I, with PE connection / 2
Housing version	Metal, corrosion resistant
Mounting position, installation notice	Horizontal on DIN rail TS 35, top and bottom 50 mm clearance for free air flow, 10 mm clearance to neighbouring active subassemblies with full load, 5 mm with passive neighbouring subassemblies, direct row mounting with 90% rated load
Conformal coating	Yes
EMC / shock / vibration	
Interference immunity test acc. to	EN 55032:2015, EN 55024:2010/A1:2015, EN 55035:2017, EN 61000-3-2:2014, EN 61000-6-1:2007, EN 61000-6-2:2005, EN 61000-6-3:2007/A1:2011, EN 61000-6-4:2007/A1:2011
Shock	30 g in all directions
Resistance to vibration	2.3 g (on DIN rail), 4 g (with direct mounting)
Electrical safety (applied standards)	
Electrical machine equipment	Acc. to EN60204
Safety transformers for switch-mode power supplies	According to EN 61558-2-16
For use with electronic equipment	Acc. to EN50178 / VDE0160
Safety extra-low voltage	SELV acc. to IEC 60950-1, PELV according to EN 60204-1
Protective separation / protection against electrical shock	VDE0100-410 / acc. to DIN57100-410
Protection against dangerous shock currents	Acc. to VDE0106-101

connectPower PROtop

- 1-phase power supplies

PRO TOP1 72W 24V 3A CO

PRO TOP1 120W 24V 5A EX

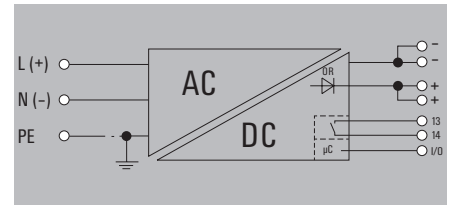
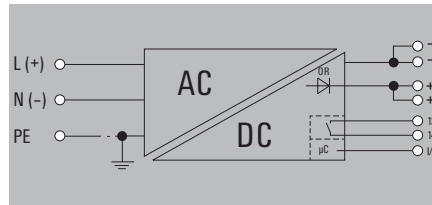

Technical data

Input	
Rated input voltage	110...240 V AC / 120...340 V DC
Input voltage range AC	85...277 V AC
Frequency range AC	45...65 Hz
DC input voltage range	80 ... 410 V DC
Input fuse (internal) / Inrush current	Yes / max. 5 A
Output	
Rated output voltage	24 V DC ± 1 %
Output voltage	22.5...28.8 V adjustable with potentiometer or communication module
DCL - peak load reserve	150 % (5 s); 400 % (15 ms)
Residual ripple, breaking spikes	< 50 mVss @ U _{Nom} , Full Load
Reserve capacity @ U _{Nominal}	130% permanent at ≤ 40°C, 150 % (5 s)
Nominal output current for U _{Nom}	3 A @ 60 °C
MTBF	
According to Standard	SN 29500
Operating time (hours), min.	2.3Mh
Ambient temperature	25°C
Input voltage	230V
Output power	72W
Duty cycle	100%
General data	
Derating	> 60°C (2.5% / 1°C)
Series switching capability	Yes
Degree of efficiency	89%
Power factor (approx.)	> 0.5
AC failure bridging time @ I _{Nom}	> 20 ms @ 230 V AC / > 20 ms @ 115 V AC
LED green/red	Green: Operation (failure-free), Flashing green: advance warning I>90%, Green/red flashing: output switched off (switch-off mode), Flashing red: overload/error
Parallel connection option	yes, max 10
Depth x width x height	125 / 35 / 130 mm
Net weight	650 g
Approvals	
Approvals	ABS; BURVER; cULus; cULusEX; DETNORVER; EAC; LLOYDSREG; RINA; RS; TUEV
Connection data	
Connection system	Clamping yoke
Number of terminals	3 for L/N/PE
Wire cross-section, rigid min/max	0.2 / 4 mm ²
Wire cross-section, flexible min/max	0.2 / 4 mm ²
Wire cross-section, AWG/kcmil min/max	30 / 12
Note	

Rated input voltage	110...240 V AC / 120...340 V DC
Input voltage range AC	85...277 V AC
Frequency range AC	45...65 Hz
DC input voltage range	80 ... 410 V DC
Input fuse (internal) / Inrush current	Yes / max. 5 A
Rated output voltage	24 V DC ± 1 %
Output voltage	22.5...28.8 V adjustable with potentiometer or communication module
DCL - peak load reserve	150 % (5 s); 400 % (15 ms)
Residual ripple, breaking spikes	< 50 mVss @ U _{Nom} , Full Load
Reserve capacity @ U _{Nominal}	130% permanent at ≤ 40°C, 150 % (5 s)
Nominal output current for U _{Nom}	3 A @ 60 °C
According to Standard	SN 29500
Operating time (hours), min.	2.3Mh
Ambient temperature	25°C
Input voltage	230V
Output power	72W
Duty cycle	100%
Derating	> 60°C (2.5% / 1°C)
Series switching capability	Yes
Degree of efficiency	89%
Power factor (approx.)	> 0.5
AC failure bridging time @ I _{Nom}	> 20 ms @ 230 V AC / > 20 ms @ 115 V AC
LED green/red	Green: Operation (failure-free), Flashing green: advance warning I>90%, Green/red flashing: output switched off (switch-off mode), Flashing red: overload/error
Parallel connection option	yes, max 10
Depth x width x height	125 / 35 / 130 mm
Net weight	650 g
Approvals	ABS; BURVER; cULus; cULusEX; DETNORVER; EAC; LLOYDSREG; RINA; RS; TUEV
Connection system	Clamping yoke
Number of terminals	3 for L/N/PE
Wire cross-section, rigid min/max	0.2 / 4 mm ²
Wire cross-section, flexible min/max	0.2 / 4 mm ²
Wire cross-section, AWG/kcmil min/max	30 / 12

Rated input voltage	110...240 V AC / 120...340 V DC
Input voltage range AC	85...277 V AC
Frequency range AC	45...65 Hz
DC input voltage range	48...410 V DC (Derating 40% @ 48 V DC)
Input fuse (internal) / Inrush current	Yes / max. 5 A
Rated output voltage	24 V DC ± 1 %
Output voltage	22.5...28.8 V adjustable with potentiometer or communication module
DCL - peak load reserve	150 % (5 s); 600 % (15 ms)
Residual ripple, breaking spikes	< 50 mVss @ U _{Nom} , Full Load
Reserve capacity @ U _{Nominal}	130% permanent at ≤ 40°C, 150 % (5 s)
Nominal output current for U _{Nom}	5 A @ 60 °C
According to Standard	SN 29500
Operating time (hours), min.	1.9Mh
Ambient temperature	25°C
Input voltage	230V
Output power	120W
Duty cycle	100%
Derating	> 60°C (2.5% / 1°C)
Series switching capability	Yes
Degree of efficiency	91%
Power factor (approx.)	> 0.85
AC failure bridging time @ I _{Nom}	> 20 ms @ 230 V AC / > 20 ms @ 115 V AC
LED green/red	Green: Operation (failure-free), Flashing green: advance warning I>90%, Green/red flashing: output switched off (switch-off mode), Flashing red: overload/error
Parallel connection option	yes, max 10
Depth x width x height	125 / 35 / 130 mm
Net weight	850 g
Approvals	ABS; BURVER; cULus; cULusEX; DETNORVER; EAC; IECEXTUEV; LLOYDSREG; RINA; RS; TUEV; TUEVSATX
Connection system	Clamping yoke
Number of terminals	3 for L/N/PE
Wire cross-section, rigid min/max	0.2 / 4 mm ²
Wire cross-section, flexible min/max	0.2 / 4 mm ²
Wire cross-section, AWG/kcmil min/max	30 / 12

Ordering data

Type	Qty.	Order No.
PRO TOP1 72W 24V 3A CO	1	2466970000

Type	Qty.	Order No.
PRO TOP1 72W 24V 3A CO	1	2466970000

Type	Qty.	Order No.
PRO TOP1 120W 24V 5A EX	1	2466980000

Note

connectPower PROtop

connectPower PROtop

- 1-phase power supplies

PRO TOP1 240W 24V 10A EX

PRO TOP1 480W 24V 20A EX

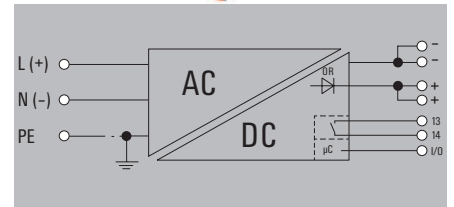
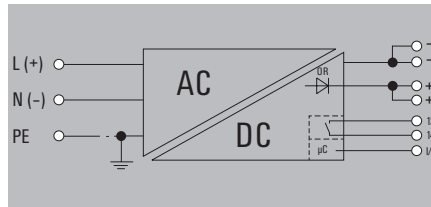

Technical data

Input	
Rated input voltage	110...240 V AC / 120...340 V DC
Input voltage range AC	85...277 V AC
Frequency range AC	45...65 Hz
DC input voltage range	80 ... 410 V DC
Input fuse (internal) / Inrush current	Yes / max. 5 A
Output	
Rated output voltage	24 V DC ± 1 %
Output voltage	22.5...28.8 V adjustable with potentiometer or communication module
DCL - peak load reserve	150 % (5 s); 600 % (15 ms)
Residual ripple, breaking spikes	< 50 mVss @ U _{Nom} , Full Load
Reserve capacity @ U _{Nominal}	130% permanent at ≤ 40°C, 150 % (5 s)
Nominal output current for U _{nom}	10 A @ 60 °C
MTBF	
According to Standard	SN 29500
Operating time (hours), min.	1.6Mh
Ambient temperature	25°C
Input voltage	230V
Output power	240W
Duty cycle	100%
General data	
Derating	> 60°C (2.5% / 1°C)
Series switching capability	Yes
Degree of efficiency	92 %
Power factor (approx.)	> 0.9
AC failure bridging time @ I _{nom}	> 20 ms @ 230 V AC / > 20 ms @ 115 V AC
LED green/red	Green: Operation (failure-free), Flashing green: advance warning I>90%, Green/red flashing: output switched off (switch-off mode), Flashing red: overload/error
Parallel connection option	yes, max 10
Depth x width x height	125 / 39 / 130 mm
Net weight	1.05 g
Approvals	
Approvals	ABS; BURVER; cULus; cULusEX; DETNORVER; EAC; IECEXTUEV; LLOYDSREG; RINA; RS; TUEV; TUEVSATEX
Connection data	
Connection system	Clamping yoke
Number of terminals	3 for L/N/PE
Wire cross-section, rigid min/max	0.2 / 4 mm ²
Wire cross-section, flexible min/max	0.2 / 4 mm ²
Wire cross-section, AWG/kcmil min/max	30 / 12
Note	

Input	
Rated input voltage	110...240 V AC / 120...340 V DC
Input voltage range AC	85...277 V AC
Frequency range AC	45...65 Hz
DC input voltage range	80 ... 410 V DC
Input fuse (internal) / Inrush current	Yes / max. 5 A
Output	
Rated output voltage	24 V DC ± 1 %
Output voltage	22.5...28.8 V adjustable with potentiometer or communication module
DCL - peak load reserve	150 % (5 s); 500 % (15 ms)
Residual ripple, breaking spikes	< 50 mVss @ U _{Nom} , Full Load
Reserve capacity @ U _{Nominal}	130% permanent at ≤ 40°C, 150 % (5 s)
Nominal output current for U _{nom}	20 A @ 60 °C
MTBF	
According to Standard	SN 29500
Operating time (hours), min.	1.22Mh
Ambient temperature	25°C
Input voltage	230V
Output power	480W
Duty cycle	100%
General data	
Derating	> 60°C (2.5% / 1°C)
Series switching capability	Yes
Degree of efficiency	93%
Power factor (approx.)	> 0.9
AC failure bridging time @ I _{nom}	> 20 ms @ 230 V AC / > 20 ms @ 115 V AC
LED green/red	Green: Operation (failure-free), Flashing green: advance warning I>90%, Green/red flashing: output switched off (switch-off mode), Flashing red: overload/error
Parallel connection option	yes, max 10
Depth x width x height	125 / 68 / 130 mm
Net weight	1520 g
Approvals	
Approvals	ABS; BURVER; cULus; cULusEX; DETNORVER; EAC; IECEXTUEV; LLOYDSREG; RINA; RS; TUEV; TUEVSATEX
Connection data	
Connection system	Clamping yoke connection
Number of terminals	5 (+ + / - -)
Wire cross-section, rigid min/max	0.18 / 6 mm ²
Wire cross-section, flexible min/max	0.22 / 4 mm ²
Wire cross-section, AWG/kcmil min/max	26 / 10
Note	

Input	
Rated input voltage	110...240 V AC / 120...340 V DC
Input voltage range AC	85...277 V AC
Frequency range AC	45...65 Hz
DC input voltage range	80 ... 410 V DC
Input fuse (internal) / Inrush current	Yes / max. 5 A
Output	
Rated output voltage	24 V DC ± 1 %
Output voltage	22.5...28.8 V adjustable with potentiometer or communication module
DCL - peak load reserve	150 % (5 s); 500 % (15 ms)
Residual ripple, breaking spikes	< 50 mVss @ U _{Nom} , Full Load
Reserve capacity @ U _{Nominal}	130% permanent at ≤ 40°C, 150 % (5 s)
Nominal output current for U _{nom}	20 A @ 60 °C
MTBF	
According to Standard	SN 29500
Operating time (hours), min.	1.22Mh
Ambient temperature	25°C
Input voltage	230V
Output power	480W
Duty cycle	100%
General data	
Derating	> 60°C (2.5% / 1°C)
Series switching capability	Yes
Degree of efficiency	93%
Power factor (approx.)	> 0.9
AC failure bridging time @ I _{nom}	> 20 ms @ 230 V AC / > 20 ms @ 115 V AC
LED green/red	Green: Operation (failure-free), Flashing green: advance warning I>90%, Green/red flashing: output switched off (switch-off mode), Flashing red: overload/error
Parallel connection option	yes, max 10
Depth x width x height	125 / 68 / 130 mm
Net weight	1520 g
Approvals	
Approvals	ABS; BURVER; cULus; cULusEX; DETNORVER; EAC; IECEXTUEV; LLOYDSREG; RINA; RS; TUEV; TUEVSATEX
Connection data	
Connection system	Clamping yoke connection
Number of terminals	5 (+ + / - -)
Wire cross-section, rigid min/max	0.18 / 6 mm ²
Wire cross-section, flexible min/max	0.22 / 4 mm ²
Wire cross-section, AWG/kcmil min/max	26 / 10
Note	

Ordering data

Type	Qty.	Order No.
PRO TOP1 240W 24V 10A EX	1	2466990000

Type	Qty.	Order No.
PRO TOP1 240W 24V 10A EX	1	2466990000

Type	Qty.	Order No.
PRO TOP1 480W 24V 20A EX	1	2467000000

Note

connectPower PROtop

- 1-phase power supplies

PRO TOP1 480W 48V 10A EX

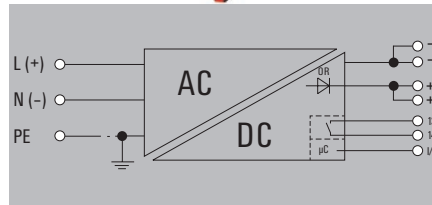

PRO TOP1 960W 48V 20A CO

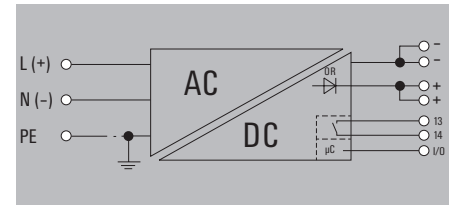

Technical data

Input	
Rated input voltage	110...240 V AC / 120...340 V DC
Input voltage range AC	85...277 V AC
Frequency range AC	45...65 Hz
DC input voltage range	80 ... 410 V DC
Input fuse (internal) / Inrush current	Yes / max. 5 A
Output	
Rated output voltage	48 V DC \pm 1 %
Output voltage	45...56 V adjustable with potentiometer or communication module
DCL - peak load reserve	150 % (5 s); 500 % (15 ms)
Residual ripple, breaking spikes	< 100 mV _{pp}
Reserve capacity @ U _{Nominal}	130% permanent at \leq 40°C, 150 % (5 s)
Nominal output current for U _{nom}	10 A @ 60 °C
MTBF	
According to Standard	SN 29500
Operating time (hours), min.	1.19Mh
Ambient temperature	25°C
Input voltage	230V
Output power	480W
Duty cycle	100%
General data	
Derating	> 60°C (2.5% / 1°C)
Series switching capability	No
Degree of efficiency	93%
Power factor (approx.)	> 0.9
AC failure bridging time @ I _{nom}	> 20 ms @ 230 V AC / > 20 ms @ 115 V AC
LED green/red	Green: Operation (failure-free), Flashing green: advance warning I>90%, Green/red flashing: output switched off (switch-off mode), Flashing red: overload/error
Parallel connection option	yes, max 10
Depth x width x height	125 / 68 / 130 mm
Net weight	1520 g
Approvals	
Approvals	ABS; BURVER; cULus; cULusEX; DETNORVER; EAC; IECEXTUEV; LLOYDSREG; RINA; RS; TUEV; TUEVSATEX
Connection data	
Connection system	Clamping yoke
Number of terminals	3 for L/N/PE
Wire cross-section, rigid min/max	0.18 / 6
Wire cross-section, flexible min/max	0.22 / 4
Wire cross-section, AWG/kcmil min/max	26 / 10
Note	

Rated input voltage	110...240 V AC / 120...340 V DC
Input voltage range AC	85...277 V AC
Frequency range AC	45...65 Hz
DC input voltage range	80 ... 410 V DC
Input fuse (internal) / Inrush current	Yes / max. 5 A
Rated output voltage	48 V DC \pm 1 %
Output voltage	45...56 V adjustable with potentiometer or communication module
DCL - peak load reserve	150 % (5 s); 500 % (15 ms)
Residual ripple, breaking spikes	< 100 mV _{pp}
Reserve capacity @ U _{Nominal}	130% permanent at \leq 40°C, 150 % (5 s)
Nominal output current for U _{nom}	10 A @ 60 °C
According to Standard	SN 29500
Operating time (hours), min.	1.19Mh
Ambient temperature	25°C
Input voltage	230V
Output power	480W
Duty cycle	100%
Derating	> 60°C (2.5% / 1°C)
Series switching capability	No
Degree of efficiency	93%
Power factor (approx.)	> 0.9
AC failure bridging time @ I _{nom}	> 20 ms @ 230 V AC / > 20 ms @ 115 V AC
LED green/red	Green: Operation (failure-free), Flashing green: advance warning I>90%, Green/red flashing: output switched off (switch-off mode), Flashing red: overload/error
Parallel connection option	yes, max 10
Depth x width x height	125 / 68 / 130 mm
Net weight	1520 g
Approvals	ABS; BURVER; cULus; cULusEX; DETNORVER; EAC; IECEXTUEV; LLOYDSREG; RINA; RS; TUEV; TUEVSATEX
Connection system	Clamping yoke
Number of terminals	3 for L/N/PE
Wire cross-section, rigid min/max	0.18 / 6
Wire cross-section, flexible min/max	0.22 / 4
Wire cross-section, AWG/kcmil min/max	26 / 10
Note	

Rated input voltage	110...240 V AC / 120...340 V DC
Input voltage range AC	85...277 V AC
Frequency range AC	45...65 Hz
DC input voltage range	80 ... 410 V DC
Input fuse (internal) / Inrush current	Yes / max. 15 A
Rated output voltage	48 V DC \pm 1 %
Output voltage	45...56 V adjustable with potentiometer or communication module
DCL - peak load reserve	150 % (5 s); 400 % (15 ms)
Residual ripple, breaking spikes	< 100 mV _{pp}
Reserve capacity @ U _{Nominal}	130% permanent at \leq 40°C, 150 % (5 s)
Nominal output current for U _{nom}	20 A @ 60 °C
According to Standard	SN 29500
Operating time (hours), min.	1.15Mh
Ambient temperature	25°C
Input voltage	230V
Output power	960W
Duty cycle	100%
Derating	> 60°C (2.5% / 1°C)
Series switching capability	No
Degree of efficiency	94%
Power factor (approx.)	> 0.9
AC failure bridging time @ I _{nom}	> 20 ms @ 230 V AC / > 20 ms @ 115 V AC
LED green/red	Green: Operation (failure-free), Flashing green: advance warning I>90%, Green/red flashing: output switched off (switch-off mode), Flashing red: overload/error
Parallel connection option	yes, max 10
Depth x width x height	125 / 139 / 130 mm
Net weight	3382 g
Approvals	ABS; BURVER; cULus; cULusEX; DETNORVER; EAC; LLOYDSREG; RINA; RS; TUEV
Connection system	Clamping yoke
Number of terminals	3 for L/N/PE
Wire cross-section, rigid min/max	0.18 / 6
Wire cross-section, flexible min/max	0.22 / 4
Wire cross-section, AWG/kcmil min/max	26 / 10
Note	

Ordering data

Type	Qty.	Order No.
PRO TOP1 480W 48V 10A EX	1	2467040000
Note		

Type	Qty.	Order No.
PRO TOP1 480W 48V 10A EX	1	2467040000
Note		

Type	Qty.	Order No.
PRO TOP1 960W 48V 20A CO	1	2467050000
Note		

connectPower PROtop

connectPower PROtop

- 1-phase power supplies

PRO TOP1 960W 24V 40A EX

PRO TOP1 120W 12V 10A EX

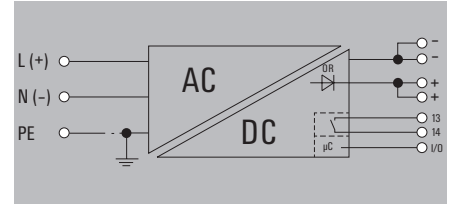
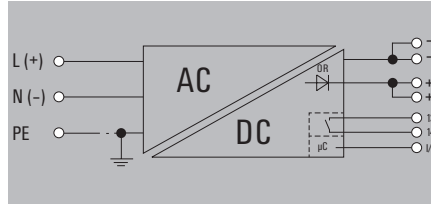

Technical data

Input	
Rated input voltage	110...240 V AC / 120...340 V DC
Input voltage range AC	85...277 V AC
Frequency range AC	45...65 Hz
DC input voltage range	80 ... 410 V DC
Input fuse (internal) / Inrush current	Yes / max. 15 A
Output	
Rated output voltage	24 V DC ± 1 %
Output voltage	22.5...28.8 V adjustable with potentiometer or communication module
DCL - peak load reserve	150 % (5 s); 400 % (15 ms)
Residual ripple, breaking spikes	< 50 mVss @ U _{Nom} , Full Load
Reserve capacity @ U _{Nominal}	130% permanent at ≤ 40°C, 150 % (5 s)
Nominal output current for U _{Nom}	40 A @ 60 °C
MTBF	
According to Standard	SN 29500
Operating time (hours), min.	1.04Mh
Ambient temperature	25°C
Input voltage	230V
Output power	960W
Duty cycle	100%
General data	
Derating	> 60°C (2.5% / 1°C)
Series switching capability	Yes
Degree of efficiency	94%
Power factor (approx.)	> 0.9
AC failure bridging time @ I _{Nom}	> 20 ms @ 230 V AC / > 20 ms @ 115 V AC
LED green/red	Green: Operation (failure-free), Flashing green: advance warning I>90%, Green/red flashing: output switched off (switch-off mode), Flashing red: overload/error
Parallel connection option	yes, max 10
Depth x width x height	125 / 139 / 130 mm
Net weight	3382 g
Approvals	
Approvals	ABS; BURVER; cULus; cULusEX; DETNORVER; EAC; IECEXTUEV; LLOYDSREG; RINA; RS; TUEV; TUEVSATEX
Connection data	
Connection system	Clamping yoke
Number of terminals	3 for L/N/PE
Wire cross-section, rigid min/max	0.18 / 6 mm ²
Wire cross-section, flexible min/max	0.22 / 4 mm ²
Wire cross-section, AWG/kcmil min/max	26 / 10
Note	

Input	
Rated input voltage	110...240 V AC / 120...340 V DC
Input voltage range AC	85...277 V AC
Frequency range AC	45...65 Hz
DC input voltage range	80 ... 410 V DC
Input fuse (internal) / Inrush current	Yes / max. 15 A
Output	
Rated output voltage	24 V DC ± 1 %
Output voltage	22.5...28.8 V adjustable with potentiometer or communication module
DCL - peak load reserve	150 % (5 s); 400 % (15 ms)
Residual ripple, breaking spikes	< 50 mVss @ U _{Nom} , Full Load
Reserve capacity @ U _{Nominal}	130% permanent at ≤ 40°C, 150 % (5 s)
Nominal output current for U _{Nom}	40 A @ 60 °C
MTBF	
According to Standard	SN 29500
Operating time (hours), min.	1.04Mh
Ambient temperature	25°C
Input voltage	230V
Output power	960W
Duty cycle	100%
General data	
Derating	> 60°C (2.5% / 1°C)
Series switching capability	Yes
Degree of efficiency	94%
Power factor (approx.)	> 0.9
AC failure bridging time @ I _{Nom}	> 20 ms @ 230 V AC / > 20 ms @ 115 V AC
LED green/red	Green: Operation (failure-free), Flashing green: advance warning I>90%, Green/red flashing: output switched off (switch-off mode), Flashing red: overload/error
Parallel connection option	yes, max 10
Depth x width x height	125 / 139 / 130 mm
Net weight	3382 g
Approvals	
Approvals	ABS; BURVER; cULus; cULusEX; DETNORVER; EAC; IECEXTUEV; LLOYDSREG; RINA; RS; TUEV; TUEVSATEX
Connection data	
Connection system	Clamping yoke
Number of terminals	3 for L/N/PE
Wire cross-section, rigid min/max	0.18 / 6 mm ²
Wire cross-section, flexible min/max	0.22 / 4 mm ²
Wire cross-section, AWG/kcmil min/max	26 / 10
Note	

Input	
Rated input voltage	110...240 V AC / 120...340 V DC
Input voltage range AC	85...277 V AC
Frequency range AC	45...65 Hz
DC input voltage range	80 ... 410 V DC
Input fuse (internal) / Inrush current	Yes / max. 5 A
Output	
Rated output voltage	12 V DC ± 1 %
Output voltage	11...15 V adjustable with potentiometer or communication module
DCL - peak load reserve	150 % (5 s); 400 % (15 ms)
Residual ripple, breaking spikes	< 50 mVss @ U _{Nom} , Full Load
Reserve capacity @ U _{Nominal}	130% permanent at ≤ 40°C, 150 % (5 s)
Nominal output current for U _{Nom}	10 A @ 60 °C
MTBF	
According to Standard	SN 29500
Operating time (hours), min.	1.5Mh
Ambient temperature	25°C
Input voltage	230V
Output power	120W
Duty cycle	100%
General data	
Derating	> 60°C (2.5% / 1°C)
Series switching capability	Yes
Degree of efficiency	90%
Power factor (approx.)	> 0.85
AC failure bridging time @ I _{Nom}	> 20 ms @ 230 V AC / > 20 ms @ 115 V AC
LED green/red	Green: Operation (failure-free), Flashing green: advance warning I>90%, Green/red flashing: output switched off (switch-off mode), Flashing red: overload/error
Parallel connection option	yes, max 10
Depth x width x height	125 / 35 / 130 mm
Net weight	850 g
Approvals	
Approvals	ABS; BURVER; cULus; cULusEX; DETNORVER; EAC; IECEXTUEV; LLOYDSREG; RINA; RS; TUEV; TUEVSATEX
Connection data	
Connection system	Clamping yoke
Number of terminals	3 for L/N/PE
Wire cross-section, rigid min/max	0.2 / 4 mm ²
Wire cross-section, flexible min/max	0.2 / 4 mm ²
Wire cross-section, AWG/kcmil min/max	30 / 12
Note	

Ordering data

Type	Qty.	Order No.
PRO TOP1 960W 24V 40A EX	1	2467010000

Type	Qty.	Order No.
PRO TOP1 120W 12V 10A EX	1	2467020000

Type	Qty.	Order No.
PRO TOP1 120W 12V 10A EX	1	2467020000

Note

Note

Note

connectPower PROtop

- 3-phase power supplies

PRO TOP3 120W 24V 5A CO

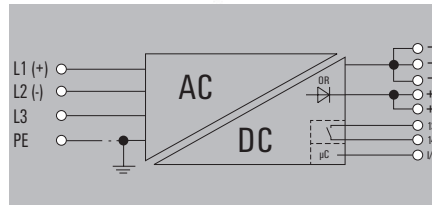

PRO TOP3 240W 24V 10A CO

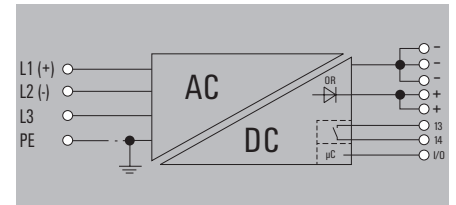

Technical data

Input	
Rated input voltage	3x 400...3x 500 V AC (wide-range input)
Input voltage range AC	3 x 320...3 x 575 V AC / 2 x 360...2 x 575 V AC
Frequency range AC	45...65 Hz
DC input voltage range	450...800 V DC (max. 500 V DC acc. to UL508)
Input fuse (internal) / Inrush current	No / Max. 10 A
Output	
Rated output voltage	24 V DC ± 1 %
Output voltage	22.5...28.8 V adjustable with potentiometer or communication module
DCL - peak load reserve	150 % (5 s); 600 % (15 ms)
Residual ripple, breaking spikes	< 50 mVss @ U _{Nom} , Full Load
Reserve capacity @ U _{Nominal}	130% permanent at ≤ 40°C, 150 % (5 s)
Nominal output current for U _{Nom}	5 A @ 60 °C
MTBF	
According to Standard	SN 29500
Operating time (hours), min.	2Mh
Ambient temperature	25°C
Input voltage	400V
Output power	120W
Duty cycle	100%
General data	
Derating	> 60°C (2.5% / 1°C)
Series switching capability	Yes
Degree of efficiency	89%
Power factor (approx.)	> 0.4 @ 3x400 V AC
AC failure bridging time @ I _{Nom}	> 20 ms @ 230 V AC / > 20 ms @ 115 V AC
LED green/red	Green: Operation (failure-free), Flashing green: advance warning I>90%, Green/red flashing: output switched off (switch-off mode), Flashing red: overload/error
Parallel connection option	yes, max 10
Depth x width x height	125 / 39 / 130 mm
Net weight	967 g
Approvals	
Approvals	ABS; BURVER; cULus; cULusEX; DETNORVER; EAC; LLOYDSREG; RINA; RS; TUEV
Connection data	
Connection system	PUSH IN with actuator
Number of terminals	4 for L1/L2/L3/PE
Wire cross-section, rigid min/max	0.5 / 1.5 mm ²
Wire cross-section, flexible min/max	0.5 / 2.5 mm ²
Wire cross-section, AWG/kcmil min/max	20 / 12
Note	

Input	
Rated input voltage	3x 400...3x 500 V AC (wide-range input)
Input voltage range AC	3 x 320...3 x 575 V AC / 2 x 360...2 x 575 V AC
Frequency range AC	45...65 Hz
DC input voltage range	450...800 V DC (max. 500 V DC acc. to UL508)
Input fuse (internal) / Inrush current	No / Max. 10 A
Output	
Rated output voltage	24 V DC ± 1 %
Output voltage	22.5...28.8 V adjustable with potentiometer or communication module
DCL - peak load reserve	150 % (5 s); 600 % (15 ms)
Residual ripple, breaking spikes	< 50 mVss @ U _{Nom} , Full Load
Reserve capacity @ U _{Nominal}	130% permanent at ≤ 40°C, 150 % (5 s)
Nominal output current for U _{Nom}	5 A @ 60 °C
MTBF	
According to Standard	SN 29500
Operating time (hours), min.	2Mh
Ambient temperature	25°C
Input voltage	400V
Output power	120W
Duty cycle	100%
General data	
Derating	> 60°C (2.5% / 1°C)
Series switching capability	Yes
Degree of efficiency	89%
Power factor (approx.)	> 0.4 @ 3x400 V AC
AC failure bridging time @ I _{Nom}	> 20 ms @ 230 V AC / > 20 ms @ 115 V AC
LED green/red	Green: Operation (failure-free), Flashing green: advance warning I>90%, Green/red flashing: output switched off (switch-off mode), Flashing red: overload/error
Parallel connection option	yes, max 10
Depth x width x height	125 / 39 / 130 mm
Net weight	967 g
Approvals	
Approvals	ABS; BURVER; cULus; cULusEX; DETNORVER; EAC; LLOYDSREG; RINA; RS; TUEV
Connection data	
Connection system	PUSH IN with actuator
Number of terminals	4 for L1/L2/L3/PE
Wire cross-section, rigid min/max	0.5 / 1.5 mm ²
Wire cross-section, flexible min/max	0.5 / 2.5 mm ²
Wire cross-section, AWG/kcmil min/max	20 / 12
Note	

Input	
Rated input voltage	3x 400...3x 500 V AC (wide-range input)
Input voltage range AC	3 x 320...3 x 575 V AC / 2 x 360...2 x 575 V AC
Frequency range AC	45...65 Hz
DC input voltage range	450...800 V DC (max. 500 V DC acc. to UL508)
Input fuse (internal) / Inrush current	No / Max. 10 A
Output	
Rated output voltage	24 V DC ± 1 %
Output voltage	22.5...28.8 V adjustable with potentiometer or communication module
DCL - peak load reserve	150 % (5 s); 600 % (15 ms)
Residual ripple, breaking spikes	< 50 mVss @ U _{Nom} , Full Load
Reserve capacity @ U _{Nominal}	130% permanent at ≤ 40°C, 150 % (5 s)
Nominal output current for U _{Nom}	10 A @ 60 °C
MTBF	
According to Standard	SN 29500
Operating time (hours), min.	1.4Mh
Ambient temperature	25°C
Input voltage	400V
Output power	240W
Duty cycle	100%
General data	
Derating	> 60°C (2.5% / 1°C)
Series switching capability	Yes
Degree of efficiency	93%
Power factor (approx.)	> 0.75 @ 3x400 V AC
AC failure bridging time @ I _{Nom}	> 20 ms @ 230 V AC / > 20 ms @ 115 V AC
LED green/red	Green: Operation (failure-free), Flashing green: advance warning I>90%, Green/red flashing: output switched off (switch-off mode), Flashing red: overload/error
Parallel connection option	yes, max 10
Depth x width x height	125 / 50 / 130 mm
Net weight	1120 g
Approvals	
Approvals	ABS; BURVER; cULus; cULusEX; DETNORVER; EAC; LLOYDSREG; RINA; RS; TUEV
Connection data	
Connection system	PUSH IN with actuator
Number of terminals	4 for L1/L2/L3/PE
Wire cross-section, rigid min/max	0.5 / 1.5 mm ²
Wire cross-section, flexible min/max	0.5 / 2.5 mm ²
Wire cross-section, AWG/kcmil min/max	20 / 12
Note	

Ordering data

Type	Qty.	Order No.
PRO TOP3 120W 24V 5A CO	1	2467070000

Type	Qty.	Order No.
PRO TOP3 240W 24V 10A CO	1	2467090000

Type	Qty.	Order No.
PRO TOP3 240W 24V 10A CO	1	2467090000

Note

connectPower PROtop

connectPower PROtop

- 3-phase power supplies

PRO TOP3 480W 24V 20A CO

PRO TOP3 960W 24V 40A CO

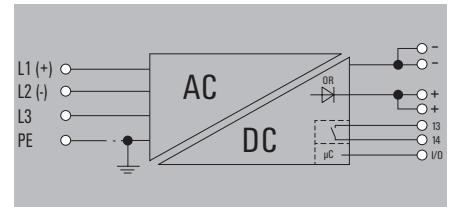
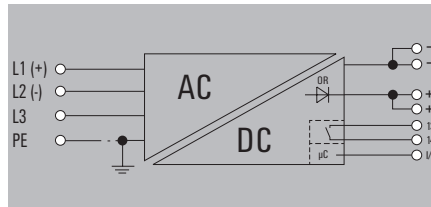

Technical data

Input	
Rated input voltage	3x 400...3x 500 V AC (wide-range input)
Input voltage range AC	3 x 320...3 x 575 V AC / 2 x 360...2 x 575 V AC
Frequency range AC	45...65 Hz
DC input voltage range	450...800 V DC (max. 500 V DC acc. to UL508)
Input fuse (internal) / Inrush current	No / Max. 10 A
Output	
Rated output voltage	24 V DC ± 1 %
Output voltage	22.5...28.8 V adjustable with potentiometer or communication module
DCL - peak load reserve	150 % (5 s); 500 % (15 ms)
Residual ripple, breaking spikes	< 50 mVss @ U _{Nom} , Full Load
Reserve capacity @ U _{Nominal}	130% permanent at ≤ 40°C, 150 % (5 s)
Nominal output current for U _{Nom}	20 A @ 60 °C
MTBF	
According to Standard	SN 29500
Operating time (hours), min.	1Mh
Ambient temperature	25°C
Input voltage	400V
Output power	480W
Duty cycle	100%
General data	
Derating	> 60°C (2.5% / 1°C)
Series switching capability	Yes
Degree of efficiency	94%
Power factor (approx.)	> 0.75 @ 3x400 V AC
AC failure bridging time @ I _{Nom}	> 20 ms @ 230 V AC / > 20 ms @ 115 V AC
LED green/red	Green: Operation (failure-free), Flashing green: advance warning I>90%, Green/red flashing: output switched off (switch-off mode), Flashing red: overload/error
Parallel connection option	yes, max 10
Depth x width x height	125 / 68 / 130 mm
Net weight	1650 g
Approvals	
Approvals	ABS; BURVER; cULus; cULusEX; DETNORVER; EAC; LLOYDSREG; RINA; RS; TUEV
Connection data	
Connection system	PUSH IN
Number of terminals	4 for L1/L2/L3/PE
Wire cross-section, rigid min/max	0.2 / 10 mm ²
Wire cross-section, flexible min/max	0.2 / 6 mm ²
Wire cross-section, AWG/kcmil min/max	20 / 8
Note	

Rated input voltage	3x 400...3x 500 V AC (wide-range input)
Input voltage range AC	3 x 320...3 x 575 V AC / 2 x 360...2 x 575 V AC
Frequency range AC	45...65 Hz
DC input voltage range	450...800 V DC (max. 500 V DC acc. to UL508)
Input fuse (internal) / Inrush current	No / Max. 10 A
Rated output voltage	24 V DC ± 1 %
Output voltage	22.5...28.8 V adjustable with potentiometer or communication module
DCL - peak load reserve	150 % (5 s); 400 % (15 ms)
Residual ripple, breaking spikes	< 50 mVss @ U _{Nom} , Full Load
Reserve capacity @ U _{Nominal}	130% permanent at ≤ 40°C, 150 % (5 s)
Nominal output current for U _{Nom}	40 A @ 60 °C
SN 29500	SN 29500
1Mh	1Mh
25°C	25°C
400V	400V
480W	960W
100%	100%
> 60°C (2.5% / 1°C)	> 60°C (2.5% / 1°C)
Yes	Yes
94%	95,3 %
> 0.75 @ 3x400 V AC	> 0.75 @ 3x400 V AC
> 20 ms @ 230 V AC / > 20 ms @ 115 V AC	> 20 ms @ 230 V AC / > 20 ms @ 115 V AC
Green: Operation (failure-free), Flashing green: advance warning I>90%, Green/red flashing: output switched off (switch-off mode), Flashing red: overload/error	Green: Operation (failure-free), Flashing green: advance warning I>90%, Green/red flashing: output switched off (switch-off mode), Flashing red: overload/error
yes, max 10	yes, max 10
125 / 68 / 130 mm	175 / 89 / 130 mm
1650 g	2490 g
ABS; BURVER; cULus; cULusEX; DETNORVER; EAC; LLOYDSREG; RINA; RS; TUEV	ABS; BURVER; cULus; cULusEX; DETNORVER; EAC; LLOYDSREG; RINA; RS; TUEV
Input	Output
PUSH IN	PUSH IN
4 for L1/L2/L3/PE	4 (++ / -)
0.2 / 10	0.2 / 10
0.2 / 6	0.2 / 6
20 / 8	20 / 8

Rated input voltage	3x 400...3x 500 V AC (wide-range input)
Input voltage range AC	3 x 320...3 x 575 V AC / 2 x 360...2 x 575 V AC
Frequency range AC	45...65 Hz
DC input voltage range	450...800 V DC (max. 500 V DC acc. to UL508)
Input fuse (internal) / Inrush current	No / Max. 10 A
Rated output voltage	24 V DC ± 1 %
Output voltage	22.5...28.8 V adjustable with potentiometer or communication module
DCL - peak load reserve	150 % (5 s); 400 % (15 ms)
Residual ripple, breaking spikes	< 50 mVss @ U _{Nom} , Full Load
Reserve capacity @ U _{Nominal}	130% permanent at ≤ 40°C, 150 % (5 s)
Nominal output current for U _{Nom}	40 A @ 60 °C
SN 29500	SN 29500
1Mh	1Mh
25°C	25°C
400V	400V
960W	960W
100%	100%
> 60°C (2.5% / 1°C)	> 60°C (2.5% / 1°C)
Yes	Yes
95,3 %	95,3 %
> 0.75 @ 3x400 V AC	> 0.75 @ 3x400 V AC
> 20 ms @ 230 V AC / > 20 ms @ 115 V AC	> 20 ms @ 230 V AC / > 20 ms @ 115 V AC
Green: Operation (failure-free), Flashing green: advance warning I>90%, Green/red flashing: output switched off (switch-off mode), Flashing red: overload/error	Green: Operation (failure-free), Flashing green: advance warning I>90%, Green/red flashing: output switched off (switch-off mode), Flashing red: overload/error
yes, max 10	yes, max 10
175 / 89 / 130 mm	175 / 89 / 130 mm
2490 g	2490 g
ABS; BURVER; cULus; cULusEX; DETNORVER; EAC; LLOYDSREG; RINA; RS; TUEV	ABS; BURVER; cULus; cULusEX; DETNORVER; EAC; LLOYDSREG; RINA; RS; TUEV
Input	Output
PUSH IN	PUSH IN
4 for L1/L2/L3/PE	4 (++ / -)
0.75 / 16	0.75 / 16
0.75 / 16	0.75 / 16
20 / 4	20 / 4

Ordering data

Type	Qty.	Order No.
PRO TOP3 480W 24V 20A CO	1	2467110000

Type	Qty.	Order No.
PRO TOP3 480W 24V 20A CO	1	2467110000

Type	Qty.	Order No.
PRO TOP3 960W 24V 40A CO	1	2467130000

Note

connectPower PROtop

- 3-phase power supplies

PRO TOP3 960W 36V 26,6A CO

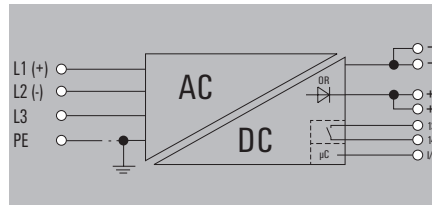

PRO TOP3 480W 48V 10A CO

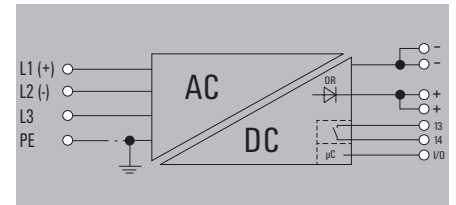

Technical data

Input	
Rated input voltage	3x 400...3x 500 V AC (wide-range input)
Input voltage range AC	3 x 320...3 x 575 V AC / 2 x 360...2 x 575 V AC
Frequency range AC	45...65 Hz
DC input voltage range	450...800 V DC (max. 500 V DC acc. to UL508)
Input fuse (internal) / Inrush current	No / Max. 10 A
Output	
Rated output voltage	36 V DC ± 1 %
Output voltage	33...44 V adjustable with potentiometer or communication module
DCL - peak load reserve	150 % (5 s); 500 % (15 ms)
Residual ripple, breaking spikes	< 50 mVss @ U _{Nom} , Full Load
Reserve capacity @ U _{Nominal}	130% permanent at ≤ 40°C, 150 % (5 s)
Nominal output current for U _{Nom}	26.6 A @ 60 °C
MTBF	
According to Standard	SN 29500
Operating time (hours), min.	1.24Mh
Ambient temperature	25°C
Input voltage	400V
Output power	960W
Duty cycle	100%
General data	
Derating	> 60°C (2.5% / 1°C)
Series switching capability	No
Degree of efficiency	95,3 %
Power factor (approx.)	> 0.75 @ 3x400 V AC
AC failure bridging time @ I _{Nom}	> 20 ms @ 230 V AC / > 20 ms @ 115 V AC
LED green/red	Green: Operation (failure-free), Flashing green: advance warning I>90%, Green/red flashing: output switched off (switch-off mode), Flashing red: overload/error
Parallel connection option	yes, max 10
Depth x width x height	175 / 89 / 130 mm
Net weight	2490 g
Approvals	
Approvals	ABS; BURVER; cULus; cULusEX; DETNORVER; EAC; LLOYDSREG; RINA; RS; TUEV
Connection data	
Connection system	PUSH IN
Number of terminals	4 for L1/L2/L3/PE
Wire cross-section, rigid min/max	0.75 / 16 mm ²
Wire cross-section, flexible min/max	0.75 / 16 mm ²
Wire cross-section, AWG/kcmil min/max	20 / 4
Note	

Rated input voltage	3x 400...3x 500 V AC (wide-range input)
Input voltage range AC	3 x 320...3 x 575 V AC / 2 x 360...2 x 575 V AC
Frequency range AC	45...65 Hz
DC input voltage range	450...800 V DC (max. 500 V DC acc. to UL508)
Input fuse (internal) / Inrush current	No / Max. 10 A
Rated output voltage	36 V DC ± 1 %
Output voltage	33...44 V adjustable with potentiometer or communication module
DCL - peak load reserve	150 % (5 s); 500 % (15 ms)
Residual ripple, breaking spikes	< 50 mVss @ U _{Nom} , Full Load
Reserve capacity @ U _{Nominal}	130% permanent at ≤ 40°C, 150 % (5 s)
Nominal output current for U _{Nom}	26.6 A @ 60 °C
According to Standard	SN 29500
Operating time (hours), min.	1.24Mh
Ambient temperature	25°C
Input voltage	400V
Output power	960W
Duty cycle	100%
Derating	> 60°C (2.5% / 1°C)
Series switching capability	No
Degree of efficiency	95,3 %
Power factor (approx.)	> 0.75 @ 3x400 V AC
AC failure bridging time @ I _{Nom}	> 20 ms @ 230 V AC / > 20 ms @ 115 V AC
LED green/red	Green: Operation (failure-free), Flashing green: advance warning I>90%, Green/red flashing: output switched off (switch-off mode), Flashing red: overload/error
Parallel connection option	yes, max 10
Depth x width x height	175 / 89 / 130 mm
Net weight	2490 g
Approvals	ABS; BURVER; cULus; cULusEX; DETNORVER; EAC; LLOYDSREG; RINA; RS; TUEV
Connection system	PUSH IN
Number of terminals	4 (++ / -)
Wire cross-section, rigid min/max	0.75 / 16
Wire cross-section, flexible min/max	0.75 / 16
Wire cross-section, AWG/kcmil min/max	20 / 4

Rated input voltage	3x 400...3x 500 V AC (wide-range input)
Input voltage range AC	3 x 320...3 x 575 V AC / 2 x 360...2 x 575 V AC
Frequency range AC	45...65 Hz
DC input voltage range	450...800 V DC (max. 500 V DC acc. to UL508)
Input fuse (internal) / Inrush current	No / Max. 10 A
Rated output voltage	48 V DC ± 1 %
Output voltage	45...56 V adjustable with potentiometer or communication module
DCL - peak load reserve	150 % (5 s); 500 % (15 ms)
Residual ripple, breaking spikes	< 100 mV ss @ 48 V DC, I Nenn
Reserve capacity @ U _{Nominal}	130% permanent at ≤ 40°C, 150 % (5 s)
Nominal output current for U _{Nom}	10 A @ 60 °C
According to Standard	SN 29500
Operating time (hours), min.	1.1Mh
Ambient temperature	25°C
Input voltage	400V
Output power	480W
Duty cycle	100%
Derating	> 60°C (2.5% / 1°C)
Series switching capability	No
Degree of efficiency	94%
Power factor (approx.)	> 0.75 @ 3x400 V AC
AC failure bridging time @ I _{Nom}	> 20 ms @ 230 V AC / > 20 ms @ 115 V AC
LED green/red	Green: Operation (failure-free), Flashing green: advance warning I>90%, Green/red flashing: output switched off (switch-off mode), Flashing red: overload/error
Parallel connection option	yes, max 10
Depth x width x height	125 / 68 / 130 mm
Net weight	1645 g
Approvals	ABS; BURVER; cULus; cULusEX; DETNORVER; EAC; LLOYDSREG; RINA; RS; TUEV
Connection system	PUSH IN
Number of terminals	4 (++ / -)
Wire cross-section, rigid min/max	0.2 / 10
Wire cross-section, flexible min/max	0.2 / 6
Wire cross-section, AWG/kcmil min/max	20 / 8

Ordering data

Type	Qty.	Order No.
PRO TOP3 960W 36V 26,6A CO	1	2467140000

Type	Qty.	Order No.
PRO TOP3 960W 36V 26,6A CO	1	2467140000

Type	Qty.	Order No.
PRO TOP3 480W 48V 10A CO	1	2467160000

Note

connectPower PROtop

connectPower PROtop

- 3-phase power supplies

PRO TOP3 960W 48V 20A CO

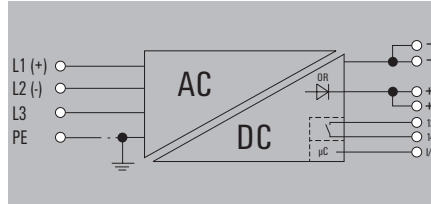

Technical data

Input	
Rated input voltage	
Input voltage range AC	
Frequency range AC	
DC input voltage range	
Input fuse (internal) / Inrush current	
Output	
Rated output voltage	
Output voltage	
DCL - peak load reserve	
Residual ripple, breaking spikes	
Reserve capacity @ $U_{Nominal}$	
Nominal output current for U_{nom}	
MTBF	
According to Standard	
Operating time (hours), min.	
Ambient temperature	
Input voltage	
Output power	
Duty cycle	
General data	
Derating	
Series switching capability	
Degree of efficiency	
Power factor (approx.)	
AC failure bridging time @ I_{nom}	
LED green/red	
Parallel connection option	
Depth x width x height	
Net weight	
Approvals	
Approvals	
Connection data	
Connection system	
Number of terminals	
Wire cross-section, rigid min/max	mm ²
Wire cross-section, flexible min/max	mm ²
Wire cross-section, AWG/kcmil min/max	
Note	

3x 400...3x 500 V AC (wide-range input)	
3 x 320...3 x 575 V AC / 2 x 360...2 x 575 V AC	
45...65 Hz	
450...800 V DC (max. 500 V DC acc. to UL508)	
No / Max. 10 A	
48 V DC ± 1 %	
45...56 V adjustable with potentiometer or communication module	
150 % (5 s); 400 % (15 ms)	
< 100 mV ss @ 48 V DC, I Nenn	
130% permanent at ≤ 40°C, 150 % (5 s)	
20 A @ 60 °C	
SN 29500	
1.2Mh	
25°C	
400V	
960W	
100%	
> 60°C (2.5% / 1°C)	
No	
95,3 %	
> 0.75 @ 3x400 V AC	
> 20 ms @ 230 V AC / > 20 ms @ 115 V AC	
Green: Operation (failure-free), Flashing green: advance warning	
I>90%, Green/red flashing: output switched off (switch-off mode),	
Flashing red: overload/error	
yes, max 10	
175 / 89 / 130 mm	
2490 g	
ABS; BURVER; cULus; cULusEX; DETNORVER; EAC; LLOYDSREG; RINA; RS; TUEV	
Input	Output
PUSH IN	PUSH IN
4 for L1/L2/L3/PE	4 (++ / -)
0.75 / 16	0.75 / 2.5
0.75 / 16	0.75 / 16
20 / 4	20 / 4
Note	

Ordering data

Type	Qty.	Order No.
PRO TOP3 960W 48V 20A CO	1	2467180000
Note		

Type	Qty.	Order No.
PRO TOP3 960W 48V 20A CO	1	2467180000
Note		

PROtop DCDC converter with IoT connection – fit for digitalisation

Powerful, efficient, and reliable isolation

PROtop DCDC converters are used for safe electrical isolation to avoid ground loops that can occur when supplying field devices in production or process plants. DCDC converters can be used on long supply lines to refresh the supply voltage.

The integrated ORing MOSFET reliably decouples possible internal short circuits. It allows direct parallel connection of ACDC and DCDC converters of the PROtop series for redundancy purposes or to increase power. This makes the use of the otherwise common diode or redundancy modules obsolete. Furthermore, PROtop DCDC converters feature the powerful DCL technology – and their communication module allows full data transparency and remote control.

Your special advantages:

- Integrated ORing MOSFET for direct parallel connection for redundancy purposes or to increase power
- Thanks to DCL technology, very high peak current reserves for fuse tripping or for powerful motor starts
- Communication interface for complete data transparency and remote control





Fit for the future thanks to IO-LINK
The optional communication modules, which can be retrofitted at any time, create data transparency, and enable automated parameterisation and remote control.



Redundancy without diode modules
The integrated ORing MOSFET allows direct parallel connection for redundancy purposes or to increase power. Diode and redundancy modules are thus obsolete.



Peak current reserves thanks to DCL
The high peak current reserves of up to 600 % nominal current reliably trigger miniature circuit breakers. In addition, the dynamic current limitation DCL offers high peak currents for powerful motor starting

Optimal for:



connectPower PROtop DCDC

connectPower PROtop DCDC

- DCL technology for an excellent dynamic range
- High energy efficiency
- Mode of operation: single or parallel operation and adjustable short-circuit response (continuous current or switch-off)
- Useful life of up to 10 years, MTBF > 1 000 000 h.
- Extremely slim design
- Time-saving PUSH IN connection technology



Derating curve

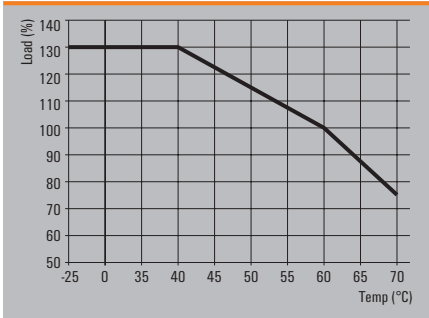

Technical data

General data	
Insulation voltage input / earth	1.41 kV
Insulation voltage output / earth	0.7 kV
Insulation voltage, input/output	1.41 kV
Ambient temperature (operational) / Storage temperature	-25 °C...70 °C / -40 °C...85 °C
Humidity at operating temperature	5...95 %, no condensation
Protection class / Pollution degree	III, with no ground connection, for SELV
Housing version	Metal, corrosion resistant
Mounting position, installation notice	Horizontal on DIN rail TS 35, top and bottom 50 mm clearance for free air flow, 10 mm clearance to neighbouring active subassemblies with full load, 5 mm with passive neighbouring subassemblies, direct row mounting with 90% rated load
Conformal coating	No
EMC / shock / vibration	
Interference immunity test acc. to	EN 55032:2015, EN 55035:2017, EN 61000-6-1:2007, EN 61000-6-2:2005, EN 61000-6-3:2007/A1:2011, EN 61000-6-4:2007/A1:2011, IEC 61000-4-2, IEC 61000-4-3, DIN EN 61000-4-4, EN 61000-4-5:2005, EN 61000-4-6:2008, IEC 61000-4-8
Shock	30 g in all directions
Resistance to vibration	2.3 g (on DIN rail), 4 g (with direct mounting)
Electrical safety (applied standards)	
Electrical machine equipment	Acc. to EN60204
Safety transformers for switch-mode power supplies	According to EN 61558-2-17
For use with electronic equipment	Acc. to EN50178 / VDE0160
Safety extra-low voltage	SELV acc. to IEC 60950-1, PELV according to EN 60204-1
Protective separation / protection against electrical shock	VDE0100-410 / acc. to DIN57100-410
Protection against dangerous shock currents	Acc. to VDE0106-101

connectPower PROtop DCDC

- DC/DC-Wandler

PRO TOPDC 24V/24V 5A

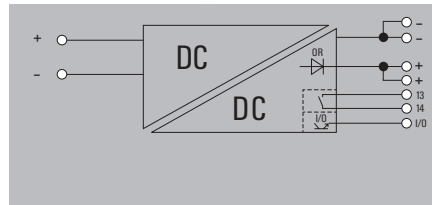

PRO TOPDC 24V/24V 10A

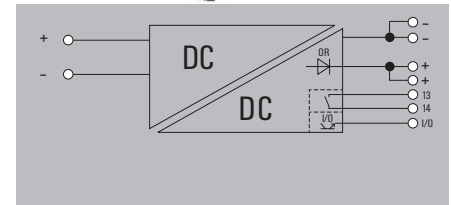

Technical data

Input	
Rated input voltage	24 V DC
Input current	5.7A @ 24V / 7.6A @ 18V
DC input voltage range	14 V...31.2 V (linear Derating from 18 V...14 V, 60% rated load @ U _{in} 14 V)
Input fuse (internal) / Inrush current	Yes / max. 5 A
Output	
Rated output voltage	24 V DC ± 1 %
Output voltage	22.5...28.8 V adjustable with potentiometer or communication module
DCL - peak load reserve	600 % (15 ms); 200 % (5 s)
Residual ripple, breaking spikes	< 40 mV _{pp} @25 °C
Reserve capacity @ U _{Nominal}	130% permanent at ≤ 40°C, 150 % (5 s)
Nominal output current for U _{nom}	5 A @ 60 °C
MTBF	
According to Standard	SN 29500
Operating time (hours), min.	1.02Mh
Ambient temperature	25°C
Input voltage	24V
Output power	480W
Duty cycle	100%
General data	
Derating	> 60°C (2.5% / 1°C)
Series switching capability	Yes
Degree of efficiency	89%
Mains failure bridge-over time	10ms
LED green/red	Green: Operation (failure-free), Flashing green: advance warning >90%, Green/red flashing: output switched off (switch-off mode), Flashing red: overload/error
Parallel connection option	yes, max 10
Depth x width x height	125 / 35 / 130 mm
Net weight	800 g
Approvals	
Approvals	ABS; BURVER; DETNORVER; LLOYDSREG; RINA

Input		Output	
PUSH IN with actuator	PUSH IN with actuator	PUSH IN with actuator	PUSH IN with actuator
2 for (+, -)	4 (++, -)	2 for (+, -)	4 (++, -)
0.5 / 1.5 mm ²	0.2 / 2.5 mm ²	0.5 / 1.5 mm ²	0.2 / 2.5 mm ²
0.5 / 2.5 mm ²	0.2 / 2.5 mm ²	0.5 / 2.5 mm ²	0.2 / 2.5 mm ²
20 / 12	26 / 12	20 / 12	26 / 12

Input		Output	
Rated input voltage	24 V DC	Rated output voltage	24 V DC ± 1 %
Input current	11A @ 24V / 15A @ 18V	Output voltage	22.5...28.8 V adjustable with potentiometer or communication module
DC input voltage range	14 V...31.2 V (linear Derating from 18 V...14 V, 60% rated load @ U _{in} 14 V)	DCL - peak load reserve	600 % (15 ms); 200 % (5 s)
Input fuse (internal) / Inrush current	Yes / Max. 10 A	Residual ripple, breaking spikes	< 40 mV _{pp} @25 °C
Input fuse (internal) / Inrush current	Yes / Max. 10 A	Reserve capacity @ U _{Nominal}	130% permanent at ≤ 40°C, 150 % (5 s)
Input fuse (internal) / Inrush current	Yes / Max. 10 A	Nominal output current for U _{nom}	10 A @ 60 °C
MTBF		MTBF	
According to Standard	SN 29500	According to Standard	SN 29500
Operating time (hours), min.	1.32Mh	Operating time (hours), min.	1.32Mh
Ambient temperature	25°C	Ambient temperature	25°C
Input voltage	24V	Input voltage	24V
Output power	240W	Output power	240W
Duty cycle	100%	Duty cycle	100%
General data		General data	
Derating	> 60°C (2.5% / 1°C)	Derating	> 60°C (2.5% / 1°C)
Series switching capability	Yes	Series switching capability	Yes
Degree of efficiency	91%	Degree of efficiency	91%
Mains failure bridge-over time	10ms	Mains failure bridge-over time	10ms
LED green/red	Green: Operation (failure-free), Flashing green: advance warning >90%, Green/red flashing: output switched off (switch-off mode), Flashing red: overload/error	LED green/red	Green: Operation (failure-free), Flashing green: advance warning >90%, Green/red flashing: output switched off (switch-off mode), Flashing red: overload/error
Parallel connection option	yes, max 10	Parallel connection option	yes, max 10
Depth x width x height	125 / 43 / 130 mm	Depth x width x height	125 / 43 / 130 mm
Net weight	1000 g	Net weight	1000 g
Approvals		Approvals	
Approvals	ABS; BURVER; DETNORVER; LLOYDSREG; RINA	Approvals	ABS; BURVER; DETNORVER; LLOYDSREG; RINA

Connection data	
Connection system	PUSH IN with actuator
Number of terminals	2 for (+, -)
Wire cross-section, rigid min/max	0.5 / 1.5 mm ²
Wire cross-section, flexible min/max	0.5 / 2.5 mm ²
Wire cross-section, AWG/kcmil min/max	20 / 12
Note	

Input		Output	
PUSH IN with actuator	PUSH IN with actuator	PUSH IN with actuator	PUSH IN with actuator
2 for (+, -)	4 (++, -)	2 for (+, -)	4 (++, -)
0.5 / 1.5 mm ²	0.2 / 2.5 mm ²	0.5 / 1.5 mm ²	0.2 / 2.5 mm ²
0.5 / 2.5 mm ²	0.2 / 2.5 mm ²	0.5 / 2.5 mm ²	0.2 / 2.5 mm ²
20 / 12	26 / 12	20 / 12	26 / 12

Input		Output	
PUSH IN with actuator	PUSH IN with actuator	PUSH IN with actuator	PUSH IN with actuator
2 for (+, -)	4 (++, -)	2 for (+, -)	4 (++, -)
0.5 / 1.5 mm ²	0.2 / 2.5 mm ²	0.5 / 1.5 mm ²	0.2 / 2.5 mm ²
0.5 / 2.5 mm ²	0.2 / 2.5 mm ²	0.5 / 2.5 mm ²	0.2 / 2.5 mm ²
20 / 12	26 / 12	20 / 12	26 / 12

Ordering data

Type	Qty.	Order No.
PRO TOPDC 24V/24V 5A	1	2627650000

Type	Qty.	Order No.
PRO TOPDC 24V/24V 5A	1	2627650000

Type	Qty.	Order No.
PRO TOPDC 24V/24V 10A	1	2627640000

Note

Current technical data at catalog.weidmueller.com

Current technical data at catalog.weidmueller.com

connectPower PROtop DCDC

- DC/DC converter

PRO TOPDC 24V/24V 5A EX

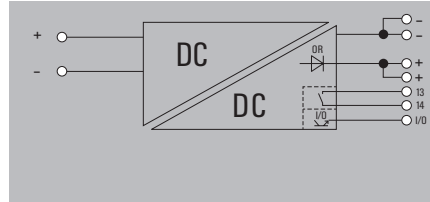

PRO TOPDC 24V/24V 10A EX

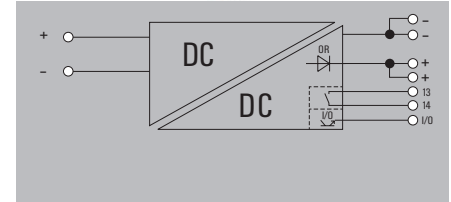

Technical data

Input	
Rated input voltage	24 V DC
Input current	5.7A @ 24V / 7.6A @ 18V
DC input voltage range	14 V...31.2 V (linear Derating from 18 V...14 V, 60% rated load @ U _{in} 14 V)
Input fuse (internal) / Inrush current	Yes / max. 5 A
Output	
Rated output voltage	24 V DC ± 1 %
Output voltage	22.5...28.8 V adjustable with potentiometer or communication module
DCL - peak load reserve	600 % (15 ms); 200 % (5 s)
Residual ripple, breaking spikes	< 40 mV _{pp} @25 °C
Reserve capacity @ U _{Nominal}	130% permanent at ≤ 40°C, 150 % (5 s)
Nominal output current for U _{nom}	5 A @ 60 °C
MTBF	
According to Standard	SN 29500
Operating time (hours), min.	2.21Mh
Ambient temperature	25°C
Input voltage	24V
Output power	120W
Duty cycle	100%
General data	
Derating	> 60°C (2.5% / 1°C)
Series switching capability	Yes
Degree of efficiency	89%
Mains failure bridge-over time	10ms
LED green/red	Green: Operation (failure-free), Flashing green: advance warning >90%, Green/red flashing: output switched off (switch-off mode), Flashing red: overload/error
Parallel connection option	yes, max 10
Depth x width x height	125 / 35 / 130 mm
Net weight	800 g
Approvals	
Approvals	ABS; BURVER; DETNORVER; LLOYDSREG; RINA; UKEX

Input		Output	
Screw connection	2 for (+, -)	Clamping yoke connection	4 (++, --)
Number of terminals	2 for (+, -)	Clamping yoke connection	4 (++, --)
Wire cross-section, rigid min/max	0.2 / 4 mm ²	Clamping yoke connection	0.2 / 4
Wire cross-section, flexible min/max	0.2 / 4 mm ²	Clamping yoke connection	0.2 / 4
Wire cross-section, AWG/kcmil min/max	30 / 12	Clamping yoke connection	30 / 12

Input		Output	
Rated input voltage	24 V DC	Rated output voltage	24 V DC ± 1 %
Input current	11A @ 24V / 15A @ 18V	Output voltage	22.5...28.8 V adjustable with potentiometer or communication module
DC input voltage range	14 V...31.2 V (linear Derating from 18 V...14 V, 60% rated load @ U _{in} 14 V)	DCL - peak load reserve	600 % (15 ms); 200 % (5 s)
Input fuse (internal) / Inrush current	Yes / Max. 10 A	Residual ripple, breaking spikes	< 40 mV _{pp} @25 °C
Input fuse (internal) / Inrush current	Yes / Max. 10 A	Reserve capacity @ U _{Nominal}	130% permanent at ≤ 40°C, 150 % (5 s)
Input fuse (internal) / Inrush current	Yes / Max. 10 A	Nominal output current for U _{nom}	10 A @ 60 °C
MTBF		MTBF	
According to Standard	SN 29500	According to Standard	SN 29500
Operating time (hours), min.	1.32Mh	Operating time (hours), min.	1.32Mh
Ambient temperature	25°C	Ambient temperature	25°C
Input voltage	24V	Input voltage	24V
Output power	240W	Output power	240W
Duty cycle	100%	Duty cycle	100%
General data		General data	
Derating	> 60°C (2.5% / 1°C)	Derating	> 60°C (2.5% / 1°C)
Series switching capability	Yes	Series switching capability	Yes
Degree of efficiency	91%	Degree of efficiency	91%
Mains failure bridge-over time	10ms	Mains failure bridge-over time	10ms
LED green/red	Green: Operation (failure-free), Flashing green: advance warning >90%, Green/red flashing: output switched off (switch-off mode), Flashing red: overload/error	LED green/red	Green: Operation (failure-free), Flashing green: advance warning >90%, Green/red flashing: output switched off (switch-off mode), Flashing red: overload/error
Parallel connection option	yes, max 10	Parallel connection option	yes, max 10
Depth x width x height	125 / 43 / 130 mm	Depth x width x height	125 / 43 / 130 mm
Net weight	1000 g	Net weight	1000 g
Approvals		Approvals	
Approvals	ABS; BURVER; DETNORVER; LLOYDSREG; RINA; UKEX	Approvals	ABS; BURVER; DETNORVER; LLOYDSREG; RINA; UKEX

Connection data	
Connection system	Screw connection
Number of terminals	2 for (+, -)
Wire cross-section, rigid min/max	0.2 / 4 mm ²
Wire cross-section, flexible min/max	0.2 / 4 mm ²
Wire cross-section, AWG/kcmil min/max	30 / 12
Note	

Input		Output	
Screw connection	2 for (+, -)	Clamping yoke connection	4 (++, --)
Number of terminals	2 for (+, -)	Clamping yoke connection	4 (++, --)
Wire cross-section, rigid min/max	0.2 / 4 mm ²	Clamping yoke connection	0.2 / 4
Wire cross-section, flexible min/max	0.2 / 4 mm ²	Clamping yoke connection	0.2 / 4
Wire cross-section, AWG/kcmil min/max	30 / 12	Clamping yoke connection	30 / 12

Input		Output	
Screw connection	2 for (+, -)	Clamping yoke connection	4 (++, --)
Number of terminals	2 for (+, -)	Clamping yoke connection	4 (++, --)
Wire cross-section, rigid min/max	0.2 / 4 mm ²	Clamping yoke connection	0.2 / 4
Wire cross-section, flexible min/max	0.2 / 4 mm ²	Clamping yoke connection	0.2 / 4
Wire cross-section, AWG/kcmil min/max	30 / 12	Clamping yoke connection	30 / 12

Ordering data

Type	Qty.	Order No.
PRO TOPDC 24V/24V 5A EX	1	2467290000

Type	Qty.	Order No.
PRO TOPDC 24V/24V 5A EX	1	2467290000

Type	Qty.	Order No.
PRO TOPDC 24V/24V 10A EX	1	2467300000

Note

Current technical data at catalog.weidmuller.com

Current technical data at catalog.weidmuller.com

connectPower PROtop DCDC

connectPower PROtop DCDC

- DC/DC converter

PRO TOPDC 24V/24V 20A EX

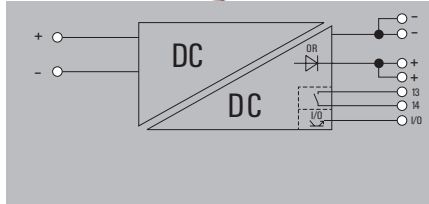

Technical data

Input

Rated input voltage
Input current
DC input voltage range

Input fuse (internal) / Inrush current

Output

Rated output voltage
Output voltage

DCL - peak load reserve
Residual ripple, breaking spikes
Reserve capacity @ $U_{Nominal}$
Nominal output current for U_{nom}

MTBF

According to Standard
Operating time (hours), min.
Ambient temperature
Input voltage
Output power
Duty cycle

General data

Derating
Series switching capability
Degree of efficiency
Mains failure bridge-over time
LED green/red

Parallel connection option

Depth x width x height
Net weight

Approvals

Approvals

Connection data

Connection system
Number of terminals
Wire cross-section, rigid min/max mm²
Wire cross-section, flexible min/max mm²
Wire cross-section, AWG/kcmil min/max

Note

24 V DC

22A @ 24V / 30A @ 18V
14 V...31.2 V (linear Derating from 18 V...14 V, 60% rated load @ U_{in} 14 V)
Yes / max. 15 A

24 V DC \pm 1 %
22.5...28.8 V adjustable with potentiometer or communication module

500 % (15 ms); 200 % (5 s)
< 40 mV_{pp}@25 °C
130% permanent at \leq 40°C, 150 % (5 s)
20 A @ 60 °C

SN 29500
1.02Mh
25°C
24V
480W
100%

> 60°C (2.5% / 1°C)
Yes
91%
10ms
Green: Operation (failure-free), Flashing green: advance warning
>90%, Green/red flashing: output switched off (switch-off mode),
Flashing red: overload/error

yes, max 10
125 / 75 / 130 mm
1746 g

ABS; BURVER; DETNORVER; LLOYDSREG; RINA; UKEX

Input	Output
Screw connection	Clamping yoke connection
2 for (+, -)	4 (++ / -)
0.18 / 6	0.2 / 6
0.22 / 4	0.5 / 6
26 / 10	24 / 8

Ordering data

Type	Qty.	Order No.
PRO TOPDC 24V/24V 20A EX	1	2467310000

Note

Current technical data at catalog.weidmuller.com

PROtop UW power supplies with ultra wide input voltage range

Use only one device for all the mains voltages

An increasing number of machines are being used worldwide. PROtop UW power supply units can be operated on all mains voltages in the world – both on single- and three-phase mains and DC supply networks. The units allow direct parallel connection for redundancy or power increase.

The fully electronic input circuit of our UW power supplies with an ultra-wide input voltage range of 85 – 550 V AC or 90 – 800 V DC allows operation on all supply networks in the world. Device classes up to 240 W ensure the basic supply of small to medium control systems. The integrated ORing MOSFETs of the PROtop family allow direct parallel connection to increase performance as well as the design of redundant power supply systems.

Your special advantages:

- Ultra-wide input voltage range for operation in supply networks worldwide
- Integrated ORing MOSFETs for direct parallel connection for redundancy purposes or to increase power
- DCL technology for high peak current reserves for fuse tripping or motor starts
- Communication interface for data transparency and remote control

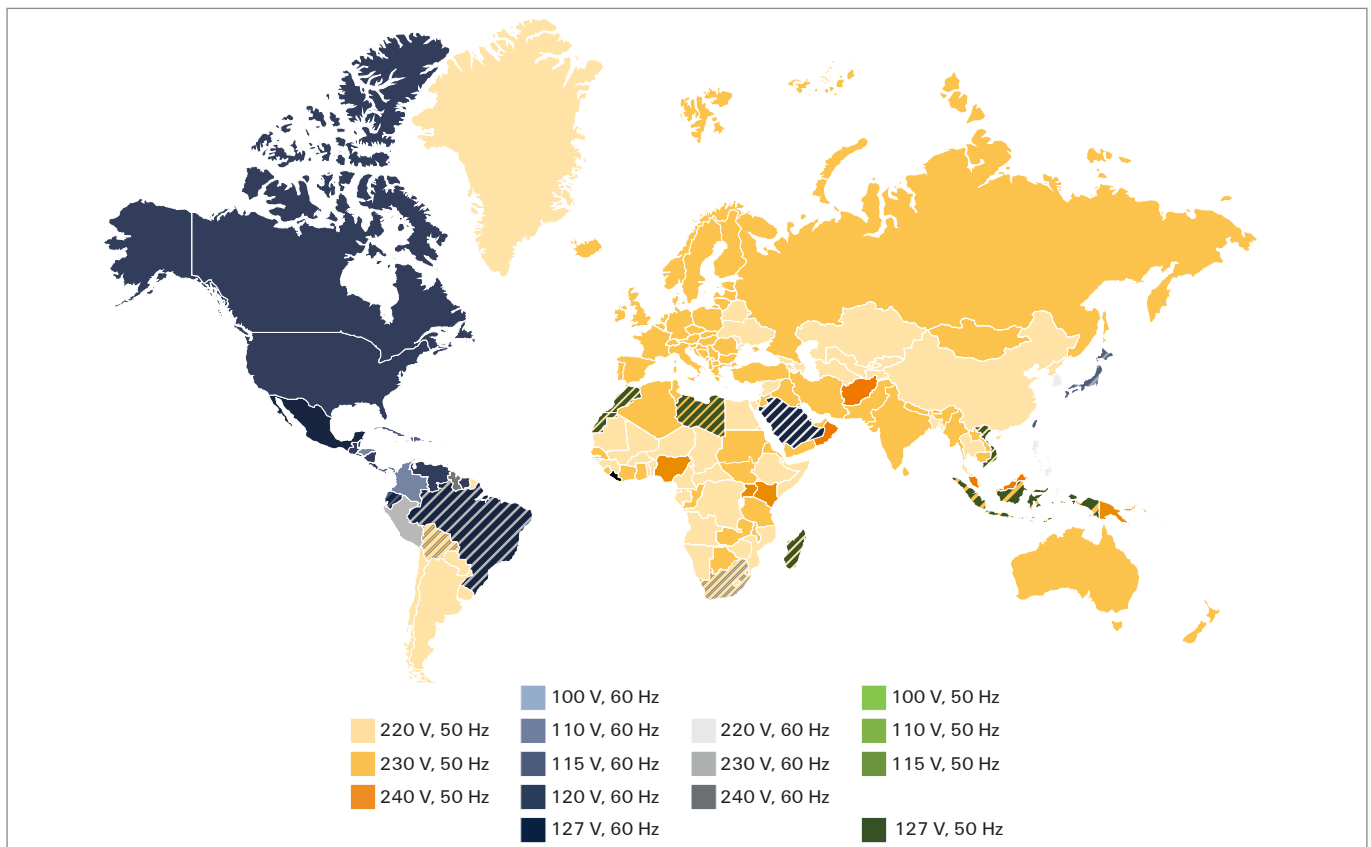

Countries with a cross-hatched colour pattern have different supply voltages between the colour-coded voltage supplies.



Operation on all networks worldwide
 The fully electronic input stage of the UW power supply units enables continuous operation on single- and three-phase mains supplies of 85 – 550 V AC as well as operation on DC mains supplies of 90 – 800 V DC.



Direct parallel connection
 The integrated ORing MOSFETs enable direct parallel connection for power increase or redundancy without any diode modules.



Fit for the future thanks to IO-LINK
 The optional communication modules, which can be retrofitted at any time, ensure data transparency, allow automated parameterization, and enable remote control.



Peak current reserves thanks to DCL
 High peak current reserves of up to 600 % nominal current reliably trigger miniature circuit breakers. In addition, the dynamic current limitation DCL enables high peak currents for powerful motor starts.

Optimal for:

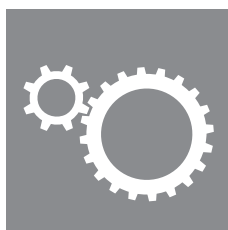

connectPower PROtop UW

connectPower PROtop2 UW

- DCL technology for an excellent dynamic range
- High energy efficiency
- Mode of operation: single or parallel operation and adjustable short-circuit response (continuous current or switch-off)
- Useful life of up to 10 years, MTBF > 1 000 000 h.
- Extremely slim design



Derating curve

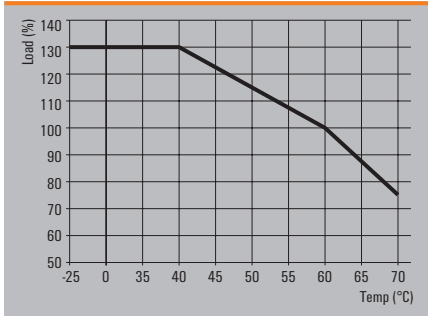

Technical data

General data	
Insulation voltage input / earth	3.2 kV
Insulation voltage output / earth	0.5 kV
Insulation voltage, input/output	3.5 kV
Earth leakage current, max.	3.5 mA
Ambient temperature (operational) / Storage temperature	-40 °C...75 °C / -40 °C...85 °C
Humidity at operating temperature	5...100 % no condensation
Protection class / Pollution degree	I, with PE connection / 2
Housing version	Metal, corrosion resistant
Mounting position, installation notice	Horizontal on DIN rail TS 35, top and bottom 50 mm clearance for free air flow, 10 mm clearance to neighbouring active subassemblies with full load, 5 mm with passive neighbouring subassemblies, direct row mounting with 90% rated load
EMC / shock / vibration	
Interference immunity test acc. to	EN 55032:2015, EN 61000-3-2:2019, EN 61000-6-3:2007/A1:2011, EN 61000-6-4:2007/A1:2011, EN 61000-3-3:2013+A1:2019, EN 55035:2017, EN 61000-6-1:2019, EN 61000-6-2:2019, IEC 61000-4-2:2008, IEC 61000-4-3:2006+A1:2007+A2:2010, IEC 61000-4-4:2012, IEC 61000-4-5:2014, IEC 61000-4-6:2013, IEC 61000-4-8:2009, IEC 61000-4-11:2004
Shock	30 g in all directions
Resistance to vibration	2.3 g (on DIN rail), 4 g (with direct mounting)
Electrical safety (applied standards)	
Electrical machine equipment	Acc. to EN60335-1
Safety transformers for switch-mode power supplies	According to EN 61558-2-17
Safety extra-low voltage	SELV acc. to IEC 60950-1, PELV according to EN 60204-1
Protective separation / protection against electrical shock	VDE0100-410 / acc. to DIN57100-410
Protection against dangerous shock currents	Acc. to VDE0106-101

connectPower PROtop2 UW

PRO TOP2 120W 24V 5A UW

PRO TOP2 240W 24V 10A UW

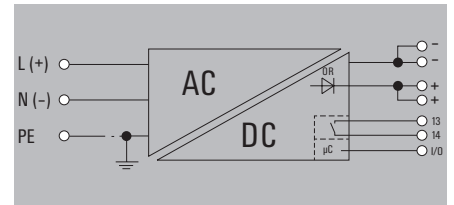
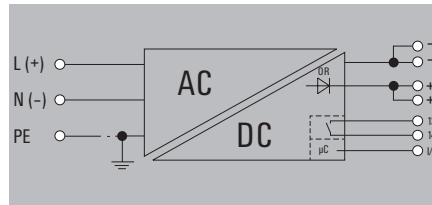

Technical data

Input	
Rated input voltage	100 - 500 V AC / 120 - 500 V DC
Input voltage range AC	85...550 V AC
Frequency range AC	45...65 Hz
DC input voltage range	90...800 V DC
Input fuse (internal) / Inrush current	Yes / max. 5 A
Output	
Rated output voltage	24 V DC ± 1 %
Output voltage	22.5...28.8 V adjustable with potentiometer or communication module
DCL - peak load reserve	600 % (12 ms)
Residual ripple, breaking spikes	< 50 mVss @ U _{Nom} , Full Load
Reserve capacity @ U _{Nominal}	130% permanent at ≤ 40°C, 150 % (5 s)
Nominal output current for U _{nom}	5 A @ 60 °C
MTBF	
According to Standard	SN 29500
Operating time (hours), min.	1.58Mh
Ambient temperature	25°C
Input voltage	230V
Output power	120W
Duty cycle	100%
General data	
Derating	> 60°C (2.5% / 1°C)
Series switching capability	Yes
Degree of efficiency	89%
Power factor (approx.)	> 0.8 @ 230 V AC, > 0.6 @ 400 V AC
Mains failure bridge-over time, min.	20ms
LED green/red	Green: Operation (failure-free), Flashing green: advance warning >90%, Green/red flashing: output switched off (switch-off mode), Flashing red: overload/error
Parallel connection option	yes, max 10
Depth x width x height	125 / 39 / 130 mm
Net weight	920 g
Conformal coating	No
Approvals	
Approvals	CE; UKCA; ABS; DNV; LR; RINA; TUEV; CCSAUS; BV
Connection data	
Connection system	PUSH IN with actuator
Number of terminals	3 for L/N/PE
Wire cross-section, rigid min/max	0.5 / 2.5 mm ²
Wire cross-section, flexible min/max	0.5 / 2.5 mm ²
Wire cross-section, AWG/kcmil min/max	26 / 12
Note	

Input		Output	
Rated input voltage	100 - 500 V AC / 120 - 500 V DC	Rated output voltage	24 V DC ± 1 %
Input voltage range AC	85...550 V AC	Output voltage	22.5...28.8 V adjustable with potentiometer or communication module
Frequency range AC	45...65 Hz	DCL - peak load reserve	600 % (12 ms)
DC input voltage range	90...800 V DC	Residual ripple, breaking spikes	< 50 mVss @ U _{Nom} , Full Load
Input fuse (internal) / Inrush current	Yes / max. 5 A	Reserve capacity @ U _{Nominal}	130% permanent at ≤ 40°C, 150 % (5 s)
Rated output voltage	24 V DC ± 1 %	Nominal output current for U _{nom}	5 A @ 60 °C
Output voltage	22.5...28.8 V adjustable with potentiometer or communication module	MTBF	SN 29500
DCL - peak load reserve	600 % (12 ms)	Operating time (hours), min.	1.58Mh
Residual ripple, breaking spikes	< 50 mVss @ U _{Nom} , Full Load	Ambient temperature	25°C
Reserve capacity @ U _{Nominal}	130% permanent at ≤ 40°C, 150 % (5 s)	Input voltage	230V
Nominal output current for U _{nom}	5 A @ 60 °C	Output power	120W
MTBF	SN 29500	Duty cycle	100%
Operating time (hours), min.	1.58Mh	General data	
Ambient temperature	25°C	Derating	> 60°C (2.5% / 1°C)
Input voltage	230V	Series switching capability	Yes
Output power	120W	Degree of efficiency	89%
Duty cycle	100%	Power factor (approx.)	> 0.8 @ 230 V AC, > 0.6 @ 400 V AC
LED green/red	Green: Operation (failure-free), Flashing green: advance warning >90%, Green/red flashing: output switched off (switch-off mode), Flashing red: overload/error	Mains failure bridge-over time, min.	20ms
Parallel connection option	yes, max 10	LED green/red	Green: Operation (failure-free), Flashing green: advance warning >90%, Green/red flashing: output switched off (switch-off mode), Flashing red: overload/error
Depth x width x height	125 / 39 / 130 mm	Parallel connection option	yes, max 10
Net weight	920 g	Depth x width x height	125 / 50 / 130 mm
Conformal coating	No	Net weight	1050 g
Approvals	CE; UKCA; ABS; DNV; LR; RINA; TUEV; CCSAUS; BV	Conformal coating	No
Connection system	PUSH IN with actuator	Approvals	CE; UKCA; ABS; DNV; LR; RINA; TUEV; CCSAUS; BV
Number of terminals	3 for L/N/PE	Connection system	PUSH IN with actuator
Wire cross-section, rigid min/max	0.5 / 2.5 mm ²	Number of terminals	4 (++ / -)
Wire cross-section, flexible min/max	0.5 / 2.5 mm ²	Wire cross-section, rigid min/max	0.5 / 2.5
Wire cross-section, AWG/kcmil min/max	26 / 12	Wire cross-section, flexible min/max	0.2 / 2.5
Note		Wire cross-section, AWG/kcmil min/max	20 / 12

Input		Output	
Rated input voltage	100 - 500 V AC / 120 - 500 V DC	Rated output voltage	24 V DC ± 1 %
Input voltage range AC	85...550 V AC	Output voltage	22.5...28.8 V adjustable with potentiometer or communication module
Frequency range AC	45...65 Hz	DCL - peak load reserve	600 % (12 ms)
DC input voltage range	90...800 V DC	Residual ripple, breaking spikes	< 50 mVss @ U _{Nom} , Full Load
Input fuse (internal) / Inrush current	Yes / Max. 10 A	Reserve capacity @ U _{Nominal}	130% permanent at ≤ 40°C, 150 % (5 s)
Rated output voltage	24 V DC ± 1 %	Nominal output current for U _{nom}	10 A @ 60 °C
Output voltage	22.5...28.8 V adjustable with potentiometer or communication module	MTBF	SN 29500
DCL - peak load reserve	600 % (12 ms)	Operating time (hours), min.	1.4Mh
Residual ripple, breaking spikes	< 50 mVss @ U _{Nom} , Full Load	Ambient temperature	25°C
Reserve capacity @ U _{Nominal}	130% permanent at ≤ 40°C, 150 % (5 s)	Input voltage	230V
Nominal output current for U _{nom}	10 A @ 60 °C	Output power	240W
MTBF	SN 29500	Duty cycle	100%
Operating time (hours), min.	1.4Mh	General data	
Ambient temperature	25°C	Derating	> 60°C (2.5% / 1°C)
Input voltage	230V	Series switching capability	Yes
Output power	240W	Degree of efficiency	91.5%
Duty cycle	100%	Power factor (approx.)	> 0.8 @ 230 V AC, > 0.6 @ 400 V AC
LED green/red	Green: Operation (failure-free), Flashing green: advance warning >90%, Green/red flashing: output switched off (switch-off mode), Flashing red: overload/error	Mains failure bridge-over time, min.	20ms
Parallel connection option	yes, max 10	LED green/red	Green: Operation (failure-free), Flashing green: advance warning >90%, Green/red flashing: output switched off (switch-off mode), Flashing red: overload/error
Depth x width x height	125 / 50 / 130 mm	Parallel connection option	yes, max 10
Net weight	1050 g	Depth x width x height	125 / 50 / 130 mm
Conformal coating	No	Net weight	1050 g
Approvals	CE; UKCA; ABS; DNV; LR; RINA; TUEV; CCSAUS; BV	Conformal coating	No
Connection system	PUSH IN with actuator	Approvals	CE; UKCA; ABS; DNV; LR; RINA; TUEV; CCSAUS; BV
Number of terminals	3 for L/N/PE	Connection system	PUSH IN with actuator
Wire cross-section, rigid min/max	0.5 / 2.5 mm ²	Number of terminals	4 (++ / -)
Wire cross-section, flexible min/max	0.5 / 2.5 mm ²	Wire cross-section, rigid min/max	0.5 / 2.5
Wire cross-section, AWG/kcmil min/max	26 / 12	Wire cross-section, flexible min/max	0.2 / 2.5
Note		Wire cross-section, AWG/kcmil min/max	20 / 12

Ordering data

Type	Qty.	Order No.
PRO TOP2 120W 24V 5A UW	1	2467230000

Type	Qty.	Order No.
PRO TOP2 240W 24V 10A UW	1	2467250000

Type	Qty.	Order No.
PRO TOP2 240W 24V 10A UW	1	2467250000

Note

connectPower PROtop UW

connectPower PROtop2 UW

- 1-phase power supplies with wide voltage input

PRO TOP2 120W 24V 5A UW EX

PRO TOP2 240W 24V 10A UW EX

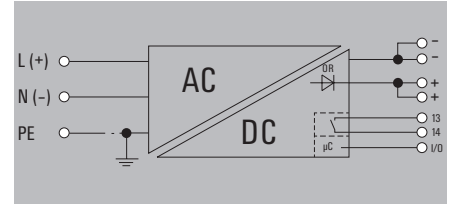
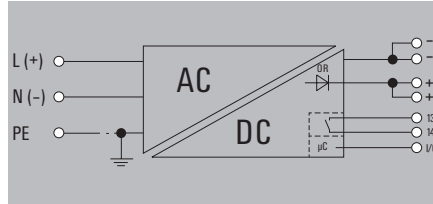
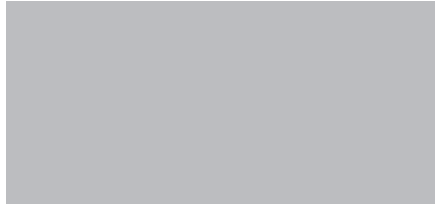

Technical data

Input	
Rated input voltage	100 - 500 V AC / 120 - 500 V DC
Input voltage range AC	85...550 V AC
Frequency range AC	45...65 Hz
DC input voltage range	90...800 V DC
Input fuse (internal) / Inrush current	Yes / max. 5 A
Output	
Rated output voltage	24 V DC ± 1 %
Output voltage	22.5...28.8 V adjustable with potentiometer or communication module
DCL - peak load reserve	600 % (12 ms)
Residual ripple, breaking spikes	< 50 mVss @ U _{Nom} , Full Load
Reserve capacity @ U _{Nominal}	130% permanent at ≤ 40°C, 150 % (5 s)
Nominal output current for U _{Nom}	5 A @ 60 °C
MTBF	
According to Standard	SN 29500
Operating time (hours), min.	1.58Mh
Ambient temperature	25°C
Input voltage	230V
Output power	120W
Duty cycle	100%
General data	
Derating	> 60°C (2.5% / 1°C)
Series switching capability	Yes
Degree of efficiency	89%
Power factor (approx.)	> 0.8 @ 230 V AC, > 0.6 @ 400 V AC
Mains failure bridge-over time, min.	20ms
LED green/red	Green: Operation (failure-free), Flashing green: advance warning >90%, Green/red flashing: output switched off (switch-off mode), Flashing red: overload/error
Parallel connection option	yes, max 10
Depth x width x height	125 / 39 / 130 mm
Net weight	892 g
Conformal coating	Yes
Approvals	
Approvals	CE; UKCA; IECEX; ATEX; ABS; BV; DNV; LR; RINA; TUEV; CCSAUS
Connection data	
Connection system	Clamping yoke connection
Number of terminals	3 for L/N/PE
Wire cross-section, rigid min/max	0.2 / 4 mm ²
Wire cross-section, flexible min/max	0.2 / 4 mm ²
Wire cross-section, AWG/kcmil min/max	30 / 12
Note	

Input		Output	
Rated input voltage	100 - 500 V AC / 120 - 500 V DC	Rated output voltage	24 V DC ± 1 %
Input voltage range AC	85...550 V AC	Output voltage	22.5...28.8 V adjustable with potentiometer or communication module
Frequency range AC	45...65 Hz	DCL - peak load reserve	600 % (12 ms)
DC input voltage range	90...800 V DC	Residual ripple, breaking spikes	< 50 mVss @ U _{Nom} , Full Load
Input fuse (internal) / Inrush current	Yes / max. 5 A	Reserve capacity @ U _{Nominal}	130% permanent at ≤ 40°C, 150 % (5 s)
Rated output voltage	24 V DC ± 1 %	Nominal output current for U _{Nom}	5 A @ 60 °C
Output voltage	22.5...28.8 V adjustable with potentiometer or communication module	MTBF	SN 29500
DCL - peak load reserve	600 % (12 ms)	Operating time (hours), min.	1.58Mh
Residual ripple, breaking spikes	< 50 mVss @ U _{Nom} , Full Load	Ambient temperature	25°C
Reserve capacity @ U _{Nominal}	130% permanent at ≤ 40°C, 150 % (5 s)	Input voltage	230V
Nominal output current for U _{Nom}	5 A @ 60 °C	Output power	120W
MTBF	SN 29500	Duty cycle	100%
Operating time (hours), min.	1.58Mh	General data	> 60°C (2.5% / 1°C)
Ambient temperature	25°C	Derating	> 60°C (2.5% / 1°C)
Input voltage	230V	Series switching capability	Yes
Output power	120W	Degree of efficiency	89%
Duty cycle	100%	Power factor (approx.)	> 0.8 @ 230 V AC, > 0.6 @ 400 V AC
General data	> 60°C (2.5% / 1°C)	Mains failure bridge-over time, min.	20ms
Derating	> 60°C (2.5% / 1°C)	LED green/red	Green: Operation (failure-free), Flashing green: advance warning >90%, Green/red flashing: output switched off (switch-off mode), Flashing red: overload/error
Series switching capability	Yes	Parallel connection option	yes, max 10
Degree of efficiency	89%	Depth x width x height	125 / 39 / 130 mm
Power factor (approx.)	> 0.8 @ 230 V AC, > 0.6 @ 400 V AC	Net weight	892 g
Mains failure bridge-over time, min.	20ms	Conformal coating	Yes
LED green/red	Green: Operation (failure-free), Flashing green: advance warning >90%, Green/red flashing: output switched off (switch-off mode), Flashing red: overload/error	Approvals	CE; UKCA; IECEX; ATEX; ABS; BV; DNV; LR; RINA; TUEV; CCSAUS
Parallel connection option	yes, max 10	Connection data	Clamping yoke connection
Depth x width x height	125 / 39 / 130 mm	Number of terminals	3 for L/N/PE
Net weight	892 g	Wire cross-section, rigid min/max	0.2 / 4 mm ²
Conformal coating	Yes	Wire cross-section, flexible min/max	0.2 / 4 mm ²
Approvals	CE; UKCA; IECEX; ATEX; ABS; BV; DNV; LR; RINA; TUEV; CCSAUS	Wire cross-section, AWG/kcmil min/max	30 / 12
Connection data	Clamping yoke connection	Note	
Number of terminals	4 (++ / -)		
Wire cross-section, rigid min/max	0.2 / 4		
Wire cross-section, flexible min/max	0.2 / 4		
Wire cross-section, AWG/kcmil min/max	30 / 12		

Input		Output	
Rated input voltage	100 - 500 V AC / 120 - 500 V DC	Rated output voltage	24 V DC ± 1 %
Input voltage range AC	85...550 V AC	Output voltage	22.5...28.8 V adjustable with potentiometer or communication module
Frequency range AC	45...65 Hz	DCL - peak load reserve	600 % (12 ms)
DC input voltage range	90...800 V DC	Residual ripple, breaking spikes	< 50 mVss @ U _{Nom} , Full Load
Input fuse (internal) / Inrush current	Yes / Max. 10 A	Reserve capacity @ U _{Nominal}	130% permanent at ≤ 40°C, 150 % (5 s)
Rated output voltage	24 V DC ± 1 %	Nominal output current for U _{Nom}	10 A @ 60 °C
Output voltage	22.5...28.8 V adjustable with potentiometer or communication module	MTBF	SN 29500
DCL - peak load reserve	600 % (12 ms)	Operating time (hours), min.	1.4Mh
Residual ripple, breaking spikes	< 50 mVss @ U _{Nom} , Full Load	Ambient temperature	25°C
Reserve capacity @ U _{Nominal}	130% permanent at ≤ 40°C, 150 % (5 s)	Input voltage	230V
Nominal output current for U _{Nom}	10 A @ 60 °C	Output power	240W
MTBF	SN 29500	Duty cycle	100%
Operating time (hours), min.	1.4Mh	General data	> 60°C (2.5% / 1°C)
Ambient temperature	25°C	Derating	> 60°C (2.5% / 1°C)
Input voltage	230V	Series switching capability	Yes
Output power	240W	Degree of efficiency	91.5%
Duty cycle	100%	Power factor (approx.)	> 0.8 @ 230 V AC, > 0.6 @ 400 V AC
General data	> 60°C (2.5% / 1°C)	Mains failure bridge-over time, min.	20ms
Derating	> 60°C (2.5% / 1°C)	LED green/red	Green: Operation (failure-free), Flashing green: advance warning >90%, Green/red flashing: output switched off (switch-off mode), Flashing red: overload/error
Series switching capability	Yes	Parallel connection option	yes, max 10
Degree of efficiency	91.5%	Depth x width x height	125 / 50 / 130 mm
Power factor (approx.)	> 0.8 @ 230 V AC, > 0.6 @ 400 V AC	Net weight	1060 g
Mains failure bridge-over time, min.	20ms	Conformal coating	Yes
LED green/red	Green: Operation (failure-free), Flashing green: advance warning >90%, Green/red flashing: output switched off (switch-off mode), Flashing red: overload/error	Approvals	CE; UKCA; IECEX; ATEX; ABS; BV; DNV; LR; RINA; TUEV; CCSAUS
Parallel connection option	yes, max 10	Connection data	Clamping yoke connection
Depth x width x height	125 / 50 / 130 mm	Number of terminals	4 (++ / -)
Net weight	1060 g	Wire cross-section, rigid min/max	0.2 / 4 mm ²
Conformal coating	Yes	Wire cross-section, flexible min/max	0.2 / 4 mm ²
Approvals	CE; UKCA; IECEX; ATEX; ABS; BV; DNV; LR; RINA; TUEV; CCSAUS	Wire cross-section, AWG/kcmil min/max	30 / 12
Connection data	Clamping yoke connection	Note	
Number of terminals	4 (++ / -)		
Wire cross-section, rigid min/max	0.2 / 4		
Wire cross-section, flexible min/max	0.2 / 4		
Wire cross-section, AWG/kcmil min/max	30 / 12		

Ordering data

Type	Qty.	Order No.
PRO TOP2 120W 24V 5A UW EX	1	2467240000

Type	Qty.	Order No.
PRO TOP2 120W 24V 5A UW EX	1	2467240000

Type	Qty.	Order No.
PRO TOP2 240W 24V 10A UW EX	1	2467260000

Note

Current technical data at catalog.weidmuller.com

Note

connectPower PROtop2 UW

- 1-phase power supplies with wide voltage input

PRO TOP2 240W 48V 5A UW

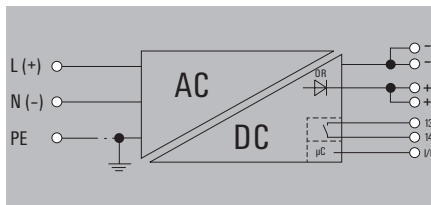

Technical data

Input	
Rated input voltage	100 - 500 V AC / 120 - 500 V DC
Input voltage range AC	85...550 V AC
Frequency range AC	45...65 Hz
DC input voltage range	90...800 V DC
Input fuse (internal) / Inrush current	Yes / Max. 10 A
Output	
Rated output voltage	48 V DC ± 1 %
Output voltage	45...56 V adjustable with potentiometer or communication module
DCL - peak load reserve	600 % (12 ms)
Residual ripple, breaking spikes	< 100 mVss @ U _{Nom} , Full Load
Reserve capacity @ U _{Nominal}	130% permanent at ≤ 40°C, 150 % (5 s)
Nominal output current for U _{Nom}	5 A @ 60 °C
MTBF	
According to Standard	Telcordia SR-332
Operating time (hours), min.	2.6kh
Ambient temperature	25°C
Input voltage	230V
Output power	240W
Duty cycle	100%
General data	
Derating	> 60°C (2.5% / 1°C)
Series switching capability	No
Degree of efficiency	91.5%
Power factor (approx.)	> 0.8 @ 230 V AC, > 0.6 @ 400 V AC
Mains failure bridge-over time, min.	20ms
LED green/red	Green: Operation (failure-free), Flashing green: advance warning I>90%, Green/red flashing: output switched off (switch-off mode), Flashing red: overload/error
Parallel connection option	yes, max 10
Depth x width x height	125 / 50 / 130 mm
Net weight	892 g
Conformal coating	No
Approvals	
Approvals	CE; UKCA; ABS; DNV; LR; RINA; TUEV; CCSAUS; BV
Connection data	
Connection system	PUSH IN with actuator
Number of terminals	3 for L/N/PE
Wire cross-section, rigid min/max	0.5 / 2.5
Wire cross-section, flexible min/max	0.2 / 2.5
Wire cross-section, AWG/kcmil min/max	26 / 12
Note	

Input	Output
PUSH IN with actuator	PUSH IN with actuator
3 for L/N/PE	4 (++ / -)
0.5 / 2.5	0.2 / 2.5
0.5 / 2.5	0.2 / 2.5
26 / 12	20 / 12

Ordering data

Type	Qty.	Order No.
PRO TOP2 240W 48V 5A UW	1	2467270000
Note		

Type	Qty.	Order No.
PRO TOP2 240W 48V 5A UW	1	2467270000
Note		

connectPower PROtop - Accessories

Small metal foot



Type	Order No.
MTA 30 MF	1251320000

Large metal foot



Type	Order No.
MTA 45 MF	1251310000

Small plastic foot



Type	Order No.
MTA 30 BK	1168970000

Large plastic foot



Type	Order No.
MTA 45 BK	1962250000

Small wall mounting



Type	Order No.
CP A WALLADAPTER 30 MM	1461870000

Large wall mounting



Type	Order No.
CP A WALLADAPTER 45 MM	1461850000

Small screwdriver

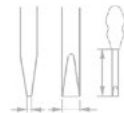

Type	Size/AF	a	b	c	Order No.
SDIK PH 1 X 80				80	2749890000
SDIS 0.5X3.0X100		0,5	3	100	2749800000

Markers



Type	Colour	Qty.	Order No.
SM 18/9.5 K MC NE WS	white	200	1248580000

End bracket

For DIN rail TS 35

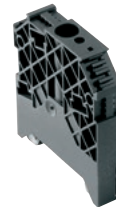

Polyamide with fibre glass, screwable	Colour	Torque	Qty.	Order No.
WEW 35/1 SW	black	1.2 Nm	50	1162600000

Powerful power supply for machines and systems

PROmax offers flexible solutions for ambitious automation

A Power supplies for large systems and machines are particularly challenging. Failures caused by device defects impact the entire production line and can result in high costs.

Our high performance and durable PROmax switched-mode power supply units are designed for demanding requirements. Continuous overload of up to 120 % or transient peak loads of 300 % are easy for PROmax to handle.

High boost capability and full power are also enabled over a wide temperature range. Our switched-mode power supply units can be used around the world and are also suitable for tight spaces thanks to their narrow width.



High boost capability for all industrial systems

Whether in large machines and plants, in power engineering or even in light process systems: Thanks to their high boost capability, the space-saving housing geometries, the wide temperature range and the numerous approvals, our PROmax switched-mode power supply units can be used for universal applications and anywhere in the world.

Robust and reliable supply

MTBF values exceeding 500,000 hours and a wide temperature range of -25 °C to +70 °C ensure reliable supply of the systems. Start-up temperatures of -40 °C make the PROmax particularly robust.

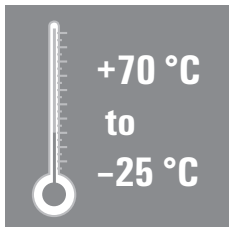

Space-saving width

With extremely small width and direct side-by-side fitting, minimal space is required on the DIN rail.



Universal application

Variants with 3 A to 40 A output current, output voltages of 5 V DC to 48 V DC and numerous approvals (e.g. GL, UL, Class I, Div. 2) enable universal application solutions the world over.



Powerful

Continuous output power of up to 120 % at temperatures up to +45 °C and high output peaks up to 300 % ensure safe operation, also at the limits.

Robust Input

With an AC input voltage range of up to 277 V in single-phase devices and SEMI F47, PROmax is extremely robust.

connectPower PROmax

connectPower PROmax



Derating curve

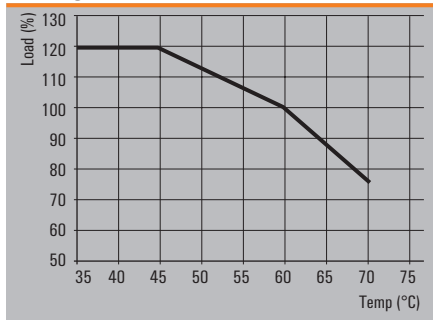

Permitted continuous limit currents [A]

Typ \ Temp.	45 °C	50 °C	55 °C	60 °C	65 °C	70 °C
1ph 24 V / 3 A	3,6	3,3	3,2	3	2,6	2,2
1ph 24 V / 5 A	6	5,7	5,4	5	4,4	3,8
1ph 24 V / 7,5 A	9	8,5	8	7,5	6,6	5,6
1ph 24 V / 10 A	12	11,3	10,7	10	8,8	7,5
1ph 24 V / 20 A	24	22,6	21,4	20	17,6	15
1ph 24 V / 40 A	48	45,2	42,8	40	35,2	30
1ph 5 V / 14 A	16,8	15,8	15	14	12,3	10,5
1ph 12 V / 6 A	7,2	6,8	6,4	6	5,3	4,5
1ph 12 V / 10 A	12	11,3	10,7	10	8,8	7,5
1ph 48 V / 5 A	6	5,7	5,4	5	4,4	3,8
1ph 48 V / 10 A	12	11,3	10,7	10	8,8	7,5
1ph 48 V / 20 A	24	22,6	21,4	20	17,6	15
3ph 24 V / 5 A	6	5,7	5,4	5	4,4	3,8
3ph 24 V / 10 A	12	11,3	10,7	10	8,8	7,5
3ph 24 V / 20 A	24	22,6	21,4	20	17,6	15
3ph 24 V / 40 A	48	45,2	42,8	40	35,2	30

Technical data

General data	
Current limiting	> 120% I _n
Insulation voltage input / earth	3.5 kV
Insulation voltage output / earth	0.5 kV
Insulation voltage, input/output	4 kV
Earth leakage current, max.	3.5 mA
Series switching capability	Yes
Ambient temperature (operational) / Storage temperature / Start-up	-25 °C...70 °C / -40 °C...85 °C / ≥ -40 °C
Humidity at operating temperature	5...95 %, no condensation
Protection class / Pollution degree	I, with PE connection / 2
Housing version	Metal, corrosion resistant
Status indication	LED red/green and relay (≥21.6 V DC LED green, relay on/ ≤20.6 LED red, relay off)
Mounting position, installation notice	Horizontal on TS35 mounting rail. 50 mm of clearance at top & bottom for air circ. Can mount side by side with no space in between.
EMC / shock / vibration	
Interference immunity test acc. to	EN 55024, EN 55032, IEC61000-3-2,-3, IEC61000-4-2,-3,-4,-5,-6,-8,-11
Shock	30 g in all directions
Resistance to vibration	2.3 g
Electrical safety (applied standards)	
Electrical machine equipment	Acc. to EN60204
Safety transformers for switch-mode power supplies	According to EN 61558-2-16
For use with electronic equipment	Acc. to EN50178 / VDE0160
Protective separation / protection against electrical shock	VDE0100-410 / acc. to DIN57100-410
Protection against dangerous shock currents	Acc. to VDE0106-101

connectPower PROmax

PRO MAX 72W 24V 3A

PRO MAX 120W 24V 5A

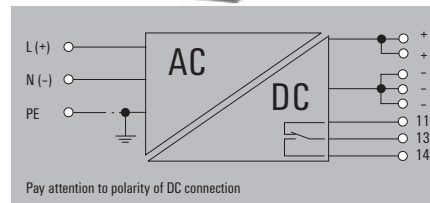
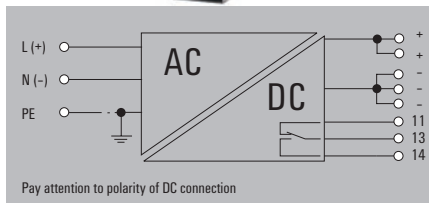

Technical data

Input
Rated input voltage
Input voltage range AC
Frequency range AC
DC input voltage range
AC current consumption
DC current consumption
Input fuse (internal) / Inrush current
Recommended back-up fuse

100...240 V AC
85...277 V AC
45...65 Hz
80...370 V DC
1 A @ 230 V AC / 1.5 A @ 115 V AC
1A @ 370 VDC / 1,5A @ 120 VDC
Yes / max. 15 A
6 A, Char. B, circuit breaker, 3 - 5 A, char. C, circuit breaker

100...240 V AC
85...277 V AC
45...65 Hz
80...370 V DC
1A @ 230 VAC / 2,5A @ 115 VAC
1,5A @ 370 VDC / 2,5A @ 120 VDC
Yes / max. 15 A
6 A, Char. B, circuit breaker, 6 A, char. C circuit breaker

Output
Rated output voltage
Output voltage
Residual ripple, breaking spikes
Nominal output current for I_{nom}
Continuous output current @ $U_{Nominal}$
Reserve capacity @ $U_{Nominal}$
Current capacity (pulse) @ $U_{Nominal}$

24 V DC \pm 1 %
22.5...29.5 V (adjustable via potentiometer)
< 50 mVss @ U_{Nomin} , Full Load
3 A @ 60 °C
3,6 A @ 45°C, 2,25 A @ 70°C
3.6 A (1 min), 4.5 A (4s)
9 A (2ms)

24 V DC \pm 1 %
22.5...29.5 V (adjustable via potentiometer)
< 50 mVss @ U_{Nomin} , Full Load
5 A @ 60 °C
6.0 A @ 45 °C, 3,75 A @ 70 °C
6 A (1 min), 7.5 A (4s)
15 A (2ms)

MTBF
According to Standard
Operating time (hours), min.
Ambient temperature
Input voltage
Output power
Duty cycle

SN 29500
1.7Mh
25°C
230V
72W
100%

SN 29500
1.5Mh
25°C
230V
120W
100%

General data
Degree of efficiency
Power factor (approx.)
AC failure bridging time @ I_{nom}
Protection against reverse voltages from the load
Parallel connection option
Depth x width x height
Net weight

89%
> 0.90 @ 230 V AC
min. 20 ms
30...35 V DC
yes, max. 5
125 / 32 / 130 mm
650 g

89%
> 0.90 @ 230 V AC
min. 20 ms
30...35 V DC
yes, max. 5
125 / 40 / 130 mm
858 g

Approvals
Approvals

CE; cULus; cULusEX; cURus; DETNORVER; EAC; TUEV

CE; cULus; cULusEX; cURus; DETNORVER; EAC; TUEV

Connection data	
Connection system	
Number of terminals	
Wire cross-section, rigid min/max	mm ²
Wire cross-section, flexible min/max	mm ²
Wire cross-section, AWG/kcmil min/max	
Screwdriver blade	

Input	Output
Screw connection	Screw connection
3 for L/N/PE	8 (++,-,11,13,14)
0.18 / 6	0.5 / 6
0.22 / 4	0.5 / 4
26 / 10	26 / 12
0.8 x 4.0, PZ 1	0.6 x 3.5

Input	Output
Screw connection	Screw connection
3 for L/N/PE	8 (++,-,11,13,14)
0.18 / 6	0.5 / 6
0.22 / 4	0.5 / 4
26 / 10	26 / 12
0.8 x 4.0, PZ 1	0.6 x 3.5

Note

Ordering data

Type	Qty.	Order No.
PRO MAX 72W 24V 3A	1	1478100000

Type	Qty.	Order No.
PRO MAX 72W 24V 3A	1	1478100000

Type	Qty.	Order No.
PRO MAX 120W 24V 5A	1	1478110000

Note

The internal varistor found in a switch-mode power supply does not replace the need for surge protection within a system.

The internal varistor found in a switch-mode power supply does not replace the need for surge protection within a system.

connectPower PROmax

connectPower PROmax

PRO MAX 180W 24V 7,5A

PRO MAX 240W 24V 10A

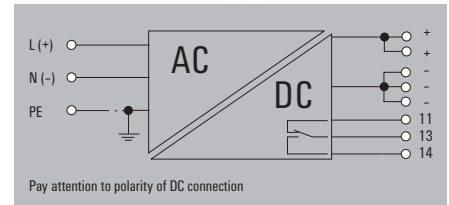
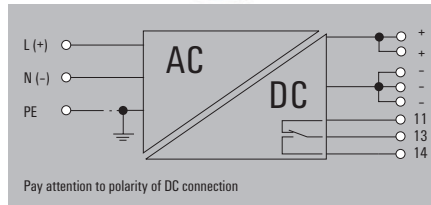

Technical data

Input	
Rated input voltage	100...240 V AC
Input voltage range AC	85...277 V AC
Frequency range AC	45...65 Hz
DC input voltage range	80...370 V DC
AC current consumption	1 A @ 230 V AC / 2 A @ 115 V AC
DC current consumption	1A @ 370 VDC / 2A @ 120 VDC
Input fuse (internal) / Inrush current	Yes / max. 15 A
Recommended back-up fuse	10 A, Char. B circuit breaker, 6...8 A, char. C circuit breaker
Output	
Rated output voltage	24 V DC ± 1 %
Output voltage	22.5...29.5 V (adjustable via potentiometer)
Residual ripple, breaking spikes	< 50 mVss @ U _{Nom} , Full Load
Nominal output current for U _{Nom}	7,5 A @ 60 °C
Continuous output current @ U _{Nominal}	9 A @ 45°C, 5,6 A @ 70°C
Reserve capacity @ U _{Nominal}	9 A (1 min), 11.25 A (4s)
Current capacity (pulse) @ U _{Nominal}	22,5 A (2ms)
MTBF	
According to Standard	SN 29500
Operating time (hours), min.	1.4Mh
Ambient temperature	25°C
Input voltage	230V
Output power	180W
Duty cycle	100%
General data	
Degree of efficiency	91.5%
Power factor (approx.)	> 0.95 @ 230 V AC
AC failure bridging time @ I _{nom}	min. 20 ms
Protection against reverse voltages from the load	30...35 V DC
Parallel connection option	yes, max. 5
Depth x width x height	125 / 50 / 130 mm
Net weight	950 g
Approvals	
Approvals	CE; cULus; cULusEX; cURus; DETNORVER; EAC; TUEV
Connection data	
Connection system	Screw connection
Number of terminals	3 for L/N/PE
Wire cross-section, rigid min/max	0.18 / 6 mm ²
Wire cross-section, flexible min/max	0.22 / 4 mm ²
Wire cross-section, AWG/kcmil min/max	26 / 10
Screwdriver blade	0.8 x 4.0, PZ 1
Note	
Ordering data	
Note	

Input		Output	
Rated input voltage	100...240 V AC	Rated output voltage	24 V DC ± 1 %
Input voltage range AC	85...277 V AC	Output voltage	22.5...29.5 V (adjustable via potentiometer)
Frequency range AC	45...65 Hz	Residual ripple, breaking spikes	< 50 mVss @ U _{Nom} , Full Load
DC input voltage range	80...370 V DC	Nominal output current for U _{Nom}	7,5 A @ 60 °C
AC current consumption	1 A @ 230 V AC / 2 A @ 115 V AC	Continuous output current @ U _{Nominal}	9 A @ 45°C, 5,6 A @ 70°C
DC current consumption	1A @ 370 VDC / 2A @ 120 VDC	Reserve capacity @ U _{Nominal}	9 A (1 min), 11.25 A (4s)
Input fuse (internal) / Inrush current	Yes / max. 15 A	Current capacity (pulse) @ U _{Nominal}	22,5 A (2ms)
Recommended back-up fuse	10 A, Char. B circuit breaker, 6...8 A, char. C circuit breaker		
Input		Output	
Connection system	Screw connection	Rated output voltage	24 V DC ± 1 %
Number of terminals	3 for L/N/PE	Output voltage	22.5...29.5 V (adjustable via potentiometer)
Wire cross-section, rigid min/max	0.18 / 6 mm ²	Residual ripple, breaking spikes	< 50 mVss @ U _{Nom} , Full Load
Wire cross-section, flexible min/max	0.22 / 4 mm ²	Nominal output current for U _{Nom}	10 A @ 60 °C
Wire cross-section, AWG/kcmil min/max	26 / 10	Continuous output current @ U _{Nominal}	12 A @ 45°C, 7,5 A @ 70°C
Screwdriver blade	0.8 x 4.0, PZ 1	Reserve capacity @ U _{Nominal}	12 A (1 min), 15 A (4s)
		Current capacity (pulse) @ U _{Nominal}	30 A (2ms)
Type		Type	
PRO MAX 180W 24V 7,5A	Qty. 1	PRO MAX 240W 24V 10A	Qty. 1
	Order No. 1478120000		Order No. 1478130000
Note		Note	

Input		Output	
Rated input voltage	100...240 V AC	Rated output voltage	24 V DC ± 1 %
Input voltage range AC	85...277 V AC	Output voltage	22.5...29.5 V (adjustable via potentiometer)
Frequency range AC	45...65 Hz	Residual ripple, breaking spikes	< 50 mVss @ U _{Nom} , Full Load
DC input voltage range	80...370 V DC	Nominal output current for U _{Nom}	10 A @ 60 °C
AC current consumption	1.5 A @ 230 V AC / 3 A @ 115 V AC	Continuous output current @ U _{Nominal}	12 A @ 45°C, 7,5 A @ 70°C
DC current consumption	1,5A @ 370 VDC / 3A @ 120 VDC	Reserve capacity @ U _{Nominal}	12 A (1 min), 15 A (4s)
Input fuse (internal) / Inrush current	Yes / max. 15 A	Current capacity (pulse) @ U _{Nominal}	30 A (2ms)
Recommended back-up fuse	10 A, Char. B circuit breaker, 6...8 A, char. C circuit breaker		
Input		Output	
Connection system	Screw connection	Rated output voltage	24 V DC ± 1 %
Number of terminals	3 for L/N/PE	Output voltage	22.5...29.5 V (adjustable via potentiometer)
Wire cross-section, rigid min/max	0.18 / 6 mm ²	Residual ripple, breaking spikes	< 50 mVss @ U _{Nom} , Full Load
Wire cross-section, flexible min/max	0.22 / 4 mm ²	Nominal output current for U _{Nom}	10 A @ 60 °C
Wire cross-section, AWG/kcmil min/max	26 / 10	Continuous output current @ U _{Nominal}	12 A @ 45°C, 7,5 A @ 70°C
Screwdriver blade	0.8 x 4.0, PZ 1	Reserve capacity @ U _{Nominal}	12 A (1 min), 15 A (4s)
		Current capacity (pulse) @ U _{Nominal}	30 A (2ms)
Type		Type	
PRO MAX 240W 24V 10A	Qty. 1	PRO MAX 240W 24V 10A	Qty. 1
	Order No. 1478130000		Order No. 1478130000
Note		Note	

connectPower PROmax

PRO MAX 480W 24V 20A

PRO MAX 960W 24V 40A

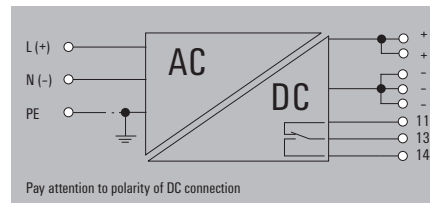
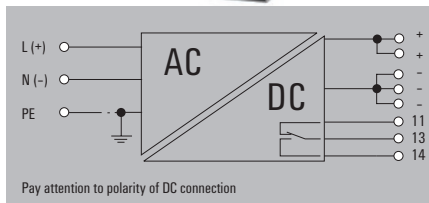

Technical data

Input

Rated input voltage
 Input voltage range AC
 Frequency range AC
 DC input voltage range
 AC current consumption
 DC current consumption
 Input fuse (internal) / Inrush current
 Recommended back-up fuse

100...240 V AC
 85...277 V AC
 45...65 Hz
 80...370 V DC
 2,3A @ 230 VAC / 4,8A @ 115 VAC
 1,5A @ 370 VDC / 4,8A @ 120 VDC
 Yes / max. 15 A
 16 A, char. B circuit breaker, 10 A, Char. C circuit breaker

100...240 V AC
 85...277 V AC
 45...65 Hz
 80...370 V DC
 4,52A @ 230 VAC / 10A @ 115 VAC
 2,8A @ 370 VDC / 10A @ 120 VDC
 Yes / max. 15 A
 20 A, char. B circuit breaker, 16 A, char. C, circuit breaker

Output

Rated output voltage
 Output voltage
 Residual ripple, breaking spikes
 Nominal output current for U_{nom}
 Continuous output current @ $U_{Nominal}$
 Reserve capacity @ $U_{Nominal}$
 Current capacity (pulse) @ $U_{Nominal}$

24 V DC \pm 1 %
 22.5...29.5 V (adjustable via potentiometer)
 < 50 mVss @ U_{Nemo} , Full Load
 20 A @ 60 °C
 24 A @ 45°C, 15 A @ 70°C
 24 A (1 min), 30 A (4s), 100...240 V AC
 60 A (2ms)

24 V DC \pm 1 %
 22.5...29.5 V (adjustable via potentiometer)
 < 50 mVss @ U_{Nemo} , Full Load
 40 A @ 60 °C
 48 A @ 45°C, 30 A @ 70°C
 48 A (1 min), 60 A (4s), 100...240 V AC
 120 A (2ms)

MTBF

According to Standard
 Operating time (hours), min.
 Ambient temperature
 Input voltage
 Output power
 Duty cycle

SN 29500
 827kh
 25°C
 230V
 480W
 100%

SN 29500
 539kh
 25°C
 230V
 960W
 100%

General data

Degree of efficiency
 Power factor (approx.)
 AC failure bridging time @ I_{nom}
 Protection against reverse voltages from the load
 Parallel connection option
 Depth x width x height
 Net weight

92 %
 > 0.95 @ 230 V AC
 min. 20 ms
 30...35 V DC
 yes, max. 3
 150 / 90 / 130 mm
 2000 g

93%
 > 0.95 @ 230 V AC
 min. 20 ms
 30...35 V DC
 yes, max. 3
 150 / 140 / 130 mm
 3900 g

Approvals

Approvals

CE; cULus; cULusEX; cURus; DETNORVER; EAC; TUEV

CE; cULus; cULusEX; cURus; DETNORVER; EAC; TUEV

Connection data

Connection system
 Number of terminals
 Wire cross-section, rigid min/max mm²
 Wire cross-section, flexible min/max mm²
 Wire cross-section, AWG/kcmil min/max
 Screwdriver blade

Input	Output
Screw connection	Screw connection
3 for L/N/PE	8 (++,--,11,13,14)
0.18 / 6	0.18 / 6
0.22 / 4	0.22 / 4
26 / 10	26 / 10
0.8 x 4.0, PZ 1	0.8 x 4.0, PZ 1

Input	Output
Screw connection	Screw connection
3 for L/N/PE	8 (++,--,11,13,14)
0.18 / 6	0.5 / 16
0.22 / 4	0.5 / 16
26 / 10	22 / 8
0.8 x 4.0, PZ 1	1.0 x 5.5

Note

Ordering data

Type	Qty.	Order No.
PRO MAX 480W 24V 20A	1	1478140000

Type	Qty.	Order No.
PRO MAX 480W 24V 20A	1	1478140000

Type	Qty.	Order No.
PRO MAX 960W 24V 40A	1	1478150000

Note

The internal varistor found in a switch-mode power supply does not replace the need for surge protection within a system.

The internal varistor found in a switch-mode power supply does not replace the need for surge protection within a system.

connectPower PROmax

connectPower PROmax

PRO MAX 70W 5V 14A

PRO MAX 72W 12V 6A

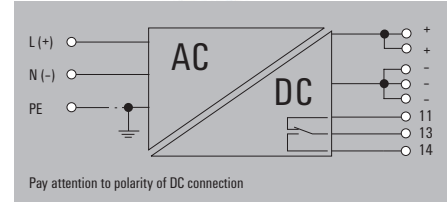
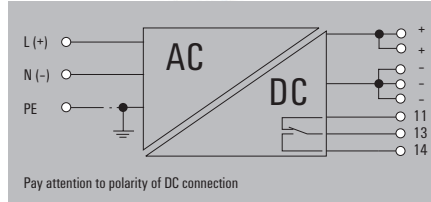

Technical data

Input	
Rated input voltage	100...240 V AC
Input voltage range AC	85...277 V AC
Frequency range AC	45...65 Hz
DC input voltage range	80...370 V DC
AC current consumption	1 A @ 230 V AC / 1.5 A @ 115 V AC
DC current consumption	1A @ 370 VDC / 1,5A @ 120 VDC
Input fuse (internal) / Inrush current	Yes / max. 15 A
Recommended back-up fuse	6 A, Char. B, circuit breaker, 3 - 5 A, char. C, circuit breaker

Rated output voltage	5 V DC
Output voltage	4.5...7 V (adjustable via potentiometer)
Residual ripple, breaking spikes	< 50 mVss @ U _{Nom} , Full Load
Nominal output current for U _{Nom}	14 A @ 60°C
Continuous output current @ U _{Nominal}	16,8 A @ 45°C, 10,5 A @ 70°C
Reserve capacity @ U _{Nominal}	16.8 A (1 min), 21 A (4s)
Current capacity (pulse) @ U _{Nominal}	42 A (2ms)

Rated output voltage	12 V DC ± 1 %
Output voltage	10...15 V (adjustable via potentiometer)
Residual ripple, breaking spikes	< 50 mVss @ U _{Nom} , Full Load
Nominal output current for U _{Nom}	6 A @ 60°C
Continuous output current @ U _{Nominal}	7.2 A @ 45°C, 4.5 A @ 70°C
Reserve capacity @ U _{Nominal}	7.2 A (1 min), 9 A (4s)
Current capacity (pulse) @ U _{Nominal}	18 A (2ms)

Output	
Rated output voltage	5 V DC
Output voltage	4.5...7 V (adjustable via potentiometer)
Residual ripple, breaking spikes	< 50 mVss @ U _{Nom} , Full Load
Nominal output current for U _{Nom}	14 A @ 60°C
Continuous output current @ U _{Nominal}	16,8 A @ 45°C, 10,5 A @ 70°C
Reserve capacity @ U _{Nominal}	16.8 A (1 min), 21 A (4s)
Current capacity (pulse) @ U _{Nominal}	42 A (2ms)

Rated output voltage	12 V DC ± 1 %
Output voltage	10...15 V (adjustable via potentiometer)
Residual ripple, breaking spikes	< 50 mVss @ U _{Nom} , Full Load
Nominal output current for U _{Nom}	6 A @ 60°C
Continuous output current @ U _{Nominal}	7.2 A @ 45°C, 4.5 A @ 70°C
Reserve capacity @ U _{Nominal}	7.2 A (1 min), 9 A (4s)
Current capacity (pulse) @ U _{Nominal}	18 A (2ms)

Rated output voltage	12 V DC ± 1 %
Output voltage	10...15 V (adjustable via potentiometer)
Residual ripple, breaking spikes	< 50 mVss @ U _{Nom} , Full Load
Nominal output current for U _{Nom}	6 A @ 60°C
Continuous output current @ U _{Nominal}	7.2 A @ 45°C, 4.5 A @ 70°C
Reserve capacity @ U _{Nominal}	7.2 A (1 min), 9 A (4s)
Current capacity (pulse) @ U _{Nominal}	18 A (2ms)

MTBF	
According to Standard	SN 29500
Operating time (hours), min.	1.4Mh
Ambient temperature	25°C
Input voltage	230V
Output power	70W
Duty cycle	100%

According to Standard	SN 29500
Operating time (hours), min.	1.4Mh
Ambient temperature	25°C
Input voltage	230V
Output power	70W
Duty cycle	100%

According to Standard	SN 29500
Operating time (hours), min.	1.5Mh
Ambient temperature	25°C
Input voltage	230V
Output power	72W
Duty cycle	100%

General data	
Degree of efficiency	86%
Power factor (approx.)	> 0.90 @ 230 V AC
AC failure bridging time @ I _{nom}	min. 20 ms
Protection against reverse voltages from the load	> 7.5 V DC
Parallel connection option	yes, max. 5
Depth x width x height	125 / 32 / 130 mm
Net weight	650 g

Degree of efficiency	86%
Power factor (approx.)	> 0.90 @ 230 V AC
AC failure bridging time @ I _{nom}	min. 20 ms
Protection against reverse voltages from the load	> 7.5 V DC
Parallel connection option	yes, max. 5
Depth x width x height	125 / 32 / 130 mm
Net weight	650 g

Degree of efficiency	89%
Power factor (approx.)	> 0.90 @ 230 V AC
AC failure bridging time @ I _{nom}	min. 20 ms
Protection against reverse voltages from the load	> 18 V DC
Parallel connection option	yes, max. 5
Depth x width x height	125 / 32 / 130 mm
Net weight	650 g

Approvals	
Approvals	CE; cULus; cULusEX; cURus; DETNORVER; EAC; TUEV

Approvals	CE; cULus; cULusEX; cURus; DETNORVER; EAC; TUEV
-----------	---

Approvals	CE; cULus; cULusEX; cURus; DETNORVER; EAC; TUEV
-----------	---

Connection data	
Connection system	Screw connection
Number of terminals	3 for L/N/PE
Wire cross-section, rigid min/max	0.18 / 6 mm ²
Wire cross-section, flexible min/max	0.22 / 4 mm ²
Wire cross-section, AWG/kcmil min/max	26 / 10
Screwdriver blade	0.8 x 4.0, PZ 1

Input	Output
Screw connection	Screw connection
3 for L/N/PE	8 (++,--,11,13,14)
0.18 / 6	0.5 / 6
0.22 / 4	0.5 / 4
26 / 10	26 / 12
0.8 x 4.0, PZ 1	0.6 x 3.5

Input	Output
Screw connection	Screw connection
3 for L/N/PE	8 (++,--,11,13,14)
0.18 / 6	0.5 / 6
0.22 / 4	0.5 / 4
26 / 10	26 / 12
0.8 x 4.0, PZ 1	0.6 x 3.5

Note	

Note	

Note	

Ordering data

Type	Qty.	Order No.
PRO MAX 70W 5V 14A	1	1478210000

Type	Qty.	Order No.
PRO MAX 70W 5V 14A	1	1478210000

Type	Qty.	Order No.
PRO MAX 72W 12V 6A	1	1478220000

Note	
The internal varistor found in a switch-mode power supply does not replace the need for surge protection within a system.	

Note	
The internal varistor found in a switch-mode power supply does not replace the need for surge protection within a system.	

Note	
The internal varistor found in a switch-mode power supply does not replace the need for surge protection within a system.	

connectPower PROmax

PRO MAX 120W 12V 10A

PRO MAX 240W 48V 5A

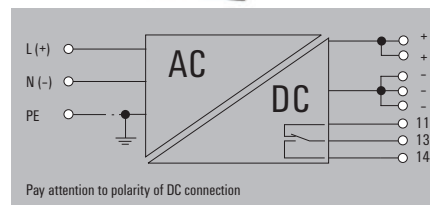
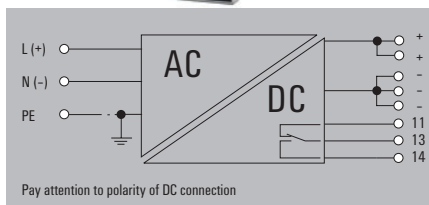

Technical data

Input	
Rated input voltage	100...240 V AC
Input voltage range AC	85...277 V AC
Frequency range AC	45...65 Hz
DC input voltage range	80...370 V DC
AC current consumption	1A @ 230 VAC / 2,5A @ 115 VAC
DC current consumption	1,5A @ 370 VDC / 2,5A @ 120 VDC
Input fuse (internal) / Inrush current	Yes / max. 15 A
Recommended back-up fuse	6 A, Char. B, circuit breaker, 6 A, char. C circuit breaker

Rated output voltage	12 V DC ± 1 %
Output voltage	10...15 V (adjustable via potentiometer)
Residual ripple, breaking spikes	< 50 mVss @ U _{Nom} , Full Load
Nominal output current for U _{Nom}	10 A @ 60 °C
Continuous output current @ U _{Nom}	12 A @ 45°C, 7,5 A @ 70°C
Reserve capacity @ U _{Nom}	12 A (1 min), 15 A (4s)
Current capacity (pulse) @ U _{Nom}	30 A (2ms)

Rated output voltage	48 V DC ± 1 %
Output voltage	30...56 V (adjustable via potentiometer)
Residual ripple, breaking spikes	< 50 mVss @ U _{Nom} , Full Load
Nominal output current for U _{Nom}	5 A @ 60 °C
Continuous output current @ U _{Nom}	6.0 A @ 45 °C, 3,75 A @ 70 °C
Reserve capacity @ U _{Nom}	5 A (1 min), 7,5 A (4s)
Current capacity (pulse) @ U _{Nom}	15 A (2ms)

Output	
Rated output voltage	12 V DC ± 1 %
Output voltage	10...15 V (adjustable via potentiometer)
Residual ripple, breaking spikes	< 50 mVss @ U _{Nom} , Full Load
Nominal output current for U _{Nom}	10 A @ 60 °C
Continuous output current @ U _{Nom}	12 A @ 45°C, 7,5 A @ 70°C
Reserve capacity @ U _{Nom}	12 A (1 min), 15 A (4s)
Current capacity (pulse) @ U _{Nom}	30 A (2ms)

Rated output voltage	48 V DC ± 1 %
Output voltage	30...56 V (adjustable via potentiometer)
Residual ripple, breaking spikes	< 50 mVss @ U _{Nom} , Full Load
Nominal output current for U _{Nom}	5 A @ 60 °C
Continuous output current @ U _{Nom}	6.0 A @ 45 °C, 3,75 A @ 70 °C
Reserve capacity @ U _{Nom}	5 A (1 min), 7,5 A (4s)
Current capacity (pulse) @ U _{Nom}	15 A (2ms)

Rated output voltage	48 V DC ± 1 %
Output voltage	30...56 V (adjustable via potentiometer)
Residual ripple, breaking spikes	< 50 mVss @ U _{Nom} , Full Load
Nominal output current for U _{Nom}	5 A @ 60 °C
Continuous output current @ U _{Nom}	6.0 A @ 45 °C, 3,75 A @ 70 °C
Reserve capacity @ U _{Nom}	5 A (1 min), 7,5 A (4s)
Current capacity (pulse) @ U _{Nom}	15 A (2ms)

MTBF	
According to Standard	SN 29500
Operating time (hours), min.	1.5Mh
Ambient temperature	25°C
Input voltage	230V
Output power	120W
Duty cycle	100%

According to Standard	SN 29500
Operating time (hours), min.	1.5Mh
Ambient temperature	25°C
Input voltage	230V
Output power	120W
Duty cycle	100%

According to Standard	SN 29500
Operating time (hours), min.	1.1Mh
Ambient temperature	25°C
Input voltage	230V
Output power	240W
Duty cycle	100%

General data	
Degree of efficiency	89%
Power factor (approx.)	> 0.90 @ 230 V AC
AC failure bridging time @ I _{nom}	min. 20 ms
Protection against reverse voltages from the load	> 18 V DC
Parallel connection option	yes, max. 5
Depth x width x height	125 / 40 / 130 mm
Net weight	850 g

Degree of efficiency	89%
Power factor (approx.)	> 0.90 @ 230 V AC
AC failure bridging time @ I _{nom}	min. 20 ms
Protection against reverse voltages from the load	> 18 V DC
Parallel connection option	yes, max. 5
Depth x width x height	125 / 40 / 130 mm
Net weight	850 g

Degree of efficiency	92.5%
Power factor (approx.)	> 0.95 @ 230 V AC
AC failure bridging time @ I _{nom}	min. 20 ms
Protection against reverse voltages from the load	> 18 V DC
Parallel connection option	yes, max. 5
Depth x width x height	125 / 60 / 130 mm
Net weight	1050 g

Approvals	
Approvals	CE; cULus; cULusEX; cURus; DETNORVER; EAC; TUEV

Approvals	CE; cULus; cULusEX; cURus; DETNORVER; EAC; TUEV
-----------	---

Approvals	CE; cULus; cULusEX; cURus; DETNORVER; EAC; TUEV
-----------	---

Connection data	
Connection system	Screw connection
Number of terminals	3 for L/N/PE
Wire cross-section, rigid min/max	0.18 / 6 mm ²
Wire cross-section, flexible min/max	0.22 / 4 mm ²
Wire cross-section, AWG/kcmil min/max	26 / 10
Screwdriver blade	0.8 x 4.0, PZ 1

Input	Output
Screw connection	Screw connection
3 for L/N/PE	8 (++,-,11,13,14)
0.18 / 6	0.5 / 6
0.22 / 4	0.5 / 4
26 / 10	26 / 12
0.8 x 4.0, PZ 1	0.6 x 3.5

Input	Output
Screw connection	Screw connection
3 for L/N/PE	8 (++,-,11,13,14)
0.18 / 6	0.18 / 6
0.22 / 4	0.22 / 4
26 / 10	26 / 10
0.8 x 4.0, PZ 1	0.8 x 4.0, PZ 1

Note	

Note	

Note	

Ordering data

Type	Qty.	Order No.
PRO MAX 120W 12V 10A	1	1478230000

Type	Qty.	Order No.
PRO MAX 120W 12V 10A	1	1478230000

Type	Qty.	Order No.
PRO MAX 240W 48V 5A	1	1478240000

Note	
The internal varistor found in a switch-mode power supply does not replace the need for surge protection within a system.	

Note	
The internal varistor found in a switch-mode power supply does not replace the need for surge protection within a system.	

Note	
The internal varistor found in a switch-mode power supply does not replace the need for surge protection within a system.	

connectPower PROmax

connectPower PROmax

PRO MAX 480W 48V 10A

PRO MAX 960W 48V 20A

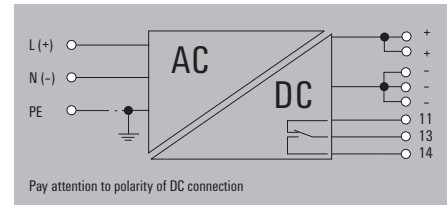
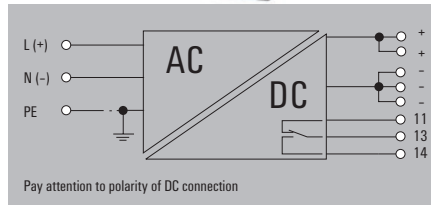

Technical data

Input	
Rated input voltage	100...240 V AC
Input voltage range AC	85...277 V AC
Frequency range AC	45...65 Hz
DC input voltage range	80...370 V DC
AC current consumption	2,3A @ 230 VAC / 4,8A @ 115 VAC
DC current consumption	1,5A @ 370 VDC / 4,8A @ 120 VDC
Input fuse (internal) / Inrush current	Yes / max. 15 A
Recommended back-up fuse	16 A, char. B circuit breaker, 10 A, Char. C circuit breaker

Rated input voltage	100...240 V AC
Input voltage range AC	85...277 V AC
Frequency range AC	45...65 Hz
DC input voltage range	80...370 V DC
AC current consumption	2,3A @ 230 VAC / 4,8A @ 115 VAC
DC current consumption	1,5A @ 370 VDC / 4,8A @ 120 VDC
Input fuse (internal) / Inrush current	Yes / max. 15 A
Recommended back-up fuse	16 A, char. B circuit breaker, 10 A, Char. C circuit breaker

Rated input voltage	100...240 V AC
Input voltage range AC	85...277 V AC
Frequency range AC	45...65 Hz
DC input voltage range	80...370 V DC
AC current consumption	4,52A @ 230 VAC / 10A @ 115 VAC
DC current consumption	2,8A @ 370 VDC / 10A @ 120 VDC
Input fuse (internal) / Inrush current	Yes / max. 15 A
Recommended back-up fuse	20 A, char. B circuit breaker, 16 A, char. C, circuit breaker

Output	
Rated output voltage	48 V DC ± 1 %
Output voltage	30...56 V (adjustable via potentiometer)
Residual ripple, breaking spikes	< 50 mVss @ U _{Nom} , Full Load
Nominal output current for U _{nom}	10 A @ 60 °C
Continuous output current @ U _{Nominal}	12 A @ 45°C, 7,5 A @ 70°C
Reserve capacity @ U _{Nominal}	12 A (1 min), 15 A (4s), 100...240 V AC
Current capacity (pulse) @ U _{Nominal}	60 A (2ms)

Rated output voltage	48 V DC ± 1 %
Output voltage	30...56 V (adjustable via potentiometer)
Residual ripple, breaking spikes	< 50 mVss @ U _{Nom} , Full Load
Nominal output current for U _{nom}	10 A @ 60 °C
Continuous output current @ U _{Nominal}	12 A @ 45°C, 7,5 A @ 70°C
Reserve capacity @ U _{Nominal}	12 A (1 min), 15 A (4s), 100...240 V AC
Current capacity (pulse) @ U _{Nominal}	60 A (2ms)

Rated output voltage	48 V DC ± 1 %
Output voltage	30...56 V (adjustable via potentiometer)
Residual ripple, breaking spikes	< 50 mVss @ U _{Nom} , Full Load
Nominal output current for U _{nom}	20 A @ 60 °C
Continuous output current @ U _{Nominal}	24 A @ 45°C, 15 A @ 70°C
Reserve capacity @ U _{Nominal}	24 A (1 min), 30 A (4s), 100...240 V AC
Current capacity (pulse) @ U _{Nominal}	60 A (2ms)

MTBF	
According to Standard	SN 29500
Operating time (hours), min.	857kh
Ambient temperature	25°C
Input voltage	230V
Output power	480W
Duty cycle	100%

According to Standard	SN 29500
Operating time (hours), min.	857kh
Ambient temperature	25°C
Input voltage	230V
Output power	480W
Duty cycle	100%

According to Standard	SN 29500
Operating time (hours), min.	651kh
Ambient temperature	25°C
Input voltage	230V
Output power	960W
Duty cycle	100%

General data	
Degree of efficiency	93%
Power factor (approx.)	> 0.95 @ 230 V AC
AC failure bridging time @ I _{nom}	min. 20 ms
Protection against reverse voltages from the load	58...65 V DC
Parallel connection option	yes, max. 5
Depth x width x height	150 / 90 / 130 mm
Net weight	2000 g

Degree of efficiency	93%
Power factor (approx.)	> 0.95 @ 230 V AC
AC failure bridging time @ I _{nom}	min. 20 ms
Protection against reverse voltages from the load	58...65 V DC
Parallel connection option	yes, max. 5
Depth x width x height	150 / 90 / 130 mm
Net weight	2000 g

Degree of efficiency	94%
Power factor (approx.)	> 0.95 @ 230 V AC
AC failure bridging time @ I _{nom}	min. 20 ms
Protection against reverse voltages from the load	58...65 V DC
Parallel connection option	yes, max. 5
Depth x width x height	150 / 140 / 130 mm
Net weight	3950 g

Approvals	
Approvals	CE; cULus; cULusEX; cURus; DETNORVER; EAC; TUEV

Approvals	CE; cULus; cULusEX; cURus; DETNORVER; EAC; TUEV
-----------	---

Approvals	CE; cULus; cULusEX; cURus; DETNORVER; EAC; TUEV
-----------	---

Connection data	
Connection system	Screw connection
Number of terminals	3 for L/N/PE
Wire cross-section, rigid min/max	0.18 / 6 mm ²
Wire cross-section, flexible min/max	0.22 / 4 mm ²
Wire cross-section, AWG/kcmil min/max	26 / 10
Screwdriver blade	0.8 x 4.0, PZ 1

Input	Output
Screw connection	Screw connection
3 for L/N/PE	8 (++, --, 11, 13, 14)
0.18 / 6	0.18 / 6
0.22 / 4	0.22 / 4
26 / 10	26 / 10
0.8 x 4.0, PZ 1	0.8 x 4.0, PZ 1

Input	Output
Screw connection	Screw connection
3 for L/N/PE	8 (++, --, 11, 13, 14)
0.18 / 6	0.5 / 16
0.22 / 4	0.5 / 16
26 / 10	22 / 8
0.8 x 4.0, PZ 1	1.0 x 5.5

Note	

Ordering data

Type	Qty.	Order No.
PRO MAX 480W 48V 10A	1	1478250000

Type	Qty.	Order No.
PRO MAX 480W 48V 10A	1	1478250000

Type	Qty.	Order No.
PRO MAX 960W 48V 20A	1	1478270000

Note	

The internal varistor found in a switch-mode power supply does not replace the need for surge protection within a system.

The internal varistor found in a switch-mode power supply does not replace the need for surge protection within a system.

connectPower PROmax

PRO MAX3 120W 24V 5A

PRO MAX3 240W 24V 10A

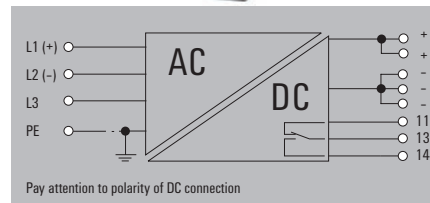
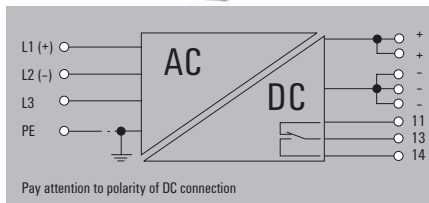

Technical data

Input

Rated input voltage
 Input voltage range AC
 Frequency range AC
 DC input voltage range
 AC current consumption
 DC current consumption
 Input fuse (internal) / Inrush current
 Recommended back-up fuse

3x 400...3x 500 V AC (wide-range input)
 3 x 320...3 x 575 V AC / 2 x 360...2 x 575 V AC
 45...65 Hz
 450...800 V DC (max. 500 V DC acc. to UL508)
 0,28A @ 3*500 VAC / 0,3A @ 3*400 VAC
 0,18 A @ 800 V DC / 0,3 A @ 450 V DC
 Yes / max. 15 A
 2...3 A, char. C circuit breaker

3x 400...3x 500 V AC (wide-range input)
 3 x 320...3 x 575 V AC / 2 x 360...2 x 575 V AC
 45...65 Hz
 450...800 V DC (max. 500 V DC acc. to UL508)
 0,35A @ 3*500 VAC / 0,4A @ 3*400 VAC
 0,35 A @ 800 V DC / 0,6 A @ 450 V DC
 Yes / max. 15 A
 3 - 5 A, char. C, circuit breaker

Output

Rated output voltage
 Output voltage
 Residual ripple, breaking spikes
 Nominal output current for I_{nom}
 Continuous output current @ $U_{Nominal}$
 Reserve capacity @ $U_{Nominal}$
 Current capacity (pulse) @ $U_{Nominal}$

24 V DC \pm 1 %
 22.5...29.5 V (adjustable via potentiometer)
 < 50 mVss @ U_{Nemo} , Full Load
 5 A @ 60 °C
 6,0 A @ 45 °C, 3,75 A @ 70 °C
 6 A (1 min), 7,5 A (4s), 400...500 V AC
 15 A (2ms)

24 V DC \pm 1 %
 22.5...29.5 V (adjustable via potentiometer)
 < 50 mVss @ U_{Nemo} , Full Load
 10 A @ 60 °C
 12 A @ 45°C, 7,5 A @ 70°C
 12 A (1 min), 15 A (4s)
 30 A (2ms)

MTBF

According to Standard
 Operating time (hours), min.
 Ambient temperature
 Input voltage
 Output power
 Duty cycle

SN 29500
 1.7Mh
 25°C
 400V
 120W
 100%

SN 29500
 865kh
 25°C
 400V
 240W
 100%

General data

Degree of efficiency
 Power factor (approx.)
 AC failure bridging time @ I_{nom}
 Protection against reverse voltages from the load
 Parallel connection option
 Depth x width x height
 Net weight

90%
 > 0.50 @ 3x400 V AC
 min. 20 ms
 30...35 V DC
 yes, max. 5
 125 / 40 / 130 mm
 783 g

91.5%
 > 0.85 @ 3*400 V AC
 min. 20 ms
 30...35 V DC
 yes, max. 5
 125 / 60 / 130 mm
 1322 g

Approvals

Approvals

CE; cULus; cULusEX; cURus; DETNORVER; EAC; TUEV

CE; cULus; cULusEX; cURus; DETNORVER; EAC; TUEV

Connection data

Connection system
 Number of terminals
 Wire cross-section, rigid min/max mm²
 Wire cross-section, flexible min/max mm²
 Wire cross-section, AWG/kcmil min/max
 Screwdriver blade

Input	Output
Screw connection	Screw connection
4 for L1/L2/L3/PE	8 (++, --, 11, 13, 14)
0.18 / 6	0.5 / 6
0.22 / 4	0.5 / 4
26 / 10	26 / 12
0.8 x 4.0, PZ 1	0.6 x 3.5

Input	Output
Screw connection	Screw connection
4 for L1/L2/L3/PE	8 (++, --, 11, 13, 14)
0.18 / 6	0.18 / 6
0.22 / 4	0.22 / 4
26 / 10	26 / 10
0.8 x 4.0, PZ 1	0.8 x 4.0, PZ 1

Note

Ordering data

Type	Qty.	Order No.
PRO MAX3 120W 24V 5A	1	1478170000

Type	Qty.	Order No.
PRO MAX3 120W 24V 5A	1	1478170000

Type	Qty.	Order No.
PRO MAX3 240W 24V 10A	1	1478180000

Note

The internal varistor found in a switch-mode power supply does not replace the need for surge protection within a system.

The internal varistor found in a switch-mode power supply does not replace the need for surge protection within a system.

connectPower PROmax

connectPower PROmax

PRO MAX3 480W 24V 20A

PRO MAX3 960W 24V 40A

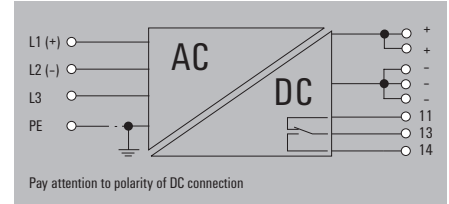
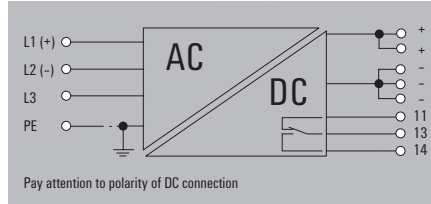

Technical data

Input	
Rated input voltage	3x 400...3x 500 V AC (wide-range input)
Input voltage range AC	3 x 320...3 x 575 V AC / 2 x 360...2 x 575 V AC
Frequency range AC	45...65 Hz
DC input voltage range	450...800 V DC (max. 500 V DC acc. to UL508)
AC current consumption	0,7A @ 3*500 VAC / 0,85 @ 3*400 VAC
DC current consumption	0,7 A @ 800 V DC / 1,2 A @ 450 V DC
Input fuse (internal) / Inrush current	Yes / max. 15 A
Recommended back-up fuse	3 - 5 A, char. C, circuit breaker
Output	
Rated output voltage	24 V DC ± 1 %
Output voltage	22.5...29.5 V (adjustable via potentiometer)
Residual ripple, breaking spikes	< 50 mVss @ U _{Nom} , Full Load
Nominal output current for U _{Nom}	20 A @ 60 °C
Continuous output current @ U _{Nom}	24 A @ 45°C, 15 A @ 70°C
Reserve capacity @ U _{Nom}	24 A (1 min), 30 A (4s)
Current capacity (pulse) @ U _{Nom}	60 A (2ms)
MTBF	
According to Standard	SN 29500
Operating time (hours), min.	642kh
Ambient temperature	25°C
Input voltage	400V
Output power	480W
Duty cycle	100%
General data	
Degree of efficiency	91.5%
Power factor (approx.)	> 0.85 @ 3*400 V AC
AC failure bridging time @ I _{nom}	min. 20 ms
Protection against reverse voltages from the load	30...35 V DC
Parallel connection option	yes, max. 3
Depth x width x height	150 / 70 / 130 mm
Net weight	1600 g
Approvals	
Approvals	CE; cULus; cULusEX; cURus; DETNORVER; EAC; TUEV

Input		Output	
Screw connection		Screw connection	
4 for L1/L2/L3/PE		8 (++, --, 11, 13, 14)	
0.18 / 6		0.18 / 6	
0.22 / 4		0.22 / 4	
26 / 10		26 / 10	
0.8 x 4.0, PZ 1		0.8 x 4.0, PZ 1	

Input		Output	
Screw connection		Screw connection	
4 for L1/L2/L3/PE		8 (++, --, 11, 13, 14)	
0.18 / 6		0.5 / 16	
0.22 / 4		0.5 / 16	
26 / 10		22 / 8	
0.8 x 4.0, PZ 1		1.0 x 5.5	

Connection data	
Connection system	Screw connection
Number of terminals	8 (++, --, 11, 13, 14)
Wire cross-section, rigid min/max	0.18 / 6 mm ²
Wire cross-section, flexible min/max	0.22 / 4 mm ²
Wire cross-section, AWG/kcmil min/max	26 / 10
Screwdriver blade	0.8 x 4.0, PZ 1
Note	

Connection data	
Connection system	Screw connection
Number of terminals	8 (++, --, 11, 13, 14)
Wire cross-section, rigid min/max	0.18 / 6 mm ²
Wire cross-section, flexible min/max	0.22 / 4 mm ²
Wire cross-section, AWG/kcmil min/max	26 / 10
Screwdriver blade	0.8 x 4.0, PZ 1
Note	

Connection data	
Connection system	Screw connection
Number of terminals	8 (++, --, 11, 13, 14)
Wire cross-section, rigid min/max	0.18 / 6 mm ²
Wire cross-section, flexible min/max	0.22 / 4 mm ²
Wire cross-section, AWG/kcmil min/max	26 / 10
Screwdriver blade	0.8 x 4.0, PZ 1
Note	

Ordering data

Type	Qty.	Order No.
PRO MAX3 480W 24V 20A	1	1478190000

Type	Qty.	Order No.
PRO MAX3 480W 24V 20A	1	1478190000

Type	Qty.	Order No.
PRO MAX3 960W 24V 40A	1	1478200000

Note
The internal varistor found in a switch-mode power supply does not replace the need for surge protection within a system.

Note
The internal varistor found in a switch-mode power supply does not replace the need for surge protection within a system.

Note
The internal varistor found in a switch-mode power supply does not replace the need for surge protection within a system.

Small metal foot



Type	Order No.
MTA 30 MF	1251320000

Large metal foot



Type	Order No.
MTA 45 MF	1251310000

Small plastic foot



Type	Order No.
MTA 30 BK	1168970000

Large plastic foot



Type	Order No.
MTA 45 BK	1962250000

Small wall mounting



Type	Order No.
CP A WALLADAPTER 30 MM	1461870000

Large wall mounting



Type	Order No.
CP A WALLADAPTER 45 MM	1461850000

Small screwdriver

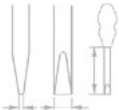
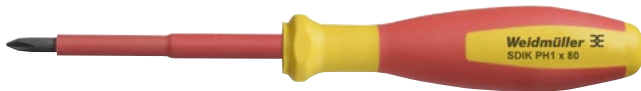

Type	Size/AF	a	b	c	Order No.
SDIK PH 1 X 80				80	2749890000
SDIS 0.5X3.0X100		0.5	3	100	2749800000

Large screwdriver



Type	Size/AF	a	b	c	Order No.
SDIS 1.0X5.5X125		1	5.5	125	2749850000

Markers



Type	Colour	Qty.	Order No.
SM 18/9.5 K MC NE WS	white	200	1248580000

Endwinkel

For DIN rail TS 35



Type	Colour	Torque	Qty.	Order No.
Polyamide with fibre glass, screwable WEW 35/1 SW	black	1.2 Nm	50	1162600000

Find the cost-effective solution for your power supply

PROeco combines all of the basic functions in a compact design

A

Even in series machine construction, switched-mode power supply units can create a real competitive edge thanks to above-average performance values. The efficient PROeco series offers all of the basic functions and delivers impressively high performance and flexibility.

Our PROeco switched-mode power supply units are characterised by their compact design, a high degree of efficiency and the fact that they are extremely easy to service. Thanks to over temperature protection, short-circuit and overload protection, they can be universally used in all applications.

Solutions featuring PROeco are characterised by extensive safety functions and compatibility with our diode modules and UPS components for setting up a redundant power supply.



Rapid status diagnosis

The tricolour LED display and an integrated status relay make it easier to analyse statuses and errors during commissioning and operation.



Extremely compact

With a depth of 100 mm, PROeco power supplies even fit into small cabinets. The compact design also saves up to 50 % space in the cabinet.



Robust and reliable

PROeco power packs work reliably in a wide temperature range from -25 °C to +70 °C and boast a high MTBF value of more than 500,000 hours.

Power supply solution

Together with the uninterruptible DC UPS, the diode modules or CAP modules, you can create a power supply solution that is tailored to your requirements.



Noticeably energy-saving

A high degree of efficiency of up to 93 % and minimal no-load losses ensure low energy consumption and a long service life.

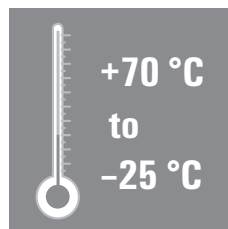
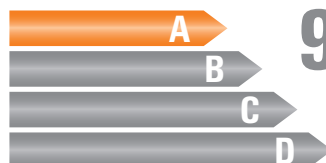

connectPower PROeco

PROeco power supplies with basic functionality and a high level of reliability

- Single- and three-phase switched-mode power supply units
- Slim design
- Large temperature range from -25 °C to 70 °C
- The output voltage can be precisely adjusted via the potentiometer on the front
- Remote monitoring via integrated status relay
- Three-coloured LED indicators for simple error detection
- Advanced visual warning at 90 % rated output current
- International approvals



Derating curve

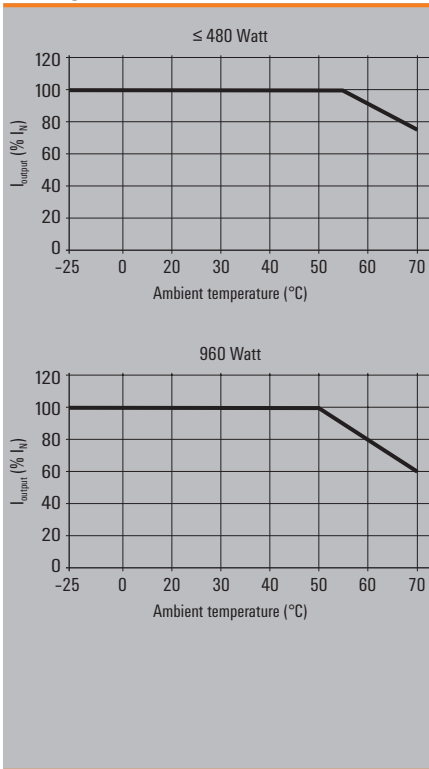

Technical data

General data	
Ambient temperature (operational)	-25 °C...70 °C
Storage temperature	-40 °C...85 °C
Max. perm. air humidity (operational)	5 %...95 % RH
Protection degree	IP20
Protection class	I, with PE connection
Pollution degree	2
Insulation voltage, input/output	3 kV
Insulation voltage input / earth	2 kV
Insulation voltage output / earth	0.5 kV
Parallel connection option	yes, max. 5
Housing version	Metal, corrosion resistant
Mounting position, installation notice	on terminal rail TS 35
Short-circuit protection	Yes
Overload protection	Yes
Protection against over-heating	Yes
EMC / shock / vibration	
Noise emission in accordance with EN55032	Class B
Interference immunity test acc. to	EN 61000-4-2 (ESD), EN 61000-4-3 (RS), EN 61000-4-4 (burst), EN 61000-4-5 (surge), EN 61000-4-6 (conducted), EN61000-4-8 (Fields), EN61000-4-11 (Dips)
Limiting of mains voltage harmonic currents	According to EN 61000-3-2
Resistance to vibration / Shock	1 g according to EN 50178 / 15 g In all directions
Electrical safety (applied standards)	
Electrical machine equipment	Acc. to EN60204
Safety transformers for switch-mode power supplies	According to EN 61558-2-16
For use with electronic equipment	Acc. to EN50178 / VDE0160
Protective separation / protection against electrical shock	VDE0100-410 / acc. to DIN57100-410
Protection against dangerous shock currents	Acc. to VDE0106-101

connectPower PROeco

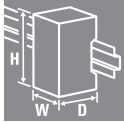

PRO ECO 72W 24V 3A



Similar to illustration

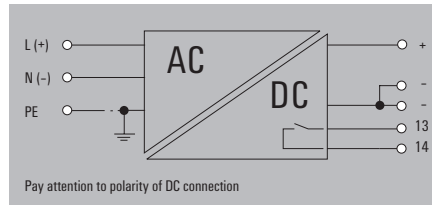

PRO ECO 120W 24V 5A



Similar to illustration

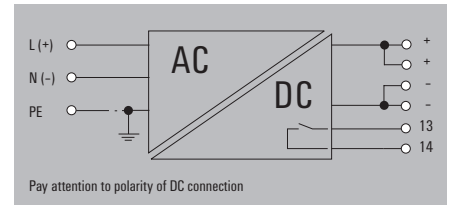

Technical data

Input	
Rated input voltage	100...240 V AC
Input voltage range AC	85...264 V AC (derating at 100 V AC)
Frequency range AC	47...63 Hz
DC input voltage range	80...370 V DC (Derating @ 120 V DC)
AC current consumption	0,55 A @ 230 V AC / 1,04 A @ 110 V AC
DC current consumption	0,22 A @ 370 V DC / 0,68 A @ 120 V DC
Input fuse (internal) / Inrush current	Yes / max. 40 A
Output	
Rated output voltage	24 V DC ± 1 %
Output voltage	22...28 V (adjustable via potentiometer)
Ramp-up time / Residual ripple, breaking spikes	≤ 100 ms / < 50 mV _{pp} @ 24 V DC, I _N
Nominal output current for U _{nom}	3 A at 55 °C
Continuous output current @ U _{Nominal}	3 A @ 55 °C, 2,25 A @ 70 °C
Capacitive load / Protection against inverse voltage	unrestricted / Yes
Signalling	
Indication	Green LED (U _{output} > 21.6 V DC), Yellow LED (I _{output} > 90 % I _{Rated} typ.), red LED (overload, overtemperature, short-circuit, U _{output} < 20.4 V DC)
Floating contact / Contact load	Yes / max. 30 V DC / 1 A
Relay on/off	Output voltage >21.6 V DC/ <20.4 V DC, overload
MTBF	
According to Standard	SN 29500
Operating time (hours), min.	1.7Mh
Ambient temperature	25 °C
Input voltage	230V
Output power	72W
Duty cycle	100%
General data	
Degree of efficiency	87 %
Power loss idling / nominal load	4 W / 9.5 W
Earth leakage current, max.	3.5 mA
Power factor (approx.)	> 0.5...230 V AC / > 0.53...115 V AC
AC failure bridging time @ I _{nom}	> 100 ms @ 230 V AC / > 20 ms @ 115 V AC
Parallel connection option	yes, max. 5
Depth x width x height / Net weight	100 / 34 / 125 mm / 557 g
Approvals	
Approvals	CE; cULus; EAC; TUEV
Connection data	
Connection system	Screw connection
Number of terminals	3 for L/N/PE
Wire cross-section, rigid min/max	0.5 / 6 mm ²
Wire cross-section, flexible min/max	0.5 / 2.5 mm ²
Wire cross-section, AWG/kcmil min/max	26 / 12
Tightening torque range	/
Note	

Ordering data

Type	Qty.	Order No.
PRO ECO 72W 24V 3A	1	1469470000
Note		
The internal varistor found in a switch-mode power supply does not replace the need for surge protection within a system.		

Input	
Rated input voltage	100...240 V AC
Input voltage range AC	85...264 V AC (derating at 100 V AC)
Frequency range AC	47...63 Hz
DC input voltage range	80...370 V DC (Derating @ 120 V DC)
AC current consumption	0,55 A @ 230 V AC / 1,04 A @ 110 V AC
DC current consumption	0,22 A @ 370 V DC / 0,68 A @ 120 V DC
Input fuse (internal) / Inrush current	Yes / max. 40 A
Output	
Rated output voltage	24 V DC ± 1 %
Output voltage	22...28 V (adjustable via potentiometer)
Ramp-up time / Residual ripple, breaking spikes	≤ 100 ms / < 50 mV _{pp} @ 24 V DC, I _N
Nominal output current for U _{nom}	3 A at 55 °C
Continuous output current @ U _{Nominal}	3 A @ 55 °C, 2,25 A @ 70 °C
Capacitive load / Protection against inverse voltage	unrestricted / Yes
Signalling	
Indication	Green LED (U _{output} > 21.6 V DC), Yellow LED (I _{output} > 90 % I _{Rated} typ.), red LED (overload, overtemperature, short-circuit, U _{output} < 20.4 V DC)
Floating contact / Contact load	Yes / max. 30 V DC / 1 A
Relay on/off	Output voltage >21.6 V DC/ <20.4 V DC, overload
MTBF	
According to Standard	SN 29500
Operating time (hours), min.	1.7Mh
Ambient temperature	25 °C
Input voltage	230V
Output power	72W
Duty cycle	100%
General data	
Degree of efficiency	87 %
Power loss idling / nominal load	4 W / 9.5 W
Earth leakage current, max.	3.5 mA
Power factor (approx.)	> 0.5...230 V AC / > 0.53...115 V AC
AC failure bridging time @ I _{nom}	> 100 ms @ 230 V AC / > 20 ms @ 115 V AC
Parallel connection option	yes, max. 5
Depth x width x height / Net weight	100 / 34 / 125 mm / 557 g
Approvals	
Approvals	CE; cULus; EAC; TUEV
Connection data	
Connection system	Screw connection
Number of terminals	3 for L/N/PE
Wire cross-section, rigid min/max	0.5 / 6 mm ²
Wire cross-section, flexible min/max	0.5 / 2.5 mm ²
Wire cross-section, AWG/kcmil min/max	26 / 12
Tightening torque range	/
Note	

Type	Qty.	Order No.
PRO ECO 120W 24V 5A	1	1469480000
Note		
The internal varistor found in a switch-mode power supply does not replace the need for surge protection within a system.		

Input	
Rated input voltage	100...240 V AC
Input voltage range AC	85...264 V AC (derating at 100 V AC)
Frequency range AC	47...63 Hz
DC input voltage range	80...370 V DC (Derating @ 120 V DC)
AC current consumption	1,26 A @ 230 V AC / 2,24 A @ 110 V AC
DC current consumption	0,39 A @ 370 V DC / 1,16 A @ 120 V DC
Input fuse (internal) / Inrush current	Yes / max. 40 A
Output	
Rated output voltage	24 V DC ± 1 %
Output voltage	22...28 V (adjustable via potentiometer)
Ramp-up time / Residual ripple, breaking spikes	≤ 100 ms / < 50 mV _{pp} @ 24 V DC, I _N
Nominal output current for U _{nom}	5 A at 55 °C
Continuous output current @ U _{Nominal}	5 A @ 55 °C, 3,75 A @ 70 °C
Capacitive load / Protection against inverse voltage	unrestricted / Yes
Signalling	
Indication	Green LED (U _{output} > 21.6 V DC), Yellow LED (I _{output} > 90 % I _{Rated} typ.), red LED (overload, overtemperature, short-circuit, U _{output} < 20.4 V DC)
Floating contact / Contact load	Yes / max. 30 V DC / 1 A
Relay on/off	Output voltage >21.6 V DC/ <20.4 V DC, overload
MTBF	
According to Standard	SN 29500
Operating time (hours), min.	2.1Mh
Ambient temperature	25 °C
Input voltage	230V
Output power	120W
Duty cycle	100%
General data	
Degree of efficiency	87 %
Power loss idling / nominal load	4 W / 15 W
Earth leakage current, max.	3.5 mA
Power factor (approx.)	> 0.5...230 V AC / > 0.53...115 V AC
AC failure bridging time @ I _{nom}	> 80 ms @ 230 V AC / > 20 ms @ 115 V AC
Parallel connection option	yes, max. 5
Depth x width x height / Net weight	100 / 40 / 125 mm / 675 g
Approvals	
Approvals	CE; cULus; EAC; TUEV
Connection data	
Connection system	Screw connection
Number of terminals	3 for L/N/PE
Wire cross-section, rigid min/max	0.5 / 6 mm ²
Wire cross-section, flexible min/max	0.5 / 2.5 mm ²
Wire cross-section, AWG/kcmil min/max	26 / 12
Tightening torque range	/
Note	

Type	Qty.	Order No.
PRO ECO 120W 24V 5A	1	1469480000
Note		
The internal varistor found in a switch-mode power supply does not replace the need for surge protection within a system.		

connectPower PROeco

connectPower PROeco

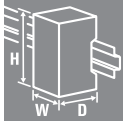

PRO ECO 240W 24V 10A



Similar to illustration

PRO ECO 480W 24V 20A



Similar to illustration

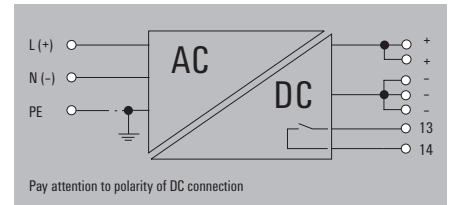
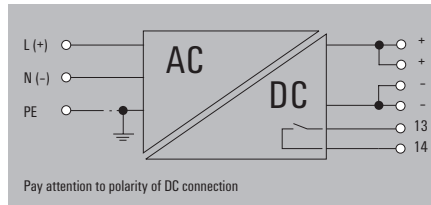

Technical data

Input	
Rated input voltage	100...240 V AC
Input voltage range AC	85...264 V AC (derating at 100 V AC)
Frequency range AC	47...63 Hz
DC input voltage range	80...370 V DC (Derating @ 120 V DC)
AC current consumption	1,23 A @ 230 V AC / 2,47 A @ 110 V AC
DC current consumption	1,18 A @ 370 V DC / 2,4 A @ 120 V DC
Input fuse (internal) / Inrush current	Yes / max. 15 A
Output	
Rated output voltage	24 V DC ± 1 %
Output voltage	22...28 V (adjustable via potentiometer)
Ramp-up time / Residual ripple, breaking spikes	≤ 100 ms / < 50 mV _{pp} @ 24 V DC, I _N
Nominal output current for U _{nom}	10 A @ 55 °C
Continuous output current @ U _{Nominal}	10 A @ 55 °C, 2,5 A @ 70 °C
Capacitive load / Protection against inverse voltage	unrestricted / Yes
Signalling	
Indication	Green LED (U _{output} > 21.6 V DC), Yellow LED (I _{output} > 90 % I _{Rated} typ.), red LED (overload, overtemperature, short-circuit, U _{output} < 20.4 V DC)
Floating contact / Contact load	Yes / max. 30 V DC / 1 A
Relay on/off	Output voltage >21.6 V DC / <20.4 V DC, overload
MTBF	
According to Standard	SN 29500
Operating time (hours), min.	2Mh
Ambient temperature	25 °C
Input voltage	230V
Output power	240W
Duty cycle	100%
General data	
Degree of efficiency	90%
Power loss idling / nominal load	2 W / 24 W
Earth leakage current, max.	3,5 mA
Power factor (approx.)	> 0.94 @ 230 V AC / > 0.99 @ 115 V AC
AC failure bridging time @ I _{nom}	> 20 ms @ 230 V AC / > 20 ms @ 115 V AC
Parallel connection option	yes, max. 5
Depth x width x height / Net weight	100 / 60 / 125 mm / 1002 g
Approvals	
Approvals	CE; cULus; EAC; TUEV
Connection data	
Connection system	Screw connection
Number of terminals	3 for L/N/PE
Wire cross-section, rigid min/max	0.5 / 6 mm ²
Wire cross-section, flexible min/max	0.5 / 2.5 mm ²
Wire cross-section, AWG/kcmil min/max	26 / 12
Tightening torque range	/
Note	

Input	
Rated input voltage	100...240 V AC
Input voltage range AC	85...264 V AC (derating at 100 V AC)
Frequency range AC	47...63 Hz
DC input voltage range	80...370 V DC (Derating @ 120 V DC)
AC current consumption	1,23 A @ 230 V AC / 2,47 A @ 110 V AC
DC current consumption	1,18 A @ 370 V DC / 2,4 A @ 120 V DC
Input fuse (internal) / Inrush current	Yes / max. 15 A
Output	
Rated output voltage	24 V DC ± 1 %
Output voltage	22...28 V (adjustable via potentiometer)
Ramp-up time / Residual ripple, breaking spikes	≤ 100 ms / < 50 mV _{pp} @ 24 V DC, I _N
Nominal output current for U _{nom}	10 A @ 55 °C
Continuous output current @ U _{Nominal}	10 A @ 55 °C, 2,5 A @ 70 °C
Capacitive load / Protection against inverse voltage	unrestricted / Yes
Signalling	
Indication	Green LED (U _{output} > 21.6 V DC), Yellow LED (I _{output} > 90 % I _{Rated} typ.), red LED (overload, overtemperature, short-circuit, U _{output} < 20.4 V DC)
Floating contact / Contact load	Yes / max. 30 V DC / 1 A
Relay on/off	Output voltage >21.6 V DC / <20.4 V DC, overload
MTBF	
According to Standard	SN 29500
Operating time (hours), min.	2Mh
Ambient temperature	25 °C
Input voltage	230V
Output power	240W
Duty cycle	100%
General data	
Degree of efficiency	90%
Power loss idling / nominal load	2 W / 24 W
Earth leakage current, max.	3,5 mA
Power factor (approx.)	> 0.94 @ 230 V AC / > 0.99 @ 115 V AC
AC failure bridging time @ I _{nom}	> 20 ms @ 230 V AC / > 20 ms @ 115 V AC
Parallel connection option	yes, max. 5
Depth x width x height / Net weight	100 / 60 / 125 mm / 1002 g
Approvals	
Approvals	CE; cULus; EAC; TUEV
Connection data	
Connection system	Screw connection
Number of terminals	3 for L/N/PE
Wire cross-section, rigid min/max	0.5 / 6 mm ²
Wire cross-section, flexible min/max	0.5 / 2.5 mm ²
Wire cross-section, AWG/kcmil min/max	26 / 12
Tightening torque range	/
Note	

Input	
Rated input voltage	100...240 V AC
Input voltage range AC	85...264 V AC (derating at 100 V AC)
Frequency range AC	47...63 Hz
DC input voltage range	80...370 V DC (Derating @ 120 V DC)
AC current consumption	2,37 A @ 230 V AC / 5,2 A @ 110 V AC
DC current consumption	1,55 A @ 370 V DC / 4,65 A @ 120 V DC
Input fuse (internal) / Inrush current	Yes / max. 5 A
Output	
Rated output voltage	24 V DC ± 1 %
Output voltage	22...28 V (adjustable via potentiometer)
Ramp-up time / Residual ripple, breaking spikes	≤ 100 ms / < 50 mV _{pp} @ 24 V DC, I _N
Nominal output current for U _{nom}	20 A @ 55 °C
Continuous output current @ U _{Nominal}	20 A @ 55 °C, 15 A @ 70 °C
Capacitive load / Protection against inverse voltage	unrestricted / Yes
Signalling	
Indication	Green LED (U _{output} > 21.6 V DC), Yellow LED (I _{output} > 90 % I _{Rated} typ.), red LED (overload, overtemperature, short-circuit, U _{output} < 20.4 V DC)
Floating contact / Contact load	Yes / max. 30 V DC / 1 A
Relay on/off	Output voltage >21.6 V DC / <20.4 V DC, overload
MTBF	
According to Standard	SN 29500
Operating time (hours), min.	1.5Mh
Ambient temperature	25 °C
Input voltage	230V
Output power	480W
Duty cycle	100%
General data	
Degree of efficiency	91%
Power loss idling / nominal load	5 W / 43 W
Earth leakage current, max.	3,5 mA
Power factor (approx.)	> 0.98...230 V AC / > 0.98...115 V AC
AC failure bridging time @ I _{nom}	> 20 ms @ 230 V AC / > 20 ms @ 115 V AC
Parallel connection option	yes, max. 3
Depth x width x height / Net weight	120 / 100 / 125 mm / 1557 g
Approvals	
Approvals	CE; cULus; EAC; TUEV
Connection data	
Connection system	Screw connection
Number of terminals	3 for L/N/PE
Wire cross-section, rigid min/max	0.5 / 6 mm ²
Wire cross-section, flexible min/max	0.5 / 2.5 mm ²
Wire cross-section, AWG/kcmil min/max	26 / 12
Tightening torque range	/
Note	

Ordering data

Type	Qty.	Order No.
PRO ECO 240W 24V 10A	1	1469490000
Note		
The internal varistor found in a switch-mode power supply does not replace the need for surge protection within a system.		

Type	Qty.	Order No.
PRO ECO 480W 24V 20A	1	1469510000
Note		
The internal varistor found in a switch-mode power supply does not replace the need for surge protection within a system.		

Type	Qty.	Order No.
PRO ECO 480W 24V 20A	1	1469510000
Note		
The internal varistor found in a switch-mode power supply does not replace the need for surge protection within a system.		

connectPower PROeco

PRO ECO 960W 24V 40A

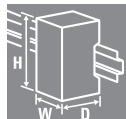

Similar to illustration

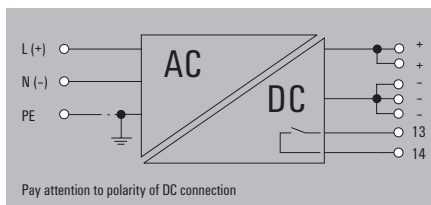

Technical data

Input	
Rated input voltage	100...240 V AC
Input voltage range AC	85...264 V AC (derating at 100 V AC)
Frequency range AC	47...63 Hz
DC input voltage range	80...370 V DC (Derating @ 120 V DC)
AC current consumption	4,6 A @ 230 V AC / 9,9 A @ 110 V AC
DC current consumption	2,9 A @ 370 V DC / 9 A @ 120 V DC
Input fuse (internal) / Inrush current	Yes / max. 5 A
Output	
Rated output voltage	24 V DC ± 1 %
Output voltage	22...28 V (adjustable via potentiometer)
Ramp-up time / Residual ripple, breaking spikes	≤ 100 ms / < 50 mV _{pp} @ 24 V DC, I _N
Nominal output current for U _{nom}	40 A @ 50 °C
Continuous output current @ U _{Nominal}	40 A @ 50 °C, 24 A @ 70 °C
Capacitive load / Protection against inverse voltage	unrestricted / Yes
Signalling	
Indication	Green LED (U _{output} > 21.6 V DC), Yellow LED (I _{output} > 90 % I _{Rated} typ.), red LED (overload, overtemperature, short-circuit, U _{output} < 20.4 V DC)
Floating contact / Contact load	Yes / max. 30 V DC / 1 A
Relay on/off	Output voltage >21.6 V DC/ <20.4 V DC, overload
MTBF	
According to Standard	SN 29500
Operating time (hours), min.	1.06Mh
Ambient temperature	25 °C
Input voltage	230V
Output power	960W
Duty cycle	100%
General data	
Degree of efficiency	93%
Power loss idling / nominal load	8 W / 85 W
Earth leakage current, max.	3,5 mA
Power factor (approx.)	> 0.98...230 V AC / > 0.98...115 V AC
AC failure bridging time @ I _{nom}	> 20 ms @ 230 V AC / > 20 ms @ 115 V AC
Parallel connection option	yes, max. 3
Depth x width x height / Net weight	120 / 160 / 125 mm / 3190 g
Approvals	
Approvals	CE; cULus; EAC; TUEV
Connection data	
Connection system	Screw connection
Number of terminals	7 (+, -, 13, 14)
Wire cross-section, rigid min/max	0.5 / 6
Wire cross-section, flexible min/max	0.5 / 2.5
Wire cross-section, AWG/kcmil min/max	26 / 12
Tightening torque range	/
Note	

Input		Output	
Screw connection	Screw connection		
3 for L/N/PE	7 (+, -, 13, 14)		
0.5 / 6	0.5 / 16		
0.5 / 2.5	2.5 / 10		
26 / 12	22 / 8		
/	0.5 / 0.6		

Ordering data

Type	Qty.	Order No.
PRO ECO 960W 24V 40A	1	1469520000

Type	Qty.	Order No.
PRO ECO 960W 24V 40A	1	1469520000

The internal varistor found in a switch-mode power supply does not replace the need for surge protection within a system.

connectPower PROeco

connectPower PROeco

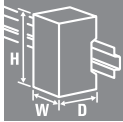

PRO ECO 72W 12V 6A



Similar to illustration

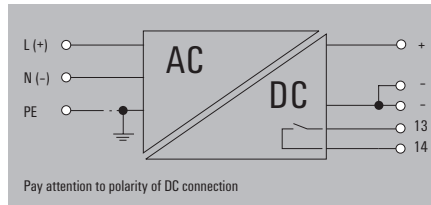

PRO ECO 120W 12V 10A



Similar to illustration

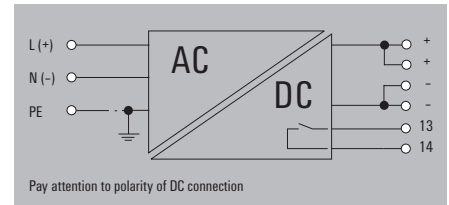

Technical data

Input	
Rated input voltage	100...240 V AC
Input voltage range AC	85...264 V AC (derating at 100 V AC)
Frequency range AC	47...63 Hz
DC input voltage range	80...370 V DC (Derating @ 120 V DC)
AC current consumption	0.6 A @ 230 V AC / 1.1 A @ 115 V AC
DC current consumption	0.25 A @ 370 V DC / 0.7 A @ 120 V DC
Input fuse (internal) / Inrush current	Yes / max. 40 A
Output	
Rated output voltage	12 V DC ± 1 %
Output voltage	10...16 V (adjustable via potentiometer)
Ramp-up time / Residual ripple, breaking spikes	≤ 100 ms / < 50 mV ss @ 12 V DC, I Nenn
Nominal output current for U _{nom}	6 A @ 55 °C
Continuous output current @ U _{Nominal}	6 A @ 55 °C, 4.5 A @ 60 °C
Capacitive load / Protection against inverse voltage	unrestricted / Yes
Signalling	
Indication	Green LED (U _{output} > 21.6 V DC), Yellow LED (I _{output} > 90 % I _{Rated} typ.), red LED (overload, overtemperature, short-circuit, U _{output} < 20.4 V DC)
Floating contact / Contact load	Yes / max. 30 V DC / 1 A
Relay on/off	Output voltage >21.6 V DC/ <20.4 V DC, overload
MTBF	
According to Standard	SN 29500
Operating time (hours), min.	3Mh
Ambient temperature	25 °C
Input voltage	230V
Output power	72W
Duty cycle	100%
General data	
Degree of efficiency	85 %
Power loss idling / nominal load	4 W / 15 W
Earth leakage current, max.	3.5 mA
Power factor (approx.)	> 0.5...230 V AC / > 0.53...115 V AC
AC failure bridging time @ I _{nom}	> 100 ms @ 230 V AC / > 20 ms @ 115 V AC
Parallel connection option	yes, max. 5
Depth x width x height / Net weight	100 / 34 / 125 mm / 565 g
Approvals	
Approvals	CE; cULus; EAC; TUEV
Connection data	
Connection system	Screw connection
Number of terminals	3 for L/N/PE
Wire cross-section, rigid min/max	0.5 / 6 mm ²
Wire cross-section, flexible min/max	0.5 / 2.5 mm ²
Wire cross-section, AWG/kcmil min/max	26 / 12
Tightening torque range	/
Note	

Input	
Rated input voltage	100...240 V AC
Input voltage range AC	85...264 V AC (derating at 100 V AC)
Frequency range AC	47...63 Hz
DC input voltage range	80...370 V DC (Derating @ 120 V DC)
AC current consumption	0.6 A @ 230 V AC / 1.1 A @ 115 V AC
DC current consumption	0.25 A @ 370 V DC / 0.7 A @ 120 V DC
Input fuse (internal) / Inrush current	Yes / max. 40 A
Output	
Rated output voltage	12 V DC ± 1 %
Output voltage	10...16 V (adjustable via potentiometer)
Ramp-up time / Residual ripple, breaking spikes	≤ 100 ms / < 50 mV ss @ 12 V DC, I Nenn
Nominal output current for U _{nom}	6 A @ 55 °C
Continuous output current @ U _{Nominal}	6 A @ 55 °C, 4.5 A @ 60 °C
Capacitive load / Protection against inverse voltage	unrestricted / Yes
Signalling	
Indication	Green LED (U _{output} > 21.6 V DC), Yellow LED (I _{output} > 90 % I _{Rated} typ.), red LED (overload, overtemperature, short-circuit, U _{output} < 20.4 V DC)
Floating contact / Contact load	Yes / max. 30 V DC / 1 A
Relay on/off	Output voltage >21.6 V DC/ <20.4 V DC, overload
MTBF	
According to Standard	SN 29500
Operating time (hours), min.	3Mh
Ambient temperature	25 °C
Input voltage	230V
Output power	72W
Duty cycle	100%
General data	
Degree of efficiency	85 %
Power loss idling / nominal load	4 W / 15 W
Earth leakage current, max.	3.5 mA
Power factor (approx.)	> 0.5...230 V AC / > 0.53...115 V AC
AC failure bridging time @ I _{nom}	> 100 ms @ 230 V AC / > 20 ms @ 115 V AC
Parallel connection option	yes, max. 5
Depth x width x height / Net weight	100 / 34 / 125 mm / 565 g
Approvals	
Approvals	CE; cULus; EAC; TUEV
Connection data	
Connection system	Screw connection
Number of terminals	3 for L/N/PE
Wire cross-section, rigid min/max	0.5 / 6 mm ²
Wire cross-section, flexible min/max	0.5 / 2.5 mm ²
Wire cross-section, AWG/kcmil min/max	26 / 12
Tightening torque range	/
Note	

Input	
Rated input voltage	100...240 V AC
Input voltage range AC	85...264 V AC (derating at 100 V AC)
Frequency range AC	47...63 Hz
DC input voltage range	80...370 V DC (Derating @ 120 V DC)
AC current consumption	1.25 A @ 230 V AC / 2.25 A @ 110 V AC
DC current consumption	0.4 A @ 370 V DC / 1.2 A @ 120 V DC
Input fuse (internal) / Inrush current	Yes / max. 40 A
Output	
Rated output voltage	12 V DC ± 1 %
Output voltage	10...16 V (adjustable via potentiometer)
Ramp-up time / Residual ripple, breaking spikes	≤ 100 ms / < 50 mV ss @ 12 V DC, I Nenn
Nominal output current for U _{nom}	10 A @ 55 °C
Continuous output current @ U _{Nominal}	10 A @ 55 °C, 2.5 A @ 70 °C
Capacitive load / Protection against inverse voltage	unrestricted / Yes
Signalling	
Indication	Green LED (U _{output} > 21.6 V DC), Yellow LED (I _{output} > 90 % I _{Rated} typ.), red LED (overload, overtemperature, short-circuit, U _{output} < 20.4 V DC)
Floating contact / Contact load	Yes / max. 30 V DC / 1 A
Relay on/off	Output voltage >21.6 V DC/ <20.4 V DC, overload
MTBF	
According to Standard	SN 29500
Operating time (hours), min.	2.6Mh
Ambient temperature	25 °C
Input voltage	230V
Output power	120W
Duty cycle	100%
General data	
Degree of efficiency	87 %
Power loss idling / nominal load	4 W / 20 W
Earth leakage current, max.	3.5 mA
Power factor (approx.)	> 0.5...230 V AC / > 0.53...115 V AC
AC failure bridging time @ I _{nom}	> 80 ms @ 230 V AC / > 20 ms @ 115 V AC
Parallel connection option	yes, max. 5
Depth x width x height / Net weight	100 / 40 / 125 mm / 680 g
Approvals	
Approvals	CE; cULus; EAC; TUEV
Connection data	
Connection system	Screw connection
Number of terminals	3 for L/N/PE
Wire cross-section, rigid min/max	0.5 / 6 mm ²
Wire cross-section, flexible min/max	0.5 / 2.5 mm ²
Wire cross-section, AWG/kcmil min/max	26 / 12
Tightening torque range	/
Note	

Ordering data

Type	Qty.	Order No.
PRO ECO 72W 12V 6A	1	1469570000
Note		
The internal varistor found in a switch-mode power supply does not replace the need for surge protection within a system.		

Type	Qty.	Order No.
PRO ECO 120W 12V 10A	1	1469580000
Note		
The internal varistor found in a switch-mode power supply does not replace the need for surge protection within a system.		

Type	Qty.	Order No.
PRO ECO 120W 12V 10A	1	1469580000
Note		
The internal varistor found in a switch-mode power supply does not replace the need for surge protection within a system.		

connectPower PROeco

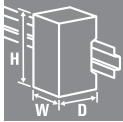

PRO ECO 240W 48V 5A



Similar to illustration

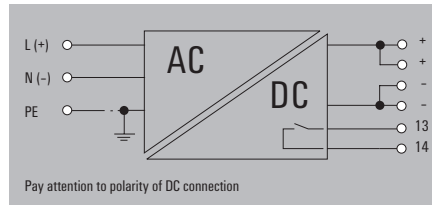

PRO ECO 480W 48V 10A



Similar to illustration

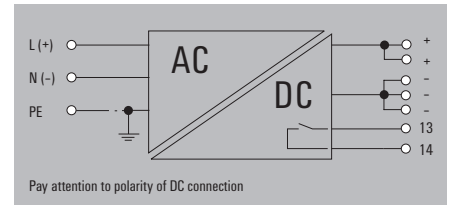

Technical data

Input	
Rated input voltage	100...240 V AC
Input voltage range AC	85...264 V AC (derating at 100 V AC)
Frequency range AC	47...63 Hz
DC input voltage range	80...370 V DC (Derating @ 120 V DC)
AC current consumption	1.2 A @ 230 V AC / 2.4 A @ 115 V AC
DC current consumption	1.2 A @ 370 V DC / 2.4 A @ 120 V DC
Input fuse (internal) / Inrush current	Yes / Max. 10 A
Output	
Rated output voltage	48 V DC ± 1 %
Output voltage	42...56 V (adjustable via potentiometer)
Ramp-up time / Residual ripple, breaking spikes	≤ 100 ms / < 100 mV ss @ 48 V DC, I Nenn
Nominal output current for I_{nom}	5 A at 55 °C
Continuous output current @ $U_{nominal}$	5 A @ 55 °C, 3,75 A @ 70 °C
Capacitive load / Protection against inverse voltage	unrestricted / Yes
Signalling	
Indication	Green LED ($U_{output} > 21.6$ V DC), Yellow LED ($I_{output} > 90 \% I_{Rated}$ typ.), red LED (overload, overtemperature, short-circuit, $U_{output} < 20.4$ V DC)
Floating contact / Contact load	Yes / max. 30 V DC / 1 A
Relay on/off	Output voltage >21.6 V DC/ <20.4 V DC, overload
MTBF	
According to Standard	SN 29500
Operating time (hours), min.	2Mh
Ambient temperature	25 °C
Input voltage	230V
Output power	240W
Duty cycle	100%
General data	
Degree of efficiency	92 %
Power loss idling / nominal load	3 W / 23 W
Earth leakage current, max.	3,5 mA
Power factor (approx.)	> 0.94 @ 230 V AC / > 0.99 @ 115 V AC
AC failure bridging time @ I_{nom}	> 20 ms @ 230 V AC / > 20 ms @ 115 V AC
Parallel connection option	yes, max. 5
Depth x width x height / Net weight	100 / 60 / 125 mm / 1.01 g
Approvals	
Approvals	CE; cULus; EAC; TUEV
Connection data	
Connection system	Screw connection
Number of terminals	3 for L/N/PE
Wire cross-section, rigid min/max	0.5 / 6
Wire cross-section, flexible min/max	0.5 / 2.5
Wire cross-section, AWG/kcmil min/max	26 / 12
Tightening torque range	/
Note	

Input	
Rated input voltage	100...240 V AC
Input voltage range AC	85...264 V AC (derating at 100 V AC)
Frequency range AC	47...63 Hz
DC input voltage range	80...370 V DC (Derating @ 120 V DC)
AC current consumption	1.2 A @ 230 V AC / 2.4 A @ 115 V AC
DC current consumption	1.2 A @ 370 V DC / 2.4 A @ 120 V DC
Input fuse (internal) / Inrush current	Yes / Max. 10 A
Output	
Rated output voltage	48 V DC ± 1 %
Output voltage	42...56 V (adjustable via potentiometer)
Ramp-up time / Residual ripple, breaking spikes	≤ 100 ms / < 100 mV ss @ 48 V DC, I Nenn
Nominal output current for I_{nom}	5 A at 55 °C
Continuous output current @ $U_{nominal}$	5 A @ 55 °C, 3,75 A @ 70 °C
Capacitive load / Protection against inverse voltage	unrestricted / Yes
Signalling	
Indication	Green LED ($U_{output} > 21.6$ V DC), Yellow LED ($I_{output} > 90 \% I_{Rated}$ typ.), red LED (overload, overtemperature, short-circuit, $U_{output} < 20.4$ V DC)
Floating contact / Contact load	Yes / max. 30 V DC / 1 A
Relay on/off	Output voltage >21.6 V DC/ <20.4 V DC, overload
MTBF	
According to Standard	SN 29500
Operating time (hours), min.	2Mh
Ambient temperature	25 °C
Input voltage	230V
Output power	240W
Duty cycle	100%
General data	
Degree of efficiency	92 %
Power loss idling / nominal load	3 W / 23 W
Earth leakage current, max.	3,5 mA
Power factor (approx.)	> 0.94 @ 230 V AC / > 0.99 @ 115 V AC
AC failure bridging time @ I_{nom}	> 20 ms @ 230 V AC / > 20 ms @ 115 V AC
Parallel connection option	yes, max. 5
Depth x width x height / Net weight	100 / 60 / 125 mm / 1.01 g
Approvals	
Approvals	CE; cULus; EAC; TUEV
Connection data	
Connection system	Screw connection
Number of terminals	3 for L/N/PE
Wire cross-section, rigid min/max	0.5 / 6
Wire cross-section, flexible min/max	0.5 / 2.5
Wire cross-section, AWG/kcmil min/max	26 / 12
Tightening torque range	/
Note	

Input	
Rated input voltage	100...240 V AC
Input voltage range AC	85...264 V AC (derating at 100 V AC)
Frequency range AC	47...63 Hz
DC input voltage range	80...370 V DC (Derating @ 120 V DC)
AC current consumption	2.4 A @ 230 V AC / 5.2 A @ 110 V AC
DC current consumption	1.5 A @ 370 V DC / 4.6 A @ 120 V DC
Input fuse (internal) / Inrush current	Yes / max. 3 A
Output	
Rated output voltage	48 V DC ± 1 %
Output voltage	42...56 V (adjustable via potentiometer)
Ramp-up time / Residual ripple, breaking spikes	≤ 100 ms / < 100 mV ss @ 48 V DC, I Nenn
Nominal output current for I_{nom}	10 A @ 55 °C
Continuous output current @ $U_{nominal}$	10 A @ 55 °C, 2.5 A @ 70 °C
Capacitive load / Protection against inverse voltage	unrestricted / Yes
Signalling	
Indication	Green LED ($U_{output} > 21.6$ V DC), Yellow LED ($I_{output} > 90 \% I_{Rated}$ typ.), red LED (overload, overtemperature, short-circuit, $U_{output} < 20.4$ V DC)
Floating contact / Contact load	Yes / max. 30 V DC / 1 A
Relay on/off	Output voltage >21.6 V DC/ <20.4 V DC, overload
MTBF	
According to Standard	SN 29500
Operating time (hours), min.	2Mh
Ambient temperature	25 °C
Input voltage	230V
Output power	480W
Duty cycle	100%
General data	
Degree of efficiency	93%
Power loss idling / nominal load	5 W / 50 W
Earth leakage current, max.	3.5 mA
Power factor (approx.)	> 0.98...230 V AC / > 0.98...115 V AC
AC failure bridging time @ I_{nom}	> 20 ms @ 230 V AC / > 20 ms @ 115 V AC
Parallel connection option	yes, max. 3
Depth x width x height / Net weight	120 / 100 / 125 mm / 1561 g
Approvals	
Approvals	CE; cULus; EAC; TUEV
Connection data	
Connection system	Screw connection
Number of terminals	3 for L/N/PE
Wire cross-section, rigid min/max	0.5 / 6
Wire cross-section, flexible min/max	0.5 / 2.5
Wire cross-section, AWG/kcmil min/max	26 / 12
Tightening torque range	/
Note	

Ordering data

Type	Qty.	Order No.
PRO ECO 240W 48V 5A	1	1469590000
Note		
The internal varistor found in a switch-mode power supply does not replace the need for surge protection within a system.		

Type	Qty.	Order No.
PRO ECO 480W 48V 10A	1	1469610000
Note		
The internal varistor found in a switch-mode power supply does not replace the need for surge protection within a system.		

Type	Qty.	Order No.
PRO ECO 480W 48V 10A	1	1469610000
Note		
The internal varistor found in a switch-mode power supply does not replace the need for surge protection within a system.		

connectPower PROeco

connectPower PROeco

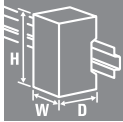

PRO ECO3 120W 24V 5A



Similar to illustration

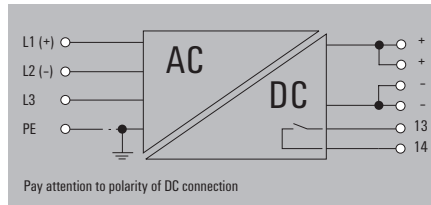

PRO ECO3 240W 24V 10A



Similar to illustration

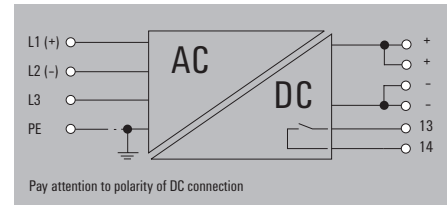

Technical data

Input	
Rated input voltage	3x 400...3x 500 V AC (wide-range input)
Input voltage range AC	3 x 320...3 x 575 V AC / 2 x 360...2 x 575 V AC
Frequency range AC	47...63 Hz
DC input voltage range	450...800 V DC (max. 500 V DC acc. to UL508)
AC current consumption	0.3 A @ 3 x 500 V AC / 0.4 A @ 3 x 400 V AC
DC current consumption	0.2 A @ 800 V DC / 0.4 A @ 450 V DC
Input fuse (internal) / Inrush current	Yes / max. 40 A
Output	
Rated output voltage	24 V DC ± 1 %
Output voltage	22...28 V (adjustable via potentiometer)
Ramp-up time / Residual ripple, breaking spikes	≤ 100 ms / < 50 mV _{pp} @ 24 V DC, I _N
Nominal output current for U _{nom}	5 A at 55 °C
Continuous output current @ U _{Nominal}	5 A @ 55 °C, 3,75 A @ 70 °C
Capacitive load / Protection against inverse voltage	unrestricted / Yes
Signalling	
Indication	Green LED (U _{output} > 21.6 V DC), Yellow LED (I _{output} > 90 % I _{Rated} typ.), red LED (overload, overtemperature, short-circuit, U _{output} < 20.4 V DC)
Floating contact / Contact load	Yes / max. 30 V DC / 1 A
Relay on/off	Output voltage >21.6 V DC / <20.4 V DC, overload
MTBF	
According to Standard	SN 29500
Operating time (hours), min.	2.5Mh
Ambient temperature	25 °C
Input voltage	400V
Output power	120W
Duty cycle	100%
General data	
Degree of efficiency	87 %
Power loss idling / nominal load	6 W / 17 W
Earth leakage current, max.	3.5 mA
Power factor (approx.)	> 0.55 @ 3 x 500 V AC / > 0.65 @ 3 x 400 V AC
AC failure bridging time @ I _{nom}	> 40 ms @ 3 x 500 V AC / > 20 ms @ 3 x 400 V AC
Parallel connection option	yes, max. 5
Depth x width x height / Net weight	100 / 40 / 125 mm / 677 g
Approvals	
Approvals	CE; cULus; EAC; TUEV
Connection data	
Connection system	Screw connection
Number of terminals	4 for L1/L2/L3/PE
Wire cross-section, rigid min/max	0.5 / 6 mm ²
Wire cross-section, flexible min/max	0.5 / 2.5 mm ²
Wire cross-section, AWG/kcmil min/max	26 / 12
Tightening torque range	/
Note	

Input	
Rated input voltage	3x 400...3x 500 V AC (wide-range input)
Input voltage range AC	3 x 320...3 x 575 V AC / 2 x 360...2 x 575 V AC
Frequency range AC	47...63 Hz
DC input voltage range	450...800 V DC (max. 500 V DC acc. to UL508)
AC current consumption	0.3 A @ 3 x 500 V AC / 0.4 A @ 3 x 400 V AC
DC current consumption	0.2 A @ 800 V DC / 0.4 A @ 450 V DC
Input fuse (internal) / Inrush current	Yes / max. 40 A
Output	
Rated output voltage	24 V DC ± 1 %
Output voltage	22...28 V (adjustable via potentiometer)
Ramp-up time / Residual ripple, breaking spikes	≤ 100 ms / < 50 mV _{pp} @ 24 V DC, I _N
Nominal output current for U _{nom}	5 A at 55 °C
Continuous output current @ U _{Nominal}	5 A @ 55 °C, 3,75 A @ 70 °C
Capacitive load / Protection against inverse voltage	unrestricted / Yes
Signalling	
Indication	Green LED (U _{output} > 21.6 V DC), Yellow LED (I _{output} > 90 % I _{Rated} typ.), red LED (overload, overtemperature, short-circuit, U _{output} < 20.4 V DC)
Floating contact / Contact load	Yes / max. 30 V DC / 1 A
Relay on/off	Output voltage >21.6 V DC / <20.4 V DC, overload
MTBF	
According to Standard	SN 29500
Operating time (hours), min.	2.5Mh
Ambient temperature	25 °C
Input voltage	400V
Output power	120W
Duty cycle	100%
General data	
Degree of efficiency	87 %
Power loss idling / nominal load	6 W / 17 W
Earth leakage current, max.	3.5 mA
Power factor (approx.)	> 0.55 @ 3 x 500 V AC / > 0.65 @ 3 x 400 V AC
AC failure bridging time @ I _{nom}	> 40 ms @ 3 x 500 V AC / > 20 ms @ 3 x 400 V AC
Parallel connection option	yes, max. 5
Depth x width x height / Net weight	100 / 40 / 125 mm / 677 g
Approvals	
Approvals	CE; cULus; EAC; TUEV
Connection data	
Connection system	Screw connection
Number of terminals	4 for L1/L2/L3/PE
Wire cross-section, rigid min/max	0.5 / 6 mm ²
Wire cross-section, flexible min/max	0.5 / 2.5 mm ²
Wire cross-section, AWG/kcmil min/max	26 / 12
Tightening torque range	/
Note	

Input	
Rated input voltage	3x 400...3x 500 V AC (wide-range input)
Input voltage range AC	3 x 320...3 x 575 V AC / 2 x 360...2 x 575 V AC
Frequency range AC	47...63 Hz
DC input voltage range	450...800 V DC (max. 500 V DC acc. to UL508)
AC current consumption	0.6 A @ 3 x 500 V AC / 0.8 A @ 3 x 400 V AC
DC current consumption	0.4 A @ 800 V DC / 0.7 A @ 450 V DC
Input fuse (internal) / Inrush current	Yes / max. 50 A
Output	
Rated output voltage	24 V DC ± 1 %
Output voltage	22...28 V (adjustable via potentiometer)
Ramp-up time / Residual ripple, breaking spikes	≤ 100 ms / < 50 mV _{pp} @ 24 V DC, I _N
Nominal output current for U _{nom}	10 A @ 55 °C
Continuous output current @ U _{Nominal}	10 A @ 55 °C, 2.5 A @ 70 °C
Capacitive load / Protection against inverse voltage	unrestricted / Yes
Signalling	
Indication	Green LED (U _{output} > 21.6 V DC), Yellow LED (I _{output} > 90 % I _{Rated} typ.), red LED (overload, overtemperature, short-circuit, U _{output} < 20.4 V DC)
Floating contact / Contact load	Yes / max. 30 V DC / 1 A
Relay on/off	Output voltage >21.6 V DC / <20.4 V DC, overload
MTBF	
According to Standard	SN 29500
Operating time (hours), min.	1.4Mh
Ambient temperature	25 °C
Input voltage	400V
Output power	240W
Duty cycle	100%
General data	
Degree of efficiency	88%
Power loss idling / nominal load	8 W / 26 W
Earth leakage current, max.	3.5 mA
Power factor (approx.)	> 0.55 @ 3 x 500 V AC / > 0.65 @ 3 x 400 V AC
AC failure bridging time @ I _{nom}	> 40 ms @ 3 x 500 V AC / > 20 ms @ 3 x 400 V AC
Parallel connection option	yes, max. 5
Depth x width x height / Net weight	100 / 60 / 125 mm / 957 g
Approvals	
Approvals	CE; cULus; cURus; EAC; TUEV
Connection data	
Connection system	Screw connection
Number of terminals	4 for L1/L2/L3/PE
Wire cross-section, rigid min/max	0.5 / 6 mm ²
Wire cross-section, flexible min/max	0.5 / 2.5 mm ²
Wire cross-section, AWG/kcmil min/max	26 / 12
Tightening torque range	/
Note	

Ordering data

Type	Qty.	Order No.
PRO ECO3 120W 24V 5A	1	1469530000
Note		
The internal varistor found in a switch-mode power supply does not replace the need for surge protection within a system.		

Type	Qty.	Order No.
PRO ECO3 240W 24V 10A	1	1469540000
Note		
The internal varistor found in a switch-mode power supply does not replace the need for surge protection within a system.		

Type	Qty.	Order No.
PRO ECO3 240W 24V 10A	1	1469540000
Note		
The internal varistor found in a switch-mode power supply does not replace the need for surge protection within a system.		

connectPower PROeco

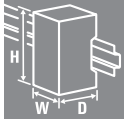

PRO ECO3 480W 24V 20A



Similar to illustration

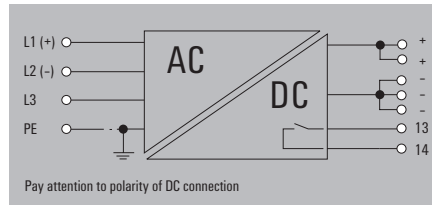

PRO ECO3 960W 24V 40A



Similar to illustration

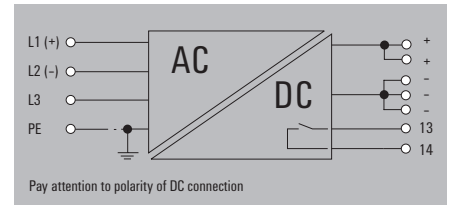

Technical data

Input	
Rated input voltage	3x 400...3x 500 V AC (wide-range input)
Input voltage range AC	3 x 320...3 x 575 V AC / 2 x 360...2 x 575 V AC
Frequency range AC	47...63 Hz
DC input voltage range	450...800 V DC (max. 500 V DC acc. to UL508)
AC current consumption	1.2 A @ 3 x 500 V AC / 1.5 A @ 3 x 400 V AC
DC current consumption	0.7 A @ 800 V DC / 1.2 A @ 450 V DC
Input fuse (internal) / Inrush current	Yes / max. 50 A
Output	
Rated output voltage	24 V DC ± 1 %
Output voltage	22...28 V (adjustable via potentiometer)
Ramp-up time / Residual ripple, breaking spikes	≤ 100 ms / < 50 mV _{pp} @ 24 V DC, I _N
Nominal output current for U _{nom}	20 A @ 55 °C
Continuous output current @ U _{Nominal}	20 A @ 55 °C, 15 A @ 70 °C
Capacitive load / Protection against inverse voltage	unrestricted / Yes
Signalling	
Indication	Green LED (U _{output} > 21.6 V DC), Yellow LED (I _{output} > 90 % I _{Rated} typ.), red LED (overload, overtemperature, short-circuit, U _{output} < 20.4 V DC)
Floating contact / Contact load	Yes / max. 30 V DC / 1 A
Relay on/off	Output voltage >21.6 V DC / <20.4 V DC, overload
MTBF	
According to Standard	SN 29500
Operating time (hours), min.	1.3Mh
Ambient temperature	25 °C
Input voltage	400V
Output power	480W
Duty cycle	100%
General data	
Degree of efficiency	89%
Power loss idling / nominal load	8 W / 48 W
Earth leakage current, max.	3.5 mA
Power factor (approx.)	> 0.55 @ 3 x 500 V AC / > 0.65 @ 3 x 400 V AC
AC failure bridging time @ I _{nom}	> 30 ms @ 3 x 500 V AC / > 20 ms @ 3 x 400 V AC
Parallel connection option	yes, max. 3
Depth x width x height / Net weight	120 / 100 / 125 mm / 1300 g
Approvals	
Approvals	CE; cULus; cURus; EAC; TUEV
Connection data	
Connection system	Screw connection
Number of terminals	4 for L1/L2/L3/PE
Wire cross-section, rigid min/max	0.5 / 6 mm ²
Wire cross-section, flexible min/max	0.5 / 2.5 mm ²
Wire cross-section, AWG/kcmil min/max	26 / 12
Tightening torque range	/
Note	

Input		Output	
Screw connection	Screw connection		
4 for L1/L2/L3/PE	7 (+, -, 13, 14)		
0.5 / 6	0.5 / 6		
0.5 / 2.5	0.5 / 2.5		
26 / 12	26 / 10		
/	0.5 / 0.6		

Input		Output	
Screw connection	Screw connection		
4 for L1/L2/L3/PE	7 (+, -, 13, 14)		
0.5 / 6	0.5 / 16		
0.5 / 2.5	2.5 / 10		
26 / 12	22 / 8		
/	0.5 / 0.6		

Ordering data

Type	Qty.	Order No.
PRO ECO3 480W 24V 20A	1	1469550000

Type	Qty.	Order No.
PRO ECO3 480W 24V 20A	1	1469550000

Type	Qty.	Order No.
PRO ECO3 960W 24V 40A	1	1469560000

Note

The internal varistor found in a switch-mode power supply does not replace the need for surge protection within a system.

The internal varistor found in a switch-mode power supply does not replace the need for surge protection within a system.

Small metal foot



Type	Order No.
MTA 30 MF	1251320000

Large metal foot



Type	Order No.
MTA 45 MF	1251310000

Small plastic foot



Type	Order No.
MTA 30 BK	1168970000

Large plastic foot



Type	Order No.
MTA 45 BK	1962250000

Small wall mounting



Type	Order No.
CP A WALLADAPTER 30 MM	1461870000

Large wall mounting



Type	Order No.
CP A WALLADAPTER 45 MM	1461850000

Small screwdriver



Type	Size/AF	a	b	c	Order No.
SDIK PH 1 X 80				80	2749890000
SDIS 0.5X3.0X100		0,5	3	100	2749800000

Markers



Type	Colour	Qty.	Order No.
SM 18/9.5 K MC NE WS	white	200	1248580000

End bracket

For DIN rail TS 35

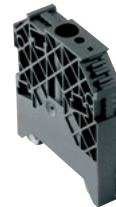

Polyamide with fibre glass, screwable	Colour	Torque	Qty.	Order No.
WEW 35/1 SW	black	1.2 Nm	50	1162600000

Basic functionality at the highest level

PRObas – highly efficient, reliable, affordable

A

A safe and stable DC supply voltage is at the heart of many automation applications. The single-phase switched-mode power supply units of the PRObas series were developed to meet high mechanical engineering standards in a cost-effective way. The expertise behind the successful PROeco, PROMax and PROtop series has been incorporated into this attractive product series.

High performance, compact design and a good price-performance ratio are the main characteristics of the new PRObas power supplies. The product family comprises 12 variants with 5V, 12V, 24V or 48V DC output voltage and a wide-range input.

Due to compatibility with our electronic fuses, DC UPS and diode modules, they are also suitable for setting up power management systems.

Your benefits at a glance

- High cost efficiency with strong performance and compact design
- Reliable start-up at -40°C for extreme external conditions
- Universal use due to wide range of variants and international approvals



Flexible mounting

PRObas switching power supply units can either be snapped onto DIN rails or screwed directly to the cabinet wall.

Space- and energy-saving

With a max. width of 23 to 59 mm, PRObas switching power supply units fit into even the smallest control cabinets. Their high efficiency of up to 95 % and an extremely low idle power loss ensure maximum efficiency.

**Robust and reliable**

PRObas switching power supplies operate reliably in the temperature range from $-25\text{ }^{\circ}\text{C}$ to $+70\text{ }^{\circ}\text{C}$ and have an MTBF value of over one million hours.

connectPower PRObas

connectPower PRObas



Derating curve

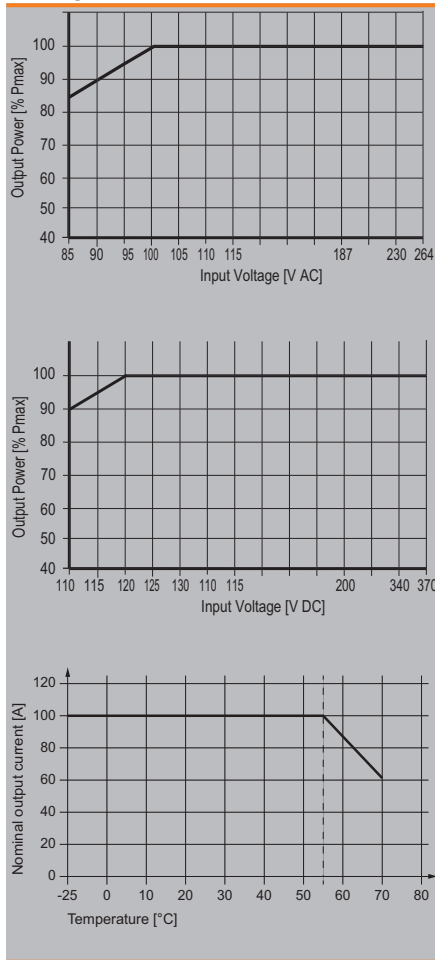

Technical data

General data	
Ambient temperature (operational)	-25 °C...70 °C
Storage temperature	-40 °C...85 °C
Humidity	5...95 % rel. humidity, no condensation
Protection degree	IP20
Protection class	II
Pollution degree	1
Insulation voltage, input/output	3.5 kV
Parallel connection option	yes, max. 3
Housing version	Plastic, protective insulation
Mounting position, installation notice	Horizontal on TS35 mounting rail. 50 mm of clearance at top & bottom for air circ. Can mount side by side with no space in between.
Short-circuit protection	Yes
Overload protection	Yes
Protection against over-heating	Yes
EMC / shock / vibration	
Noise emission in accordance with EN55032	Class B
Resistance to vibration / Shock	0.7 g according to EN 50178 / 30 g in all directions
Electrical safety (applied standards)	
For use with electronic equipment	Acc. to EN50178
Safety extra-low voltage	IEC 61010-1, IEC 61010-2-201
Safety transformers for switch-mode power supplies	According to EN 61558-2-16

connectPower PRObas

PRO BAS 30W 24V 1.3A

PRO BAS 30W 12V 2.6A

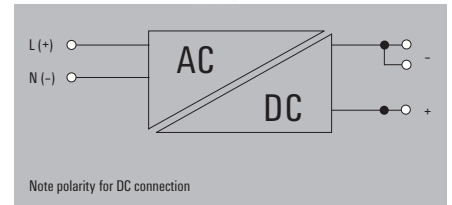
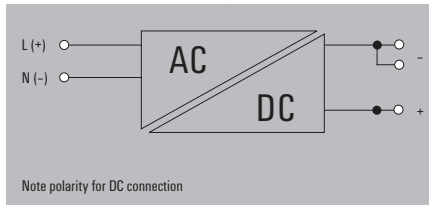

Technical data

Input	
Rated input voltage	110...240 V AC / 120...340 V DC
Input voltage range AC	85...264 V AC (derating at 100 V AC)
Frequency range AC	45...65 Hz
DC input voltage range	110...370 V DC (derating at <120 V DC)
Current consumption in relation to the input voltage	0.33A @ 230VAC; 0.55A @ 115VAC; 0.29A @ 120V
Input fuse (internal) / Inrush current	Yes / 40 A @ 230 V AC, 25 °C
Output	
Rated output voltage	24 V DC
Output voltage	22...28 V
Residual ripple, breaking spikes	≤ 50 mVpp @ full load
Nominal output current for U_{nom}	1.3 A @ 55 °C
Continuous output current @ $U_{Nominal}$	1.3 A @ 55 °C, 0.8 A @ 70 °C
Capacitive load	5.5mF
Protection against inverse voltage	Yes
Signalling	
Status indication	Green LED
Floating contact / Contact load	No /
MTBF	
According to Standard	SN 29500
Operating time (hours), min.	1.56Mh
Ambient temperature	40°C
Input voltage	230V
Output power	30W
Duty cycle	100%
General data	
Degree of efficiency	89% @ 230 V AC
Power loss idling / nominal load / Power loss, nominal load	0.5 W / 3.3 W
Earth leakage current, max.	3.5 mA
Power factor (approx.)	0.45 @ 120 V AC, 0.47 @ 230 V AC
AC failure bridging time @ I_{nom}	> 80 ms @ 230 V AC / > 20 ms @ 115 V AC
Parallel connection option	yes, max. 3
Depth x width x height / Net weight	85 / 23 / 90 mm / 163 g
Approvals	
Approvals	cCSAus; cULus
Connection data	
Connection system	Screw connection
Number of terminals	2 (L,N)
Wire cross-section, rigid min/max	0.5 / 6 mm ²
Wire cross-section, flexible min/max	0.5 / 6 mm ²
Wire cross-section, AWG/kcmil min/max	26 / 12
Tightening torque range	/
Note	

Input		Output	
Connection system	Screw connection	Connection system	Screw connection
Number of terminals	2 (L,N)	Number of terminals	4 (++ / -)
Wire cross-section, rigid min/max	0.5 / 6	Wire cross-section, rigid min/max	0.5 / 6
Wire cross-section, flexible min/max	0.5 / 6	Wire cross-section, flexible min/max	0.5 / 6
Wire cross-section, AWG/kcmil min/max	26 / 12	Wire cross-section, AWG/kcmil min/max	26 / 12
Tightening torque range	/	Tightening torque range	0.5 / 0.6

Input		Output	
Rated input voltage	110...240 V AC / 120...340 V DC	Rated output voltage	12 V DC
Input voltage range AC	85...264 V AC (derating at 100 V AC)	Output voltage	9...16 V
Frequency range AC	45...65 Hz	Residual ripple, breaking spikes	≤ 50 mVpp @ full load
DC input voltage range	110...370 V DC (derating at <120 V DC)	Nominal output current for U_{nom}	2.6 A @ 55 °C
Current consumption in relation to the input voltage	0.33A @ 230VAC; 0.56A @ 115VAC; 0.29A @ 120V	Continuous output current @ $U_{Nominal}$	2.6 A @ 55 °C, 1.625 A @ 70 °C
Input fuse (internal) / Inrush current	Yes / 40 A @ 230 V AC, 25 °C	Capacitive load	5.5mF
Protection against inverse voltage	Yes	Protection against inverse voltage	Yes
Signalling		Signalling	
Status indication	Green LED	Status indication	Green LED
Floating contact / Contact load	No /	Floating contact / Contact load	No /
MTBF		MTBF	
According to Standard	SN 29500	According to Standard	SN 29500
Operating time (hours), min.	1.63Mh	Operating time (hours), min.	1.63Mh
Ambient temperature	40°C	Ambient temperature	40°C
Input voltage	230V	Input voltage	230V
Output power	30W	Output power	30W
Duty cycle	100%	Duty cycle	100%
General data		General data	
Degree of efficiency	89% @ 230 V AC	Degree of efficiency	89% @ 230 V AC
Power loss idling / nominal load / Power loss, nominal load	0.5 W / 3.3 W	Power loss idling / nominal load / Power loss, nominal load	0.5 W / 3.3 W
Earth leakage current, max.	3.5 mA	Earth leakage current, max.	3.5 mA
Power factor (approx.)	0.45 @ 120 V AC, 0.47 @ 230 V AC	Power factor (approx.)	0.45 @ 120 V AC, 0.48 @ 230 V AC
AC failure bridging time @ I_{nom}	> 80 ms @ 230 V AC / > 20 ms @ 115 V AC	AC failure bridging time @ I_{nom}	> 80 ms @ 230 V AC / > 20 ms @ 115 V AC
Parallel connection option	yes, max. 3	Parallel connection option	yes, max. 3
Depth x width x height / Net weight	85 / 23 / 90 mm / 163 g	Depth x width x height / Net weight	85 / 23 / 90 mm / 163 g
Approvals		Approvals	
Approvals	cCSAus; cULus	Approvals	cCSAus; cULus

Ordering data

Type	Qty.	Order No.
PRO BAS 30W 24V 1.3A	1	2838500000

Type	Qty.	Order No.
PRO BAS 30W 12V 2.6A	1	2838510000

Type	Qty.	Order No.
PRO BAS 30W 12V 2.6A	1	2838510000

Note

Current technical data at catalog.weidmueller.com

Current technical data at catalog.weidmueller.com

connectPower PRObas

connectPower PRObas

PRO BAS 30W 5V 6A

PRO BAS 60W 24V 2.5A

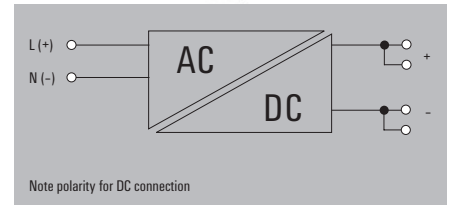
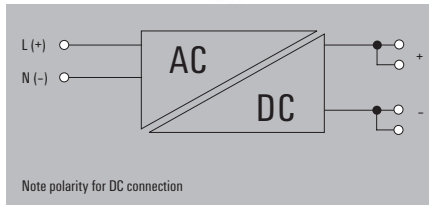

Technical data

Input	
Rated input voltage	110...240 V AC / 120...340 V DC
Input voltage range AC	85...264 V AC (derating at 100 V AC)
Frequency range AC	45...65 Hz
DC input voltage range	110...370 V DC (derating at <120 V DC)
Current consumption in relation to the input voltage	0.34A @ 230VAC; 0.56A @ 115VAC; 0.28A @ 120V
Input fuse (internal) / Inrush current	Yes / 40 A @ 230 V AC, 25 °C
Output	
Rated output voltage	5 V DC
Output voltage	3...8 V
Residual ripple, breaking spikes	≤ 50 mVpp @ full load
Nominal output current for U _{nom}	6 A @ 55 °C
Continuous output current @ U _{Nominal}	6 A @ 55 °C, 3.75 A @ 70 °C
Capacitive load	5.5mF
Protection against inverse voltage	Yes
Signalling	
Status indication	Green LED
Floating contact / Contact load	No /
MTBF	
According to Standard	SN 29500
Operating time (hours), min.	1.9Mh
Ambient temperature	40°C
Input voltage	230V
Output power	30W
Duty cycle	100%
General data	
Degree of efficiency	87% @ 230 V AC
Power loss idling / nominal load / Power loss, nominal load	0.5 W / 3.9 W
Earth leakage current, max.	3.5 mA
Power factor (approx.)	0.45 @ 120 V AC, 0.45 @ 230 V AC
AC failure bridging time @ I _{nom}	> 80 ms @ 230 V AC / > 20 ms @ 115 V AC
Parallel connection option	yes, max. 3
Depth x width x height / Net weight	85 / 36 / 90 mm / 245 g
Approvals	
Approvals	cCSAus
Connection data	
Connection system	Screw connection
Number of terminals	2 (L,N)
Wire cross-section, rigid min/max	0.5 / 6 mm ²
Wire cross-section, flexible min/max	0.5 / 6 mm ²
Wire cross-section, AWG/kcmil min/max	26 / 12
Tightening torque range	/
Note	

Input		Output	
Rated input voltage	110...240 V AC / 120...340 V DC	Rated output voltage	5 V DC
Input voltage range AC	85...264 V AC (derating at 100 V AC)	Output voltage	3...8 V
Frequency range AC	45...65 Hz	Residual ripple, breaking spikes	≤ 50 mVpp @ full load
DC input voltage range	110...370 V DC (derating at <120 V DC)	Nominal output current for U _{nom}	6 A @ 55 °C
Current consumption in relation to the input voltage	0.34A @ 230VAC; 0.56A @ 115VAC; 0.28A @ 120V	Continuous output current @ U _{Nominal}	6 A @ 55 °C, 3.75 A @ 70 °C
Input fuse (internal) / Inrush current	Yes / 40 A @ 230 V AC, 25 °C	Capacitive load	5.5mF
		Protection against inverse voltage	Yes
Signalling			
Status indication	Green LED	Floating contact / Contact load	No /
Floating contact / Contact load	No /		
MTBF			
According to Standard	SN 29500	Operating time (hours), min.	1.9Mh
Operating time (hours), min.	1.9Mh	Ambient temperature	40°C
Ambient temperature	40°C	Input voltage	230V
Input voltage	230V	Output power	30W
Output power	30W	Duty cycle	100%
Duty cycle	100%		
General data			
Degree of efficiency	87% @ 230 V AC	Power loss idling / nominal load / Power loss, nominal load	0.5 W / 3.9 W
Power loss idling / nominal load / Power loss, nominal load	0.5 W / 3.9 W	Earth leakage current, max.	3.5 mA
Earth leakage current, max.	3.5 mA	Power factor (approx.)	0.45 @ 120 V AC, 0.45 @ 230 V AC
Power factor (approx.)	0.45 @ 120 V AC, 0.45 @ 230 V AC	AC failure bridging time @ I _{nom}	> 80 ms @ 230 V AC / > 20 ms @ 115 V AC
AC failure bridging time @ I _{nom}	> 80 ms @ 230 V AC / > 20 ms @ 115 V AC	Parallel connection option	yes, max. 3
Parallel connection option	yes, max. 3	Depth x width x height / Net weight	85 / 36 / 90 mm / 245 g
Depth x width x height / Net weight	85 / 36 / 90 mm / 245 g		
Approvals			
Approvals	cCSAus		
Connection data			
Connection system	Screw connection	Connection system	Screw connection
Number of terminals	2 (L,N)	Number of terminals	4 (++, -)
Wire cross-section, rigid min/max	0.5 / 6 mm ²	Wire cross-section, rigid min/max	0.5 / 6 mm ²
Wire cross-section, flexible min/max	0.5 / 6 mm ²	Wire cross-section, flexible min/max	0.5 / 6 mm ²
Wire cross-section, AWG/kcmil min/max	26 / 12	Wire cross-section, AWG/kcmil min/max	26 / 12
Tightening torque range	/	Tightening torque range	/
Note			

Input		Output	
Rated input voltage	110...240 V AC / 120...340 V DC	Rated output voltage	24 V DC
Input voltage range AC	85...264 V AC (derating at 100 V AC)	Output voltage	22...28 V
Frequency range AC	45...65 Hz	Residual ripple, breaking spikes	≤ 50 mVpp @ full load
DC input voltage range	110...370 V DC (derating at <120 V DC)	Nominal output current for U _{nom}	2.5 A @ 55 °C
Current consumption in relation to the input voltage	0.61A @ 230VAC; 1.01A @ 115VAC; 0.54A @ 120V	Continuous output current @ U _{Nominal}	2.5 A @ 55 °C, 1.65 A @ 70 °C
Input fuse (internal) / Inrush current	Yes / 40 A @ 230 V AC, 25 °C	Capacitive load	5.5mF
		Protection against inverse voltage	Yes
Signalling			
Status indication	Green LED	Floating contact / Contact load	No /
Floating contact / Contact load	No /		
MTBF			
According to Standard	SN 29500	Operating time (hours), min.	1.4Mh
Operating time (hours), min.	1.4Mh	Ambient temperature	40°C
Ambient temperature	40°C	Input voltage	230V
Input voltage	230V	Output power	60W
Output power	60W	Duty cycle	100%
Duty cycle	100%		
General data			
Degree of efficiency	90% @ 230 V AC	Power loss idling / nominal load / Power loss, nominal load	0.5 W / 6 W
Power loss idling / nominal load / Power loss, nominal load	0.5 W / 6 W	Earth leakage current, max.	3.5 mA
Earth leakage current, max.	3.5 mA	Power factor (approx.)	0.45 @ 120 V AC, 0.47 @ 230 V AC
Power factor (approx.)	0.45 @ 120 V AC, 0.47 @ 230 V AC	AC failure bridging time @ I _{nom}	> 80 ms @ 230 V AC / > 20 ms @ 115 V AC
AC failure bridging time @ I _{nom}	> 80 ms @ 230 V AC / > 20 ms @ 115 V AC	Parallel connection option	yes, max. 3
Parallel connection option	yes, max. 3	Depth x width x height / Net weight	85 / 36 / 90 mm / 259 g
Depth x width x height / Net weight	85 / 36 / 90 mm / 259 g		
Approvals			
Approvals	cCSAus; cULus		
Connection data			
Connection system	Screw connection	Connection system	Screw connection
Number of terminals	2 (L,N)	Number of terminals	4 (++, -)
Wire cross-section, rigid min/max	0.5 / 6 mm ²	Wire cross-section, rigid min/max	0.5 / 6 mm ²
Wire cross-section, flexible min/max	0.5 / 6 mm ²	Wire cross-section, flexible min/max	0.5 / 6 mm ²
Wire cross-section, AWG/kcmil min/max	26 / 12	Wire cross-section, AWG/kcmil min/max	26 / 12
Tightening torque range	/	Tightening torque range	/
Note			

Ordering data

Type	Qty.	Order No.
PRO BAS 30W 5V 6A	1	2838400000
Note		
Current technical data at catalog.weidmueller.com		

Type	Qty.	Order No.
PRO BAS 60W 24V 2.5A	1	2838410000
Note		
Current technical data at catalog.weidmueller.com		

Type	Qty.	Order No.
PRO BAS 60W 24V 2.5A	1	2838410000
Note		
Current technical data at catalog.weidmueller.com		

connectPower PRObas

PRO BAS 60W 12V 5A

PRO BAS 90W 24V 3.8A

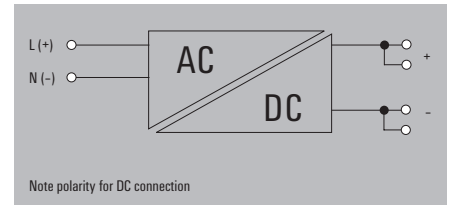
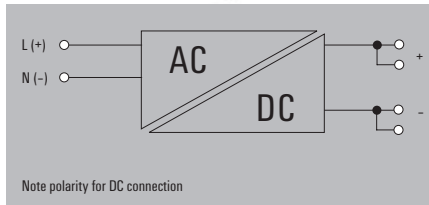

Technical data

Input	
Rated input voltage	110...240 V AC / 120...340 V DC
Input voltage range AC	85...264 V AC (derating at 100 V AC)
Frequency range AC	45...65 Hz
DC input voltage range	110...370 V DC (derating at <120 V DC)
Current consumption in relation to the input voltage	0.62A @ 230VAC; 1.04A @ 115VAC; 0.55A @ 120V
Input fuse (internal) / Inrush current	Yes / 40 A @ 230 V AC, 25 °C
Output	
Rated output voltage	12 V DC
Output voltage	9...16 V
Residual ripple, breaking spikes	≤ 50 mVpp @ full load
Nominal output current for U _{nom}	5 A @ 55 °C
Continuous output current @ U _{Nominal}	5 A @ 55 °C, 3.125 A @ 70°C
Capacitive load	5.5mF
Protection against inverse voltage	Yes
Signalling	
Status indication	Green LED
Floating contact / Contact load	No /
MTBF	
According to Standard	SN 29500
Operating time (hours), min.	1.3Mh
Ambient temperature	40°C
Input voltage	230V
Output power	60W
Duty cycle	100%
General data	
Degree of efficiency	90% @ 230 V AC
Power loss idling / nominal load / Power loss, nominal load	0.5 W / 6 W
Earth leakage current, max.	3.5 mA
Power factor (approx.)	0.45 @ 120 V AC, 0.47 @ 230 V AC
AC failure bridging time @ I _{nom}	> 80 ms @ 230 V AC / > 20 ms @ 115 V AC
Parallel connection option	yes, max. 3
Depth x width x height / Net weight	85 / 36 / 90 mm / 259 g
Approvals	
Approvals	cCSAus; cULus
Connection data	
Connection system	Screw connection
Number of terminals	2 (L,N)
Wire cross-section, rigid min/max	0.5 / 6 mm ²
Wire cross-section, flexible min/max	0.5 / 6 mm ²
Wire cross-section, AWG/kcmil min/max	26 / 12
Tightening torque range	/
Note	

Ordering data

Type	Qty.	Order No.
PRO BAS 60W 12V 5A	1	2838420000
Note		
Current technical data at catalog.weidmuller.com		

Input	
Rated input voltage	110...240 V AC / 120...340 V DC
Input voltage range AC	85...264 V AC (derating at 100 V AC)
Frequency range AC	45...65 Hz
DC input voltage range	110...370 V DC (derating at <120 V DC)
Current consumption in relation to the input voltage	0.62A @ 230VAC; 1.04A @ 115VAC; 0.55A @ 120V
Input fuse (internal) / Inrush current	Yes / 40 A @ 230 V AC, 25 °C
Output	
Rated output voltage	24 V DC
Output voltage	22...25 V
Residual ripple, breaking spikes	≤ 50 mVpp @ full load
Nominal output current for U _{nom}	3.8 A @ 55 °C
Continuous output current @ U _{Nominal}	3.8 A @ 55 °C, 2.375 A @ 70°C
Capacitive load	5.5mF
Protection against inverse voltage	Yes
Signalling	
Status indication	Green LED
Floating contact / Contact load	No /
MTBF	
According to Standard	SN 29500
Operating time (hours), min.	1.23Mh
Ambient temperature	40°C
Input voltage	230V
Output power	90W
Duty cycle	100%
General data	
Degree of efficiency	89.4% @ 230 V AC
Power loss idling / nominal load / Power loss, nominal load	0.5 W / 9.5 W
Earth leakage current, max.	3.5 mA
Power factor (approx.)	0.45 @ 120 V AC, 0.47 @ 230 V AC
AC failure bridging time @ I _{nom}	> 80 ms @ 230 V AC / > 20 ms @ 115 V AC
Parallel connection option	yes, max. 3
Depth x width x height / Net weight	85 / 47 / 90 mm / 376 g
Approvals	
Approvals	cCSAus; cULus
Connection data	
Connection system	Screw connection
Number of terminals	2 (L,N)
Wire cross-section, rigid min/max	0.5 / 6 mm ²
Wire cross-section, flexible min/max	0.5 / 6 mm ²
Wire cross-section, AWG/kcmil min/max	26 / 12
Tightening torque range	/
Note	

Type	Qty.	Order No.
PRO BAS 90W 24V 3.8A	1	2838430000
Note		
Current technical data at catalog.weidmuller.com		

connectPower PRObas

connectPower PRObas

PRO BAS 120W 24V 5A

PRO BAS 120W 12V 10A

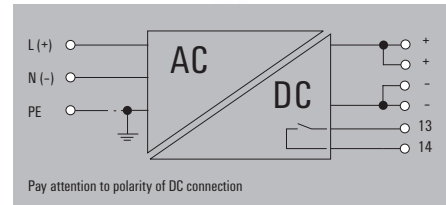
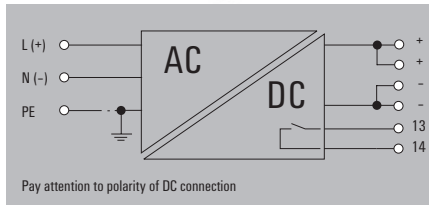

Technical data

Input	
Rated input voltage	110...240 V AC / 120...340 V DC
Input voltage range AC	85...264 V AC (derating at 100 V AC)
Frequency range AC	45...65 Hz
DC input voltage range	110...370 V DC (derating at <120 V DC)
Current consumption in relation to the input voltage	1.13A @ 230VAC; 2.02A @ 115VAC; 1.11A @ 120V
Input fuse (internal) / Inrush current	Yes / 40 A @ 230 V AC, 25 °C
Output	
Rated output voltage	24 V DC
Output voltage	22...28 V
Residual ripple, breaking spikes	≤ 50 mVpp @ full load
Nominal output current for U_{nom}	5 A @ 55 °C
Continuous output current @ $U_{nominal}$	5 A @ 55 °C, 3.125 A @ 70°C
Capacitive load	5.5mF
Protection against inverse voltage	Yes
Signalling	
Status indication	Green LED
Floating contact / Contact load	Yes / max. 30 V DC / 1 A
MTBF	
According to Standard	SN 29500
Operating time (hours), min.	814.2kh
Ambient temperature	40°C
Input voltage	230V
Output power	120W
Duty cycle	100%
General data	
Degree of efficiency	90% @ 230 V AC
Power loss idling / nominal load / Power loss, nominal load	1.5 W / 14.5 W
Earth leakage current, max.	3.5 mA
Power factor (approx.)	0.5 @ 120 V AC, 0.51 @ 230 V AC
AC failure bridging time @ I_{nom}	> 80 ms @ 230 V AC / > 20 ms @ 115 V AC
Parallel connection option	yes, max. 3
Depth x width x height / Net weight	100 / 40 / 130 mm / 490 g
Approvals	
Approvals	cCSAus; cULus
Connection data	
Connection system	Screw connection
Number of terminals	3 for L/N/PE
Wire cross-section, rigid min/max	0.5 / 6 mm ²
Wire cross-section, flexible min/max	0.5 / 6 mm ²
Wire cross-section, AWG/kcmil min/max	26 / 12
Tightening torque range	/
Note	

Input		Output	
Connection system	Screw connection	Connection system	Screw connection
Number of terminals	3 for L/N/PE	Number of terminals	4 (++ / -)
Wire cross-section, rigid min/max	0.5 / 6	Wire cross-section, rigid min/max	0.5 / 6
Wire cross-section, flexible min/max	0.5 / 6	Wire cross-section, flexible min/max	0.5 / 6
Wire cross-section, AWG/kcmil min/max	26 / 12	Wire cross-section, AWG/kcmil min/max	26 / 12
Tightening torque range	/	Tightening torque range	0.5 / 0.6

Input		Output	
Rated input voltage	110...240 V AC / 120...340 V DC	Rated output voltage	12 V DC
Input voltage range AC	85...264 V AC (derating at 100 V AC)	Output voltage	9...16 V
Frequency range AC	45...65 Hz	Residual ripple, breaking spikes	≤ 50 mVpp @ full load
DC input voltage range	110...370 V DC (derating at <120 V DC)	Nominal output current for U_{nom}	10 A @ 55 °C
Current consumption in relation to the input voltage	1.14A @ 230VAC; 2.04A @ 115VAC; 1.12A @ 120V	Continuous output current @ $U_{nominal}$	10 A @ 55 °C, 6.25 A @ 70°C
Input fuse (internal) / Inrush current	Yes / 40 A @ 230 V AC, 25 °C	Capacitive load	5.5mF
Protection against inverse voltage	Yes	Protection against inverse voltage	Yes
Signalling		Signalling	
Status indication	Green LED	Status indication	Green LED
Floating contact / Contact load	Yes / max. 30 V DC / 1 A	Floating contact / Contact load	Yes / max. 30 V DC / 1 A
MTBF		MTBF	
According to Standard	SN 29500	According to Standard	SN 29500
Operating time (hours), min.	901.4kh	Operating time (hours), min.	901.4kh
Ambient temperature	40°C	Ambient temperature	40°C
Input voltage	230V	Input voltage	230V
Output power	120W	Output power	120W
Duty cycle	100%	Duty cycle	100%
General data		General data	
Degree of efficiency	90% @ 230 V AC	Degree of efficiency	90% @ 230 V AC
Power loss idling / nominal load / Power loss, nominal load	1.2 W / 15.4 W	Power loss idling / nominal load / Power loss, nominal load	1.2 W / 15.4 W
Earth leakage current, max.	3.5 mA	Earth leakage current, max.	3.5 mA
Power factor (approx.)	0.5 @ 120 V AC, 0.51 @ 230 V AC	Power factor (approx.)	0.5 @ 120 V AC, 0.51 @ 230 V AC
AC failure bridging time @ I_{nom}	> 80 ms @ 230 V AC / > 20 ms @ 115 V AC	AC failure bridging time @ I_{nom}	> 80 ms @ 230 V AC / > 20 ms @ 115 V AC
Parallel connection option	yes, max. 3	Parallel connection option	yes, max. 3
Depth x width x height / Net weight	100 / 40 / 130 mm / 490 g	Depth x width x height / Net weight	100 / 40 / 130 mm / 490 g
Approvals		Approvals	
Approvals	cCSAus; cULus	Approvals	cCSAus; cULus

Ordering data

Type	Qty.	Order No.
PRO BAS 120W 24V 5A	1	2838440000

Type	Qty.	Order No.
PRO BAS 120W 24V 5A	1	2838440000

Type	Qty.	Order No.
PRO BAS 120W 12V 10A	1	2838450000

Note

Current technical data at catalog.weidmueller.com

Current technical data at catalog.weidmueller.com

connectPower PRObas

PRO BAS 240W 24V 10A

PRO BAS 240W 48V 5A

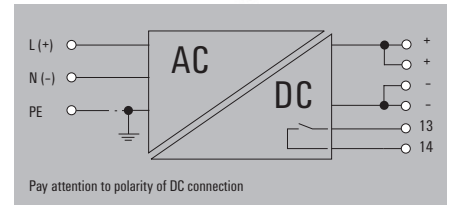
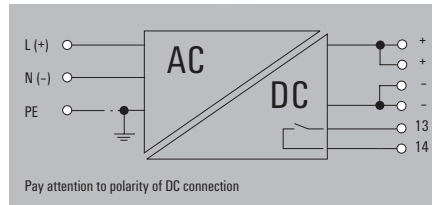

Technical data

Input	
Rated input voltage	110...240 V AC / 120...340 V DC
Input voltage range AC	85...264 V AC (derating at 100 V AC)
Frequency range AC	45...65 Hz
DC input voltage range	110...370 V DC (derating at <120 V DC)
Current consumption in relation to the input voltage	1.13A @ 230VAC; 2.29A @ 115VAC; 2.3A @ 120V
Input fuse (internal) / Inrush current	Yes / 20 A @ 230 V AC, 25 °C
Output	
Rated output voltage	24 V DC
Output voltage	22...28 V
Residual ripple, breaking spikes	≤ 100 mVpp @ full Load
Nominal output current for U_{nom}	10 A @ 55 °C
Continuous output current @ $U_{nominal}$	10 A @ 55 °C, 6.25 A @ 70°C
Capacitive load	5.5mF
Protection against inverse voltage	Yes
Signalling	
Status indication	Green LED
Floating contact / Contact load	Yes / max. 30 V DC / 1 A
MTBF	
According to Standard	SN 29500
Operating time (hours), min.	987.3kh
Ambient temperature	40°C
Input voltage	230V
Output power	240W
Duty cycle	100%
General data	
Degree of efficiency	94% @ 230 V AC
Power loss idling / nominal load / Power loss, nominal load	2 W / 19.5 W
Earth leakage current, max.	3.5 mA
Power factor (approx.)	0.95 @ 230 V AC, nominal load
AC failure bridging time @ I_{nom}	> 80 ms @ 230 V AC / > 20 ms @ 115 V AC
Parallel connection option	yes, max. 3
Depth x width x height / Net weight	100 / 52 / 130 mm / 693 g
Approvals	
Approvals	cCSAus; cULus
Connection data	
Connection system	Screw connection
Number of terminals	3 for L/N/PE
Wire cross-section, rigid min/max	0.5 / 6 mm ²
Wire cross-section, flexible min/max	0.5 / 6 mm ²
Wire cross-section, AWG/kcmil min/max	26 / 12
Tightening torque range	/
Note	

Input		Output	
Connection system	Screw connection	Connection system	Screw connection
Number of terminals	3 for L/N/PE	Number of terminals	4 (++ / -)
Wire cross-section, rigid min/max	0.5 / 6	Wire cross-section, rigid min/max	0.5 / 6
Wire cross-section, flexible min/max	0.5 / 6	Wire cross-section, flexible min/max	0.5 / 6
Wire cross-section, AWG/kcmil min/max	26 / 12	Wire cross-section, AWG/kcmil min/max	26 / 12
Tightening torque range	/	Tightening torque range	0.5 / 0.6

Input		Output	
Rated input voltage	110...240 V AC / 120...340 V DC	Rated output voltage	48 V DC
Input voltage range AC	85...264 V AC (derating at 100 V AC)	Output voltage	36...56 V
Frequency range AC	45...65 Hz	Residual ripple, breaking spikes	≤ 100 mVpp @ full Load
DC input voltage range	110...370 V DC (derating at <120 V DC)	Nominal output current for U_{nom}	5 A @ 55 °C
Current consumption in relation to the input voltage	1.14A @ 230VAC; 2.3A @ 115VAC; 2.22A @ 120V	Continuous output current @ $U_{nominal}$	5 A @ 55 °C, 3.125 A @ 70°C
Input fuse (internal) / Inrush current	Yes / 20 A @ 230 V AC, 25 °C	Capacitive load	5.5mF
Protection against inverse voltage	Yes	Protection against inverse voltage	Yes
Signalling		Signalling	
Status indication	Green LED	Status indication	Green LED
Floating contact / Contact load	Yes / max. 30 V DC / 1 A	Floating contact / Contact load	Yes / max. 30 V DC / 1 A
MTBF		MTBF	
According to Standard	SN 29500	According to Standard	SN 29500
Operating time (hours), min.	971kh	Operating time (hours), min.	971kh
Ambient temperature	40°C	Ambient temperature	40°C
Input voltage	230V	Input voltage	230V
Output power	240W	Output power	240W
Duty cycle	100%	Duty cycle	100%
General data		General data	
Degree of efficiency	95% @ 230 V AC	Degree of efficiency	95% @ 230 V AC
Power loss idling / nominal load / Power loss, nominal load	2 W / 19.2 W	Power loss idling / nominal load / Power loss, nominal load	2 W / 19.2 W
Earth leakage current, max.	3.5 mA	Earth leakage current, max.	3.5 mA
Power factor (approx.)	0.95 @ 230 V AC, nominal load	Power factor (approx.)	0.95 @ 230 V AC, nominal load
AC failure bridging time @ I_{nom}	> 80 ms @ 230 V AC / > 20 ms @ 115 V AC	AC failure bridging time @ I_{nom}	> 80 ms @ 230 V AC / > 20 ms @ 115 V AC
Parallel connection option	yes, max. 3	Parallel connection option	yes, max. 3
Depth x width x height / Net weight	100 / 52 / 130 mm / 693 g	Depth x width x height / Net weight	100 / 52 / 130 mm / 693 g
Approvals		Approvals	
Approvals	cCSAus; cULus	Approvals	cCSAus; cULus

Ordering data

Type	Qty.	Order No.
PRO BAS 240W 24V 10A	1	2838460000

Type	Qty.	Order No.
PRO BAS 240W 24V 10A	1	2838460000

Type	Qty.	Order No.
PRO BAS 240W 48V 5A	1	2838470000

Note

Current technical data at catalog.weidmueller.com

Current technical data at catalog.weidmueller.com

connectPower PRObas

connectPower PRObas

PRO BAS 480W 24V 20A

PRO BAS 480W 48V 10A

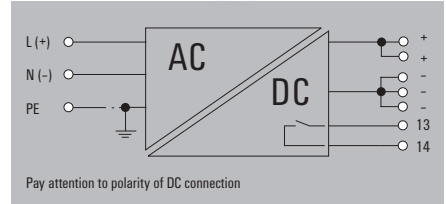
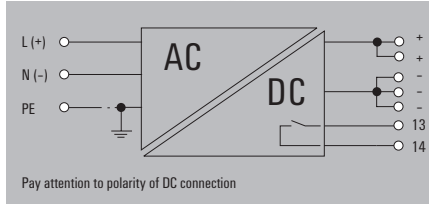

Technical data

Input	
Rated input voltage	110...240 V AC / 120...340 V DC
Input voltage range AC	85...264 V AC (derating at 100 V AC)
Frequency range AC	45...65 Hz
DC input voltage range	110...370 V DC (derating at <120 V DC)
Current consumption in relation to the input voltage	2.23A @ 230VAC; 4.58A @ 115VAC; 4.39A @ 120V
Input fuse (internal) / Inrush current	Yes / 20 A @ 230 V AC, 25 °C
Output	
Rated output voltage	24 V DC
Output voltage	22...28 V
Residual ripple, breaking spikes	≤ 100 mVpp @ full Load
Nominal output current for U _{nom}	20 A @ 55 °C
Continuous output current @ U _{Nominal}	20 A @ 55 °C, 12.5 A @ 70°C
Capacitive load	5.5mF
Protection against inverse voltage	Yes
Signalling	
Status indication	Green LED
Floating contact / Contact load	Yes / max. 30 V DC / 1 A
MTBF	
According to Standard	SN 29500
Operating time (hours), min.	563.3kh
Ambient temperature	40°C
Input voltage	230V
Output power	480W
Duty cycle	100%
General data	
Degree of efficiency	95% @ 230 V AC
Power loss idling / nominal load / Power loss, nominal load	2 W / 30 W
Earth leakage current, max.	3.5 mA
Power factor (approx.)	0.95 @ 230 V AC, nominal load
AC failure bridging time @ I _{nom}	> 80 ms @ 230 V AC / > 20 ms @ 115 V AC
Parallel connection option	yes, max. 3
Depth x width x height / Net weight	125 / 59 / 130 mm / 1380 g
Approvals	
Approvals	cCSAus; cULus
Connection data	
Connection system	Screw connection
Number of terminals	3 for L/N/PE
Wire cross-section, rigid min/max	0.18 / 6 mm ²
Wire cross-section, flexible min/max	0.18 / 6 mm ²
Wire cross-section, AWG/kcmil min/max	26 / 10
Tightening torque range	/
Note	

Input	
Rated input voltage	110...240 V AC / 120...340 V DC
Input voltage range AC	85...264 V AC (derating at 100 V AC)
Frequency range AC	45...65 Hz
DC input voltage range	110...370 V DC (derating at <120 V DC)
Current consumption in relation to the input voltage	2.23A @ 230VAC; 4.58A @ 115VAC; 4.39A @ 120V
Input fuse (internal) / Inrush current	Yes / 20 A @ 230 V AC, 25 °C
Output	
Rated output voltage	24 V DC
Output voltage	22...28 V
Residual ripple, breaking spikes	≤ 100 mVpp @ full Load
Nominal output current for U _{nom}	20 A @ 55 °C
Continuous output current @ U _{Nominal}	20 A @ 55 °C, 12.5 A @ 70°C
Capacitive load	5.5mF
Protection against inverse voltage	Yes
Signalling	
Status indication	Green LED
Floating contact / Contact load	Yes / max. 30 V DC / 1 A
MTBF	
According to Standard	SN 29500
Operating time (hours), min.	563.3kh
Ambient temperature	40°C
Input voltage	230V
Output power	480W
Duty cycle	100%
General data	
Degree of efficiency	95% @ 230 V AC
Power loss idling / nominal load / Power loss, nominal load	2 W / 30 W
Earth leakage current, max.	3.5 mA
Power factor (approx.)	0.95 @ 230 V AC, nominal load
AC failure bridging time @ I _{nom}	> 80 ms @ 230 V AC / > 20 ms @ 115 V AC
Parallel connection option	yes, max. 3
Depth x width x height / Net weight	125 / 59 / 130 mm / 1380 g
Approvals	
Approvals	cCSAus; cULus
Connection data	
Connection system	Screw connection
Number of terminals	3 for L/N/PE
Wire cross-section, rigid min/max	0.18 / 6 mm ²
Wire cross-section, flexible min/max	0.18 / 6 mm ²
Wire cross-section, AWG/kcmil min/max	26 / 10
Tightening torque range	/
Note	

Input	
Rated input voltage	110...240 V AC / 120...340 V DC
Input voltage range AC	85...264 V AC (derating at 100 V AC)
Frequency range AC	45...65 Hz
DC input voltage range	110...370 V DC (derating at <120 V DC)
Current consumption in relation to the input voltage	2.26A @ 230VAC; 4.58A @ 115VAC; 4.42A @ 120V
Input fuse (internal) / Inrush current	Yes / 20 A @ 230 V AC, 25 °C
Output	
Rated output voltage	48 V DC
Output voltage	36...56 V
Residual ripple, breaking spikes	≤ 100 mVpp @ full Load
Nominal output current for U _{nom}	10 A @ 55 °C
Continuous output current @ U _{Nominal}	10 A @ 55 °C, 6.25 A @ 70°C
Capacitive load	5.5mF
Protection against inverse voltage	Yes
Signalling	
Status indication	Green LED
Floating contact / Contact load	Yes / max. 30 V DC / 1 A
MTBF	
According to Standard	SN 29500
Operating time (hours), min.	674kh
Ambient temperature	40°C
Input voltage	230V
Output power	480W
Duty cycle	100%
General data	
Degree of efficiency	95% @ 230 V AC
Power loss idling / nominal load / Power loss, nominal load	2 W / 30 W
Earth leakage current, max.	3.5 mA
Power factor (approx.)	0.95 @ 230 V AC, nominal load
AC failure bridging time @ I _{nom}	> 80 ms @ 230 V AC / > 20 ms @ 115 V AC
Parallel connection option	yes, max. 3
Depth x width x height / Net weight	125 / 59 / 130 mm / 1380 g
Approvals	
Approvals	cCSAus; cULus
Connection data	
Connection system	Screw connection
Number of terminals	3 for L/N/PE
Wire cross-section, rigid min/max	0.18 / 6 mm ²
Wire cross-section, flexible min/max	0.18 / 6 mm ²
Wire cross-section, AWG/kcmil min/max	26 / 10
Tightening torque range	/
Note	

Ordering data

Type	Qty.	Order No.
PRO BAS 480W 24V 20A	1	2838480000
Note		
Current technical data at catalog.weidmueller.com		

Type	Qty.	Order No.
PRO BAS 480W 48V 10A	1	2838490000
Note		
Current technical data at catalog.weidmueller.com		

Type	Qty.	Order No.
PRO BAS 480W 48V 10A	1	2838490000
Note		
Current technical data at catalog.weidmueller.com		

PRO-PM – the efficient plate mounted power supply solution

Powering simple automation applications

A

Simple machines and automation applications require standard power supply solutions with basic functionalities. The new power supplies of the PRO-PM series offer an excellent price/performance ratio and are designed for reliable DC control voltage.

Due to the wide range of variants with output voltages of 5, 12, 24, and 48 V and extensive international approvals, they are suitable for use in many applications. The power range extends from 35 W to 350 W. The individual adaptability makes PRO-PM the right choice for many standard machines.

Your special advantages:

- Especially compact and robust metal housing
- Wide temperature range from -20°C to +70°C – for almost all industrial applications
- Certified according to CE, CCC, and cURus for universal worldwide use



Compact design

The low height of only 30 mm saves space and reduces overall system costs

Wide range of applications

The wide temperature range from -20°C to +70°C as well as international certificates such as CE, cURus, CCC etc. ensure reliable operation worldwide.



Especially economic

Thanks to the new „Design-to-Cost“ concept, PRO-PM power supplies offer a particularly favourable price/performance ratio.

Optimal for:

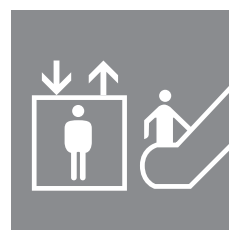

connectPower PRO-PM

connectPower PRO-PM

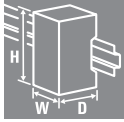

PRO PM 35W 5V 7A

PRO PM 35W 12V 3A

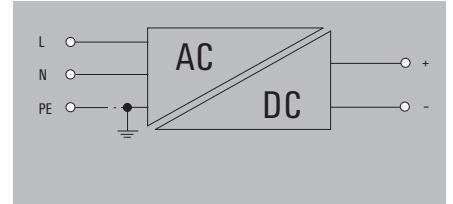
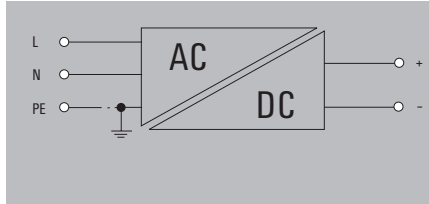

Technical data

Input	
Input voltage range AC	90...264 V AC
Frequency range AC	47...63 Hz
Rated input voltage	100...240 V AC
Recommended back-up fuse	2 A at 230 V AC, characteristic curve C
Output	
Output voltage	5 V DC
Output voltage adjustment	± 10% nominal output voltage tolerance, adjustable with potentiometer
Output current	7 A
Output power	35 W
Derating	> 50°C (2% / 1°C)
Residual ripple, breaking spikes	< 100 mV _{pp}
Overload protection	120%...180% I _{nominal} , hiccup mode with automatic recovery
Surge protection	5.6...6.8 V @ 5 V DC
Mains failure bridge-over time	20 ms
Parallel connection option	Yes, with diode module
General data	
Ambient temperature (operational)	-20 °C...70 °C
Storage temperature	-40 °C...85 °C
Humidity	5...95 % RH
Degree of efficiency	82 %
Status indication	LED green: ready
Mounting position, installation notice	Panel mount, screw fix
Net weight	223 g
Approvals	CE
Screw connection	
Connection cross-section, solid, min. / max.	0.34 / 4 mm ²
Depth x width x height	99 / 82 / 30 mm

Input	
Input voltage range AC	90...264 V AC
Frequency range AC	47...63 Hz
Rated input voltage	100...240 V AC
Recommended back-up fuse	2 A at 230 V AC, characteristic curve C
Output	
Output voltage	12 V DC
Output voltage adjustment	± 10% nominal output voltage tolerance, adjustable with potentiometer
Output current	3 A
Output power	35 W
Derating	> 50°C (2% / 1°C)
Residual ripple, breaking spikes	< 100 mV _{pp}
Overload protection	120%...180% I _{nominal} , hiccup mode with automatic recovery
Surge protection	13.5...16.2 V @ 12 V DC
Mains failure bridge-over time	20 ms
Parallel connection option	Yes, with diode module
General data	
Ambient temperature (operational)	-20 °C...70 °C
Storage temperature	-40 °C...85 °C
Humidity	5...95 % RH
Degree of efficiency	84 %
Status indication	LED green: ready
Mounting position, installation notice	Panel mount, screw fix
Net weight	220 g
Approvals	CE
Screw connection	
Connection cross-section, solid, min. / max.	0.34 / 4 mm ²
Depth x width x height	99 / 82 / 30 mm

Input	
Input voltage range AC	90...264 V AC
Frequency range AC	47...63 Hz
Rated input voltage	100...240 V AC
Recommended back-up fuse	2 A at 230 V AC, characteristic curve C
Output	
Output voltage	12 V DC
Output voltage adjustment	± 10% nominal output voltage tolerance, adjustable with potentiometer
Output current	3 A
Output power	35 W
Derating	> 50°C (2% / 1°C)
Residual ripple, breaking spikes	< 100 mV _{pp}
Overload protection	120%...180% I _{nominal} , hiccup mode with automatic recovery
Surge protection	13.5...16.2 V @ 12 V DC
Mains failure bridge-over time	20 ms
Parallel connection option	Yes, with diode module
General data	
Ambient temperature (operational)	-20 °C...70 °C
Storage temperature	-40 °C...85 °C
Humidity	5...95 % RH
Degree of efficiency	84 %
Status indication	LED green: ready
Mounting position, installation notice	Panel mount, screw fix
Net weight	220 g
Approvals	CE
Screw connection	
Connection cross-section, solid, min. / max.	0.34 / 4 mm ²
Depth x width x height	99 / 82 / 30 mm

Note

Note

Note

Ordering data

Note

Type	Qty.	Order No.
PRO PM 35W 5V 7A	1	2660200277
The internal varistor found in a switch-mode power supply does not replace the necessary surge protection in a system.		

Type	Qty.	Order No.
PRO PM 35W 12V 3A	1	2660200278
The internal varistor found in a switch-mode power supply does not replace the necessary surge protection in a system.		

connectPower PRO-PM

PRO PM 35W 24V 1.5A

PRO PM 35W 48V 0.75A

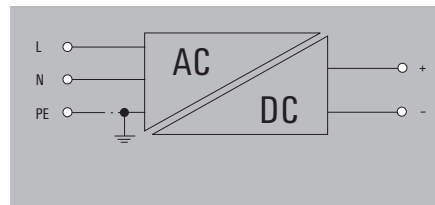
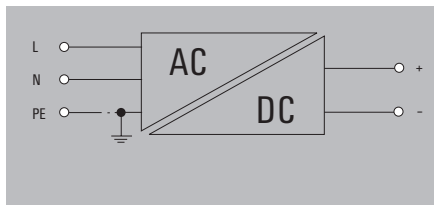
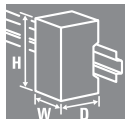

Technical data

Input	
Input voltage range AC	90...264 V AC
Frequency range AC	47...63 Hz
Rated input voltage	100...240 V AC
Recommended back-up fuse	2 A at 230 V AC, characteristic curve C
Output	
Output voltage	24 V DC
Output voltage adjustment	± 10% nominal output voltage tolerance, adjustable with potentiometer
Output current	1.5 A
Output power	35 W
Derating	> 50°C (2% / 1°C)
Residual ripple, breaking spikes	< 100 mV _{pp}
Overload protection	120%...180% I _{nominal} , hiccup mode with automatic recovery
Surge protection	28...32 V @ 24 V DC
Mains failure bridge-over time	20 ms
Parallel connection option	Yes, with diode module
General data	
Ambient temperature (operational)	-20 °C...70 °C
Storage temperature	-40 °C...85 °C
Humidity	5...95 % RH
Degree of efficiency	86%
Status indication	LED green: ready
Mounting position, installation notice	Panel mount, screw fix
Net weight	223 g
Approvals	CE
Screw connection	
Connection cross-section, solid, min. / max.	0.34 / 4 mm ²
Depth x width x height	99 / 82 / 30 mm

Input	
Input voltage range AC	90...264 V AC
Frequency range AC	47...63 Hz
Rated input voltage	100...240 V AC
Recommended back-up fuse	2 A at 230 V AC, characteristic curve C
Output	
Output voltage	48 V DC
Output voltage adjustment	± 10% nominal output voltage tolerance, adjustable with potentiometer
Output current	0.75 A
Output power	35 W
Derating	> 50°C (2% / 1°C)
Residual ripple, breaking spikes	< 150 mV _{pp}
Overload protection	120%...180% I _{nominal} , hiccup mode with automatic recovery
Surge protection	55...62 V @ 48 V DC
Mains failure bridge-over time	20 ms
Parallel connection option	Yes, with diode module
General data	
Ambient temperature (operational)	-20 °C...70 °C
Storage temperature	-40 °C...85 °C
Humidity	5...95 % RH
Degree of efficiency	86%
Status indication	LED green: ready
Mounting position, installation notice	Panel mount, screw fix
Net weight	223 g
Approvals	CE
Screw connection	
Connection cross-section, solid, min. / max.	0.34 / 4 mm ²
Depth x width x height	99 / 82 / 30 mm

Input	
Input voltage range AC	90...264 V AC
Frequency range AC	47...63 Hz
Rated input voltage	100...240 V AC
Recommended back-up fuse	2 A at 230 V AC, characteristic curve C
Output	
Output voltage	48 V DC
Output voltage adjustment	± 10% nominal output voltage tolerance, adjustable with potentiometer
Output current	0.75 A
Output power	35 W
Derating	> 50°C (2% / 1°C)
Residual ripple, breaking spikes	< 150 mV _{pp}
Overload protection	120%...180% I _{nominal} , hiccup mode with automatic recovery
Surge protection	55...62 V @ 48 V DC
Mains failure bridge-over time	20 ms
Parallel connection option	Yes, with diode module
General data	
Ambient temperature (operational)	-20 °C...70 °C
Storage temperature	-40 °C...85 °C
Humidity	5...95 % RH
Degree of efficiency	86%
Status indication	LED green: ready
Mounting position, installation notice	Panel mount, screw fix
Net weight	223 g
Approvals	CE
Screw connection	
Connection cross-section, solid, min. / max.	0.34 / 4 mm ²
Depth x width x height	99 / 82 / 30 mm

Note

Ordering data

Type	Qty.	Order No.
PRO PM 35W 24V 1.5A	1	2660200279

Note

The internal varistor found in a switch-mode power supply does not replace the necessary surge protection in a system.

Type	Qty.	Order No.
PRO PM 35W 48V 0.75A	1	2660200280

The internal varistor found in a switch-mode power supply does not replace the necessary surge protection in a system.

connectPower PRO-PM

connectPower PRO-PM

PRO PM 75W 5V 14A

PRO PM 75W 12V 6A

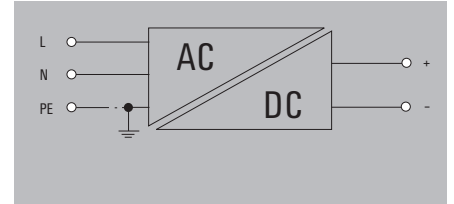
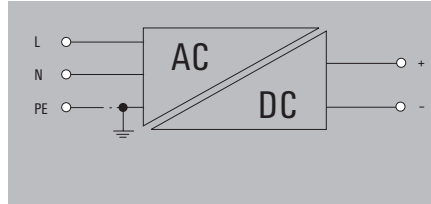
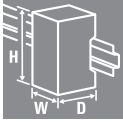

Technical data

Input	PRO PM 75W 5V 14A	PRO PM 75W 12V 6A
Input voltage range AC	90...264 V AC	90...264 V AC
Frequency range AC	47...63 Hz	47...63 Hz
Rated input voltage	100...240 V AC	100...240 V AC
Recommended back-up fuse	4 A at 230 V AC, characteristic curve C	4 A at 230 V AC, characteristic curve C
Output		
Output voltage	5 V DC	12 V DC
Output voltage adjustment	± 10% nominal output voltage tolerance, adjustable with potentiometer	± 10% nominal output voltage tolerance, adjustable with potentiometer
Output current	14 A	6 A
Output power	75 W	75 W
Derating	> 50°C (2% / 1°C)	> 50°C (2% / 1°C)
Residual ripple, breaking spikes	< 100 mV _{pp}	< 100 mV _{pp}
Overload protection	120%...180% I _{nominal} , hiccup mode with automatic recovery	120%...180% I _{nominal} , hiccup mode with automatic recovery
Surge protection	5.6...6.8 V @ 5 V DC	13.5...16.2 V @ 12 V DC
Mains failure bridge-over time	20 ms	20 ms
Parallel connection option	Yes, with diode module	Yes, with diode module
General data		
Ambient temperature (operational)	-20 °C...70 °C	-20 °C...70 °C
Storage temperature	-40 °C...85 °C	-40 °C...85 °C
Humidity	5...95 % RH	5...95 % RH
Degree of efficiency	82 %	84 %
Status indication	LED green: ready	LED green: ready
Mounting position, installation notice	Panel mount, screw fix	Panel mount, screw fix
Net weight	240 g	240 g
Approvals	CE	CE
Screw connection		
Connection cross-section, solid, min. / max.	0.34 / 4 mm ²	0.34 / 4 mm ²
Depth x width x height	99 / 97 / 30 mm	99 / 97 / 30 mm

Note

Ordering data

Type	Qty.	Order No.
PRO PM 75W 5V 14A	1	2660200281
The internal varistor found in a switch-mode power supply does not replace the necessary surge protection in a system.		
PRO PM 75W 12V 6A	1	2660200282
The internal varistor found in a switch-mode power supply does not replace the necessary surge protection in a system.		

Note

connectPower PRO-PM

PRO PM 75W 24V 3.2A

PRO PM 75W 48V 1.6A

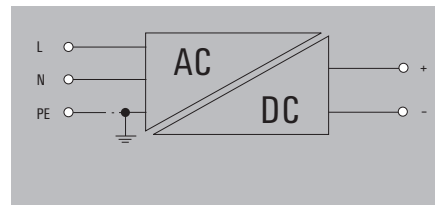
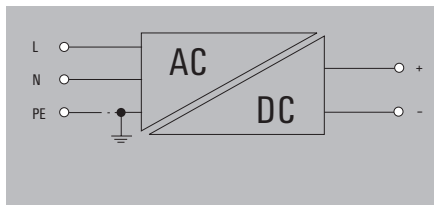

Technical data

Input	
Input voltage range AC	90...264 V AC
Frequency range AC	47...63 Hz
Rated input voltage	100...240 V AC
Recommended back-up fuse	4 A at 230 V AC, characteristic curve C
Output	
Output voltage	24 V DC
Output voltage adjustment	± 10% nominal output voltage tolerance, adjustable with potentiometer
Output current	3.2 A
Output power	75 W
Derating	> 50°C (2% / 1°C)
Residual ripple, breaking spikes	< 100 mV _{pp}
Overload protection	120%...180% I _{nominal} , hiccup mode with automatic recovery
Surge protection	28...32 V @ 24 V DC
Mains failure bridge-over time	20 ms
Parallel connection option	Yes, with diode module
General data	
Ambient temperature (operational)	-20 °C...70 °C
Storage temperature	-40 °C...85 °C
Humidity	5...95 % RH
Degree of efficiency	86%
Status indication	LED green: ready
Mounting position, installation notice	Panel mount, screw fix
Net weight	240 g
Approvals	CE
Screw connection	
Connection cross-section, solid, min. / max.	0.34 / 4 mm ²
Depth x width x height	99 / 97 / 30 mm

Input	
Input voltage range AC	90...264 V AC
Frequency range AC	47...63 Hz
Rated input voltage	100...240 V AC
Recommended back-up fuse	4 A at 230 V AC, characteristic curve C
Output	
Output voltage	48 V DC
Output voltage adjustment	± 10% nominal output voltage tolerance, adjustable with potentiometer
Output current	1.6 A
Output power	75 W
Derating	> 50°C (2% / 1°C)
Residual ripple, breaking spikes	< 150 mV _{pp}
Overload protection	120%...180% I _{nominal} , hiccup mode with automatic recovery
Surge protection	55...62 V @ 48 V DC
Mains failure bridge-over time	20 ms
Parallel connection option	Yes, with diode module
General data	
Ambient temperature (operational)	-20 °C...70 °C
Storage temperature	-40 °C...85 °C
Humidity	5...95 % RH
Degree of efficiency	86%
Status indication	LED green: ready
Mounting position, installation notice	Panel mount, screw fix
Net weight	240 g
Approvals	CE
Screw connection	
Connection cross-section, solid, min. / max.	0.34 / 4 mm ²
Depth x width x height	99 / 97 / 30 mm

Input	
Input voltage range AC	90...264 V AC
Frequency range AC	47...63 Hz
Rated input voltage	100...240 V AC
Recommended back-up fuse	4 A at 230 V AC, characteristic curve C
Output	
Output voltage	48 V DC
Output voltage adjustment	± 10% nominal output voltage tolerance, adjustable with potentiometer
Output current	1.6 A
Output power	75 W
Derating	> 50°C (2% / 1°C)
Residual ripple, breaking spikes	< 150 mV _{pp}
Overload protection	120%...180% I _{nominal} , hiccup mode with automatic recovery
Surge protection	55...62 V @ 48 V DC
Mains failure bridge-over time	20 ms
Parallel connection option	Yes, with diode module
General data	
Ambient temperature (operational)	-20 °C...70 °C
Storage temperature	-40 °C...85 °C
Humidity	5...95 % RH
Degree of efficiency	86%
Status indication	LED green: ready
Mounting position, installation notice	Panel mount, screw fix
Net weight	240 g
Approvals	CE
Screw connection	
Connection cross-section, solid, min. / max.	0.34 / 4 mm ²
Depth x width x height	99 / 97 / 30 mm

Note

Ordering data

Type	Qty.	Order No.
PRO PM 75W 24V 3.2A	1	2660200283

Note

Type	Qty.	Order No.
PRO PM 75W 24V 3.2A	1	2660200283

The internal varistor found in a switch-mode power supply does not replace the necessary surge protection in a system.

Type	Qty.	Order No.
PRO PM 75W 48V 1.6A	1	2660200284

The internal varistor found in a switch-mode power supply does not replace the necessary surge protection in a system.

connectPower PRO-PM

connectPower PRO-PM

PRO PM 100W 12V 8.5A

PRO PM 100W 24V 4.5A

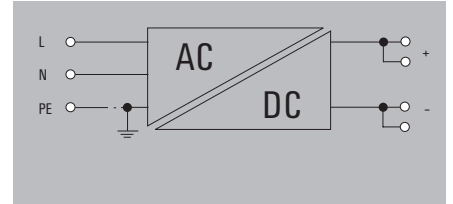
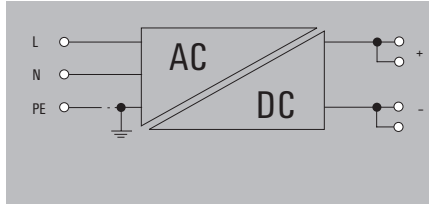
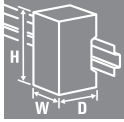

Technical data

Input	PRO PM 100W 12V 8.5A	PRO PM 100W 24V 4.5A
Input voltage range AC	90...264 V AC	90...264 V AC
Frequency range AC	47...63 Hz	47...63 Hz
Rated input voltage	100...240 V AC	100...240 V AC
Recommended back-up fuse	4 A at 230 V AC, characteristic curve C	4 A at 230 V AC, characteristic curve C
Output		
Output voltage	12 V DC	24 V DC
Output voltage adjustment	± 10% nominal output voltage tolerance, adjustable with potentiometer	± 10% nominal output voltage tolerance, adjustable with potentiometer
Output current	8.5 A	4.5 A
Output power	100 W	100 W
Derating	> 50°C (2% / 1°C)	> 50°C (2% / 1°C)
Residual ripple, breaking spikes	< 100 mV _{pp}	< 100 mV _{pp}
Overload protection	120%...180% I _{nominal} , hiccup mode with automatic recovery	120%...180% I _{nominal} , hiccup mode with automatic recovery
Surge protection	13.5...16.2 V @ 12 V DC	28...32 V @ 24 V DC
Mains failure bridge-over time	20 ms	20 ms
Parallel connection option	Yes, with diode module	Yes, with diode module
General data		
Ambient temperature (operational)	-20 °C...70 °C	-20 °C...70 °C
Storage temperature	-40 °C...85 °C	-40 °C...85 °C
Humidity	5...95 % RH	5...95 % RH
Degree of efficiency	84%	86%
Status indication	LED green: ready	LED green: ready
Mounting position, installation notice	Panel mount, screw fix	Panel mount, screw fix
Net weight	330 g	330 g
Approvals	CE	CE
Screw connection		
Connection cross-section, solid, min. / max.	0.34 / 4 mm ²	0.34 / 4 mm ²
Depth x width x height	129 / 97 / 30 mm	129 / 97 / 30 mm

Note

Ordering data

Type	Qty.	Order No.
PRO PM 100W 12V 8.5A	1	2660200285
The internal varistor found in a switch-mode power supply does not replace the necessary surge protection in a system.		
PRO PM 100W 24V 4.5A	1	2660200286
The internal varistor found in a switch-mode power supply does not replace the necessary surge protection in a system.		

Note

connectPower PRO-PM

PRO PM 100W 48V 2.3A

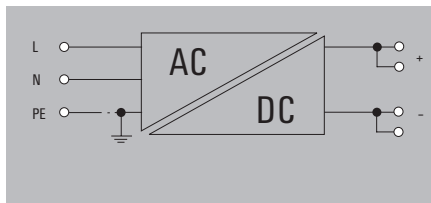

Technical data

Input	
Input voltage range AC	90...264 V AC
Frequency range AC	47...63 Hz
Rated input voltage	100...240 V AC
Recommended back-up fuse	4 A at 230 V AC, characteristic curve C
Output	
Output voltage	48 V DC
Output voltage adjustment	± 10% nominal output voltage tolerance, adjustable with potentiometer
Output current	2.3 A
Output power	100 W
Derating	> 50°C (2% / 1°C)
Residual ripple, breaking spikes	< 150 mV _{pp}
Overload protection	120%...180% I _{nominal} , hiccup mode with automatic recovery
Surge protection	55...62 V @ 48 V DC
Mains failure bridge-over time	20 ms
Parallel connection option	Yes, with diode module
General data	
Ambient temperature (operational)	-20 °C...70 °C
Storage temperature	-40 °C...85 °C
Humidity	5...95 % RH
Degree of efficiency	86%
Status indication	LED green: ready
Mounting position, installation notice	Panel mount, screw fix
Net weight	330 g
Approvals	CE
Screw connection	
Connection cross-section, solid, min. / max.	0.34 / 4 mm ²
Depth x width x height	129 / 97 / 30 mm

Note

Ordering data

Type	Qty.	Order No.
PRO PM 100W 48V 2.3A	1	2660200287

Note

The internal varistor found in a switch-mode power supply does not replace the necessary surge protection in a system.

connectPower PRO-PM

connectPower PRO-PM

PRO PM 150W 12V 12.5A

PRO PM 150W 24V 6.5A

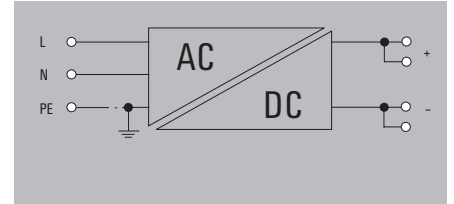
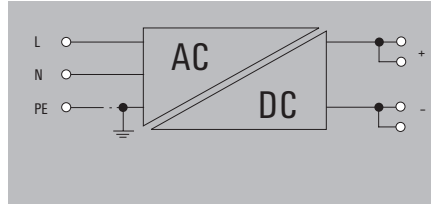
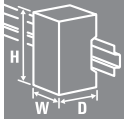

Technical data

Input	
Input voltage range AC	90...264 V AC
Frequency range AC	47...63 Hz
Rated input voltage	100...240 V AC
Recommended back-up fuse	4 A at 230 V AC, characteristic curve C
Output	
Output voltage	12 V DC
Output voltage adjustment	± 10% nominal output voltage tolerance, adjustable with potentiometer
Output current	12.5 A
Output power	150 W
Derating	> 50°C (2% / 1°C)
Residual ripple, breaking spikes	< 100 mV _{pp}
Overload protection	120%...180% I _{nominal} , hiccup mode with automatic recovery
Surge protection	13.5...16.2 V @ 12 V DC
Mains failure bridge-over time	20 ms
Parallel connection option	Yes, with diode module
General data	
Ambient temperature (operational)	-20 °C...70 °C
Storage temperature	-40 °C...85 °C
Humidity	5...95 % RH
Degree of efficiency	84%
Status indication	LED green: ready
Mounting position, installation notice	Panel mount, screw fix
Net weight	394 g
Approvals	CE
Screw connection	
Connection cross-section, solid, min. / max.	0.34 / 4 mm ²
Depth x width x height	159 / 97 / 30 mm

Input	
Input voltage range AC	90...264 V AC
Frequency range AC	47...63 Hz
Rated input voltage	100...240 V AC
Recommended back-up fuse	4 A at 230 V AC, characteristic curve C
Output	
Output voltage	24 V DC
Output voltage adjustment	± 10% nominal output voltage tolerance, adjustable with potentiometer
Output current	6.5 A
Output power	150 W
Derating	> 50°C (2% / 1°C)
Residual ripple, breaking spikes	< 100 mV _{pp}
Overload protection	120%...180% I _{nominal} , hiccup mode with automatic recovery
Surge protection	28...32 V @ 24 V DC
Mains failure bridge-over time	20 ms
Parallel connection option	Yes, with diode module
General data	
Ambient temperature (operational)	-20 °C...70 °C
Storage temperature	-40 °C...85 °C
Humidity	5...95 % RH
Degree of efficiency	86%
Status indication	LED green: ready
Mounting position, installation notice	Panel mount, screw fix
Net weight	394 g
Approvals	CE
Screw connection	
Connection cross-section, solid, min. / max.	0.34 / 4 mm ²
Depth x width x height	159 / 97 / 30 mm

Input	
Input voltage range AC	90...264 V AC
Frequency range AC	47...63 Hz
Rated input voltage	100...240 V AC
Recommended back-up fuse	4 A at 230 V AC, characteristic curve C
Output	
Output voltage	24 V DC
Output voltage adjustment	± 10% nominal output voltage tolerance, adjustable with potentiometer
Output current	6.5 A
Output power	150 W
Derating	> 50°C (2% / 1°C)
Residual ripple, breaking spikes	< 100 mV _{pp}
Overload protection	120%...180% I _{nominal} , hiccup mode with automatic recovery
Surge protection	28...32 V @ 24 V DC
Mains failure bridge-over time	20 ms
Parallel connection option	Yes, with diode module
General data	
Ambient temperature (operational)	-20 °C...70 °C
Storage temperature	-40 °C...85 °C
Humidity	5...95 % RH
Degree of efficiency	86%
Status indication	LED green: ready
Mounting position, installation notice	Panel mount, screw fix
Net weight	394 g
Approvals	CE
Screw connection	
Connection cross-section, solid, min. / max.	0.34 / 4 mm ²
Depth x width x height	159 / 97 / 30 mm

Note

Note

Note

Ordering data

Note

Type	Qty.	Order No.
PRO PM 150W 12V 12.5A	1	2660200288
The internal varistor found in a switch-mode power supply does not replace the necessary surge protection in a system.		

Type	Qty.	Order No.
PRO PM 150W 24V 6.5A	1	2660200289
The internal varistor found in a switch-mode power supply does not replace the necessary surge protection in a system.		

connectPower PRO-PM

PRO PM 150W 48V 3.3A

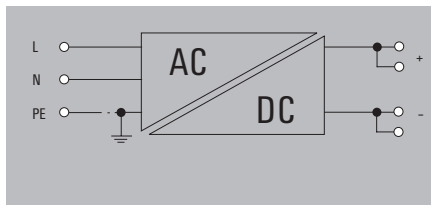
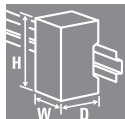

Technical data

Input	
Input voltage range AC	90...264 V AC
Frequency range AC	47...63 Hz
Rated input voltage	100...240 V AC
Recommended back-up fuse	4 A at 230 V AC, characteristic curve C
Output	
Output voltage	48 V DC
Output voltage adjustment	± 10% nominal output voltage tolerance, adjustable with potentiometer
Output current	3.3 A
Output power	150 W
Derating	> 50°C (2% / 1°C)
Residual ripple, breaking spikes	< 150 mV _{pp}
Overload protection	120%...180% I _{nominal} , hiccup mode with automatic recovery
Surge protection	55...62 V @ 48 V DC
Mains failure bridge-over time	20 ms
Parallel connection option	Yes, with diode module
General data	
Ambient temperature (operational)	-20 °C...70 °C
Storage temperature	-40 °C...85 °C
Humidity	5...95 % RH
Degree of efficiency	86%
Status indication	LED green: ready
Mounting position, installation notice	Panel mount, screw fix
Net weight	394 g
Approvals	CE
Screw connection	
Connection cross-section, solid, min. / max.	0.34 / 4 mm ²
Depth x width x height	159 / 97 / 30 mm

Note

Ordering data

Type	Qty.	Order No.
PRO PM 150W 48V 3.3A	1	2660200290

Note

The internal varistor found in a switch-mode power supply does not replace the necessary surge protection in a system.

connectPower PRO-PM

connectPower PRO-PM

PRO PM 250W 12V 21A

PRO PM 250W 24V 10.5A

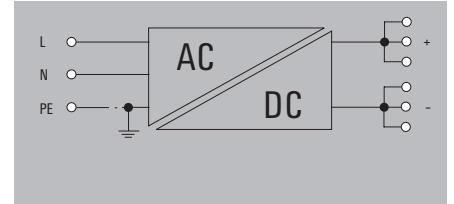
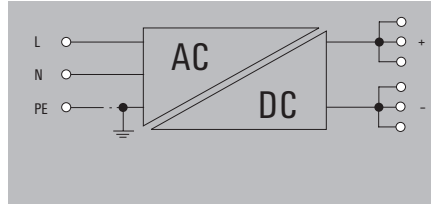
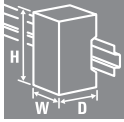

Technical data

Input	PRO PM 250W 12V 21A	PRO PM 250W 24V 10.5A
Input voltage range AC	90...264 V AC	90...264 V AC
Frequency range AC	47...63 Hz	47...63 Hz
Rated input voltage	100...240 V AC	100...240 V AC
Recommended back-up fuse	6 A at 230 V AC, characteristic curve C	6 A at 230 V AC, characteristic curve C
Output		
Output voltage	12 V DC	24 V DC
Output voltage adjustment	± 10% nominal output voltage tolerance, adjustable with potentiometer	± 10% nominal output voltage tolerance, adjustable with potentiometer
Output current	21 A	10.5 A
Output power	250 W	250 W
Derating	> 50°C (2% / 1°C)	> 50°C (2% / 1°C)
Residual ripple, breaking spikes	< 100 mV _{pp}	< 100 mV _{pp}
Overload protection	120%...180% I _{nominal} , hiccup mode with automatic recovery	120%...180% I _{nominal} , hiccup mode with automatic recovery
Surge protection	13.5...16.2 V @ 12 V DC	28...32 V @ 24 V DC
Mains failure bridge-over time	20 ms	20 ms
Parallel connection option	Yes, with diode module	Yes, with diode module
General data		
Ambient temperature (operational)	-20 °C...70 °C	-20 °C...70 °C
Storage temperature	-40 °C...85 °C	-40 °C...85 °C
Humidity	5...95 % RH	5...95 % RH
Degree of efficiency	84%	86%
Status indication	LED green: ready	LED green: ready
Mounting position, installation notice	Panel mount, screw fix	Panel mount, screw fix
Net weight	736 g	0.84 g
Approvals	CE	CE
Screw connection		
Connection cross-section, solid, min. / max.	0.34 / 4 mm ²	0.34 / 4 mm ²
Depth x width x height	215 / 115 / 30 mm	215 / 115 / 30 mm

Note

Ordering data

Type	Qty.	Order No.
PRO PM 250W 12V 21A	1	2660200291
The internal varistor found in a switch-mode power supply does not replace the necessary surge protection in a system.		
Type	Qty.	Order No.
PRO PM 250W 24V 10.5A	1	2660200292
The internal varistor found in a switch-mode power supply does not replace the necessary surge protection in a system.		

Note

connectPower PRO-PM

PRO PM 250W 48V 5.2A

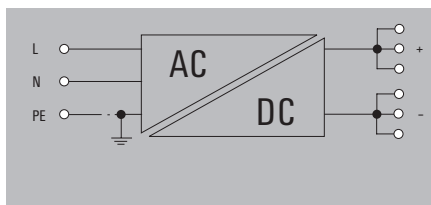
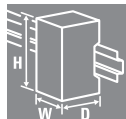

Technical data

Input	
Input voltage range AC	90...264 V AC
Frequency range AC	47...63 Hz
Rated input voltage	100...240 V AC
Recommended back-up fuse	6 A at 230 V AC, characteristic curve C
Output	
Output voltage	48 V DC
Output voltage adjustment	± 10% nominal output voltage tolerance, adjustable with potentiometer
Output current	5.2 A
Output power	250 W
Derating	> 50°C (2% / 1°C)
Residual ripple, breaking spikes	< 150 mV _{pp}
Overload protection	120%...180% I _{nominal} , hiccup mode with automatic recovery
Surge protection	55...62 V @ 48 V DC
Mains failure bridge-over time	20 ms
Parallel connection option	Yes, with diode module
General data	
Ambient temperature (operational)	-20 °C...70 °C
Storage temperature	-40 °C...85 °C
Humidity	5...95 % RH
Degree of efficiency	86%
Status indication	LED green: ready
Mounting position, installation notice	Panel mount, screw fix
Net weight	736 g
Approvals	CE
Screw connection	
Connection cross-section, solid, min. / max.	0.34 / 4 mm ²
Depth x width x height	215 / 115 / 30 mm

Note

Ordering data

Type	Qty.	Order No.
PRO PM 250W 48V 5.2A	1	2660200293

Note
The internal varistor found in a switch-mode power supply does not replace the necessary surge protection in a system.

connectPower PRO-PM

connectPower PRO-PM

PRO PM 350W 24V 14.6A

PRO PM 350W 48V 7.3A

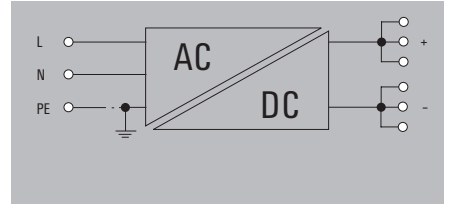
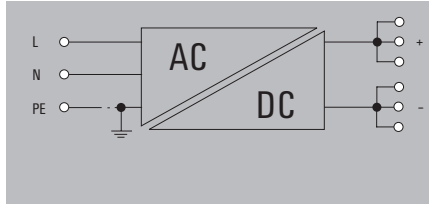
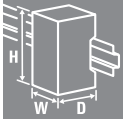

Technical data

Input	
Input voltage range AC	90...264 V AC
Frequency range AC	47...63 Hz
Rated input voltage	100...240 V AC
Recommended back-up fuse	6 A at 230 V AC, characteristic curve C
Output	
Output voltage	24 V DC
Output voltage adjustment	± 10% nominal output voltage tolerance, adjustable with potentiometer
Output current	14.6 A
Output power	350 W
Derating	> 50°C (2% / 1°C)
Residual ripple, breaking spikes	< 100 mV _{pp}
Overload protection	120%...180% I _{nominal} , hiccup mode with automatic recovery
Surge protection	28...32 V @ 24 V DC
Mains failure bridge-over time	20 ms
Parallel connection option	Yes, with diode module
General data	
Ambient temperature (operational)	-20 °C...70 °C
Storage temperature	-40 °C...85 °C
Humidity	5...95 % RH
Degree of efficiency	86%
Status indication	LED green: ready
Mounting position, installation notice	Panel mount, screw fix
Net weight	750 g
Approvals	CE
Screw connection	
Connection cross-section, solid, min. / max.	0.34 / 4 mm ²
Depth x width x height	215 / 115 / 30 mm

Input	
Input voltage range AC	90...264 V AC
Frequency range AC	47...63 Hz
Rated input voltage	100...240 V AC
Recommended back-up fuse	6 A at 230 V AC, characteristic curve C
Output	
Output voltage	48 V DC
Output voltage adjustment	± 10% nominal output voltage tolerance, adjustable with potentiometer
Output current	7.3 A
Output power	350 W
Derating	> 50°C (2% / 1°C)
Residual ripple, breaking spikes	< 150 mV _{pp}
Overload protection	120%...180% I _{nominal} , hiccup mode with automatic recovery
Surge protection	55...62 V @ 48 V DC
Mains failure bridge-over time	20 ms
Parallel connection option	Yes, with diode module
General data	
Ambient temperature (operational)	-20 °C...70 °C
Storage temperature	-40 °C...85 °C
Humidity	5...95 % RH
Degree of efficiency	86%
Status indication	LED green: ready
Mounting position, installation notice	Panel mount, screw fix
Net weight	750 g
Approvals	CE
Screw connection	
Connection cross-section, solid, min. / max.	0.34 / 4 mm ²
Depth x width x height	215 / 115 / 30 mm

Input	
Input voltage range AC	90...264 V AC
Frequency range AC	47...63 Hz
Rated input voltage	100...240 V AC
Recommended back-up fuse	6 A at 230 V AC, characteristic curve C
Output	
Output voltage	48 V DC
Output voltage adjustment	± 10% nominal output voltage tolerance, adjustable with potentiometer
Output current	7.3 A
Output power	350 W
Derating	> 50°C (2% / 1°C)
Residual ripple, breaking spikes	< 150 mV _{pp}
Overload protection	120%...180% I _{nominal} , hiccup mode with automatic recovery
Surge protection	55...62 V @ 48 V DC
Mains failure bridge-over time	20 ms
Parallel connection option	Yes, with diode module
General data	
Ambient temperature (operational)	-20 °C...70 °C
Storage temperature	-40 °C...85 °C
Humidity	5...95 % RH
Degree of efficiency	86%
Status indication	LED green: ready
Mounting position, installation notice	Panel mount, screw fix
Net weight	750 g
Approvals	CE
Screw connection	
Connection cross-section, solid, min. / max.	0.34 / 4 mm ²
Depth x width x height	215 / 115 / 30 mm

Note

Note

Note

Ordering data

Type	Qty.	Order No.
PRO PM 350W 24V 14.6A	1	2660200294

Type	Qty.	Order No.
PRO PM 350W 24V 14.6A	1	2660200294
The internal varistor found in a switch-mode power supply does not replace the necessary surge protection in a system.		

Type	Qty.	Order No.
PRO PM 350W 48V 7.3A	1	2660200295
The internal varistor found in a switch-mode power supply does not replace the necessary surge protection in a system.		

Note

An everlasting power supply for buildings and machines

INSTA POWER power supplies – compact, efficient and reliable

A In building automation and mechanical engineering, many small distributors, meter cabinets and electrical distributions must often be taken into account. Efficient power supply solutions with high power density and high efficiency are in demand here.

The single phase INSTA POWER have a broad power spectrum, compact design, and good price-performance ratio. They operate in a temperature range from -25 °C to +70 °C and have wide range of approvals and wide-range voltage input. They are suitable for a variety of applications, which include signal and telecommunication systems and automation systems with low power requirements up to 96 W.

With its unique combination of particularly slim design, proven PUSH IN connection technology and high cost efficiency, INSTA POWER has decisive advantages over competitive products on the market.



Building automation with the compact power package.

The new INSTA POWER is optimal for the use in building automation. Due to the standardized design with small width, this power supply also finds sufficient space in sub-distribution boards and small distribution boards. Furthermore, the extensive power spectrum of INSTA POWER is an additional advantage for compact applications.

Extremely space- and energy-saving

With a basic depth of only 60 mm, INSTA POWER fits into the smallest control cabinets. The high efficiency of up to 91 % and the extremely low no-load power loss of max. 0.5 W ensure minimum energy costs.

**Robust and reliable**

INSTA POWER operates reliably in a temperature range from -25 °C to +70 °C (start-up: -40 °C) and have a high MTBF value of more than 1,000,000 hours.

**Easy and quick to install**

The INSTA POWER devices can either be snapped onto a DIN rail or screwed to the control cabinet wall. The maintenance work and measurements can be carried out conveniently via the PUSH IN connections.



connectPower INSTA POWER

connectPower INSTA POWER



Derating curve

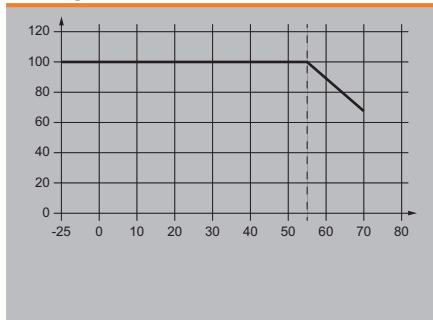

Technical data

General data	
Ambient temperature (operational)	-25 °C...70 °C
Protection degree	IP20
Housing version	Plastic, protective insulation
Mounting position, installation notice	Horizontal on DIN rail TS 35, top and bottom 50 mm clearance for free air flow, 10 mm clearance to neighbouring active subassemblies with full load, 5 mm with passive neighbouring subassemblies, direct row mounting with 90% rated load
Signalling	
LED green	Operating voltage OK
EMC / shock / vibration	
Limiting of mains voltage harmonic currents	According to EN 61000-3-2
Noise emission in accordance with EN55032	Class B
Interference immunity test acc. to	EN 61000-4-2 (ESD) EN 61000-4-3 and EN 61000-4-8 (fields) EN 61000-4-4 (burst) EN 61000-4-5 (surge) EN 61000-4-6 (conducted) EN 61000-4-11 (dips), EN 61000-4-11 (Dips)
Shock	15 g In all directions
Insulation coordination	
Insulation voltage output / earth	0.5 kV
Insulation voltage, input/output	4 kV
Insulation voltage input / earth	3.5 kV
Protection class	II
Pollution degree	2
Electrical safety (applied standards)	
For use with electronic equipment	Acc. to EN50178 / VDE0160
Electrical machine equipment	Acc. to EN60204
Protection against dangerous shock currents	Acc. to VDE0106-101
Protective separation / protection against electrical shock	VDE0100-410 / acc. to DIN57100-410
Safety transformers for switch-mode power supplies	According to EN 61558-2-16

connectPower INSTA POWER

- 1-phase power supplies

PRO INSTA 16 W 24 V 0.7 A

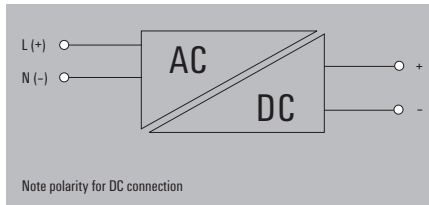

PRO INSTA 30 W 5 V 6 A

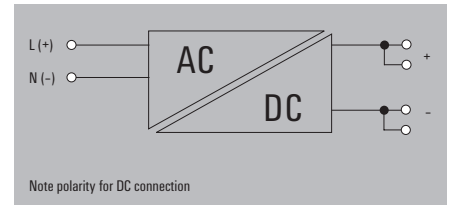

Technical data

Input	
Rated input voltage	110...240 V AC / 120...340 V DC
Input voltage range AC	85...264 V AC (derating at 100 V AC)
AC current consumption	0.25 A @ 230 V AC / 0.45 A @ 100 V AC
Frequency range AC	45...65 Hz
DC input voltage range	95...370 V DC
DC current consumption	0.08 A @ 370V DC / 0.22 A @ 120 V DC
Inrush current	max. 40 A
Output	
Rated output voltage	24 V DC ± 1 %
Nominal output current for U _{nom}	0.7 A @ 55 °C
Output voltage	22...28 V (adjustable via potentiometer on front)
Continuous output current @ U _{Nominal}	0.7 A @ 55 °C, 0.43 A @ 70 °C
Residual ripple, breaking spikes	< 50 mVss @ U _{Nom} , Full Load
Capacitive load	unrestricted
MTBF	
According to Standard	Telcordia SR-332
Operating time (hours), min.	810kh
Ambient temperature	25°C
Input voltage	230V
Output power	16W
Duty cycle	100%
General data	
Degree of efficiency	82.5 %
Power loss idling / nominal load	0.4 W
Power loss, nominal load	3.6 W
Protection against reverse voltages from the load	30...35 V DC
Depth x width x height	60 / 22.5 / 90.5 mm
Net weight	82 g
Approvals	
Approvals	cCSAus; cULus; TUEV

Rated input voltage	110...240 V AC / 120...340 V DC
Input voltage range AC	85...264 V AC (derating at 100 V AC)
AC current consumption	0.25 A @ 230 V AC / 0.45 A @ 100 V AC
Frequency range AC	45...65 Hz
DC input voltage range	95...370 V DC
DC current consumption	0.08 A @ 370V DC / 0.22 A @ 120 V DC
Inrush current	max. 40 A
Rated output voltage	24 V DC ± 1 %
Nominal output current for U _{nom}	0.7 A @ 55 °C
Output voltage	22...28 V (adjustable via potentiometer on front)
Continuous output current @ U _{Nominal}	0.7 A @ 55 °C, 0.43 A @ 70 °C
Residual ripple, breaking spikes	< 50 mVss @ U _{Nom} , Full Load
Capacitive load	unrestricted
According to Standard	Telcordia SR-332
Operating time (hours), min.	810kh
Ambient temperature	25°C
Input voltage	230V
Output power	16W
Duty cycle	100%
Degree of efficiency	82.5 %
Power loss idling / nominal load	0.4 W
Power loss, nominal load	3.6 W
Protection against reverse voltages from the load	30...35 V DC
Depth x width x height	60 / 22.5 / 90.5 mm
Net weight	82 g
Approvals	cCSAus; cULus; TUEV

Rated input voltage	110...240 V AC / 120...340 V DC
Input voltage range AC	85...264 V AC (derating at 100 V AC)
AC current consumption	0.5 A @ 230 V AC / 1.0 A @ 100 V AC
Frequency range AC	45...65 Hz
DC input voltage range	95...370 V DC
DC current consumption	0.2 A @ 370 V DC / 0.5 A @ 120 V DC
Inrush current	max. 40 A
Rated output voltage	5 V DC ± 2 %
Nominal output current for U _{nom}	6 A @ 55 °C
Output voltage	4...7 V (adjustable via potentiometer on front)
Continuous output current @ U _{Nominal}	6 A @ 55 °C, 3.75 A @ 70 °C
Residual ripple, breaking spikes	< 50 mVss @ U _{Nom} , Full Load
Capacitive load	unrestricted
According to Standard	Telcordia SR-332
Operating time (hours), min.	896kh
Ambient temperature	25°C
Input voltage	230V
Output power	30W
Duty cycle	100%
Degree of efficiency	82 %
Power loss idling / nominal load	0.45 W
Power loss, nominal load	5.4 W
Protection against reverse voltages from the load	8...10 V DC
Depth x width x height	60 / 72 / 90 mm
Net weight	256 g
Approvals	cCSAus; cULus; TUEV

Connection data	
Connection system	PUSH IN with actuator
Number of terminals	2 (L,N)
Wire cross-section, rigid min/max	0.25 / 2.5 mm ²
Wire cross-section, flexible min/max	0.25 / 2.5 mm ²
Wire cross-section, AWG/kcmil min/max	24 / 12
Note	

Input	Output
PUSH IN with actuator	PUSH IN
2 (L,N)	2 (+ / -)
0.25 / 2.5	0.25 / 2.5
0.25 / 2.5	0.25 / 2.5
24 / 12	24 / 12

Input	Output
PUSH IN with actuator	PUSH IN
2 (L,N)	4 (++ / -)
0.25 / 2.5	0.25 / 2.5
0.25 / 2.5	0.25 / 2.5
24 / 12	24 / 12

Ordering data

Type	Qty.	Order No.
PRO INSTA 16W 24V 0.7A	1	2580180000

Type	Qty.	Order No.
PRO INSTA 16W 24V 0.7A	1	2580180000

Type	Qty.	Order No.
PRO INSTA 30W 5V 6A	1	2580210000

Note

Note

Note

connectPower INSTA POWER

connectPower INSTA POWER

- 1-phase power supplies

PRO INSTA 30 W 12 V 2.6 A

PRO INSTA 30 W 24 V 1.3 A

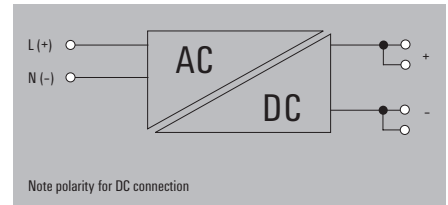
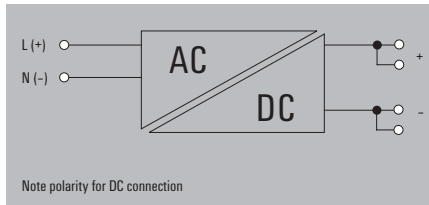

Technical data

Input	
Rated input voltage	110...240 V AC / 120...340 V DC
Input voltage range AC	85...264 V AC (derating at 100 V AC)
AC current consumption	0.5 A @ 230 V AC / 1.0 A @ 100 V AC
Frequency range AC	45...65 Hz
DC input voltage range	95...370 V DC
DC current consumption	0.2 A @ 370 V DC / 0.5 A @ 120 V DC
Inrush current	max. 40 A
Output	
Rated output voltage	12 V DC ± 1 %
Nominal output current for U _{nom}	2.6 A @ 55 °C
Output voltage	9...16 V (adjustable via potentiometer on front)
Continuous output current @ U _{Nominal}	2.6 A @ 55 °C, 1.625 A @ 55 °C
Residual ripple, breaking spikes	< 50 mVss @ U _{Nom} , Full Load
Capacitive load	unrestricted
MTBF	
According to Standard	Telcordia SR-332
Operating time (hours), min.	896kh
Ambient temperature	25°C
Input voltage	230V
Output power	30W
Duty cycle	100%
General data	
Degree of efficiency	85 %
Power loss idling / nominal load	0.45 W
Power loss, nominal load	5.29 W
Protection against reverse voltages from the load	18...25 V DC
Depth x width x height	60 / 54 / 90 mm
Net weight	192 g
Approvals	
Approvals	cCSAus; cULus; TUEV

Rated input voltage	110...240 V AC / 120...340 V DC
Input voltage range AC	85...264 V AC (derating at 100 V AC)
AC current consumption	0.5 A @ 230 V AC / 1.0 A @ 100 V AC
Frequency range AC	45...65 Hz
DC input voltage range	95...370 V DC
DC current consumption	0.2 A @ 370 V DC / 0.5 A @ 120 V DC
Inrush current	max. 40 A
Output	
Rated output voltage	24 V DC ± 1 %
Nominal output current for U _{nom}	1.3 A @ 55 °C
Output voltage	22...28 V (adjustable via potentiometer on front)
Continuous output current @ U _{Nominal}	1.3 A @ 55 °C, 0.8 A @ 70 °C
Residual ripple, breaking spikes	< 50 mVss @ U _{Nom} , Full Load
Capacitive load	unrestricted
MTBF	
According to Standard	Telcordia SR-332
Operating time (hours), min.	1143kh
Ambient temperature	25°C
Input voltage	230V
Output power	30W
Duty cycle	100%
General data	
Degree of efficiency	86%
Power loss idling / nominal load	0.45 W
Power loss, nominal load	4.88 W
Protection against reverse voltages from the load	30...35 V DC
Depth x width x height	60 / 54 / 90 mm
Net weight	192 g
Approvals	
Approvals	cCSAus; cULus; TUEV

Input	Output
PUSH IN with actuator	PUSH IN
2 (L,N)	4 (++ / -)
0.25 / 2.5 mm ²	0.25 / 2.5
0.25 / 2.5 mm ²	0.25 / 2.5
24 / 12	24 / 12

Connection data	
Connection system	PUSH IN with actuator
Number of terminals	4 (++ / -)
Wire cross-section, rigid min/max	0.25 / 2.5 mm ²
Wire cross-section, flexible min/max	0.25 / 2.5 mm ²
Wire cross-section, AWG/kcmil min/max	24 / 12
Note	

Ordering data

Type	Qty.	Order No.
PRO INSTA 30W 12V 2.6A	1	2580220000
Note		

Input	Output
PUSH IN with actuator	PUSH IN
2 (L,N)	4 (++ / -)
0.25 / 2.5 mm ²	0.25 / 2.5
0.25 / 2.5 mm ²	0.25 / 2.5
24 / 12	24 / 12

Type	Qty.	Order No.
PRO INSTA 30W 24V 1.3A	1	2580190000
Note		

connectPower INSTA POWER

- 1-phase power supplies

PRO INSTA 60 W 12 V 5 A

PRO INSTA 60 W 24 V 2.5 A

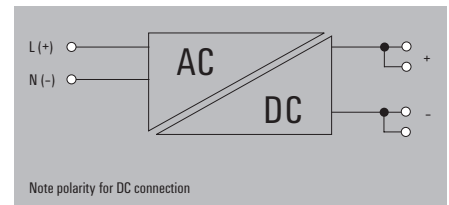
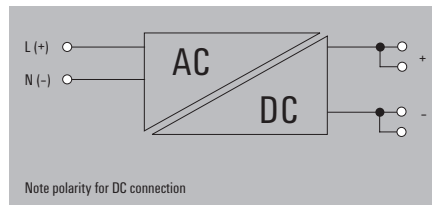

Technical data

Input	
Rated input voltage	
Input voltage range AC	
AC current consumption	
Frequency range AC	
DC input voltage range	
DC current consumption	
Inrush current	
Output	
Rated output voltage	
Nominal output current for U_{nom}	
Output voltage	
Continuous output current @ $U_{Nominal}$	
Residual ripple, breaking spikes	
Capacitive load	
MTBF	
According to Standard	
Operating time (hours), min.	
Ambient temperature	
Input voltage	
Output power	
Duty cycle	
General data	
Degree of efficiency	
Power loss idling / nominal load	
Power loss, nominal load	
Protection against reverse voltages from the load	
Depth x width x height	
Net weight	
Approvals	
Approvals	

110...240 V AC / 120...340 V DC
85...264 V AC (derating at 100 V AC)
0.7 A @ 230 V AC / 1.5 A @ 100 V AC
45...65 Hz
95...370 V DC
0.25 A @ 370 V DC / 0.8 A @ 120 V DC
max. 40 A
12 V DC \pm 1 %
5 A @ 55 °C
9...16 V (adjustable via potentiometer on front)
5 A @ 55 °C, 3.75 A @ 70 °C
< 50 mVss @ U_{Ntemp} , Full Load
unrestricted
Telcordia SR-332
792kh
25°C
230V
60W
100%
86%
0.42 W
8.4 W
18...25 V DC
60 / 72 / 90 mm
258 g
cCSAus; cULus; TUEV

110...240 V AC / 120...340 V DC
85...264 V AC (derating at 100 V AC)
0.7 A @ 230 V AC / 1.5 A @ 100 V AC
45...65 Hz
95...370 V DC
0.25 A @ 370 V DC / 0.8 A @ 120 V DC
max. 40 A
24 V DC \pm 1 %
2.5 A @ 55 °C
22...28 V (adjustable via potentiometer on front)
2.5 A @ 55 °C, 1.56 A @ 70 °C
< 50 mVss @ U_{Ntemp} , Full Load
unrestricted
Telcordia SR-332
1014kh
25°C
230V
60W
100%
89%
0.44 W
6.6 W
30...35 V DC
60 / 72 / 90 mm
258 g
cCSAus; cULus; TUEV

Connection data	
Connection system	
Number of terminals	
Wire cross-section, rigid min/max	mm ²
Wire cross-section, flexible min/max	mm ²
Wire cross-section, AWG/kcmil min/max	
Note	

Input	Output
PUSH IN with actuator	PUSH IN
2 (L,N)	4 (++ / -)
0.25 / 2.5	0.25 / 2.5
0.25 / 2.5	0.25 / 2.5
24 / 12	24 / 12

Input	Output
PUSH IN with actuator	PUSH IN
2 (L,N)	4 (++ / -)
0.25 / 2.5	0.25 / 2.5
0.25 / 2.5	0.25 / 2.5
24 / 12	24 / 12

Ordering data

Type	Qty.	Order No.
PRO INSTA 60W 12V 5A	1	2580240000

Type	Qty.	Order No.
PRO INSTA 60W 24V 2.5A	1	2580230000

Type	Qty.	Order No.
PRO INSTA 60W 24V 2.5A	1	2580230000

Note

connectPower INSTA POWER

connectPower INSTA POWER

- 1-phase power supplies

PRO INSTA 90 W 24 V 3.8 A

PRO INSTA 96 W 24 V 4 A

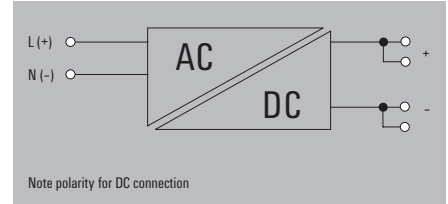
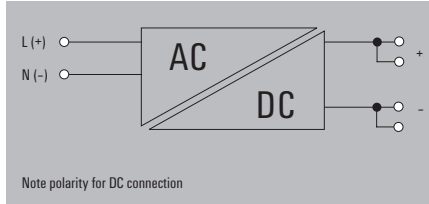

Technical data

Input	
Rated input voltage	
Input voltage range AC	
AC current consumption	
Frequency range AC	
DC input voltage range	
DC current consumption	
Inrush current	
Output	
Rated output voltage	
Nominal output current for U_{nom}	
Output voltage	
Continuous output current @ $U_{Nominal}$	
Residual ripple, breaking spikes	
Capacitive load	
MTBF	
According to Standard	
Operating time (hours), min.	
Ambient temperature	
Input voltage	
Output power	
Duty cycle	
General data	
Degree of efficiency	
Power loss idling / nominal load	
Power loss, nominal load	
Protection against reverse voltages from the load	
Depth x width x height	
Net weight	
Approvals	
Approvals	

110...240 V AC / 120...340 V DC
85...264 V AC (derating at 100 V AC)
1.2 A @ 230 V AC / 2.4 A @ 100 V AC
45...65 Hz
95...370 V DC
0.4 A @ 370 V DC / 1.3 A @ 120 V DC
max. 40 A
24 V DC \pm 1 %
3.8 A @ 55 °C
22...25 V (adjustable via potentiometer on front)
3.8 A @ 55 °C, 2.38 A @ 70 °C
< 50 mVss @ U_{Ntemp} , Full Load
unrestricted
Telcordia SR-332
619kh
25°C
230V
90W
100%
87 %
0.45 W
11.7 W
30...35 V DC
60 / 90 / 90 mm
352 g
cCSAus; cULus; TUEV

110...240 V AC / 120...340 V DC
85...264 V AC (derating at 100 V AC)
1.2 A @ 230 V AC / 2.5 A @ 100 V AC
45...65 Hz
95...370 V DC
0.4 A @ 370 V DC / 1.35 A @ 120 V DC
max. 40 A
24 V DC \pm 1 %
4 A @ 55 °C
22...28 V (adjustable via potentiometer on front)
4 A @ 55 °C, 2.5 A @ 70 °C
< 50 mVss @ U_{Ntemp} , Full Load
unrestricted
Telcordia SR-332
613kh
25°C
230V
96W
100%
87 %
0.45 W
12.48 W
30...35 V DC
60 / 90 / 90 mm
352 g
cCSAus; cULus; TUEV

Connection data	
Connection system	
Number of terminals	
Wire cross-section, rigid min/max	mm ²
Wire cross-section, flexible min/max	mm ²
Wire cross-section, AWG/kcmil min/max	
Note	

Input	Output
PUSH IN with actuator	PUSH IN
2 (L,N)	4 (++ / -)
0.25 / 2.5	0.25 / 2.5
0.25 / 2.5	0.25 / 2.5
24 / 12	24 / 12

Input	Output
PUSH IN with actuator	PUSH IN
2 (L,N)	4 (++ / -)
0.25 / 2.5	0.25 / 2.5
0.25 / 2.5	0.25 / 2.5
24 / 12	24 / 12

Ordering data

Type	Qty.	Order No.
PRO INSTA 90W 24V 3.8A	1	2580250000
Note		

Type	Qty.	Order No.
PRO INSTA 96W 24V 4A	1	2580260000
Note		

Type	Qty.	Order No.
PRO INSTA 96W 24V 4A	1	2580260000
Note		

connectPower INSTA POWER

- 1-phase power supplies

PRO INSTA 96 W 48 V 2 A

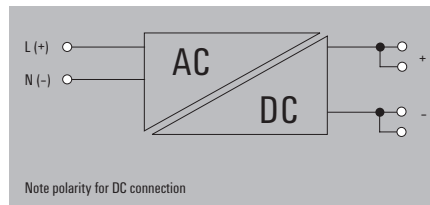

Technical data

Input	
Rated input voltage	110...240 V AC / 120...340 V DC
Input voltage range AC	85...264 V AC (derating at 100 V AC)
AC current consumption	1.2 A @ 230 V AC / 2.5 A @ 100 V AC
Frequency range AC	45...65 Hz
DC input voltage range	95...370 V DC
DC current consumption	0.4 A @ 370 V DC / 1.35 A @ 120 V DC
Inrush current	max. 40 A
Output	
Rated output voltage	48 V DC ± 1 %
Nominal output current for U _{nom}	2 A @ 55 °C
Output voltage	35...56 V (adjustable via potentiometer on front)
Continuous output current @ U _{Nominal}	2 A @ 55 °C, 1.25 A @ 70 °C
Residual ripple, breaking spikes	< 50 mV _{rms} @ U _{Nom} , Full Load
Capacitive load	unrestricted
MTBF	
According to Standard	Telcordia SR-332
Operating time (hours), min.	648kh
Ambient temperature	25°C
Input voltage	230V
Output power	96W
Duty cycle	100%
General data	
Degree of efficiency	89%
Power loss idling / nominal load	0.45 W
Power loss, nominal load	10.56 W
Protection against reverse voltages from the load	58...62 V DC
Depth x width x height	60 / 90 / 90 mm
Net weight	361 g
Approvals	
Approvals	cCSAus; cULus; TUEV

Input		Output	
PUSH IN with actuator		PUSH IN	
2 (L,N)		4 (++ / -)	
0.25 / 2.5		0.25 / 2.5	
0.25 / 2.5		0.25 / 2.5	
24 / 12		24 / 12	

Connection data	
Connection system	
Number of terminals	
Wire cross-section, rigid min/max	mm ²
Wire cross-section, flexible min/max	mm ²
Wire cross-section, AWG/kcmil min/max	
Note	

Ordering data

Note	
-------------	--

Type	Qty.	Order No.
PRO INSTA 96W 48V 2A	1	2580270000

Small screwdriver

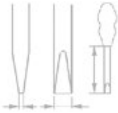

Type	Size/AF	a	b	c	Order No.
SDIS 0.5X3.0X100		0.5	3	100	2749800000

Markers

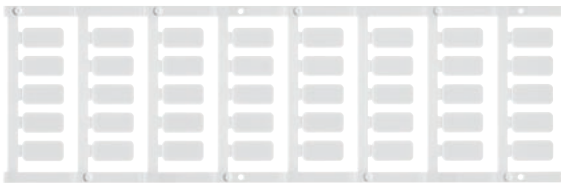

Type	Colour	Qty.	Order No.
SM 18/9.5 K MC NE WS	white	200	1248580000

End bracket

For DIN rail TS 35



Polyamide with fibre glass, screwable	Colour	Torque	Qty.	Order No.
WEW 35/1 SW	black	1.2 Nm	50	1162600000

Electronic load monitoring

Electronic load monitoring	topGUARD	B.2
	maxGUARD	B.8

Intelligent protection of DC loads

topGUARD load monitoring system with communication via IO-LINK

Modern machines and plants require load monitoring systems capable of communication. The IO-Link-capable load monitoring system topGUARD offers remote control options, full data transparency, and reliable protection of the 24 V system voltage.

topGUARD is an outstanding supplement to the IO-LINK-capable PROtop power supplies for innovative power management systems. It saves space and time during device installation through an innovative approach to integrated distribution of potential. Parameterisation, control, and provision of all operating data are carried out by plugging in the IO-Link module and integrating an IODD file. The module can be used for PROtop power supplies as well as for topGUARD load monitoring.

Combination of load monitoring and potential distribution

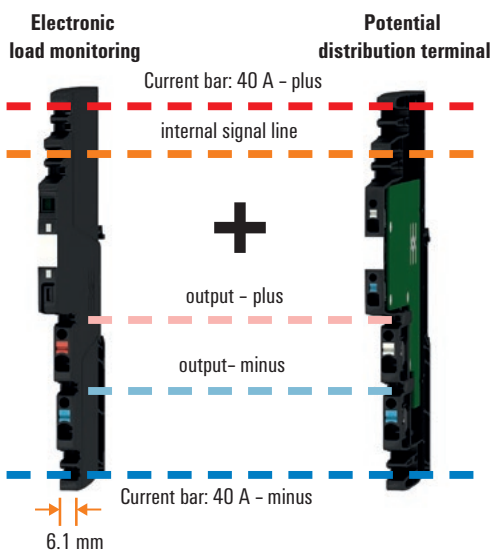

- Three main connection channels: positive, negative and internal signals
- Simple to increase the number of contacts thanks to crossconnection option in the potential distribution terminals



IO-LINK capable

The IO-Link-capable load monitoring system topGUARD offers remote control options, provides operating data for optimal condition monitoring, and enables entirely new control solutions.

Data transparency and remote control thanks to IO-Link.

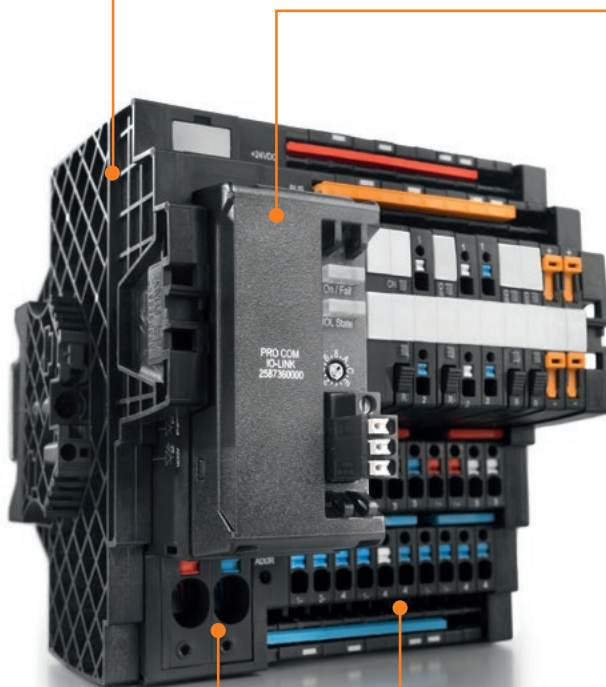

Modular and innovative

The modular concept enables custom-fit solutions. The first of its kind, voltage-adaptive class 2 load monitoring allows the continued use of 18 to 30 V DC operating voltage.

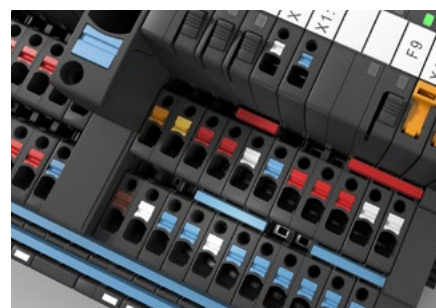

Integrated distribution of potential

The integrated distribution of potential, well known from the maxGUARD concept, takes up significantly less space and saves valuable time during installation.

topGUARD

topGUARD – power-feed module

TGD FIM-C

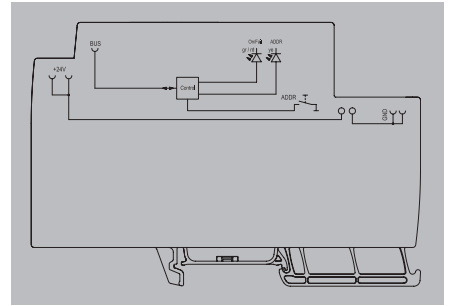

B

Technical data

Input
Input fuse (internal)
DC input voltage range
Rated input voltage
max. admissible residual ripple at the input
General data
Protection degree
Surge protection input, bus
Overvoltage category
Signalling
Yellow LED
LED green/red
Connection data
Number of terminals
Wire cross-section, AWG/kcmil min/max
Wire cross-section, flexible min/max
Wire cross-section, rigid min/max
Screwdriver blade
Approvals
Approvals
Note

No
18...30 V DC
24 V DC
100 mVpp
IP20
Suppressor diode
III
Address is assigned, Addresses being assigned (slow flashing, 1.5 Hz), Address error (fast flashing, 13 Hz)
Station ok (slow flashing green, 1.5 Hz), Device ok (fast flashing green, 13 Hz), Station error (slow flashing red, 1.5 Hz), Device error (fast flashing red, 13 Hz)
2 (+,-)
18..6
0.75...16 mm ²
0.75...10 mm ²
1.2 x 6.5
cULus

Ordering data

Rated current
Note

Type	Qty.	Order No.
TGD FIM-C	1	2625000000

Accessories

Note

Type	Qty.	Order No.
PRO COM IO-LINK	1	2587360000

topGUARD – load monitoring adjustable

TGD ELM-12

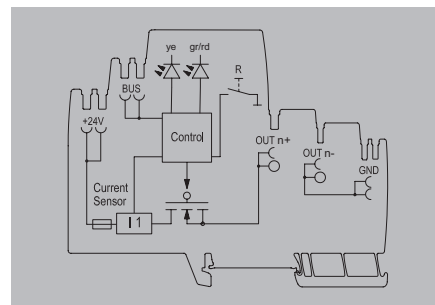

Technical data

Input
Input fuse (internal)
DC input voltage range
Rated input voltage
max. admissible residual ripple at the input
Output
Connection system
Triggering characteristic
Adjustable range
adjustable rated current
Capacitive load
Function key
Function key
General data
Relay to activate the output
Protection degree
Surge protection input, output, bus
Overvoltage category
Signalling
Yellow LED
LED green
Red LED
Connection data
Number of terminals
Wire cross-section, AWG/kcmil min/max
Wire cross-section, flexible min/max
Wire cross-section, rigid min/max
Screwdriver blade
Approvals
Approvals
Note

Yes
18...30 V DC
24 V DC
100 mVpp
PUSH IN
see characteristic curve
4-12 A
Yes
20,000 µF
Activation time < 3s, Reset, ON
No
IP20
Suppressor diode
III
Address is assigned, Address is being assigned (flashing)
Operation (failure-free), Early warning: I Out > 90% I Rated (flashing)
Load monitoring has disconnected, Load monitoring has triggered (flashing), Internal error (rapid flashing)
4 (++ / -)
26...12
0.14...2.5 mm ²
0.14...2.5 mm ²
0.6 x 3.5
cULus

Ordering data

Rated current	12 A
Note	

Type	Qty.	Order No.
TGD ELM-12	1	2624990000

Accessories

Note

Type	Qty.	Order No.
AMG DIS	10	2123050000
AMG MD	10	2122930000
AMG OD	10	2122910000
AMG PD	10	2122920000

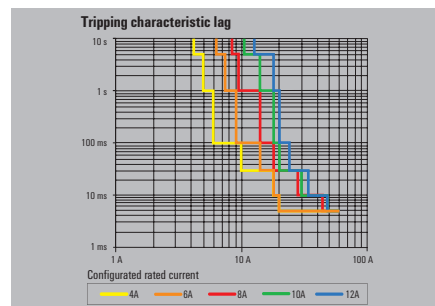
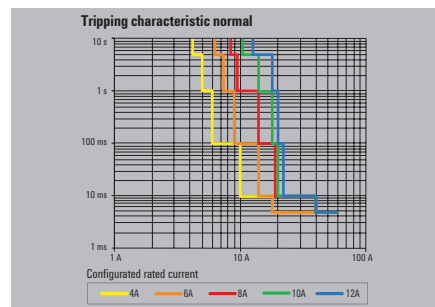

topGUARD

topGUARD – Adjustable load monitoring

TGD ELM-6

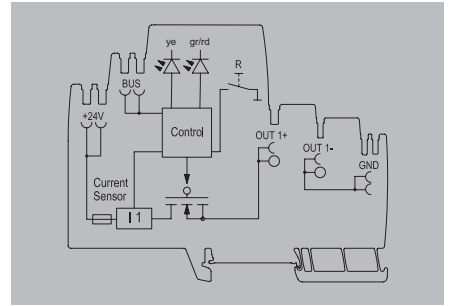

B

Technical data

Input
Input fuse (internal)
DC input voltage range
Rated input voltage
max. admissible residual ripple at the input
Output
Connection system
Triggering characteristic
Adjustable range
Capacitive load
adjustable rated current
Function key
Function key
General data
Relay to activate the output
Protection degree
Surge protection input, output, bus
Overvoltage category
Signalling
Yellow LED
LED green
Red LED
Connection data
Number of terminals
Wire cross-section, AWG/kcmil min/max
Wire cross-section, flexible min/max
Wire cross-section, rigid min/max
Screwdriver blade
Approvals
Approvals
Note

Yes
18...30 V DC
24 V DC
100 mVpp
PUSH IN
see characteristic curve
1- 6 A
15,000 µF
Yes
Activation time < 3s, Reset, ON
No
IP20
Suppressor diode
III
Address is assigned, Address is being assigned (flashing)
Operation (failure-free), Early warning: I Out > 90% I Rated (flashing)
Load monitoring has disconnected, Load monitoring has triggered (flashing), Internal error (rapid flashing)
2 (+ / -)
26...12
0.14... 2.5 mm ²
0.14... 2.5 mm ²
0.6 x 3.5
cULus

Ordering data

Rated current	6 A
Note	

Type	Qty.	Order No.
TGD ELM-6	1	2624980000

Accessories

Note

Type	Qty.	Order No.
AMG DIS	10	2123050000
AMG MD	10	2122930000
AMG OD	10	2122910000
AMG PD	10	2122920000

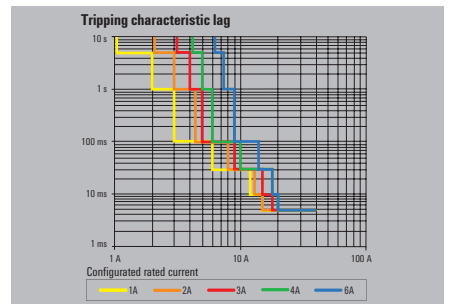
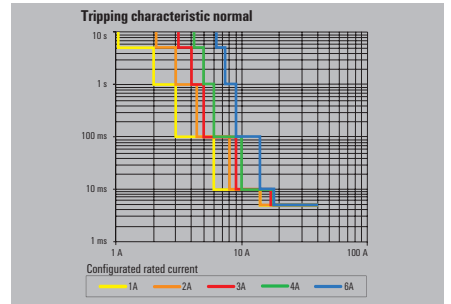

topGUARD – Load monitoring class2

TGD ELM-4 CL2

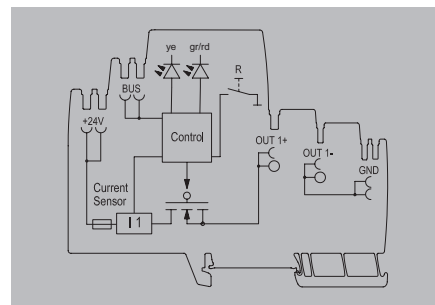

Technical data

Input
Input fuse (internal)
DC input voltage range
Rated input voltage
max. admissible residual ripple at the input
Output
Connection system
Triggering characteristic
Capacitive load
adjustable rated current
Function key
Function key
General data
Relay to activate the output
Protection degree
Surge protection input, output, bus
Overvoltage category
Signalling
Yellow LED
LED green
Red LED
Connection data
Number of terminals
Wire cross-section, AWG/kcmil min/max
Wire cross-section, flexible min/max
Wire cross-section, rigid min/max
Screwdriver blade
Approvals
Approvals
Note

Yes
18...30 V DC
24 V DC
100 mVpp
PUSH IN
see characteristic curve
4.700 µF
Yes
Activation time < 3s, Reset, ON
No
IP20
Suppressor diode
III
Address is assigned, Address is being assigned (flashing)
Operation (failure-free), Early warning: I Out > 90% I Rated (flashing)
Load monitoring has disconnected, Load monitoring has triggered (flashing), Internal error (rapid flashing)
2 (+ / -)
26...12
0.14...2.5 mm ²
0.14...2.5 mm ²
0.6 x 3.5
cULus

Ordering data

Rated current	4 A
Note	

Type	Qty.	Order No.
TGD ELM-4 CL2	1	2656670000

Accessories

Note

Type	Qty.	Order No.
AMG DIS	10	2123050000
AMG MD	10	2122930000
AMG OD	10	2122910000
AMG PD	10	2122920000

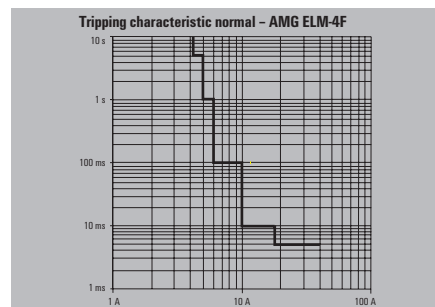

Load monitoring and potential distribution in one complete solution

maxGUARD – taking control voltage distribution to a new level

Fail-safe and maintenance-friendly control voltage distributions that can be installed in a time- and space-saving manner are a must for efficient machine and facility operation. With the new maxGUARD system, the terminal blocks (previously installed separately) for distributing potential to the outputs of the electronic load monitors become an integral part of a 24 V DC control voltage distribution solution. The new combination of load monitoring and potential distribution saves time during installation, increases safety against failure and reduces the amount of space required on the terminal rail by 50 %.



Extreme ease of servicing

Sophisticated operating, testing and connection elements permit safe access to all voltage potentials and load circuits during commissioning and maintenance.

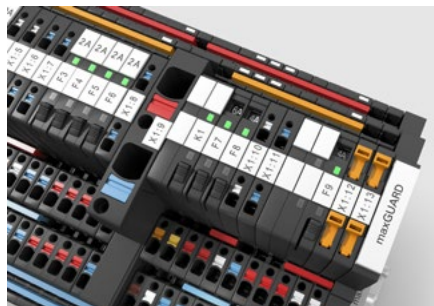

Particularly space-saving

Electronic load monitors and potential distributors with a 6.1 mm pitch.



Integrated test point

Consistently integrated test points in the maxGUARD control voltage distribution's input and output speed up troubleshooting operations.



Practical disconnecting lever

Potential distributor with a disconnecting lever for simple galvanic isolation of the load circuit for testing and checking purposes.



Unique cross-connectors

Less time and effort needed for wiring due to cross-connections between load monitoring and potential distribution terminals.



Can be used in a customised way

The sheer range of variants and the very different potential distribution terminals and additional components enable customised solutions at all times.

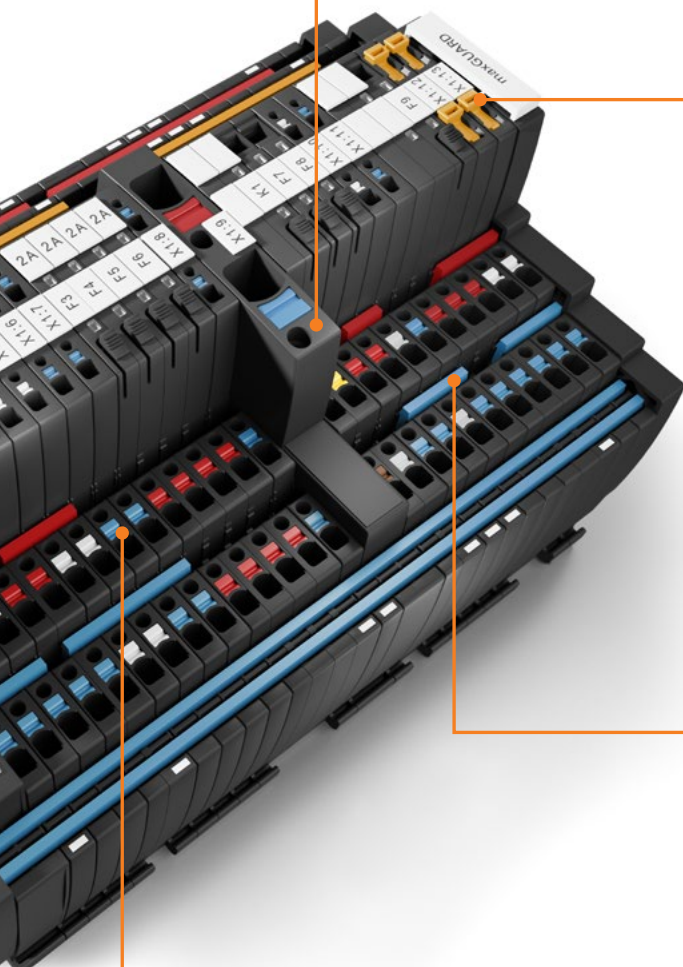

Potential distribution and accessories

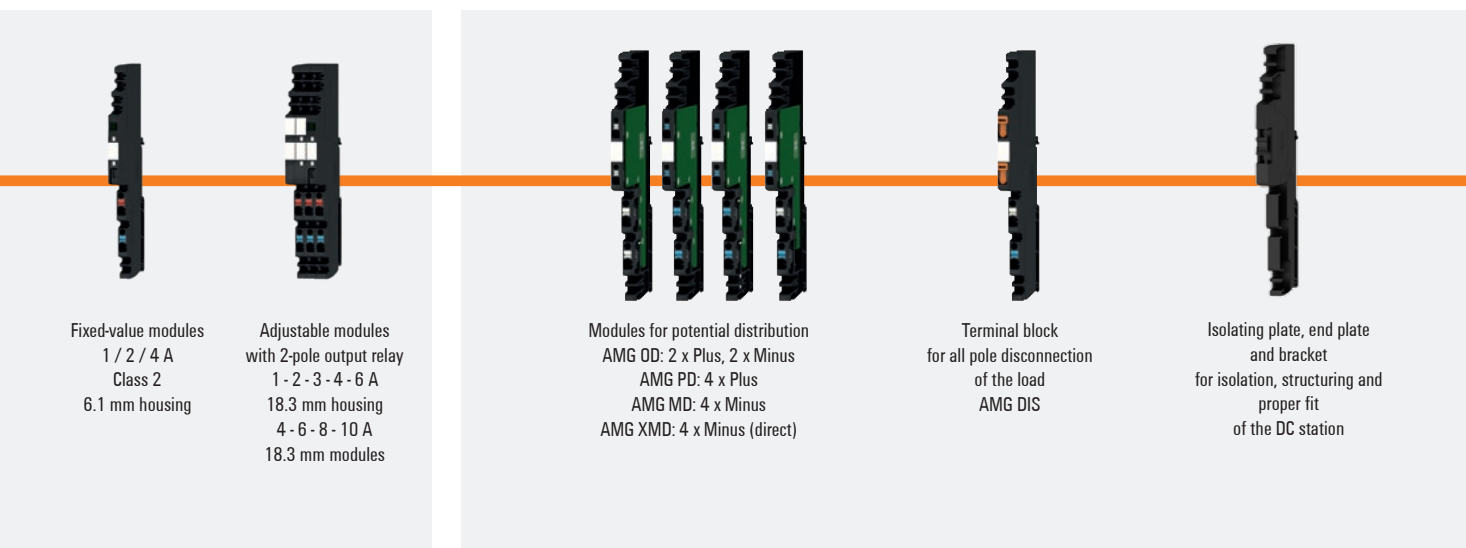

Fixed-value modules
1 / 2 / 4 A
Class 2
6.1 mm housing

Adjustable modules
with 2-pole output relay
1 - 2 - 3 - 4 - 6 A
18.3 mm housing
4 - 6 - 8 - 10 A
18.3 mm modules

Modules for potential distribution
AMG OD: 2 x Plus, 2 x Minus
AMG PD: 4 x Plus
AMG MD: 4 x Minus
AMG XMD: 4 x Minus (direct)

Terminal block
for all pole disconnection
of the load
AMG DIS

Isolating plate, end plate
and bracket
for isolation, structuring and
proper fit
of the DC station

**Load monitoring (fixed value)
Class 2**

Electronic load monitoring with fixed rated current (without I > 90 % pre warning)
Class 2 Approval

Load monitoring with relay

Electronic load monitoring with 2-pole output relay for allpole load disconnection; triggering current and triggering characteristic adjustable (with I > 90 % function)

Potential distributor

Flexible application through various potential distributor.

End plate and Separation plate

End plate for mechanical stabilization. Separation plate for logical subdivision.

Type	Order No.
AMG ELM-1F CL2	2491270000
AMG ELM-2F CL2	2491280000
AMG ELM-4F CL2	2491290000

Type	Order No.
AMG ELM-6D CO	2082440000
AMG ELM-10D CO	2082470000

Type	Order No.
AMG MD	2122930000
AMG MD EX	2495040000
AMG OD	2122910000
AMG OD EX	2495090000
AMG PD	2122920000
AMG PD EX	2495070000
AMG XMD	2122940000
AMG XMD EX	2495080000
AMG DIS	2123050000
AMG DIS EX	2495100000

Type	Order No.
AMG PP	2123000000
AMG EP	2495380000
AMG EP KIT	2500760000

maxGUARD – power-feed module

Active power-feed module with reset and alarm function

AMG FIM-C

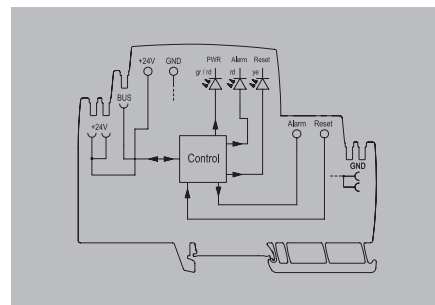

Technical data

Input
Input fuse (internal)
DC input voltage range
Rated input voltage
Current consumption (idle)
Current consumption (full load)
max. admissible residual ripple at the input
General data
Protection degree
Control inputs
Surge protection input, output, bus
Overtoltage category
Signalling
Yellow LED
LED green
Red LED
Transistor output, positive-switching
Connection data
Number of terminals
Wire cross-section, AWG/kcmil min/max
Wire cross-section, flexible min/max
Wire cross-section, rigid min/max
Screwdriver blade
Approvals
Approvals
Note

No
18...30 V DC
24 V DC
20 mA
120 mA
100 mVpp
IP20
Reset
Suppressor diode
III
External reset is signalled, Alarm is signalled
Operating voltage OK
Alarm
Alarm
2 (+,-)
18...6
0.75...16 mm ²
0.75...10 mm ²
1.2 x 6.5
CE; cULus; EAC; TUEV

Ordering data

Rated current
Note

Type	Qty.	Order No.
AMG FIM-C	1	2081880000

maxGUARD

maxGUARD – load monitoring (fixed value)

Electronic load monitoring with fixed current (without I > 90% function > 90 %)

AMG ELM - xF

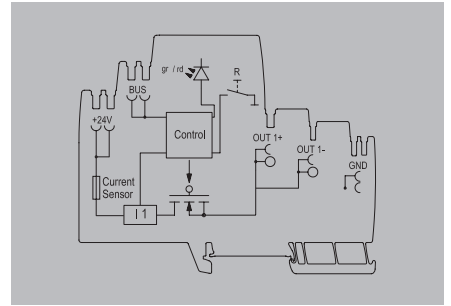

B

Technical data

Input	
Input fuse (internal)	Yes
DC input voltage range	18...30 V DC
Rated input voltage	24 V DC
Current consumption (idle) / Current consumption (full load)	25 mA / I _{out} +30 mA
max. admissible residual ripple at the input	100 mVpp
Output	
Connection system	PUSH IN
Triggering characteristic	see characteristic curve
Switch-on delay	1 s
Capacitive load	2080420000: 10,000 µF; 2080480000: 10,000 µF; 2080490000: 10,000 µF; 2080500000: 15,000 µF
Function key	
LED initial state	LED green, in operation LED flashing red, load monitoring has triggered (disconnected) LED red (permanently lit)
Pressing the button	> 0.1 to 2 s (manual disconnect) > 0.1 to 2 s (confirm and reset) > 0.1 to 2 s (restart)
LED, subsequent state	Red LED switched off Red LED switched off LED green switched on
General data	
Relay to activate the output	No
Surge protection input, output, bus	Suppressor diode
Protection degree / Overvoltage category	IP20 / III
Signalling	
LED green	Operation (failure-free)
Red LED	Load monitoring has disconnected, Load monitoring has triggered (flashing), Internal error (rapid flashing)
Connection data	
Number of terminals	2 (+ / -)
Wire cross-section, AWG/kcmil min/max	26...12
Wire cross-section, flexible min/max	0.14...2.5 mm ²
Wire cross-section, rigid min/max	0.14...2.5 mm ²
Screwdriver blade	0.6 x 3.5
Approvals	
Approvals	CE; cULus; EAC; TUEV
Note	

Ordering data

Rated current	
	1 A
	2 A
	4 A
	6 A
Note	

Accessories

Note	
------	--

Type	Qty.	Order No.
AMG ELM-1F	1	2080420000
AMG ELM-2F	1	2080480000
AMG ELM-4F	1	2080490000
AMG ELM-6F	1	2080500000

Type	Qty.	Order No.
AMG DIS	10	2123050000
AMG MD	10	2122930000
AMG OD	10	2122910000
AMG PD	10	2122920000

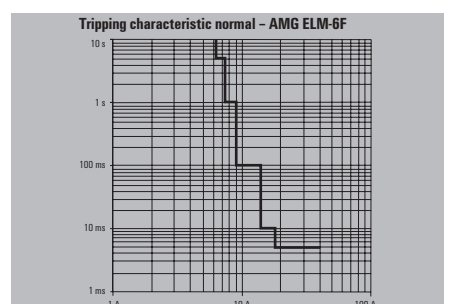
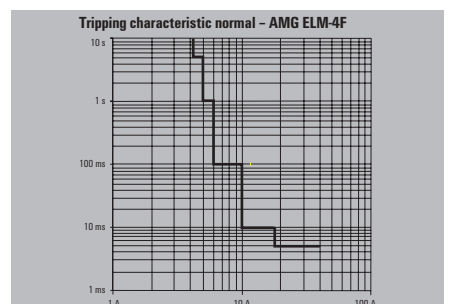
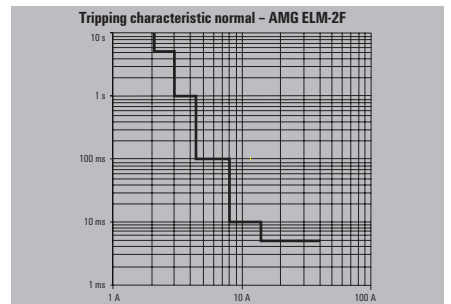
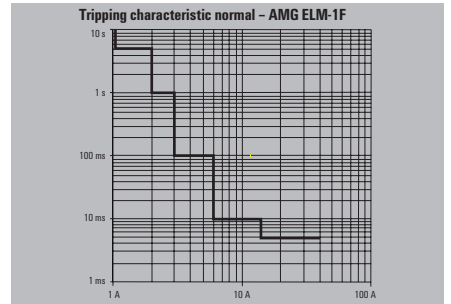

maxGUARD – load monitoring (fixed value)

Electronic load monitoring with fixed rated current (without I > 90 % pre warning > 90 %)

AMG ELM - xF

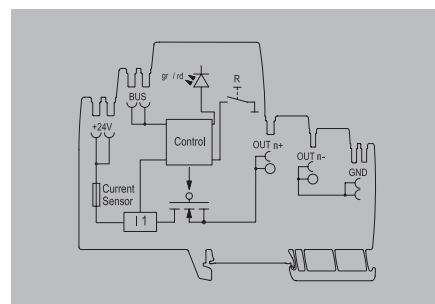

Technical data

Input	
Input fuse (internal)	Yes
DC input voltage range	18...30 V DC
Rated input voltage	24 V DC
Current consumption (idle)	25 mA
Current consumption (full load)	I _{OUT} +30 mA
max. admissible residual ripple at the input	100 mVpp
Output	
Connection system	PUSH IN
Triggering characteristic	see characteristic curve
Switch-on delay	1 s
Capacitive load	208060000: 15,000 µF; 208065000: 20,000 µF
Function key	
LED initial state	LED green, in operation
Pressing the button	> 0.1 to 2 s (manual disconnect)
LED, subsequent state	LED flashing red, load monitoring has triggered (disconnected)
Output, subsequent state	LED red (permanently lit)
General data	
Relay to activate the output	No
Protection degree	IP20
Surge protection input, output, bus	Suppressor diode
Oversvoltage category	III
Signalling	
LED green	Operation (failure-free)
Red LED	Load monitoring has disconnected, Load monitoring has triggered (flashing), Internal error (rapid flashing)
Connection data	
Number of terminals	4 (++ / -)
Wire cross-section, AWG/kcmil min/max	26...12
Wire cross-section, flexible min/max	0.14...2.5 mm ²
Wire cross-section, rigid min/max	0.14...2.5 mm ²
Screwdriver blade	0.6 x 3.5
Approvals	
Approvals	CE; cULus; EAC; TUEV
Note	

Type	Qty.	Order No.
AMG ELM-8F	1	2080600000
AMG ELM-10F	1	2080650000

Ordering data

Rated current	
	8 A
	10 A
Note	

Accessories

Type	Qty.	Order No.
AMG DIS	10	2123050000
AMG MD	10	2122930000
AMG OD	10	2122910000
AMG PD	10	2122920000
Note		

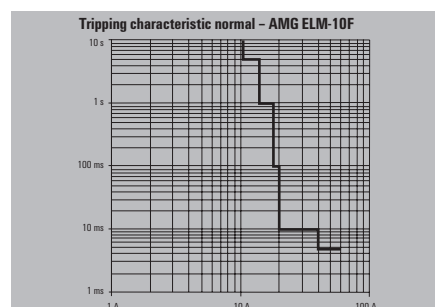
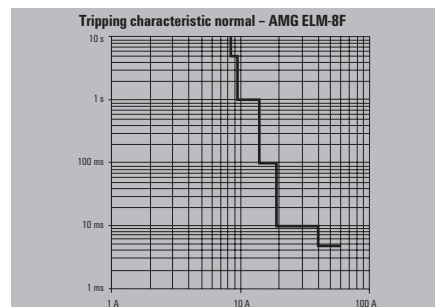

maxGUARD

**maxGUARD – load monitoring (fixed value),
Class 2**

Electronic load monitoring with fixed rated current
(without I > 90 % pre warning)

- Class 2 Approval

AMG ELM - xF CL2

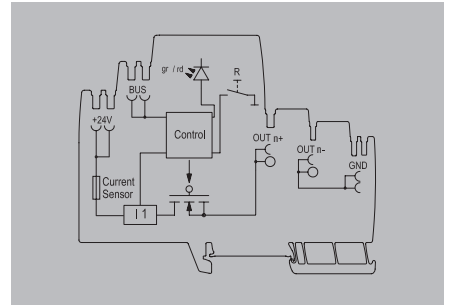

Technical data

Input	
Input fuse (internal)	Yes
DC input voltage range	18...30 V DC
Rated input voltage	24 V DC
Current consumption (idle)	25 mA
Current consumption (full load)	I _{OUT} +30 mA
max. admissible residual ripple at the input	100 mVpp
Output	
Connection system	PUSH IN
Triggering characteristic	see characteristic curve
Switch-on delay	1 s
Capacitive load	2491270000: 4.700 µF; 2491280000: 4.700 µF; 2491290000: 4.700 µF
Function key	
LED initial state	LED green, in operation LED flashing red, load monitoring has triggered (disconnected) LED red (permanently lit)
Pressing the button	> 0.1 to 2 s (manual disconnect) > 0.1 to 2 s (confirm and reset) > 0.1 to 2 s (restart)
LED, subsequent state	Red LED switched off Red LED switched off LED green switched on
General data	
Relay to activate the output	No
Protection degree	IP20
Surge protection input, output, bus	Suppressor diode
Overvoltage category	III
Signalling	
LED green	Operation (failure-free)
Red LED	Load monitoring has disconnected, Load monitoring has triggered (flashing), Internal error (rapid flashing)
Connection data	
Number of terminals	2 (+ / -)
Wire cross-section, AWG/kcmil min/max	26...12
Wire cross-section, flexible min/max	0.14...2.5 mm ²
Wire cross-section, rigid min/max	0.14...2.5 mm ²
Screwdriver blade	0.6 x 3.5
Approvals	
Approvals	CE; cULus; TUEV
Note	

Ordering data

	1 A
	2 A
	4 A
Note	

Accessories

Note	
------	--

Type	Qty.	Order No.
AMG ELM-1F CL2	1	2491270000
AMG ELM-2F CL2	1	2491280000
AMG ELM-4F CL2	1	2491290000

Type	Qty.	Order No.
AMG DIS	10	2123050000
AMG MD	10	2122930000
AMG OD	10	2122910000
AMG PD	10	2122920000

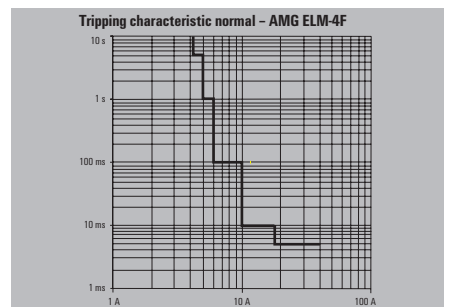
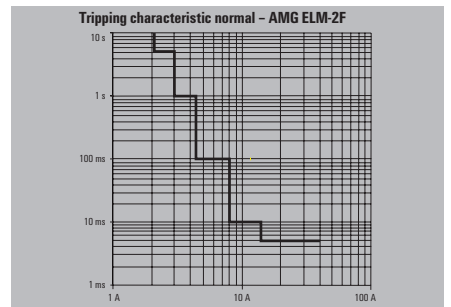
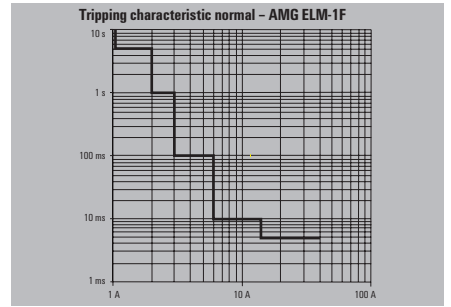

maxGUARD – load monitoring adjustable

Electronic load monitoring with adjustable triggering current and triggering characteristic

AMG ELM-6

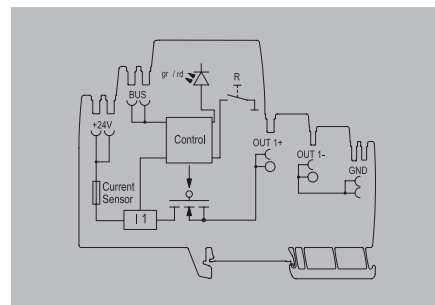

Technical data

Input	
Input fuse (internal)	Yes
DC input voltage range	18...30 V DC
Rated input voltage	24 V DC
Current consumption (idle)	25 mA
Current consumption (full load)	I _{OUT} +30 mA
max. admissible residual ripple at the input	100 mVpp
Output	
Connection system	PUSH IN
Triggering characteristic	see characteristic curve
Adjustable range	1- 6 A
Switch-on delay	1 s
Capacitive load	15,000 µF
adjustable rated current	Yes
Function key	
LED initial state	LED green, in operation
Pressing the button	> 0.1 to 2 s (manual disconnect)
LED, subsequent state	LED flashing red, load monitoring has triggered (disconnected)
Output, subsequent state	> 0.1 to 2 s (confirm and reset)
	Red LED switched off
	LED green switched on
General data	
Relay to activate the output	No
Protection degree	IP20
Surge protection input, output, bus	Suppressor diode
Overvoltage category	III
Signalling	
LED green	Operation (failure-free), Early warning: I _{Out} > 90% I _{Rated} (flashing)
Red LED	Load monitoring has disconnected, Load monitoring has triggered (flashing), Internal error (rapid flashing)
Connection data	
Number of terminals	2 (+ / -)
Wire cross-section, AWG/kcmil min/max	26...12
Wire cross-section, flexible min/max	0.14...2.5 mm ²
Wire cross-section, rigid min/max	0.14...2.5 mm ²
Screwdriver blade	0.6 x 3.5
Approvals	
Approvals	CE; cULus; EAC; TUEV
Note	

Ordering data

Rated current	6 A
Note	

Accessories

Note	
-------------	--

LED green, in operation	LED flashing red, load monitoring has triggered (disconnected)	LED red (permanently lit)
> 0.1 to 2 s (manual disconnect)	> 0.1 to 2 s (confirm and reset)	> 0.1 to 2 s (restart)
Red LED switched off	Red LED switched off	LED green switched on
Operation (failure-free), Early warning: I_{Out} > 90% I_{Rated} (flashing)		
Load monitoring has disconnected, Load monitoring has triggered (flashing), Internal error (rapid flashing)		
2 (+ / -)		
26...12		
0.14...2.5 mm ²		
0.14...2.5 mm ²		
0.6 x 3.5		
CE; cULus; EAC; TUEV		

Type	Qty.	Order No.
AMG ELM-6	1	2080360000

Type	Qty.	Order No.
AMG DIS	10	2123050000
AMG MD	10	2122930000
AMG OD	10	2122910000
AMG PD	10	2122920000

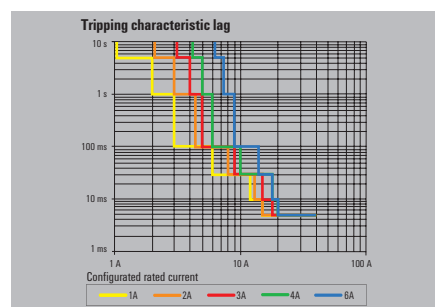
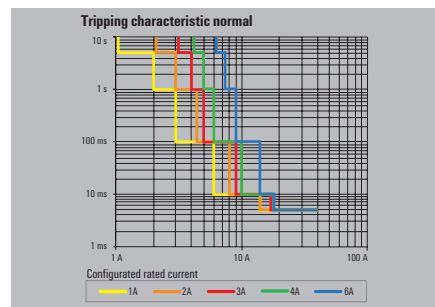

maxGUARD

maxGUARD – load monitoring adjustable

Electronic load monitoring with adjustable trigger current and characteristic (with I > 90 % pre warning > 90 %)

AMG ELM-12

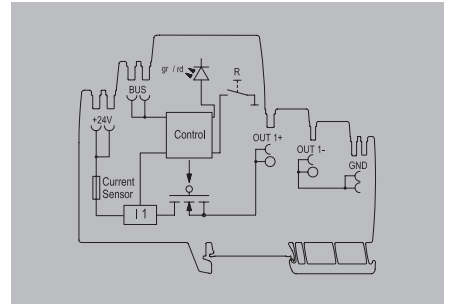

Technical data

Input	
Input fuse (internal)	Yes
DC input voltage range	18...30 V DC
Rated input voltage	24 V DC
Current consumption (idle)	25 mA
Current consumption (full load)	I _{OUT} +30 mA
max. admissible residual ripple at the input	100 mVpp
Output	
Connection system	PUSH IN
Triggering characteristic	see characteristic curve
Adjustable range	4-12 A
Switch-on delay	1 s
adjustable rated current	Yes
Capacitive load	20,000 µF
Function key	
LED initial state	LED green, in operation
Pressing the button	> 0.1 to 2 s (manual disconnect)
LED, subsequent state	LED flashing red, load monitoring has triggered (disconnected)
Output, subsequent state	Red LED switched off
General data	
Relay to activate the output	No
Protection degree	IP20
Surge protection input, output, bus	Suppressor diode
Overvoltage category	III
Signalling	
LED green	Operation (failure-free), Early warning: I Out > 90% I Rated (flashing)
Red LED	Load monitoring has disconnected, Load monitoring has triggered (flashing), Internal error (rapid flashing)
Connection data	
Number of terminals	4 (++ / -)
Wire cross-section, AWG/kcmil min/max	26...12
Wire cross-section, flexible min/max	0.14...2.5 mm ²
Wire cross-section, rigid min/max	0.14...2.5 mm ²
Screwdriver blade	0.6 x 3.5
Approvals	
Approvals	CE; cULus; EAC; TUEV
Note	

Ordering data

Rated current	12 A
Note	

Accessories

Note	
-------------	--

LED green, in operation	LED flashing red, load monitoring has triggered (disconnected)	LED red (permanently lit)
> 0.1 to 2 s (manual disconnect)	> 0.1 to 2 s (confirm and reset)	> 0.1 to 2 s (restart)
Red LED switched off	Red LED switched off	LED green switched on
No		
IP20		
Suppressor diode		
III		
Operation (failure-free), Early warning: I Out > 90% I Rated (flashing)		
Load monitoring has disconnected, Load monitoring has triggered (flashing), Internal error (rapid flashing)		
4 (++ / -)		
26...12		
0.14...2.5 mm ²		
0.14...2.5 mm ²		
0.6 x 3.5		
CE; cULus; EAC; TUEV		

Type	Qty.	Order No.
AMG ELM-12	1	2080410000

Type	Qty.	Order No.
AMG DIS	10	2123050000
AMG MD	10	2122930000
AMG OD	10	2122910000
AMG PD	10	2122920000

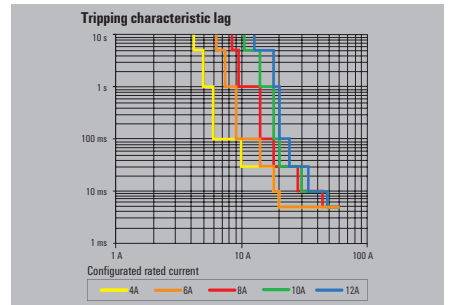
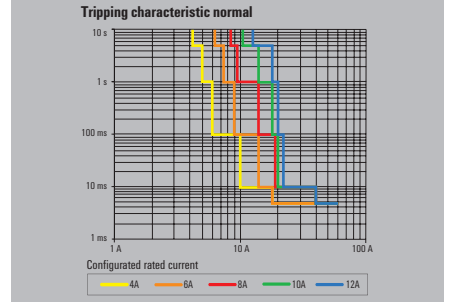

maxGUARD – load monitoring adjustable

AMG ELM-18

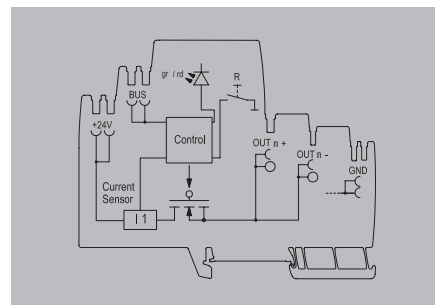

Technical data

Input	
Input fuse (internal)	Yes
DC input voltage range	18...30 V DC
Rated input voltage	24 V DC
Current consumption (idle)	25 mA
Current consumption (full load)	I _{OUT} +30 mA
max. admissible residual ripple at the input	100 mVpp
Output	
Connection system	PUSH IN
Triggering characteristic	see characteristic curve
Adjustable range	10-18 A
Switch-on delay	1 s
adjustable rated current	Yes
Capacitive load	50 mF
Function key	
LED initial state	LED green, in operation
Pressing the button	> 0.1 to 2 s (manual disconnect)
LED, subsequent state	LED flashing red, load monitoring has triggered (disconnected)
Output, subsequent state	Red LED switched off
General data	
Relay to activate the output	No
Protection degree	IP20
Surge protection input, output, bus	Suppressor diode
Overvoltage category	III
Signalling	
LED green	Operation (failure-free), Early warning: I _{Out} > 90% I _{Rated} (flashing)
Red LED	Load monitoring has disconnected, Load monitoring has triggered (flashing), Internal error (rapid flashing)
Connection data	
Number of terminals	4 (++) / (-)
Wire cross-section, AWG/kcmil min/max	26...12
Wire cross-section, flexible min/max	0.14...2.5 mm ²
Wire cross-section, rigid min/max	0.14...2.5 mm ²
Screwdriver blade	0.6 x 3.5
Approvals	
Approvals	cULus
Note	

LED flashing red, load monitoring has triggered (disconnected)	LED red (permanently lit)
> 0.1 to 2 s (confirm and reset)	> 0.1 to 2 s (restart)
Red LED switched off	LED green switched on
Operation (failure-free), Early warning: I _{Out} > 90% I _{Rated} (flashing)	
Load monitoring has disconnected, Load monitoring has triggered (flashing), Internal error (rapid flashing)	
Type	
AMG ELM-18	Qty. 10
Order No.	
2859800000	

Ordering data

Rated current	
	18 A
Note	

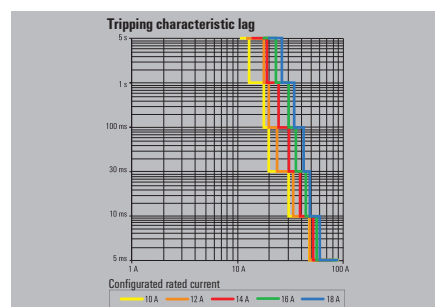
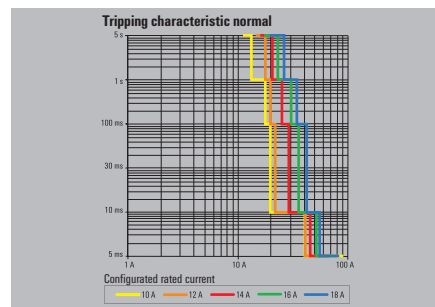

maxGUARD

maxGUARD – load monitoring with relay

Electronic load monitoring with 2-pole output relay for all-pole load disconnection; triggering current and triggering characteristic adjustable.

AMG ELM – adjustable with output relay

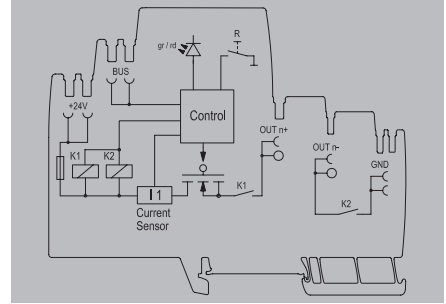

Technical data

Input	
Input fuse (internal)	Yes
DC input voltage range	18...30 V DC
Rated input voltage	24 V DC
Current consumption (idle)	40 mA
max. admissible residual ripple at the input	100 mVpp
Output	
Connection system	PUSH IN
Triggering characteristic	see characteristic curve
Adjustable range	2082470000: 4- 10 A 2082440000: 1- 6 A
Switch-on delay	1 s
adjustable rated current	Yes
Capacitive load	2082470000: 20,000 µF 2082440000: 15,000 µF
Function key	
LED initial state	LED green, in operation LED flashing red, load monitoring has triggered (disconnected) LED red (permanently lit)
Pressing the button	> 0.1 to 2 s (manual disconnect) > 0.1 to 2 s (confirm and reset) > 0.1 to 2 s (restart)
LED, subsequent state	Red LED
Output, subsequent state	switched off switched off switched on
General data	
Relay to activate the output	Yes
Protection degree / Surge protection	IP20 / Suppressor diode
Conformal coating	Yes
Surge protection input, output, bus	Suppressor diode
Signalling	
LED green	Operation (failure-free), Early warning: I Out > 90% I Rated (flashing)
Red LED	Load monitoring has disconnected, Load monitoring has triggered (flashing), Internal error (rapid flashing)
Connection data	
Number of terminals	6 (3x + / 3x -)
Wire cross-section, AWG/kcmil min/max	26...12
Wire cross-section, flexible min/max	0.14...2.5 mm ²
Wire cross-section, rigid min/max	0.14...2.5 mm ²
Screwdriver blade	0.6 x 3.5
Approvals	
Approvals	ABS; BURVER; CE; cULus; DETNORVER; EAC; LLOYDSREG; RINA; TUEV
Note	

Ordering data

Rated current	6 A
	10 A
Note	

Accessories

Type	Qty.	Order No.
AMG DIS	10	2123050000
AMG MD	10	2122930000
AMG OD	10	2122910000
AMG PD	10	2122920000
Note		

Type	Qty.	Order No.
AMG ELM-6D CD	1	2082440000
AMG ELM-10D CD	1	2082470000

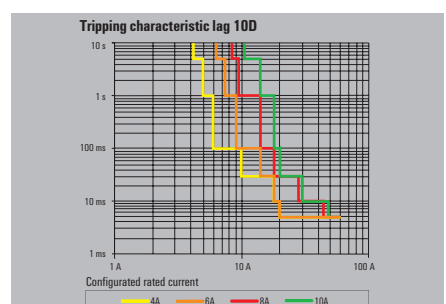
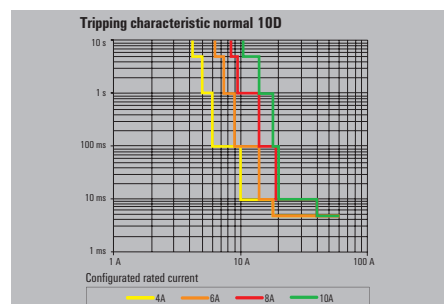
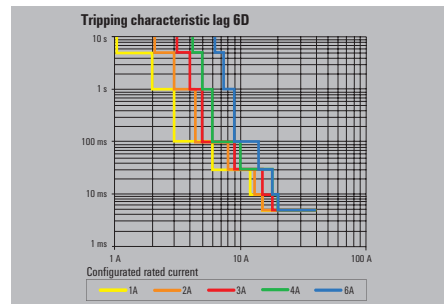
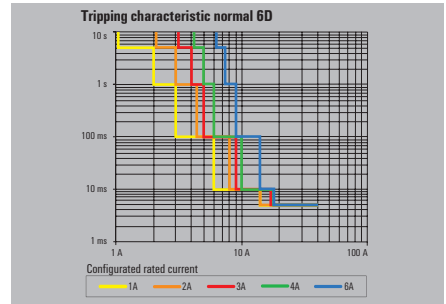

maxGUARD – Alarm module

Alarm module with potential-free contacts for the “Alarm” and “I>90%” signals > 90 %.

AMG AM

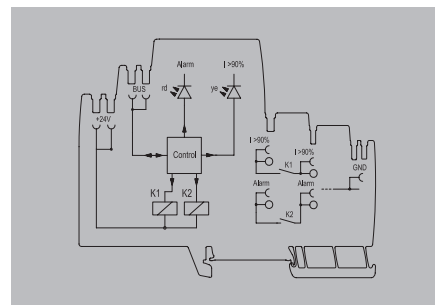

Technical data

Input	
Input fuse (internal)	No
DC input voltage range	18...30 V DC
Rated input voltage	24 V DC
Current consumption (idle)	25 mA
Current consumption (full load)	30 mA
max. admissible residual ripple at the input	100 mVpp
General data	
Protection degree	IP20
Surge protection input, bus	Suppressor diode
Overvoltage category	III
Signalling	
Yellow LED	Current > 90% Inom (flashing)
Red LED	Alarm
Floating contact	Yes
Status relay (max. load)	Alarm (24 V / 0.1 A), I > 90 % (24 V / 0.1 A)
Connection data	
Number of terminals	4 (2 x NO)
Wire cross-section, AWG/kcmil min/max	26...12
Wire cross-section, flexible min/max	0.14...2.5 mm ²
Wire cross-section, rigid min/max	0.14...2.5 mm ²
Screwdriver blade	0.6 x 3.5
Approvals	
Approvals	CE; cULus; EAC; TUEV
Note	

Input		
Input fuse (internal)	No	
DC input voltage range	18...30 V DC	
Rated input voltage	24 V DC	
Current consumption (idle)	25 mA	
Current consumption (full load)	30 mA	
max. admissible residual ripple at the input	100 mVpp	
General data		
Protection degree	IP20	
Surge protection input, bus	Suppressor diode	
Overvoltage category	III	
Signalling		
Yellow LED	Current > 90% Inom (flashing)	
Red LED	Alarm	
Floating contact	Yes	
Status relay (max. load)	Alarm (24 V / 0.1 A), I > 90 % (24 V / 0.1 A)	
Connection data		
Number of terminals	4 (2 x NO)	
Wire cross-section, AWG/kcmil min/max	26...12	
Wire cross-section, flexible min/max	0.14...2.5 mm ²	
Wire cross-section, rigid min/max	0.14...2.5 mm ²	
Screwdriver blade	0.6 x 3.5	
Approvals		
Approvals	CE; cULus; EAC; TUEV	
Note		

Ordering data

Rated current	
Note	

Type	Qty.	Order No.
AMG AM	1	2081890000

Accessories

Plug-in cross-connection	
50-pole	
50-pole / red	
50-pole / blue	
2-pole	
2-pole / red	
2-pole / blue	
Note	

Type	Qty.	Order No.
ZQV 4N/50	5	1528130000
ZQV 4N/50 RD	5	2460730000
ZQV 4N/50 BL	5	1528240000
ZQV 4N/2	60	1527930000
ZQV 4N/2 RD	60	2460450000
ZQV 4N/2 BL	60	1528040000

maxGUARD

maxGUARD – control module

Control module with extended control function: alarm, reset, I >90% connection/disconnection

AMG CM

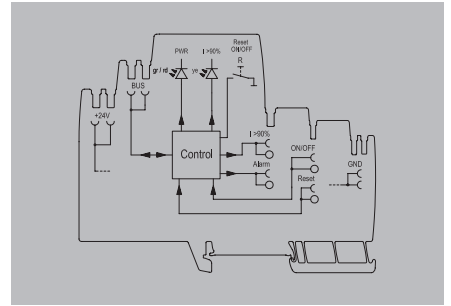

B

Technical data

Input	
DC input voltage range	18...30 V DC
Rated input voltage	24 V DC
Current consumption (idle)	25 mA
Current consumption (full load)	225 mA
max. admissible residual ripple at the input	100 mVpp
Output	
Connection system	PUSH IN
General data	
Relay to activate the output	No
Protection degree	IP20
Control inputs	ON/ OFF, Reset
Surge protection input, output, bus	Suppressor diode
Overvoltage category	III
Signalling	
LED green	Operation (failure-free), Early warning: I Out > 90% I Rated (flashing)
Red LED	Load monitoring has disconnected, Load monitoring has triggered (flashing), Internal error (rapid flashing)
Transistor output, positive-switching	Pre-warning, Alarm
Connection data	
Number of terminals	2 (Reset / ON)
Wire cross-section, AWG/kcmil min/max	26...12
Wire cross-section, flexible min/max	0.14...2.5 mm ²
Wire cross-section, rigid min/max	0.14...2.5 mm ²
Screwdriver blade	0.6 x 3.5
Approvals	
Approvals	CE; cULus; EAC; TUEV
Note	

Type	Qty.	Order No.
AMG CM	1	2081900000

Ordering data

Rated current	
Note	

Accessories

Plug-in cross-connection	
50-pole	ZQV 4N/50
50-pole / red	ZQV 4N/50 RD
50-pole / blue	ZQV 4N/50 BL
2-pole	ZQV 4N/2
2-pole/ red	ZQV 4N/2 RD
2-pole / blue	ZQV 4N/2 BL
Note	

Type	Qty.	Order No.
ZQV 4N/50	5	1528130000
ZQV 4N/50 RD	5	2460730000
ZQV 4N/50 BL	5	1528240000
ZQV 4N/2	60	1527930000
ZQV 4N/2 RD	60	2460450000
ZQV 4N/2 BL	60	1528040000

maxGUARD – Potential distributor

Potential distribution in combination with the electronic load monitoring.

AMG

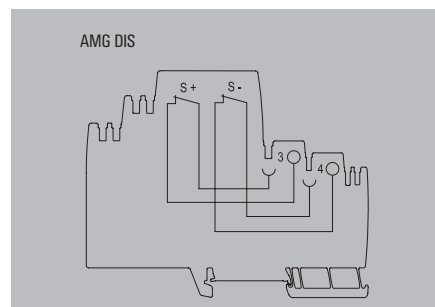
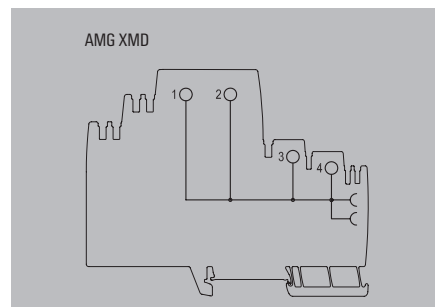
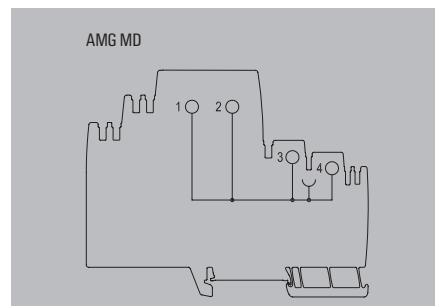
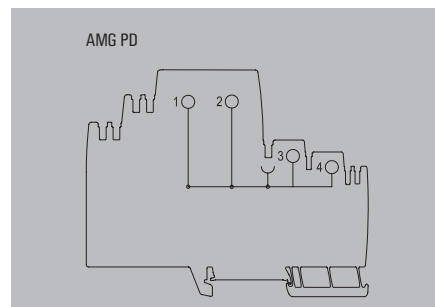
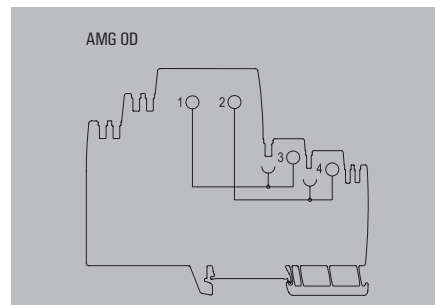
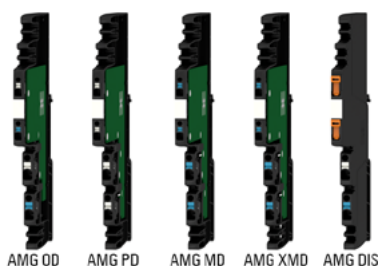

Technical data

General data	
Protection degree	IP20
Total current load per potential	2122910000: 12 A; 2122920000: 12 A; 2122930000: 12 A; 2122940000: 24 A; 2123050000: 12 A
Current load per contact point	12 A
Connection data	
Connection system	PUSH IN
Number of terminals	4 (++ / -), 2 x 1.5 mm ² , 2 x 2.5 mm ²
Wire cross-section, AWG/kcmil min/max	26...12
Wire cross-section, flexible min/max	0.14...2.5 mm ²
Wire cross-section, rigid min/max	0.14...2.5 mm ²
Screwdriver blade	0.6 x 3.5
Approvals	
Approvals	CE; cULus; EAC; TUEV
Note	

Ordering data

Type	Qty.	Order No.
AMG OD	10	2122910000
AMG PD	10	2122920000
AMG MD	10	2122930000
AMG XMD	10	2122940000
AMG DIS	10	2123050000
Note		

Accessories

Plug-in cross-connection	
50-pole	ZQV 4N/50
50-pole / red	ZQV 4N/50 RD
50-pole / blue	ZQV 4N/50 BL
2-pole	ZQV 4N/2
2-pole / red	ZQV 4N/2 RD
2-pole / blue	ZQV 4N/2 BL
Note	

Type	Qty.	Order No.
ZQV 4N/50	5	1528130000
ZQV 4N/50 RD	5	2460730000
ZQV 4N/50 BL	5	1528240000
ZQV 4N/2	60	1527930000
ZQV 4N/2 RD	60	2460450000
ZQV 4N/2 BL	60	1528040000
Note		

maxGUARD – power-feed module

Active power-feed module with reset and alarm function

AMG FIM-C Ex

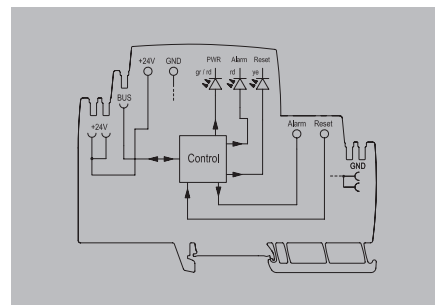

Technical data

Input	
Input fuse (internal)	No
DC input voltage range	18...30 V DC
Rated input voltage	24 V DC
Current consumption (idle)	20 mA
Current consumption (full load)	120 mA
max. admissible residual ripple at the input	100 mVpp
General data	
Protection degree	IP20
Control inputs	Reset
Surge protection input, output, bus	Suppressor diode
Overtoltage category	III
Signalling	
Yellow LED	External reset is signalled, Alarm is signalled
LED green	Operating voltage OK
Red LED	Alarm
Transistor output, positive-switching	Alarm
Connection data	
Number of terminals	2 (+,-)
Wire cross-section, AWG/kcmil min/max	18...6
Wire cross-section, flexible min/max	0.75...16 mm ²
Wire cross-section, rigid min/max	0.75...10 mm ²
Screwdriver blade	1.2 x 6.5
Approvals	
Approvals	ABS; BURVER; CE; cULus; cULusEX; DEMKOATEX; DETNORVER; EAC; IECEXULD; LLOYDSREG; RINA; TUEV
Note	
Ordering data	
Rated current	
Note	

Type	Qty.	Order No.
AMG FIM-C EX	1	2082540000

maxGUARD

maxGUARD – load monitoring (fixed value)

Electronic load monitoring with fixed current (without I > 90% function)

AMG ELM - xF Ex

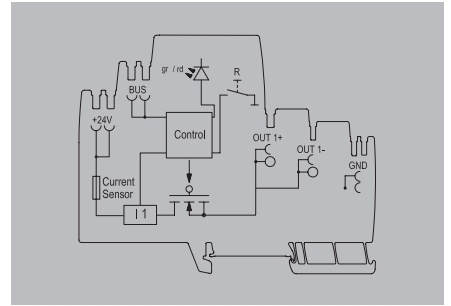

B

Technical data

Input	
Input fuse (internal)	Yes
DC input voltage range	18...30 V DC
Rated input voltage	24 V DC
Current consumption (idle) / Current consumption (full load)	25 mA / I _{out} +30 mA
max. admissible residual ripple at the input	100 mVpp
Output	
Connection system	PUSH IN
Triggering characteristic	see characteristic curve
Switch-on delay	1 s
Capacitive load	2082040000: 10,000 µF; 2082050000: 10,000 µF; 2082060000: 10,000 µF; 2082310000: 15,000 µF
Function key	
LED initial state	LED green, in operation LED flashing red, load monitoring has triggered (disconnected) LED red (permanently lit)
Pressing the button	> 0.1 to 2 s (manual disconnect) > 0.1 to 2 s (confirm and reset) > 0.1 to 2 s (restart)
LED, subsequent state	Red LED switched off Red LED switched off LED green switched on
General data	
Relay to activate the output	No
Surge protection input, output, bus	Suppressor diode
Protection degree / Overvoltage category	IP20 / III
Signalling	
LED green	Operation (failure-free)
Red LED	Load monitoring has disconnected, Load monitoring has triggered (flashing), Internal error (rapid flashing)
Connection data	
Number of terminals	2 (+ / -)
Wire cross-section, AWG/kcmil min/max	26...12
Wire cross-section, flexible min/max	0.14...2.5 mm ²
Wire cross-section, rigid min/max	0.14...2.5 mm ²
Screwdriver blade	0.6 x 3.5
Approvals	
Approvals	ABS; BURVER; CE; cULus; cULusEX; DEMKOATEX; DETNORVER; EAC; IECEXULD; LLOYDSREG; RINA; TUEV
Note	
Ordering data	
Rated current	
	1 A
	2 A
	4 A
	6 A
Note	
Accessories	
Note	

Type	Qty.	Order No.
AMG ELM-1F EX	1	2082040000
AMG ELM-2F EX	1	2082050000
AMG ELM-4F EX	1	2082060000
AMG ELM-6F EX	1	2082310000

Type	Qty.	Order No.
AMG OD EX	10	2495090000
AMG PD EX	10	2495070000
AMG MD EX	10	2495040000
AMG XMD EX	10	2495080000
AMG DIS EX	10	2495100000

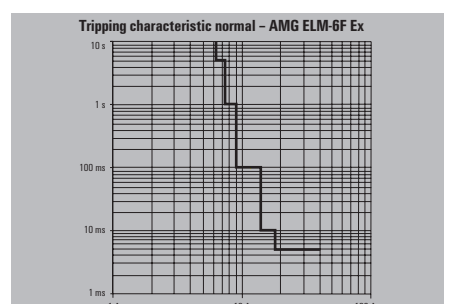
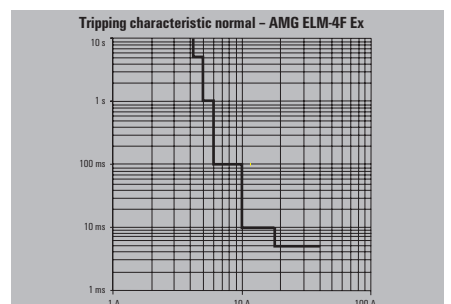
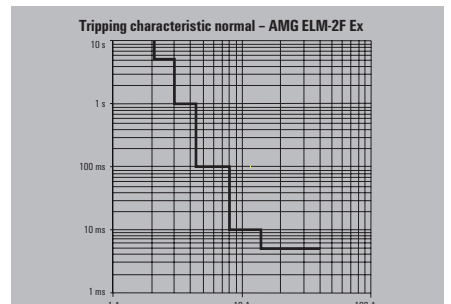
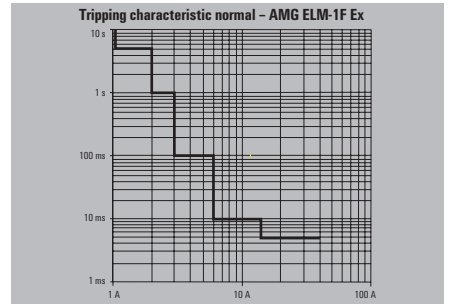

maxGUARD – load monitoring (fixed value)

Electronic load monitoring with fixed rated current (without I > 90 % pre warning)

Technical data

Input

- Input fuse (internal)
- DC input voltage range
- Rated input voltage
- Current consumption (idle)
- Current consumption (full load)
- max. admissible residual ripple at the input

Output

- Connection system
- Triggering characteristic
- Switch-on delay
- Capacitive load

Function key

LED initial state

Pressing the button

LED, subsequent state
Output, subsequent state

General data

- Relay to activate the output
- Protection degree
- Surge protection input, output, bus
- Overvoltage category

Signalling

LED green
Red LED

Connection data

- Number of terminals
- Wire cross-section, AWG/kcmil min/max
- Wire cross-section, flexible min/max
- Wire cross-section, rigid min/max
- Screwdriver blade

Approvals

Approvals

Note

Ordering data

Rated current

8 A
10 A

Note

Accessories

Type

Note

AMG ELM - xF Ex



Input

- Yes
- 18...30 V DC
- 24 V DC
- 25 mA
- I_{OUT} +30 mA
- 100 mVpp

Output

- PUSH IN
- see characteristic curve
- 1 s
- 2082320000: 15,000 µF;
- 2082430000: 20,000 µF

LED

LED green, in operation LED flashing red, load monitoring has triggered (disconnected) LED red (permanently lit)

> 0.1 to 2 s (manual disconnect) > 0.1 to 2 s (confirm and reset) > 0.1 to 2 s (restart)

Red LED switched off Red LED switched off LED green switched on

General data

- No
- IP20
- Suppressor diode
- III

Operation (failure-free)

Load monitoring has disconnected, Load monitoring has triggered (flashing), Internal error (rapid flashing)

Connection data

- 4 (++) / (-)
- 26...12
- 0.14...2.5 mm²
- 0.14...2.5 mm²
- 0.6 x 3.5

Approvals

ABS; BURVER; CE; cULus; cULusEX; DEMKOATEX; DETNORVER; EAC; IECEXULD; LLOYDSREG; RINA; TUEV

Note

Type **Qty.** **Order No.**

AMG ELM-8F EX	1	2082320000
AMG ELM-10F EX	1	2082430000

Type **Qty.** **Order No.**

AMG OD EX	10	2495090000
AMG PD EX	10	2495070000
AMG MD EX	10	2495040000
AMG XMD EX	10	2495080000
AMG DIS EX	10	2495100000

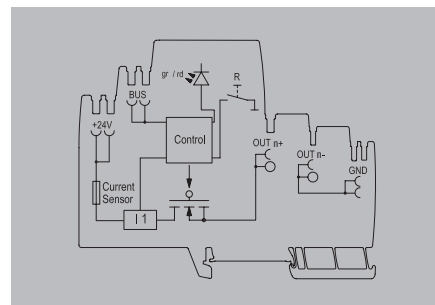

Tripping characteristic normal – AMG ELM-8F Ex

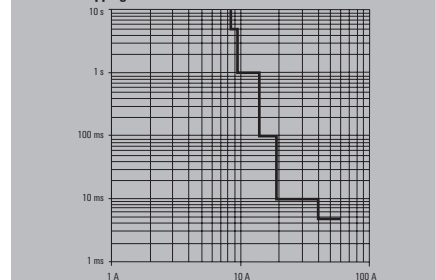

Tripping characteristic normal – AMG ELM-10F Ex

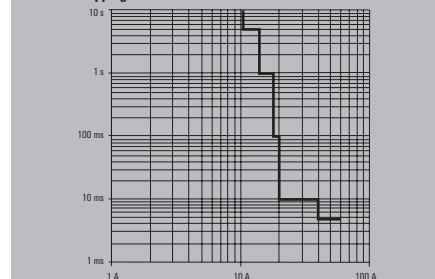

maxGUARD

maxGUARD – load monitoring adjustable

Electronic load monitoring with adjustable triggering current and triggering characteristic

AMG ELM-6 Ex

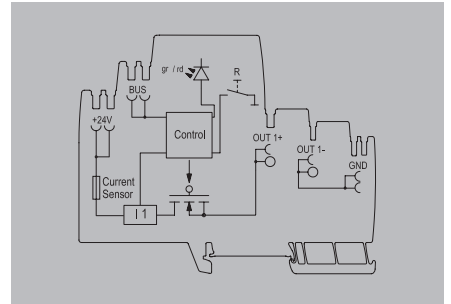

Technical data

Input	
Input fuse (internal)	Yes
DC input voltage range	18...30 V DC
Rated input voltage	24 V DC
Current consumption (idle)	25 mA
Current consumption (full load)	I _{OUT} +30 mA
max. admissible residual ripple at the input	100 mVpp
Output	
Connection system	PUSH IN
Triggering characteristic	see characteristic curve
Adjustable range	1- 6 A
Switch-on delay	1 s
Capacitive load	15,000 µF
adjustable rated current	Yes
Function key	
LED initial state	LED green, in operation
Pressing the button	> 0.1 to 2 s (manual disconnect)
LED, subsequent state	LED flashing red, load monitoring has triggered (disconnected)
Output, subsequent state	Red LED switched off
General data	
Relay to activate the output	No
Protection degree	IP20
Surge protection input, output, bus	Suppressor diode
Overvoltage category	III
Signalling	
LED green	Operation (failure-free), Early warning: I _{Out} > 90% I _{Rated} (flashing)
Red LED	Load monitoring has disconnected, Load monitoring has triggered (flashing), Internal error (rapid flashing)
Connection data	
Number of terminals	2 (+ / -)
Wire cross-section, AWG/kcmil min/max	26...12
Wire cross-section, flexible min/max	0.14...2.5 mm ²
Wire cross-section, rigid min/max	0.14...2.5 mm ²
Screwdriver blade	0.6 x 3.5
Approvals	
Approvals	ABS; BURVER; CE; cULus; cULusEX; DEMKOATEX; DETNORVER; EAC; IECEXULD; LLOYDSREG; RINA; TUEV
Note	

LED green, in operation	LED flashing red, load monitoring has triggered (disconnected)	LED red (permanently lit)
> 0.1 to 2 s (manual disconnect)	> 0.1 to 2 s (confirm and reset)	> 0.1 to 2 s (restart)
Red LED switched off	Red LED switched off	LED green switched on
Operation (failure-free), Early warning: I _{Out} > 90% I _{Rated} (flashing)		
Load monitoring has disconnected, Load monitoring has triggered (flashing), Internal error (rapid flashing)		
2 (+ / -)		
26...12		
0.14...2.5 mm ²		
0.14...2.5 mm ²		
0.6 x 3.5		
ABS; BURVER; CE; cULus; cULusEX; DEMKOATEX; DETNORVER; EAC; IECEXULD; LLOYDSREG; RINA; TUEV		

Ordering data

Rated current	6 A
Note	

Type	Qty.	Order No.
AMG ELM-6 EX	1	2082000000

Accessories

Type	Qty.	Order No.
AMG OD EX	10	2495090000
AMG PD EX	10	2495070000
AMG MD EX	10	2495040000
AMG XMD EX	10	2495080000
AMG DIS EX	10	2495100000
Note		

Type	Qty.	Order No.
AMG OD EX	10	2495090000
AMG PD EX	10	2495070000
AMG MD EX	10	2495040000
AMG XMD EX	10	2495080000
AMG DIS EX	10	2495100000

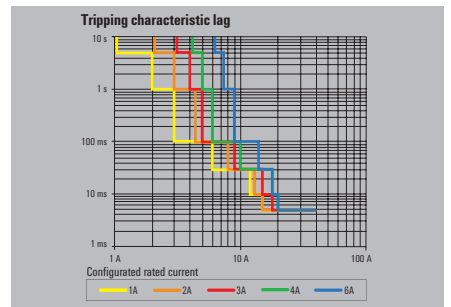
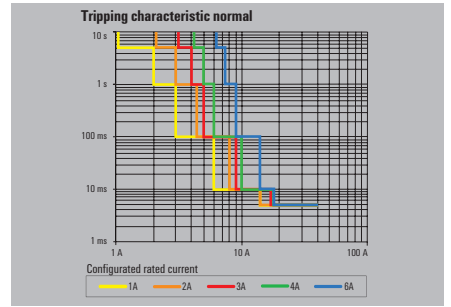

maxGUARD – load monitoring adjustable

Electronic load monitoring with adjustable trigger current and characteristic (with I > 90 % pre warning)

AMG ELM-12 Ex

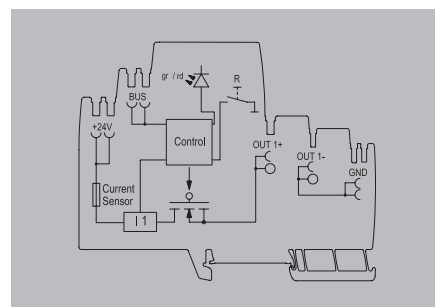

Technical data

Input

- Input fuse (internal)
- DC input voltage range
- Rated input voltage
- Current consumption (idle)
- Current consumption (full load)
- max. admissible residual ripple at the input

Output

- Connection system
- Triggering characteristic
- Adjustable range
- Switch-on delay
- adjustable rated current
- Capacitive load

Function key

LED initial state

Pressing the button

LED, subsequent state
Output, subsequent state

General data

- Relay to activate the output
- Protection degree
- Surge protection input, output, bus
- Overvoltage category

Signalling

- LED green
- Red LED

Connection data

- Number of terminals
- Wire cross-section, AWG/kcmil min/max
- Wire cross-section, flexible min/max
- Wire cross-section, rigid min/max
- Screwdriver blade

Approvals

Approvals

Note

Ordering data

Rated current 12 A

Note

Accessories

Note

Yes

18...30 V DC

24 V DC

25 mA

I_{OUT} +30 mA

100 mVpp

PUSH IN

see characteristic curve

4-12 A

1 s

Yes

20,000 µF

LED green, in operation

LED flashing red, load monitoring has triggered (disconnected)

LED red (permanently lit)

> 0.1 to 2 s (manual disconnect)

> 0.1 to 2 s (confirm and reset)

> 0.1 to 2 s (restart)

Red LED switched off

Red LED switched off

LED green switched on

No

IP20

Suppressor diode

III

Operation (failure-free), Early warning: I Out > 90% I Rated (flashing)

Load monitoring has disconnected, Load monitoring has triggered (flashing), Internal error (rapid flashing)

4 (++) / -)

26...12

0.14...2.5 mm²

0.14...2.5 mm²

0.6 x 3.5

ABS; BURVER; CE; cULus; cULusEX; DEMKOATEX; DETNORVER; EAC; IECEXULD; LLOYDSREG; RINA; TUEV

Tripping characteristic normal Ex

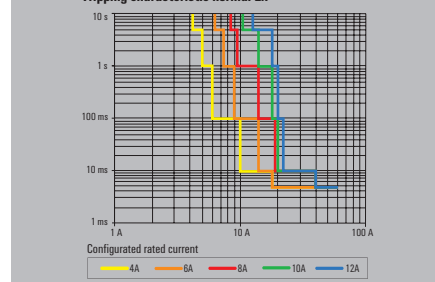

Tripping characteristic lag

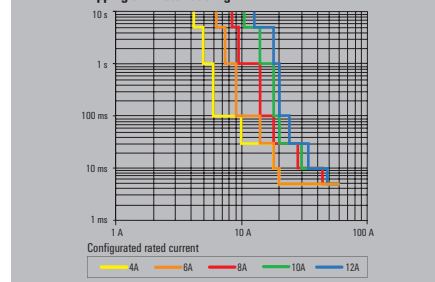

Type	Qty.	Order No.
AMG ELM-12 EX	1	2082010000

Type	Qty.	Order No.
AMG OD EX	10	2495090000
AMG PD EX	10	2495070000
AMG MD EX	10	2495040000
AMG XMD EX	10	2495080000
AMG DIS EX	10	2495100000

maxGUARD – load monitoring adjustable

AMG ELM-18 Ex

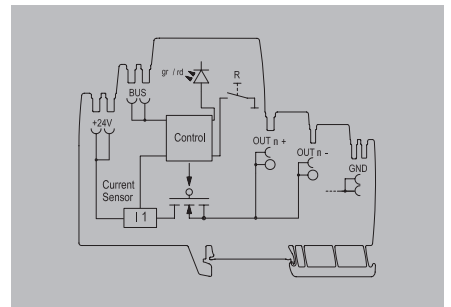

Technical data

Input	
Input fuse (internal)	Yes
DC input voltage range	18...30 V DC
Rated input voltage	24 V DC
Current consumption (idle)	25 mA
Current consumption (full load)	I _{OUT} +30 mA
max. admissible residual ripple at the input	100 mVpp
Output	
Connection system	PUSH IN
Triggering characteristic	see characteristic curve
Adjustable range	10-18 A
Switch-on delay adjustable rated current	1 s
Capacitive load	Yes
Function key	
LED initial state	LED green, in operation

Pressing the button

LED, subsequent state
Output, subsequent state

General data	
Relay to activate the output	No
Protection degree	IP20
Surge protection input, output, bus	Suppressor diode
Overvoltage category	III
Signalling	
LED green	Operation (failure-free), Early warning: I _{Out} > 90% I _{Rated} (flashing)
Red LED	Load monitoring has disconnected, Load monitoring has triggered (flashing), Internal error (rapid flashing)
Connection data	
Number of terminals	4 (++) / -)
Wire cross-section, AWG/kcmil min/max	26...12
Wire cross-section, flexible min/max	0.14...2.5 mm ²
Wire cross-section, rigid min/max	0.14...2.5 mm ²
Screwdriver blade	0.6 x 3.5
Approvals	
Approvals	cULus

Note

Ordering data

Rated current	18 A
Note	

Accessories

Type	Qty.	Order No.
AMG OD EX	10	2495090000
AMG PD EX	10	2495070000
AMG MD EX	10	2495040000
AMG XMD EX	10	2495080000
AMG DIS EX	10	2495100000
Note		

LED green, in operation	LED flashing red, load monitoring has triggered (disconnected)	LED red (permanently lit)
> 0.1 to 2 s (manual disconnect)	> 0.1 to 2 s (confirm and reset)	> 0.1 to 2 s (restart)
Red LED switched off	Red LED switched off	LED green switched on

Operation (failure-free), Early warning: I_{Out} > 90% I_{Rated} (flashing)
Load monitoring has disconnected, Load monitoring has triggered (flashing), Internal error (rapid flashing)

Type	Qty.	Order No.
AMG ELM-18 EX	1	2838520000

Type	Qty.	Order No.
AMG OD EX	10	2495090000
AMG PD EX	10	2495070000
AMG MD EX	10	2495040000
AMG XMD EX	10	2495080000
AMG DIS EX	10	2495100000

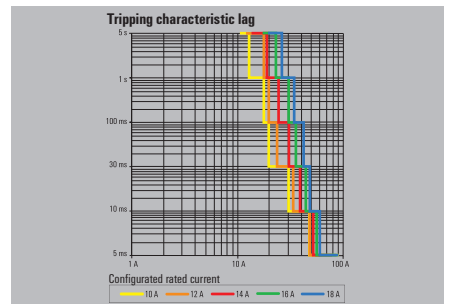
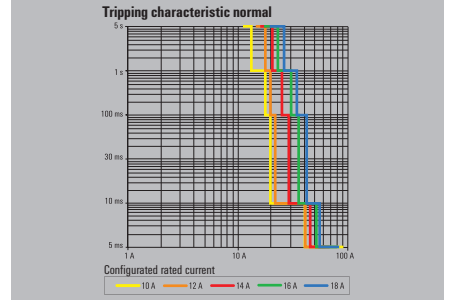

maxGUARD – Alarm module

Alarm module with potential-free contacts for the “Alarm” and “I>90%” signals.

AMG AM CO

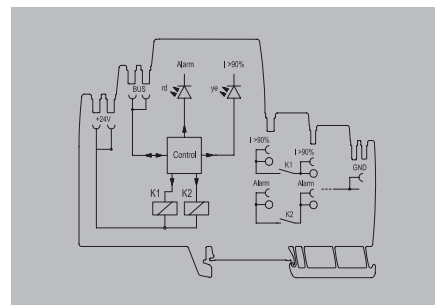

Technical data

Input
Input fuse (internal)
DC input voltage range
Rated input voltage
Current consumption (idle)
Current consumption (full load)
max. admissible residual ripple at the input
General data
Protection degree
Surge protection input, bus
Overvoltage category
Signalling
Yellow LED
Red LED
Floating contact
Status relay (max. load)
Connection data
Number of terminals
Wire cross-section, AWG/kcmil min/max
Wire cross-section, flexible min/max
Wire cross-section, rigid min/max
Screwdriver blade
Approvals
Approvals
Note

No
18...30 V DC
24 V DC
25 mA
30 mA
100 mVpp
IP20
Suppressor diode
III
Current > 90% Inom (flashing)
Alarm
Yes
Alarm (24 V / 0.1 A), I > 90 % (24 V / 0.1 A)
4 (2 x NO)
26...12
0.14...2.5 mm ²
0.14...2.5 mm ²
0.6 x 3.5
ABS; BURVER; CE; cULus; DETNORVER; EAC; LLOYDSREG; RINA; TUEV

Ordering data

Rated current
Note

Type	Qty.	Order No.
AMG AM CO	1	2082770000

Accessories

Plug-in cross-connection
50-pole
50-pole / red
50-pole / blue
2-pole
2-pole / red
2-pole / blue
Note

Type	Qty.	Order No.
ZQV 4N/50	5	1528130000
ZQV 4N/50 RD	5	2460730000
ZQV 4N/50 BL	5	1528240000
ZQV 4N/2	60	1527930000
ZQV 4N/2 RD	60	2460450000
ZQV 4N/2 BL	60	1528040000

maxGUARD

maxGUARD – control module

Control module with extended control function: Alarm, Reset, I>90%, ON/OFF

AMG CM Ex

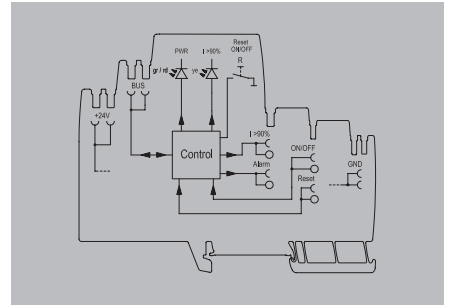

B

Technical data

Input	
DC input voltage range	18...30 V DC
Rated input voltage	24 V DC
Current consumption (idle)	25 mA
Current consumption (full load)	225 mA
max. admissible residual ripple at the input	100 mVpp
Output	
Connection system	PUSH IN
General data	
Relay to activate the output	No
Protection degree	IP20
Surge protection input, output, bus	Suppressor diode
Control inputs	ON/ OFF, Reset
Overvoltage category	III
Signalling	
LED green	Operation (failure-free), Early warning: I Out > 90% I Rated (flashing)
Red LED	Load monitoring has disconnected, Load monitoring has triggered (flashing), Internal error (rapid flashing)
Transistor output, positive-switching	Pre-warning, Alarm
Connection data	
Number of terminals	2 (Reset / ON)
Wire cross-section, AWG/kcmil min/max	26...12
Wire cross-section, flexible min/max	0.14...2.5 mm ²
Wire cross-section, rigid min/max	0.14...2.5 mm ²
Screwdriver blade	0.6 x 3.5
Approvals	
Approvals	ABS; BURVER; CE; cULus; cULusEX; DEMKOATEX; DETNORVER; EAC; IECEXULD; LLOYDSREG; RINA; TUEV
Note	

Input		
DC input voltage range	18...30 V DC	
Rated input voltage	24 V DC	
Current consumption (idle)	25 mA	
Current consumption (full load)	225 mA	
max. admissible residual ripple at the input	100 mVpp	
Output		
Connection system	PUSH IN	
General data		
Relay to activate the output	No	
Protection degree	IP20	
Surge protection input, output, bus	Suppressor diode	
Control inputs	ON/ OFF, Reset	
Overvoltage category	III	
Signalling		
LED green	Operation (failure-free), Early warning: I Out > 90% I Rated (flashing)	
Red LED	Load monitoring has disconnected, Load monitoring has triggered (flashing), Internal error (rapid flashing)	
Transistor output, positive-switching	Pre-warning, Alarm	
Connection data		
Number of terminals	2 (Reset / ON)	
Wire cross-section, AWG/kcmil min/max	26...12	
Wire cross-section, flexible min/max	0.14...2.5 mm ²	
Wire cross-section, rigid min/max	0.14...2.5 mm ²	
Screwdriver blade	0.6 x 3.5	
Approvals		
Approvals	ABS; BURVER; CE; cULus; cULusEX; DEMKOATEX; DETNORVER; EAC; IECEXULD; LLOYDSREG; RINA; TUEV	
Note		

Ordering data

Rated current	
Note	

Type	Qty.	Order No.
AMG CM EX	1	2083360000

Accessories

Plug-in cross-connection	
	50-pole
	50-pole / red
	50-pole / blue
	2-pole
	2-pole/ red
	2-pole / blue
Note	

Type	Qty.	Order No.
ZQV 4N/50	5	1528130000
ZQV 4N/50 RD	5	2460730000
ZQV 4N/50 BL	5	1528240000
ZQV 4N/2	60	1527930000
ZQV 4N/2 RD	60	2460450000
ZQV 4N/2 BL	60	1528040000

maxGUARD – Potential distributor

Potential distribution in combination with the electronic load monitoring.

AMG

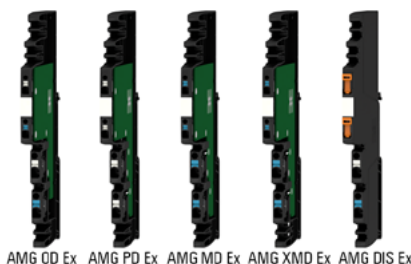

AMG OD Ex AMG PD Ex AMG MD Ex AMG XMD Ex AMG DIS Ex

Technical data

General data	
Protection degree	IP20
Total current load per potential	2495090000: 12 A; 2495070000: 12 A; 2495040000: 12 A; 2495080000: 24 A; 2495100000: 12 A
Current load per contact point	12 A
Connection data	
Connection system	PUSH IN
Number of terminals	4 (++ / -), 2 x 1.5 mm ² , 2 x 2.5 mm ²
Wire cross-section, AWG/kcmil min/max	26...12
Wire cross-section, flexible min/max	0.14...2.5 mm ²
Wire cross-section, rigid min/max	0.14...2.5 mm ²
Screwdriver blade	0.6 x 3.5
Approvals	
Approvals	ABS; BURVER; CE; cULus; cULusEX; DEMKOATEX; DETNORVER; EAC; IECEXULD; LLOYDSREG; RINA; TUEV
Note	

Ordering data

Type	Qty.	Order No.
AMG OD EX	10	2495090000
AMG PD EX	10	2495070000
AMG MD EX	10	2495040000
AMG XMD EX	10	2495080000
AMG DIS EX	10	2495100000

Accessories

Plug-in cross-connection	
50-pole	ZQV 4N/50
50-pole / red	ZQV 4N/50 RD
50-pole / blue	ZQV 4N/50 BL
2-pole	ZQV 4N/2
2-pole / red	ZQV 4N/2 RD
2-pole / blue	ZQV 4N/2 BL
Note	

Type	Qty.	Order No.
ZQV 4N/50	5	1528130000
ZQV 4N/50 RD	5	2460730000
ZQV 4N/50 BL	5	1528240000
ZQV 4N/2	60	1527930000
ZQV 4N/2 RD	60	2460450000
ZQV 4N/2 BL	60	1528040000

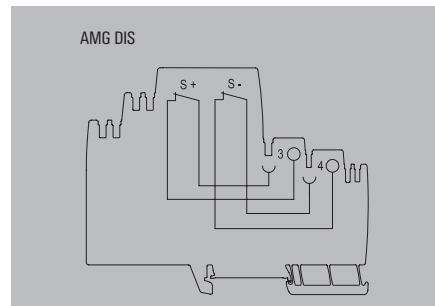
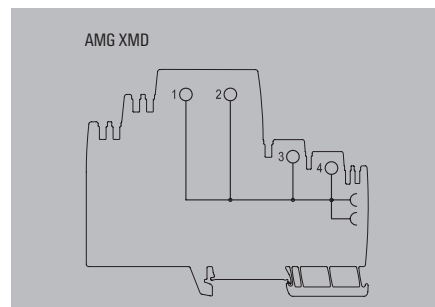
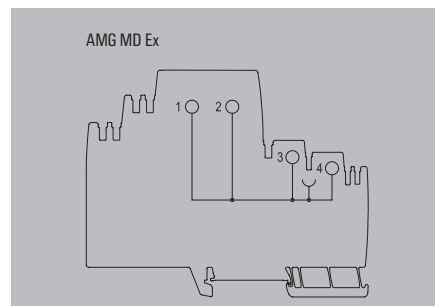
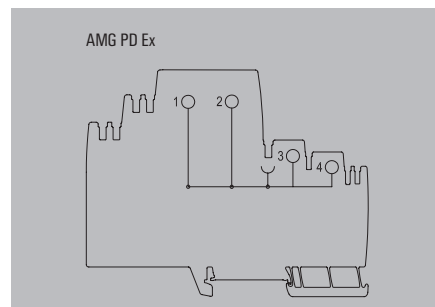
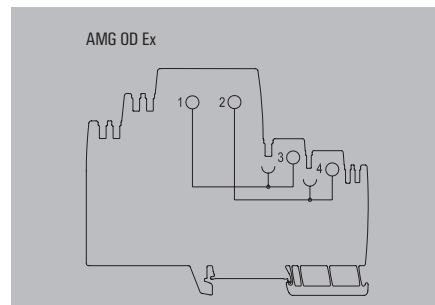

maxGUARD – accessories

Cross-connector orange



Type	Qty.	Order No.
ZQV 4N/2	60	1527930000
ZQV 4N/3	60	1527940000
ZQV 4N/4	60	1527970000
ZQV 4N/5	60	1527980000
ZQV 4N/6	20	1527990000
ZQV 4N/7	20	1528020000
ZQV 4N/8	20	1528030000
ZQV 4N/9	20	1528070000
ZQV 4N/10	20	1528090000
ZQV 4N/50	5	1528130000

Cross-connector blue



Type	Qty.	Order No.
ZQV 4N/2 BL	60	1528040000
ZQV 4N/3 BL	60	1528080000
ZQV 4N/4 BL	60	1528120000
ZQV 4N/5 BL	60	1528140000
ZQV 4N/6 BL	20	1528170000
ZQV 4N/7 BL	20	1528180000
ZQV 4N/8 BL	20	1528190000
ZQV 4N/9 BL	20	1528220000
ZQV 4N/10 BL	20	1528230000
ZQV 4N/50 BL	5	1528240000

Cross-connector red



Type	Qty.	Order No.
ZQV 4N/2 RD	60	2460450000
ZQV 4N/3 RD	60	2460810000
ZQV 4N/4 RD	60	2460800000
ZQV 4N/5 RD	60	2460790000
ZQV 4N/6 RD	20	2460780000
ZQV 4N/7 RD	20	2460770000
ZQV 4N/8 RD	20	2460760000
ZQV 4N/9 RD	20	2460750000
ZQV 4N/10 RD	20	2460740000
ZQV 4N/50 RD	5	2460730000

maxGUARD – accessories

End brackets

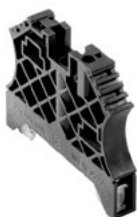

Type	Qty.	Order No.
WEW 35/2 SW	50	1061210000
WEW 35/2 V0 GF SW	100	1479000000

Cutting tool for ZQV



Type	Qty.	Order No.
KT 14	1	1157820000

Endplate and separation plate



Type	Qty.	Order No.
AMG PP	40	2123000000
AMG EP 2010	30	2495380000
AMG EP KIT	1	2500760000

Uninterruptible power supplies

Uninterruptible power supplies	Overview	C.2
	UPS control unit	C.4
	connectPower Battery modules	C.8
	connectPower Buffer modules	C.12

Uninterruptible Power Supply DC UPS

Safe energy in automation

In automation, a high-availability 24 V power supply avoids costly machine downtimes machine downtimes caused by mains interruptions.

For short-term interruptions in the range of several 100 ms, it is recommended to use a maintenance-free buffer module with an application-dependent service life of up to ten years.

Longer mains failures are bridged by our uninterruptible power supply unit in conjunction with a battery module. Depending on requirements, these modules supply energy up to 40 A for 30 minutes or 1 A for 30 hours. Battery life is guaranteed by the temperature-compensated charging characteristic.

Weidmüller's uninterruptible power supplies reliably protect 24 V DC consumers from power failures and voltage drops, such as those caused by mains faults, which can affect system availability.

Together with the associated battery module and the power supply unit, the UPS control unit forms a complete DC UPS system with backup times in the range of minutes to hours. The total load is divided into non-safe and safe loads.

Various operating modes are available for precise use. A remote control input for blocking the battery operation as well as numerous signal outputs allow the remote controllability of the UPS.

Your special advantages:

- A wide range of status relays for condition monitoring
- Direct switchover to battery operation in the event of a fault
- Automatic switch back to load when power is restored
- Long battery life due to integrated deep discharge protection
- Optimized charging characteristic

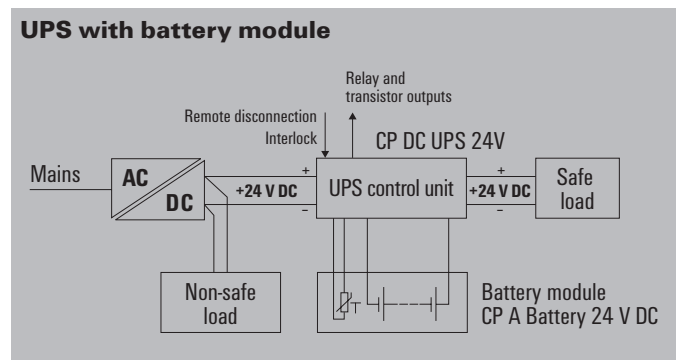

Fast error analysis

The charge status display as well as the status and error display enable fast error analysis

Flexible use

Different operating modes enable optimal utilization of the battery energy and thus flexible use



Worldwide use

International approvals (cURus, cULus) as well as TÜV certification enable worldwide use in various applications



UPS control unit

UPS control unit

- Two 24 V models in 10 A/20 A and 40 A
- Temperature-compensated charging feature for long battery life
- Integrated battery diagnostics including continuous availability test
- Status relay and additional transistor outputs for remote monitoring
- Convenient LED displays for easy error analysis



Technical data

Signalling	
Status relay (max. load)	Fault (alarm) (30 V AC/DC 0.1 A), Battery operation (buff.) (30 V AC/DC 0.1 A), Laden (Charg.) (30V AC/DC 0,1A)
Transistor outputs (24...27 V DC max. load 150 mA)	Battery operation (buff.), Charging, Fault (alarm)
Status indicator	Green/yellow LED: normal / buffering, Yellow/red LED: temperature alarm / alarm, Yellow/red LED: switch-off / battery fault
General data	
Ambient temperature (operational)	-25 °C...70 °C
Storage temperature	-40 °C...85 °C
Humidity	5...95 %, no condensation
Protection degree	IP20
Protection class	III, with no ground connection, for SELV
Pollution degree	2
Overvoltage category	III
Insulation voltage	1 kV DC
Protection against reverse voltages from the load	32...34 V DC
Parallel connection option	Yes, max. 2, Yes, with diode module
Housing version	Metal, corrosion resistant
Mounting position, installation notice	Horizontal on TS35 mounting rail. 50 mm of clearance at top & bottom for air circ. Can mount side by side with no space in between.
Overload protection	Yes
Short-circuit protection	Yes
EMC / shock / vibration	
Noise emission in accordance with EN55032	Class B
Interference immunity test acc. to	EN 61000-4-2 (ESD) EN 61000-4-3 and EN 61000-4-8 (fields) EN 61000-4-4 (burst) EN 61000-4-5 (surge) EN 61000-4-6 (conducted) EN 61000-4-11 (dips)
Resistance to vibration / Shock	2.3 g / 30 g in all directions
Electrical safety (applied standards)	
Electrical machine equipment	Acc. to EN60204
Safety transformers for switch-mode power supplies	According to EN 61558-2-16
For use with electronic equipment	Acc. to EN50178 / VDE0160

Blockschaltbild

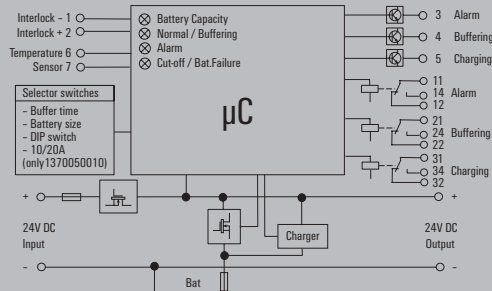

Verdrahtung

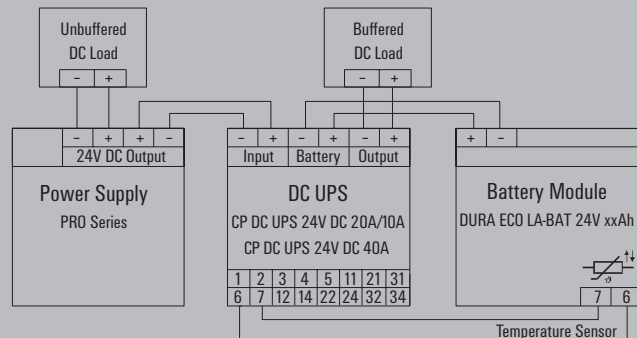

UPS control unit

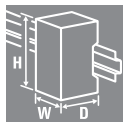

Technical data

Input	
Rated input voltage	24 V DC
DC input voltage range	20...30 V DC
Input current	≤ 13A (for 10A), ≤ 23A (for 20A)
Input fuse (internal)	Yes
DC current consumption	max. 200 mA (without battery), max. 0.5 A (with fully charged battery)
Reverse polarity protection	Yes
Output	
Rated output voltage	24 V DC ± 1 %
Output voltage	Vo = Vin - 0.2 V normal operation (Imax), Vo = Vin - 0.3 V battery supply (I max)
Nominal output current for U _{nom}	20 A @ 60 °C
Integrated battery charger	
Charging feature	IU characteristic curve
Charging voltage (temperature compensated)	27, 48 V @ 20°C
Temperature coefficient	- 48 mV / °C
Charging current	0.15 CA
Battery availability test	every minute
Battery module	
Rated voltage	24 V
Storage medium	1.3 Ah, 3.4 Ah, 7.2 Ah, 12 Ah, 17 Ah, Selectable with rotary switch
Parallel connection option	Yes, max. 2
Operating elements and control inputs	
Output current selector switch	20 A, 10 A
Selector switch battery	1.3 Ah, 3.4 Ah, 7.2 Ah, 12 Ah, 17 Ah, No Battery, Service
Selector switch buffer times	0.5 min, 1 min, 3 min, 5 min, 10 min, 20 min, 30 min, 45 min, ∞, ∞ w/D
Function DIP switch	Inversion of transistor outputs, Operation without temperature probe
Remote disconnection (Interlock)	Yes
Temperature probe	NTC 100 kΩ
General data	
Buffer times	Depending on the connected battery
Degree of efficiency	≥ 96% normal mode, battery is being charged, ≥ 98% normal mode, battery is charged, ≥ 98% buffer mode
Power loss	< 10 W
Depth x width x height / Net weight	150 / 66 / 130 mm / 1139 g
Approvals	
Approvals	BURVER; CE; cULus; DETNORVER; EAC; TUEV

Connection data	
Wire connection method	Screw connection
Wire cross-section, rigid min/max	0.5 / 16 mm ²
Wire cross-section, flexible min/max	0.5 / 16 mm ²
Wire cross-section, AWG/kcmil min/max	26 / 6
Tightening torque	1.2...1.5 Nm
Note	

Ordering data

Type	Qty.	Order No.
CP DC UPS 24V 20A/10A	1	1370050010
Note		

CP DC UPS 24V 20A/10A



Input	
Rated input voltage	24 V DC
DC input voltage range	20...30 V DC
Input current	≤ 13A (for 10A), ≤ 23A (for 20A)
Input fuse (internal)	Yes
DC current consumption	max. 200 mA (without battery), max. 0.5 A (with fully charged battery)
Reverse polarity protection	Yes
Output	
Rated output voltage	24 V DC ± 1 %
Output voltage	Vo = Vin - 0.2 V normal operation (Imax), Vo = Vin - 0.3 V battery supply (I max)
Nominal output current for U _{nom}	20 A @ 60 °C
Integrated battery charger	
Charging feature	IU characteristic curve
Charging voltage (temperature compensated)	27, 48 V @ 20°C
Temperature coefficient	- 48 mV / °C
Charging current	0.15 CA
Battery availability test	every minute
Battery module	
Rated voltage	24 V
Storage medium	1.3 Ah, 3.4 Ah, 7.2 Ah, 12 Ah, 17 Ah, Selectable with rotary switch
Parallel connection option	Yes, max. 2
Operating elements and control inputs	
Output current selector switch	20 A, 10 A
Selector switch battery	1.3 Ah, 3.4 Ah, 7.2 Ah, 12 Ah, 17 Ah, No Battery, Service
Selector switch buffer times	0.5 min, 1 min, 3 min, 5 min, 10 min, 20 min, 30 min, 45 min, ∞, ∞ w/D
Function DIP switch	Inversion of transistor outputs, Operation without temperature probe
Remote disconnection (Interlock)	Yes
Temperature probe	NTC 100 kΩ
General data	
Buffer times	Depending on the connected battery
Degree of efficiency	≥ 96% normal mode, battery is being charged, ≥ 98% normal mode, battery is charged, ≥ 98% buffer mode
Power loss	< 10 W
Depth x width x height / Net weight	150 / 66 / 130 mm / 1139 g
Approvals	
Approvals	BURVER; CE; cULus; DETNORVER; EAC; TUEV

Input/output/battery		Signal	
Screw connection		Screw connection	
0.5 / 16	0.2 / 1.5	0.5 / 16	0.2 / 1.5
0.5 / 16	0.2 / 1.5	26 / 6	30 / 15
26 / 6	30 / 15	1.2...1.5	
1.2...1.5			

Type	Qty.	Order No.
CP DC UPS 24V 20A/10A	1	1370050010
Note		

CP DC UPS 24V 40A



Input	
Rated input voltage	24 V DC
DC input voltage range	20...30 V DC
Input current	≤ 43 A
Input fuse (internal)	Yes
DC current consumption	max. 200 mA (without battery), max. 0.5 A (with fully charged battery)
Reverse polarity protection	Yes
Output	
Rated output voltage	24 V DC ± 1 %
Output voltage	Vo = Vin - 0.2 V normal operation (Imax), Vo = Vin - 0.3 V battery supply (I max)
Nominal output current for U _{nom}	40 A @ 60 °C
Integrated battery charger	
Charging feature	IU characteristic curve
Charging voltage (temperature compensated)	27, 48 V @ 20°C
Temperature coefficient	- 48 mV / °C
Charging current	0.15 CA
Battery availability test	every minute
Battery module	
Rated voltage	24 V
Storage medium	3.4 Ah, 7.2 Ah, 12 Ah, 17 Ah, Selectable with rotary switch
Parallel connection option	Yes, max. 2
Operating elements and control inputs	
Output current selector switch	3.4 Ah, 7.2 Ah, 12 Ah, 17 Ah, No Battery, Service
Selector switch battery	3.4 Ah, 7.2 Ah, 12 Ah, 17 Ah, No Battery, Service
Selector switch buffer times	0.5 min, 1 min, 3 min, 5 min, 10 min, 20 min, 30 min, 45 min, ∞, ∞ w/D
Function DIP switch	Inversion of transistor outputs, Operation without temperature probe
Remote disconnection (Interlock)	Yes
Temperature probe	NTC 100 kΩ
General data	
Buffer times	Depending on the connected battery
Degree of efficiency	≥ 96% normal mode, battery is being charged, ≥ 98% normal mode, battery is charged, ≥ 98% buffer mode
Power loss	< 10 W
Depth x width x height / Net weight	150 / 66 / 130 mm / 1051.8 g
Approvals	
Approvals	BURVER; CE; cULus; DETNORVER; EAC; TUEV

Input/output/battery		Signal	
Screw connection		Screw connection	
0.5 / 16	0.2 / 1.5	0.5 / 16	0.2 / 1.5
0.5 / 16	0.2 / 1.5	26 / 6	30 / 15
26 / 6	30 / 15	1.2...1.5	
1.2...1.5			

Type	Qty.	Order No.
CP DC UPS 24V 40A	1	1370040010
Note		

Small metal foot



Type	Order No.
MTA 30 MF	1251320000

Large metal foot



Type	Order No.
MTA 45 MF	1251310000

Small plastic foot



Type	Order No.
MTA 30 BK	1168970000

Large plastic foot



Type	Order No.
MTA 45 BK	1962250000

Small wall mounting



Type	Order No.
CP A WALLADAPTER 30 MM	1461870000

Large wall mounting



Type	Order No.
CP A WALLADAPTER 45 MM	1461850000

Temperature probe



Type	Kabellänge	Order No.
CP DC UPS TF25	2.5 m	1444540000
CP DC UPS TF05	0.5 m	1444480000

Small screwdriver

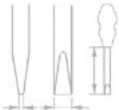

Type	Size/AF	a	b	c	Order No.
SDIS 0.5X3.0X100		0.5	3	100	2749800000

Large screwdriver

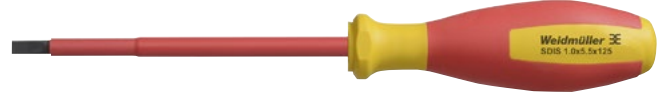

Type	Size/AF	a	b	c	Order No.
SDIS 1.0X5.5X125		1	5.5	125	2749850000

Markers

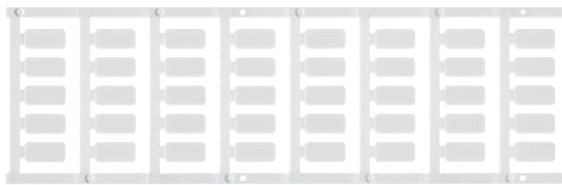

Type	Colour	Qty.	Order No.
SM 18/9.5 K MC NE WS	white	200	1248580000

End bracket

For DIN rail TS 35

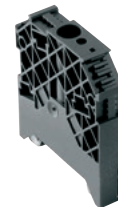

Type	Colour	Torque	Qty.	Order No.
Polyamide with fibre glass, screwable WEW 35/1 SW	black	1.2 Nm	50	1162600000

Flexible and easy to use uninterruptible power supplies

Bridge network failures of up to 30 hours with our DC-UPS systems

If sensitive process have to run reliably in a 24/7 operation, then the automation components need an everlasting supply. Using our uninterruptible power supply units in conjunction with the suitable battery modules ensure a reliable operation even in case of network failures.

The 5 battery modules with capacities from 1,2 Ah to 17Ah can supply up to 40 A for 30 minutes or 1 A for 30 hours and are fully compatible with the DC UPS control units CP DC UPS 24V 20A/10A & CP DC UPS 24V 40A.

And for sure, the DURAEco series is a flexible & ease of use solution in a cost-effective design.

Your benefits

- Sealed and maintenance-free VRLA batteries with 4,1 ... 7 years design lifetime
- Trouble-free exchange of existing batteries in running machineries due to the same footprint & drilling dimensions in comparison to the previous models
- Fully compatible with the control units CP DC UPS 24V 20A/10A & CP DC UPS 24V 40A
- Economical design



Integrated temperature measurement
Integrated temperature sensor for optimum charging and a long service life

Quick and easy mounting
DIN rail and 4-hole mounting for fast installation



Universally applicable
Comprehensive approval and test marks for use in the international field and in many industries

connectPower Battery modules

Battery modules

- Maintenance-free lead-acid batteries from 1.2 Ah to 17 Ah
- Integrated temperature sensor for optimal battery charging
- Capacity up to 40 A / 30 min or 1 A / 30 hrs
- Robust metal housing for wall mounting

DURA ECO LA-BAT 24V 1.2AH



DURA ECO LA-BAT 24V 3.4AH

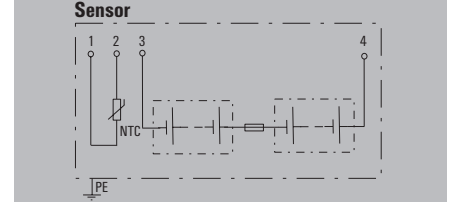
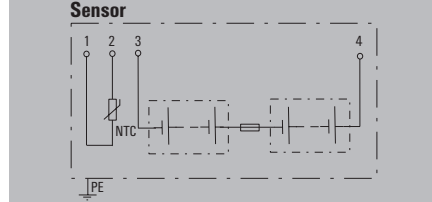
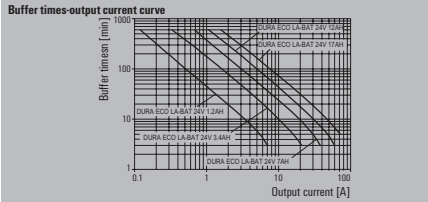

Technical data

Rated input voltage	24 V DC
Nominal capacity	1.3 Ah
Charging current, max.	0.2 A
Overload and short circuit protection	10 A fuse
Buffer time 10A	7.2 min
Buffer time 20A	
Output current, max.	15 A
Parallel connection option	Yes
Series switching capability	No
Temperature probe	NTC 100 kΩ
General data	
Battery type	VRLA Lead-Acid
Life expectancy	5.650000
Ambient temperature	Charge: -15...+50°C, Discharge: -20...+60°C
Storage temperature	-20 °C...60 °C
Latest commissioning	9 months
Humidity	5...95 % RH
Protection class	III, with no ground connection, for SELV
Protection degree	IP20
Vibration DIN rail/wall in accordance with IEC 68-2-6	0.7 / 0.7 g
Shock wall acc. to IEC 68227	30 g
Depth x width x height / Net weight	124 / 52 / 149.5 mm / 1750 g
Approvals	
Approvals	ABS; BURVER; cULus; DETNORVER; TUEV

Rated input voltage	24 V DC
Nominal capacity	3.4 Ah
Charging current, max.	0.51 A
Overload and short circuit protection	25 A fuse
Buffer time 10A	11.3 min
Buffer time 20A	5 min
Output current, max.	25 A
Parallel connection option	Yes
Series switching capability	No
Temperature probe	NTC 100 kΩ
General data	
Battery type	VRLA Lead-Acid
Life expectancy	5.650000
Ambient temperature	Charge: -15...+50°C, Discharge: -20...+60°C
Storage temperature	-20 °C...60 °C
Latest commissioning	9 months
Humidity	5...95 % RH
Protection class	III, with no ground connection, for SELV
Protection degree	IP20
Vibration DIN rail/wall in accordance with IEC 68-2-6	0.7 / 0.7 g
Shock wall acc. to IEC 68227	30 g
Depth x width x height / Net weight	166 / 108 / 141 mm / 3900 g
Approvals	
Approvals	ABS; BURVER; cULus; DETNORVER; TUEV

Rated input voltage	24 V DC
Nominal capacity	3.4 Ah
Charging current, max.	0.51 A
Overload and short circuit protection	25 A fuse
Buffer time 10A	11.3 min
Buffer time 20A	5 min
Output current, max.	25 A
Parallel connection option	Yes
Series switching capability	No
Temperature probe	NTC 100 kΩ
General data	
Battery type	VRLA Lead-Acid
Life expectancy	5.650000
Ambient temperature	Charge: -15...+50°C, Discharge: -20...+60°C
Storage temperature	-20 °C...60 °C
Latest commissioning	9 months
Humidity	5...95 % RH
Protection class	III, with no ground connection, for SELV
Protection degree	IP20
Vibration DIN rail/wall in accordance with IEC 68-2-6	0.7 / 0.7 g
Shock wall acc. to IEC 68227	30 g
Depth x width x height / Net weight	166 / 108 / 141 mm / 3900 g
Approvals	
Approvals	ABS; BURVER; cULus; DETNORVER; TUEV

Connection data	
Wire connection method	
Wire cross-section, rigid min/max	mm ²
Wire cross-section, flexible min/max	mm ²
Wire cross-section, AWG/kcmil min/max	

Input/output/battery	Signal
	Pluggable screw connection
0.2 / 4	0.2 / 4
0.2 / 4	0.2 / 4
24 / 12	24 / 12

Input/output/battery	Signal
	Pluggable screw connection
0.5 / 16	0.2 / 1.5
0.5 / 10	0.2 / 1.5
24 / 6	24 / 16

Note

Note

Note

Ordering data

Type	Qty.	Order No.
DURA ECO LA-BAT 24V 1.2AH	1	2789890000

Type	Qty.	Order No.
DURA ECO LA-BAT 24V 1.2AH	1	2789890000

Type	Qty.	Order No.
DURA ECO LA-BAT 24V 3.4AH	1	2789900000

Note

Note

Note

DURA ECO LA-BAT 24V 7AH



DURA ECO LA-BAT 24V 12AH



DURA ECO LA-BAT 24V 17AH

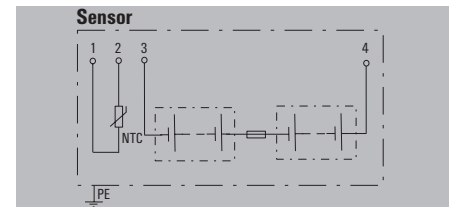
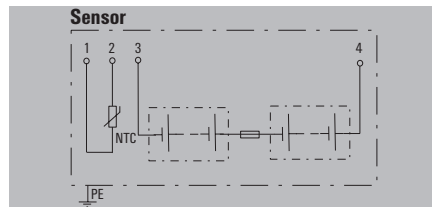
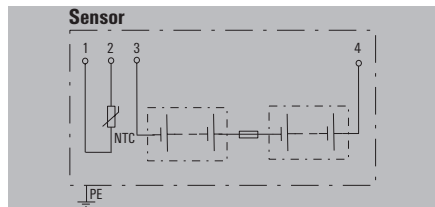

24 V DC
7 Ah
1.08 A
2x25 A fuse
26.5 min
11.5 min
50 A
Yes
No
NTC 100 kΩ
VRLA Lead-Acid
5.650000
Charge: -15...+50°C, Discharge: -20...+60°C
-20 °C...60 °C
9 months
5...95 % RH
III, with no ground connection, for SELV
IP20
- / 0.7 g
30 g
135 / 162 / 158 mm / 6120 g
ABS; BURVER; cULus; DETNORVER; TUEV

24 V DC
12 Ah
1.8 A
2x25 A fuse
51 min
22.7 min
50 A
Yes
No
NTC 100 kΩ
VRLA Lead-Acid
5.650000
Charge: -15...+50°C, Discharge: -20...+60°C
-20 °C...60 °C
9 months
5...95 % RH
III, with no ground connection, for SELV
IP20
- / 0.7 g
30 g
135 / 229 / 158 mm / 9700 g
ABS; BURVER; cULus; DETNORVER; TUEV

24 V DC
17 Ah
2 A
2x25 A fuse
81 min
34.2 min
50 A
Yes
No
NTC 100 kΩ
VRLA Lead-Acid
5.650000
Charge: -15...+50°C, Discharge: -20...+60°C
-20 °C...60 °C
9 months
5...95 % RH
III, with no ground connection, for SELV
IP20
- / 0.7 g
30 g
189 / 242 / 178 mm / 14300 g
ABS; BURVER; cULus; DETNORVER; TUEV

Input/output/battery	Signal
	Pluggable screw connection
0.5 / 16	0.2 / 1.5
0.5 / 10	0.2 / 1.5
24 / 6	24 / 16

Input/output/battery	Signal
	Pluggable screw connection
0.5 / 16	0.2 / 1.5
0.5 / 10	0.2 / 1.5
24 / 6	24 / 16

Input/output/battery	Signal
	Pluggable screw connection
0.5 / 16	0.2 / 1.5
0.5 / 10	0.2 / 1.5
24 / 6	24 / 16

Type	Qty.	Order No.
DURA ECO LA-BAT 24V 7AH	1	2789910000

Type	Qty.	Order No.
DURA ECO LA-BAT 24V 12AH	1	2789920000

Type	Qty.	Order No.
DURA ECO LA-BAT 24V 17AH	1	2789930000

Operate automation applications with maximum reliability maxSHIELD DC buffer modules for the uninterrupted 24 V systems

Voltage interruptions of several 100 ms in automation applications can lead to cost-intensive machine and system downtimes. These can be avoided with an uninterruptible 24 V power supply.

Weidmüller's maintenance-free maxSHIELD DC buffer modules guarantee an uninterruptible power supply and are therefore an important basis for 24 V systems. They supply the required voltage to the electronic load to bridge outages. The maintenance-free electrolytic capacitors enable continuous operation at ambient temperatures of up to +70°C. Optionally, a parallel connection is possible to bridge longer failures or to increase the output power.

C

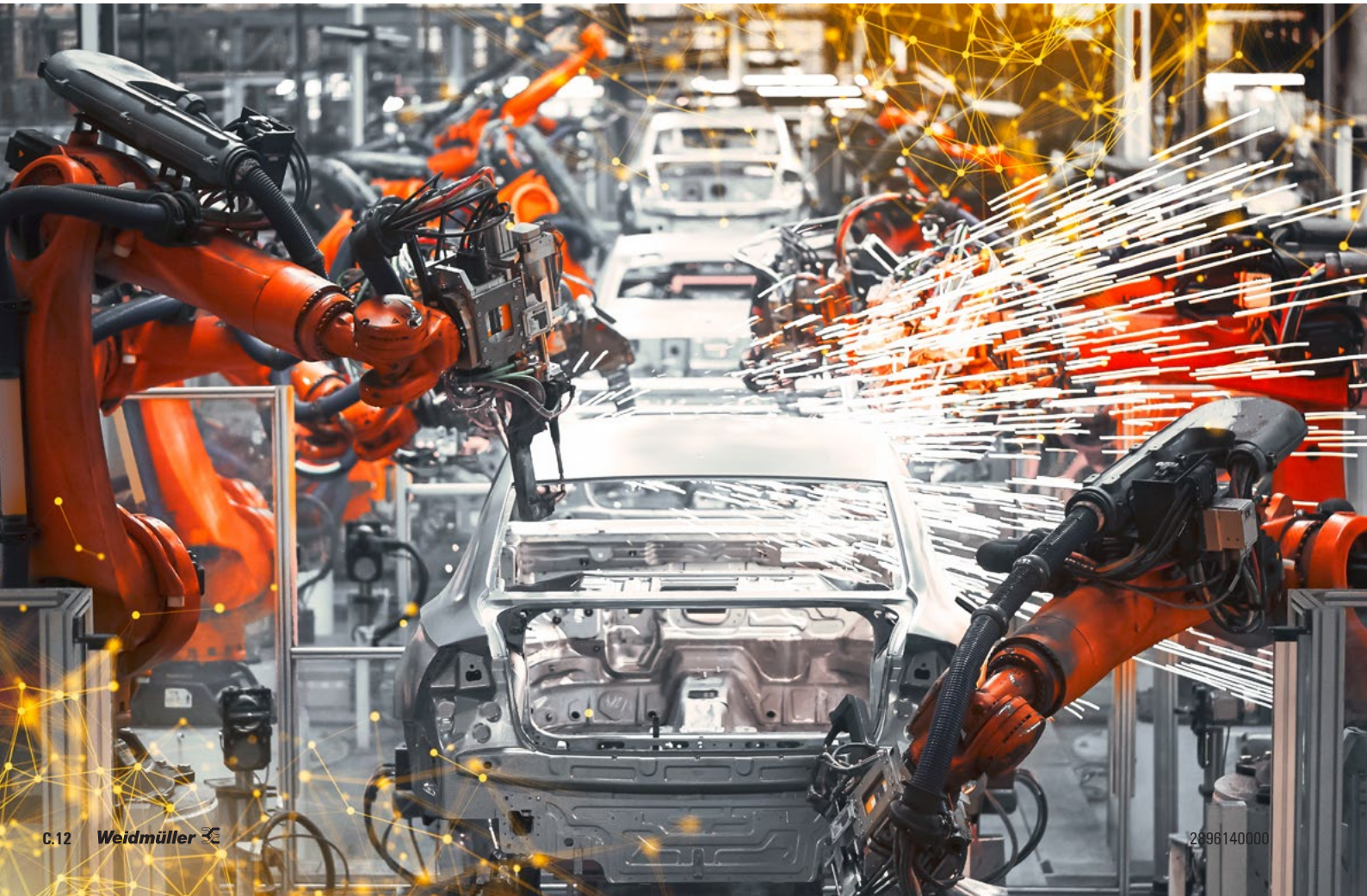

Simple and flexible combination

The DC buffer modules provide flexible limit selection between 22.5V DC and VIN-1 V. They can also be operated in parallel to increase bridging time or output power.

Space-saving and maintenance-free

Due to the compact design, with only 55 or 65 mm width, the DC buffer module can be placed directly next to power supplies in the control cabinet.

**Universally applicable**

International approvals such as cULus, ATEX, and IECex as well as a wide operating temperature range enable use in a wide variety of applications worldwide.

connectPower Buffer modules

Buffer modules

- Buffer time: 320ms @ 20 A or 230 ms @ 40 A
- Extensive approvals and wide temperature range
- Status display by LEDs and signal connections
- Space-saving and maintenance-free
- Parallel switchable

PRO DC BUFFER 24V 20A

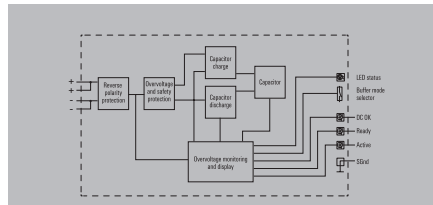
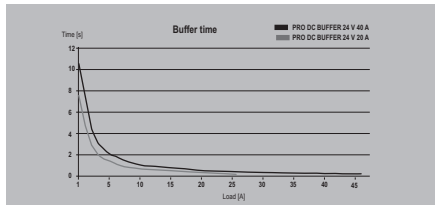

PRO DC BUFFER 24V 40A

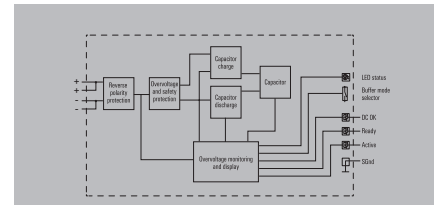

Technical data

Input	
Rated input voltage	24 V DC
Input current	0...21 A
DC current consumption	<0.2 A @ no load, <1 A @ charging process for typ. 10s
DC input voltage range	22.5 - 30 V DC
Output	
Mains failure bridge-over time, min.	200mS
Output voltage	22.2 ± 0.4 V DC / Vin-1 V(± 0.4 V)
Output voltage	Corresponds to the input voltage
Output current at 40 °C	25 A
Rated current	20 A
Parallel connection option	Yes
Overload and short circuit protection	Yes
Surge protection	33 V...35 V
Display	
Status indicator	Green LED
MTBF	
According to Standard	SN 29500
Operating time (hours), min.	2.5Mh
Ambient temperature	25°C
Input voltage	24V DC
Output power	480W
Duty cycle	100%
Mains failure bridge-over time	
Mains failure bridge-over time, min.	200mS
Output current	20A
Output voltage	22.2V
General data	
Degree of efficiency	≥ 98% buffer mode
Storage medium	Internal condenser
Ambient temperature (operational)	-25 °C...70 °C
Humidity	5...95 %, no condensation
Depth x width x height / Net weight	130 / 55 / 125 mm / 1043 g
Approvals	
Approvals	CE; CSAEX; cULus; TUEV
Connection data	
Connection system	Screw connection
Number of terminals	4 (++) / (-)
Wire cross-section, rigid min/max	0.18 / 6 mm ²
Wire cross-section, flexible min/max	0.22 / 4 mm ²
Wire cross-section, AWG/kcmil min/max	26 / 10
Tightening torque range	0.5 / 0.6 Nm
Note	

Input / Output	
Screw connection	PUSH IN
4 (++) / (-)	4
0.18 / 6	0.2 / 1.5
0.22 / 4	0.2 / 1.5
26 / 10	28 / 14
0.5 / 0.6	
Signal	
LED status	
Buffer mode indicator	
DC OK	
Ready	
Active	
Standby	

Input / Output	
Screw connection	PUSH IN
4 (++) / (-)	4
0.5 / 16	0.2 / 1.5
0.5 / 16	0.2 / 1.5
22 / 8	28 / 14
0.5 / 0.6	
Signal	
LED status	
Buffer mode indicator	
DC OK	
Ready	
Active	
Standby	

Ordering data

Type	Qty.	Order No.
PRO DC BUFFER 24V 20A	1	2786240000

Type	Qty.	Order No.
PRO DC BUFFER 24V 20A	1	2786240000

Type	Qty.	Order No.
PRO DC BUFFER 24V 40A	1	2786250000

Note

DC/DC converters

DC/DC converters	Overview	D.2
	connectPower DC/DC converter	D.4

Stabilise control voltages in 24 V DC systems

Compact and powerful DC/DC converters for an everlasting supply

Maximum supply reliability and minimum downtimes indicate a good power supply system. However, the increasing complexity of supply solutions and the increased use of battery back-up systems can have a negative impact on the stability of the DC control voltage. Supply disruptions, e. g. voltage fluctuations as a result of different potentials or voltage drops as a result of long cables may occur as a result. These issues can often lead to cost-intensive production disruptions.

The DC/DC converter balances out voltage fluctuations, such as those arising as a result of unregulated voltage supplies. Voltage drops at the end of long cables are also balanced out. With protection class III for floating systems and galvanic isolation, the DC/DC converters are particularly well-suited for use with independent supply systems.

As well as having above-average performance characteristics, the DC/DC converter also stands out thanks to its slim design, ease of servicing and high degree of efficiency of up to 94 %. It also has a wide range of safety functions and can be combined with PROtop, PROeco or PROmax power supplies. It is also possible to combine UPS components, diode and redundancy modules with the DC/DC converter in order to establish a redundant power supply. All of these features make the DC converter a real all-rounder when it comes to 24 V DC supply voltages.

Your special advantages:

- Reliable and powerful
- The long-lasting Power Boost of up to 120 % and high peak currents of up to 600 % of the rated current for 16 ms guarantee reliable starting and safe operation even within limit ranges.



In floating voltage systems, e. g. with emergency power battery systems in marine engineering, the control voltage needs to be galvanically isolated from the battery voltage

Extremely compact and energy-efficient

The compact design saves up to 30 % space in the control cabinet. The high degree of efficiency of up to 93 % ensures low energy costs.

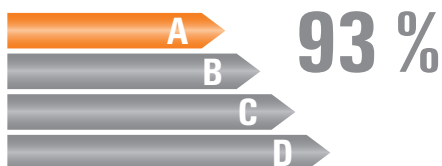

Quick status diagnostics and maintenance

The preventative function monitoring via LED display, the status relay and transistor outputs make it easier to carry out status and error analyses during commissioning and operation.



Robust and reliable

Weidmüller DC/DC converters function reliably over a large temperature range of between -25 °C and +70 °C (start-up: -40 °C), and with a high MTBF value of over 1,000,000 hours.

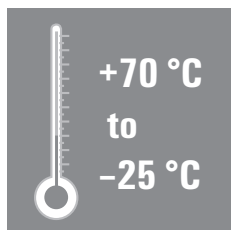

All-purpose usage

Variants with 5 A, 10 A and 20 A and international approvals (e. g. cULus, Class I, Div. 2, ATEX, GL, DNV) allow for global use in a range of different applications.



ConnectPower DC/DC converter



Derating curve

Event	LED (Gr/Ye/Rd)	LED (Ye)	Transistor status outputs			Status relay
			DC OK	$i > 90\% I_N$	$low u_N$	
$U_N < 14 V$	OFF	ON	Low	Low	Low	OFF
$U_N = 14...19.2 V$ *)	$i < 90\% I_N$	Gr	ON	High	Low	ON
	$i > 90\% I_N$	Ye	ON	High	High	ON
$U_N > 19.2 V$	$U < 20.4 V$	Rd	ON	Low	Low	OFF
	$U > 20.4 V$	Rd	OFF	High	Low	High
$U_N > 19.2 V$	$i < 90\% I_N$	Gr	OFF	High	Low	High
	$i > 90\% I_N$	Ye	OFF	High	High	ON
$U_N > 19.2 V$	$U < 20.4 V$	Rd	OFF	Low	Low	High
	$U > 20.4 V$	Rd	OFF	Low	High	OFF

Gr = grün / green / verde / verde / verde / verde / 绿色
 Ye = gelb / yellow / jaune / giallo / amarillo / amarillo / 黄色
 Rd = rot / red / rouge / rosso / rojo / vermelho / 红色
 *) während des Betriebes / during operations / en cours de fonctionnement / durante l'esercizio / durante el servicio / durante a operação / 运行过程中

Technical data

General data	
Current limiting	150% I_{out}
Insulation voltage input / earth	1.5 kV
Insulation voltage output / earth	0.5 kV
Insulation voltage, input/output	1.5 kV
Ambient temperature (operational) / Storage temperature / Start-up	-25 °C...70 °C / -40 °C...85 °C / ≥ -40 °C
Humidity at operating temperature	5...95 %, no condensation
Protection class / Pollution degree	III, with no ground connection, for SELV / 2
MTBF	1250000
Housing version	Metal, corrosion resistant
Mounting position, installation notice	Horizontal on TS35 mounting rail. 50 mm of clearance at top & bottom for air circ. Can mount side by side with no space in between., 50 mm clearance at top and bottom for free air circulation, mountable side by side without clearance
EMC / shock / vibration	
Interference immunity test acc. to	EN 61000-4-2 (ESD), EN 61000-4-4 (burst), EN 61000-4-5 (surge), EN 61000-4-6 (conducted), EN61000-4-3 (HF field)
Shock	30 g in all directions
Resistance to vibration	2.3 g (15 Hz...150 Hz)
Electrical safety (applied standards)	
Electrical machine equipment	Acc. to EN60204
Safety transformers for switch-mode power supplies	According to EN 61558-2-16
For use with electronic equipment	Acc. to EN50178 / VDE0160
Protective separation / protection against electrical shock	VDE0100-410 / acc. to DIN57100-410
Protection against dangerous shock currents	Acc. to VDE0106-101

Signal states

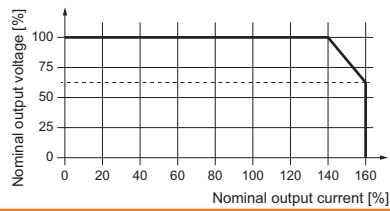
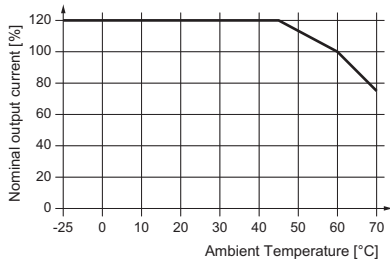

ConnectPower DC/DC converter

PRO DCDC 120W 24V 5A

PRO DCDC 240W 24V 10A

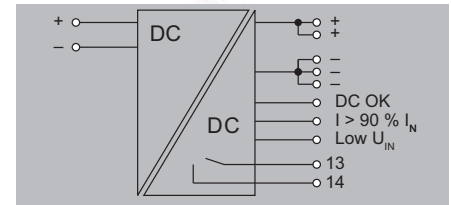
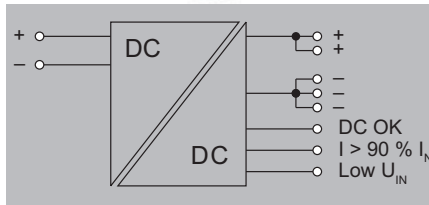

Technical data

Input	
Rated input voltage	24 V DC
DC input voltage range	14...32 V (during operation), 18...32 V (commissioning)
Input fuse (internal)	Yes
Inrush current / Inrush Current Limitation	Max. 10 A / Yes
Recommended back-up fuse	10 A, Char. B circuit breaker, 10 A, Char. C circuit breaker

Output	
Rated output voltage	24 V DC ± 1 %
Output voltage	22.5...29.5 V (adjustable via potentiometer on front)
Continuous output current @ U _{Nominal}	5 A @ 40 °C, 6 A @ 45°C, 3,75 A @ 70°C
Output power	120 W
Ramp-up time	≤ 9 ms (U _{out} : 10%...90%)
Capacitive load	unrestricted
Parallel connection option	yes, max. 5 (without diode module)
Reserve capacity @ U _{Nominal}	600% IN for 16 ms
Residual ripple, breaking spikes	max. 20 mVpp @ 24 VDC, IN
Protection against inverse voltage / Overload protection	Yes / Yes

General data	
AC failure bridging time @ I _{load}	> 10 ms @ 24 V DC
Protection against reverse voltages from the load	33...34 V DC
Start-up	≥ -40 °C
Current limiting	150% I _{load}
Power loss idling / nominal load	2 W / 11 W
Degree of efficiency	Typ.: 92 %

Signalling	
Transistor output, positive-switching	DC OK: 20 mA max., short-circuit-proof, I > 90%: 20 mA max., short-circuit-proof, Low U _{IN} : 20 mA max., short-circuit-proof

Floating contact	/
Relay on/off / Contact load	/

Approvals	
Approvals	ABS; BURVER; cULus; cULusEX; DETNORVER; LLOYDSREG; RINA; TUEV

Connection data	
Connection system	Screw connection
Number of terminals	2 for (+, -)
Wire cross-section, rigid min/max	0.2 / 4 mm ²
Wire cross-section, flexible min/max	0.2 / 4 mm ²
Wire cross-section, AWG/kcmil min/max	30 / 12
Tightening torque	0.4 / 0.5

Note	

Ordering data

Type	Qty.	Order No.
PRO DCDC 120W 24V 5A	1	2001800000

Note	

Input	
Rated input voltage	24 V DC
DC input voltage range	14...32 V (during operation), 18...32 V (commissioning)
Input fuse (internal)	Yes
Inrush current / Inrush Current Limitation	Max. 10 A / Yes
Recommended back-up fuse	10 A, Char. B circuit breaker, 10 A, Char. C circuit breaker

Output	
Rated output voltage	24 V DC ± 1 %
Output voltage	22.5...29.5 V (adjustable via potentiometer on front)
Continuous output current @ U _{Nominal}	5 A @ 40 °C, 6 A @ 45°C, 3,75 A @ 70°C
Output power	120 W
Ramp-up time	≤ 9 ms (U _{out} : 10%...90%)
Capacitive load	unrestricted
Parallel connection option	yes, max. 5 (without diode module)
Reserve capacity @ U _{Nominal}	600% IN for 16 ms
Residual ripple, breaking spikes	max. 20 mVpp @ 24 VDC, IN
Protection against inverse voltage / Overload protection	Yes / Yes

General data	
AC failure bridging time @ I _{load}	> 10 ms @ 24 V DC
Protection against reverse voltages from the load	33...34 V DC
Start-up	≥ -40 °C
Current limiting	150% I _{load}
Power loss idling / nominal load	2 W / 11 W
Degree of efficiency	Typ.: 92 %

Signalling	
Transistor output, positive-switching	DC OK: 20 mA max., short-circuit-proof, I > 90%: 20 mA max., short-circuit-proof, Low U _{IN} : 20 mA max., short-circuit-proof

Floating contact	/
Relay on/off / Contact load	/

Approvals	
Approvals	ABS; BURVER; cULus; cULusEX; DETNORVER; LLOYDSREG; RINA; TUEV

Connection data	
Connection system	Screw connection
Number of terminals	2 for (+, -)
Wire cross-section, rigid min/max	0.2 / 4 mm ²
Wire cross-section, flexible min/max	0.2 / 4 mm ²
Wire cross-section, AWG/kcmil min/max	30 / 12
Tightening torque	0.4 / 0.5

Note	

Ordering data

Type	Qty.	Order No.
PRO DCDC 120W 24V 5A	1	2001800000

Note	

Input	
Rated input voltage	24 V DC
DC input voltage range	14...32 V (during operation), 18...32 V (commissioning)
Input fuse (internal)	Yes
Inrush current / Inrush Current Limitation	max. 15 A / Yes
Recommended back-up fuse	25 A, Char.B circuit breaker, 25 A, Char.C circuit breaker

Output	
Rated output voltage	24 V DC ± 1 %
Output voltage	22.5...29.5 V (adjustable via potentiometer on front)
Continuous output current @ U _{Nominal}	10 A @ 40 °C, 12 A @ 45°C, 7,5 A @ 70°C
Output power	240 W
Ramp-up time	≤ 9 ms (U _{out} : 10%...90%)
Capacitive load	unrestricted
Parallel connection option	yes, max. 5 (without diode module)
Reserve capacity @ U _{Nominal}	600% IN for 16 ms
Residual ripple, breaking spikes	max. 20 mVpp @ 24 VDC, IN
Protection against inverse voltage / Overload protection	Yes / Yes

General data	
AC failure bridging time @ I _{load}	> 12 ms @ 24 V DC
Protection against reverse voltages from the load	33...34 V DC
Start-up	≥ -40 °C
Current limiting	150% I _{load}
Power loss idling / nominal load	2 W / 22 W
Degree of efficiency	Typ.: 92 %

Signalling	
Transistor output, positive-switching	DC OK: 20 mA max., short-circuit-proof, I > 90%: 20 mA max., short-circuit-proof, Low U _{IN} : 20 mA max., short-circuit-proof

Floating contact	Yes
Relay on/off / Contact load	Output voltage > 21.6 V / < 20.4 V / max. 30 V DC / 0.5 A

Approvals	
Approvals	ABS; BURVER; cULus; cULusEX; DETNORVER; LLOYDSREG; RINA; TUEV

Connection data	
Connection system	Screw connection
Number of terminals	2 for (+, -)
Wire cross-section, rigid min/max	0.08 / 4 mm ²
Wire cross-section, flexible min/max	0.08 / 4 mm ²
Wire cross-section, AWG/kcmil min/max	30 / 12
Tightening torque	0.4 / 0.5

Note	

Ordering data

Type	Qty.	Order No.
PRO DCDC 240W 24V 10A	1	2001810000

Note	

ConnectPower DC/DC converter

PRO DCDC 480W 24V 20A

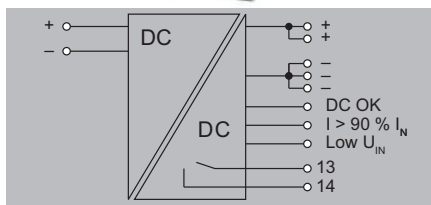

Technical data

Input
Rated input voltage
DC input voltage range
Input fuse (internal)
Inrush current / Inrush Current Limitation
Recommended back-up fuse

Output
Rated output voltage
Output voltage
Continuous output current @ $U_{Nominal}$
Output power
Ramp-up time
Capacitive load
Parallel connection option
Reserve capacity @ $U_{Nominal}$
Residual ripple, breaking spikes
Protection against inverse voltage / Overload protection

General data
AC failure bridging time @ I_{load}
Protection against reverse voltages from the load
Start-up
Current limiting
Power loss idling / nominal load
Degree of efficiency

Signalling
Transistor output, positive-switching

Floating contact
Relay on/off / Contact load

Approvals
Approvals

Connection data
Connection system
Number of terminals
Wire cross-section, rigid min/max mm²
Wire cross-section, flexible min/max mm²
Wire cross-section, AWG/kcmil min/max
Tightening torque

Note

Ordering data

--

Note

24 V DC
14...32 V (during operation), 18...32 V (commissioning)
Yes
max. 30 A / Yes
40 A, Char. B circuit breaker, 40 A, Char. C circuit breaker

24 V DC ± 1 %
22.5...29.5 V (adjustable via potentiometer on front)
20 A @ 60 °C, 24 A @ 45°C, 15 A @ 70°C
480 W
≤ 9 ms (U_{out} : 10%...90%)
unrestricted
yes, max. 3
600% IN for 16 ms
max. 20 mVpp @ 24 VDC, IN
Yes / Yes

> 10 ms @ 24 V DC
33...34 V DC
≥ -40 °C
150% I_{load}
3 W / 40 W
typ. > 93%

DC OK: 20 mA max., short-circuit-proof, I > 90%: 20 mA max., short-circuit-proof, Low U_{IN} : 20 mA max., short-circuit-proof
--

Yes
Output voltage > 21.6 V / < 20.4 V / max. 30 V DC / 0.5 A

ABS; BURVER; cULus; cULusEX; DETNORVER; LLOYDSREG; RINA; TUEV

Input	Output
Screw connection	Screw connection
2 for (+, -)	10 (+ / - / signal)
0.5 / 16	0.18 / 6
0.5 / 16	0.18 / 6
22 / 8	26 / 10
1.2 / 1.5	0.4 / 0.5

Type	Qty.	Order No.
PRO DCDC 480W 24V 20A	1	2001820000

--

Redundancy- and diode modules

Redundancy- and diode modules	Overview	E.2
	connectPower redundancy modules	E.4
	connectPower diode modules	E.6

Reliable protection of sensitive system components

Redundancy- and diode modules

In many automation applications, power supply systems are required that function reliably even if a power supply unit fails. With our optimally coordinated supplementary modules, a permanent supply concept is created. Weidmüller's diodes and redundancy modules connect two power supplies to each other in order to compensate for the failure of one device.

Diode modules

The diode modules allow with 20 A or 40 A output current to the construction of safe power supply systems.



Redundancy modules

Redundancy modules increase system availability is decisive. Each redundant branch is able to supply full output load. The 24-V control voltage remains stable in the event of a power supply failure. The use of MOSFETs in our redundancy modules allows for a optimum efficiency.

Redundancy module

- Up to 40 A per input
- Individually adjustable current warning for Overload directly at the device
- Suitable for EX areas

The space- and energy-saving system solution

- The compact design saves up to 30 % space in the switch cabinet
- The high degree of efficiency of up to 98 % ensures for low energy costs

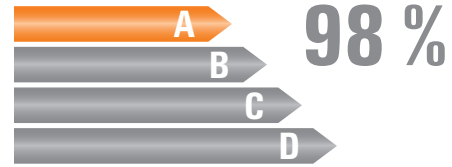

Diode module

- Ideal for setting up trouble-free systems
- In versions with 20 or 40 A output current obtainable
- Also suitable for small systems

connectPower redundancy modules

connectPower redundancy modules

PRO RM 10

PRO RM 20

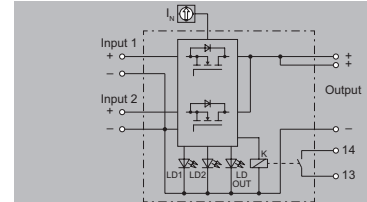
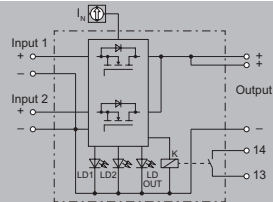

Technical data

Input	
DC input voltage range	
Input current	
Output	
Rated output voltage	
Continuous output current @ $U_{Nominal}$	
General data	
Ambient temperature (operational)	
Storage temperature	
Derating	
Degree of efficiency	
Mounting position, installation notice	
Depth x width x height / Net weight	
Approvals	

10 ... 32 V DC
2 × 12 A (-40 °C ~ +45 °C), 2 × 10 A (+45 °C ~ +60 °C), 2 × 7.5 A (+70 °C)
$V_{INPUT-typ. 0.13 V}$
1 × 24 A (-40 °C ~ +45 °C), 1 × 20 A (+45 °C ~ +60 °C), 1 × 15 A (+70 °C)
-40 °C...70 °C
-40 °C...85 °C
> 60°C / 75% @ 70°C
> 98%
Horizontal on TS35 mounting rail. 50 mm of clearance at top & bottom for air circ. Can mount side by side with no space in between.
125 / 30 / 130 mm / 497 g
cULus; DETNORVER; EAC; TUEV

10 ... 32 V DC
2 × 24 A (-40 °C ~ +45 °C), 2 × 20 A (+45 °C ~ +60 °C), 2 × 15 A (+70 °C)
$V_{INPUT-typ. 0.2 V}$
1 × 48 A (-40 °C ~ +45 °C), 1 × 40 A (+45 °C ~ +60 °C), 1 × 30 A (+70 °C)
-40 °C...70 °C
-40 °C...85 °C
> 60°C / 75% @ 70°C
> 98%
Horizontal on TS35 mounting rail. 50 mm of clearance at top & bottom for air circ. Can mount side by side with no space in between.
125 / 38 / 130 mm / 558 g
cULus; DETNORVER; EAC; TUEV

Connection data	
Connection system	
Number of terminals	
Wire cross-section, rigid min/max	mm ²
Wire cross-section, flexible min/max	mm ²
Wire cross-section, AWG/kcmil min/max	
Tightening torque range	
Note	

Input	Output
PUSH IN	PUSH IN
4 (+,+, -,-)	2 (+/-)
0.2 / 2.5	0.2 / 10
0.2 / 2.5	0.2 / 6
26 / 12	24 / 8
/	/

Input	Output
PUSH IN	PUSH IN
4 (+,+, -,-)	2 (+/-)
0.2 / 10	0.75 / 16
0.2 / 6	0.75 / 16
24 / 8	20 / 4
/	/

Ordering data

Screw connection	
Note	

Type	Qty.	Order No.
PRO RM 10	1	2486090000
Note		

Type	Qty.	Order No.
PRO RM 20	1	2486100000
Note		

connectPower redundancy modules

PRO RM 40

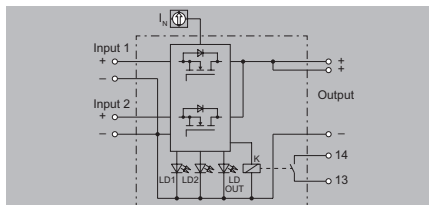

Technical data

Input	
DC input voltage range	10 ... 32 V DC
Input current	2 × 48 A (-40 °C ~ +45 °C), 2 × 40 A (+45 °C ~ +60 °C), 2 × 30 A (+70 °C)
Output	
Rated output voltage	V_{NOUT} -typ. 0.16 V
Continuous output current @ $U_{Nominale}$	1 × 96 A (-40 °C ~ +45 °C), 1 × 80 A (+45 °C ~ +60 °C), 1 × 60 A (+70 °C)
General data	
Ambient temperature (operational)	-40 °C...70 °C
Storage temperature	-40 °C...85 °C
Derating	> 60 °C / 75% @ 70 °C
Degree of efficiency	> 98%
Mounting position, installation notice	Horizontal on TS35 mounting rail. 50 mm of clearance at top & bottom for air circ. Can mount side by side with no space in between.
Depth x width x height / Net weight	125 / 52 / 130 mm /
Approvals	cULus; DETNORVER; EAC; TUEV

Connection data		Input	Output
Connection system		Pluggable screw connection	Screw connection
Number of terminals		4 (+,+, -,-)	2 (+ / -)
Wire cross-section, rigid min/max	mm ²	0.2 / 16	0.5 / 16
Wire cross-section, flexible min/max	mm ²	0.5 / 16	0.5 / 35
Wire cross-section, AWG/kcmil min/max		22 / 6	20 / 1
Tightening torque range		/	/4
Note			

Ordering data

Type	Qty.	Order No.
PRO RM 40	1	2486110000

Note

connectPower diode modules

connectPower diode modules

PRO DM 10

PRO DM 20

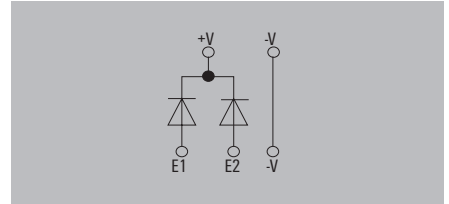
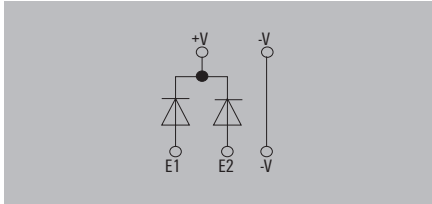
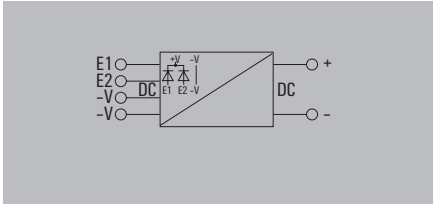

Technical data

Input
DC input voltage range
Input current
Output
Rated output voltage
Continuous output current @ $U_{Nominal}$
General data
Ambient temperature (operational)
Storage temperature
Derating
Degree of efficiency
Mounting position, installation notice
Depth x width x height / Net weight
Approvals

0...60 V DC
2 × 12 A (-40 °C ~ +45 °C), 2 × 10 A (+45 °C ~ +60 °C), 2 × 7.5 A (+70 °C)
$V_{INPUT-typ. 0.7 V}$
1 × 24 A (-40 °C ~ +45 °C), 1 × 20 A (+45 °C ~ +60 °C), 1 × 15 A (+70 °C)
-40 °C...70 °C
-40 °C...85 °C
> 60 °C / 75% load @ 70 °C
> 97% @ 24 V Input voltage
Horizontal on TS35 mounting rail. 50 mm of clearance at top & bottom for air circ. Can mount side by side with no space in between.
125 / 32 / 125 mm / 501 g
cULus; TUEV

0...60 V DC
2 × 24 A (-40 °C ~ +45 °C), 2 × 20 A (+45 °C ~ +60 °C), 2 × 15 A (+70 °C)
$V_{INPUT-typ. 0.7 V}$
1 × 48 A (-40 °C ~ +45 °C), 1 × 40 A (+45 °C ~ +60 °C), 1 × 30 A (+70 °C)
-40 °C...70 °C
-40 °C...85 °C
> 60 °C / 75% load @ 70 °C
> 97% @ 24 V Input voltage
Horizontal on TS35 mounting rail. 50 mm of clearance at top & bottom for air circ. Can mount side by side with no space in between.
125 / 32 / 125 mm / 552 g
cULus; TUEV

Connection data
Connection system
Number of terminals
Wire cross-section, rigid min/max mm²
Wire cross-section, flexible min/max mm²
Wire cross-section, AWG/kcmil min/max
Tightening torque range
Note

Input	Output
Screw connection	Screw connection
4 (1+, 2+, 1-, 2-)	4 (++, --)
0.18 / 6	0.18 / 6
0.22 / 4	0.22 / 6
26 / 10	26 / 10
/	0.5 / 0.6

Input	Output
Screw connection	Screw connection
4 (1+, 2+, 1-, 2-)	4 (++, --)
0.18 / 6	0.5 / 16
0.22 / 4	0.5 / 16
26 / 10	22 / 8
/	1.2 / 1.5

Ordering data

Screw connection
Note

Type	Qty.	Order No.
PRO DM 10	1	2486070000

Type	Qty.	Order No.
PRO DM 20	1	2486080000

Communication modules

Communication modules	Overview	F.2
	CANopen module	F.4
	IO-link module	F.5
	Display module	F.6

Exploiting the potential of industry 4.0

Communication modules for continuous networking of your components

The communication capability of machines, plant components and IT systems is a basic prerequisite for exploiting the potential of industry 4.0 and increasing the future security of plants.

Weidmüller's plug-in communication modules enable individual components to exchange relevant data with the cloud. This lays the foundation for targeted process optimization using condition monitoring and remote controllability - factors that play a decisive role in increasing efficiency, quality, process stability and availability can contribute.

The communication modules are designed according to IP20 protected, can be operated without tools and can be flexibly adapted to different customisable communication protocols.



PRO COM CANopen

PRO COM CANopen connects the device-internal interface of a Weidmüller basic unit (e.g. PROtop) with the CAN bus system of a plant control system. The CANopen fieldbus protocol is used for this purpose. The communication module is equipped with two RJ45-sockets (CAN 1-1 and 1-2) and is connected via the Basic unit supplied with power.

Range of functions:

- Read out device data and identification
- Read out process data and process alarms
- Reading event and status data
- Configuring the Base Device
- Specify operating modes and setpoints
- Display operating states



PRO COM IO-Link

PRO COM IO-Link connects the device-internal interface of a Weidmüller basic device (e.g. PROtop or topGUARD) to the communication system of a plant control system using the IO-Link communication protocol. The communication module has a three-pole connection socket for the communication cable and is supplied with power via IO-Link Master.

Range of functions:

- Read out device data and identification
- Read out process data and process alarms
- Reading event and status data
- Configuring the Base Device
- Specify operating modes and setpoints
- Display operating states

PRO COM Display

The display module enables service technicians to sporadically check output voltage and current without the aid of a multimeter. During initial commissioning, the output voltage can be conveniently adjusted using buttons, whereby the current voltage is displayed continuously. If the display module is permanently attached to the PROtop power supply, the remaining service life can easily be determined and displayed.

- Ideal for quick testing of output voltage and current by the service technician
- Tool-free voltage adjustment at the touch of a button with simultaneous voltage display
- Simple service life prediction with programmable pre-warning and signal output



CANopen module

PRO COM CANopen

PRO COM CAN OPEN



Technical data

System data

Connection type
Field bus protocol
Module type
Interface

2 x RJ45 plug-in connectors
CANopen
plug-on module
PROtop interconnection interface

General data

Ambient temperature (operational)
Protection degree
Weight
Depth x width x height

-25 °C...70 °C
IP20
36 g
33.6 / 35 / 74.4 mm

Approvals

Approvals

ABS; BURVER; cULus; DETNORVER; LLOYDSREG; RINA; RS

Note

Ordering data

Type	Qty.	Order No.
PRO COM CAN OPEN	1	2467320000

Note

PRO COM IO-LINK

PRO COM IO-LINK



Technical data

System data	
Connection type	IO-Link
IO link standard	IEC 61131-9
Compatible IO-Link Master	Beckhoff, GE, Rockwell, Siemens, Weidmüller
Module type	plug-on module
Interface	topGUARD interconnection interface, PROtop interconnection interface
General data	
Ambient temperature (operational)	-25 °C...70 °C
Protection degree	IP20
Weight	29 g
Depth x width x height	33.6 / 35 / 74.4 mm
Approvals	
Approvals	cULus

IO-Link		
IEC 61131-9		
Beckhoff, GE, Rockwell, Siemens, Weidmüller		
plug-on module		
topGUARD interconnection interface, PROtop interconnection interface		
-25 °C...70 °C		
IP20		
29 g		
33.6 / 35 / 74.4 mm		
cULus		

Note

Ordering data

Type	Qty.	Order No.
PRO COM IO-LINK	1	2587360000

Note

Display module

PRO COM Display 7S

PRO COM Display 7S



Technical data

General data

Ambient temperature (operational)
 Protection degree
 Weight
 Depth x width x height

-25 °C...70 °C
 IP20
 93 g
 33.6 / 34 / 74.4 mm

Approvals

Approvals

cULus

Note

Ordering data

Type	Qty.	Order No.
PRO COM DISPLAY 7S	1	2466960000

Note

Service and support

Service and support	Service connects - worldwide	V.2
	Engineering services and customised products	V.3
	easyConnect - Your Industrial Service Platform	V.4
	Support Center	V.6
	Additional support services	V.7
	Weidmüller Configurator: intuitive, uncomplicated & fast digital engineering	V.8
	Your digital ordering options at Weidmüller	V.10

Our expertise for your requirements

Service connects – worldwide



Automation technology functions are becoming more complex in a globally-oriented world facing ambitious targets in terms of energy efficiency and smart production. We are your equal partners for the best connections in Industrial Connectivity.

Our personal support answers all questions reliably and expertly. During planning, installation or operation our service and support offer is your best companion.

In short: Weidmüller's global service combines our expertise with your requirements.

V



Your way to our service
www.weidmueller.com/service

Engineering services and customised products

Automation engineering and connectivity consulting belongs to our services as well as assembly of engineered products. We also support the process from the idea to the product with our Weidmüller Configurator and the Configure-to-Order process.



Consulting and engineering

The challenge for you is reducing costs and increasing efficiency. This requires intelligent, individual solutions. Whether it is modified products, pre-fitted mounting rails or complete small cabinets – our application centres provide a highly qualified custom-made engineering and production service.



Connectivity Consulting

Increase your competitiveness - supported by our experts. Our drive is to optimise your competitiveness. That's why our team of experts supports you in significantly increasing your efficiency in electrical machine design and control cabinet construction. With proven products and services from the Weidmüller portfolio – and with the experience gained from over 300 projects worldwide.



Assembled terminal rails - Flexibly designed to suit your requirements

Your processes in panel building have to be fast, flexible and productive. This is the only way you can cut your costs and increase efficiency. Depending on the application in question, you will have different requirements with respect to the engineering service, delivery speed and flexibility to be provided.



Modified and assembled enclosures - Competitive advantages included

To compete internationally, your plants need to satisfy high standards of safety, quality and performance. The smart combination of consultation, application expertise and industry know-how is our key to finding a custom-fit solution for your application. Reduce costs and increase efficiency.

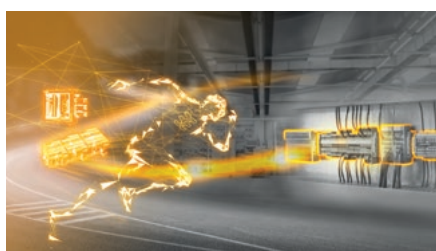

Fast Delivery Service - Your ideas deserve a quick realisation

Obtain offers 24/7 and within minutes, including directly orderable article numbers with our Fast Delivery Service. The Weidmüller Configurator (WMC) for planning and configuration is key for consistent processes. Dispatch your orders in 5 days. Assemble individual terminal strips and enclosures from batch size 1!

Your ticket to the world of digital service

easyConnect – Your Industrial Service Platform



Our cloud-based platform is your ticket to the world of digital services from Weidmüller, and the intuitive and future-proof tool for your way to the Industrial IoT. Realise your use cases easily, consistently and without any relevant prior knowledge, thanks to the perfect interaction of platform, devices and diverse software services.

As an open, modular and perfectly integrable system, the platform is your enabler for a wide range of use cases. Increase your efficiency and unleash your full innovation potential with easyConnect.

V



Interested in using easyConnect?

Learn how to get started with easyConnect step-by-step.

www.weidmueller.com/easyconnect

Why should you use easyConnect?

- You want to enter your digital transformation step-by-step?
- You want to make the step into Industrial IOT, but have no or little IT expertise?
- You want to use your digital data for smart & scalable services?
- You want to offer digital services (such as customised dashboard) to your customers?
- You want to improve your service offering and efficiency, e.g. through remote access?
- You feel Weidmüller's digital services are interesting, but you have „your cloud“ already?



Weidmüller comes up with the solution: easyConnect, the new digitalisation platform. It bundles Weidmüller's digital services at one place in the cloud and connects them with various Weidmüller devices.

With easyConnect you start digitalising your application step-by-step without ballast in a secure way.

The following services are initially available on easyConnect:

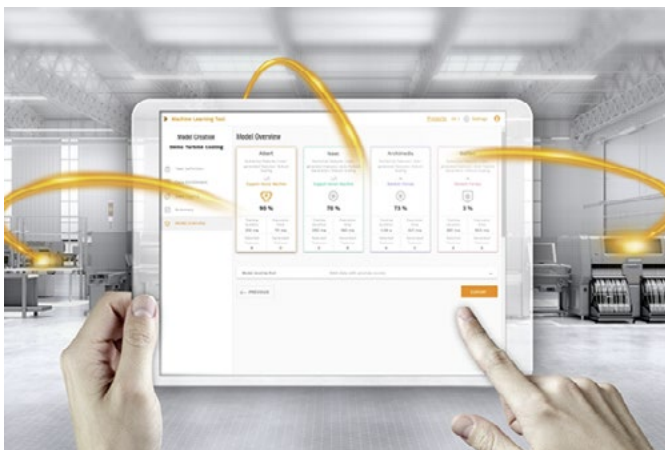

Device management

Adding and managing cloud-connected devices is typically the first step in any Industrial IoT use case.

Asset management

The asset management service is a modelling tool that allows users to model their assets and processes and link them to relevant time series data.

Remote access (u-link)

u-link guarantees a quick and secure access to machines and plants while also allowing for efficient management.

Data visualisation

easyConnect data visualisation services enable users to view, monitor and display live and historical data.

AutoML

With Weidmüller Industrial AutoML, you can optimize operations, increase product quality and develop new business models by benefiting from advanced analytics.

Expand the possibilities of our products

Our Support Center provides you with comprehensive, clear and personal assistance



Receive fast and intuitive support to get the most out of our products in your application. In our new Support Center you can search or navigate to the many application notes, product information, video tutorials or software downloads of our products.

- **Everything at a glance** – One central support hub, where all relevant information is available
- **Powerful search** – Provides filter functions for various types of information and products
- **Different views and navigations** – Content provided in views product information, engineering support or software downloads
- **More than 170,000 downloads** – Application notes, video tutorials, templates and examples, user documentation, engineering data, ...
- **Personal contact** – Direct access to your personal technical contact in your country



Explore the world of our new Support Center
support.weidmueller.com

Additional support services

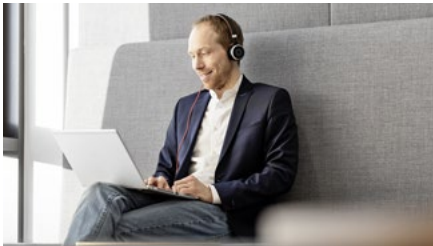

Training and Webinars

Stay tuned in a world that is accelerating. In our entertaining interactive webinars, we offer you the opportunity to learn about new products and technology topics and to interact with our experts.



Repairs and replacement parts

We offer repair and components for our Workplace Solutions as well as assistance for other Weidmüller products. Find out how our experts can help you with your repair request.



Security advisory board

Our Product Security Incident Response Team (PSIRT) continuously informs you about possible security-related vulnerabilities of our products.



Engineering data

For the quick integration of our products into your design, there are a lot of digital product data for engineering systems like EPLAN, Zuken E3.series, WSCAD and many others available for download.

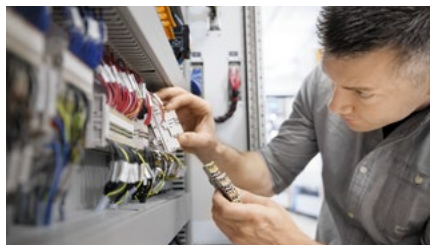

Product change notifications

Technical modifications of our products always available online.



Technical product catalogues

Technical data for our entire program in Industrial Connectivity for download in PDF-format.

From the idea to the finished solution

Weidmüller Configurator: intuitive, uncomplicated & fast digital engineering

Digital engineering can be so easy – with the Weidmüller Configurator!

It's a **free to use** software application to easily configure industrial solutions. It features more than **12,000 articles** from multiple product families including rail-mounted components, industrial and ex-certified enclosures, Heavy Duty Connectors, remote I/O-systems and PCB connectors.

Unleash the full power of digital engineering:

Our application wizards help you choose the right articles.

Place, mark or modify them to your needs and get your solution **visualized in 3D** – what you see is what you get!

Our promise: Speed up your solution planning process by up to 70%!

Your benefits:

- **Proven configuration designs in real 3D:** The plausibility and collision check with the complete digital documentation ensures that you can rely 100% on your configuration.
- **Seamless E-CAD Roundtrip:** Interfaces enable the simple exchange of product data between the WMC and all common engineering tools, such as Zuken E3 or EPLAN Electric P8.
- **Sample Service & Fast Delivery Service:** to support your design-in process, we offer a **3-day sample service** for many products. Inquire them directly online – for free!
You want your solution right away? Our **Fast Delivery Service** guarantees delivery of individually assembled terminal strips or enclosures within a few days.

Get started online now!

The Weidmüller Configurator makes solution planning easy. Visit our website for more information, tutorials and download it for free:



www.weidmueller.com/wmc



or register on easyconnect.weidmueller.com and use it online.



Wizards:

Design complete applications within few clicks – even without detailed product knowledge – for signal wiring, load monitoring, instrument transformers, enclosures, remote I/O-systems and many more.

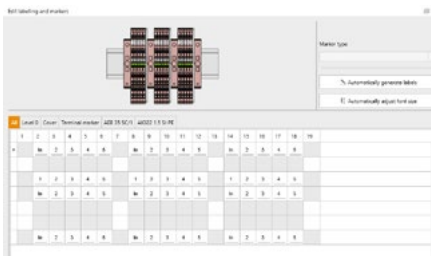

Assistants:

Finalize your solutions with supporting assistants to add cross-connectors, markers or colors and verify the faultlessness. Automatic modes save valuable time!



1-click documentation:

Get assembly drawings for production – only 1 click. Bill of material – only 1 click. The complete solution documentation including all component data sheets – you’re right, only 1 click!



Digital ordering options

Your digital ordering options at Weidmüller

Find and easily select the products you need, with convenient ordering: as your Partner in Industrial Connectivity, we know what counts in purchasing. That is why we offer you a variety of options for ordering products from us and optimising your purchasing processes to meet your individual requirements and your workflow. The choice is yours.

Order via the Weidmüller eShop

Our eShop offers you access to the complete Weidmüller product range around the clock – directly from a PC, tablet, or smartphone. The intuitive user guidance supports you as you select from over 50,000 products. Technical data, prices, and availabilities are available at any time. The shopping basket with check out function lets you place an order in seconds. Convenient additional functions like CSV upload, order history, reports, or custom order templates make your ordering processes even more efficient.

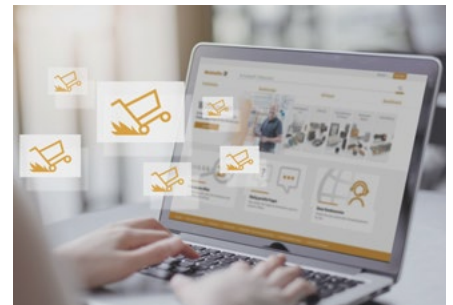

Order via the OCI interface

The Open Catalogue Interface (OCI) facilitates the exchange of data between your enterprise resource planning system and our eShop. This means that our eShop is integrated into your system via an OCI interface, so you have access to our complete product catalogue from your enterprise resource planning system. You can filter and select products, place them in your shopping basket and place direct orders without changing your software application. The open OCI standard is supported worldwide from a variety of software providers.

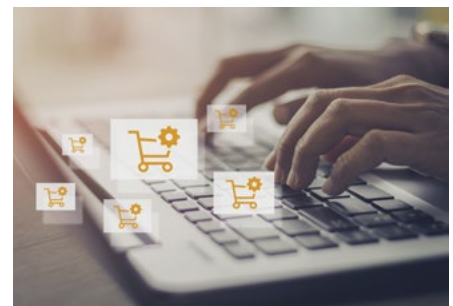

Order via the EDI interface

Our Electronic Data Interchange (EDI) also offers you the option of ordering our products directly from your enterprise resource planning system. All order data is transmitted automatically to our system and processed immediately. Orders, order confirmations, invoices, and delivery notices are transmitted lightning fast. This helps you make your purchasing processes even more efficient.

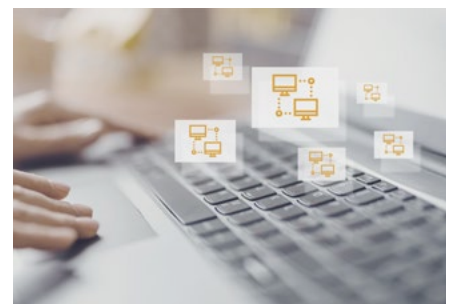

We will be glad to advise you on which solutions are suitable for you and how implementation is possible.

Get in touch with us

www.weidmueller.com/digital-order

Glossary/Technical appendix

Glossary/Technical appendix	Power Supplies - Overview	W.2
	Standards and approvals	W.4
	Glossary	W.6



Power Supplies – Overview

Power supplies are important links in the energy supply chain of automation systems. Unregulated power supplies or regulated switched-mode power supplies are at the heart of every electrical cabinet. 24 V DC has emerged as the standard control voltage for the supply of electrical sub-assemblies and systems. But other control voltages are also required. The correct power supply is a critical factor for the reliable operation of the supplied components. Thus it must be chosen with particular attention.

Regulated power supplies from Weidmüller have proven themselves reliable over many years in the supply of electrical sub-assemblies and systems. They perform reliably and safely – even under harsh industrial conditions – in all sectors of machine construction, industrial automation, and the power and process industries.

Weidmüller offers custom-fit solutions for practically all of your requirements:

- Switch-mode power supplies
- DC/DC converters
- Diode and redundancy modules
- UPS control modules
- Electronic load monitoring

How they work

Unregulated power supply units consist of a mains power transformer that transforms the input voltage into a different AC voltage. The units then make use of a rectifier and a filter circuit to smooth out the DC output voltage.

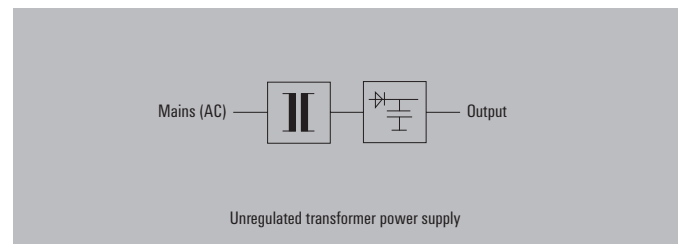

Regulated power supply units in the range up to 1,000 W are usually designed as primary switched-mode power units. The mains AC voltage is then rectified and transformed in high frequency to the secondary side using switching transistors and power transformers. This is followed by the rectifier and filter circuit in order to generate the DC output voltage. A control circuit compares the current and voltage on the output side to the specified target values and then generates a control signal for the switching transistors. This permits compensation for load changes and mains voltage fluctuations. As a result, the output voltage remains stable. These power supply units are increasingly being operated with DC input voltages (e.g. the Weidmüller PROtop, PROeco, PROmax, etc.).

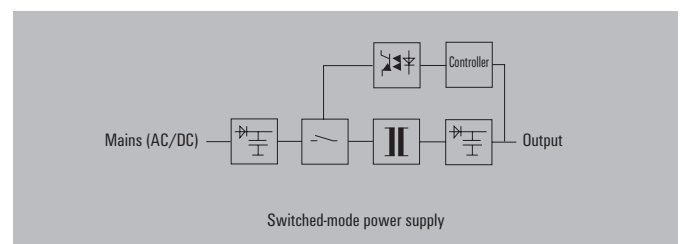

A DC/DC converter is a variation of the classic switched mode power supply. The switching strategy is similar but there is no input rectifier. Starting with a specified DC input voltage, DC/DC converters generate a different DC voltage at a similar or different level. They are used to adapt different voltage levels and also for isolating potentials.

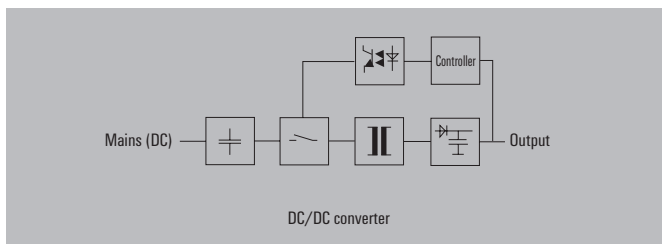

In use around the globe

Weidmüller's power supply units have been designed for use around the world. They can be used in practically all applications throughout the world because of their CE label and many other national and international approvals. Their wide input voltage ranges and compatibility with various mains power connections increases their global appeal.

Temperature range

During operation, power supply units generate power losses. In Weidmüller's switched-mode power supplies, the resulting heat is dispersed using natural air currents only. The design, which does not make use of a ventilation fan, is an example of our uncompromised durability standard. Weidmüller's power supply units, depending on the model, can be used in temperatures ranging from -40 °C to +70 °C.

Compact and efficient design

Weidmüller's switched-mode power supplies are extra small because they take advantage of the above-average degree of efficiency offered by the latest technologies. The power supplies from Weidmüller – whether they are book-shaped with minimised base surface, or variants with reduced height for use in distributor boxes – always provide the proper cost-saving solution.

Standards and approvals

Standard/Approval	Description
DIN EN 50178 (VDE 0160)	Electronic equipment for use in power installations
DIN EN 60950-1 (VDE 0805-1)	IT Equipment – Safety – Part 1: General requirements
DIN EN 61558-1 (VDE 0570-1)	Safety of transformers, power supply units, throttles and similar devices Part 1: General requirements and tests
DIN EN 61558-2-17 (VDE 0570 Part 2-17)	Safety of transformers, power supply units and similar devices Part 2-17: Special requirements for switch-mode power supply transformers
DIN EN 60204-1 (VDE 0113-1)	Safety of machinery – Electrical equipment of machinery – Part 1: General requirements
DIN VDE 0100-410	Construction of power installations with rated voltages up to 1,000 V Part 4: Protective measures Chapter 41: Protection against electrical shock
DIN EN 61204-1	Power supply units for low voltages, with direct-current-output – properties
DIN EN 60947-1	Low-voltage switching devices – Part 1: General definitions
DIN EN 61140	Protection against electrical shock - common requirements for facilities and operating equipment
IEC 38	Supplementary notes relating to status of international standards and European harmonisation of mains voltages 230/400 V
73/23 EWG	Electrical equipment for use within specific voltage limits (Low Voltage Directive)
2004/108/EG (89/336 EWG)	Electromagnetic compatibility (EMC Directive)
2006/42/EG (98/37 EG)	Safety of machines (directive covering mechanical equipment)
UL	Safety approval for the United States market
CSA	Safety approval for the Canadian market
GL	Test specifications for electrical/electronic devices and systems for use in marine technology
UL1310	Class 2 power supplies (limited energy)
UL1604	Electrical equipment for use in dangerous surroundings

Standard/Approval	Description
SEMI F47	Resistance of electronic devices against voltage drops
2006/95/EG (72/23/EWG)	Low Voltage Directive
EN 60721-3-2	Classification of surrounding conditions
EN 60664-1 (VDE0110-1)	Insulation coordination for electrical equipment
C22.2 No. 107.1	General standards for power supplies (Canadian standard)
EN 61000-3-2	Limiting of mains voltage harmonic currents
EN 61000-4-x	Interference immunity tests

Glossary

A

AC/DC converter	Conventional switched-mode power supplies generate a DC voltage from an AC voltage. For this reason they are sometimes also called AC/DC converters. Such devices are increasingly compatible for use with DC input voltages. The primary and secondary sides are typically electrically isolated.
Ambient temperature (operational)	The ambient operating temperature (the min. and max. values) together with the output current and voltage ratings can be used to describe the power capabilities of a power supply unit.

B

Burst	A burst is a quick low-power burst pulse which can, for example, simulate welding equipment phenomena. Similar phenomena can also result from switching operations on the mains supply. This test can be used to demonstrate immunity against quick transients.
--------------	---

C

Class of protection	Electrical equipment is classified according to varying classes of protection. These classes define the particular safety measures that are required to avoid an electrical shock. The most widely used power supplies correspond with protection class I. The basic requirement of protection class I is for a basic insulation and for the earthing of all conductive housing parts. If the basic insulation fails, then the earthed conductive housing serves to prevent an electrical shock. For this reason, devices in protection class I are equipped with an earth (PE) connection.
Connecting power supply units in parallel	Power supplies can only be connected in parallel when this is clearly permitted by the manufacturer. Parallel connections are then normally tied to certain conditions. This is a typical way to increase the output power (for example, when extending a facility). Power supplies are also wired in parallel in order to design in redundant power supply systems. The parallel circuit is not wired straight though but connects using decoupling diodes. → Redundancy
Cooling	Cooling is used by components or devices to prevent them from overheating. A variety of cooling strategies are available – two of the most common are natural and forced-air cooling. Natural (convection-based) cooling takes advantage of the natural air currents. Manufacturers must then ensure that there is sufficient air flow by specifying the clearance gaps and mounting positions that are required above and below the ventilation openings. Forced-air cooling normally uses a fan to dissipate any heat that has been generated. When fans are used in a device, they have the effect of increasing the likelihood of device outages. For this reason, a power supply with natural cooling methods is generally preferred.

D

DC/DC converter	DC/DC converters are switched-mode power supplies that convert a specific DC voltage into another voltage. They are a variant of the AC/DC converter. DC/DC converters, in their simplest implementation, do not isolate voltage potentials. They are used only for adapting voltages. Improved DC/DC converters have isolated voltages. A safety isolating transformer in the power element ensures the required electrical isolation. Besides the voltage adaptation, the isolation of the voltage potentials is an important factor.																																
Derating	<p>For power supply devices, derating generally refers to the reduction in power as influenced by the surrounding temperature and the input voltage. A temperature derating often occurs starting at a surrounding temperature of 50 °C. The rated power is guaranteed up to this temperature. The available power continually declines as the temperature heats up above this level. This is typically specified in %/K. A voltage-dependent specification is another form of derating. For switched-mode power supplies, the derating begins below a specific input voltage. So a switched-mode power supply with a wide input range can typically work under full power with 115 V AC input voltage. However at 85 V AC it can only produce 60 % of the power rating. The coefficient is usually specified in %/V.</p> <div style="display: flex; justify-content: space-around;"> <div data-bbox="624 1115 978 1361"> <p style="text-align: center;">Temperature derating</p> <table border="1"> <caption>Temperature derating data</caption> <thead> <tr> <th>Temperature [°C]</th> <th>Max. current [%IN]</th> </tr> </thead> <tbody> <tr><td>40</td><td>100</td></tr> <tr><td>50</td><td>100</td></tr> <tr><td>60</td><td>100</td></tr> <tr><td>70</td><td>80</td></tr> </tbody> </table> </div> <div data-bbox="1066 1115 1434 1361"> <p style="text-align: center;">Voltage derating</p> <table border="1"> <caption>Voltage derating data</caption> <thead> <tr> <th>Main voltage [V]</th> <th>Max. current [%IN]</th> </tr> </thead> <tbody> <tr><td>85</td><td>60</td></tr> <tr><td>115</td><td>100</td></tr> <tr><td>130</td><td>100</td></tr> <tr><td>150</td><td>100</td></tr> <tr><td>170</td><td>100</td></tr> <tr><td>190</td><td>100</td></tr> <tr><td>210</td><td>100</td></tr> <tr><td>230</td><td>100</td></tr> <tr><td>250</td><td>100</td></tr> <tr><td>270</td><td>100</td></tr> </tbody> </table> </div> </div>	Temperature [°C]	Max. current [%IN]	40	100	50	100	60	100	70	80	Main voltage [V]	Max. current [%IN]	85	60	115	100	130	100	150	100	170	100	190	100	210	100	230	100	250	100	270	100
Temperature [°C]	Max. current [%IN]																																
40	100																																
50	100																																
60	100																																
70	80																																
Main voltage [V]	Max. current [%IN]																																
85	60																																
115	100																																
130	100																																
150	100																																
170	100																																
190	100																																
210	100																																
230	100																																
250	100																																
270	100																																
Diode modules	Diode modules are used to construct a redundant power supply system. They are important for decoupling the power supply unit. Thus, a short circuit that occurs on the output of a power supply unit will not influence the output voltage.																																

E

Efficiency	The degree of efficiency is equal to the ratio of output power to input power and is expressed in percent. The degree of efficiency can be between 70 and 90 %, depending on the dimensions and type of technology in use.
EMC (electromagnetic compatibility)	Electromagnetic compatibility describes the interference emissions caused by an electronic device and the level of immunity against external electrical influences. Interference emissions can be caused by cabling and wires or by radiated emissions. Immunity measures the resistance against such wire-based emissions and against radiated emissions such as electrostatic fields and magnetic fields. Electric devices must also be protected against electrostatic discharges.

F

Foldback characteristic curve

The foldback characteristic curve is a special type of output curve that protects the power supply unit from overloads. When a specific current limit is exceeded (for example, by 110 or 120 % of the nominal level), the current is limited electronically and lowered to a very low, safe value. This downward-sloping characteristic curve means that it is not sufficient to simply eliminate the overload. The load must be reduced significantly more so that the adjustment control can return to the normal voltage control. Thus this solution is not suitable for many applications and is becoming less popular.

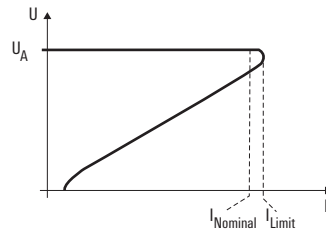

G

Galvanic isolation

Galvanic (electrical) isolation ensures that no electrical connections can exist between the primary and the secondary sides. Opto modules and transformers are the typical components used.

H

Hiccup mode

The hiccup mode is a special output characteristic curve that protects power supply units from overloads and short circuits. The unit switches off at a specified current limit (for example, 110 or 120 % on the nominal rating) and then switches back on after a certain delay. This leads to a pulsating mode of operations which can only revert to continual operations after the overload has been eliminated. The main disadvantage here is that the connected consumer load must be restarted after every pause. A restart may not be possible with motors or large capacitive loads since the restart current peak may once again exceed the defined limit.

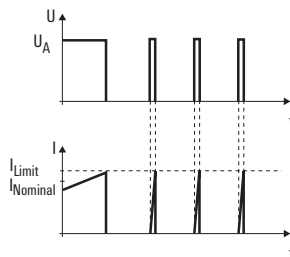

**Hold-up time
(mains-failure bridging time)**

The hold-up time (also known as the mains-failure bridging time) is the interval from the start of the mains outage to the point in time when the output voltage can no longer be maintained at its original level. The hold-up time indicates how long a mains outage may last before it influences the output voltage. For DC power supplies, EN 61204 requires a bridging time of at least 20 ms.

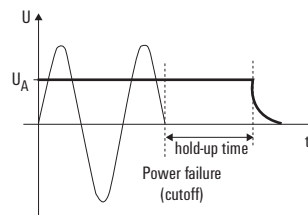

Input voltage range

This refers to the minimum and maximum input voltage at which the rated output specifications can be maintained.

Inrush current

The inrush current refers to the peak current that occurs when turning on a consumer load. Switched-mode power supplies have storage capacitors in the input which can cause significant current peaks while the mains power is being switched on. A variety of circuitry solutions can be used to attenuate these current peaks. In the simplest solution, an inrush limiter is used. Active switching can be used in other cases. The peak current specification indicates which upstream fuse should be used in the circuit. If a fuse is selected which is too sensitive, it can trigger when the mains power is switched on.

IU characteristic curve

The IU characteristic curve is a special output characteristic curve that protects power supply units from overloads and short circuits. It offers the best performance with regards to overload and short circuit capabilities. A current limit is activated at a specific current level (for example, 110 or 120 % on the nominal rating). As the load continues to increase, the output voltage is reduced according to the current limit curve until it reaches a level approaching zero volts. Thus a pulsating mode of operations is avoided for short-term overloads. Large capacitive loads or motors are brought back up along the slope of the current-limit characteristic curve. After a short circuit or overload is fixed, the IU characteristic curve offers the advantage of immediately returning to the normal voltage control mechanism. The full output voltage is then immediately available. The IU characteristic curve is becoming the established standard for modern power supplies. Additional variants are available which pertain to the peak current capacity and the slope of the current-limit characteristic curve.

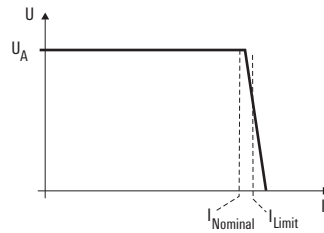

M

Mains harmonics

Power supplies can experience harmonics caused by mains rectification on the input side. These harmonics are multiples of the mains frequencies. Existing standards define specific limit values since such harmonics can significantly lower the mains quality.

Mains system types

This refers to the types of mains supply systems. Systems differ in their method of earthing and the implementation of the phase wire, PE wire and central-point wire. Common mains systems include the TN, IT and TT networks. The individual mains types can also differ in their voltage levels and frequencies.

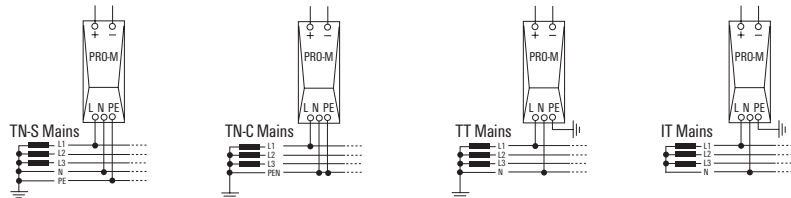

MTBF (mean time between failure)

The MTBF is a statistical value that specifies the probability that a product will fail. It is typically specified in hours and normally assumes a temperature of 25 °C. The probability of failure depends largely on the ambient surroundings. The key variables are the type of load and the ambient temperature.

W

O

Output characteristic curves	<p>The output characteristic curves of power supply devices are determined by current and voltage. Unregulated devices do not have a current limit. In the case of an overload or short circuit, fuses or temperature switches are used to protect the device. Regulated devices are protected against overload and short circuits by means of various output characteristic curves. In this case, the system attempts to prevent any activation of fuses or temperature switches.</p> <p>The mandatory manual reset which follows an overload or short circuit can then be avoided. Common output characteristic curves include the hiccup mode, the foldback characteristic curve or the IU characteristic curve.</p> <p>→ Hiccup mode, foldback characteristic curve, IU characteristic curve</p>
Overvoltage category	<p>Power supply units are classified into overvoltage categories according to the immunity against mains surges and transient voltages.</p>

P

PELV (protective extra-low voltage)	<p>This is a functional DC voltage with secure isolation according to EN 50178. As with SELV, a reinforced or double insulation is used between the primary and secondary sides. However, the secondary side is earthed.</p>
PFC (power factor correction)	<p>The power factor correction can be either passive or active in relation to power supply devices. The reactive power resulting from the bridge rectification puts a significant strain on the power supply network. The relatively poor power efficiency factor that results can be improved by using passive components (such as filters) or an active electronic mechanism. For switched-mode power supplies, PFC usually refers to the active variant of the power factor correction. Power factors of almost 1 can be reached when using an active PFC. Practically no reactive power is drawn from the mains supply network; therefore the strain on the mains network is relatively low.</p>
Pollution severity	<p>Pollution severity describes the environment and ambient conditions that a device requires in order for it to function smoothly. Significant environmental variables include condensation or air containing dust and oil.</p>
Power-boost or boost	<p>The power-boost function is the surge current handling capacity in the seconds to minutes range. This function is often required for starting up DC motors. DC motors have a high start-up current and often require several seconds before they have achieved their rated rotational speed. The power-boost function helps to optimise this start-up phase.</p>
Power factor	<p>The power factor is the ratio of reactive power to apparent power. It is an indicator of the device performance with respect to the load on the mains power network. Depending on the technology in use, the power factor for power supplies can be between 0.45 and nearly 1.</p>

Power loss	For power supply units, the power loss specification indicates the thermal output emitted during nominal (rated) operations. This is a key specification used by engineers when designing the climate control systems within electrical cabinets. It is calculated as the difference between the input and output power and can also take the degree of efficiency into account.
Power rating	The continual output permitted under the rated conditions.
Power supply units connected in series	Power supplies can only be connected in series when this is clearly permitted by the manufacturer. Such series connections are then normally tied to certain conditions. They can be used to increase the output voltage. This is not widely implemented.
Protection degree	According to DIN EN 60529, devices can be classified according to their protection degrees. The numeric code (for example, IP 20) defines two protection degrees: protection against touch or penetration by external objects (the first digit) and protection against water penetration (the second digit). Switched-mode power supplies intended for use in electrical cabinets or similar enclosures are often designed with IP 20 protection. The first digit (in this case, 2) ensures finger protection. The second digit (0) indicates that no protection against water is provided.
Pulsed current capacity	The pulsed current capacity describes the dynamic performance of a switched-mode power supply. Capacitive consumer loads, with their high inrush currents, put a particular strain on a switched-mode power supply. Peak values are reached (in the ms range) which amount to levels many times higher than the mains current. If the current control mechanism reacts too quickly, this can lead to voltage drops and can cause problems for loads which are connected in parallel. For this reason, power supplies are often equipped with a surge current limiting factor based on time. This allows a high current output for only a few ms which can be much higher than the rated current.

R

Rated control voltage	The nominal value of the sparkover voltage for the relay.
Rated input voltage	The input voltage required at which, under the normal mains voltage fluctuations, the output levels can be kept stable. It usually corresponds to the rated voltage for the electric utility's power grid.
Rated output current	The long-term current permitted under the rated conditions.
Rated output voltage	The nominal output voltage used for the rated specifications. It usually corresponds to the factory default output voltage.

Redundancy	A power supply system is considered redundant if it is constructed so that it has partial power supplies which are independent of each other and each of these can individually deliver the output load. When a fault occurs, therefore, it is still possible to continue to supply the connected rated load. In reality, at least two power supplies are connected in parallel using decoupling diodes. In this way, a short circuit in the output of one power supply will not lead to the failure of the entire power supply system. → Diode modules
Regulated power supply units	Switched-mode power supplies, as opposed to more common power supply units, have become established as the standard for the 10–1,000 W power range. They produce a stable output voltage with minimal residual ripple, even when influenced by fluctuations in the mains voltage, mains frequency or load. Their small size and weight is a result of their superior efficiency degree. The electronic control mechanism typically ensures a constant output voltage that varies $\pm 1\%$.
Residual ripple	The residual ripple describes the ratio of superimposed AC voltage to DC voltage on the output side of the power supplies. In addition to a percent specification, the superimposed ripple is often specified in mV_{SS} for switched-mode power supplies.
Resistance to shock	Resistance to shock refers to mechanical immunity against impacts in any direction. This is a key factor while the product is being transported.
Response time	The response time is the time that a power supply unit needs to compensate for a disturbance (for example, a load fluctuation).

S

Switching frequency	Switched-mode power supplies are normally operated with switching frequencies from 20 to 200 kHz. The HF or power transformer is switched on and off using transistors at this switching frequency. Small, compact units can be built with this method in comparison with the traditional 50/60 Hz transformers.
----------------------------	--

Switched-mode power supply units

The switching pulse can be either primary or secondary. Thus there are primary switched-mode and secondary switched-mode power supply units. Secondary switched-mode power supply units are no longer of much significance. The primary switched-mode power supplies are now the focus of attention. The pulse refers to the high-frequency on and off switching of the transformer or transmitter in order to transmit energy. The high frequency allows the use of extra small inductive and capacitive components, particularly for the transmitter. In comparison to transformer-based power supply units, the weight and volume required are much reduced.

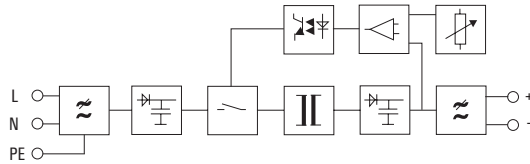

Selectivity

When surge protection equipment is connected in series, selectivity refers to the ability of only one upstream fuse to trigger selectively in the event of an overload. The differentiation can take into account current or also time. With DC power supply systems, selectivity refers to the separate fusing of load circuits on the DC side. In this case as well, only the proper series fuse should trigger in the event of an overload. Fuses in DC circuits play a critical role since the power supplies must react to upcoming short circuits with a speedy cut-off or by limiting the current. Usually electronic fuses are used for this purpose.

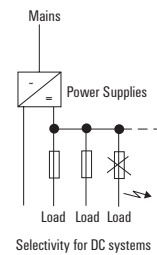
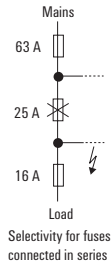

SELV (safety extra low voltage)

SELV refers to extra-low safety voltages according to IEC/EN 60950. Reinforced or doubled insulation between the primary and secondary sides is used to prevent electric shock. The output voltage here is sufficiently low so that it does not pose an injury risk if a person comes into direct contact.

Surge

A surge is a high-power voltage pulse which can be caused by, for example, a lightning strike. The switching operations from large consumer loads can also generate such voltage surges on the mains network. The surge test is used to demonstrate the immunity against high-power voltage pulses.

T

Temperature range	The temperature range specifies the minimum and maximum ambient temperatures for which a device can start up and run continuously.
--------------------------	--

U

Unregulated power supply units	Unregulated power supplies consist mainly of a transformer, a rectifier and an Elkos filter. Since no controlling system is in place, mains voltage fluctuations influence the DC voltage side. Unregulated power supply units are very sturdy; they can be used in applications where a stabilised DC voltage is not necessary (for example, power supply to contactors).
---------------------------------------	--

V

Vibration resistance	Vibration resistance describes the resistance against constant mechanical vibrations that occur during operations. Rail and ship applications place stricter demands for vibration resistance on the device.
-----------------------------	--

W

Wide-range input	Modern switched-mode power supplies often feature a wide input range. They can be run under a wide range of voltages: from min. to max. rated voltages including the tolerance limits. They do not require any manual range switching.
-------------------------	--

W

Index

Index	Index Type	X.2
	Index Order No.	X.4
	Addresses worldwide	X.6

Type	Order No.	Page
A		
AMG AM	2081890000	B.21
AMG AM CO	2082770000	B.31
AMG CM	2081900000	B.22
AMG CM EX	2083360000	B.32
AMG DIS	2123050000	B.14
AMG DIS	2123050000	B.15
AMG DIS	2123050000	B.16
AMG DIS	2123050000	B.17
AMG DIS	2123050000	B.18
AMG DIS	2123050000	B.20
AMG DIS	2123050000	B.23
AMG DIS	2123050000	B.5
AMG DIS	2123050000	B.6
AMG DIS	2123050000	B.7
AMG DIS EX	2495100000	B.26
AMG DIS EX	2495100000	B.27
AMG DIS EX	2495100000	B.28
AMG DIS EX	2495100000	B.29
AMG DIS EX	2495100000	B.30
AMG DIS EX	2495100000	B.33
AMG ELM-10D CO	2082470000	B.20
AMG ELM-10F	2080650000	B.15
AMG ELM-10F EX	2082430000	B.27
AMG ELM-12	2080410000	B.18
AMG ELM-12 EX	2082010000	B.29
AMG ELM-18	2859800000	B.19
AMG ELM-18 EX	2838520000	B.30
AMG ELM-1F	2080420000	B.14
AMG ELM-1F CL2	2491270000	B.16
AMG ELM-1F EX	2082040000	B.26
AMG ELM-2F	2080480000	B.16
AMG ELM-2F CL2	2491280000	B.16
AMG ELM-2F EX	2082050000	B.26
AMG ELM-4F	2080490000	B.14
AMG ELM-4F CL2	2491290000	B.16
AMG ELM-4F EX	2082060000	B.26
AMG ELM-6	2080360000	B.17
AMG ELM-6 EX	2082000000	B.28
AMG ELM-6D CO	2082440000	B.20
AMG ELM-6F	2080500000	B.14
AMG ELM-6F EX	2082310000	B.26
AMG ELM-8F	2080600000	B.15
AMG ELM-8F EX	2082320000	B.27
AMG EP 2010	2495380000	B.34
AMG EP KIT	2500760000	B.34
AMG FIM-0	2081870000	B.12
AMG FIM-0 EX	2082530000	B.24
AMG FIM-C	2081880000	B.13
AMG FIM-C EX	2082540000	B.25
AMG MD	2122930000	B.14
AMG MD	2122930000	B.15
AMG MD	2122930000	B.16
AMG MD	2122930000	B.17
AMG MD	2122930000	B.18
AMG MD	2122930000	B.20
AMG MD	2122930000	B.23
AMG MD	2122930000	B.5
AMG MD	2122930000	B.6
AMG MD	2122930000	B.7
AMG MD EX	2495040000	B.26
AMG MD EX	2495040000	B.27
AMG MD EX	2495040000	B.28
AMG MD EX	2495040000	B.29
AMG MD EX	2495040000	B.30
AMG MD EX	2495040000	B.33
AMG OD	2122910000	B.14
AMG OD	2122910000	B.15
AMG OD	2122910000	B.16
AMG OD	2122910000	B.17
AMG OD	2122910000	B.18
AMG OD	2122910000	B.20
AMG OD	2122910000	B.23
AMG OD	2122910000	B.5
AMG OD	2122910000	B.6
AMG OD	2122910000	B.7
AMG OD EX	2495090000	B.26
AMG OD EX	2495090000	B.27
AMG OD EX	2495090000	B.28
AMG OD EX	2495090000	B.29
AMG OD EX	2495090000	B.30
AMG OD EX	2495090000	B.33
AMG PD	2122920000	B.14
AMG PD	2122920000	B.15
AMG PD	2122920000	B.16
AMG PD	2122920000	B.17
AMG PD	2122920000	B.18
AMG PD	2122920000	B.20
AMG PD	2122920000	B.23
AMG PD	2122920000	B.5
AMG PD	2122920000	B.6
AMG PD	2122920000	B.7
AMG PD EX	2495070000	B.26
AMG PD EX	2495070000	B.27
AMG PD EX	2495070000	B.28
AMG PD EX	2495070000	B.29
AMG PD EX	2495070000	B.30
AMG PD EX	2495070000	B.33

Type	Order No.	Page
C		
AMG PP	2123000000	B.11
AMG PP	2123000000	B.34
AMG XMD	2122940000	B.23
AMG XMD EX	2495080000	B.26
AMG XMD EX	2495080000	B.27
AMG XMD EX	2495080000	B.28
AMG XMD EX	2495080000	B.29
AMG XMD EX	2495080000	B.30
AMG XMD EX	2495080000	B.33
C		
CP A WALLADAPTER 30 MM	1461870000	A.40
CP A WALLADAPTER 30 MM	1461870000	A.53
CP A WALLADAPTER 30 MM	1461870000	A.64
CP A WALLADAPTER 30 MM	1461870000	C.6
CP A WALLADAPTER 45MM	1461850000	A.40
CP A WALLADAPTER 45MM	1461850000	A.53
CP A WALLADAPTER 45MM	1461850000	A.64
CP A WALLADAPTER 45MM	1461850000	C.6
CP DC UPS 24V 20A/10A	1370050010	C.5
CP DC UPS 24V 20A/10A	1370050010	IX
CP DC UPS 24V 40A	1370040010	C.5
CP DC UPS 24V 40A	1370040010	IX
CP DC UPS TF05	1444480000	C.6
CP DC UPS TF25	1444540000	C.6
D		
DURA ECO LA-BAT 24V 1.2AH	2789890000	C.10
DURA ECO LA-BAT 24V 1.2AH	2789890000	IX
DURA ECO LA-BAT 24V 12AH	2789920000	C.11
DURA ECO LA-BAT 24V 12AH	2789920000	IX
DURA ECO LA-BAT 24V 17AH	2789930000	C.11
DURA ECO LA-BAT 24V 17AH	2789930000	IX
DURA ECO LA-BAT 24V 3.4AH	2789900000	C.10
DURA ECO LA-BAT 24V 3.4AH	2789900000	IX
DURA ECO LA-BAT 24V 7AH	2789910000	C.11
DURA ECO LA-BAT 24V 7AH	2789910000	IX
K		
KT 14	1157820000	B.34
M		
MTA 30 BK	1168970000	A.40
MTA 30 BK	1168970000	A.53
MTA 30 BK	1168970000	A.64
MTA 30 BK	1168970000	C.6
MTA 30 MF	1251320000	A.40
MTA 30 MF	1251320000	A.53
MTA 30 MF	1251320000	A.64
MTA 30 MF	1251320000	C.6
MTA 45 BK	1962250000	A.40
MTA 45 BK	1962250000	A.53
MTA 45 BK	1962250000	A.64
MTA 45 BK	1962250000	C.6
MTA 45 MF	1251310000	A.40
MTA 45 MF	1251310000	A.53
MTA 45 MF	1251310000	A.64
MTA 45 MF	1251310000	C.6
P		
PRO BAS 120W 12V 10A	2838450000	A.72
PRO BAS 120W 12V 10A	2838450000	VII
PRO BAS 120W 24V 5A	2838440000	A.72
PRO BAS 120W 24V 5A	2838440000	VII
PRO BAS 240W 24V 10A	2838460000	A.73
PRO BAS 240W 24V 10A	2838460000	VII
PRO BAS 240W 48V 5A	2838470000	A.73
PRO BAS 240W 48V 5A	2838470000	VII
PRO BAS 30W 12V 2.6A	2838510000	A.69
PRO BAS 30W 12V 2.6A	2838510000	VII
PRO BAS 30W 24V 1.3A	2838500000	A.69
PRO BAS 30W 24V 1.3A	2838500000	VII
PRO BAS 30W 5V 6A	2838400000	A.70
PRO BAS 30W 5V 6A	2838400000	VII
PRO BAS 480W 24V 20A	2838480000	A.74
PRO BAS 480W 24V 20A	2838480000	VII
PRO BAS 480W 48V 10A	2838490000	A.74
PRO BAS 480W 48V 10A	2838490000	VII
PRO BAS 60W 12V 5A	2838420000	A.71
PRO BAS 60W 12V 5A	2838420000	VII
PRO BAS 60W 24V 2.5A	2838410000	A.70
PRO BAS 60W 24V 2.5A	2838410000	VII
PRO BAS 90W 24V 3.8A	2838430000	A.71
PRO BAS 90W 24V 3.8A	2838430000	VII
PRO BDM CAN OPEN	2467320000	F.4
PRO BDM DISPLAY 7S	2466960000	F.6
PRO BDM IO-LINK	2587360000	B.4
PRO BDM IO-LINK	2587360000	F.5
PRO DC BUFFER 24V 20A	2786240000	C.14
PRO DC BUFFER 24V 20A	2786240000	IX
PRO DC BUFFER 24V 40A	2786250000	C.14
PRO DC BUFFER 24V 40A	2786250000	IX
PRO DCDC 120W 24V 5A	2001800000	D.5
PRO DCDC 120W 24V 5A	2001800000	IX

Type	Order No.	Page
D		
PRO DCDC 240W 24V 10A	2001810000	D.5
PRO DCDC 240W 24V 10A	2001810000	IX
PRO DCDC 480W 24V 20A	2001820000	D.6
PRO DCDC 480W 24V 20A	2001820000	IX
PRO DM 10	2486070000	E.6
PRO DM 10	2486070000	IX
PRO DM 20	2486080000	E.6
PRO DM 20	2486080000	IX
PRO ECO 240W 48V 5A	1469590000	A.61
PRO ECO 240W 48V 5A	1469590000	VII
PRO ECO 240W 48V 10A	1469610000	A.61
PRO ECO 240W 48V 10A	1469610000	VII
PRO ECO 72W 12V 6A	1469570000	A.60
PRO ECO 72W 12V 6A	1469570000	VII
PRO ECO 120W 12V 10A	1469580000	A.60
PRO ECO 120W 12V 10A	1469580000	VII
PRO ECO 120W 24V 5A	1469480000	A.57
PRO ECO 120W 24V 5A	1469480000	VII
PRO ECO 240W 24V 10A	1469490000	A.58
PRO ECO 240W 24V 10A	1469490000	VII
PRO ECO 240W 24V 10A	1469510000	A.58
PRO ECO 240W 24V 10A	1469510000	VII
PRO ECO 480W 24V 20A	1469510000	VII
PRO ECO 480W 24V 20A	1469510000	VII
PRO ECO 72W 24V 3A	1469470000	A.57
PRO ECO 72W 24V 3A	1469470000	VII
PRO ECO 960W 24V 40A	1469520000	A.59
PRO ECO 960W 24V 40A	1469520000	VII
PRO ECO3 120W 24V 5A	1469530000	A.62
PRO ECO3 120W 24V 5A	1469530000	VII
PRO ECO3 240W 24V 10A	1469540000	A.62
PRO ECO3 240W 24V 10A	1469540000	VII
PRO ECO3 480W 24V 20A	1469550000	A.63
PRO ECO3 480W 24V 20A	1469550000	VII
PRO ECO3 960W 24V 40A	1469560000	A.63
PRO ECO3 960W 24V 40A	1469560000	VII
PRO INSTA 16W 24V 0.7A	2580180000	A.93
PRO INSTA 16W 24V 0.7A	2580180000	VIII
PRO INSTA 30W 12V 2.6A	2580220000	A.94
PRO INSTA 30W 12V 2.6A	2580220000	VIII
PRO INSTA 30W 24V 1.3A	2580190000	A.94
PRO INSTA 30W 24V 1.3A	2580190000	VIII
PRO INSTA 30W 5V 6A	2580210000	A.93
PRO INSTA 30W 5V 6A	2580210000	VIII
PRO INSTA 60W 12V 5A	2580240000	A.95
PRO INSTA 60W 12V 5A	2580240000	VIII
PRO INSTA 60W 24V 2.5A	2580230000	A.95
PRO INSTA 60W 24V 2.5A	2580230000	VIII
PRO INSTA 90W 24V 3.8A	2580250000	A.96
PRO INSTA 90W 24V 3.8A	2580250000	VIII
PRO INSTA 96W 24V 4A	2580260000	A.96
PRO INSTA 96W 24V 4A	2580260000	VIII
PRO INSTA 96W 48V 2A	2580270000	A.97
PRO INSTA 96W 48V 2A	2580270000	VIII
PRO MAX 120W 12V 10A	1478230000	A.49
PRO MAX 120W 12V 10A	1478230000	VII
PRO MAX 120W 24V 5A	1478110000	A.45
PRO MAX 120W 24V 5A	1478110000	VII
PRO MAX 180W 24V 7.5A	1478120000	A.46
PRO MAX 180W 24V 7.5A	1478120000	VII
PRO MAX 240W 24V 10A	1478130000	A.46
PRO MAX 240W 24V 10A	1478130000	VII
PRO MAX 240W 48V 5A	1478240000	A.49
PRO MAX 240W 48V 5A	1478240000	VII
PRO MAX 480W 24V 20A	1478140000	A.47
PRO MAX 480W 24V 20A	1478140000	VII
PRO MAX 480W 48V 10A	1478250000	A.50
PRO MAX 70W 5V 14A	1478210000	A.48
PRO MAX 70W 5V 14A	1478210000	VII
PRO MAX 72W 12V 6A	1478220000	A.48
PRO MAX 72W 12V 6A	1478220000	VII
PRO MAX 72W 24V 3A	1478100000	A.45
PRO MAX 72W 24V 3A	1478100000	VII
PRO MAX 960W 24V 40A	1478150000	A.47
PRO		

Type	Order No.	Page
PRO TOP3 960W 36V 26,6A CO	2467140000	VI
PRO TOP3 960W 48V 20A	2467170000	A.15
PRO TOP3 960W 48V 20A	2467170000	VI
PRO TOP3 960W 48V 20A CO	2467180000	A.24
PRO TOP3 960W 48V 20A CO	2467180000	VI
PRO TOPDC 24V/24V 10A	2627640000	A.29
PRO TOPDC 24V/24V 10A	2627640000	VI
PRO TOPDC 24V/24V 10A EX	2467300000	A.31
PRO TOPDC 24V/24V 10A EX	2467300000	VI
PRO TOPDC 24V/24V 20A	2627630000	A.30
PRO TOPDC 24V/24V 20A	2627630000	VI
PRO TOPDC 24V/24V 20A EX	2467310000	A.32
PRO TOPDC 24V/24V 20A EX	2467310000	VI
PRO TOPDC 24V/24V 5A	2627650000	A.29
PRO TOPDC 24V/24V 5A	2627650000	VI
PRO TOPDC 24V/24V 5A EX	2467290000	A.31
PRO TOPDC 24V/24V 5A EX	2467290000	VI
PRO TOPDC 24V/48V 10A	2627660000	A.30
PRO TOPDC 24V/48V 10A	2627660000	VI

S

SDIK PH1 X 80	2749890000	A.40
SDIK PH1 X 80	2749890000	A.53
SDIK PH1 X 80	2749890000	A.64
SDIS 0.5X3.0X100	2749800000	A.40
SDIS 0.5X3.0X100	2749800000	A.53
SDIS 0.5X3.0X100	2749800000	A.64
SDIS 0.5X3.0X100	2749800000	A.98
SDIS 0.5X3.0X100	2749800000	C.6
SDIS 1.0X5.5X125	2749850000	A.53
SDIS 1.0X5.5X125	2749850000	C.6
SM 18/9.5 K MC NE WS	1248580000	A.40
SM 18/9.5 K MC NE WS	1248580000	A.53
SM 18/9.5 K MC NE WS	1248580000	A.64
SM 18/9.5 K MC NE WS	1248580000	A.98
SM 18/9.5 K MC NE WS	1248580000	C.6

T

TGD ELM-12	2624990000	B.5
TGD ELM-4 CL2	2656670000	B.7
TGD ELM-6	2624980000	B.6
TGD FIM-C	2625000000	B.4

W

WEW 35/1 SW	1162600000	A.40
WEW 35/1 SW	1162600000	A.53
WEW 35/1 SW	1162600000	A.64
WEW 35/1 SW	1162600000	A.98
WEW 35/1 SW	1162600000	C.6
WEW 35/2 SW	1061210000	B.34
WEW 35/2 VO GF SW	1479000000	B.34

Z

ZQV 4N/10	1528090000	B.34
ZQV 4N/10 BL	1528230000	B.34
ZQV 4N/10 RD	2460740000	B.34
ZQV 4N/2	1527930000	B.21
ZQV 4N/2	1527930000	B.22
ZQV 4N/2	1527930000	B.23
ZQV 4N/2	1527930000	B.31
ZQV 4N/2	1527930000	B.32
ZQV 4N/2	1527930000	B.33
ZQV 4N/2	1527930000	B.34
ZQV 4N/2 BL	1528040000	B.21
ZQV 4N/2 BL	1528040000	B.22
ZQV 4N/2 BL	1528040000	B.23
ZQV 4N/2 BL	1528040000	B.31
ZQV 4N/2 BL	1528040000	B.32
ZQV 4N/2 BL	1528040000	B.33
ZQV 4N/2 BL	1528040000	B.34
ZQV 4N/2 RD	2460450000	B.21
ZQV 4N/2 RD	2460450000	B.22
ZQV 4N/2 RD	2460450000	B.23
ZQV 4N/2 RD	2460450000	B.31
ZQV 4N/2 RD	2460450000	B.32
ZQV 4N/2 RD	2460450000	B.33
ZQV 4N/2 RD	2460450000	B.34
ZQV 4N/3	1527940000	B.34
ZQV 4N/3 BL	1528080000	B.34
ZQV 4N/3 RD	2460810000	B.34
ZQV 4N/4	1527970000	B.34
ZQV 4N/4 BL	1528120000	B.34
ZQV 4N/4 RD	2460800000	B.34
ZQV 4N/5	1527980000	B.34
ZQV 4N/5 BL	1528140000	B.34
ZQV 4N/5 RD	2460790000	B.34
ZQV 4N/50	1528130000	B.21
ZQV 4N/50	1528130000	B.22
ZQV 4N/50	1528130000	B.23
ZQV 4N/50	1528130000	B.31
ZQV 4N/50	1528130000	B.32
ZQV 4N/50	1528130000	B.33
ZQV 4N/50	1528130000	B.34
ZQV 4N/50 BL	1528240000	B.21
ZQV 4N/50 BL	1528240000	B.22

Type	Order No.	Page
ZQV 4N/50 BL	1528240000	B.23
ZQV 4N/50 BL	1528240000	B.31
ZQV 4N/50 BL	1528240000	B.32
ZQV 4N/50 BL	1528240000	B.33
ZQV 4N/50 BL	1528240000	B.34
ZQV 4N/50 RD	2460730000	B.21
ZQV 4N/50 RD	2460730000	B.22
ZQV 4N/50 RD	2460730000	B.23
ZQV 4N/50 RD	2460730000	B.31
ZQV 4N/50 RD	2460730000	B.32
ZQV 4N/50 RD	2460730000	B.33
ZQV 4N/50 RD	2460730000	B.34
ZQV 4N/6	1527990000	B.34
ZQV 4N/6 BL	1528170000	B.34
ZQV 4N/6 RD	2460780000	B.34
ZQV 4N/7	1528020000	B.34
ZQV 4N/7 BL	1528180000	B.34
ZQV 4N/7 RD	2460770000	B.34
ZQV 4N/8	1528030000	B.34
ZQV 4N/8 BL	1528190000	B.34
ZQV 4N/8 RD	2460760000	B.34
ZQV 4N/9	1528070000	B.34
ZQV 4N/9 BL	1528220000	B.34
ZQV 4N/9 RD	2460750000	B.34

Order No.	Type	Page
-----------	------	------

1060000000

1061210000	WEW 35/2 SW	B.34
------------	-------------	------

1150000000

1157820000	KT 14	B.34
------------	-------	------

1160000000

1162600000	WEW 35/1 SW	A.40
1162600000	WEW 35/1 SW	A.53
1162600000	WEW 35/1 SW	A.64
1162600000	WEW 35/1 SW	A.98
1162600000	WEW 35/1 SW	C.6
1168970000	MTA 30 BK	A.40
1168970000	MTA 30 BK	A.53
1168970000	MTA 30 BK	A.64
1168970000	MTA 30 BK	C.6

1240000000

1248580000	SM 18/9.5 K MC NE WS	A.40
1248580000	SM 18/9.5 K MC NE WS	A.53
1248580000	SM 18/9.5 K MC NE WS	A.64
1248580000	SM 18/9.5 K MC NE WS	A.98
1248580000	SM 18/9.5 K MC NE WS	C.6

1250000000

1251310000	MTA 45 MF	A.40
1251310000	MTA 45 MF	A.53
1251310000	MTA 45 MF	A.64
1251310000	MTA 45 MF	C.6
1251320000	MTA 30 MF	A.40
1251320000	MTA 30 MF	A.53
1251320000	MTA 30 MF	A.64
1251320000	MTA 30 MF	C.6

1370000000

1370040010	CP DC UPS 24V 40A	C.5
1370040010	CP DC UPS 24V 40A	IX
1370050010	CP DC UPS 24V 20A/10A	C.5
1370050010	CP DC UPS 24V 20A/10A	IX

1440000000

1444480000	CP DC UPS TF05	C.6
1444540000	CP DC UPS TF25	C.6

1460000000

1461850000	CP A WALLADAPTER 45MM	A.40
1461850000	CP A WALLADAPTER 45MM	A.53
1461850000	CP A WALLADAPTER 45MM	A.64
1461850000	CP A WALLADAPTER 45MM	C.6
1461870000	CP A WALLADAPTER 30 MM	A.40
1461870000	CP A WALLADAPTER 30 MM	A.53
1461870000	CP A WALLADAPTER 30 MM	A.64
1461870000	CP A WALLADAPTER 30 MM	C.6
1469470000	PRO ECO 72W 24V 3A	A.57
1469470000	PRO ECO 72W 24V 3A	VII
1469480000	PRO ECO 120W 24V 5A	A.57
1469480000	PRO ECO 120W 24V 5A	VII
1469490000	PRO ECO 240W 24V 10A	A.58
1469490000	PRO ECO 240W 24V 10A	VII
1469510000	PRO ECO 480W 24V 20A	A.58
1469510000	PRO ECO 480W 24V 20A	VII
1469520000	PRO ECO 960W 24V 40A	A.59
1469520000	PRO ECO 960W 24V 40A	VII
1469530000	PRO ECO3 120W 24V 5A	A.62
1469530000	PRO ECO3 120W 24V 5A	VII
1469540000	PRO ECO3 240W 24V 10A	A.62
1469540000	PRO ECO3 240W 24V 10A	VII
1469550000	PRO ECO3 480W 24V 20A	A.63
1469550000	PRO ECO3 480W 24V 20A	VII
1469560000	PRO ECO3 960W 24V 40A	A.63
1469560000	PRO ECO3 960W 24V 40A	VII
1469570000	PRO ECO 72W 12V 6A	A.60
1469570000	PRO ECO 72W 12V 6A	VII
1469580000	PRO ECO 120W 12V 10A	A.60
1469580000	PRO ECO 120W 12V 10A	VII
1469590000	PRO ECO 240W 48V 5A	A.61
1469590000	PRO ECO 240W 48V 5A	VII
1469610000	PRO ECO 480W 48V 10A	A.61
1469610000	PRO ECO 480W 48V 10A	VII

1470000000

1478100000	PRO MAX 72W 24V 3A	A.45
1478100000	PRO MAX 72W 24V 3A	VII
1478110000	PRO MAX 120W 24V 5A	A.45
1478110000	PRO MAX 120W 24V 5A	VII
1478120000	PRO MAX 180W 24V 7.5A	A.46
1478120000	PRO MAX 180W 24V 7.5A	VII
1478130000	PRO MAX 240W 24V 10A	A.46
1478130000	PRO MAX 240W 24V 10A	VII
1478140000	PRO MAX 480W 24V 20A	A.47

Order No.	Type	Page
-----------	------	------

1478140000	PRO MAX 480W 24V 20A	VII
1478150000	PRO MAX 960W 24V 40A	A.47
1478150000	PRO MAX 960W 24V 40A	VII
1478170000	PRO MAX3 120W 24V 5A	A.51
1478170000	PRO MAX3 120W 24V 5A	VII
1478180000	PRO MAX3 240W 24V 10A	A.51
1478180000	PRO MAX3 240W 24V 10A	VII
1478190000	PRO MAX3 480W 24V 20A	A.52
1478190000	PRO MAX3 480W 24V 20A	VII
1478200000	PRO MAX3 960W 24V 40A	A.52
1478200000	PRO MAX3 960W 24V 40A	VII
1478210000	PRO MAX 70W 5V 14A	A.48
1478210000	PRO MAX 70W 5V 14A	VII
1478220000	PRO MAX 72W 12V 6A	A.48
1478220000	PRO MAX 72W 12V 6A	VII
1478230000	PRO MAX 120W 12V 10A	A.49
1478230000	PRO MAX 120W 12V 10A	VII
1478240000	PRO MAX 240W 48V 5A	A.49
1478240000	PRO MAX 240W 48V 5A	VII
1478250000	PRO MAX 480W 48V 10A	A.50
1478270000	PRO MAX 960W 48V 20A	A.50
1478270000	PRO MAX 960W 48V 20A	VII
1479000000	WEW 35/2 VO GF SW	B.34

1520000000

1527930000	ZQV 4N/2	B.21
1527930000	ZQV 4N/2	B.22
1527930000	ZQV 4N/2	B.23
1527930000	ZQV 4N/2	B.31
1527930000	ZQV 4N/2	B.32
1527930000	ZQV 4N/2	B.33
1527930000	ZQV 4N/2	C.6
1527940000	ZQV 4N/3	B.34
1527970000	ZQV 4N/4	B.34
1527980000	ZQV 4N/5	B.34
1527990000	ZQV 4N/6	B.34
1528020000	ZQV 4N/7	B.34
1528030000	ZQV 4N/8	B.34
1528040000	ZQV 4N/2 BL	B.21
1528040000	ZQV 4N/2 BL	B.22
1528040000	ZQV 4N/2 BL	B.23
1528040000	ZQV 4N/2 BL	B.31
1528040000	ZQV 4N/2 BL	B.32
1528040000	ZQV 4N/2 BL	B.33
1528040000	ZQV 4N/2 BL	B.34
1528070000	ZQV 4N/9	B.34
1528080000	ZQV 4N/3 BL	B.34
1528090000	ZQV 4N/10	B.34
1528120000	ZQV 4N/4 BL	B.34
1528130000	ZQV 4N/50	B.21
1528130000	ZQV 4N/50	B.22
1528130000	ZQV 4N/50	B.23
1528130000	ZQV 4N/50	B.31
1528130000	ZQV 4N/50	B.32
1528130000	ZQV 4N/50	B.33
1528130000	ZQV 4N/50	B.34
1528140000	ZQV 4N/5 BL	B.34
1528170000	ZQV 4N/6 BL	B.34
1528180000	ZQV 4N/7 BL	B.34
1528190000	ZQV 4N/8 BL	B.34
1528220000	ZQV 4N/9 BL	B.34
1528230000	ZQV 4N/10 BL	B.34
1528240000	ZQV 4N/50 BL	B.21
1528240000	ZQV 4N/50 BL	B.22
1528240000	ZQV 4N/50 BL	B.23
1528240000	ZQV 4N/50 BL	B.31
1528240000	ZQV 4N/50 BL	B.32
1528240000	ZQV 4N/50 BL	B.33
1528240000	ZQV 4N/50 BL	B.34

1960000000

1962250000	MTA 45 BK	A.40
1962250000	MTA 45 BK	A.53
1962250000	MTA 45 BK	A.64
1962250000	MTA 45 BK	C.6

2000000000

2001800000	PRO DCDC 120W 24V 5A	D.5
2001800000	PRO DCDC 120W 24V 5A	IX
2001810000	PRO DCDC 240W 24V 10A	D.5
2001810000	PRO DCDC 240W 24V 10A	IX
2001820000	PRO DCDC 480W 24V 20A	D.6
2001820000	PRO DCDC 480W 24V 20A	IX

2080000000

2080360000	AMG ELM-6	B.17
2080410000	AMG ELM-1F	B.18
2080420000	AMG ELM-1F	B.19
2080480000	AMG ELM-2F	B.14
2080490000	AMG ELM-4F	B.14
2080500000	AMG ELM-6F	B.14
2080600000	AMG ELM-8F	B.15
2080650000	AMG ELM-10F	B.15
2081870000	AMG FIM-O	B.12
2081880000	AMG FIM-C	B.13

Order No.	Type	Page
-----------	------	------

2081890000	AMG AM	B.21
2081900000	AMG CM	B.22
2082000000	AMG ELM-6 EX	B.28
2082010000	AMG ELM-12 EX	B.29
2082040000	AMG ELM-1F EX	B.26
2082050000	AMG ELM-2F EX	B.26
2082060000	AMG ELM-4F EX	B.26
2082310000	AMG ELM-6F EX	B.26
2082320000	AMG ELM-8F EX	B.27
2082430000	AMG ELM-10F EX	B.27
2082440000	AMG ELM-6D CO	B.20
2082470000	AMG ELM-10D CO	B.20
2082530000	AMG FIM-O EX	B.24
2082540000	AMG FIM-C EX	B.25
2082770000	AMG AM CO	B.31
2083360000	AMG CM EX	B.32

2120000000

2122910000	AMG OD	B.14
2122910000	AMG OD	B.15
2122910000	AMG OD	B.16
2122910000	AMG OD	B.17
2122910000	AMG OD	B.18
2122910000	AMG OD	B.20
2122910000	AMG OD	B.23
2122910000	AMG OD	B.5
2122910000	AMG OD	B.6
2122910000	AMG OD	B.7
2122920000	AMG PD	B.14
2122920000	AMG PD	B.15
2122920000	AMG PD	B.16
2122920000	AMG PD	B.17
2122920000	AMG PD	B.18
2122920000	AMG PD	B.20
2122920000	AMG PD	B.23
2122920000	AMG PD	B.5
2122920000	AMG PD	B.6
2122920000	AMG PD	B.7
2122930000	AMG MD	B.14
2122930000	AMG MD	B.15
2122930000	AMG MD	B.17
2122930000	AMG MD	B.18
2122930000	AMG MD	B.20
2122930000	AMG MD	B.23
2122930000	AMG MD	B.5
2122930000	AMG MD	B.6
2122930000	AMG MD	B.7
2122940000	AMG XMD	B.23
2123000000	AMG PP	B.11
2123000000	AMG PP	B.34
2123050000	AMG DIS	B.14
2123050000	AMG DIS	B.15
2123050000	AMG DIS	B.16
2123050000	AMG DIS	B.17
2123050000	AMG DIS	B.18
2123050000	AMG DIS	B.20
2123050000	AMG DIS	B.23
2123050000	AMG DIS	B.5
2123050000	AMG DIS	B.6
2123050000	AMG DIS	B.7

2460000000

2460450000	ZQV 4N/2 RD	B.21
2460450000	ZQV 4N/2 RD	B.22
2460450000	ZQV 4N/2 RD	B.23
2460450000	ZQV 4N/2 RD	B.31
2460450000	ZQV 4N/2 RD	B.32
2460450000	ZQV 4N/2 RD	B.33
2460450000	ZQV 4N/2 RD	B.34
2460730000	ZQV 4N/50 RD	B.21
2460730000	ZQV 4N/50 RD	B.22
2460730000	ZQV 4N/50 RD	B.2

Order No.	Type	Page
2495080000	AMG XMD EX	B.30
2495080000	AMG XMD EX	B.33
2495090000	AMG OD EX	B.26
2495090000	AMG OD EX	B.27
2495090000	AMG OD EX	B.28
2495090000	AMG OD EX	B.29
2495090000	AMG OD EX	B.30
2495090000	AMG OD EX	B.33
2495100000	AMG DIS EX	B.26
2495100000	AMG DIS EX	B.27
2495100000	AMG DIS EX	B.28
2495100000	AMG DIS EX	B.29
2495100000	AMG DIS EX	B.30
2495100000	AMG DIS EX	B.33
2495380000	AMG EP 2010	B.34

2500000000

2500760000	AMG EP KIT	B.34
------------	------------	------

2560000000

2568970000	PRO TOP1 72W 24V 3A F	A.11
2568970000	PRO TOP1 72W 24V 3A F	VI
2568980000	PRO TOP1 120W 24V 5A F	A.12
2568980000	PRO TOP1 120W 24V 5A F	VI
2568990000	PRO TOP1 240W 24V 10A F	A.12
2568990000	PRO TOP1 240W 24V 10A F	VI
2569000000	PRO TOP1 120W 12V 10A F	A.11
2569000000	PRO TOP1 120W 12V 10A F	VI

2580000000

2580180000	PRO INSTA 16W 24V 0.7A	A.93
2580180000	PRO INSTA 16W 24V 0.7A	VIII
2580190000	PRO INSTA 30W 24V 1.3A	A.94
2580190000	PRO INSTA 30W 24V 1.3A	VIII
2580210000	PRO INSTA 30W 5V 6A	A.93
2580210000	PRO INSTA 30W 5V 6A	VIII
2580220000	PRO INSTA 30W 12V 2.6A	A.94
2580220000	PRO INSTA 30W 12V 2.6A	VIII
2580230000	PRO INSTA 60W 24V 2.5A	A.95
2580230000	PRO INSTA 60W 24V 2.5A	VIII
2580240000	PRO INSTA 60W 12V 5A	A.95
2580240000	PRO INSTA 60W 12V 5A	VIII
2580250000	PRO INSTA 90W 24V 3.8A	A.96
2580250000	PRO INSTA 90W 24V 3.8A	VIII
2580260000	PRO INSTA 96W 24V 4A	A.96
2580260000	PRO INSTA 96W 24V 4A	VIII
2580270000	PRO INSTA 96W 48V 2A	A.97
2580270000	PRO INSTA 96W 48V 2A	VIII
2587360000	PRO CDM IO-LINK	B.4
2587360000	PRO CDM IO-LINK	F.5

2620000000

2624980000	TGD ELM-6	B.6
2624990000	TGD ELM-12	B.5
2625000000	TGD FIM-C	B.4
2627630000	PRO TOPDC 24V/24V 20A	A.30
2627630000	PRO TOPDC 24V/24V 20A	VI
2627640000	PRO TOPDC 24V/24V 10A	A.29
2627640000	PRO TOPDC 24V/24V 10A	VI
2627650000	PRO TOPDC 24V/24V 5A	A.29
2627650000	PRO TOPDC 24V/24V 5A	VI
2627660000	PRO TOPDC 24V/48V 10A	A.30
2627660000	PRO TOPDC 24V/48V 10A	VI

2650000000

2656670000	TGD ELM-4 CL2	B.7
------------	---------------	-----

2660000000

2660200277	PRO PM 35W 5V 7A	A.78
2660200277	PRO PM 35W 5V 7A	VIII
2660200278	PRO PM 35W 12V 3A	A.78
2660200278	PRO PM 35W 12V 3A	VIII
2660200279	PRO PM 35W 24V 1.5A	A.79
2660200279	PRO PM 35W 24V 1.5A	VIII
2660200280	PRO PM 35W 48V 0.75A	A.79
2660200280	PRO PM 35W 48V 0.75A	VIII
2660200281	PRO PM 75W 5V 14A	A.80
2660200281	PRO PM 75W 5V 14A	VIII
2660200282	PRO PM 75W 12V 6A	A.80
2660200282	PRO PM 75W 12V 6A	VIII
2660200283	PRO PM 75W 24V 3.2A	A.81
2660200283	PRO PM 75W 24V 3.2A	VIII
2660200284	PRO PM 75W 48V 1.6A	A.81
2660200284	PRO PM 75W 48V 1.6A	VIII
2660200285	PRO PM 100W 12V 8.5A	A.82
2660200285	PRO PM 100W 12V 8.5A	VIII
2660200286	PRO PM 100W 24V 4.5A	A.82
2660200286	PRO PM 100W 24V 4.5A	VIII
2660200287	PRO PM 100W 48V 2.3A	A.83
2660200287	PRO PM 100W 48V 2.3A	VIII
2660200288	PRO PM 150W 12V 12.5A	A.84
2660200288	PRO PM 150W 12V 12.5A	VIII
2660200289	PRO PM 150W 24V 6.5A	A.84

Order No.	Type	Page
2660200289	PRO PM 150W 24V 6.5A	VIII
2660200290	PRO PM 150W 48V 3.3A	A.85
2660200290	PRO PM 150W 48V 3.3A	VIII
2660200291	PRO PM 250W 12V 21A	A.86
2660200291	PRO PM 250W 12V 21A	VIII
2660200292	PRO PM 250W 24V 10.5A	A.86
2660200292	PRO PM 250W 24V 10.5A	VIII
2660200293	PRO PM 250W 48V 5.2A	A.87
2660200293	PRO PM 250W 48V 5.2A	VIII
2660200294	PRO PM 350W 24V 14.6A	A.88
2660200294	PRO PM 350W 24V 14.6A	VIII
2660200295	PRO PM 350W 48V 7.3A	A.88
2660200295	PRO PM 350W 48V 7.3A	VIII

2740000000

2749800000	SDIS 0.5X3.0X100	A.40
2749800000	SDIS 0.5X3.0X100	A.53
2749800000	SDIS 0.5X3.0X100	A.64
2749800000	SDIS 0.5X3.0X100	A.98
2749800000	SDIS 0.5X3.0X100	C.6
2749850000	SDIS 1.0X5.5X125	A.53
2749850000	SDIS 1.0X5.5X125	C.6
2749890000	SDIK PH1 X 80	A.40
2749890000	SDIK PH1 X 80	A.53
2749890000	SDIK PH1 X 80	A.64

2780000000

2786240000	PRO DC BUFFER 24V 20A	C.14
2786240000	PRO DC BUFFER 24V 20A	IX
2786250000	PRO DC BUFFER 24V 40A	C.14
2786250000	PRO DC BUFFER 24V 40A	IX
2789890000	DURA ECO LA-BAT 24V 1.2AH	C.10
2789890000	DURA ECO LA-BAT 24V 1.2AH	IX
2789900000	DURA ECO LA-BAT 24V 3.4AH	C.10
2789900000	DURA ECO LA-BAT 24V 3.4AH	IX
2789910000	DURA ECO LA-BAT 24V 7AH	C.11
2789910000	DURA ECO LA-BAT 24V 7AH	IX
2789920000	DURA ECO LA-BAT 24V 12AH	C.11
2789920000	DURA ECO LA-BAT 24V 12AH	IX
2789930000	DURA ECO LA-BAT 24V 17AH	C.11
2789930000	DURA ECO LA-BAT 24V 17AH	IX

2830000000

2838400000	PRO BAS 30W 5V 6A	A.70
2838400000	PRO BAS 30W 5V 6A	VII
2838410000	PRO BAS 60W 24V 2.5A	A.70
2838410000	PRO BAS 60W 24V 2.5A	VII
2838420000	PRO BAS 60W 12V 5A	A.71
2838420000	PRO BAS 60W 12V 5A	VII
2838430000	PRO BAS 90W 24V 3.8A	A.71
2838430000	PRO BAS 90W 24V 3.8A	VII
2838440000	PRO BAS 120W 24V 5A	A.72
2838440000	PRO BAS 120W 24V 5A	VII
2838450000	PRO BAS 120W 12V 10A	A.72
2838450000	PRO BAS 120W 12V 10A	VII
2838460000	PRO BAS 240W 24V 10A	A.73
2838460000	PRO BAS 240W 24V 10A	VII
2838470000	PRO BAS 240W 48V 5A	A.73
2838470000	PRO BAS 240W 48V 5A	VII
2838480000	PRO BAS 480W 24V 20A	A.74
2838480000	PRO BAS 480W 24V 20A	VII
2838490000	PRO BAS 480W 48V 10A	A.74
2838490000	PRO BAS 480W 48V 10A	VII
2838500000	PRO BAS 30W 24V 1.3A	A.69
2838500000	PRO BAS 30W 24V 1.3A	VII
2838510000	PRO BAS 30W 12V 2.6A	A.69
2838510000	PRO BAS 30W 12V 2.6A	VII
2838520000	AMG ELM-18 EX	B.30

2850000000

2859800000	AMG ELM-18	B.19
------------	------------	------

Addresses worldwide

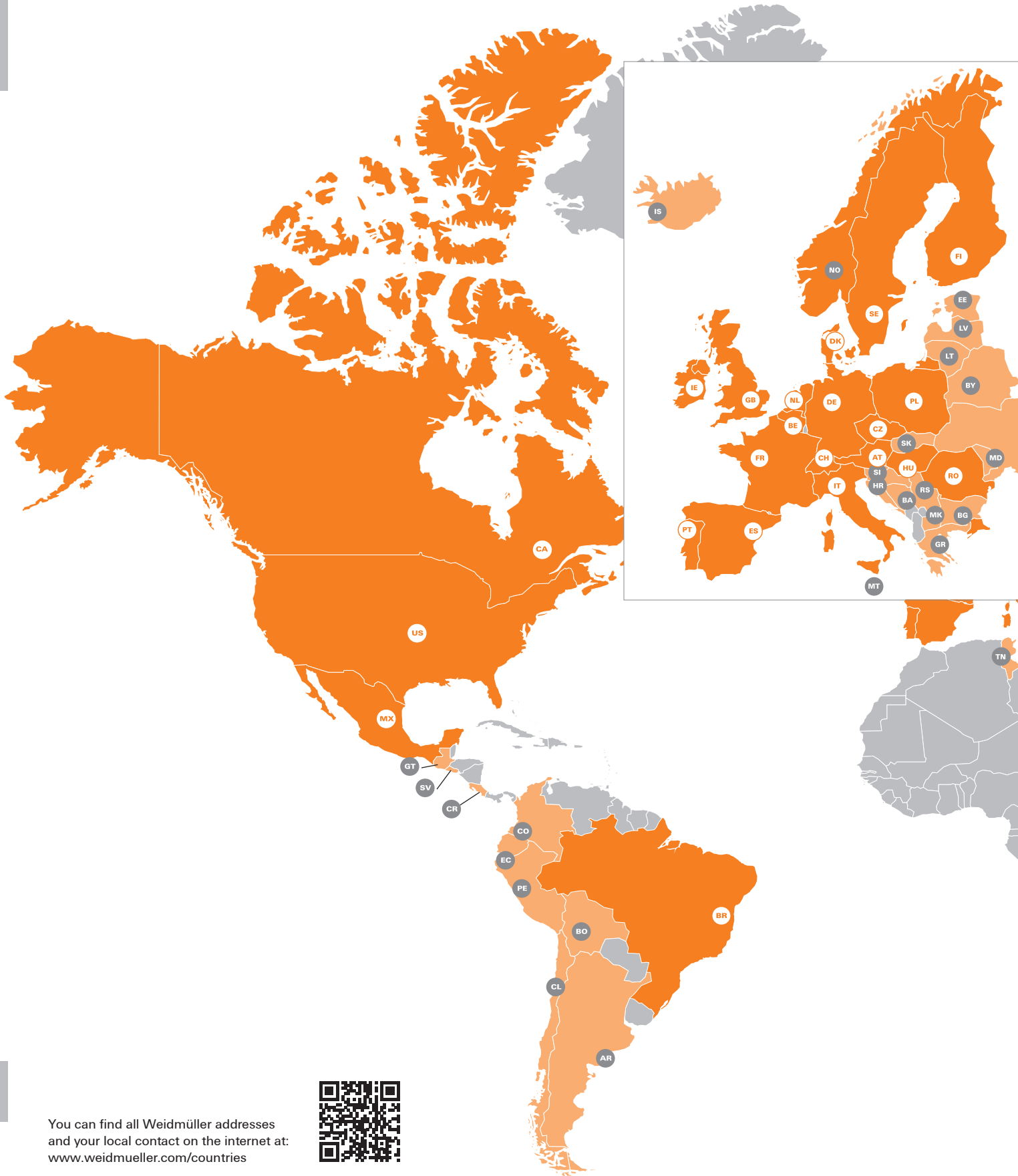

X

You can find all Weidmüller addresses and your local contact on the internet at: www.weidmueller.com/countries



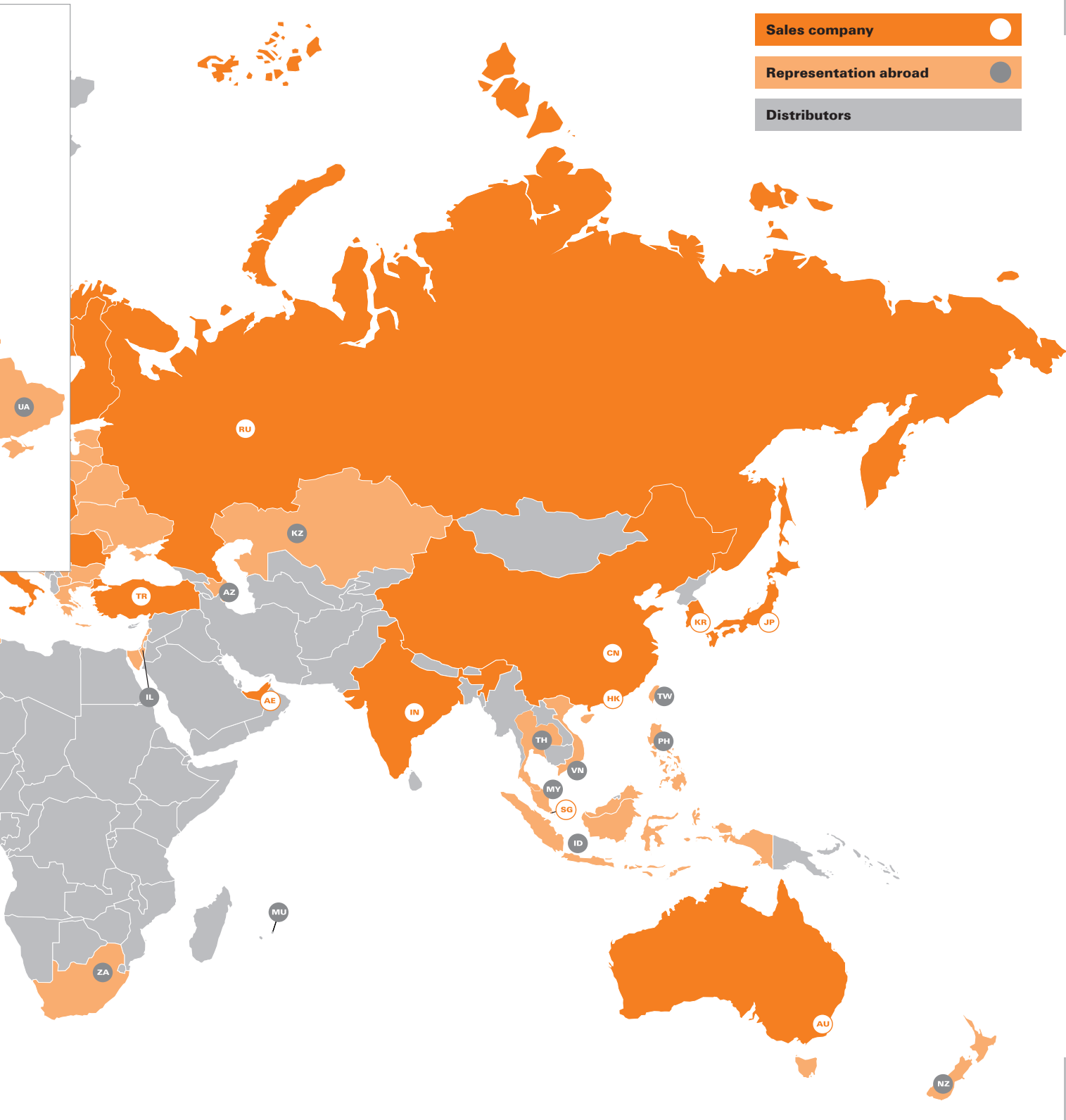

We cannot guarantee that there are no mistakes in the publications or software provided by us to the customer for the purpose of making orders. We try our best to quickly correct errors in our printed media.

X

All orders are based on our general terms of delivery, which can be reviewed on the websites of our group companies where you place your order. On demand we can also send the general terms of delivery to you.

Weidmüller – Your partner in Industrial Connectivity

As experienced experts we support our customers and partners around the world with products, solutions and services in the industrial environment of power, signal and data. We are at home in their industries and markets and know the technological challenges of tomorrow. We are therefore continuously developing innovative, sustainable and useful solutions for their individual needs. Together we set standards in Industrial Connectivity.

Weidmüller Interface GmbH & Co. KG
Klingenbergstraße 26
32758 Detmold, Germany
T +49 5231 14-0
F +49 5231 14-292083
www.weidmueller.com

Personal support can
be found on our website:
www.weidmueller.com/contact

Made in Germany



Order Number: 2896140000/12/2022/SMD