

**PLEASE CHECK WWW.MOLEX.COM FOR LATEST PART INFORMATION**

**Part Number:** [44300-2000](#)  
**Status:** **Active**  
**Overview:** Micro-Fit 3.0™ Connectors  
**Description:** Micro-Fit BMI™ Plug Housing, Dual Row, Panel Mount, 20 Circuits

**Documents:**

<a href="#">3D Model</a>	<a href="#">Test Summary TS-44300-001 (PDF)</a>
<a href="#">Drawing (PDF)</a>	<a href="#">RoHS Certificate of Compliance (PDF)</a>
<a href="#">Product Specification PS-44300-001 (PDF)</a>	<a href="#">Product Literature (PDF)</a>
<a href="#">Packaging Specification PK-44300-001 (PDF)</a>	

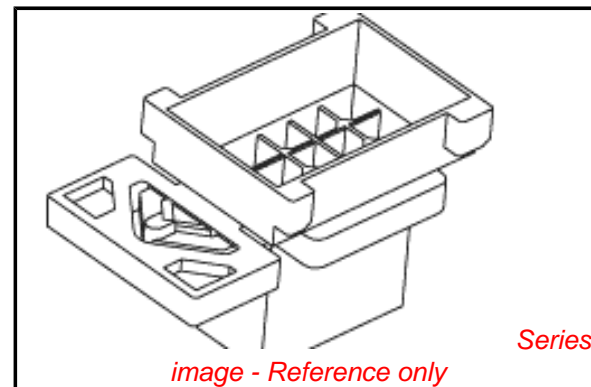

image - Reference only

**Agency Certification**

CSA	LR19980
TUV	R72081037
UL	E29179

**General**

Product Family	Crimp Housings
Series	<a href="#">44300</a>
Application	Power, Wire-to-Board, Wire-to-Wire
Overview	<a href="#">Micro-Fit 3.0™ Connectors</a>
Product Literature Order No	987650-5984
Product Name	Micro-Fit BMI™
UPC	800753281967

**Physical**

Circuits (maximum)	20
Color - Resin	Black
Flammability	94V-0
Gender	Male
Glow-Wire Compliant	No
Lock to Mating Part	No
Material - Resin	Polyester
Net Weight	4.581/g
Number of Rows	2
Packaging Type	Bag
Panel Mount	Yes
Pitch - Mating Interface	3.00mm
Polarized to Mating Part	Yes
Stackable	No
Temperature Range - Operating	-40°C to +105°C

**Electrical**

Current - Maximum per Contact	5A
-------------------------------	----

**Material Info**

**Reference - Drawing Numbers**

Packaging Specification	PK-44300-001
Product Specification	PS-44300-001, RPS-44300-001
Sales Drawing	SD-44300-001
Test Summary	TS-44300-001

<b>EU RoHS</b> <b>ELV and RoHS</b> <b>Compliant</b> <b>REACH SVHC</b> <b>Contains SVHC: No</b> <b>Low-Halogen Status</b> <b>Not Low-Halogen</b>	<b>China RoHS</b> 
---	--

**Need more information on product environmental compliance?**

Email [productcompliance@molex.com](mailto:productcompliance@molex.com)  
For a multiple part number RoHS Certificate of Compliance, [click here](#)

Please visit the [Contact Us](#) section for any non-product compliance questions.

**Search Parts in this Series**

44300Series

**Mates With**

44133 , 44764 , 44769

**Use With**

43031 Micro-Fit 3.0™ Male Crimp Terminals