

Datasheet

Header with 180° (Straight) Pins for Vertical Mounting

RS Stock number 458-459

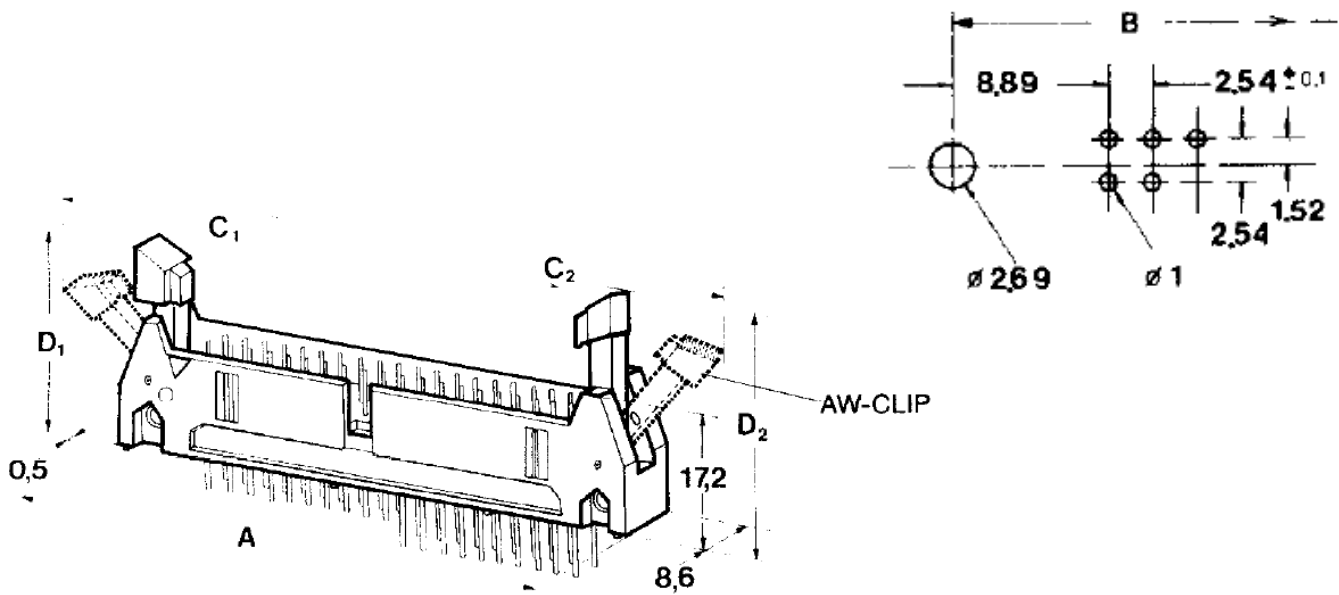

Stock no.	No. of Ways	A	B	C ₁	C ₂	D ₁	D ₂
458-409	14	37.3	33.0	49.5	55.0	23.1	26.5
458-415	16	39.9	35.6	52.1	57.6	23.1	26.5
458-421	20	44.8	40.6	57.0	62.5	23.1	26.5
458-437	26	52.4	48.3	64.6	70.1	23.1	26.5
458-443	34	62.6	58.4	74.8	80.3	23.1	26.5
458-459	40	70.2	66.0	82.4	87.9	23.1	26.5
458-465	50	83.0	78.7	95.2	100.7	23.1	26.5



ENGLISH

Specifications:

Insulators:	Polyester GV, VO, UL 94, colour grey, RAL 7035
Operating Temperature Range:	-65 to +150
Current Carrying Capacity:	1A
Tensile Strength:	1000Veff
Contacts:	Phosphor Bronze