

FCP13N60N / FCPF13N60NT

N-Channel MOSFET

600V, 13A, 0.258Ω

Features

- $R_{DS(on)} = 0.244\Omega$ (Typ.) @ $V_{GS} = 10V$, $I_D = 6.5A$
- Ultra Low Gate Charge (Typ. $Q_g = 30.4nC$)
- Low Effective Output Capacitance
- 100% Avalanche Tested
- RoHS Compliant

Description

The SupreMOS MOSFET, Fairchild's next generation of high voltage super-junction MOSFETs, employs a deep trench filling process that differentiates it from preceding multi-epi based technologies. By utilizing this advanced technology and precise process control, SupreMOS provides world class R_{sp} , superior switching performance and ruggedness.

This SupreMOS MOSFET fits the industry's AC-DC SMPS requirements for PFC, server/telecom power, FPD TV power, ATX power, and industrial power applications.

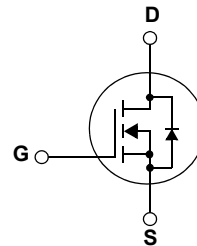
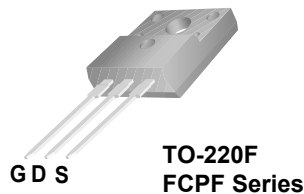
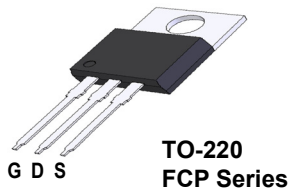

MOSFET Maximum Ratings $T_C = 25^\circ C$ unless otherwise noted

Symbol	Parameter	FCP13N60N	FCPF13N60NT	Units
V_{DSS}	Drain to Source Voltage	600		V
V_{GSS}	Gate to Source Voltage	±30		V
I_D	Drain Current	-Continuous ($T_C = 25^\circ C$)	13	13*
		-Continuous ($T_C = 100^\circ C$)	8.2	8.2*
I_{DM}	Drain Current	- Pulsed (Note 1)	39	39
E_{AS}	Single Pulsed Avalanche Energy (Note 2)	235		mJ
I_{AR}	Avalanche Current	4.3		A
E_{AR}	Repetitive Avalanche Energy	1.16		mJ
dv/dt	MOSFET dv/dt Ruggedness	100		V/ns
	Peak Diode Recovery dv/dt (Note 3)	20		V/ns
P_D	Power Dissipation	($T_C = 25^\circ C$)	116	33.8
		- Derate above $25^\circ C$	0.93	0.27
T_J, T_{STG}	Operating and Storage Temperature Range	-55 to +150		$^\circ C$
T_L	Maximum Lead Temperature for Soldering Purpose, 1/8" from Case for 5 Seconds	300		$^\circ C$

*Drain current limited by maximum junction temperature

Thermal Characteristics

Symbol	Parameter	FCP13N60N	FCPF13N60NT	Units
$R_{\theta JC}$	Thermal Resistance, Junction to Case	1.07	3.7	$^\circ C/W$
$R_{\theta CS}$	Thermal Resistance, Case to Heat Sink (Typical)	0.5	0.5	
$R_{\theta JA}$	Thermal Resistance, Junction to Ambient	62.5	62.5	

Package Marking and Ordering Information

Device Marking	Device	Package	Reel Size	Tape Width	Quantity
FCP13N60N	FCP13N60N	TO-220	-	-	50
FCPF13N60NT	FCPF13N60NT	TO-220F	-	-	50

Electrical Characteristics $T_C = 25^\circ\text{C}$ unless otherwise noted

Symbol	Parameter	Test Conditions	Min.	Typ.	Max.	Units
--------	-----------	-----------------	------	------	------	-------

Off Characteristics

BV_{DSS}	Drain to Source Breakdown Voltage	$I_D = 1\text{mA}, V_{GS} = 0\text{V}, T_C = 25^\circ\text{C}$	600	-	-	V
$\frac{\Delta BV_{DSS}}{\Delta T_J}$	Breakdown Voltage Temperature Coefficient	$I_D = 1\text{mA}$, Referenced to 25°C	-	0.73	-	$\text{V}/^\circ\text{C}$
I_{DSS}	Zero Gate Voltage Drain Current	$V_{DS} = 480\text{V}, V_{GS} = 0\text{V}$	-	-	10	μA
		$V_{DS} = 480\text{V}, V_{GS} = 0\text{V}, T_C = 125^\circ\text{C}$	-	-	100	
I_{GSS}	Gate to Body Leakage Current	$V_{GS} = \pm 30\text{V}, V_{DS} = 0\text{V}$	-	-	± 100	nA

On Characteristics

$V_{GS(th)}$	Gate Threshold Voltage	$V_{GS} = V_{DS}, I_D = 250\mu\text{A}$	2.0	-	4.0	V
$R_{DS(on)}$	Static Drain to Source On Resistance	$V_{GS} = 10\text{V}, I_D = 6.5\text{A}$	-	0.244	0.258	Ω
g_{FS}	Forward Transconductance	$V_{DS} = 40\text{V}, I_D = 6.5\text{A}$	-	16.3	-	S

Dynamic Characteristics

C_{iss}	Input Capacitance	$V_{DS} = 100\text{V}, V_{GS} = 0\text{V}$ $f = 1\text{MHz}$	-	1325	1765	pF
C_{oss}	Output Capacitance		-	50	65	pF
C_{riss}	Reverse Transfer Capacitance		-	3	5	pF
C_{oss}	Output Capacitance	$V_{DS} = 380\text{V}, V_{GS} = 0\text{V}, f = 1\text{MHz}$	-	30	-	pF
$C_{oss,eff}$	Effective Output Capacitance	$V_{DS} = 0\text{V to } 480\text{V}, V_{GS} = 0\text{V}$	-	145	-	pF
$Q_{g(tot)}$	Total Gate Charge at 10V	$V_{DS} = 380\text{V}, I_D = 6.5\text{A}$ $V_{GS} = 10\text{V}$	-	30.4	39.5	nC
Q_{gs}	Gate to Source Gate Charge		-	6.0	-	nC
Q_{gd}	Gate to Drain "Miller" Charge		(Note 4)	-	9.5	-
ESR	Equivalent Series Resistance (G-S)	Drain Open	-	2.8	-	Ω

Switching Characteristics

$t_{d(on)}$	Turn-On Delay Time	$V_{DD} = 380\text{V}, I_D = 6.5\text{A}$ $R_G = 4.7\Omega$	-	14.5	39	ns
t_r	Turn-On Rise Time		-	10.6	31.2	ns
$t_{d(off)}$	Turn-Off Delay Time		-	45	100	ns
t_f	Turn-Off Fall Time		(Note 4)	-	9.8	29.6

Drain-Source Diode Characteristics

I_S	Maximum Continuous Drain to Source Diode Forward Current	-	-	13	A	
I_{SM}	Maximum Pulsed Drain to Source Diode Forward Current	-	-	39	A	
V_{SD}	Drain to Source Diode Forward Voltage	$V_{GS} = 0\text{V}, I_{SD} = 6.5\text{A}$	-	-	1.2	V
t_{rr}	Reverse Recovery Time	$V_{GS} = 0\text{V}, I_{SD} = 6.5\text{A}$	-	287	-	ns
Q_{rr}	Reverse Recovery Charge	$di_F/dt = 100\text{A}/\mu\text{s}$	-	3.5	-	μC

Notes:

1. Repetitive Rating: Pulse width limited by maximum junction temperature
2. $I_{AS} = 4.3\text{A}, R_G = 25\Omega$, Starting $T_J = 25^\circ\text{C}$
3. $I_{SD} \leq 13\text{A}, di/dt \leq 200\text{A}/\mu\text{s}, V_{DD} \leq BV_{DSS}$, Starting $T_J = 25^\circ\text{C}$
4. Essentially Independent of Operating Temperature Typical Characteristics

Typical Performance Characteristics

Figure 1. On-Region Characteristics

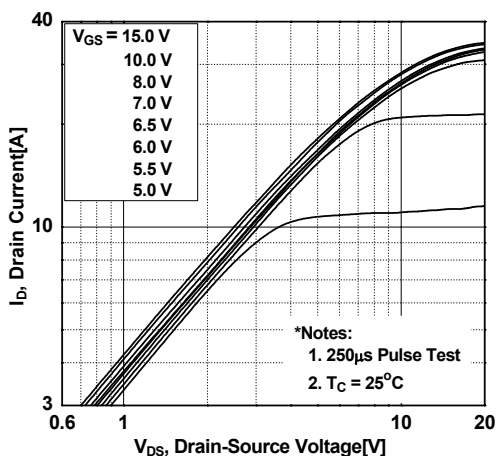

Figure 2. Transfer Characteristics

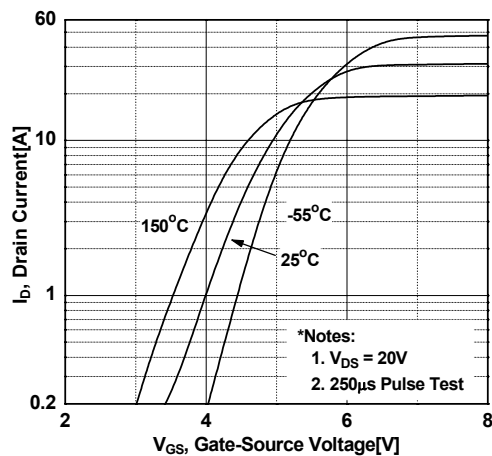

Figure 3. On-Resistance Variation vs. Drain Current and Gate Voltage

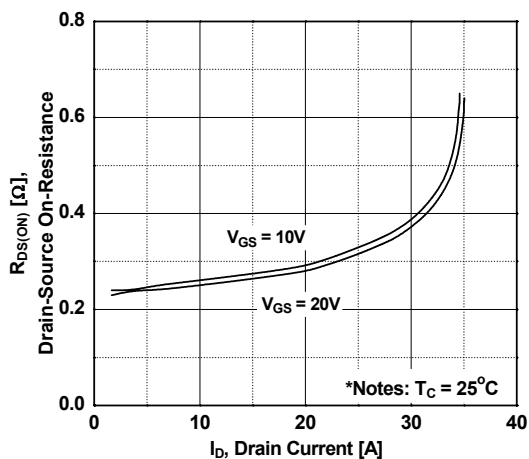

Figure 4. Body Diode Forward Voltage Variation vs. Source Current and Temperature

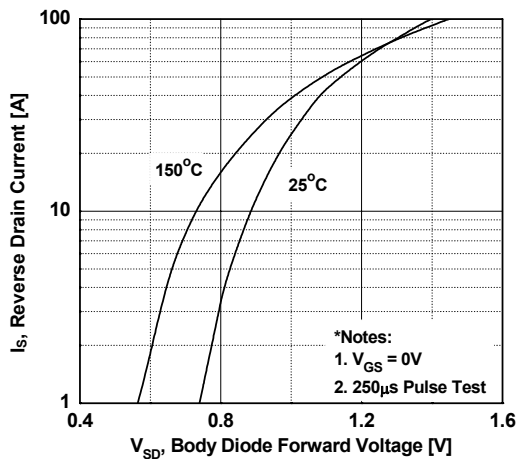

Figure 5. Capacitance Characteristics

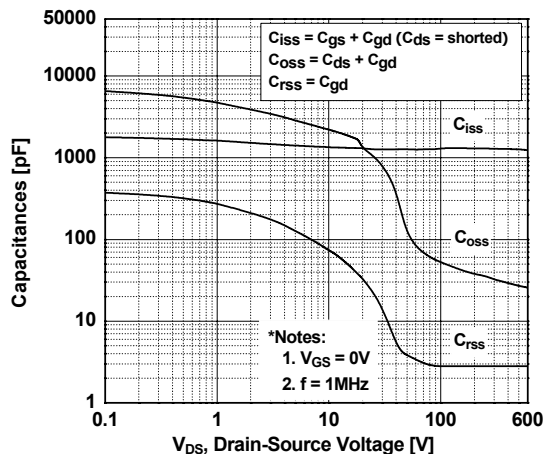
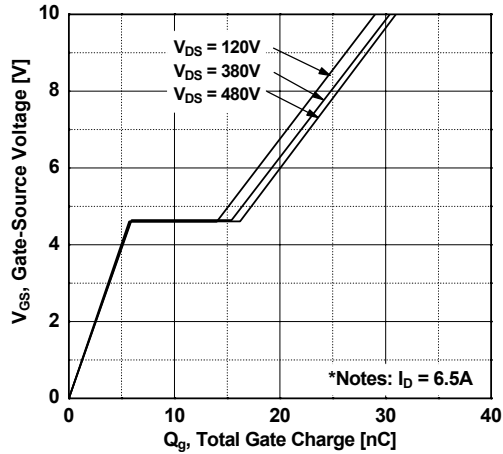

Figure 6. Gate Charge Characteristics



Typical Performance Characteristics (Continued)

Figure 7. Breakdown Voltage Variation vs. Temperature

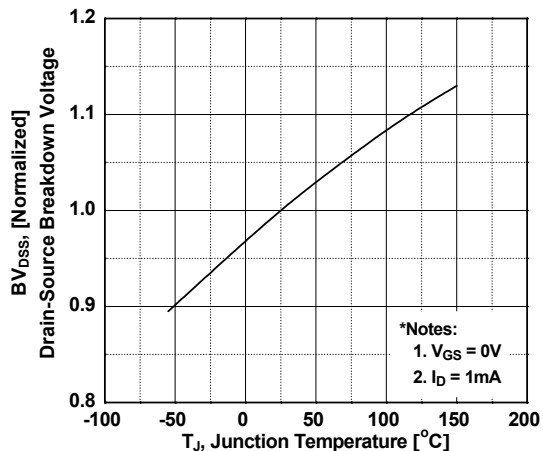

Figure 8. On-Resistance Variation vs. Temperature

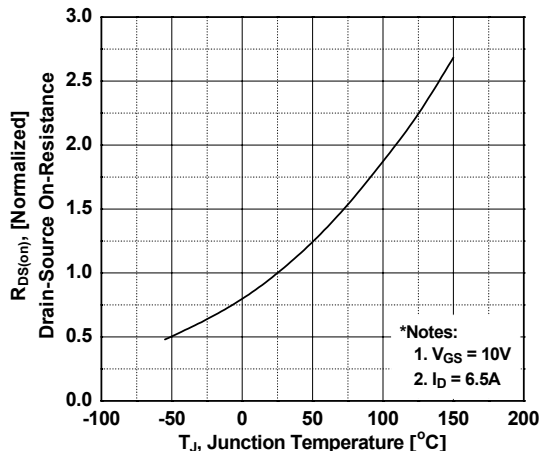

Figure 9. Maximum Safe Operating Area _ FCP13N60N

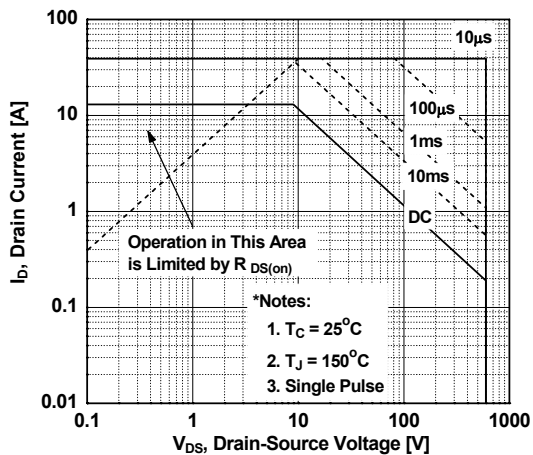

Figure 10. Maximum Safe Operating Area _ FCPF13N60NT

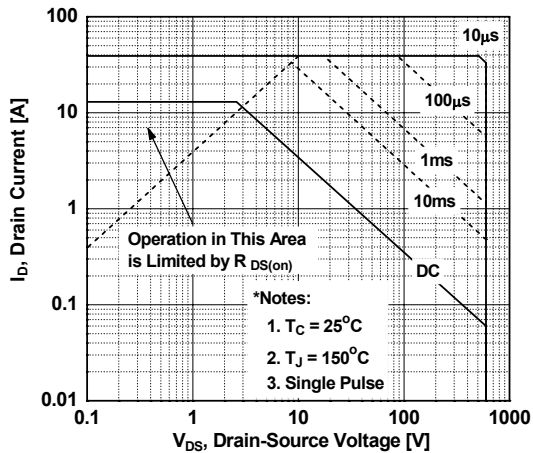
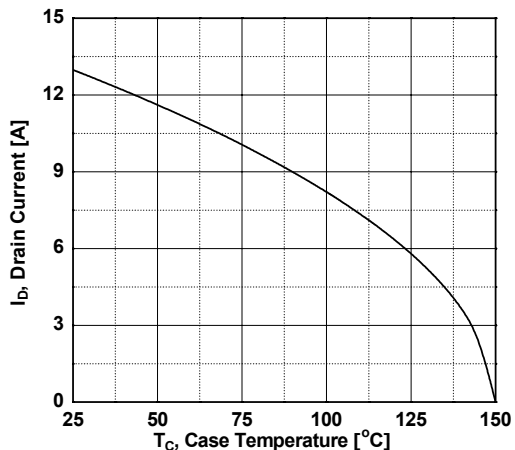

Figure 11. Maximum Drain Current vs. Case Temperature



Typical Performance Characteristics (Continued)

Figure 12. Transient Thermal Response Curve _ FCP13N60N

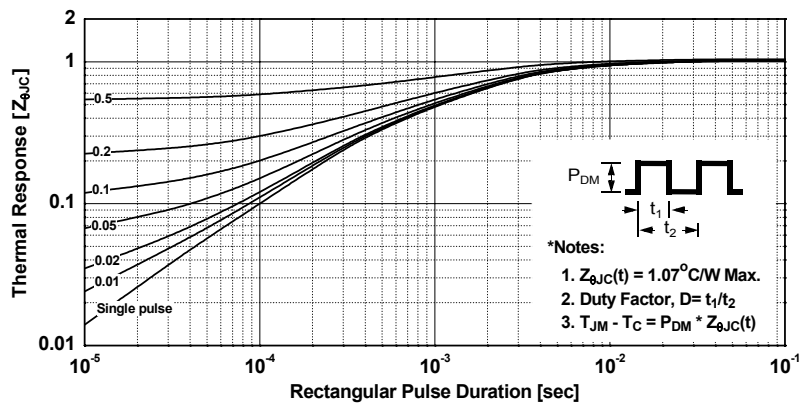
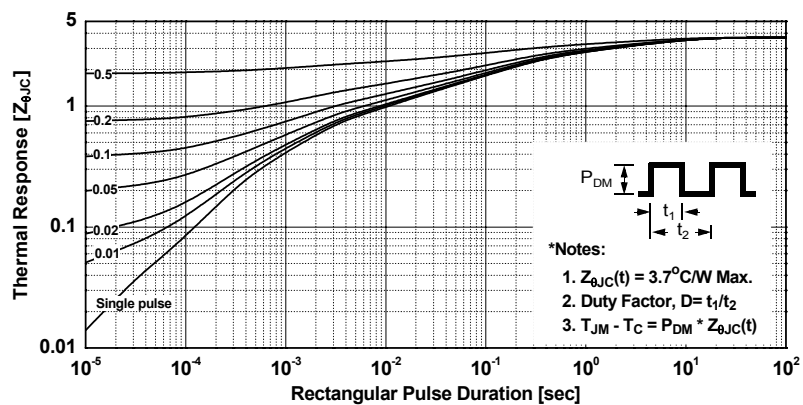
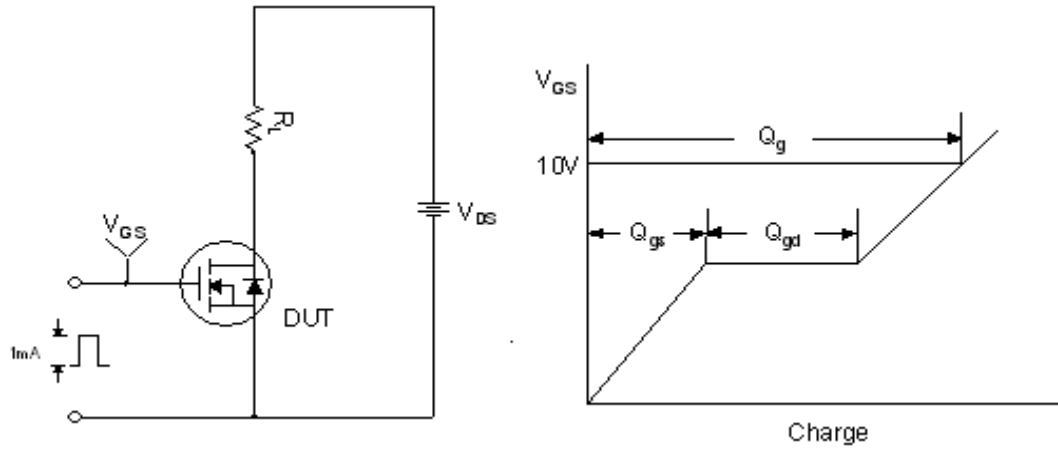

Figure 13. Transient Thermal Response Curve _ FCPF13N60NT



Gate Charge Test Circuit & Waveform



Resistive Switching Test Circuit & Waveforms

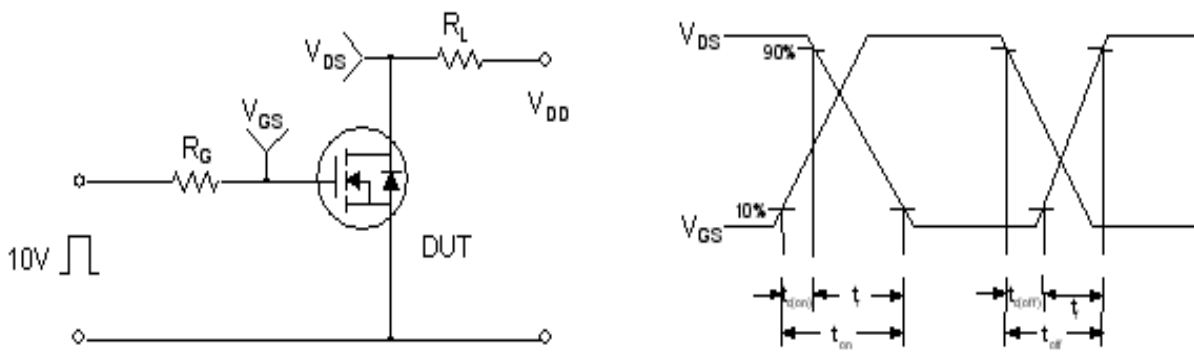

Unclamped Inductive Switching Test Circuit & Waveforms

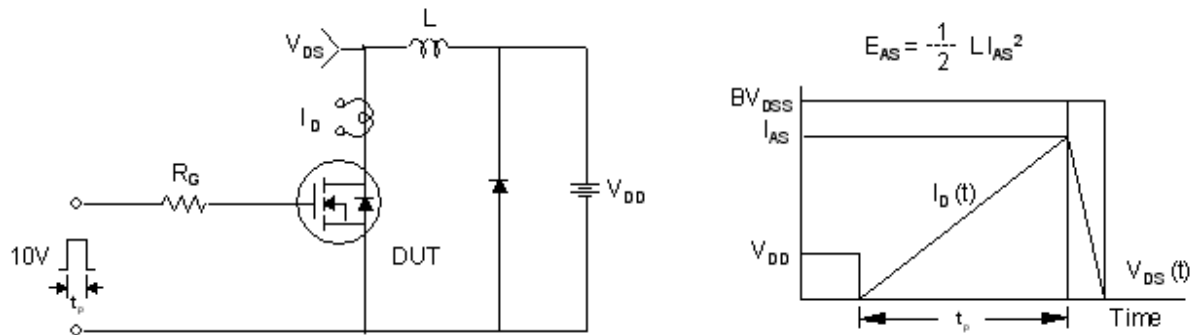

Peak Diode Recovery dv/dt Test Circuit & Waveforms

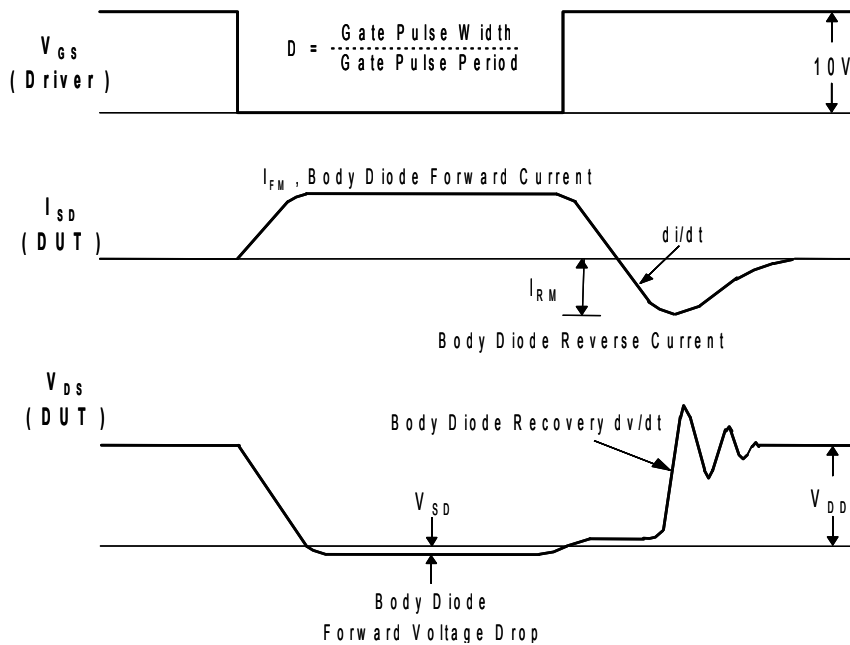
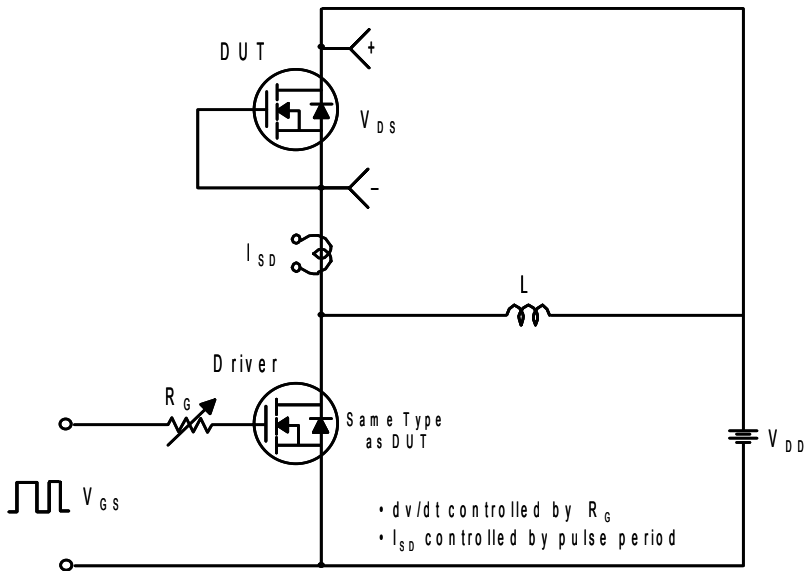

Mechanical Dimensions

TO-220

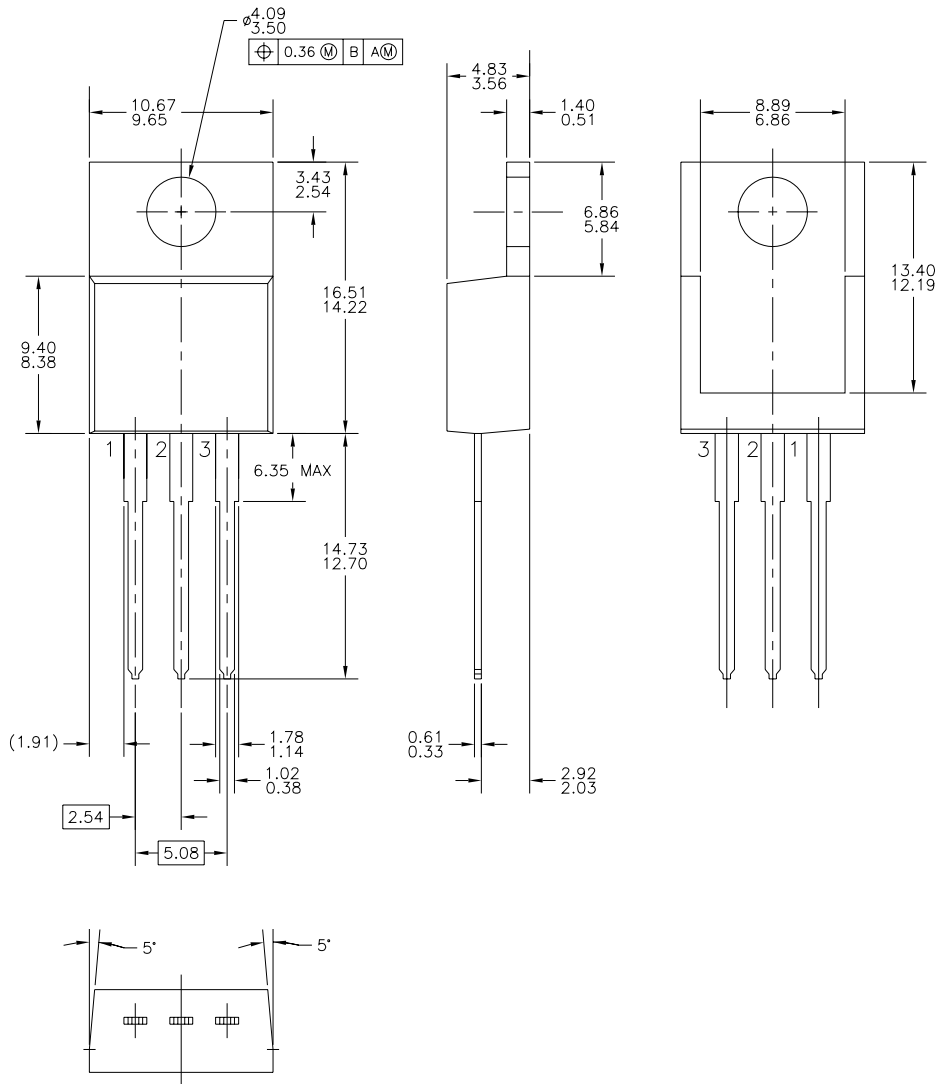

Dimensions in Millimeters

FCP13N60N / FCPF13N60NT N-Channel MOSFET

Mechanical Dimensions

TO-220F

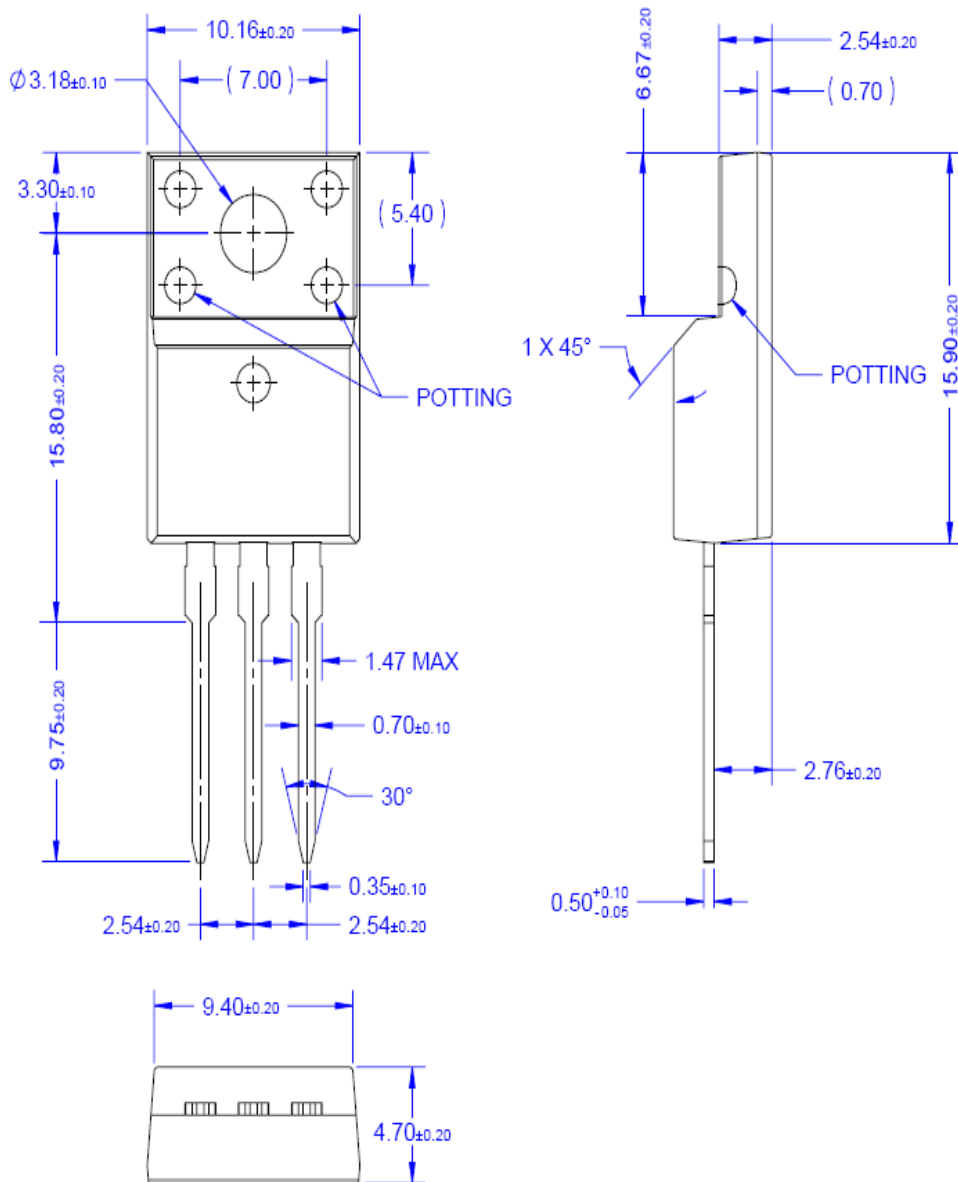





Dimensions in Millimeters



TRADEMARKS

The following includes registered and unregistered trademarks and service marks, owned by Fairchild Semiconductor and/or its global subsidiaries, and is not intended to be an exhaustive list of all such trademarks.

- | | | | |
|---|---|---|---|
| AccuPower™ | FPS™ | PowerTrench® | The Power Franchise® |
| Auto-SPM™ | F-PFS™ | PowerXS™ | the power® |
| Build it Now™ | FRFET® | Programmable Active Droop™ | franchise |
| CorePLUS™ | Global Power Resource SM | QFET® | TinyBoost™ |
| CorePOWER™ | Green FPS™ | QS™ | TinyBuck™ |
| CROSSVOLT™ | Green FPS™ e-Series™ | Quiet Series™ | TinyCalc™ |
| CTL™ | Gmax™ | RapidConfigure™ | TinyLogic® |
| Current Transfer Logic™ | GTO™ |  ™ | TINYOPTO™ |
| EcoSPARK® | IntelliMAX™ | Saving our world, 1mW /W /kW at a time™ | TinyPower™ |
| EfficientMax™ | ISOPLANAR™ | SmartMax™ | TinyPWM™ |
| EZSWITCH™* | MegaBuck™ | SMART START™ | TinyWire™ |
|  | MICROCOUPLER™ | SPM® | TriFault Detect™* |
|  | MicroFET™ | STEALTH™ | TRUECURRENT™* |
| Fairchild® | MicroPak™ | SuperFET™ |  |
| Fairchild Semiconductor® | MillerDrive™ | SuperSOT™-3 | UHC® |
| FACT Quiet Series™ | MotionMax™ | SuperSOT™-6 | Ultra FRFET™ |
| FACT® | Motion-SPM™ | SuperSOT™-8 | UniFET™ |
| FAST® | OPTOLOGIC® | SupreMOS™ | VCX™ |
| FastvCore™ | OPTOPLANAR® | SyncFET™ | VisualMax™ |
| FETBench™ |  | Sync-Lock™ | XS™ |
| FlashWriter®* | PDP SPM™ |  | |
| | Power-SPM™ | | |

*Trademarks of System General Corporation, used under license by Fairchild Semiconductor.

DISCLAIMER

FAIRCHILD SEMICONDUCTOR RESERVES THE RIGHT TO MAKE CHANGES WITHOUT FURTHER NOTICE TO ANY PRODUCTS HEREIN TO IMPROVE RELIABILITY, FUNCTION, OR DESIGN. FAIRCHILD DOES NOT ASSUME ANY LIABILITY ARISING OUT OF THE APPLICATION OR USE OF ANY PRODUCT OR CIRCUIT DESCRIBED HEREIN; NEITHER DOES IT CONVEY ANY LICENSE UNDER ITS PATENT RIGHTS, NOR THE RIGHTS OF OTHERS. THESE SPECIFICATIONS DO NOT EXPAND THE TERMS OF FAIRCHILD'S WORLDWIDE TERMS AND CONDITIONS, SPECIFICALLY THE WARRANTY THEREIN, WHICH COVERS THESE PRODUCTS.

LIFE SUPPORT POLICY

FAIRCHILD'S PRODUCTS ARE NOT AUTHORIZED FOR USE AS CRITICAL COMPONENTS IN LIFE SUPPORT DEVICES OR SYSTEMS WITHOUT THE EXPRESS WRITTEN APPROVAL OF FAIRCHILD SEMICONDUCTOR CORPORATION.

As used herein:

1. Life support devices or systems are devices or systems which, (a) are intended for surgical implant into the body or (b) support or sustain life, and (c) whose failure to perform when properly used in accordance with instructions for use provided in the labeling, can be reasonably expected to result in a significant injury of the user.
2. A critical component in any component of a life support, device, or system whose failure to perform can be reasonably expected to cause the failure of the life support device or system, or to affect its safety or effectiveness.

ANTI-COUNTERFEITING POLICY

Fairchild Semiconductor Corporation's Anti-Counterfeiting Policy. Fairchild's Anti-Counterfeiting Policy is also stated on our external website, www.Fairchildsemi.com, under Sales Support.

Counterfeiting of semiconductor parts is a growing problem in the industry. All manufactures of semiconductor products are experiencing counterfeiting of their parts. Customers who inadvertently purchase counterfeit parts experience many problems such as loss of brand reputation, substandard performance, failed application, and increased cost of production and manufacturing delays. Fairchild is taking strong measures to protect ourselves and our customers from the proliferation of counterfeit parts. Fairchild strongly encourages customers to purchase Fairchild parts either directly from Fairchild or from Authorized Fairchild Distributors who are listed by country on our web page cited above. Products customers buy either from Fairchild directly or from Authorized Fairchild Distributors are genuine parts, have full traceability, meet Fairchild's quality standards for handling and storage and provide access to Fairchild's full range of up-to-date technical and product information. Fairchild and our Authorized Distributors will stand behind all warranties and will appropriately address and warranty issues that may arise. Fairchild will not provide any warranty coverage or other assistance for parts bought from Unauthorized Sources. Fairchild is committed to combat this global problem and encourage our customers to do their part in stopping this practice by buying direct or from authorized distributors.

PRODUCT STATUS DEFINITIONS

Definition of Terms

Datasheet Identification	Product Status	Definition
Advance Information	Formative / In Design	Datasheet contains the design specifications for product development. Specifications may change in any manner without notice.
Preliminary	First Production	Datasheet contains preliminary data; supplementary data will be published at a later date. Fairchild Semiconductor reserves the right to make changes at any time without notice to improve design.
No Identification Needed	Full Production	Datasheet contains final specifications. Fairchild Semiconductor reserves the right to make changes at any time without notice to improve the design.
Obsolete	Not In Production	Datasheet contains specifications on a product that is discontinued by Fairchild Semiconductor. The datasheet is for reference information only.

Rev. I41