

Mod. G7520 - Fittings Series 7000 - Automation

Product code: G7520 16-3/4

Datasheet creation date: 12/12/2025 08:31

Check the most updated document online [click here](#)



■ TECHNICAL DATA

Mod.	G7520 16-3/4
------	--------------

Mod. G7520 - Fittings Series 7000 - Automation

Product code: G7520 16-3/4

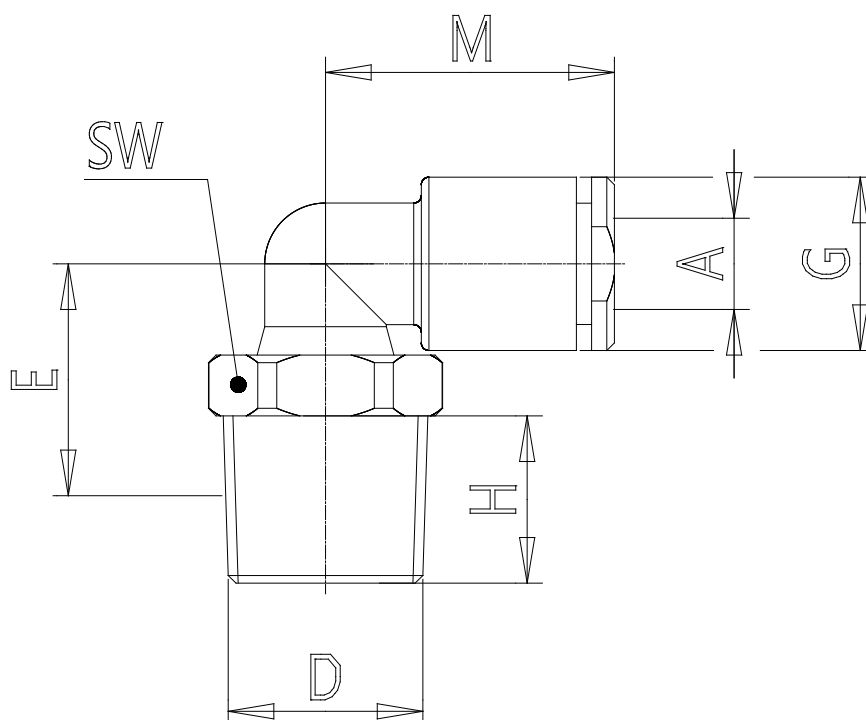

DIMENSIONS

A (mm)	16
D	R3/4
E (mm)	43.5
G (mm)	27.0
H (mm)	16.5
M (mm)	38.0
SW (mm)	27
Weight (g)	74.0