

Features

- Low Forward Voltage Drop
- Guard Ring Construction for Transient Protection
- Negligible Reverse Recovery Time
- Low Reverse Capacitance
- Ultra-Small Surface Mount Package
- **Lead, Halogen and Antimony Free, RoHS Compliant "Green" Device (Notes 3 and 4)**
- **Qualified to AEC-Q101 Standards for High Reliability (Only for SD103AWS-7-F)**

Mechanical Data

- Case: SOD-323
- Case Material: Molded Plastic. UL Flammability Classification Rating 94V-0
- Moisture Sensitivity: Level 1 per J-STD-020D
- Leads: Solderable per MIL-STD-202, Method 208
- Lead Free Plating (Matte Tin Finish annealed over Alloy 42 leadframe).
- Polarity: Cathode Band
- Marking Information: See Page 2
- Ordering Information: See Page 2
- Weight: 0.004 grams (approximate)



Top View

Maximum Ratings @T_A = 25°C unless otherwise specified

Characteristic	Symbol	SD103AWS	SD103BWS	SD103CWS	Unit
Peak Repetitive Reverse Voltage	V _{RRM}				
Working Peak Reverse Voltage	V _{RWM}	40	30	20	V
DC Blocking Voltage	V _R				
RMS Reverse Voltage	V _{R(RMS)}	28	21	14	V
Forward Continuous Current (Note 1)	I _{FM}		350		mA
Non-Repetitive Peak Forward Surge Current @ t ≤ 1.0s	I _{FSM}		1.5		A

Thermal Characteristics

Characteristic	Symbol	Value	Unit
Power Dissipation (Note 1)	P _D	200	mW
Thermal Resistance, Junction to Ambient Air (Note 1)	R _{θJA}	625	°C/W
Operating and Storage Temperature Range	T _J , T _{STG}	-65 to +125	°C

Electrical Characteristics @T_A = 25°C unless otherwise specified

Characteristic	Symbol	Min	Typ	Max	Unit	Test Conditions
SD103AWS Reverse Breakdown Voltage (Note 2)	SD103BWS SD103CWS V _{(BR)R}	40 30 20	—	—	V	I _R = 100μA I _R = 100μA I _R = 100μA
Forward Voltage Drop	V _F	—	—	0.37 0.60	V	I _F = 20mA I _F = 200mA
SD103AWS Peak Reverse Current (Note 2)	SD103BWS SD103CWS I _R	—	—	5.0	μA	V _R = 30V V _R = 20V V _R = 10V
Total Capacitance	C _T	—	28	—	pF	V _R = 0V, f = 1.0MHz
Reverse Recovery Time	t _{rr}	—	10	—	ns	I _F = I _R = 200mA, I _{rr} = 0.1 x I _R , R _L = 100Ω

- Notes:
1. Part mounted on FR-4 PC board with recommended pad layout, which can be found on our website at <http://www.diodes.com/datasheets/ap02001.pdf>.
 2. Short duration test pulse used to minimize self-heating effect.
 3. No purposefully added lead. Halogen and Antimony Free.
 4. Product manufactured with Data Code V9 (week 33, 2008) and newer are built with Green Molding Compound. Product manufactured prior to Date Code V9 are built with Non-Green Molding Compound and may contain Halogens or Sb₂O₃ Fire Retardants.

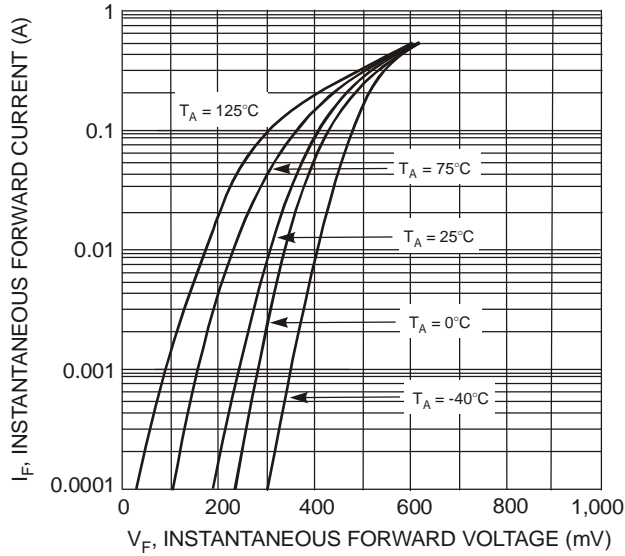

Fig. 1 Typical Forward Characteristics

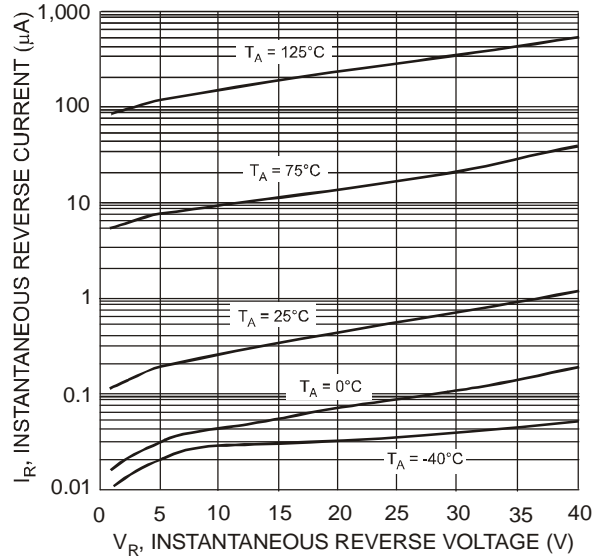

Fig. 2 Typical Reverse Characteristics

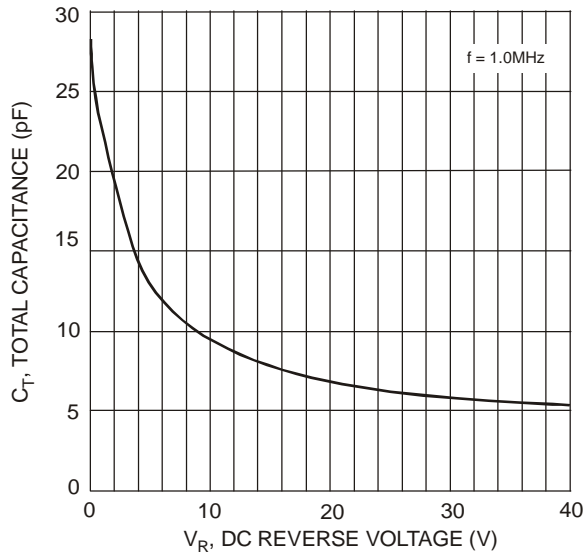

Fig. 3 Total Capacitance vs. Reverse Voltage

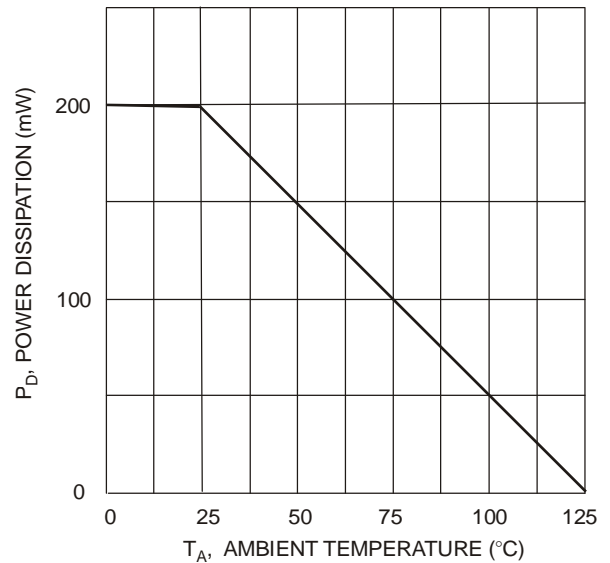

Fig. 4 Power Derating Curve

Ordering Information (Note 5)

Part Number	Case	Packaging
SD103AWS-7-F	SOD-323	3000/Tape & Reel
SD103BWS-7-F	SOD-323	3000/Tape & Reel
SD103CWS-7-F	SOD-323	3000/Tape & Reel

Notes: 5. For packaging details, go to our website at <http://www.diodes.com/datasheets/ap02007.pdf>.

Marking Information

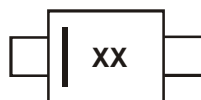

xx = Product Type Marking Code
 S4 = SD103AWS
 S5 or S4 = SD103BWS
 S6 or S5 or S4 = SD103CWS

Package Outline Dimensions

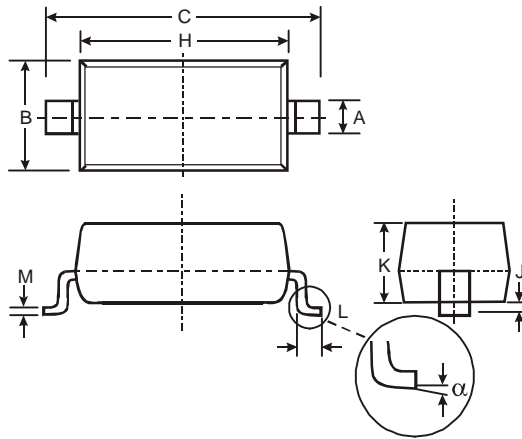

SOD-323		
Dim	Min	Max
A	0.25	0.35
B	1.20	1.40
C	2.30	2.70
H	1.60	1.80
J	0.00	0.10
K	1.0	1.1
L	0.20	0.40
M	0.10	0.15
α	0°	8°

All Dimensions in mm

Suggested Pad Layout

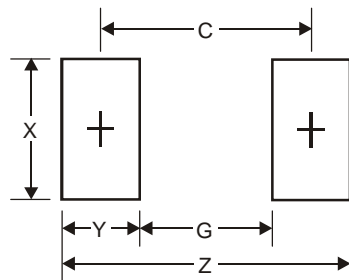

Dimensions	Value (in mm)
Z	3.75
G	1.05
X	0.65
Y	1.35
C	2.40

IMPORTANT NOTICE

Diodes Incorporated and its subsidiaries reserve the right to make modifications, enhancements, improvements, corrections or other changes without further notice to any product herein. Diodes Incorporated does not assume any liability arising out of the application or use of any product described herein; neither does it convey any license under its patent rights, nor the rights of others. The user of products in such applications shall assume all risks of such use and will agree to hold Diodes Incorporated and all the companies whose products are represented on our website, harmless against all damages.

LIFE SUPPORT

Diodes Incorporated products are not authorized for use as critical components in life support devices or systems without the expressed written approval of the President of Diodes Incorporated.