



Low voltage AC drives

ACS55, ACS150, ACS310, ACS355,  
ACS550, ACS580

For smooth motor control and energy savings  
Catalog and price list

# Smooth motor control and energy savings



## What is an AC drive?

An AC drive is an electronic device that is used to adjust the rotating speed and torque of a standard, electric AC motor. The electric motor, in turn, drives a load such as a fan, pump or conveyor.

AC drives are also referred to as frequency converters, variable frequency drives (VFD), variable speed drives (VSD), adjustable frequency drives (AFD), adjustable speed drives (ASD) or inverters.

## ABB - global market and technology leader in AC drives

ABB ([www.abb.com](http://www.abb.com)) is a leader in power and automation technologies that enable utility and industry customers to improve their performance while lowering environmental impact. ABB is the world's largest drives manufacturer. The ABB Group of companies operates in around 100 countries and employs more than 145,000 people.

Electric motors consume about 65% of all electricity used throughout industry. Yet, less than 10% of those motors are fitted with a variable speed drive.

## Benefits of using AC drives

### Substantial energy savings

Rather than having an electric motor running continuously at full speed, an electric drive allows the user to slow down or speed up the motor depending on the demand.

### Optimal process control

An electric drive enables the process to achieve the right speed and torque while maintaining its accuracy. This contributes to more consistent quality and throughput of the end product.

### Reduced need for maintenance

Being able to vary the speed and torque of an electric motor means there is less wear and tear on the motor and the driven machine.

### Efficient system upgrade

An AC drive allows the removal of valves, gears and belts. It also ensures network dimensioning based on a lower starting current.



## ABB drives common features

### Easy to select

Selecting a drive can be as simple as choosing the power rating, voltage and current through to detailed dimensioning and the addition of various options. A drive can easily be selected using the ABB drives selection table on page 5.

### Easy to purchase

ABB drives are available from ABB and selected ABB partners. Please contact ABB for more details.

### Easy to install

The drives are simple to install, featuring a variety of mounting options from wall-mounted to cabinet mounted.

### Easy to operate

Once installed and commissioned, the drives are incredibly easy to operate. The user interface allows instant adjustments to speed or other more advanced parameters.

# Choosing the right drive for your application

Step	Process	Action
1	<p><b>Identify the application</b></p> <p>Identify the type of application and the likely demands of the drive.</p>	Continue to step 2.
2	<p><b>Gather the load data: system inertia, required acceleration and deceleration rates, minimum and maximum speeds, overload requirements, etc.</b></p> <p>This information can often be determined by the performance of the existing motor.</p>	Continue to step 3.
3	<p><b>Gather the motor data: rated torque, kW, volts, insulation class, speed, etc.</b></p> <p>Whether an existing motor or a new motor is being used, the motor information is critical to choosing a drive.</p>	Continue to step 4.
4	<p><b>Choose a drive</b></p> <p>Match the data gathered in Steps 1 to 3 against the table of drive features on page 5. Select a drive that meets the motor requirements and has all the software features needed for the application.</p>	Continue to step 5.
5	<p><b>Is the drive offered in the correct kW/amp rating?</b></p> <p>The drive you choose must be able to supply the necessary current to the motor to produce the torque required. This includes normal and overload conditions. Select current from the tables on pages 7, 9, 11, 13 or 15 depending on drive type selected.</p>	<p>If yes, continue to step 6.</p> <p>If no, go to step 4.</p>
6	<p><b>Is the drive offered in the correct enclosure and environmental ratings?</b></p> <p>The drive you choose must be available in an enclosure style that will withstand the application's environment. It also must produce the required current at the application's altitude and ambient temperature.</p>	<p>If yes, continue to step 7.</p> <p>If no, go to step 4.</p>
7	<p><b>Does this drive have the features needed to meet the application's demands?</b></p> <p>The drive you choose must have a feature set that matches the application. It also must have sufficient hardware (inputs and outputs, feedback, communications, etc.) to perform the application.</p>	<p>If yes, continue to step 8.</p> <p>If no, go to step 4.</p>
8	<p><b>Does this drive have the motor control performance to meet the application's demands?</b></p> <p>The drive you choose must be able to produce the needed torque at the necessary speeds. It must also be able to control speed and torque depending on the application requirements.</p>	<p>If yes, continue to step 9.</p> <p>If no, go to step 4.</p>
9	<p><b>Congratulations!</b></p> <p>The ABB AC drive you have chosen has the features and performance needed for a successful application.</p>	

# ABB AC drive selection table

Applications where to use		ABB micro drives		ABB machinery drive	ABB general purpose drives		
		ACS55	ACS150	ACS355	ACS310	ACS550	ACS580
Pumps		●	●	●	●	●	●
Fans		●	●	●	●	●	●
Conveyors		●	●	●	-	●	●
Material handling machines		●	●	●	-	●	●
Exercise equipment		●	●	-	-	-	-
White goods		●	●	-	-	-	-
Gates, doors, barriers		●	●	●	-	-	-
Compressors		-	-	●	●	●	●
Cutting machines, shears, saws		-	-	●	-	●	●
Extruders		-	-	●	-	●	●
Machine tools, mixers, stirrers		-	-	●	-	●	●
Spinning machines		-	●	●	-	●	●
Centrifuges		-	-	●	-	●	●
Processing lines		-	-	-	-	●	●
Specification		ACS55	ACS150	ACS355	ACS310	ACS550	ACS580
<b>Voltage and power ranges</b>		1-phase, 100 to 120 V: 0.18 to 0.37 kW 1-phase, 200 to 240 V: 0.18 to 2.2 kW	1-phase, 200 to 240 V: 0.37 to 2.2 kW 3-phase, 200 to 240 V: 0.37 to 2.2 kW 3-phase, 380 to 480 V: 0.37 to 4 kW	1-phase, 200 to 240 V: 0.37 to 2.2 kW 3-phase, 200 to 240 V: 0.37 to 11 kW 3-phase, 380 to 480 V: 0.37 to 22 kW	1-phase 200 to 240 V: 0.37 to 2.2 kW 3-phase, 200 to 240 V: 0.37 to 11 kW 3-phase, 380 to 480 V: 0.37 to 22 kW	3-phase, 208 to 240 V: 0.75 to 75 kW 3-phase, 380 to 480 V: 0.75 to 355 kW	3-phase, 380 to 480 V: 0.75 to 250 kW
<b>Protection classes</b>	IP20	●	●	●	●	●	●
	IP21	-	-	○	○	● <sup>1)</sup>	● <sup>1)</sup>
	IP54/IP55	-	-	-	-	● <sup>1)</sup>	● <sup>1)</sup>
	IP66/IP67	-	-	● <sup>1)</sup>	-	-	-
<b>Mounting arrangements</b>	Optimal for cabinet mounting	●	●	●	●	-	-
	Optimal for wall mounting	-	-	● (IP66/67 variant)	○	●	●
<b>Programming</b>	Parameter programming	●	●	●	●	●	●
	Sequence programming	-	-	●	-	-	-
<b>Human-machine interface</b>	Basic control panel	-	●	○	○	○	○
	Assistant control panel	-	-	○/● (with IP66/67 variant)	○	●	●
<b>Ambient temperature</b>		0 to +40 °C with nominal current and 5 kHz switching frequency, up to +50 °C with derating, -20 °C with restrictions.	-10 to +40 °C, no frost allowed, +50 °C with 10% derating.	-10 to +40 °C, no frost allowed, +50 °C with 10% derating.	-10 to +50 °C (14 to 122 °F), no frost allowed.	-15 to +50 °C. No frost allowed. From +40 to +50 °C with derating.	-15 to +50 °C. No frost allowed. From +40 to +50 °C with derating.
<b>Inputs and outputs</b>	Digital inputs/outputs	3/0	5/0	5/1	5/1	6/0	6/0
	Relay outputs	1	1	1	1	3 + (3 as option)	3 + (2 as option)
	Analog inputs/outputs	1/0	2/1	2/1	2/1	2/2	2/2
	Speed feedback	-	-	○	-	○	-
<b>Supported fieldbus protocols</b>	Modbus RTU	-	-	○	●	●	●
	Profibus DP	-	-	○	-	○	○
	DeviceNet™	-	-	-	-	○	○
	LonWorks®	-	-	○	-	○	○
	ControlNet	-	-	-	-	○	○
	CANopen®	-	-	○	-	○	○
	Ethernet (Modbus/TCP)	-	-	○	-	○	○
	Ethernet (EtherNet/IP™)	-	-	○	-	○	○
	Ethernet (EtherCAT®)	-	-	○	-	○	○
	Ethernet (PROFINET IO)	-	-	○	-	○	○
Ethernet (PowerLink)	-	-	-	-	○	○	
<b>EMC compliance (EN 61800-3)</b>	C3, industrial use	●	●	●	●	●	●
	C2, commercial use (installation by EMC experts)	●	○	○	○	●	●
	C1, commercial use	○ (conductive emissions)	○ (conductive emissions)	○ (conductive emissions)	○ (conductive emissions)	○ (conductive emissions)	○ (conductive emissions)
<b>Chokes</b>	Input chokes	○	○	○	○	● (built-in)	● (built-in)
	Output chokes	○	○	○	○	○	○
<b>Brake chopper</b>		-	●	●	-	● <sup>2)</sup>	● <sup>3)</sup>
<b>Suggested maximum motor cable length</b>		30 to 50 m	30 to 60 m	30 to 60 m	30 to 60 m	100 to 200 m	100 to 200 m
<b>Switching frequency</b>		up to 16 kHz	up to 16 kHz	up to 16 kHz	up to 16 kHz	up to 12 kHz	up to 12 kHz
<b>Output frequency</b>		0 to 120/130 Hz 150% for 60 s	0 to 500 Hz 150% for 60 s, 180% for 2 s	0 to 599 Hz 150% for 60 s, 180% for 2 s	0 to 500 Hz 110% for 60 s, 180% for 2 s	0 to 500 Hz 150% for 60 s, 180% for 2 s	0 to 500 Hz 150% for 60 s, 180% for 2 s
<b>Overload capacity</b>							
<b>Number of preset speeds</b>		1	3	7	7	7	7
<b>PC tools</b>	Drive commissioning tool	○	-	○	○	○	○
	Drive offline programming tool	-	○	○	○	○	○
	Drive dimensioning tool	-	-	-	-	○	○
<b>Approvals</b>		●	●	●	●	●	●
<b>RoHS compliance</b>		●	●	●	●	●	●

● = standard

○ = option

- = not available

<sup>1)</sup> IP66/67 and IP54/55 product variants

<sup>2)</sup> up to R2 as standard

<sup>3)</sup> up to R3 as standard

# ABB micro drives

## ACS55, 0.18 to 2.2 kW

### What is it?

The ACS55 drive is a component that can be integrated easily into existing panels, replacing contactors and motor starters. Its compact size is ideal for new installations or whenever speed control of AC induction motors is needed. For users new to drives, its interface with DIP switches and trimmers is exceptionally intuitive.

The ACS55 drive meets the requirements of new drive users, installers, machine builders and panel builders.



ACS55 frame sizes: A, B, C, D

Feature	Advantage	Benefit
Single phase supply	Suitable for single phase residential and commercial applications	Avoids cabling and installation costs associated with three-phase supplies
Slim design	Fits easily into a variety of cabinet designs	Cabinet size can be smaller or greater packing density can be achieved
Flexible installation alternatives	Screw or DIN rail mounting, sideways or side-by-side	One drive type can be used in various designs, saving installation costs and time
High switching frequency	Reduced motor noise	Does not disturb occupants of buildings
Integrated EMC filter as standard	High electromagnetic compatibility	Low EMC emissions in all environments
Easy configuration	Quick setup with DIP switches and trimmers	Substantial time savings. Minimal expertise needed.
DriveConfig kit PC tool	DriveConfig kit PC tool is used to set drive parameters and to upload the parameter set to a drive in seconds, even without a power connection to the drive. The DIP switches and trimmers on the front panel of the drive are disabled after using the DriveConfig kit. This prevents the end users from altering the drive configuration.	Time savings with multiple drives. Drive configuration protected from end user alterations.

### Inputs and outputs

The figure shows the ACS55 factory-set standard inputs and outputs.

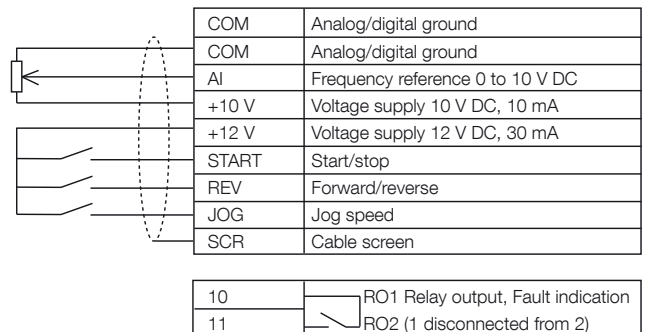

## Types and voltages

Rated values *)		ABB ordering code Enclosure IP20	Electrical code/ reference code	ABB type code/ order code	Frame size	Price (Eur)
$P_{motor}$ (kW)	$I_{motor}$ (A)					
<b>Built-in EMC filter, 1-phase AC supply, 200 to 240 V, +10/-15%, 3-phase output 200 to 240 V</b>						
0.18	1.4	68878331		ACS55-01E-01A4-2	A	
0.37	2.2	68878349		ACS55-01E-02A2-2	A	
0.75	4.3	68878357		ACS55-01E-04A3-2	B	
1.5	7.6	68878365		ACS55-01E-07A6-2	D	
2.2	9.8	68878373		ACS55-01E-09A8-2	D	
<b>No EMC filter, 1-phase AC supply, 200 to 240 V, +10/-15%, 3-phase output 200 to 240 V</b>						
0.18	1.4	68878403		ACS55-01N-01A4-2	A	
0.37	2.2	68878420		ACS55-01N-02A2-2	A	
0.75	4.3	68878438		ACS55-01N-04A3-2	B	
1.5	7.6	68878446		ACS55-01N-07A6-2	C	
2.2	9.8	68878454		ACS55-01N-09A8-2	C	
<b>Built-in EMC filter, 1-phase AC supply, 110/120 V, +10/-15%, 3-phase output 200/240 V</b>						
0.18	1.4	68878314		ACS55-01E-01A4-1	A	
0.37	2.2	68878322		ACS55-01E-02A2-1	A	
<b>No EMC filter, 1-phase AC supply, 110/120 V, +10/-15%, 3-phase output 200/240 V</b>						
0.18	1.4	68878381		ACS55-01N-01A4-1	A	
0.37	2.2	68878390		ACS55-01N-02A2-1	A	

\*) The rated power and current values are valid for both pump and fan applications and heavy load applications. Examples of typical heavy load applications include most extruders and compressors.

## Dimensions and weights

Frame size	Built-in EMC filter				No EMC filter			
	H (mm)	W (mm)	D (mm)	Weight (kg)	H (mm)	W (mm)	D (mm)	Weight (kg)
A	170	45	128	0.65	170	45	128	0.65
B	170	67.5	128	0.9	170	67.5	128	0.9
C	-	-	-	-	194	70	159	1.2
D	226	70	159	1.6	-	-	-	-



# ABB micro drives

## ACS150, 0.37 to 4 kW

### What is it?

The ACS150 drive is a component that is brought together with other components and includes, as standard, all necessary functions and interfaces for typical applications with AC induction motors. This makes the product selection very easy.

The ACS150 drive meets the requirements of new drive users, installers, machine builders and panel builders.



ACS150 frame sizes: R0, R1, R2

Feature	Advantage	Benefit
User-friendly LCD control panel	Clear alphanumeric display Easy setup and use	Time savings
Flexible mounting alternatives	Screw or DIN rail mounting, sideways or side-by-side	One drive type can be used in various designs, saving installation costs and time
Integrated EMC filter	High electromagnetic compatibility	Low EMC emissions in selected environments
Built-in brake chopper as standard	No need for an external brake chopper	Space savings, reduced installation cost
Embedded potentiometer	Easy to adjust output frequency	Time savings
PID control	Simple integration to process control	Cost savings as a result of less cabling
FlashDrop tool	FlashDrop is a hand held tool that is used to quickly and easily set drive parameters. FlashDrop tool uploads drive parameters directly to unpowered drives. The tool can copy parameters from one drive to another or between a PC and a drive.	Time savings, especially with multiple drives

### Inputs and outputs

The figure shows the ACS150 factory-set standard inputs and outputs. All inputs and outputs are freely programmable.

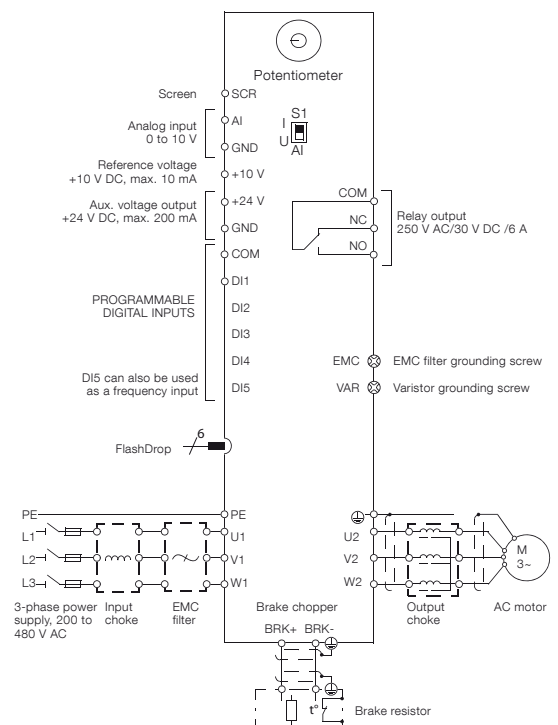



## Types and voltages

Rated values *)		ABB ordering code Enclosure IP20	Electrical code/ reference code	ABB type code/order code for IP20 units	Frame size	Price (Eur)
$P_{\text{motor}}$ (kW)	$I_{\text{motor}}$ (A)					
<b>1-phase AC supply, 200 to 240 V</b>						
0.37	2.4	68581940		ACS150-01E-02A4-2	R0	
0.75	4.7	68581966		ACS150-01E-04A7-2	R1	
1.1	6.7	68581974		ACS150-01E-06A7-2	R1	
1.5	7.5	68581982		ACS150-01E-07A5-2	R2	
2.2	9.8	68581991		ACS150-01E-09A8-2	R2	
<b>3-phase AC supply, 200 to 240 V</b>						
0.37	2.4	68582008		ACS150-03E-02A4-2	R0	
0.55	3.5	68582016		ACS150-03E-03A5-2	R0	
0.75	4.7	68582024		ACS150-03E-04A7-2	R1	
1.1	6.7	68582032		ACS150-03E-06A7-2	R1	
1.5	7.5	68582041		ACS150-03E-07A5-2	R1	
2.2	9.8	68582059		ACS150-03E-09A8-2	R2	
<b>3-phase AC supply, 380 to 480 V</b>						
0.37	1.2	68581737		ACS150-03E-01A2-4	R0	
0.55	1.9	68581745		ACS150-03E-01A9-4	R0	
0.75	2.4	68581753		ACS150-03E-02A4-4	R1	
1.1	3.3	68581761		ACS150-03E-03A3-4	R1	
1.5	4.1	68581788		ACS150-03E-04A1-4	R1	
2.2	5.6	68581796		ACS150-03E-05A6-4	R1	
3	7.3	68581800		ACS150-03E-07A3-4	R1	
4	8.8	68581818		ACS150-03E-08A8-4	R1	

\*) The rated power and current values are valid for both pump and fan applications and heavy load applications. Examples of typical heavy load applications include most extruders and compressors.

## Dimensions and weights

Frame size	IP20/UL open				NEMA 1			
	H (mm)	W (mm)	D (mm)	Weight (kg)	H (mm)	W (mm)	D (mm)	Weight (kg)
R0	239	70	142	1.1	280	70	142	1.5
R1	239	70	142	1.3	280	70	142	1.7
R2	239	105	142	1.5	282	105	142	1.9



# ABB machinery drives

## ACS355, 0.37 to 22 kW

### What is it?

The ACS355 is designed to be the fastest drive in terms of installation, setting parameters and commissioning. The drive is user-friendly, yet provides a wide range of built-in technology such as the safe torque off functionality and sequence programming which reduce the need for additional control electronics. The product offers options and diverse functionality to cater to the needs set for speed and torque control of AC induction and permanent magnet motors.

The ACS355 drive meets the requirements of new drive users, installers, machine builders, system integrators and panel builders.



ACS355 frame sizes: R0, R1, R2, R3, R4 and IP66/IP67 variants

Feature	Advantage	Benefit
Same height and depth across power range	Effective space usage	Less engineering and installation time
Assistant control panel with Help functions	Quick setup, easy configuration and commissioning, rapid fault diagnosis	Substantial time savings locating faults and implementing repairs, thereby reducing maintenance costs
Scalar and vector control	Optimum performance depending on application	Ensures the end-product is produced cost efficiently
Sequence programming	Logic programming included as standard with PLC-like functions	Reduces components and wiring in control system
Integrated EMC filter	High electromagnetic compatibility	Low EMC emissions in selected environments
Built-in brake chopper as standard	No need for an external brake chopper	Space savings, reduced installation cost
Safe torque off function (SIL3) as standard	Built-in and certified function that is used for prevention of an unexpected startup and other stopping related functions	Reduces the need for external safety components. Helps machine builders to fulfill the requirements of Machinery Directive 2006/42/EC.
High protection class variant (IP66/67) up to 7.5 kW	No need to design special enclosure for applications that require high ingress protection	Time and cost savings
Product variant for solar pumps	Drive converts PV energy from solar panels to AC current, it can be operated independent from the grid.	Long life time and reduced maintenance costs, energy use and pollution. Improved reliability in electricity supply.
FlashDrop tool	FlashDrop is used to quickly and easily set drive parameters. FlashDrop tool uploads drive parameters directly to unpowered drives. The tool can copy parameters from one drive to another or between a PC and a drive.	Time savings, especially with multiple drives

### Inputs and outputs

The figure shows the ACS355 factory-set standard inputs and outputs. All inputs and outputs are freely programmable.

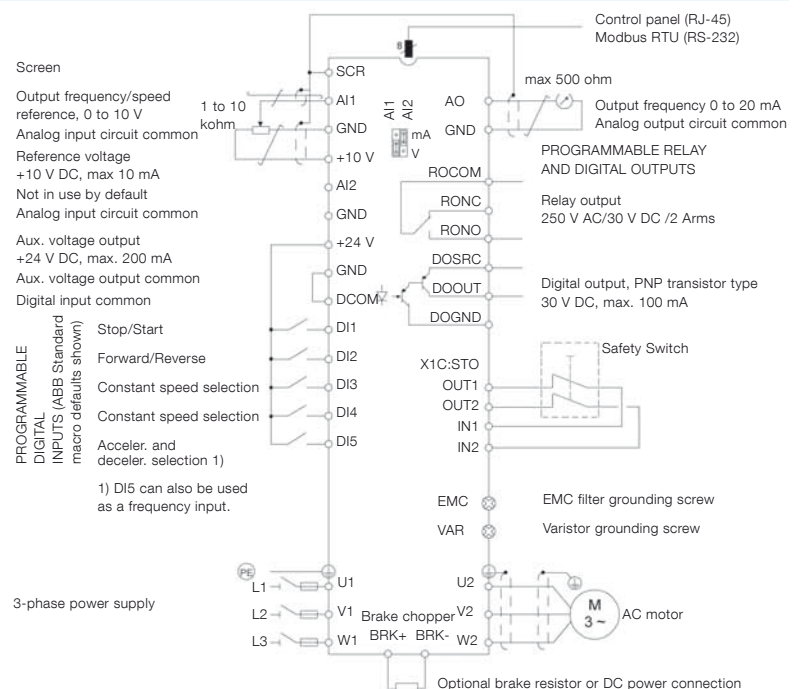

## Types and voltages

Rated values *)		ABB ordering code Enclosure IP20	Electrical code/ reference code	ABB type code/order code for IP20 units	Frame size	Price (Eur)
$P_{motor}$ (kW)	$I_{motor}$ (A)					
<b>1-phase AC supply, 200 to 240 V</b>						
0.37	2.4	3AUA0000058166		ACS355-01E-02A4-2	R0	
0.75	4.7	3AUA0000058167		ACS355-01E-04A7-2	R1	
1.1	6.7	3AUA0000058168		ACS355-01E-06A7-2	R1	
1.5	7.5	3AUA0000058169		ACS355-01E-07A5-2	R2	
2.2	9.8	3AUA0000058170		ACS355-01E-09A8-2	R2	
<b>3-phase AC supply, 200 to 240 V</b>						
0.37	2.4	3AUA0000058171		ACS355-03E-02A4-2	R0	
0.55	3.5	3AUA0000058172		ACS355-03E-03A5-2	R0	
0.75	4.7	3AUA0000058173		ACS355-03E-04A7-2	R0	
1.1	6.7	3AUA0000058174		ACS355-03E-06A7-2	R1	
1.5	7.5	3AUA0000058175		ACS355-03E-07A5-2	R1	
2.2	9.8	3AUA0000058176		ACS355-03E-09A8-2	R2	
3	13.3	3AUA0000058177		ACS355-03E-13A3-2	R2	
4	17.6	3AUA0000058178		ACS355-03E-17A6-2	R2	
5.5	24.4	3AUA0000058179		ACS355-03E-24A4-2	R3	
7.5	31	3AUA0000058180		ACS355-03E-31A0-2	R4	
11	46.2	3AUA0000058181		ACS355-03E-46A2-2	R4	
<b>3-phase AC supply, 380 to 480 V</b>						
0.37	1.2	3AUA0000058182		ACS355-03E-01A2-4	R0	
0.55	1.9	3AUA0000058183		ACS355-03E-01A9-4	R0	
0.75	2.4	3AUA0000058184		ACS355-03E-02A4-4	R1	
1.1	3.3	3AUA0000058185		ACS355-03E-03A3-4	R1	
1.5	4.1	3AUA0000058186		ACS355-03E-04A1-4	R1	
2.2	5.6	3AUA0000058187		ACS355-03E-05A6-4	R1	
3	7.3	3AUA0000058188		ACS355-03E-07A3-4	R1	
4	8.8	3AUA0000058189		ACS355-03E-08A8-4	R1	
5.5	12.5	3AUA0000058190		ACS355-03E-12A5-4	R3	
7.5	15.6	3AUA0000058191		ACS355-03E-15A6-4	R3	
11	23.1	3AUA0000058192		ACS355-03E-23A1-4	R3	
15	31	3AUA0000058193		ACS355-03E-31A0-4	R4	
18.5	38	3AUA0000058194		ACS355-03E-38A0-4	R4	
22	44	3AUA0000058195		ACS355-03E-44A0-4	R4	

\*) The rated power and current values are valid for both pump and fan applications and heavy load applications. Examples of typical heavy load applications include most extruders and compressors.

Rated values *)		ABB ordering code Enclosure IP66/IP67	Electrical code/ reference code	ABB type code/order code for IP66/IP67 units	Frame size	Price (Eur)
$P_{motor}$ (kW)	$I_{motor}$ (A)					
<b>3-phase AC supply, 200 to 240 V</b>						
0.37	2.4	3AUA0000058148		ACS355-03X-02A4-2 + B063	R1	
0.55	3.5	3AUA0000058149		ACS355-03X-03A5-2 + B063	R1	
0.75	4.7	3AUA0000058150		ACS355-03X-04A7-2 + B063	R1	
1.1	6.7	3AUA0000058151		ACS355-03X-06A7-2 + B063	R1	
1.5	7.5	3AUA0000058152		ACS355-03X-07A5-2 + B063	R1	
2.2	9.8	3AUA0000058153		ACS355-03X-09A8-2 + B063	R3	
3	13.3	3AUA0000058154		ACS355-03X-13A3-2 + B063	R3	
4	17.6	3AUA0000058155		ACS355-03X-17A6-2 + B063	R3	
<b>3-phase AC supply, 380 to 480 V</b>						
0.37	1.2	3AUA0000058156		ACS355-03X-01A2-4 + B063	R1	
0.55	1.9	3AUA0000058157		ACS355-03X-01A9-4 + B063	R1	
0.75	2.4	3AUA0000058158		ACS355-03X-02A4-4 + B063	R1	
1.1	3.3	3AUA0000058159		ACS355-03X-03A3-4 + B063	R1	
1.5	4.1	3AUA0000058160		ACS355-03X-04A1-4 + B063	R1	
2.2	5.6	3AUA0000058161		ACS355-03X-05A6-4 + B063	R1	
3	7.3	3AUA0000058162		ACS355-03X-07A3-4 + B063	R1	
4	8.8	3AUA0000058163		ACS355-03X-08A8-4 + B063	R1	
5.5	12.5	3AUA0000058164		ACS355-03X-12A5-4 + B063	R3	
7.5	15.6	3AUA0000058165		ACS355-03X-15A6-4 + B063	R3	

## Dimensions and weights

Frame size	IP20/UL open				IP66/IP67			
	H (mm)	W (mm)	D (mm)	Weight (kg)	H (mm)	W (mm)	D (mm)	Weight (kg)
R0	239	70	161	1.1	-	-	-	-
R1	239	70	161	1.3	305	195	281	7.7
R2	239	105	165	1.5	-	-	-	-
R3	236	169	169	2.5	436	246	277	13
R4	244	260	169	4.4	-	-	-	-

X within the type code stands for E or U.



For more technical information, see ACS355 catalog (3AUA0000068569 EN) or ABB drives product guide (3AFE68401771 EN)

# ABB general purpose drives

## ACS310, 0.37 to 22 kW

### What is it?

The ACS310 drive is designed for squared torque applications such as booster pumps and supply and return fans. The drive includes a powerful set of features which benefit pump and fan applications including built-in PID controllers and pump and fan control (PFC) that varies the drive's performance in response to changes in pressure, flow or other external data.

The ACS310 drive meets the requirements of new drive users, installers, machine builders, system integrators and panel builders.



ACS310 frame sizes: R0, R1, R2, R3, R4

Feature	Advantage	Benefit
Same height and depth across power range	Effective space usage	Less engineering and installation time
Commissioning assistants	Easy set up of parameters for PID controllers, real-time clock, serial communication, drive optimizer and drive startup	Time savings. Ensures all required parameters are set.
Pump and fan control (PFC)	One drive controls several pumps or fans. Auxiliary motors are driven according to the needed pump/fan capacity. One motor can be disengaged from the mains supply while others continue operating in parallel.	Saves cost of additional drives and external PLC. Longer life for pump or fan system while reducing maintenance time and costs. Maintenance can be carried out safely without stopping the process.
Pump protection functions	Pre-programmed features such as pipe cleaning, pipefill, inlet/outlet pressure supervision and detection of under- or overload	Reduces maintenance costs. Longer life for pump and fan system.
PID controllers	Varies the drive's performance according to the need of the application	Enhances production output, stability and accuracy
Energy efficiency counters	Illustrates saved energy, CO <sub>2</sub> emissions and energy cost in local currency using a baseline determined from the energy consumed when the fan or pump is used directly online	Shows direct impact on energy bill and helps control operational expenditure (OPEX)
Embedded Modbus EIA-485 fieldbus interface	No need for external fieldbus options. Integrated and compact design.	Saves cost of an external fieldbus device. Increases reliability
FlashDrop tool	FlashDrop is a hand held tool that is used to quickly and easily set drive parameters. FlashDrop tool uploads drive parameters directly to unpowered drives. The tool can copy parameters from one drive to another or between a PC and a drive.	Time savings, especially with multiple drives

## Inputs and outputs

The figure shows the ACS310 factory-set standard inputs and outputs. All inputs and outputs are freely programmable.

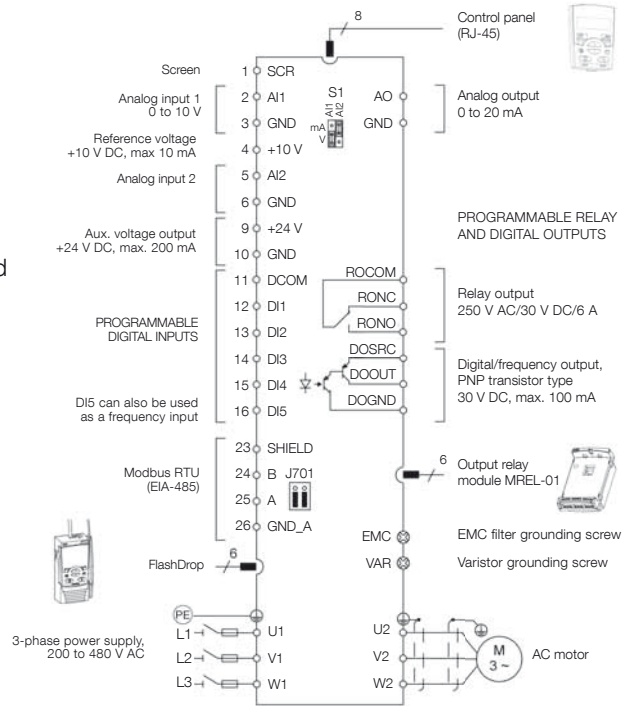

## Types and voltages

Rated values *)		ABB ordering code Enclosure IP20	Electrical code/ reference code	ABB type code/order code for IP20 units	Frame size	Price (Eur)
$P_{motor}$ (kW)	$I_{motor}$ (A)					
<b>1-phase AC supply, 200 to 240 V</b>						
0.37	2.4	3AUA0000038701		ACS310-01X-02A4-2	R0	
0.75	4.7	3AUA0000038843		ACS310-01X-04A7-2	R1	
1.1	6.7	3AUA0000038844		ACS310-01X-06A7-2	R1	
1.5	7.5	3AUA0000038845		ACS310-01X-07A5-2	R2	
2.2	9.8	3AUA0000039071		ACS310-01X-09A8-2	R2	
<b>3-phase AC supply, 200 to 240 V</b>						
0.37	2.6	3AUA0000039087		ACS310-03X-02A6-2	R0	
0.55	3.9	3AUA0000039163		ACS310-03X-03A9-2	R0	
0.75	5.2	3AUA0000039192		ACS310-03X-05A2-2	R1	
1.1	7.4	3AUA0000039215		ACS310-03X-07A4-2	R1	
1.5	8.3	3AUA0000039218		ACS310-03X-08A3-2	R1	
2.2	10.8	3AUA0000039234		ACS310-03X-10A8-2	R2	
3	14.6	3AUA0000039307		ACS310-03X-14A6-2	R2	
4	19.4	3AUA0000039621		ACS310-03X-19A4-2	R2	
5.5	26.8	3AUA0000039622		ACS310-03X-26A8-2	R3	
7.5	34.1	3AUA0000039623		ACS310-03X-34A1-2	R4	
11	50.8	3AUA0000039624		ACS310-03X-50A8-2	R4	
<b>3-phase AC supply, 380 to 480 V</b>						
0.37	1.3	3AUA0000039625		ACS310-03X-01A3-4	R0	
0.55	2.1	3AUA0000039626		ACS310-03X-02A1-4	R0	
0.75	2.6	3AUA0000039627		ACS310-03X-02A6-4	R1	
1.1	3.6	3AUA0000039628		ACS310-03X-03A6-4	R1	
1.5	4.5	3AUA0000039629		ACS310-03X-04A5-4	R1	
2.2	6.2	3AUA0000039630		ACS310-03X-06A2-4	R1	
3	8.0	3AUA0000039631		ACS310-03X-08A0-4	R1	
4	9.7	3AUA0000039632		ACS310-03X-09A7-4	R1	
5.5	13.8	3AUA0000039633		ACS310-03X-13A8-4	R3	
7.5	17.2	3AUA0000039634		ACS310-03X-17A2-4	R3	
11	25.4	3AUA0000039635		ACS310-03X-25A4-4	R3	
15	34.1	3AUA0000039636		ACS310-03X-03A4-4	R4	
18.5	41.8	3AUA0000039637		ACS310-03X-41A8-4	R4	
22	48.4	3AUA0000039638		ACS310-03X-48A4-4	R4	

\*) The rated power and current values are valid for both pump and fan applications and heavy load applications. Examples of typical heavy load applications include most extruders and compressors.

X within the type code stands for E or U.

## Dimensions and weights

Frame size	IP20/UL open				NEMA 1			
	H (mm)	W (mm)	D (mm)	Weight (kg)	H (mm)	W (mm)	D (mm)	Weight (kg)
R0	239	70	161	1.1	280	70	169	1.5
R1	239	70	161	1.3	280	70	169	1.7
R2	239	105	165	1.5	282	105	169	1.9
R3	236	169	169	2.5	299	169	177	3.1
R4	244	260	169	4.4	320	260	177	5



For more technical information, see ACS310 catalog (3AUA0000051082 EN) or ABB drives product guide (3AFE68401771 EN)

# ABB general purpose drives

## ACS550, 0.75 to 355 kW

### What is it?

The ACS550 drive is simple to buy, install, configure and use, saving considerable time as most features are built-in as standard. The product offers a high functionality to cater to the needs for speed and torque control of AC induction motors. Several programming tools are available for easy dimensioning, commissioning and maintenance.

The ACS550 drive meets the requirements of new drive users, installers, machine builders, system integrators and panel builders.



ACS550 frame sizes: R1, R2, R3, R4

Feature	Advantage	Benefit
Easy programming with parameter upload/download function	Quick setup and commissioning, simple configuration	Substantial time savings
Scalar and vector control	Optimum performance depending on application	Increased process speed. Increased production capacity ensures end-product is produced cost efficiently.
Advanced interface (user and machine) with integrated real-time clock, with battery back-up	Enables timed functions, eg day/night	Energy and labor cost savings, eg pump only runs when needed, no human intervention to start/stop drive
Integrated EMC filter	No need for an external EMC filter	Cost saving
Patented swinging choke as standard	Reduced harmonics by up to 25% standard	Losses caused by harmonics in the supply network and grid connected equipment are reduced. Energy consumption is reduced and equipment lifetime extended.
Built-in brake chopper as standard up to 11 kW	No need for external brake chopper	Space savings, and lower installation cost, no need for an external brake chopper
Energy efficiency counters	Illustrates saved energy, CO <sub>2</sub> emissions and energy cost in local currency using a baseline determined from the energy consumed when the fan or pump is used directly online	Shows direct impact on energy bill and helps control operational expenditure (OPEX)
FlashDrop tool	FlashDrop is a handheld tool that is used to quickly and easily set drive parameters. FlashDrop tool uploads drive parameters directly to unpowered drives. The tool can copy parameters from one drive to another or between a PC and a drive.	Time savings, especially with multiple drives.

### Inputs and outputs

The figure shows the ACS550 factory-set standard inputs and outputs. All inputs and outputs are freely programmable.

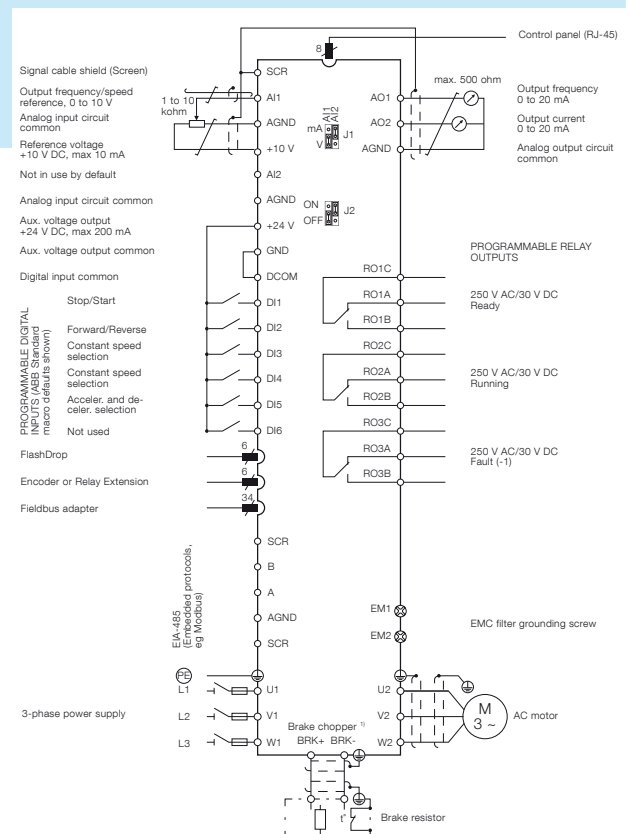

## Types and voltages

Pump and fan applications		Heavy-duty applications		ABB ordering code Enclosure IP21	Electrical code/ reference code	ABB type code/ order code for IP21 units	ABB type code/ order code for IP54 units	Frame size	Price for IP21 units (Eur)	Price for IP54 units (Eur)
$P_{motor}$ (kW)	$I_{motor}$ (A)	$P_{motor}$ (kW)	$I_{motor}$ (A)							
<b>3-phase AC supply, 208 to 240 V</b>										
0.75	4.6	0.75	3.5	3AUA0000003373		ACS550-01-04A6-2	ACS550-01-04A6-2+B055	R1		
1.1	6.6	0.75	4.6	3AUA0000003374		ACS550-01-06A6-2	ACS550-01-06A6-2+B055	R1		
1.5	7.5	1.1	6.6	3AUA0000003375		ACS550-01-07A5-2	ACS550-01-07A5-2+B055	R1		
2.2	11.8	1.5	7.5	3AUA0000003376		ACS550-01-012A-2	ACS550-01-012A-2+B055	R1		
4	16.7	3	11.8	3AUA0000003377		ACS550-01-017A-2	ACS550-01-017A-2+B055	R1		
5.5	24.2	4	16.7	3AUA0000003378		ACS550-01-024A-2	ACS550-01-024A-2+B055	R2		
7.5	30.8	5.5	24.2	3AUA0000003379		ACS550-01-031A-2	ACS550-01-031A-2+B055	R2		
11	46.2	7.5	30.8	3AUA0000003380		ACS550-01-046A-2	ACS550-01-046A-2+B055	R3		
15	59.4	11	46.2	3AUA0000003381		ACS550-01-059A-2	ACS550-01-059A-2+B055	R3		
18.5	74.8	15	59.4	3AUA0000003382		ACS550-01-075A-2	ACS550-01-075A-2+B055	R4		
22	88	18.5	74.8	3AUA0000003383		ACS550-01-088A-2	ACS550-01-088A-2+B055	R4		
30	114	22	88	3AUA0000003384		ACS550-01-114A-2	ACS550-01-114A-2+B055	R4		
37	143	30	114	3AUA0000007124		ACS550-01-143A-2	ACS550-01-143A-2+B055	R6		
45	178	37	150	3AUA0000007125		ACS550-01-178A-2	ACS550-01-178A-2+B055	R6		
55	221	45	178	3AUA0000007126		ACS550-01-221A-2	ACS550-01-221A-2+B055	R6		
75	248	55	192	3AUA0000007127		ACS550-01-248A-2	ACS550-01-248A-2+B055	R6		
<b>3-phase AC supply, 380 to 480 V</b>										
1.1	3.3	0.75	2.4	3AUA0000003385		ACS550-01-03A3-4	ACS550-01-03A3-4+B055	R1		
1.5	4.1	1.1	3.3	3AUA0000003386		ACS550-01-04A1-4	ACS550-01-04A1-4+B055	R1		
2.2	5.4	1.5	4.1	3AUA0000003387		ACS550-01-05A4-4	ACS550-01-05A4-4+B055	R1		
3	6.9	2.2	5.4	3AUA0000002415		ACS550-01-06A9-4	ACS550-01-06A9-4+B055	R1		
4	8.8	3	6.9	3AUA0000002419		ACS550-01-08A8-4	ACS550-01-08A8-4+B055	R1		
5.5	11.9	4	8.8	3AUA0000002420		ACS550-01-012A-4	ACS550-01-012A-4+B055	R1		
7.5	15.4	5.5	11.9	3AUA0000002412		ACS550-01-015A-4	ACS550-01-015A-4+B055	R2		
11	23	7.5	15.4	3AUA0000002417		ACS550-01-023A-4	ACS550-01-023A-4+B055	R2		
15	31	11	23	3AUA0000002418		ACS550-01-031A-4	ACS550-01-031A-4+B055	R3		
18.5	38	15	31	3AUA0000002431		ACS550-01-038A-4	ACS550-01-038A-4+B055	R3		
22	45	18.5	38	3AUA0000012789		ACS550-01-045A-4	ACS550-01-045A-4+B055	R3		
30	59	22	45	3AUA0000002546		ACS550-01-059A-4	ACS550-01-059A-4+B055	R4		
37	72	30	59	3AUA0000002547		ACS550-01-072A-4	ACS550-01-072A-4+B055	R4		
45	87	37	72	3AUA0000013108		ACS550-01-087A-4	ACS550-01-087A-4+B055	R4		
55	125	45	96	68589657		ACS550-01-125A-4	ACS550-01-125A-4+B055	R5		
75	157	55	125	64726820		ACS550-01-157A-4	ACS550-01-157A-4+B055	R6		
90	180	75	156	64726838		ACS550-01-180A-4	ACS550-01-180A-4+B055	R6		
110	205	90	162	68294479		ACS550-01-195A-4	ACS550-01-195A-4+B055	R6		
132	246	110	192	3AUA0000014490		ACS550-01-246A-4	ACS550-01-246A-4+B055	R6		
160	290	132	246	3AUA0000026919		ACS550-01-290A-4	ACS550-01-290A-4+B055	R6		
200	368	160	302	64727044		ACS550-02-368A-4	-	R8		
250	486	200	414	64727061		ACS550-02-486A-4	-	R8		
280	526	250	477	64727079		ACS550-02-526A-4	-	R8		
315	602	280	515	64727087		ACS550-02-602A-4	-	R8		
355	645	315	590	64727095		ACS550-02-645A-4	-	R8		

Higher powers are available on request.

## Dimensions and weights

### Wall-mounted units

Frame size	IP21 / UL type 1					IP54 / UL type 12 <sup>2)</sup>			
	H1 mm	H2 mm	W mm	D mm	Weight kg	H mm	W mm	D mm	Weight kg
R1	369	330	125	212	6.5	461	213	234	8
R2	469	430	125	222	9	561	213	245	11
R3	583	490	203	231	16	629	257	254	17
R4	689	596	203	262	24	760	257	284	26
R5	736	602	265	286	34	775	369	309	42
R6	888 <sup>1)</sup>	700	302	400	69	924 <sup>3)</sup>	410	423	86

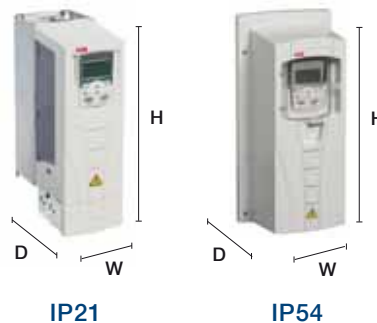

<sup>1)</sup> ACS550-01-246A-4 and ACS550-01-290A-4: 979 mm

<sup>2)</sup> UL Type 12 not available for ACS550-01-290A-4

<sup>3)</sup> ACS550-01-290A-4: 1119 mm

### Free-standing units

R8	2024	n/a	347 <sup>1)</sup>	617 <sup>1)</sup>	230
----	------	-----	-------------------	-------------------	-----

<sup>1)</sup> The dimensions apply to bookshelf mounting.  
In flat type mounting the width and depth change places.  
n/a = not applicable

# ABB general purpose drives ACS580, 0.75 to 250 kW

## What is it?

The ACS580 is plug-in ready to control your pumps, fans, conveyors, mixers and many other variable and constant torque applications. Most essential features are built-in as standard, simplifying drive selection, and making additional hardware unnecessary. Straightforward settings menu and assistants enable fast setup, commissioning, use and maintenance.

The ACS580 drive meets the requirements of new drive users, installers, electricians, machine builders, system integrators and panel builders.



ACS580 frame sizes: R0, R1, R2, R3, R5, R6, R7, R8, R9

Feature	Advantage	Benefit
Control panel and Primary settings menu with multi-language support	Effortless commissioning, configuration, monitoring and defect tracking. No need to know parameters with the Primary settings menu.	Substantial time savings. Drive speaks your local language. No need for manual as the help function is already built-in to the panel.
Installation and commissioning	Highest power density against most of the comparable products in the market. Multiple drives can be installed side-by-side.	Cost, space and time savings
Connect to public low voltage networks	Integrated C2 EMC filter (1st environment) and swinging choke (compatible harmonics levels) as standard	Ensure that the product can be used on public installations and therefore no additional filters or engineering is required.
Energy efficiency functionality	The built-in energy efficiency calculators monitoring used and saved kWh, CO <sub>2</sub> reduction and money saved. The energy optimizer ensures the maximum torque per ampere. The drive fulfills the highest IE2 drive (EN 50598-2) energy efficiency class and is compatible with high-efficiency IE4 motors.	Energy savings through improved energy management
Standard safety functions	Integrated, certified safety with SIL3 / PL e safe torque off (STO), fulfilling the machinery directive.	Fulfills Machinery Directive 2006/42/EC, EN / IEC 61800-5-2:2007. Cost-effective and certified solution for safe machine maintenance.

## Inputs and outputs

The figure shows the ACS580 factory-set standard inputs and outputs. All inputs and outputs are freely programmable.

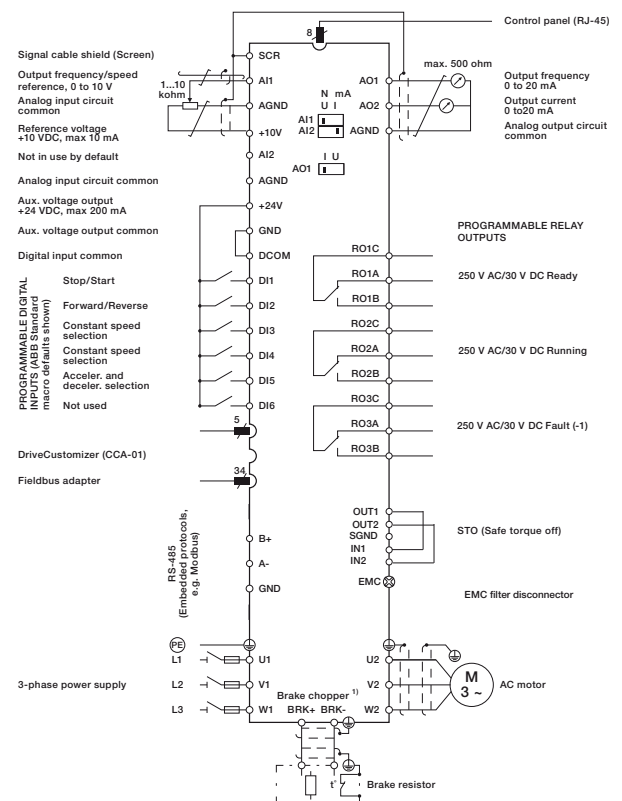



## Types and voltages

Pump and fan applications		Heavy-duty applications		ABB ordering code Enclosure IP21	Electrical code/ reference code	ABB type code/ order code for IP21 units	ABB type code/ order code for IP55 units	Frame size	Price for IP21 units (Eur)	Price for IP55 units (Eur)
$P_{motor}$ (kW)	$I_{motor}$ (A)	$P_{motor}$ (kW)	$I_{motor}$ (A)							
<b>3-phase AC supply, 380, 400, 415 V</b>										
0.75	2.5	0.55	1.8	3AUA0000080486		ACS580-01-02A6-4	ACS580-01-02A6-4+B056	R0		
1.1	3.1	0.75	2.6	3AUA0000080487		ACS580-01-03A3-4	ACS580-01-03A3-4+B056	R0		
1.5	3.8	1.1	3.3	3AUA0000080488		ACS580-01-04A0-4	ACS580-01-04A0-4+B056	R0		
2.2	5.3	1.5	4	3AUA0000080489		ACS580-01-05A6-4	ACS580-01-05A6-4+B056	R0		
3	6.8	2.2	5.6	3AUA0000080490		ACS580-01-07A2-4	ACS580-01-07A2-4+B056	R1		
4	8.9	3	7.2	3AUA0000080491		ACS580-01-09A4-4	ACS580-01-09A4-4+B056	R1		
5.5	12	4	9.4	3AUA0000080492		ACS580-01-12A6-4	ACS580-01-12A6-4+B056	R1		
7.5	16.2	5.5	12.6	3AUA0000080493		ACS580-01-017A-4	ACS580-01-017A-4+B056	R2		
11	23.8	7.5	17	3AUA0000080494		ACS580-01-025A-4	ACS580-01-025A-4+B056	R2		
15	30.4	11	24.6	3AUA0000080495		ACS580-01-032A-4	ACS580-01-032A-4+B056	R3		
18.5	36.1	15	31.6	3AUA0000080496		ACS580-01-038A-4	ACS580-01-038A-4+B056	R3		
22	42.8	18.5	37.7	3AUA0000080497		ACS580-01-045A-4	ACS580-01-045A-4+B056	R3		
30	58	22	44.6	3AUA0000130730		ACS580-01-061A-4		R5		
37	68.4	30	61	3AUA0000144812		ACS580-01-072A-4		R5		
45	82.7	37	72	3AUA0000144825		ACS580-01-087A-4		R5		
55	100	45	87	3AUA0000150595		ACS580-01-105A-4	ACS580-01-105A-4+B056	R6		
75	138	55	105	3AUA0000080504		ACS580-01-145A-4	ACS580-01-145A-4+B056	R6		
90	161	75	145	3AUA0000080505		ACS580-01-169A-4	ACS580-01-169A-4+B056	R7		
110	196	90	169	3AUA0000080506		ACS580-01-206A-4	ACS580-01-206A-4+B056	R7		
132	234	110	206	3AUA0000080507		ACS580-01-246A-4	ACS580-01-246A-4+B056	R8		
160	278	132	246 *	3AUA0000080508		ACS580-01-293A-4	ACS580-01-293A-4+B056	R8		
200	345	160	293	3AUA0000080509		ACS580-01-363A-4	ACS580-01-363A-4+B056	R9		
250	400	200	363 **	3AUA0000080510		ACS580-01-430A-4	ACS580-01-430A-4+B056	R9		

### ACS580 Heavy-duty use ratings

$P_{HD}$	Typical motor power in heavy-duty use.
$I_{HD}$	Continuous current allowing 150% $I_{LD}$ for 1 min/10 min at 40 °C. * Continuous current allowing 130% $I_{LD}$ for 1 min/10 min at 40 °C. ** Continuous current allowing 125% $I_{LD}$ for 1 min/10 min at 40 °C.

## Dimensions and weights

### Wall-mounted units

Frame size	IP21/UL type 1				IP55/UL type 12			
	H mm	W mm	D mm	Weight kg	H mm	W mm	D mm	Weight kg
R0	303	125	210	4.5	303	125	222	5.1
R1	303	125	223	4.6	303	125	233	5.1
R2	394	125	227	7.5	394	125	239	8.0
R3	454	203	228	14.9	454	203	237	15.4
R5	726	203	283	23	-	-	-	-
R6	726	252	369	45	726	252	380	45.5
R7	880	284	370	55	880	284	381	55.5
R8	965	300	393	70	965	300	452	72
R9	955	380	418	98	955	380	477	100





# Options



## ACS55

## ACS150

### ACS55 options













Type code	Electrical code/ ordering code		Price (Eur)
<b>Potentiometer</b>			
ACS50-POT	68226716		Integrated potentiometer for adjusting the motor speed
<b>DriveConfig kit</b>			
RFDT-02	68973988		PC tool for programming of ACS55 drives in larger quantities without the need for a power connection

### ACS150 options





Type code	Electrical code/ ordering code		Price (Eur)
<b>NEMA 1 enclosure kit</b>			
MUL1-R1	68566398		NEMA 1 enclosure kit for finger protection and for protection against dirt and dust, available for frame sizes R0 to R2
<b>EMC filters</b>			
RFI-11	68902371		Compatibility with category C1 and C2, 1-phase, 0.37 kW
RFI-12	68902401		Compatibility with category C1 and C2, 1-phase, 0.75 to 1.1 kW
RFI-13	68902410		Compatibility with category C1 and C2, 1-phase, 1.5 to 2.2 kW
RFI-32	68902495		Compatibility with category C1 and C2, 3-phase, 0.37 to 4.0 kW
<b>Low leakage current filters</b>			
LRFI-31	3AUA0000050644		Low leakage current filters are ideal for installations where residual current devices (RCD) are required and leakage current needs to be below 30 mA
LRFI-32	3AUA0000050645		
<b>PC tools and adapters</b>			
MFDT-01	68566380		FlashDrop is a powerful palm sized tool for fast and easy parameter selecting and setting. It gives the possibility to hide selected parameters to protect the machine.

# Options ACS355

## ACS355 options

Type code	Electrical code/ ordering code		Price (Eur)
<b>Potentiometer and control panels</b>			
M POT-01	J402		Integrated potentiometer for adjusting the motor speed
	–		Control panel cover, delivered with ACS355 drives as standard
ACS-CP-C	J404		Basic control panel with numeric display and large buttons
ACS-CP-A	J400		Assistant control panel with commissioning and diagnostic assistants. Features a multilingual display and a real-time clock.
ACS/H-CP-EXT	68294673		Control panel mounting kit, enables mounting of the control panel on the cabinet door
ACS/H-CP-EXT-IP66	68829593		Control panel mounting kit with IP66 enclosure, enables mounting of the control panel on the cabinet door
OPMP-01	3AUA0000013086		Control panel holder mounting kit. Includes a panel platform that enables the panel to be removed in the same way as a drive-mounted panel.
<b>NEMA 1 enclosure kits</b>			
MUL1-R1	68566398		NEMA 1 enclosure kit for finger protection and for protection against dirt and dust, available for frame sizes R0 to R2. Total height increases by 43 mm and depth by 8 mm.
MUL1-R3	68566410		NEMA 1 enclosure kit for finger protection and for protection against dirt and dust, available for frame size R3. Total height increases by 63 mm and depth by 8 mm.
MUL1-R4	3AUA0000023888		NEMA 1 enclosure kit for finger protection and for protection against dirt and dust, available for frame size R4. Total height increases by 76 mm and depth by 8 mm.
	B063		IP66/NEMA 4X enclosure Available up to 7.5 kW Has to be ordered together with ACS355 drive
<b>Extension modules</b>			
MTAC-01	68566355		Pulse encoder interface module
MREL-01	L511		Relay output extension module. The optional MREL-01 module offers three additional relay outputs, which can be configured for different functions with parameters.
MPOW-01	G406		Auxiliary power module







## ACS355 options

Type code	Electrical code/ ordering code		Price (Eur)
<b>Connection options</b>			
Cable gland kit	H376		Cable gland kit for the IP66/67 drive variant
Input switch kit	F278		Input switch kit for the IP66/67 drive variant
<b>Pressure compensation</b>			
	C169		Pressure compensation valve for IP66/67 variant to prevent water condensation within the enclosure.
<b>Fieldbus adapter modules</b>			
FCAN-01	K457		CANopen® protocol
FPBA-01	K454		PROFIBUS DP protocol
FDNA-01	K451		DeviceNet™ protocol
FMBA-01	K458		EIA-485/Modbus RTU protocol
FENA-01	K466		EtherNet protocol
FLON-01	K452		LonWorks® protocol
FECA-01	K469		Ethernet/EtherCAT® protocol
<b>Remote monitoring</b>			
SREA-01	3AUA0000039179		Ethernet adapter with remote monitoring access can send process data, data logs and event messages independently, without a PLC or a dedicated on-site computer. It has an internal web server for configuration and drive access.
<b>Braking resistors *</b>			
CBR-V 160	68691770		Compatibility with 1-phase, 200 to 240 V, units up to 2.2 kW Compatibility with 3-phase, 200 to 240 V, units up to 2.2 kW
CBR-V 210	68569311		Compatibility with 3-phase, 380 to 480 V, units up to 2.2 kW
CBR-V 260	68691796		Compatibility with 3-phase, 200 to 240 V, units 3 and 4 kW
CBR-V 460	68455685		Compatibility with 3-phase, 380 to 480 V, units from 3 to 7.5 kW
CBR-V 660	68897921		Compatibility with 3-phase, 380 to 480 V, unit 11 kW
CBT-V 560	3AUA0000023613		Compatibility with 3-phase, 200 to 240 V, units from 5.5 to 11 kW Compatibility with 3-phase, 380 to 480 V, units from 15 to 22 kW
<b>Input chokes</b>			
CHK-A1	68418500		Compatibility with 1-phase, 200 to 240 V, unit 0.37 kW
CHK-B1	68418518		Compatibility with 1-phase, 200 to 240 V, unit 0.75 kW
CHK-C1	68418526		Compatibility with 1-phase, 200 to 240 V, units from 1.1 to 1.5 kW
CHK-D1	68418534		Compatibility with 1-phase, 200 to 240 V, unit 2.2 kW
CHK-01	68711185		Compatibility with 3-phase, 200 to 240 V, unit 0.37 kW Compatibility with 3-phase, 380 to 480 V, units from 0.37 to 1.1 kW
CHK-02	68711193		Compatibility with 3-phase, 200 to 240 V, unit 0.55 kW Compatibility with 3-phase, 380 to 480 V, units from 1.5 to 3 kW
CHK-03	68711215		Compatibility with 3-phase, 200 to 240 V, units 0.75 to 1 kW Compatibility with 3-phase, 380 to 480 V, units from 4 to 5.5 kW
CHK-04	68711231		Compatibility with 3-phase, 200 to 240 V, units 1.5 to 4 kW Compatibility with 3-phase, 380 to 480 V, units from 7.5 to 11 kW
CHK-05	68711240		Compatibility with 3-phase, 380 to 480 V, unit 15 kW
CHK-06	68711266		Compatibility with 3-phase, 200 to 240 V, units 5.5 to 11 kW Compatibility with 3-phase, 380 to 480 V, units from 18.5 to 22 kW

\* ACS355 drives have an internal brake chopper as standard. The braking resistors chart shows typically used resistors per drive power rating. For more information about the selection of brake resistors, see the ACS355 User's Manual (3AUA0000068569), section Resistor Braking.











# Options ACS355

## ACS355 options

Type code	Electrical code/ ordering code			Price (Eur)
<b>Output chokes</b>				
ACS-CHK-B3	64324063		Compatibility with 1-phase, 200 to 240 V, units up to 0.75 kW Compatibility with 3-phase, 200 to 240 V, units up to 0.75 kW Compatibility with 3-phase, 380 to 480 V, units up to 1.1 kW	
ACS-CHK-C3	64324080		Compatibility with 1-phase, 200 to 240 V, units from 1.1 to 2.2 kW Compatibility with 3-phase, 200 to 240 V, units from 1.1 to 2.2 kW Compatibility with 3-phase, 380 to 480 V, units from 1.5 to 2.2 kW	
NOCH-0016-6x	61445412		Compatibility with 3-phase, 200 to 240 V, units from 3 to 4 kW Compatibility with 3-phase, 380 to 480 V, units from 3 to 7.5 kW	
NOCH-0030-6x	61445439		Compatibility with 3-phase, 200 to 240 V, units from 5.5 to 7.5 kW Compatibility with 3-phase, 380 to 480 V, units from 11 to 18.5 kW	
NOCH-0070-6x	61445455		Compatibility with 3-phase, 200 to 240 V, unit 11 kW Compatibility with 3-phase, 380 to 480 V, unit 22 kW	
<b>EMC filters</b>				
RFI-11	68902371		Compatibility with category C1 and C2, 1-phase, 0.37 kW	
RFI-12	68902401		Compatibility with category C1 and C2, 1-phase, 0.75 to 1.1 kW	
RFI-13	68902410		Compatibility with category C1 and C2, 1-phase, 1.5 to 2.2 kW	
RFI-32	68902495		Compatibility with category C1 and C2, 3-phase, 0.37 to 4.0 kW	
RFI-33	68902509		Compatibility with category C1 and C2, 3-phase, 5.5 to 11 kW	
RFI-34	3AUA0000023611		Compatibility with category C1 and C2, 3-phase, 15 to 22 kW	
<b>Low leakage current filters</b>				
LRFI-31	3AUA0000050644		Compatibility with 3-phase, 380 to 480 V, units 0.37 to 2.2 kW	
LRFI-32	3AUA0000050645		Compatibility with 3-phase, 380 to 480 V, units 3 to 4 kW	
<b>PC tools, configuration tools and adapters</b>				
DriveWindow Light	64532871		DriveWindow Light is a PC program for easy commissioning and drive monitoring. Includes an RS-232 cable as standard for connecting the drive to the PC.	
MFDT-01	68566380		FlashDrop is a powerful hand held tool that is used to quickly and easily set drive parameters. FlashDrop tool uploads drive parameters directly to unpowered drives and stores up to 20 different drive parameter sets.	
USB serial adapter	68583667		USB, an RS-232 adapter to be used between the PC and the drive. Not needed if the computer has an RS-232 port.	







# Options ACS310

## ACS310 options

Type code	Electrical code/ ordering code		Price (Eur)
<b>Potentiometer and control panels</b>			
	–		Control panel cover, delivered with ACS310 drives as standard
ACS-CP-C	J404		Basic control panel with numeric display and large buttons
ACS-CP-A	J400		Assistant control panel with commissioning and diagnostic assistants. Features a multilingual display and a real-time clock.
ACS/H-CP-EXT	68294673		Control panel mounting kit, enables mounting of the control panel on the cabinet door
ACS/H-CP-EXT-IP66	68829593		Control panel mounting kit with IP66 enclosure, enables mounting of the control panel on the cabinet door
OPMP-01	3AUA0000013086		Control panel holder mounting kit. Includes a panel platform that enables the panel to be removed in the same way as a drive-mounted panel.
<b>NEMA 1 enclosure kits</b>			
MUL1-R1	68566398		NEMA 1 enclosure kit for finger protection and for protection against dirt and dust, available for frame sizes R0 to R2. Total height increases by 43 mm and depth by 8 mm.
MUL1-R3	68566410		NEMA 1 enclosure kit for finger protection and for protection against dirt and dust, available for frame size R3. Total height increases by 63 mm and depth by 8 mm.
MUL1-R4	3AUA0000023888		NEMA 1 enclosure kit for finger protection and for protection against dirt and dust, available for frame size R4. Total height increases by 76 mm and depth by 8 mm.
<b>Extension module</b>			
MREL-01	L511		Relay output extension module. The optional MREL-01 module offers three additional relay outputs, which can be configured for different functions with parameters.
<b>Remote monitoring</b>			
SREA-01	3AUA0000039179		Ethernet adapter with remote monitoring access can send process data, data logs and event messages independently, without a PLC or a dedicated on-site computer. It has an internal web server for configuration and drive access.

# Options ACS310









## ACS310 options

Type code	Electrical code/ ordering code		Price (Eur)
<b>Input chokes</b>			
CHK-01	68711185		Compatibility with 3-phase, 200 to 240 V, unit 0.37 kW Compatibility with 3-phase, 380 to 480 V, units from 0.37 to 1.1 kW
CHK-02	68711193		Compatibility with 3-phase, 200 to 240 V, unit 0.55 kW Compatibility with 3-phase, 380 to 480 V, units from 1.5 to 3 kW
CHK-03	68711215		Compatibility with 3-phase, 200 to 240 V, units 0.75 to 1 kW Compatibility with 3-phase, 380 to 480 V, units from 4 to 5.5 kW
CHK-04	68711231		Compatibility with 3-phase, 200 to 240 V, units 1.5 to 4 kW Compatibility with 3-phase, 380 to 480 V, units from 7.5 to 11 kW
CHK-05	68711240		Compatibility with 3-phase, 380 to 480 V, unit 15 kW
CHK-06	68711266		Compatibility with 3-phase, 200 to 240 V, units 5.5 to 11 kW Compatibility with 3-phase, 380 to 480 V, units from 18.5 to 22 kW
<b>Output chokes</b>			
ACS-CHK-B3	64324063		Compatibility with 1-phase, 200 to 240 V, units up to 0.75 kW Compatibility with 3-phase, 200 to 240 V, units up to 0.75 kW Compatibility with 3-phase, 380 to 480 V, units up to 1.1 kW
ACS-CHK-C3	64324080		Compatibility with 1-phase, 200 to 240 V, units from 1.1 to 2.2 kW Compatibility with 3-phase, 200 to 240 V, units from 1.1 to 2.2 kW Compatibility with 3-phase, 380 to 480 V, units from 1.5 to 2.2 kW
NOCH-0016-6x	61445412		Compatibility with 3-phase, 200 to 240 V, units from 3 to 4 kW Compatibility with 3-phase, 380 to 480 V, units from 3 to 7.5 kW
NOCH-0030-6x	61445439		Compatibility with 3-phase, 200 to 240 V, units from 5.5 to 7.5 kW Compatibility with 3-phase, 380 to 480 V, units from 11 to 18.5 kW
NOCH-0070-6x	61445455		Compatibility with 3-phase, 200 to 240 V, unit 11 kW Compatibility with 3-phase, 380 to 480 V, unit 22 kW
<b>Low leakage current filters</b>			
LRFI-31	3AUA0000050644		Compatibility with 3-phase, 380 to 480 V, units 0.37 to 2.2 kW
LRFI-32	3AUA0000050645		Compatibility with 3-phase, 380 to 480 V, units 3 to 4 kW
<b>EMC filters</b>			
RFI-32	68902495		Compatibility with category C1 and C2, 3-phase, 0.37 to 4.0 kW
RFI-33	68902509		Compatibility with category C1 and C2, 3-phase, 5.5 to 11 kW
RFI-34	3AUA0000023611		Compatibility with category C1 and C2, 3-phase, 15 to 22 kW
<b>PC tools, configuration tools and adapters</b>			
DriveWindow Light	64532871		DriveWindow Light is a PC program for easy commissioning and drive monitoring. Includes an RS-232 cable as standard for connecting the drive to the PC.
MFDT-01	68566380		FlashDrop is a powerful hand held tool that is used to quickly and easily set drive parameters. FlashDrop tool uploads drive parameters directly to unpowered drives and stores up to 20 different drive parameter sets.
USB serial adapter	68583667		USB, an RS-232 adapter to be used between the PC and the drive. Not needed if the computer has an RS-232 port.

# Options

## ACS550

### ACS550 options

Type code	Electrical code/ ordering code			Price (Eur)
<b>Control panels</b>				
ACS-CP-C	J404		Basic control panel with numeric display and large buttons	
ACS-CP-A	J400		Assistant control panel, delivered with ACS550 drives as standard. Features commissioning and diagnostic assistants, a multilingual display and a real-time clock.	
ACS/H-CP-EXT	68294673		Control panel mounting kit, enables mounting of the control panel on the cabinet door	
ACS/H-CP-EXT-IP66	68829593		Control panel mounting kit with IP66 enclosure, enables mounting of the control panel on the cabinet door	
OPMP-01	3AUA0000013086		Control panel holder mounting kit. Includes a panel platform that enables the panel to be removed in the same way as a drive-mounted panel.	
<b>Fieldbus adapter modules <sup>1)</sup></b>				
RDNA-01	K451		DeviceNet™ protocol	
RLON-01	K452		LonWorks® protocol	
RPBA-01	K454		PROFIBUS DP protocol	
RCAN-01	K457		CANopen® protocol	
RCNA-01	K462		ControlNet protocol	
RETA-01	K466		EtherNet/Modbus TCP protocol	
RECA-01	3AUA0000045102		EtherCAT® protocol	
RETA-02	K467		PROFINET IO protocol	
REPL-02	3AUA0000085536		PowerLink protocol	
<b>Remote monitoring</b>				
SREA-01	3AUA0000039179		Ethernet adapter with remote monitoring access can send process data, data logs and event messages independently, without a PLC or a dedicated on-site computer. It has an internal web server for configuration and drive access.	
<b>Relay output extension module <sup>2)</sup></b>				
OREL-01	L511		Three additional relay outputs for pump and fan control or other supervisory functions	
<b>Control options <sup>2)</sup></b>				
OTAC-01	3AUA0000002051		Encoder feedback module	
<b>Brake units</b>				
Frame sizes R1 and R2 are delivered with integrated brake chopper as standard. Other units can use the compact-sized brake units which include brake chopper and resistor.				
ACS-BRK-C	64078372		Resistor's resistance 32 ohm, continuous output power 2 kW, maximum output power for 20 s is 4.5 kW for 200 to 240 V units and 12 kW for 380 to 480 V units	
ACS-BRK-D	64102931		Resistor's resistance 10.5 ohm, continuous output power 7 kW, maximum output power for 20 s is 14 kW for 200 to 240 V units and 42 kW for 380 to 480 V units	







<sup>1)</sup> One slot available for a fieldbus adapter. Modbus EIA-485 built-in as standard.

<sup>2)</sup> One slot available for relay or encoder.











# Options ACS550

## ACS550 options

Type code	Electrical code/ ordering code		Price (Eur)
<b>Brake resistors</b>			
CBR-V 160 DT 281 70R	68691770		Compatibility with 208 to 240 V, units from 0.55 to 0.75 kW
CBR-V 210 DT 281 200R	68569311		Compatibility with 380 to 480 V, units from 0.75 to 1.5 kW
CBR-V 260 DT 281 40R	68691796		Compatibility with 208 to 240 V, units from 1.1 to 3 kW
CBR-V 460 DT 281 80R	68455685		Compatibility with 208 to 240 V, unit 4 kW Compatibility with 380 to 480 V, units from 2.2 to 7.5 kW
<b>Output chokes</b>			
NOCH0016-62	61445412		IP22, compatibility with 380 to 480 V, units from 1.1 to 7.5 kW
NOCH0030-62	61445439		IP22, compatibility with 380 to 480 V, units from 11 to 18.5 kW
NOCH0070-62	61445455		IP22, compatibility with 380 to 480 V, units from 22 to 45 kW
NOCH0120-62	64782126		IP22, compatibility with 380 to 480 V, unit 55 kW
NOCH0016-65	61445421		IP54, compatibility with 380 to 480 V, units from 1.1 to 7.5 kW
NOCH0030-65	61445447		IP54, compatibility with 380 to 480 V, units from 11 to 18.5 kW
NOCH0070-65	61445463		IP54, compatibility with 380 to 480 V, units from 22 to 45 kW
NOCH0120-65	64789503		IP54, compatibility with 380 to 480 V, unit 55 kW
FOCH0260-70	68490308		IP00, compatibility with 380 to 480 V, units from 75 to 132 kW
FOCH0320-50	68612209		IP00, compatibility with 380 to 480 V, units from 160 to 200 kW
FOCH0610-70	68550505		IP00, compatibility with 380 to 480 V, units from 250 to 355 kW
<b>Flange mounting kits</b>			
FMK-A-R1	3AUA0000006788		Flange mounting kit for the frame size R1, IP21
FMK-A-R2	3AUA0000006789		Flange mounting kit for the frame size R2, IP21
FMK-A-R3	3AUA0000006790		Flange mounting kit for the frame size R3, IP21
FMK-A-R4	3AUA0000006791		Flange mounting kit for the frame size R4, IP21
FMK-B-R1	3AUA0000006792		Flange mounting kit for the frame size R1, IP54
FMK-B-R2	3AUA0000006793		Flange mounting kit for the frame size R2, IP54
FMK-B-R3	3AUA0000006796		Flange mounting kit for the frame size R3, IP54
FMK-B-R4	3AUA0000006798		Flange mounting kit for the frame size R4, IP54
<b>PC tools, configuration tools and adapters</b>			
DriveWindow Light	64532871		DriveWindow Light is a PC program for easy commissioning and drive monitoring. Includes an RS-232 cable as standard for connecting the drive to the PC.
MFD-01	68566380		FlashDrop is a powerful hand held tool that is used to quickly and easily set drive parameters. FlashDrop tool uploads drive parameters directly to unpowered drives and stores up to 20 different drive parameter sets.
USB serial adapter	68583667		USB, an RS-232 adapter to be used between the PC and the drive. Not needed if the computer has an RS-232 port.







# Options ACS580

## ACS580 options

Type code	Electrical code/ ordering code			Price (Eur)
<b>Control panels</b>				
ACS-AP-S	J400		Assistant control panel, delivered with ACS580 drives as standard if no other panel option is selected. Features commissioning and diagnostic assistants, a multilingual display and a real-time clock.	
ACS-AP-I	J425		Assistant control panel replaces standard ACS-AP-S control panel. In addition to the standard features, the control panel offers compatibility to ACS880 drives.	
CDUM-01	J424		Blank control panel cover replaces control panel (no control panel)	
CDPI-01+DPMP-02	3AXD50000010763		Combined panel bus adapter and panel platform kit, enables mounting of the control panel on the cabinet door	
DPMP-01	3AUA0000108878		Control panel mounting platform (flush)	
DPMP-02	3AXD50000009374		Control panel mounting platform (surface)	
CDPI-01	3AXD50000004419		Panel bus adapter	
<b>Fieldbus adapter modules <sup>1)</sup></b>				
FDNA-01	K451		DeviceNet™ protocol	
FPBA-01	K454		PROFIBUS DP protocol	
FCAN-01	K457		CANopen® protocol	
FCNA-01	K462		ControlNet protocol	
FENA-11	K473		Ethernet (EtherNet/IP™, Modbus/TCP, PROFINET) protocol	
FENA-21	K467		PROFINET IO protocol	
FECA-01	K469		EtherCAT® protocol	
FSCA-01	K458		Modbus/RTU	
FEPL-02	K470		Ethernet POWERLINK protocol	

# Options ACS580

## ACS580 options

Type code	Electrical code/ ordering code			Price (Eur)
<b>Remote monitoring</b>				
NETA-21	3AUA0000094517		Ethernet adapter with remote monitoring access can send process data, data logs and event messages independently, without a PLC or a dedicated on-site computer. It has an internal web server for configuration and drive access.	
<b>Input/output extension module</b>				
CMOD-01	3AXD5000004420		External 24 V AC and DC input 2 x RO and 1 x DO	
CMOD-02	3AXD5000004418		External 24 V AC and DC input and isolated PTC interface	
CHDI-01	3AXD5000004431		six 115/230 V AC digital inputs and two relay outputs	
<b>Brake units</b>				
Frame sizes R0, R1, R2 and R3 are delivered with integrated brake chopper as standard. Other units can use external braking choppers and resistors or integrated braking chopper and resistor unit.				
ACS-BRK-D	64102931		Resistor's resistance 10.5 ohm, continuous output power 7 kW, maximum output power for 20 s is 42 kW for 380 to 480 V units	
NBRA-658	59006428		Braking chopper module, maximum braking power up to 230 kW depending on frame and used brake resistor.	
<b>Flange mounting kits</b>				
6438177339694	3AXD50000018852		Flange mounting kit for the frame size R6, IP21	
6438177339700	3AXD50000018853		Flange mounting kit for the frame size R7, IP21	
6438177339816	3AXD50000018854		Flange mounting kit for the frame size R8, IP21	
6438177339823	3AXD50000018855		Flange mounting kit for the frame size R9, IP21	
<b>PC tools, configuration tools and adapters</b>				
Drive composer entry	Download free from <a href="http://www.abb.com/drives">www.abb.com/drives</a>		Drive composer PC tool for startup, configuration, monitoring and process tuning. PC tool is connected to the drive's control panel via USB interface.	
DCPT-01 Drive composer pro	3AUA0000108087 (single user license) 3AUA0000145150 (10 users license) 3AUA0000145151 (20 users license)		Drive composer pro provides the same standard functionality as the free version and some additional features, like graphic control diagrams. The tool has fast monitoring capabilities of multiple signals from several drives in the panel bus. Full backup and restore functions are also included.	
CCA-01	3AXD50000019865		Cold configuration adapter provides serial communication interface to unpowered drives. This adapter ensures safety isolation of both serial communication and control board power supply. The power supply is taken from PC USB port.	

# Introducing the most extensive drives portfolio in the world



### **ABB low voltage AC drives**

The ABB low voltage AC drives product range, from 0.18 to 5600 kW, is the widest available from any manufacturer. These drives are the global benchmark that signifies reliability, simplicity, flexibility and ingenuity throughout the entire life cycle of the drive.

Several ABB drives feature calculators that provide energy consumption data. This information can be used to further analyze and tune a process for even greater energy savings.

The portfolio is supported by a selection of PC tools, fieldbus and communication options.

### **ABB micro drives**

ABB micro drives are suitable for many low power applications such as pumps, fans and conveyors. The focus in our design has been the easy integration into machines, which provides flexible mounting alternatives and straightforward commissioning.

### **ABB general purpose drives**

ABB general purpose drives are ideal in those situations where there is a need for simplicity to install, commission and use. They are designed to control a wide range of standard drives applications, including pump, fan and constant torque use, such as conveyors.

### **ABB machinery drives**

ABB machinery drives can be configured to meet the precise needs of industries and order-based configuration is an integral part of the offering. Covering a wide power and voltage range with standard and optional features, the drives are readily programmable, making their adaptation to different applications easy.

### **ABB motion control products**

ABB offers an extensive range of complete machine control solutions for diverse industrial applications such as labeling, packaging, bottling, pick and place, laser cutting/trimming, stacking, cut-to-length, flying shear, web feeders and high speed rotary wrappers.

### **ABB industrial drives**

The ABB industrial drive portfolio is designed for heavy industrial applications such as those found in pulp and paper, metals, mining, cement, power, chemical, oil and gas, water and wastewater and food and beverage. Drives adapted and approved for use in the marine environment are also included within this portfolio.

### **Industry specific drives**

Our industry specific ABB drives provide our customers with dedicated drive solutions for AC motor control used in industries such as HVAC and water and wastewater. Working closely with these industries, we have developed targeted functionality to help you improve your overall operating performance while also helping to reduce energy use. Built-in application macros in the drives help you easily setup and tailor processes.

### **ABB DC drives**

ABB's DC drive portfolio, from 9 to 18000 kW, provides the highest power-to-size ratio on the market. The drives are designed for most industries including metals, cement, mining, pulp and paper, printing, food and beverage, wire manufacturing, test rigs, ski lift and cranes. ABB DC drives are available as complete cabinets, modules for cabinet assembly, and as retrofit kits. With built-in field exciters and integrated PLC's, they are the best DC drives choice for all new and retrofit applications.

To find more information please visit: [www.abb.com/drives](http://www.abb.com/drives)

# Life cycle services

## Your choice, your future

Your future takes the course of the service you choose for your drives.

Whatever your choice, it should be a well-informed decision. No guesswork. We have the expertise and experience to help you find and implement the right service for your drive equipment.

You can start by asking yourself these two critical questions:

- How do I want to maintain my drives?
- What would my optimal service options be?

### Your choice, your business efficiency

ABB Drive Care agreement lets you focus on your core business. A selection of predefined service options matching your needs provides optimal, more reliable performance, extended drive lifetime and improved cost control. So you can reduce the risk of unplanned downtime and find it easier to budget for maintenance.

### We can help you more by knowing where you are!

Register your drive at [www.abb.com/drivereg](http://www.abb.com/drivereg) for extended warranty options and other benefits.



## Service offerings for your business

Your needs in service usually depend on your operation, priorities, and life cycle phase of your equipment. Here are the most typical service needs with some of our service product options that satisfy them:

### Is performance most critical to your operation?

Get optimal performance out of your machinery and systems.

#### Supporting services include:

- Training
- Inspections and Diagnostics
- Hardware and Control Upgrades
- Retrofits
- Workshop Repair

### Need to extend your assets' lifetime?

Maximize your drive's lifetime with our services.

#### Supporting services include:

- Life Cycle Assessment
- Hardware and Control Upgrades
- Retrofits
- Replacement, Disposal and Recycling

### Is uptime your priority?

Keep your drives running with precisely planned and executed maintenance.

#### Supporting services include:

- Life Cycle Assessment
- Installation and Commissioning
- Spare Parts
- Preventive Maintenance
- Reconditioning

### Is rapid response a key consideration?

If your drives require immediate action, our global network is at your service.

#### Supporting services include:

- Technical Support
- Drive Exchange
- On-site repairs
- Remote Support





# Contact us

For more information please contact your local ABB representative or visit:

[www.abb.com/drives](http://www.abb.com/drives)

[www.abb.com/drivespartners](http://www.abb.com/drivespartners)

© Copyright 2015 ABB. All rights reserved.  
Specifications subject to change without notice.

3AFE6896200 REV E EN 3.2.2015