

6-292132-4 ✓ ACTIVE

AMP CT

TE Internal #: 6-292132-4

PCB Mount Header, Vertical, Wire-to-Board, 4 Position, 2 mm [.079 in] Centerline, Partially Shrouded, Tin (Sn), Through Hole - Solder, AMP CT

[View on TE.com >](#)



Connectors > PCB Connectors > PCB Headers & Receptacles > CT 2mm Post Header Asmbly: Box V DIP

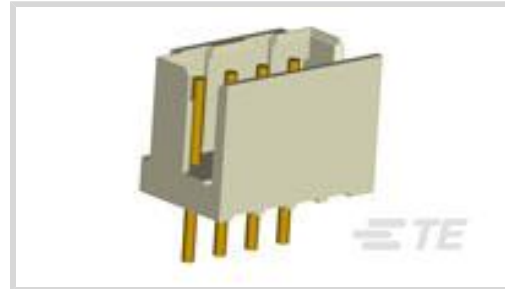

PCB Connector Type: **PCB Mount Header**

PCB Mount Orientation: **Vertical**

Connector System: **Wire-to-Board**

Number of Positions: **4**

Centerline (Pitch): **2 mm [.079 in]**

[All CT 2mm Post Header Asmbly: Box V DIP \(81\)](#)

Features

Product Type Features

PCB Connector Type	PCB Mount Header
Connector System	Wire-to-Board
Header Type	Partially Shrouded
Sealable	No
Connector & Contact Terminates To	Printed Circuit Board
Connector Product Type	Connector Assembly

Configuration Features

PCB Mount Orientation	Vertical
Number of Positions	4
Number of Rows	1

Electrical Characteristics

Operating Voltage	125 VDC
-------------------	---------

Body Features

Primary Product Color	Black
-----------------------	-------

Contact Features

Mating Pin Diameter	.6 mm [.024 in]
---------------------	-----------------



PCB Contact Termination Area Plating Material Thickness	1 µm[39.37 µin]
Contact Shape & Form	Round
Contact Layout	Inline
Contact Mating Area Length	4.2 mm[.165 in]
Contact Base Material	Brass
Contact Mating Area Plating Material	Tin (Sn)
Contact Mating Area Plating Material Finish	Matte
Contact Mating Area Plating Material Thickness	1 µm[39.37 µin]
Contact Type	Pin
Contact Current Rating (Max)	4 A
PCB Contact Termination Area Plating Material	Tin

Termination Features

Termination Post & Tail Diameter	.6 mm[.024 in]
Termination Post & Tail Length	3.2 mm[.126 in]
Termination Method to PCB	Through Hole - Solder

Mechanical Attachment

Mating Retention Type	Polarized Lock
Mating Alignment Type	Polarization
PCB Mount Retention Type	Kinked Legs
PCB Mount Alignment Type	Kinked Legs
PCB Mount Alignment	Without
Mating Retention	Without
PCB Mount Retention	With
Connector Mounting Type	Board Mount
Mating Alignment	With

Housing Features

Centerline (Pitch)	2 mm[.079 in]
Housing Material	Nylon 66

Dimensions

Connector Width	5.8 mm[.228 in]
PCB Thickness (Recommended)	.8 mm[.031 – .063 in]
Connector Height	6.8 mm[.267 in]
Connector Length	9.8 mm[.386 in]



Usage Conditions

Operating Temperature Range	-40 – 105 °C[-40 – 221 °F]
-----------------------------	----------------------------

Operation/Application

Assembly Process Feature	Pick and Place Cover
Circuit Application	Power & Signal

Industry Standards

Compatible With Agency/Standards Products	CSA, UL
Compatible With Approved Standards Products	CSA LR7189, UL E28476
UL Flammability Rating	UL 94V-0

Packaging Features

Packaging Quantity	1000
Packaging Method	Bag, Box

Product Compliance

[For compliance documentation, visit the product page on TE.com>](#)

EU RoHS Directive 2011/65/EU	Compliant
EU ELV Directive 2000/53/EC	Compliant
China RoHS 2 Directive MIIT Order No 32, 2016	No Restricted Materials Above Threshold
EU REACH Regulation (EC) No. 1907/2006	Current ECHA Candidate List: JAN 2025 (247) Candidate List Declared Against: JAN 2025 (247) Does not contain REACH SVHC
Halogen Content	Low Halogen - Br, Cl, F, I < 900 ppm per homogenous material. Also BFR/CFR/PVC Free
Solder Process Capability	Wave solder capable to 265°C

Product Compliance Disclaimer

This information is provided based on reasonable inquiry of our suppliers and represents our current actual knowledge based on the information they provided. This information is subject to change. The part numbers that TE has identified as EU RoHS compliant have a maximum concentration of 0.1% by weight in homogenous materials for lead, hexavalent chromium, mercury, PBB, PBDE, DBP, BBP, DEHP, DIBP, and 0.01% for cadmium, or qualify for an exemption to these limits as defined in the Annexes of Directive 2011/65/EU (RoHS2). Finished electrical and electronic equipment products will be CE marked as required by Directive 2011/65/EU. Components may not be CE marked. Additionally, the part numbers that TE has identified as EU ELV compliant have a maximum concentration of 0.1% by weight in homogenous materials for lead, hexavalent chromium, and mercury, and 0.01% for cadmium, or qualify for an exemption to these limits as defined in the Annexes of Directive 2000/53/EC (ELV). Regarding the REACH Regulation, the information TE provides

on SVHC in articles for this part number is based on the latest European Chemicals Agency (ECHA) 'Guidance on requirements for substances in articles' posted at this URL: <https://echa.europa.eu/guidance-documents/guidance-on-reach>

Compatible Parts



TE Part # CAT-AM7017-H8172
AMP COMMON TERMINATION HOUSINGS



TE Part # CAT-AM7017-C7671
Common Termination Contacts — POWER TRIPLE LOCK



TE Part # CAT-AM7053-C7671
Mini Common Termination Contacts

Also in the Series | AMP CT



Connector Contacts(8)



Connector Hardware(39)



PCB Headers & Receptacles(739)



Rectangular Connector Housings(74)



Rectangular Power Connectors(883)

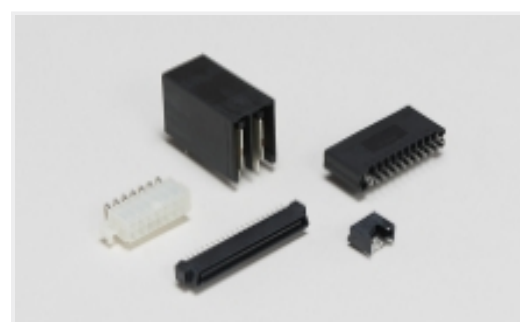

Standard Rectangular Connectors(229)

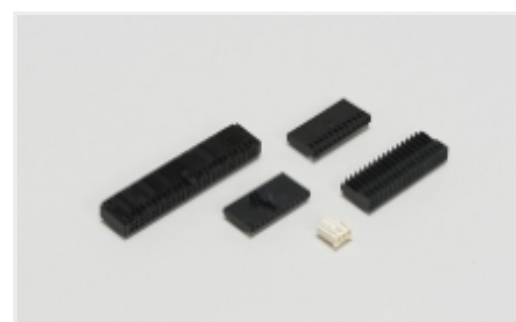

Wire-to-Board Connector Assemblies & Housings(165)



Wire-to-Board Headers & Receptacles (739)

Customers Also Bought



TE Part #179317-4
HYBRID MINI DRAWER REC CONT.#2



TE Part #179322-3
HYBRID MINI DRAWER TAB CONT.#2



TE Part #4-292249-2
1.5 MINI CT LATTICE PLUG/KIT K



TE Part #4-292254-2
CT RELAY HDR ASSY 2P YELLOW

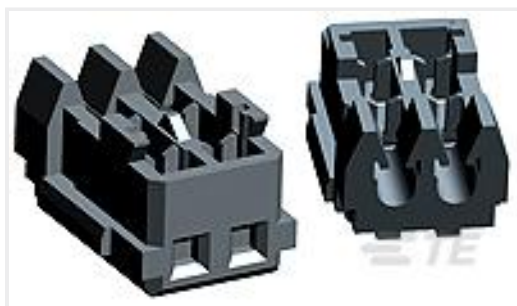

TE Part #1-353293-3
MINI CT MT REC ASSY 13P GRAY

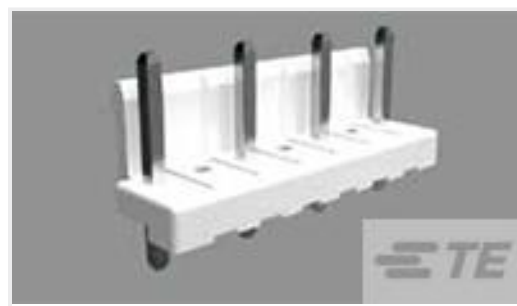

TE Part #5-1123724-4
3.96EP HDR ASSY 4(7)P BLACK



TE Part #7-1625868-1
RP 2A 0.25W 28R7 0.1% 25PPM 1K RL



TE Part #1735251-3
SKT,SODIMM,144P,1.5/1.35V(DDR3),
STD,TY-S



TE Part #5188256-1
2MMHM PIN HDR B MOD 175P-7ROW

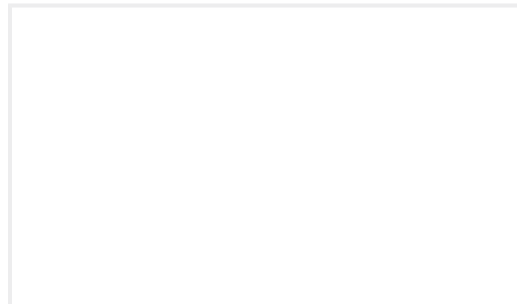

TE Part #9-292131-1
SGL HDR ASSY BOX DIP V POLARIS

Documents

Product Drawings

[CT P/HDR BOX V 4P BLACK](#)

English

CAD Files

[3D PDF](#)

3D

Customer View Model

[ENG_CVM_CVM_6-292132-4_B1.2d_dxf.zip](#)

English

Customer View Model

[ENG_CVM_CVM_6-292132-4_B1.3d_igs.zip](#)

English

Customer View Model

[ENG_CVM_CVM_6-292132-4_B1.3d_stp.zip](#)

English

By downloading the CAD file I accept and agree to the [Terms and Conditions](#) of use.

Product Specifications

[Workmanship Specification](#)

English