

Ordering number CA11016_TINA2-RS

Family	Tina2	FWHM	11 degrees
Type	Assembly	Efficiency	89 %
LED	XP-E2	cd/lm	16.600
Color	Black	Gerber File	Available
Diameter	16.1 mm		
Height	9.7 mm		
Style	Round		
Optic Material	PMMA		
Holder Material	PC		
Fastening	Tape		
Status	Ready		

Ordering number CA11420_TINA2-D

Family	Tina2	FWHM	13 degrees
Type	Assembly	Efficiency	86 %
LED	XP-E2	cd/lm	11.800
Color	Black	Gerber File	Available
Diameter	16.1 mm		
Height	9.66 mm		
Style	Round		
Optic Material	PMMA		
Holder Material	PC		
Fastening	Tape		
Status	Ready		

Ordering number CA11052_TINA2-O

Family	Tina2	FWHM	34+14 degrees
Type	Assembly	Efficiency	86 %
LED	XP-E2	cd/lm	5.100
Color	Black	Gerber File	Available
Diameter	16.1 mm		
Height	9.7 mm		
Style	Round		
Optic Material	PMMA		
Holder Material	PC		
Fastening	Tape		
Status	Ready		

Ordering number CA12056_TINA2-W

Family	Tina2	FWHM	52 degrees
Type	Assembly	Efficiency	89 %
LED	XP-E2	cd/lm	1.200
Color	Black	Gerber File	Available
Diameter	16.1 mm		
Height	9.7 mm		
Style	Round		
Optic Material	PMMA		
Holder Material	PC		
Fastening	Tape		
Status	Ready		



PRODUCT DATASHEET
Tina2 series
last update 22/3/2013

NOTE: The typical divergence will be changed by different color, chip size and chip position tolerance. The typical total divergence is the full angle measured where the luminous intensity is half of the peak value.



PRODUCT DATASHEET

Tina2 series

last update 22/3/2013

GENERAL INFORMATION

- Product series especially designed & optimized for XP-E2 series of LEDs.
- Special care taken to make light distribution as uniform as possible.
- Lens material optical grade PMMA with high UV and temperature resistance. Allows use of high current and temperature conditions.

Please find more information about used material from below:

http://ledil.fi/sites/default/files/Documents/Technical/Material/PMMA%20N%20UL94_Yellow%20Card.pdf

<http://ledil.fi/sites/default/files/Documents/Technical/Material/PMMA%20N%20PLEXIGLAS-Datasheet.pdf>

- Optic holder molded by high quality PC material (120 degrees of Celcius / 248 degrees of Fahrenheit).

- Fastening to heat sink with a PU foam adhesive tape of automotive grade. Please find fastening details by clicking link: http://www.ledil.com/datasheets/DataSheet_TAPE.pdf

NOTE 1: We advise customer to ensure the suitability and sufficiency of the bond in the end product. For example, mechanical stress, vibration and holes on the surface of the circuit board weaken the strength of the tape.

NOTE 2: Assembly to the surface must be made straight, so the tape bonds constant and balanced with fastening surface. Slanted assembly might cause unbalanced bond to the surface. All surfaces where tape is applied must be clean, dry and free from grease and dirt.

If cleaning of PCB surfaces is needed, please follow strictly the cleaning instructions of your LED manufacturer - this is important as cleaning shall under no circumstances damage LEDs or other electronics components on the PCB.

Further note that optical components shall not be cleaned with any chemicals - only micro fiber cloth may be used to remove fingerprints or other traces from handling.

Relative intensity of Tina2-XP-W

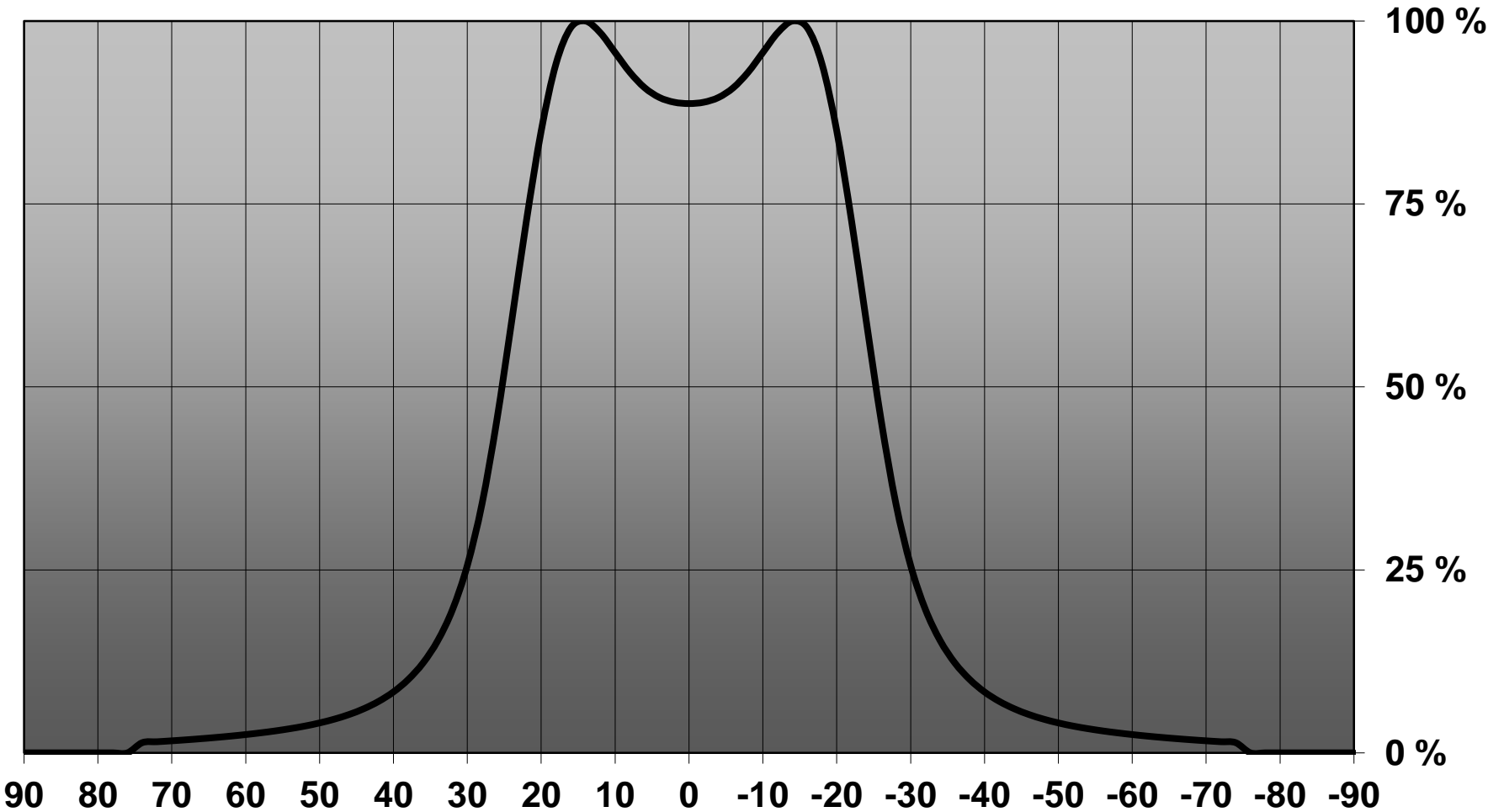

D

C

B

A

4

4

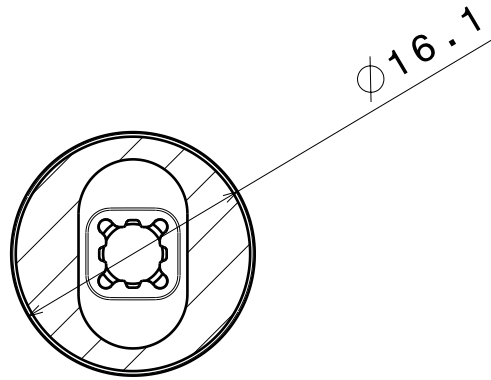

Lens

Holder

Tape

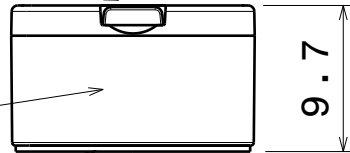

3

3

2

2

MATERIALS

Lens: PMMA

Holder: PC

Tape: PU Foam with PSA

Part no.s:

CA11016_Tina2-XP-RS

CA11017_Tina2-XP-M

CA11052_Tina2-XP-O

CA11420_Tina2-XP-D

This drawing is our property. It can't be reproduced or communicated without our written agreement.



L
T
F
F

e
e
i
i
N
n

d
h

DRAWING TITLE

Datasheet Tina2-XP Tape series

1

1

DRAWN BY

a

DATE

18.5.2011

CHECKED BY

s n

DATE

28.07.2010

DESIGNED BY

HH

DATE

09.11.2009

SIZE

A4

DRAWING NUMBER

-

REV

2

SCALE

2:1

WEIGHT (g)

-

SHEET

1/1

D

A

Luminaire: Ledil Oy CA11016_TINA2-RS (CREE XP-E2 92 lm @ 250 mA) Efficiency=89%
Lamps: 1 x CREE XP-E2 92 lm @ 250 mA

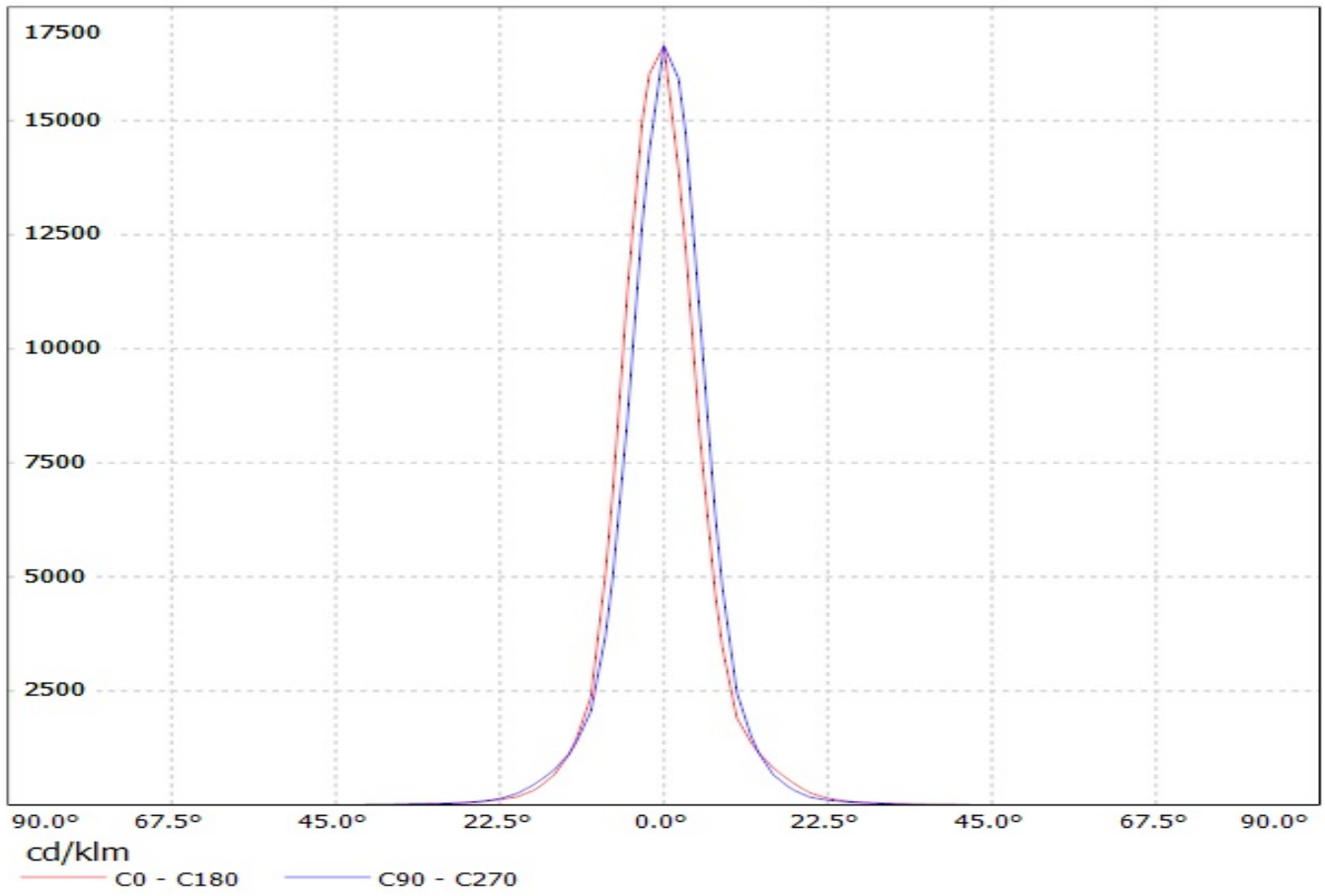

Luminaire: Ledil Oy CA11420_TINA2-D (CREE XP-E2 (92 lm @ 250 mA)) Efficiency=86%
Lamps: 1 x CREE XP-E2 (92 lm @ 250 mA)

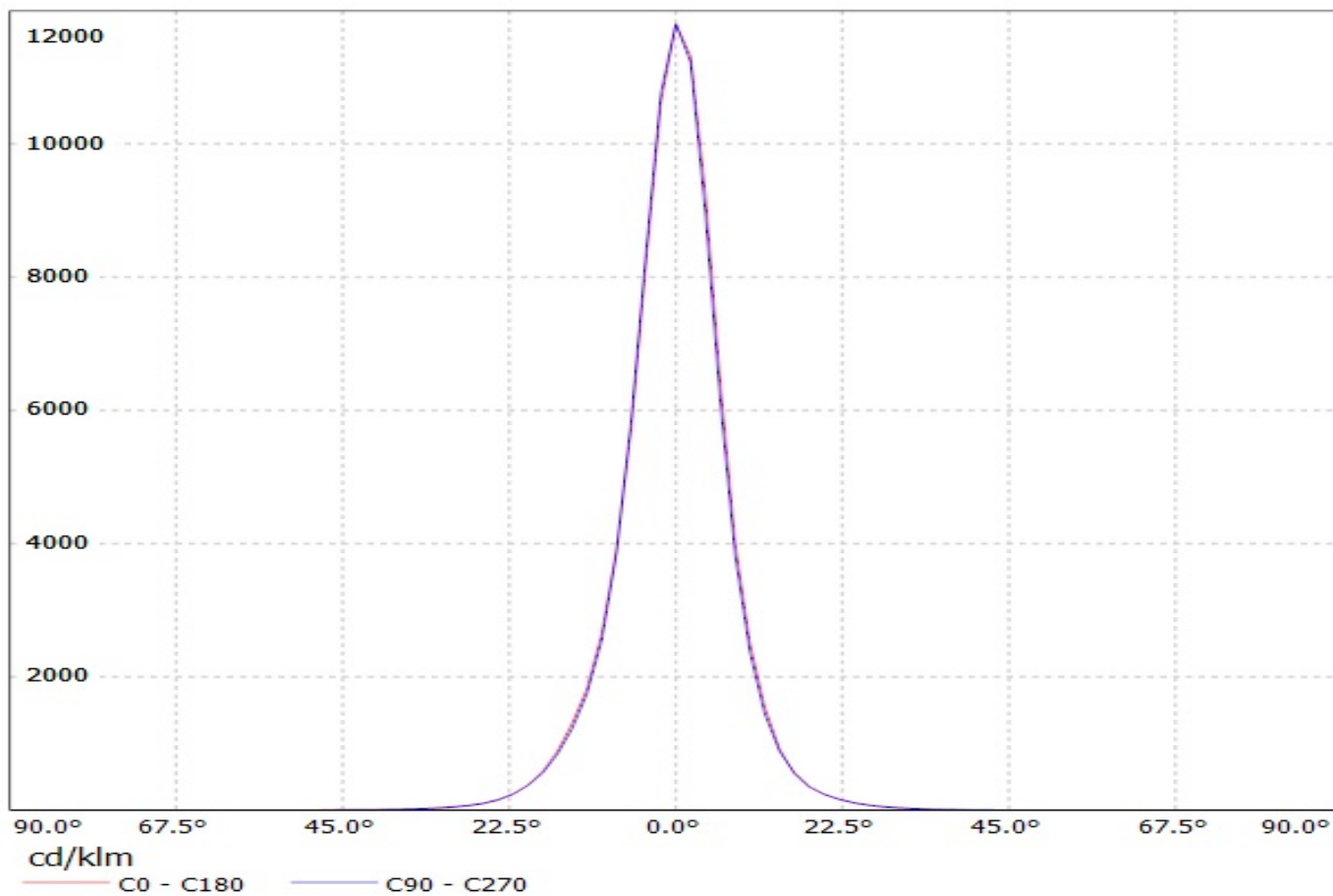

Luminaire: Ledil Oy CA11052_TINA2-O (CREE XP-E2 92 lm @ 250 mA) Efficiency=86%
Lamps: 1 x CREE XP-E2 92 lm @ 250 mA

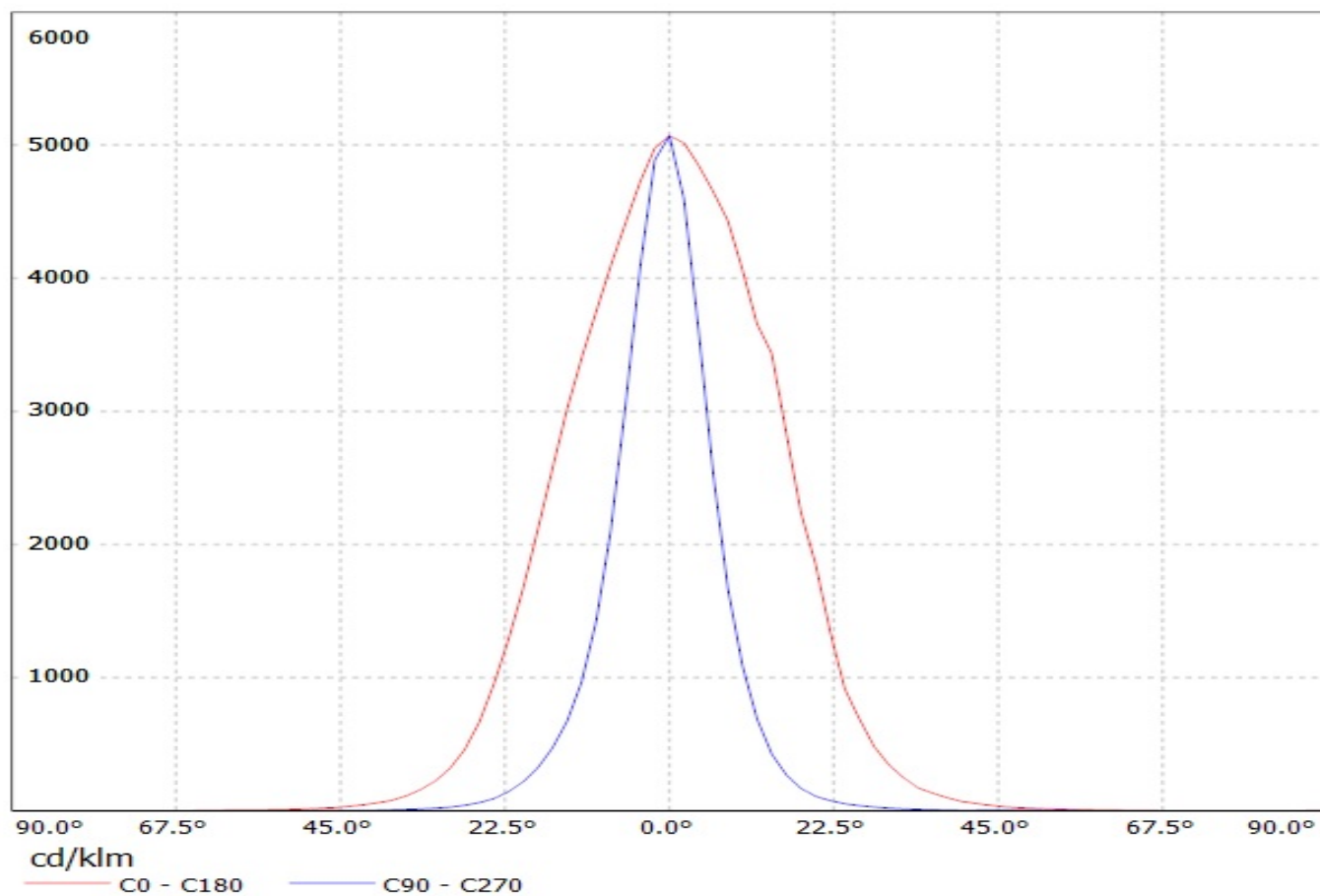

Luminaire: Ledil Oy CA12056_TINA2-W (CREE XP-E2 92 lm @ 250 mA) Efficiency=89%
Lamps: 1 x CREE XP-E2 92 lm @ 250 mA

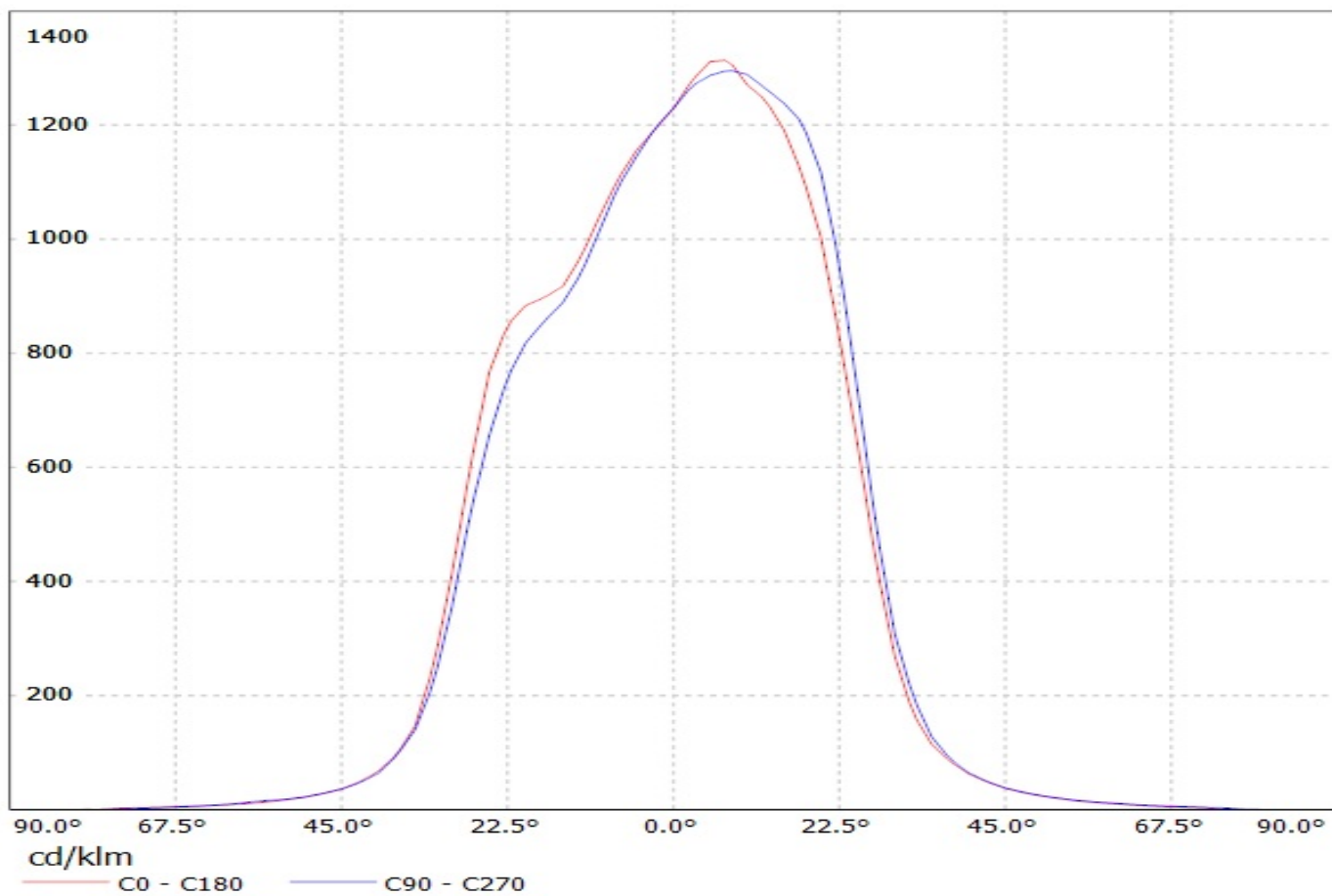

Luminaire: Ledil Oy CA11016_TINA2-RS (CREE XP-E2 92 lm @ 250 mA) Efficiency=89%
Lamps: 1 x CREE XP-E2 92 lm @ 250 mA

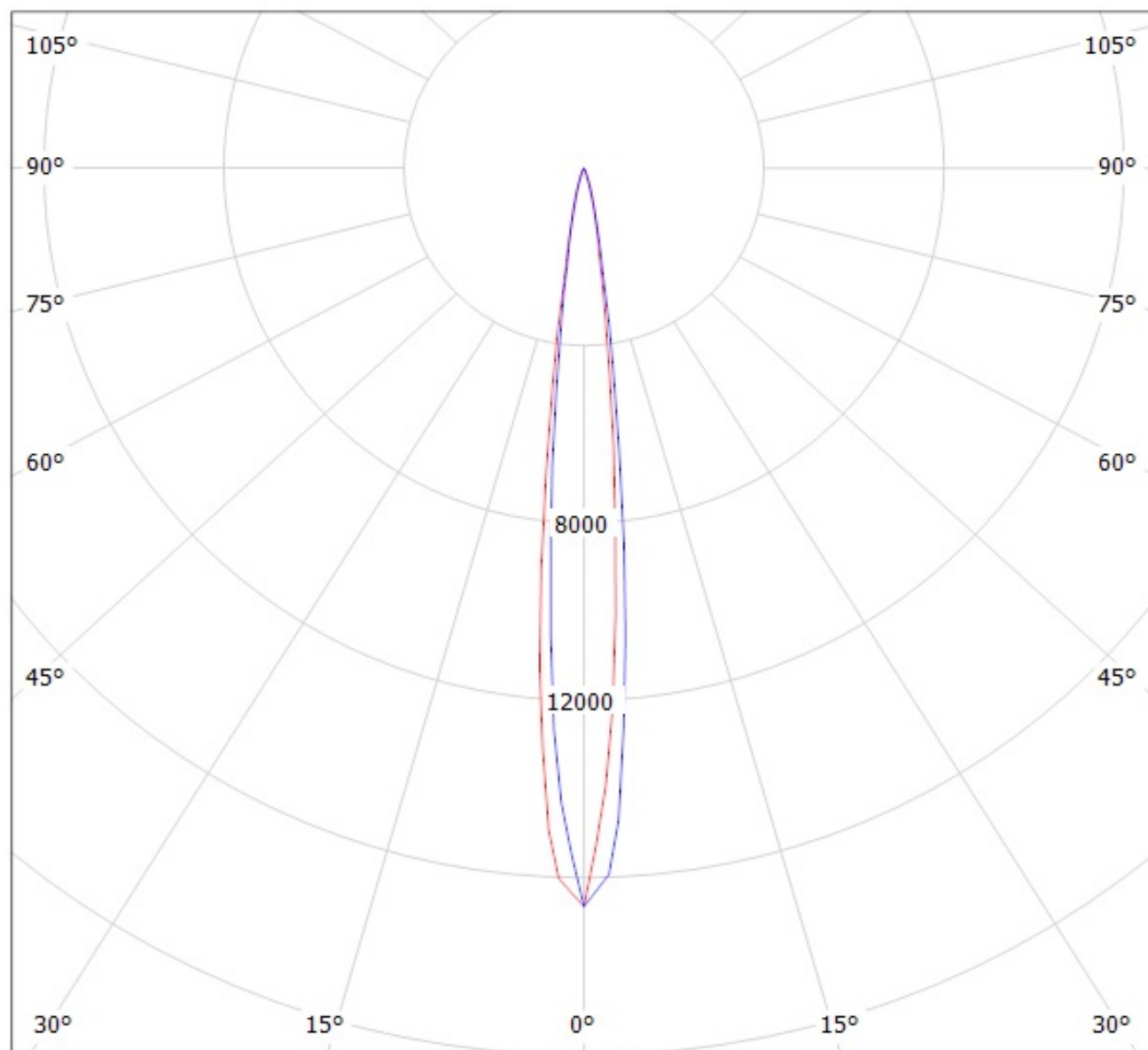

cd/klm

— C0 - C180

— C90 - C270

Luminaire: Ledil Oy CA11420_TINA2-D (CREE XP-E2 (92 lm @ 250 mA)) Efficiency=86%
Lamps: 1 x CREE XP-E2 (92 lm @ 250 mA)

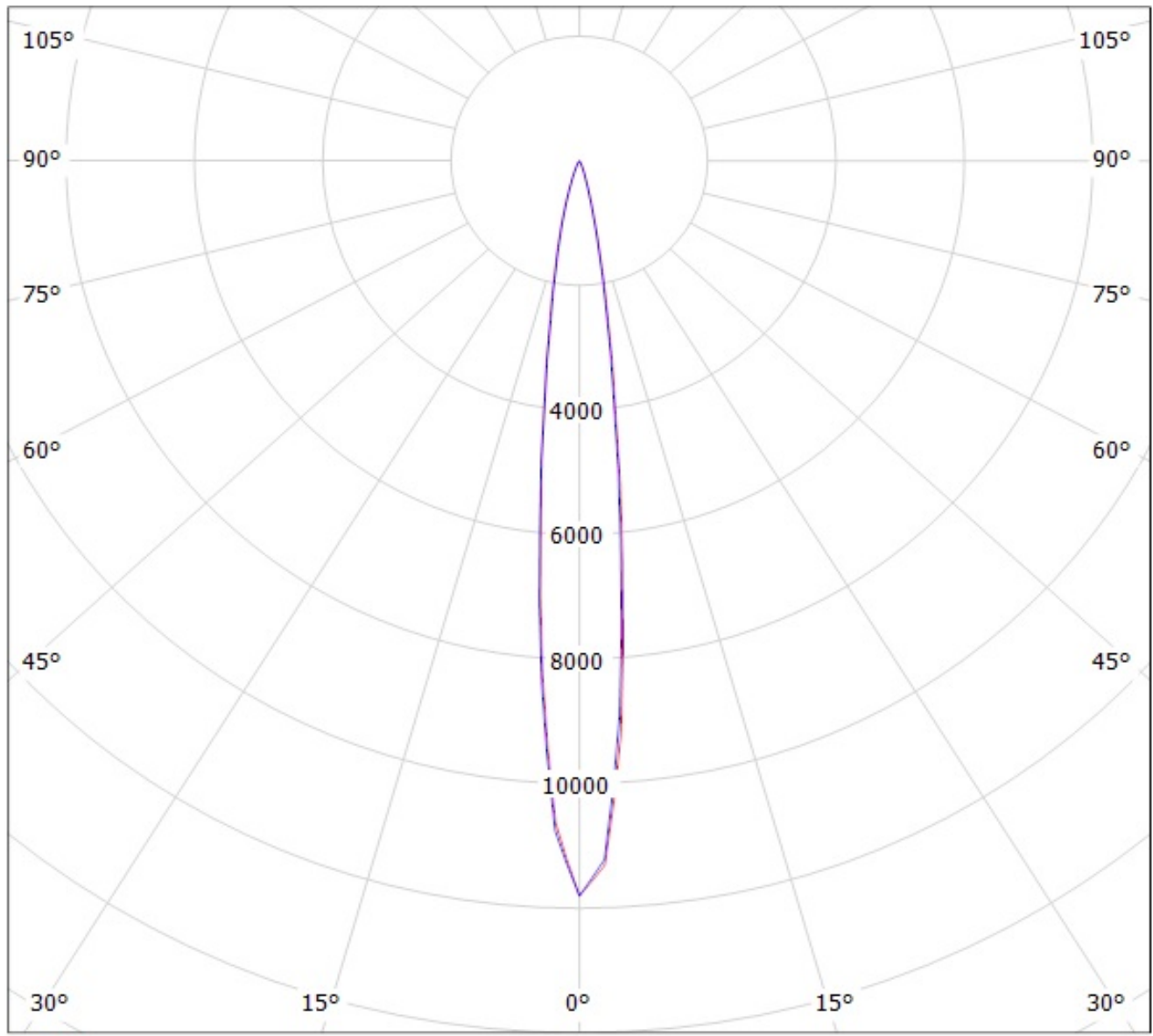

cd/klm

— C0 - C180

— C90 - C270

Luminaire: Ledil Oy CA11052_TINA2-O (CREE XP-E2 92 lm @ 250 mA) Efficiency=86%
Lamps: 1 x CREE XP-E2 92 lm @ 250 mA

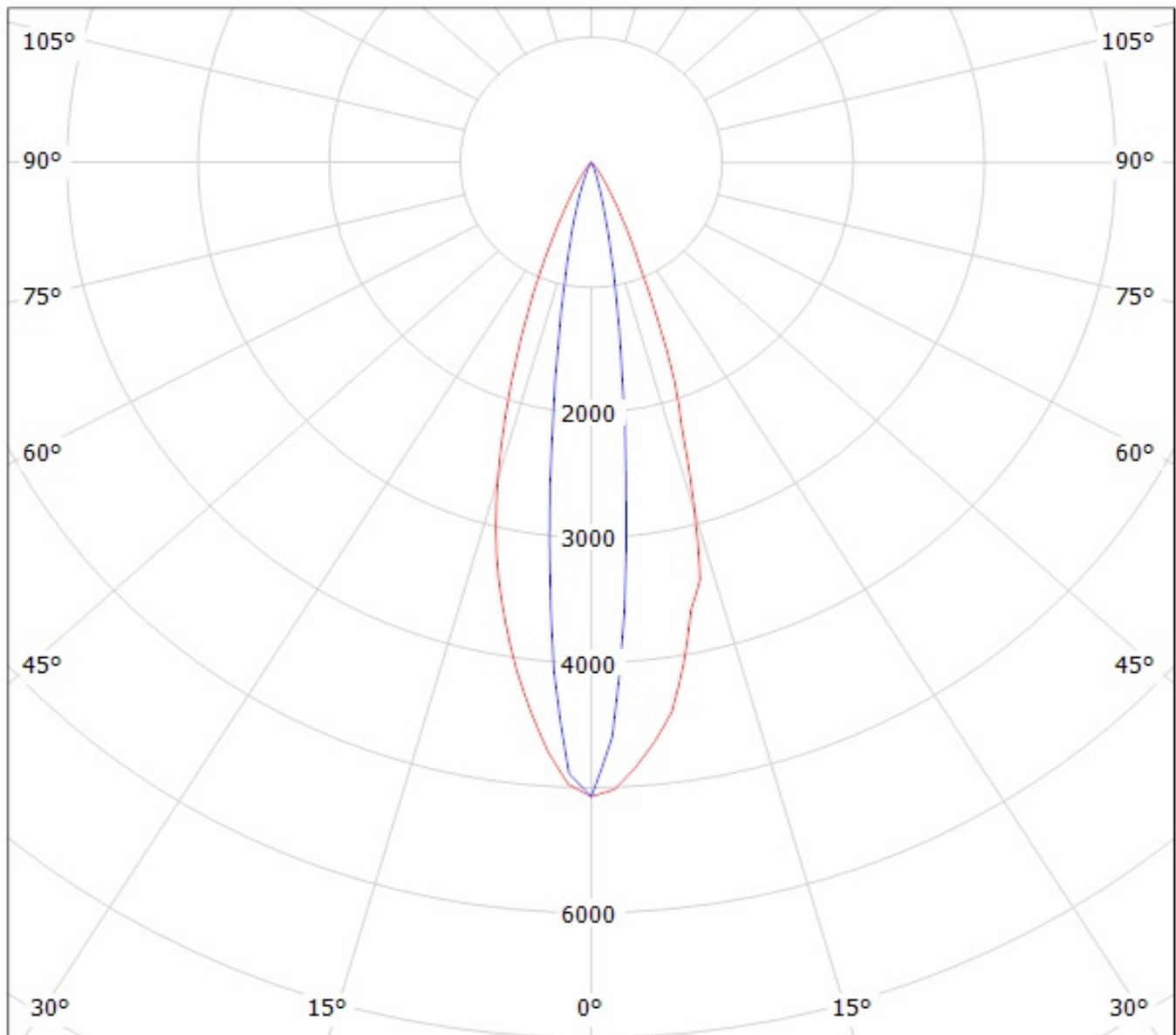

cd/klm

— C0 - C180 — C90 - C270

Luminaire: Ledil Oy CA12056_TINA2-W (CREE XP-E2 92 lm @ 250 mA) Efficiency=89%
Lamps: 1 x CREE XP-E2 92 lm @ 250 mA

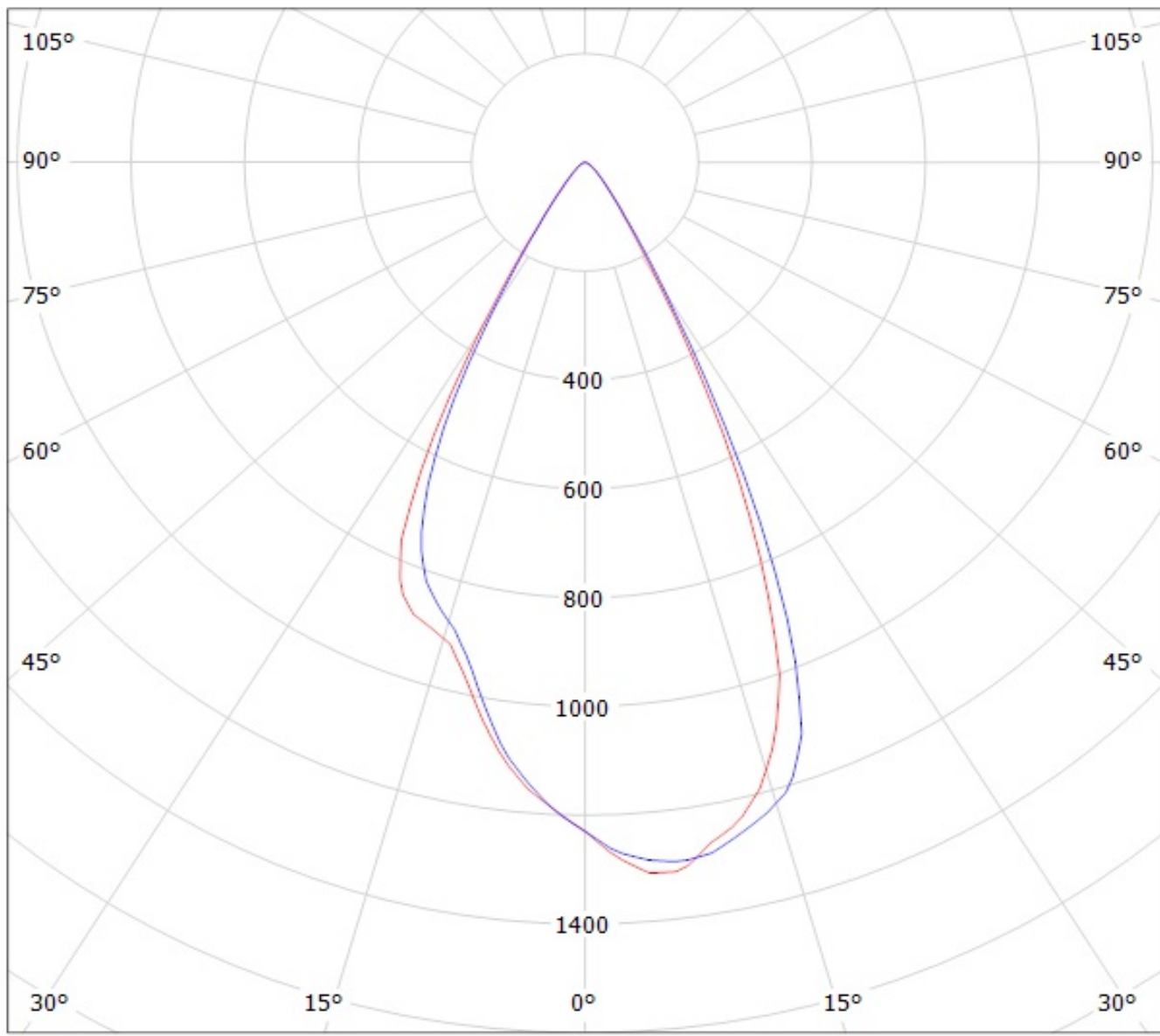

cd/klm
— C0 - C180 — C90 - C270