

ATV320U07N4C

variable speed drive ATV320 - 0.75kW -
380...500V - 3 phase - compact



Main

Range of product	Altivar Machine ATV320
Product or component type	Variable speed drive
Product specific application	Complex machines
Device short name	ATV320
Format of the drive	Compact
Product destination	Asynchronous motors Synchronous motors
EMC filter	Class C2 EMC filter integrated
IP degree of protection	IP20 conforming to EN/IEC 61800-5-1
Degree of protection	UL type 1 with UL type 1 conformity kit
Type of cooling	Fan
Network number of phases	3 phases
[Us] rated supply voltage	380...500 V (- 15...10 %)
Supply frequency	50...60 Hz (- 5...5 %)
Motor power kW	0.75 kW for heavy duty
Motor power hp	1 hp for heavy duty
Line current	2.8 A at 500 V for heavy duty 3.6 A at 380 V for heavy duty
Prospective line I _{sc}	<= 5 kA
Apparent power	2.4 kVA at 500 V for heavy duty
Continuous output current	2.3 A at 4 kHz for heavy duty
Maximum transient current	3.5 A during 60 s for heavy duty
Asynchronous motor control profile	Voltage/Frequency ratio, 2 points Voltage/Frequency ratio, 5 points Flux vector control without sensor, standard Voltage/Frequency ratio - Energy Saving, quadratic U/f Flux vector control without sensor - Energy Saving
Synchronous motor control profile	Vector control without sensor
Speed drive output frequency	0.1...599 Hz

Disclaimer: This documentation is not intended as a substitute for and is not to be used for determining suitability or reliability of these products for specific user applications

Nominal switching frequency	4 kHz
Switching frequency	2...16 kHz adjustable
Safety function	STO (safe torque off) SIL 2
Communication port protocol	CANopen Modbus
Option card	Communication module: CANopen daisy chain RJ45 Communication module: CANopen SUB-D 9 Communication module: EtherCAT RJ45 Communication module: Profinet Communication module: Ethernet Powerlink Communication module: CANopen open style terminal block Communication module: Ethernet/IP Communication module: DeviceNet Communication module: Profibus DP V1

Offer Sustainability

Sustainable offer status	Not Green Premium product
RoHS (date code: YYWW)	Compliant - since 1610 - Schneider Electric declaration of conformity Schneider Electric declaration of conformity
REACH	Reference not containing SVHC above the threshold Reference not containing SVHC above the threshold

Complementary

Output voltage	\leq power supply voltage
Permissible temporary current boost	1.5 x I_n during 60 s for heavy duty
Speed range	1...100 with asynchronous motor in open-loop mode
Speed accuracy	+/- 10 % of nominal slip 0.2 T_n to T_n
Torque accuracy	+/- 15 %
Transient overtorque	170...200 % of nominal motor torque
Braking torque	< 170 % with braking resistor during 60 s
Regulation loop	Adjustable PID regulator
Motor slip compensation	Automatic whatever the load Not available in voltage/frequency ratio (2 or 5 points) Adjustable 0...300 %
Acceleration and deceleration ramps	S U CUS Deceleration ramp automatic stop DC injection Deceleration ramp adaptation Linear Ramp switching
Braking to standstill	By DC injection
Protection type	Drive: input phase breaks Drive: overheating protection Drive: thermal protection Drive: overcurrent between output phases and earth Drive: short-circuit between motor phases
Frequency resolution	Display unit: 0.1 Hz Analog input: 0.012/50 Hz
Electrical connection	Control, screw terminal: 0.5...1.5 mm ² AWG 20...AWG 16 Motor/Braking resistor, screw terminal: 2.5...6 mm ² AWG 14...AWG 10 Power supply, screw terminal: 2.5...6 mm ² AWG 14...AWG 10
Type of connector	1 RJ45 for Modbus/CANopen on control terminal
Physical interface	2-wire RS 485 for Modbus
Transmission frame	RTU for Modbus
Transmission rate	4.8, 9.6, 19.2, 38.4 kbit/s for Modbus 50 kbps, 125 kbps, 250 kbps, 500 kbps, 1 Mbps for CANopen
Data format	8 bits, configurable odd, even or no parity for Modbus
Type of polarization	No impedance for Modbus
Number of addresses	1...127 for CANopen

	1...247 for Modbus
Method of access	Slave for CANopen
Supply	Internal supply for reference potentiometer (1 to 10 kOhm): 10.5 V DC (+/- 5 %) current <= 10 mA (overload and short-circuit protection)
Local signalling	1 LED green for CANopen run 1 LED red for CANopen error 1 LED red for drive fault
Width	105 mm
Height	142 mm 188 mm with EMC plate
Depth	158 mm
Product weight	1.2 kg
Analogue input number	3
Analogue input type	Voltage (AI1): 0...10 V DC, impedance 30000 Ohm, resolution 10 bits Bipolar differential voltage (AI2): +/- 10 V DC, impedance 30000 Ohm, resolution 10 bits Current (AI3): 0...20 mA (or 4-20 mA, x-20 mA, 20-x mA or other patterns by configuration), impedance 250 Ohm, resolution 10 bits
Discrete input number	7
Discrete input type	Programmable (sink/source) (DI1...DI4): 24...30 V DC: level 1 PLC Switch-configurable PTC probe (DI6): 24...30 V DC Safe torque off (STO): 24...30 V DC, impedance 1500 Ohm Programmable as pulse input 20 kpps (DI5): 24...30 V DC: level 1 PLC
Discrete input logic	Negative logic (sink): : DI1...DI6, > 19 V (state 0) < 13 V (state 1) Positive logic (source): : DI1...DI6, < 5 V (state 0) > 11 V (state 1)
Analogue output number	1
Analogue output type	Software-configurable voltage (AQ1): 0...10 V, impedance 470 Ohm, resolution 10 bits Software-configurable current (AQ1): 0...20 mA, impedance 800 Ohm, resolution 10 bits
Sampling duration	Analog output (AQ1): 2 ms Analog input (AI1, AI2, AI3): 2 ms
Accuracy	Analog output AQ1: +/- 1 % for a temperature of 25 °C Analog input AI1, AI2, AI3: +/- 0.2 % for a temperature of -10...60 °C Analog input AI1, AI2, AI3: +/- 0.5 % for a temperature of 25 °C Analog output AQ1: +/- 2 % for a temperature of -10...60 °C
Linearity error	Analog input (AI1, AI2, AI3): +/- 0.2...0.5 % of maximum value Analog output (AQ1): +/- 0.3 %
Discrete output number	3
Discrete output type	Configurable relay logic NO (R2A, R2B): electrical durability 100000 cycles Logic (LO) Configurable relay logic NO/NC (R1A, R1B, R1C): electrical durability 100000 cycles
Refresh time	Logic input (DI1...DI6): 8 ms (+/- 0.7 ms) Relay output (R2A, R2C): 2 ms Relay output (R1A, R1B, R1C): 2 ms
Minimum switching current	Relay output (R1, R2): 5 mA at 24 V DC
Maximum switching current	Relay output (R1, R2) on inductive load (cos phi = 0.4: 2 A at 30 V DC Relay output (R1) on resistive load (cos phi = 1: 3 A at 250 V AC Relay output (R2) on resistive load (cos phi = 1: 5 A at 250 V AC Relay output (R2) on resistive load (cos phi = 1: 5 A at 30 V DC Relay output (R1) on resistive load (cos phi = 1: 4 A at 30 V DC Relay output (R1, R2) on inductive load (cos phi = 0.4: 2 A at 250 V AC
Specific application	Machinery

Environment

Isolation	Between power and control terminals
Insulation resistance	> 1 mOhm at 500 V DC for 1 minute to earth
Noise level	51 dB conforming to 86/188/EEC
Power dissipation in W	38 W (fan) at 380 V, 4 kHz
Volume of cooling air	18 m3/h
Operating position	Vertical +/- 10 degree
Electromagnetic compatibility	1.2/50 µs - 8/20 µs surge immunity test conforming to IEC 61000-4-5 level 3 Electrostatic discharge immunity test conforming to IEC 61000-4-2 level 3 Conducted radio-frequency immunity test conforming to IEC 61000-4-6 level 3

Radiated radio-frequency electromagnetic field immunity test conforming to IEC 61000-4-3 level 3
Voltage dips and interruptions immunity test conforming to IEC 61000-4-11
Electrical fast transient/burst immunity test conforming to IEC 61000-4-4 level 4

Pollution degree	2 conforming to EN/IEC 61800-5-1
Vibration resistance	1.5 mm peak to peak (f = 2...13 Hz) conforming to EN/IEC 60068-2-6 1 gn (f = 13...200 Hz) conforming to EN/IEC 60068-2-6
Shock resistance	15 gn during 11 ms conforming to EN/IEC 60068-2-27
Relative humidity	5...95 % without dripping water conforming to IEC 60068-2-3 5...95 % without condensation conforming to IEC 60068-2-3
Ambient air temperature for operation	-10...50 °C without derating 50...60 °C with derating factor
Ambient air temperature for storage	-25...70 °C
Operating altitude	<= 1000 m without derating 1000...3000 m with current derating 1 % per 100 m
Standards	EN/IEC 61800-5-1 IEC 13849-1 IEC 60721-3 EN/IEC 61800-3 EN/IEC 61800-3 environment 1 category C2 IEC 61508
Product certifications	CSA NOM 117 UL RCM EAC
Marking	CE

Dimensions

Views: Right - Front - Front with EMC Plate

mm
in.

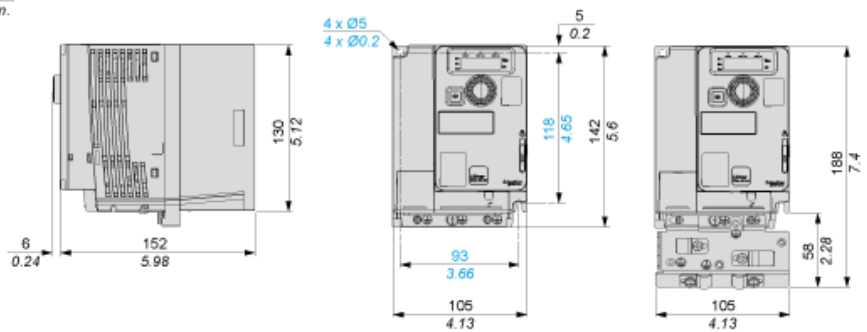

Mounting Types

Mounting Type A: Individual with Ventilation Cover

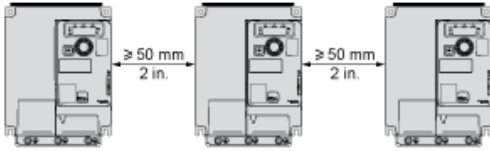

Only Possible at Ambient Temperature Less or Equal to 50 °C (122 °F)

Mounting Type B: Side by Side, Ventilation Cover Removed

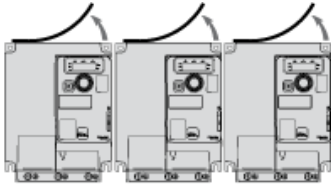

Mounting Type C: Individual, Ventilation Cover Removed

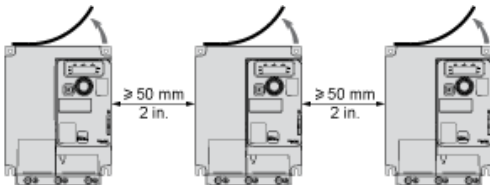

For Operation at Ambient Temperature Above 50 °C (122 °F)

Digital Inputs Wiring

The logic input switch (SW1) is used to adapt the operation of the logic inputs to the technology of the programmable controller outputs. Switch SW1 set to “Source” position and use of the output power supply for the DIs.

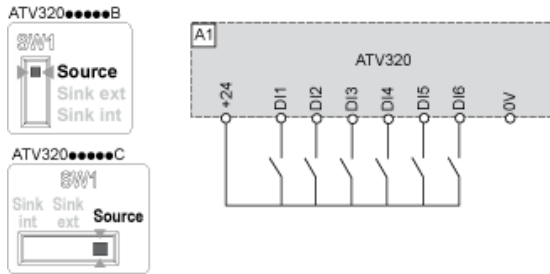

Switch SW1 set to “Source” position and use of an external power supply for the DIs.

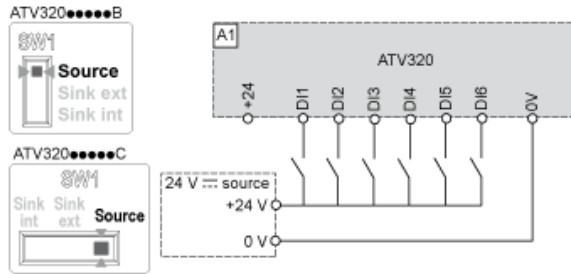

Switch SW1 set to “Sink Int” position and use of the output power supply for the DIs.

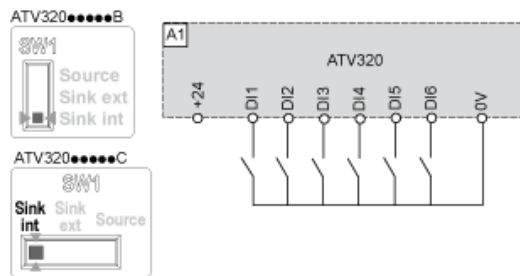

Switch SW1 set to “Sink Ext” position and use of an external power supply for the DIs.

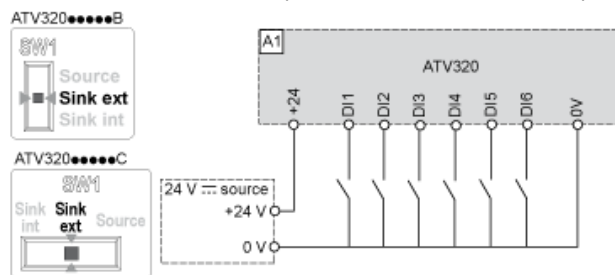

Digital Inputs Wiring

The logic input switch (SW1) is used to adapt the operation of the logic inputs to the technology of the programmable controller outputs. Switch SW1 set to "Source" position and use of the output power supply for the DIs.

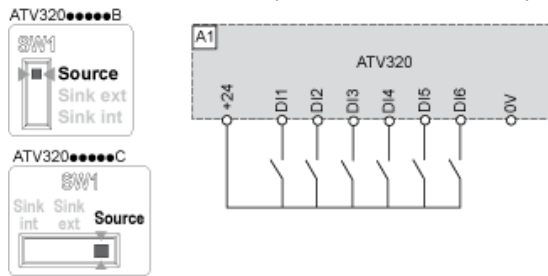

Switch SW1 set to "Source" position and use of an external power supply for the DIs.

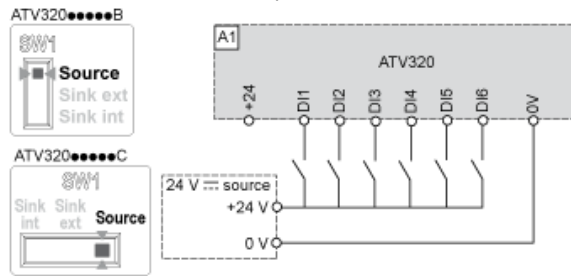

Switch SW1 set to "Sink Int" position and use of the output power supply for the DIs.

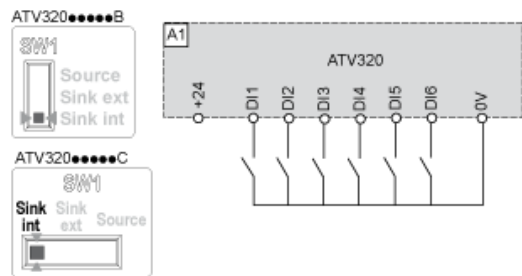

Switch SW1 set to "Sink Ext" position and use of an external power supply for the DIs.

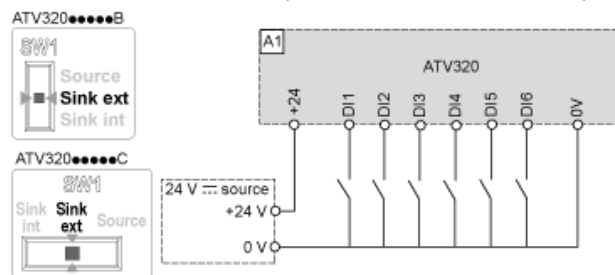

Digital Inputs Wiring

The logic input switch (SW1) is used to adapt the operation of the logic inputs to the technology of the programmable controller outputs. Switch SW1 set to “Source” position and use of the output power supply for the DIs.

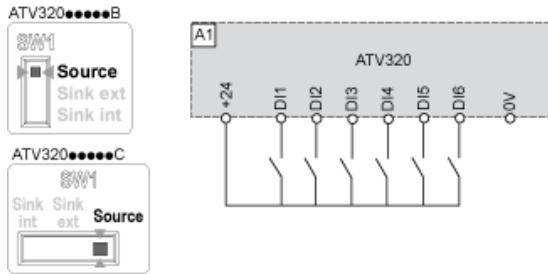

Switch SW1 set to “Source” position and use of an external power supply for the DIs.

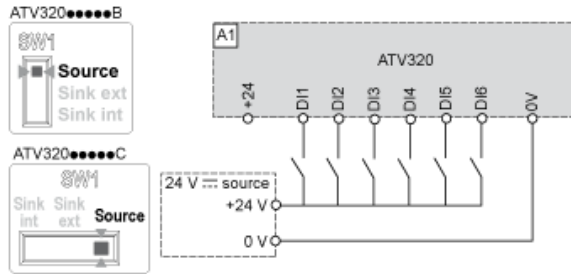

Switch SW1 set to “Sink Int” position and use of the output power supply for the DIs.

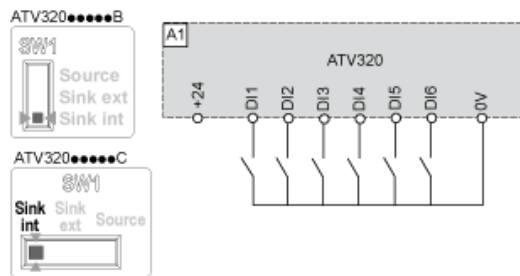

Switch SW1 set to “Sink Ext” position and use of an external power supply for the DIs.

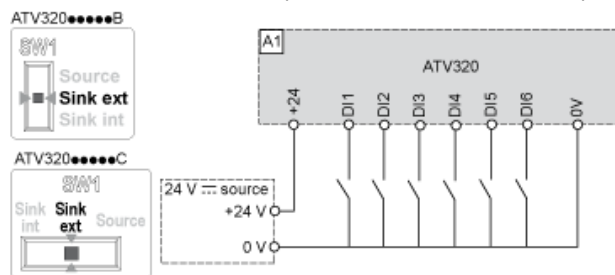

Derating Curves

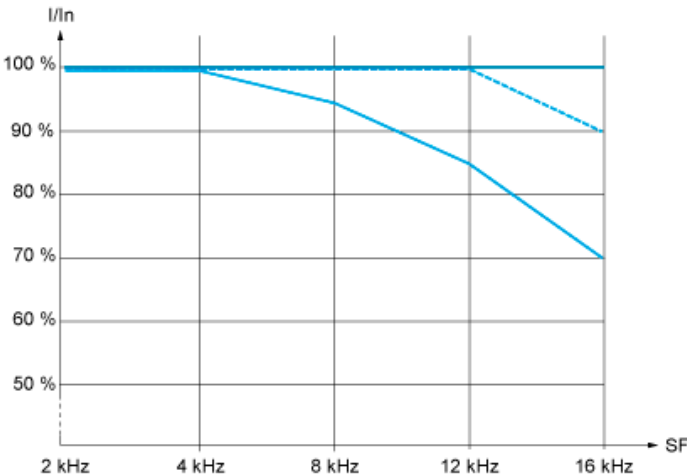

40 °C (104 °F) - Mounting type A, B and C
50 °C (122 °F) - Mounting type A, B and C
60 °C (140 °F) - Mounting type B and C