

Installation & Operation Manual

RSMA™

Adjustable Frequency Drives

for 1/8 HP thru 1HP 3-Phase AC Motors rated 208 – 230 VAC, 50* & 60 Hz

NEMA 1 / IP50

Operates from 115* and 208/230 Volt 50/60 Hz AC Line

Variable Speed / Soft-Start with Electronic Motor Overload Protection¹

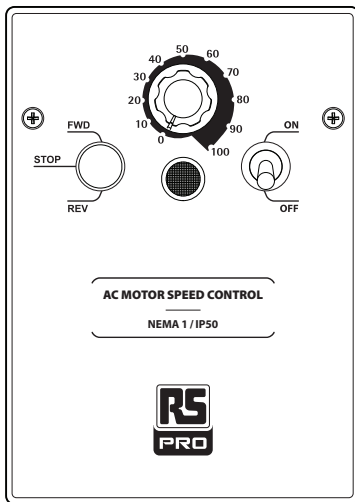

*IMPORTANT

This drive is factory set for:

- 1. 60 Hz Motors,**
for 50 Hz motors, see
Section 7.4, on page 17
and 18.
- 2. 208/230 Volt AC line input,**
for 115 VAC operation, see
Section 7.1, on page 16.



See Safety Warning,
on page 5.



This Manual Covers Models RSMA24D, 24DF²

The information contained in this manual is intended to be accurate. However, the manufacturer retains the right to make changes in design which may not be included herein.

Notes: 1. UL approved as an electronic overload protector for motors. 2. Model RSMA24DF contains a built-in AC line Class A RFI (EMI) filter which meets CE Council Directive 89/336/EEC Industrial Requirement. For Class B Residential Requirement, the RSRF300 filter must be used (externally mounted). 3. Model RSMA24D only.



For Product Support
Contact Customer Service Helpline
Phone (UK): 08457 201201

© 2017 RS Components, Ltd
(see back cover)

Table of Contents

Section	Page
1 Quick-Start Instructions	4
2 Safety Warning	5
3 Introduction	6
4 Important Application Information	13
5 Mounting Instructions	14
6 Electrical Connections	14
7 Setting Selectable Jumpers	16
8 Recommended High Voltage Dielectric Withstand Testing (Hi-Pot Testing)	18
9 Drive Operation	20
10 Pilot Light and Diagnostic LEDs	20
11 Trimpot Adjustments	21
Limited Warranty	24

Tables	Page
1 Optional Accessories	8
2 General Performance Specifications	9
3 Electrical Ratings	9
4 Terminal Block Wire and Tightening Torque Specifications	14
5 Drive Operating Conditions and Run/Fault Relay Contact Status	16
6 Drive Operating Conditions and LED Indications	21

Figures	Page
1 Quick-Start Connection Diagram	4
2 Mechanical Specifications	10
3 Cover Layout	11
4 Drive Layout	12
5 Maximum Allowed Motor Torque vs. Speed	13
6 Open Ventilated Motor with External Fan Cooling	13
7 AC Line Input, Motor, and Ground Connections	15
8 Run/Fault Relay Output Contacts Connections	15
9 AC Line Input Voltage Selection (Jumper J1)	16
10 Motor Horsepower Selection (Jumper J2)	16
11 Automatic or Manual Start and Reset Selection (Jumper J3)	17
12 60 Hz or 50 Hz Motor Selection (Jumpers J4 and J5)	17
13 Available Torque vs. Output Frequency	17
14 120 Hz and 100 Hz Drive Output Frequency Selection (Jumpers J4 and J5)	18
15 "Run" or "Fault" Output Relay Operation Selection (Jumper J6)	18
16 Typical Hi-Pot Test Setup	19
17 Minimum Speed Trimpot (MIN) Range	21

18	Maximum Speed Trimpot (MAX) Range	22
19	Acceleration Trimpot (ACCEL) Range	22
20	Deceleration Trimpot (DECEL) Range	22
21	Slip Compensation Trimpot (COMP) Range	22
22	Current Limit Trimpot (CL) Range	23
23	I ² t Trip Time vs. Motor Current	23

Items Included In this Package:

RSMA Adjustable Frequency Drive, Installation and Operation Manual, Hardware Bag (containing Trimpot Adjustment Tool, AC Line Input Voltage Selection Jumper, and an extra Feed-Through Bushing) and Mounting Template.

UL Notice

115 VAC Controls

Suitable For Use On A Circuit Capable Of Delivering Not More Than 5 kA RMS Symmetrical Amperes, 230 Volts Maximum.

Use Copper Conductors Rated 75 °C.

Suitable for Operation in a Maximum Surrounding Air Temperature of 40 °C.

230 VAC Controls

Suitable For Use On A Circuit Capable Of Delivering Not More Than 5 kA RMS Symmetrical Amperes, 230 Volts Maximum.

Use Copper Conductors Rated 75 °C.

Suitable for Operation in a Maximum Surrounding Air Temperature of 40 °C.

1 QUICK-START INSTRUCTIONS

Important – You must read these simplified instructions before proceeding. These instructions are to be used as a reference only and are not intended to replace the details provided herein. You must read the Safety Warning, on page 5, before proceeding.

Note: This drive contains bus capacitors which must be reconditioned if the drive has been in storage for over 1 year. To recondition the bus capacitors, apply the AC line, with the main speed potentiometer set to zero, for a minimum of 30 minutes.

See Figure 1. Also see Section 4 – Important Application Information, on page 13.



WARNING! Disconnect main power before making connections to the drive.

Note: It is recommended that both Feed-Through Bushings be used to connect the drive. If signal wiring (for the Run/Fault Relay Output Contacts or for a remote Main Speed Potentiometer) is required, it is recommended that the extra Feed-Through Bushing (supplied with the drive) be used to replace the center Hole Plug. Standard 3/4" fittings (not supplied) can also be used in lieu of the Feed-Through Bushings.

1.1 MOUNTING INSTRUCTIONS – See Section 5, on page 14.

1.2 AC LINE INPUT CONNECTION – Connect the single-phase AC line input to Terminal Block TB1 (Terminals “L1”, “L2”), as shown in Figure 1. See Section 6.1, on pages 14 and 15.

Application Note – Do not connect this drive to a GFCI. If operation with a GFCI is required, contact our Sales Department.

Note: The drive is factory set for 208/230 Volt AC line input (Jumper J1 not installed). For 115 Volt AC line input, install Jumper J1 (supplied). See Section 7.1, on page 16.

FIGURE 1 – QUICK-START CONNECTION DIAGRAM

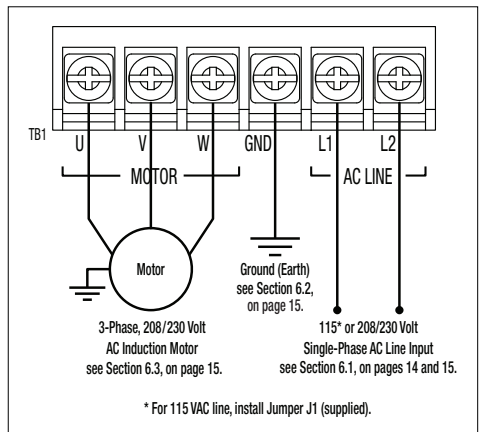

1.3 AC LINE FUSING – It is recommended that a fuse(s) or circuit breaker be installed in the AC line. Fuse each conductor that is not at ground potential. For the recommended fuse size, see Table 3, on page 9. Also see Section 6.1, on pages 14 and 15.

1.4 GROUND CONNECTION – Connect the ground wire (earth) to Terminal Block TB1 (Terminal “GND”), as shown in Figure 1, above.

1.5 MOTOR CONNECTION – Connect the motor to Terminal Block TB1 (Terminals “U”, “V”, “W”), as shown in Figure 1, on page 4. (Special reactors may be required for cable lengths over 100 ft. (30 m) – consult our Sales Department.). See Section 6.3, on page 15.

- 1.6 **JUMPER SETTINGS** – All jumpers have been factory set for most applications, as shown in Figure 4, on page 12. Some applications require setting of the jumpers in order to set the drive for a specific application. Jumper J2 must be set to match the horsepower of the motor being used. See Section 7, on pages 16 – 18.
- 1.7 **60 Hz and 50 Hz MOTOR OPERATION** – The drive is factory set for 60 Hz motor operation (Jumper J5 set to the “60Hz” position). For 50 Hz motor operation, set Jumper J5 to the “50Hz” position. See Section 7.4, on pages 17 and 18.
- 1.8 **PILOT LIGHT** – After applying power to the drive and setting the On/Off AC Line Switch to the “ON” position, the panel mounted Pilot Light will illuminate.
- 1.9 **DIAGNOSTIC LEDs** – After applying power to the drive and setting the On/Off AC Line Switch to the “ON” position, observe the PC board mounted LEDs for proper drive operation. See Section 10, on pages 20 & 21.
- 1.10 **TRIMPOT SETTINGS** – All trimpots have been factory set for most applications, as shown in Figure 4, on page 12. Some applications require adjustment of the trimpots in order to setup the drive for a specific requirement. See Section 11, on pages 21 – 23.

2 SAFETY WARNING

Definition of Safety Warning Symbols



Electrical Hazard Warning Symbol – Failure to observe this warning could result in electrical shock or electrocution.



Operational Hazard Warning Symbol – Failure to observe this warning could result in serious injury or death.



This product should be installed and serviced by a qualified technician, electrician, or electrical maintenance person familiar with its operation and the hazards involved. Proper installation, which includes wiring, fusing or other current protection, and grounding can reduce the chance of electrical shocks, and/or fires, in this product or products used with this product, such as electric motors, switches, coils, solenoids, and/or relays. Do not use this drive in an explosion-proof application. Eye protection must be worn and insulated adjustment tools must be used when working with drive under power. This product is constructed of materials (plastics, metals, carbon, silicon, etc.) which may be a potential hazard. Proper shielding, grounding, and filtering of this product can reduce the emission of radio frequency interference (RFI) which may adversely affect sensitive electronic equipment. It is the responsibility of the equipment manufacturer and individual installer to supply this Safety Warning to the ultimate end user of this product. (SW 1/2006)

The drive contains electronic Start/Stop circuits which can be used to start and stop the drive. However, these circuits are never to be used as safety disconnects since they are not fail-safe. Use only the AC line for this purpose.

Be sure to follow all instructions carefully. Fire and/or electrocution can result due to improper use of this product.



This product complies with all CE directives pertinent at the time of manufacture. Contact Technical Support for Declaration of Conformity. Installation of a CE approved RFI filter is required. Additional shielded cable and/or AC line cables may be required along with a signal isolator.

3 INTRODUCTION

Thank you for purchasing the RSMA Adjustable Frequency Drive. RS Components, Ltd. is committed to providing total customer satisfaction by producing quality products that are easy to install and operate. The RSMA is manufactured with surface mount components incorporating advanced circuitry and technology. The RSMA Series Adjustable Frequency Drives are variable speed controls housed in a NEMA 1/IP50 enclosure. They are designed to operate 208 – 230 Volt 50 & 60 Hz 3-phase AC induction motors from 1/8 HP thru 1 HP. The sine wave coded Pulse Width Modulated (PWM) output operates at a carrier frequency of 16 kHz which provides high motor efficiency and low noise. Adjustable Linear Acceleration and Deceleration make the drive suitable for soft-start applications. The Motor Horsepower Selection Jumper allows the drive to be used on a wide range of motor horsepower (1/8, 1/4, 1/2, 3/4, 1 HP) without recalibration or programming. Model RSMA24DF contains a built-in AC line Class A RFI (EMI) filter which meets the CE Council Directive 89/336/EEC Industrial Requirement.

Its user-friendly design makes the drive easy to install and operate. Setting the drive to specific applications is accomplished with selectable jumpers and trim pots, which eliminates the computer-like programming required on other drives. However, for most applications no adjustments are necessary. For more advanced programming, PC based Drive-Link™ software is available.

Main features include adjustable RMS Current Limit and I²t Motor Overload Protection.¹ In addition, Adjustable Slip Compensation with Static Auto-Tune and Boost provides high torque and excellent load regulation over a wide speed range. Power Start™ delivers over 200% motor torque to ensure startup of high frictional loads. Electronic Inrush Current Limit (EICL™) eliminates harmful AC line inrush current. A Run/Fault Relay is provided, which can be used to turn on or off equipment or to signal a warning if the drive is put into the Stop Mode or a fault has occurred.

Standard front panel features include an On/Off AC Line Switch, a pilot light for power on, and a Main Speed Potentiometer. Other features include PC board mounted diagnostic LEDs (Power On (ON), Drive Status (ST) and Overload (OL)), Barrier Terminal Blocks to facilitate wiring (AC line, motor, ground (earth), and Run/Fault Relay Output Contacts), adjustable trim pots (MIN, MAX, ACCEL, DECEL, COMP, CL), customer selectable jumpers (AC Line Input Voltage Selection, Motor Horsepower, Automatic or Manual Start and Reset², Motor Frequency, Frequency Multiplier, and a Run/Fault Output Relay).

Optional accessories include: Forward-Stop-Reverse Switch² and AC Line Filter.

Notes: **1.** UL approved as an electronic overload protector for motors. **2.** The optional Forward-Stop-Reverse Switch is required for Manual Start.

3.1 STANDARD FEATURES

- **Simple to Operate** – Does not require programming. Uses trim pots and jumpers, which are factory set for most applications.
- **Dual AC Line Input Voltage (115 or 208/230 Volt AC Operation)** – Controls 208 – 230 Volt AC, 50 & 60 Hz, 3-phase motors from 115 or 208/230 Volt AC line. (Jumper J1 must be installed for 115 Volt AC line operation.)

- **Motor Horsepower Selection Jumper** – Allows the drive to be used on a wide range of motor horsepower (1/8, 1/4, 1/2, 3/4, 1 HP) without recalibration or programming.
- **Diagnostic LEDs** – PC board mounted LEDs for Power On (ON), Drive Status (ST), and Overload (OL).
- **Run/Fault Relay Output Contacts** – Can be used to turn on or off equipment or to signal a warning if the drive is put into the Stop Mode or a fault has occurred.
- **Barrier Terminal Blocks** – Facilitate wiring of AC line, motor, ground (earth) and Run/Fault Relay Output Contacts.
- **On/Off AC Line Switch** – Panel mounted. Used to turn the power on or off to the drive.
- **Pilot Light** – Panel mounted. Indicates that power is applied to the drive and the On/Off AC Line Switch is set to the “ON” position.
- **Main Speed Potentiometer** – Panel mounted. Provides adjustment of motor speed.
- **Jumper Selection of Drive Output Frequency** – Increases the motor speed up to two times the rated RPM.
- **Compatible with GFCIs (with optional software).**

3.2 PERFORMANCE FEATURES

- **Power Start™** – Provides more than 200% starting torque which ensures startup of high frictional loads.
- **Slip Compensation with Static Auto-Tune and Boost** – Provides excellent load regulation over a wide speed range.
- **Speed Range** – 60:1

3.3 PROTECTION FEATURES

- **Motor Overload (I²t) with RMS Current Limit** – Provides motor overload protection which prevents motor burnout and eliminates nuisance trips.*
- **Electronic Inrush Current Limit (EICL™)** – Eliminates harmful inrush AC line current during startup.
- **Short Circuit** – Shuts down the drive if a short circuit occurs at the motor (phase-to-phase).
- **Regeneration** – Eliminates tripping due to bus overvoltage caused by rapid deceleration of high inertial loads.
- **Undervoltage and Overvoltage** – Shuts down the drive if the AC line input voltage goes above or below the operating range.
- **MOV input transient suppression.**
- **Microcontroller self monitoring and auto-reboot.**

**UL approved as an overload protector for motors.*

3.4 SELECTABLE JUMPERS (See Section 7, on pages 16 – 18.)

- **AC Line Input Voltage Selection (115/230 Volts AC) (J1)**
- **Motor Horsepower (1/8, 1/4, 1/2, 3/4, 1 HP) (J2)**
- **Automatic or Manual Start and Reset (J3)**
- **Frequency Multiplier (1X, 2X) (J4)**
- **Motor Frequency (50/60 Hz) (J5)**
- **“Run” or “Fault” Output Relay Operation (J6)**

3.5 TRIMPOT ADJUSTMENTS (See Section 11, on pages 21 – 23.)

- **Minimum Speed** (MIN)
- **Maximum Speed** (MAX)
- **Acceleration** (ACCEL)
- **Deceleration** (DECEL)
- **Slip Compensation** (COMP)
- **Current Limit** (CL)

TABLE 1 – OPTIONAL ACCESSORIES

Description	Stock No.
Forward-Stop-Reverse Switch: Provides motor reversing, stop, and manual start functions.	136-3126
RSRF300: Panel mount. AC line Class B RFI (EMI) filter which meets the CE Council Directive 89/336/EEC Residential Requirement. Installs externally to the drive.	—

TABLE 2 – GENERAL PERFORMANCE SPECIFICATIONS

Description	Specification	Factory Setting
115 Volt AC Line Input Voltage Operating Range (Volts AC) ¹	115 (±15%)	—
208/230 Volt AC Line Input Voltage Operating Range (Volts AC) ¹	208 (-15%) / 230 (+15%) ²	—
Maximum Load (% Current Overload for 1 Minute)	150	—
Horsepower Selection (HP) (J2)	1/8, 1/4, 1/2, 3/4, 1	1
Carrier, Switching Frequency (kHz)	16, 8	—
Output Frequency Resolution (Bits, Hz)	10, .06	—
Minimum Speed Trimpot (MIN) Range (% Frequency Setting)	0 – 40	0
Maximum Speed Trimpot (MAX) Range (% Frequency Setting)	70 – 110	100
Acceleration Trimpot (ACCEL) and Deceleration Trimpot (DECEL) Range (Seconds)	.3 – 20	1.5
Slip Compensation Trimpot (COMP) Range at Drive Rating (Volts/Hz)	0 – 3	1.5
Current Limit Trimpot (CL) Range (% Full Load)	40 – 200	160
Motor Frequency Setting (Hz) (Jumper J5)	50, 60	60
Output Frequency Multiplier (1X, 2X) (Jumper J4) ³	1, 2	1
Minimum Operating Frequency at Motor (Hz)	0.3	—
Speed Range (Ratio)	60:1	—
Speed Regulation (30:1 Speed Range, 0 – Full Load) (% Base Speed) ⁴	2.5	—
Overload Protector Trip Time for Stalled Motor (Seconds)	6	—
Undervoltage/Overvoltage Trip Points for 115 Volt AC Line Input (±5%) (Volts AC) ¹	76 – 141	—
Undervoltage/Overvoltage Trip Points for 208/230 Volt AC Line Input (±5%) (Volts AC) ¹	151 – 282	—
Run/Fault Relay Output Contact Rating (Amps at 30 Volts DC, 125 Volts AC, 250 Volts AC)	1, 0.5, 0.25	—
Operating Temperature Range (°C / °F)	0 – 40 / 32 – 104	—
Operating Humidity Range (% Relative, Non-Condensing)	0 – 95	—
Storage Temperature Range (°C / °F)	-2.5 – +85 / -13 – +185	—

Notes: **1.** Do not operate the drive outside the specified AC line input voltage operating range. **2.** The drive is factory set for 208/230 Volt AC line input (Jumper J1 not installed). For 115 Volt AC line input, install Jumper J1 (supplied). See Figure 9, on page 16. **3.** Allows the motor to operate up to two times the rated RPM. Constant motor horsepower will result when operating the drive in the “2X” mode above the motor nameplate rated RPM. **4.** Dependent on motor performance.

TABLE 3 – ELECTRICAL RATINGS

Model	Stock No.	AC Line Input			Fuse or Circuit Breaker Rating (Amps)	Output			Net Weight	
		Volts AC (50/60 Hz)	Phase	Maximum Current (Amps AC)		Voltage Range (Volts AC)	Maximum Continuous Load Current (RMS Amps/Phase)	Maximum Horsepower (HP (KW))	Lbs.	kg
RSMA24D	—	115	1	14.4	20	0 – 230	3.6	1 (.75)	2.42	1.09
		208/230 ¹		9.5						
RSMA24DF ²	136-3113	115	1	9.5	20	0 – 230	3.6	1 (.75)	2.48	1.12
		208/230 ¹								

Notes: **1.** The drive is factory set for 208/230 Volt AC line input (J1 not installed). For 115 volt AC line input, install Jumper J1 (supplied). See Figure 9, on page 16. **2.** Model RSMA24DF contains a built-in AC line Class A RFI (EMI) filter which meets the CE Council Directive 89/336/EEC Industrial Requirement.

FIGURE 2 – MECHANICAL SPECIFICATIONS (Inches/mm)

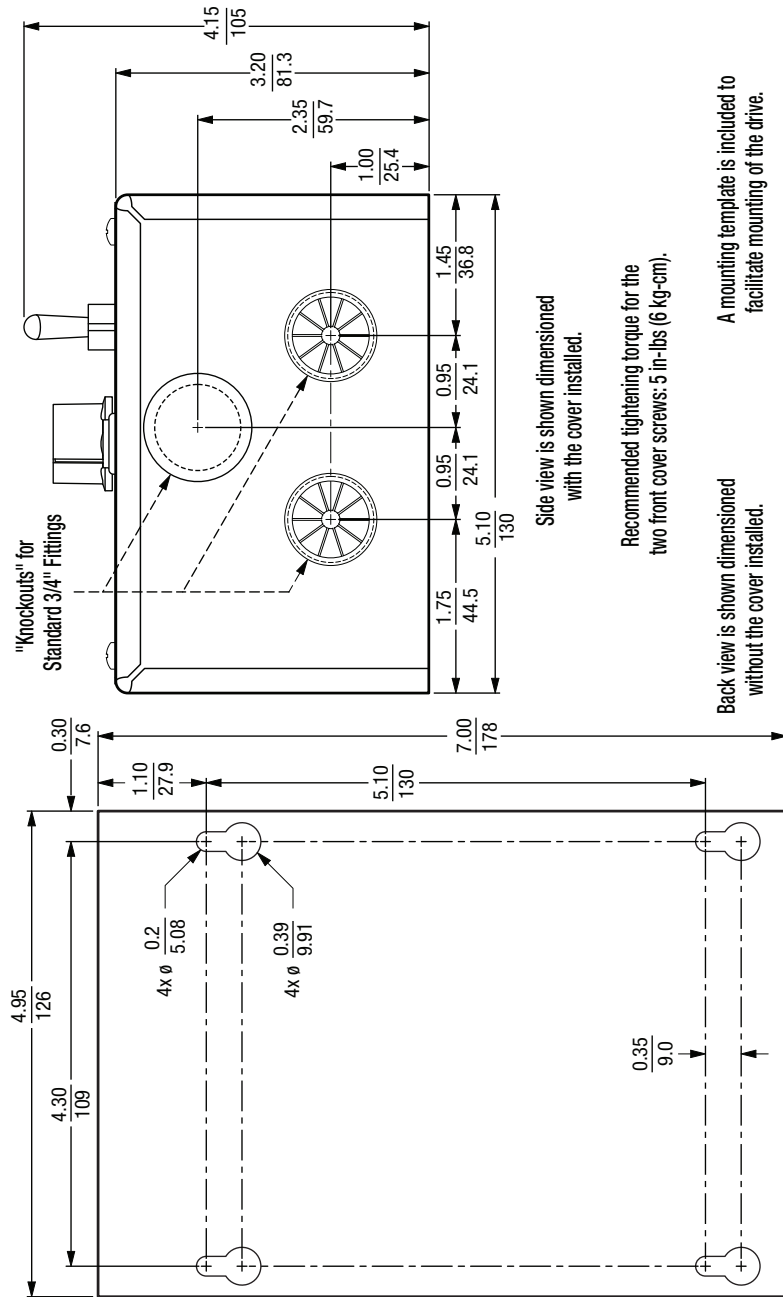

FIGURE 3 – COVER LAYOUT

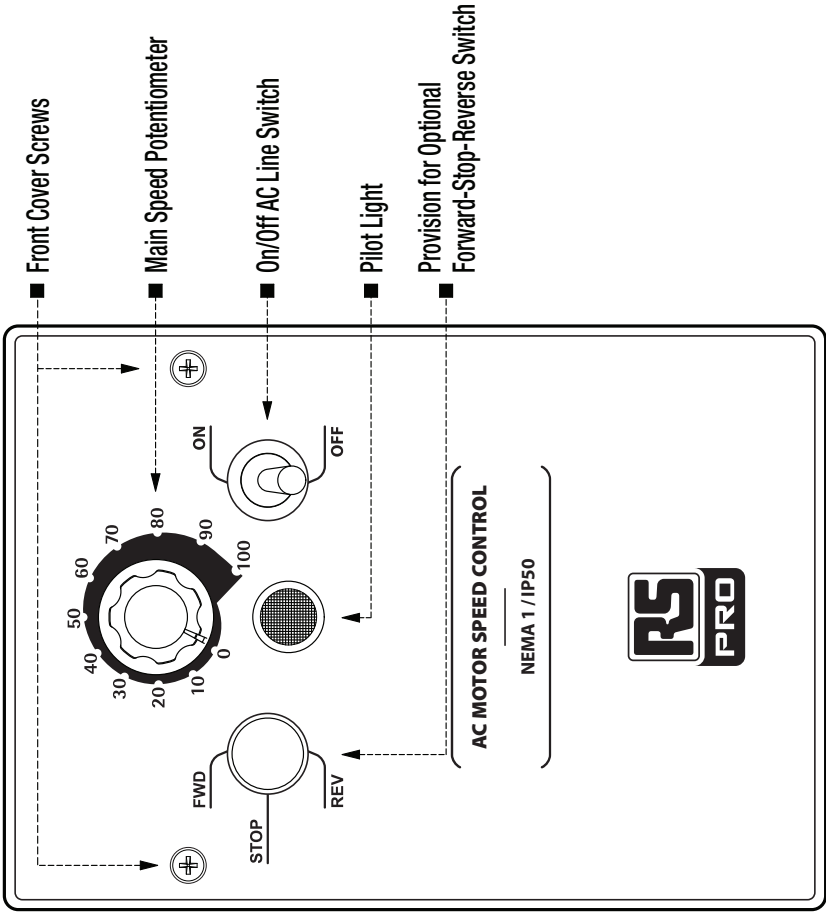
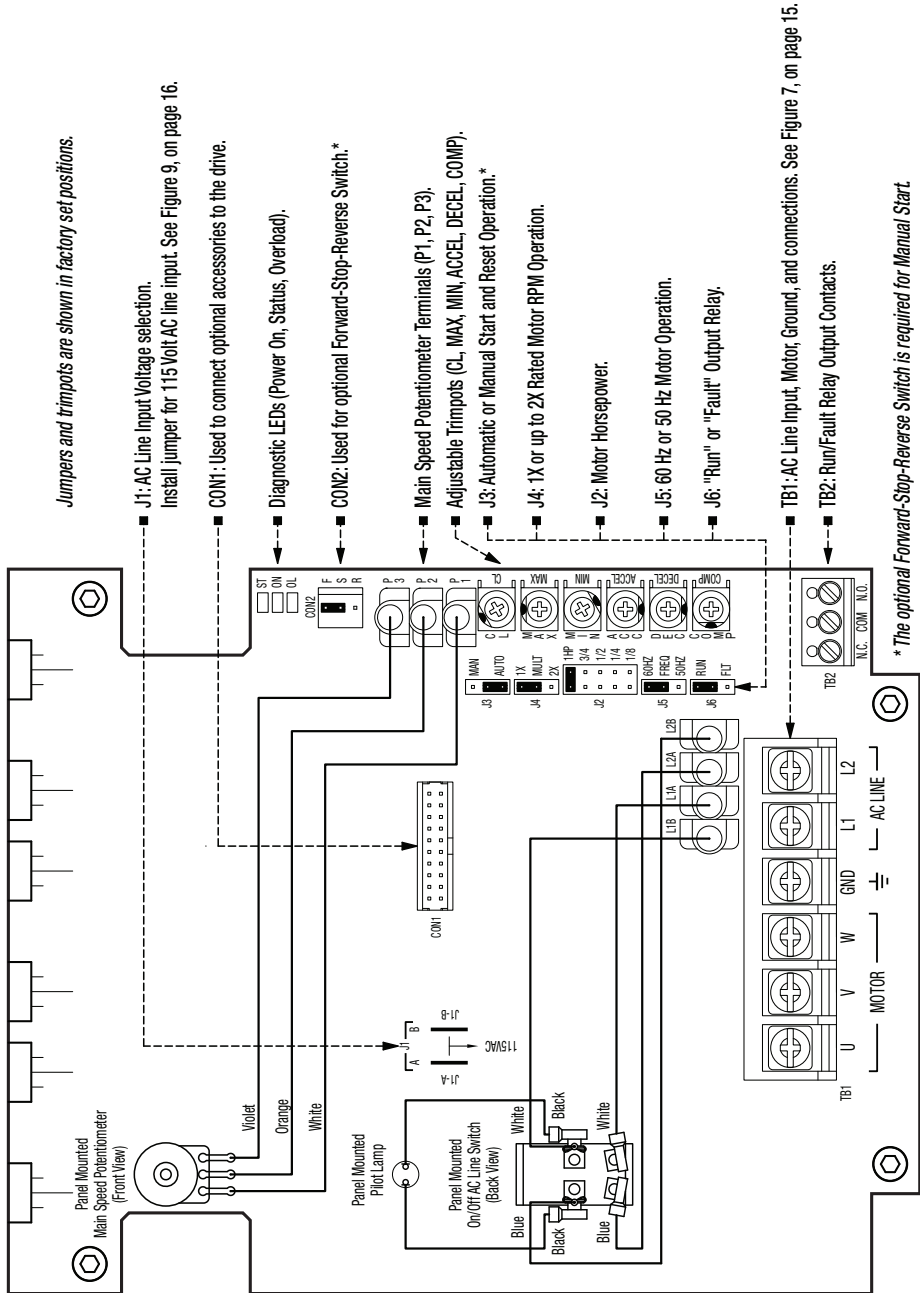

FIGURE 4 – DRIVE LAYOUT





4 IMPORTANT APPLICATION INFORMATION

4.1 MOTOR WITH EXTERNAL FAN

COOLING – Most totally enclosed fan-cooled (TEFC) and open ventilated 3-phase AC induction motors will overheat if used beyond a limited speed range at full torque. Therefore, it is necessary to reduce motor load as speed is decreased.

Note: Some fan-cooled motors can be used over a wider speed range. Consult the motor manufacturer for details.

 **WARNING!** Some motors have low speed characteristics which cause overheating and winding failure under light load or no load conditions. If the motor is operated in this manner for an extended period of time, it is recommended that the unloaded motor current be checked from 2 – 15 Hz (60 – 450 RPM) to ensure motor current does not exceed the nameplate rating. **Do not use motor if the motor current exceeds the nameplate rating.**

 **It is recommended that the drive be used with Inverter Duty or TENV motors.**

Inverter duty and most totally enclosed non-ventilated (TENV) motors can provide full rated torque over an extended speed range without overheating. See Figure 5.

If external fan cooling is provided, open ventilated motors can also achieve an extended speed range at full rated torque. A box fan or blower with a minimum of 100 CFM per HP is recommended. Mount the fan or blower so the motor is surrounded by the airflow. See Figure 6.

4.2 ELECTRONIC MOTOR OVERLOAD PROTECTION – The drive contains Modified I^2t Overload Protection.* Part of this function consists of a Current Limit (CL) circuit, which limits the drive current to a factory preset level of 160% of the rated drive current. The CL Trimpot is used to recalibrate the drive current from 60% thru 200%. The Power Start™ circuit provides an overshoot function that allows most motors to develop more than 200% of starting torque and breakdown torque.

Standard I^2t is undesirable because it causes nuisance tripping. It allows a very high motor current to develop and will turn the drive off after a short period of time. The RMS Current Limit Circuit which includes I^2 plus an $I \cdot t$ timing circuit (as described in the following paragraph), avoids this nuisance tripping while providing maximum motor protection.

If the motor is overloaded to 120% of full load (75% of the CL setting), the I^2t Timer starts. If the motor continues to be overloaded at the 120% level, the timer will shut down the drive after 30 minutes. If the motor is overloaded to 160% of full load, the drive will trip in 6 seconds. See Section 11.6, on pages 22 and 23.

*UL approved as an overload protector for motors.

FIGURE 5 – MAXIMUM ALLOWED MOTOR TORQUE vs. SPEED

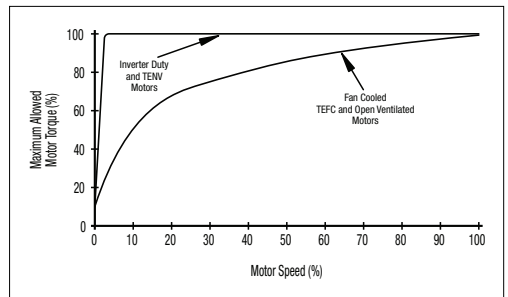
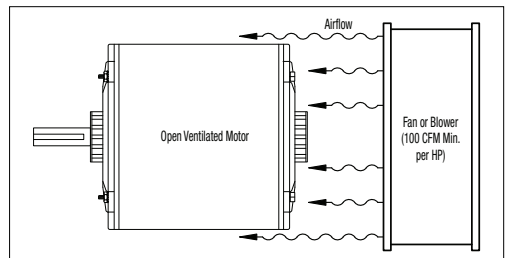

FIGURE 6 – OPEN VENTILATED MOTOR WITH EXTERNAL FAN COOLING



5 MOUNTING INSTRUCTIONS

The drive is designed with a NEMA 1/1P50 enclosure for indoor use. It is recommended that the drive be mounted vertically on a flat surface with adequate ventilation. Leave enough room below the drive to allow for AC line, motor connections, and any other wiring that is required. Care should be taken to avoid extreme hazardous locations where physical damage can occur. When mounting the drive in an enclosure, the enclosure should be large enough to allow for proper heat dissipation so that the ambient temperature does not exceed 40°C (104 °F) at full rating. See Figure 2, on page 10. A mounting template is included to facilitate mounting of the drive.



WARNING! Do not use this drive in an explosion-proof application.

6 ELECTRICAL CONNECTIONS

See Table 4, for terminal block wire and tightening torque specifications.



WARNING! Read Safety Warning, on page 5, before using the drive. Disconnect main power before making connections to the drive. To avoid electric shock, be sure to properly ground the drive.

Application Note: To avoid erratic operation, do not bundle the AC line and motor wires with each other or with wires from signal following, start/stop contacts, or any other signal wires. Also, do not bundle motor wires from multiple drives in the same conduit. Use shielded cables on all signal wiring over 12" (30 cm). The shield should be earth grounded on the drive side only. Connect the drive in accordance with the National Electrical Code requirements and other local codes that may apply.

Be sure to properly fuse each AC line conductor that is not at ground potential. Do not fuse neutral or grounded conductors. A separate AC line switch or contactor must be installed as a disconnect so that each ungrounded conductor is opened. For fuse or circuit breaker rating, see Table 3, on page 9. Also see Section 6.1, below and on page 15.

The drive is designed with a removable cover. To open the cover, the two front cover screws must be removed. After mounting and connections, install and tighten the two front cover screws to 5 in-lbs (6 kg-cm). Do not overtighten.

TABLE 4 – TERMINAL BLOCK WIRE & TIGHTENING TORQUE SPECIFICATIONS

Terminal Block	Description	Maximum Wire Size (Cu)		Recommended Tightening Torque	
		AWG	mm ²	in-lbs	kg-cm
TB1	AC Line Input and Motor Wiring	12	3.3	7	8
TB2	Run/Fault Relay Output Contacts	16	1.3	3.5	3

6.1 AC LINE INPUT CONNECTION – Connect the single-phase AC line input to Terminal Block TB1 (Terminals “L1”, “L2”), as shown in Figure 7, on page 15.

The rated AC line voltage of the drive must match the actual AC line input voltage setting of Jumper J1. The drive is factory set for 208/230 Volt AC line input (Jumper J1 not installed). For 115 Volt AC line input, install Jumper J1 (supplied). See Section 7.1, on page 16.

GFCI Operation – Do not connect this drive to an AC power source controlled by a Ground-Fault Circuit-Interrupter. Special software is available for GFCI operation – contact our Sales Department.

AC Line Fusing – The drive does not contain line fuses. Most electrical codes require that each ungrounded conductor contain circuit protection. Do not fuse neutral or ground connections. It is recommended to install a fuse (Littelfuse 326, Buss ABC, or equivalent) or a circuit breaker in series with each ungrounded conductor. Connect the drive in accordance with the National Electrical Code requirements and other local codes that may apply to the application. Do not fuse motor leads. For the recommended fuse size, see Table 3, on page 9.

FIGURE 7 – AC LINE INPUT, MOTOR & GROUND CONNECTIONS

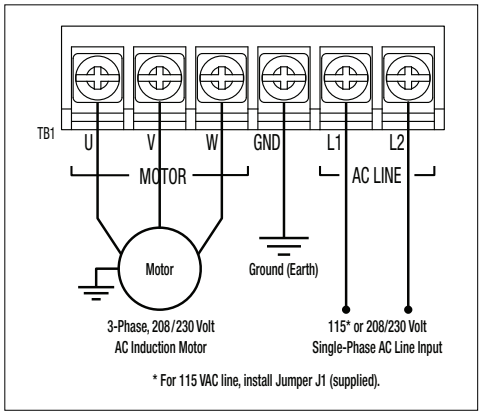

- 6.2 GROUND CONNECTION –** Connect the ground (earth) wires from the AC line and motor to Terminal Block TB1 (Terminal “GND”). See Figure 7.
- 6.3 MOTOR CONNECTION –** Connect the motor to Terminal Block TB1 Terminals “U”, “V”, “W”. See Figure 7. Motor cable length should not exceed 100 ft (30 m) – special reactors may be required – consult our Sales Department. Be sure Jumper J2 is set to the corresponding motor horsepower rating, as described in Section 7.2, on page 16.

Note: If the motor rotates in the incorrect direction, it will be necessary to disconnect the AC line and change the position of the jumper on CON2 from “F” to “R” or reverse any two motor leads.

- 6.4 RUN/FAULT RELAY CONNECTION –** The Run/Fault Relay Output Contacts are located at TB2 and can be used to turn on or off equipment or to signal a warning if a fault has occurred or the drive is put into the Stop Mode*. See Figure 8. The Run/Fault Relay Contact status for various drive operating conditions is shown in Table 5, on page 16. Also see Section 7.5, on page 18.

Relay Contacts Ratings – 1 Amp at 30 Volts DC, 0.5 Amps at 125 Volts AC, and 0.25 Amps at 250 Volts AC.

FIGURE 8 – RUN/FAULT RELAY OUTPUT CONTACTS CONNECTIONS

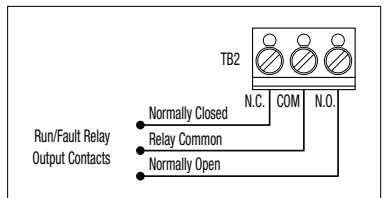

**In order for the Run/Fault Relay to give “Stop Mode” indication, the optional Forward-Stop Reverse Switch must be installed.*

TABLE 5 – DRIVE OPERATING CONDITIONS & RUN/FAULT RELAY CONTACT STATUS

Drive Operating Condition	Description	Run Relay Operation (J5 Installed in "RUN" Position) (Factory Setting)		Fault Relay Operation (J5 Installed in "FLT" Position)	
		Normally Open Contact	Normally Closed Contact	Normally Open Contact	Normally Closed Contact
Power Off	Main Power Disconnected	Open	Closed	Open	Closed
Run Mode ¹	Normal Drive Operation	Closed	Open	Closed	Open
Stop Mode ²	Selected by Operator	Open	Closed	Closed	Open
Fault ³	Drive Tripped	Open	Closed	Open	Closed

Notes: 1. Run Mode is selected with the optional Forward-Stop-Reverse Switch or with the jumper installed in CON2 (jumper installed in the "F-S" position for forward direction (factory setting) or jumper installed in the "R-S" position for reverse direction). 2. Stop Mode is selected using the optional Forward-Stop-Reverse Switch. 3. I²t, Short Circuit, Undervoltage, Overvoltage.

7 SETTING SELECTABLE JUMPERS

The drive has customer selectable jumpers which must be set before the drive can be used. For the location of jumpers, see Figure 4, on page 12. Disconnect the AC line before changing position of Jumpers.

7.1 AC LINE INPUT VOLTAGE (J1) – The drive is factory set for 208/230 Volt AC line input(Jumper J1 not installed). For 115 Volt AC line input, install Jumper J1. See Figure 9.

FIGURE 9 – AC LINE INPUT VOLTAGE SELECTION¹

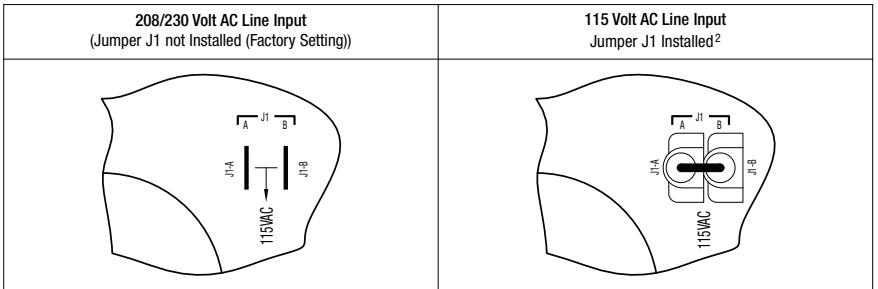

Notes: 1. The drive is factory set for 208/230 Volt AC line input (Jumper J1 not installed). For 115 Volt AC line input, install Jumper J1 (supplied). 2. Jumper J1 is supplied in the hardware bag.

7.2 MOTOR HORSEPOWER (J2) – Set Jumper J2 to the corresponding position for the motor being used. See Figure 10.

7.3 AUTOMATIC OR MANUAL START AND RESET SELECTION (J3) – See Figure 11, on page 17.

7.3.1 WARNING! Automatic Start and Reset – Jumper J3 is factory set to the "AUTO" position to automatically start the drive when the power is applied and the On/Off AC Line Switch is set to the "ON" position. The drive will also automatically restart after an Undervoltage or Overvoltage Fault has cleared.

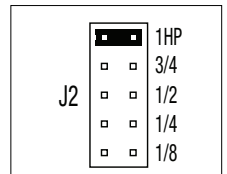

FIGURE 10 – MOTOR HORSEPOWER SELECTION



If an I²t or Short Circuit Fault occurs, the drive must be restarted by setting the On/Off AC Line Switch to the “OFF” position for a minimum of 5 seconds.

7.3.2 Manual Start and Reset* – In Manual Start Mode, the drive must be manually restarted, after a fault has cleared, using the optional Forward-Stop-Reverse Switch. If a Short Circuit or I²t Fault occurs, the drive can be restarted by setting either the On/Off AC Line Switch to the “OFF” position for a minimum of 5 seconds or setting the Forward-Stop-Reverse Switch to the “STOP” position.





FIGURE 11 – AUTOMATIC OR MANUAL START & RESET SELECTION

Automatic Start and Reset (Factory Setting) (J3 Installed in “AUTO” Position)	Manual Start and Reset (J3 Installed in “MAN” Position)
 <p>J3</p>	 <p>J3</p>

***Note: The optional Forward-Stop-Reverse Switch must be installed in order to use the drive for Manual Start operation.**

7.4 60 Hz OR 50 Hz MOTOR OPERATION AND DRIVE OUTPUT FREQUENCY (J4 AND J5) – Both jumpers must be set for the appropriate motor nameplate frequency rating.

FIGURE 12 – 60 Hz OR 50 Hz MOTOR SELECTION

60 Hz Motor Operation (Factory Setting) (J4 Installed in “1X” Position) (J5 Installed in “60Hz” Position)		50 Hz Motor Operation (J4 Installed in “1X” Position) (J5 Installed in “50Hz” Position)	
 <p>J4</p>	 <p>J5</p>	 <p>J4</p>	 <p>J5</p>

7.4.1 Setting the Drive for 60 Hz or 50 Hz Motor Operation – The drive is factory set to operate 60 Hz motors. Jumper J5 is factory set to the “60Hz” position. For 50 Hz motors, set Jumper J5 to the “50Hz” position, and be sure Jumper J4 is set to the “1X” position. See Figure 12.

7.4.2 Setting the Drive for Two Times the Rated Motor RPM – The drive can also be used to operate the motor up to two times the rated RPM. However, constant horsepower will result when operating the drive in the “2X” mode above the motor rated frequency. See Figure 13.

FIGURE 13 – AVAILABLE TORQUE vs. OUTPUT FREQUENCY

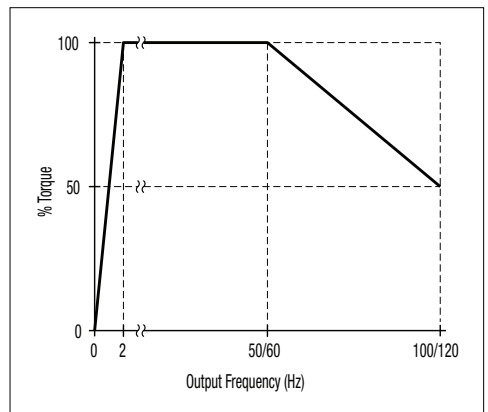

For 120 Hz output with 60 Hz motor, set Jumper J4 to the “2X” position and be sure Jumper J5 is set to the “60Hz” position. For 100 Hz output with 50 Hz motor, set Jumper J4 to the “2X” position and set Jumper J5 to the “50Hz” position. See Figure 14.

FIGURE 14 – 120 Hz AND 100 Hz DRIVE OUTPUT FREQUENCY SELECTION

120 Hz Output with 60 Hz Motor (J4 Installed in “2X” Position) (J5 Installed in “60Hz” Position)		100 Hz Output with 60 Hz Motor (J4 Installed in “2X” Position) (J5 Installed in “50Hz” Position)	

7.5 RUN/FAULT OUTPUT RELAY

OPERATION (J6) – Jumper J6 is factory set to the “RUN” position for “Run” operation of the Run/Fault Relay. For “Fault” operation of the Run/Fault Relay, set Jumper J6 to the “FLT” position. See Figure 15.

FIGURE 15 – “RUN” OR “FAULT” OUTPUT RELAY OPERATION SELECTION

“Run” Output Relay Operation (Factory Setting) (J6 Installed in “RUN” Position)	“Fault” Output Relay Operation (J6 Installed in “FLT” Position)

8 RECOMMENDED HIGH VOLTAGE DIELECTRIC WITHSTAND TESTING (HI-POT TESTING)

Testing agencies such as UL, CSA, VDE, etc., usually require that equipment undergo a hi-pot test. In order to prevent catastrophic damage to the drive which has been installed in the equipment, the following procedure is recommended. A typical hi-pot test setup is shown in Figure 16, on page 19. All drives have been factory hi-pot tested in accordance with UL requirements.



WARNING! All equipment AC line inputs must be disconnected from the AC power.

- 8.1 Connect all equipment AC power input lines together and connect them to the H.V. lead of the hi-pot tester. Connect the RETURN lead of the hi-pot tester to the frame on which the drive and other auxiliary equipment are mounted.
- 8.2 The hi-pot tester must have an automatic ramp-up to the test voltage and an automatic ramp-down to zero voltage.

Note: If the hi-pot tester does not have automatic ramping, then the hi-pot output must be manually increased to the test voltage and then manually reduced to zero. This procedure must be followed for each machine to be tested. A suggested hi-pot tester is Slaughter Model 2550.

CAUTION! Instantly applying the hi-pot voltage will cause irreversible damage to the drive, which will void the warranty.

FIGURE 16 – TYPICAL HI-POT TEST SETUP

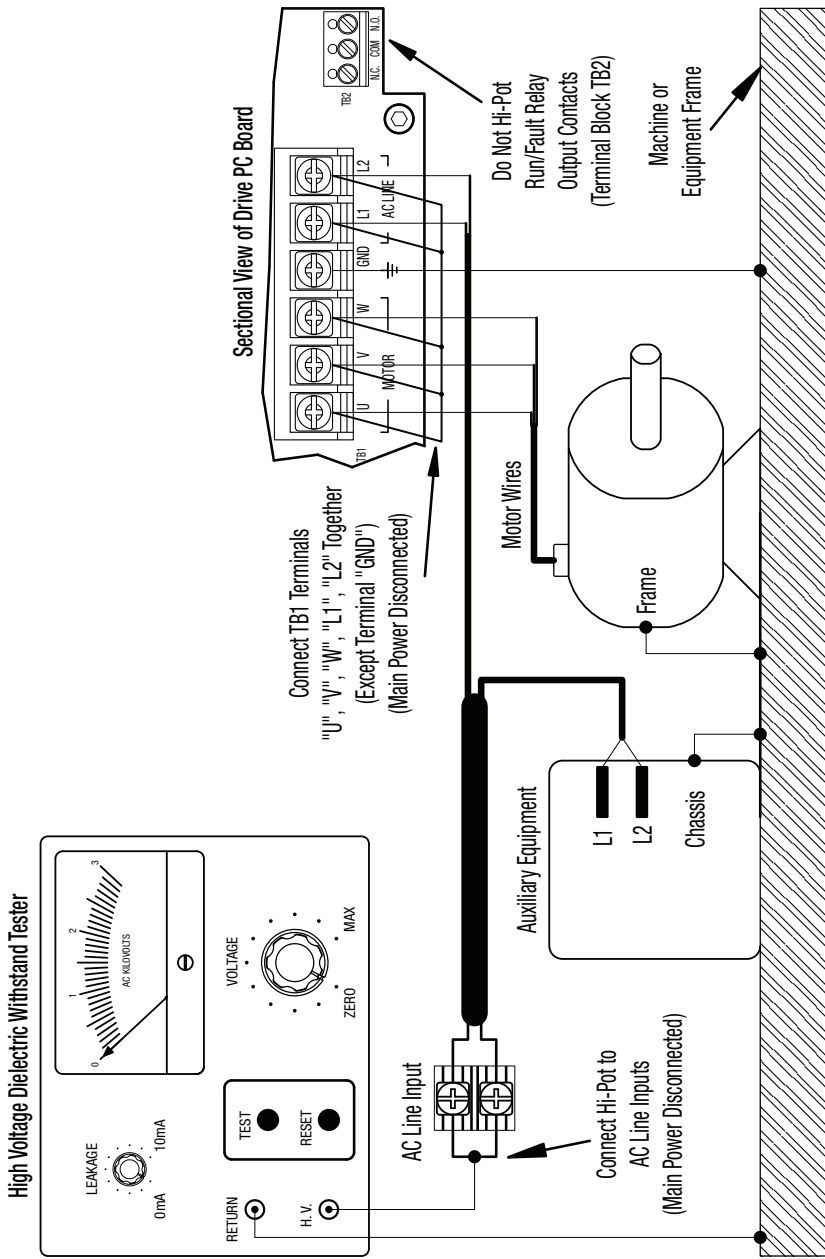

9 DRIVE OPERATION

- 9.1 START-UP PROCEDURE** – After the drive has been properly setup (jumpers and trimpots set to the desired positions) and wiring completed, the start-up procedure can begin.

Note: This drive contains bus capacitors which must be reconditioned if the drive has been in storage for over 1 year. To recondition the bus capacitors, apply the AC line, with the main speed potentiometer set to zero, for a minimum of 30 minutes.



WARNING! The motor will run at the Main Speed Potentiometer setting when the AC line is applied.

To start the drive, set the On/Off AC Line Switch to the “ON” position. If the AC power has been properly brought to the drive, the Pilot Light will illuminate. If the optional Forward-Stop-Reverse Switch has been installed, set it to the “FWD” or “REV” position. The motor will begin to accelerate to the set speed. The PC board mounted “ST” and “OL” LEDs will indicate the drive status, as described in Sections 10.3 and 10.4, on page 21.

Note: If the motor rotates in the incorrect direction, it will be necessary to disconnect the AC line and change the position of the jumper on CON2 from “F” to “R” or reverse any two motor leads, and repeat the start-up procedure.

- 9.2 RESTARTING THE DRIVE AFTER A FAULT HAS BEEN CLEARED** – The drive monitors four faults (Undervoltage, Overvoltage, Short Circuit (at the motor (phase-to-phase)), and Overload). The PC board mounted “ST” and “OL” LEDs will indicate the drive status, as described in Sections 10.3 and 10.4, on page 21. Also see Section 7.3, on pages 16 and 17, for Automatic or Manual Start and Reset selection with Jumper J3.

- 9.2.1**  **WARNING! Drive Set for Automatic Start and Reset (Factory Setting)** – The drive will automatically restart after an Undervoltage or Overvoltage Fault has cleared (J3 set to the “AUTO” position). For an I²t Fault, be sure the fault has been cleared before restarting the drive. Check the motor current with an AC RMS responding ammeter. Also, the CL setting may be set too low. See Section 11.6, on pages 22 and 23. For an I²t or Short Circuit Fault, the drive must be restarted by setting the On/Off AC Line Switch to the “OFF” position for a minimum of 5 seconds.

- 9.2.2 Drive Set for Manual Start and Reset*** – In Manual Start Mode, the drive must be manually restarted, after a fault has cleared, using the optional Forward-Stop-Reverse Switch. If a Short Circuit or I²t Fault occurs, the drive can be restarted by setting either the On/Off AC Line Switch to the “OFF” position for a minimum of 5 seconds or setting the Forward-Stop-Reverse Switch to the “STOP” position.

***Note:** The optional Forward-Stop-Reverse Switch must be installed in order to use the drive for Manual Start operation.

10 PILOT LIGHT AND DIAGNOSTIC LEDs



WARNING! Do not depend on the Pilot Light or the PC board mounted LEDs to no longer be illuminated as a guaranteed power off condition. Be sure the main power switch or circuit breaker is in the “OFF” position before servicing the drive.

- 10.1 PILOT LIGHT** – Located on the front cover. The Pilot Light will illuminate orange when the AC line is applied to the drive and the On/Off AC Line Switch is set to the “ON” position.
- 10.2 POWER ON LED (ON)** – Located on the PC board. The “ON” LED will illuminate green when the AC line is applied to the drive and the On/Off AC Line Switch is set to the “ON” position.
- 10.3 STATUS LED (ST)** – Located on the PC board. The “ST” LED is a green LED, which provides indication of a fault or abnormal condition. The information provided can be used to diagnose an installation problem such as incorrect input voltage and drive output miswiring. It also provides a signal which informs the user that all drive and microcontroller operating parameters are normal. Table 6 summarizes the “ST” LED functions.
- 10.4 OVERLOAD LED (OL)** – Located on the PC board. The “OL” LED is a red LED, which provides indication of an overload condition. Table 6, summarizes the “OL” LED functions.

TABLE 6 – DRIVE OPERATING CONDITIONS & LED INDICATIONS

Drive Operating Condition	LED and Flash Rate ¹ Information	
	ST (Green)	OL (Red)
Normal operation	Slow Flash	Off
Overload (120% – 160% Full Load)	Off	On ²
I ² t (Drive Timed Out)	Off	Quick Flash
Short Circuit	Off	Slow Flash
Undervoltage	Quick Flash ³	On
Overvoltage	Slow Flash ³	On
Stop	On	On

Notes: 1. Slow Flash = 1 second on and 1 second off. Quick Flash = 0.25 second on and 0.25 second off. 2. When the Overload is removed, before the I²t times out and trips the drive, the “ST” LED will flash green and the “OL” LED will turn off. 3. In Manual Restart Mode, when the Undervoltage or Overvoltage condition is cleared, the “ST” and “OL” LEDs will flash red / (red and green) / green.

11 TRIMPOT ADJUSTMENTS

The drive contains trimpots which are factory set for most applications. See Figure 4, on page 12, for the location of the trimpots and their approximate factory calibrated positions. Some applications may require readjustment of the trimpots in order to set the drive for a specific requirement. The trimpots may be readjusted as described below.



WARNING! If possible, do not adjust trimpots with the main power applied. If adjustments are made with the main power applied, an insulated adjustment tool must be used and safety glasses must be worn. High voltage exists in this drive. Fire and/or electrocution can result if caution is not exercised. Safety Warning, on page 5, must be read and understood before proceeding.

- 11.1 MINIMUM SPEED (MIN)** – Sets the minimum speed of the motor. The MIN Trimpot is factory set to 0% of frequency setting. For a higher minimum speed, setting, rotate the MIN Trimpot clockwise. See Figure 17.

FIGURE 17 – MINIMUM SPEED TRIMPOT RANGE

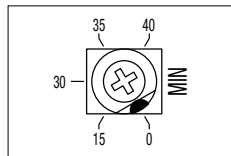

(Shown Factory Set to 0% Frequency Setting)

11.2 MAXIMUM SPEED (MAX) – Sets the maximum speed of the motor. The MAX Trimpot is factory set for 100% of frequency setting. For a lower maximum speed setting, rotate the MAX Trimpot counterclockwise. For a higher maximum speed setting, rotate the MAX Trimpot clockwise. See Figure 18.

11.3 ACCELERATION (ACCEL) – Sets the amount of time for the motor to accelerate from zero speed to full speed. The ACCEL Trimpot is factory set to 1.5 seconds. For a longer acceleration time, rotate the ACCEL Trimpot clockwise. For more rapid acceleration, rotate the ACCEL Trimpot counterclockwise. See Figure 19.

Note: Rapid acceleration settings may cause the current limit circuit to activate, which will extend the acceleration time.

11.4 DECELERATION (DECEL) – Sets the amount of time for the motor to decelerate from full speed to zero speed. The DECEL Trimpot is factory set to 1.5 seconds. For longer deceleration time, rotate the DECEL Trimpot clockwise. For more rapid deceleration, rotate the DECEL Trimpot counterclockwise. See Figure 20.

Application Note – On applications with high inertial loads, the deceleration may automatically increase in time. This will slow down the rate of speed of decrease to prevent the bus voltage from rising to the Overvoltage Trip point. This function is called Regeneration Protection. It is recommended that for very high inertial loads that both the ACCEL and DECEL Trimspots be set to greater than 10 seconds.

11.5 SLIP COMPENSATION (COMP) – Sets the amount of Volts/Hz to maintain set motor speed under varying loads. The COMP Trimpot is factory set to 1.5 Volts/Hz, which provides excellent speed regulation for most motors. To increase the slip compensation, rotate the COMP Trimpot clockwise. To decrease the slip compensation, rotate the COMP Trimpot counterclockwise. See Figure 21.

The slip compensation may be adjusted as follows:

1. Connect an AC RMS ammeter in series with one motor phase.
2. Run the motor and set the unloaded speed to approximately 50% (900 RPM on 4-pole 1500/1725 RPM motors).
3. Using a tachometer, record the unloaded speed.
4. Load the motor to the nameplate rated current (AC Amps).
5. Adjust the COMP Trimpot until the loaded RPM is equal to the unloaded RPM.

The motor is now compensated to provide constant speed under varying loads.

11.6 MOTOR OVERLOAD (I²t) WITH RMS CURRENT LIMIT (CL)* – Sets the current limit (overload), which limits the maximum current to the motor, preventing motor burnout and eliminating nuisance trips.

FIGURE 18 – MAXIMUM SPEED TRIMPOT RANGE

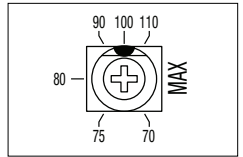

(Shown Factory Set to 100% of Frequency Setting)

FIGURE 19 – ACCELERATION TRIMPOT RANGE

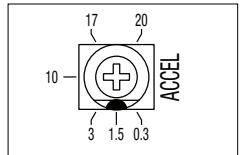

(Shown Factory Set to 1.5 Seconds)

FIGURE 20 – DECELERATION TRIMPOT RANGE

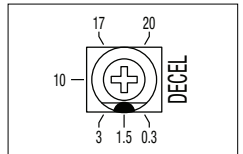

(Shown Factory Set to 1.5 Seconds)

FIGURE 21 – SLIP COMPENSATION TRIMPOT RANGE

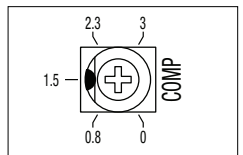

(Shown Factory Set to 1.5 Volts/Hz)

The CL Trimpot is factory set to 160% of the drive rated current. To increase the current limit, rotate the CL Trimpot clockwise. To decrease the current limit, rotate the CL Trimpot counterclockwise. See Figure 22.

FIGURE 22 – CURRENT LIMIT TRIMPOT RANGE

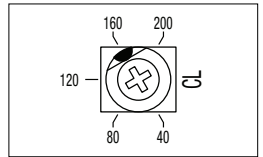

(Shown Factory Set to 160% Full Load)

Figure 23 shows the I^2t Trip Time vs. Motor Overload. Also see Section 4.2, on page 13.

**UL approved as an electronic overload protector for motors.*

CAUTION! Adjusting the current limit above 160% of the motor nameplate rating can cause overheating of the motor. Consult the motor manufacturer. Do not leave the motor in a locked rotor condition for more than a few seconds since damage may occur.

In order to ensure that the motor is properly protected with the I²t feature, it is required that the CL Trimpot be set for 160% of the motor nameplate rated current, as described on page 16.

Note: This adjustment must be made within 6 seconds or an P^2t Trip will occur.

The current limit may be adjusted as follows:

1. Connect an AC RMS ammeter in series with one motor phase.
2. Set the CL Trimpot fully counterclockwise.
3. Adjust the speed setting to 30%.
4. Lock the motor shaft and adjust the CL Trimpot to 160% of the motor nameplate rated current.

FIGURE 23 – I^2t TRIP TIME vs. MOTOR CURRENT

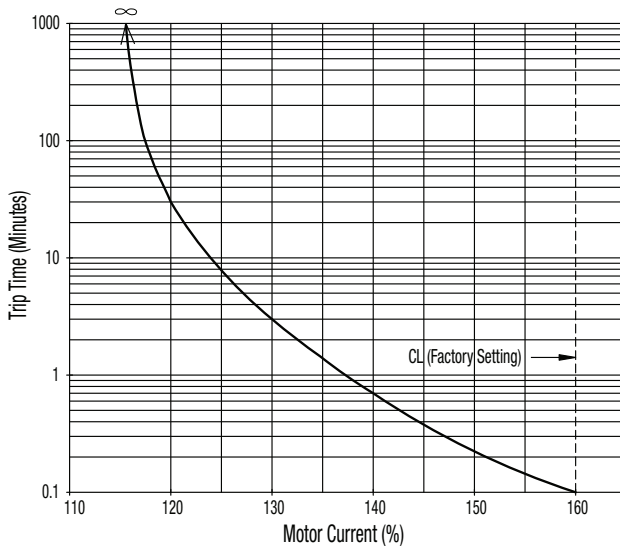

LIMITED WARRANTY

For a period of 18 months from the date of original purchase, RS Components, Ltd. will repair or replace without charge, devices which our examination proves to be defective in material or workmanship.

This warranty is valid if the unit has not been tampered with by unauthorized persons, misused, abused, or improperly installed and has been used in accordance with the instructions and/or ratings supplied.

The foregoing is in lieu of any other warranty or guarantee, expressed or implied. RS Components, Ltd. is not responsible for any expense, including installation and removal, inconvenience, or consequential damage, including injury to any person, caused by items of our manufacture or sale. Some states do not allow certain exclusions or limitations found in this warranty and therefore they may not apply to you. In any event, the total liability of RS Components, Ltd., under any circumstance, shall not exceed the full purchase price of this product. (rev 2/2000)

COPYRIGHT © 2017 RS Components, Ltd.

All rights reserved. In accordance with the United States Copyright Act of 1976, no part of this publication may be reproduced in any form or by any means without permission in writing from RS Components, Ltd. (8/2002)



RS Components Ltd.
PO Box 99, Corby, Northants. NN17 9RS United Kingdom
www.RSPro.com