

REVISIONS

P	LTR	DESCRIPTION	DATE	DWN	APVD
	BA	INITIAL DRAWING RELEASE	04SEP2024	AR	GT

FOR FURTHER DETAILS PLEASE REFER TO THICK FILM PRECISION RESISTOR TYPE RT73 SERIES

RECOMMENDED LAND PATTERN

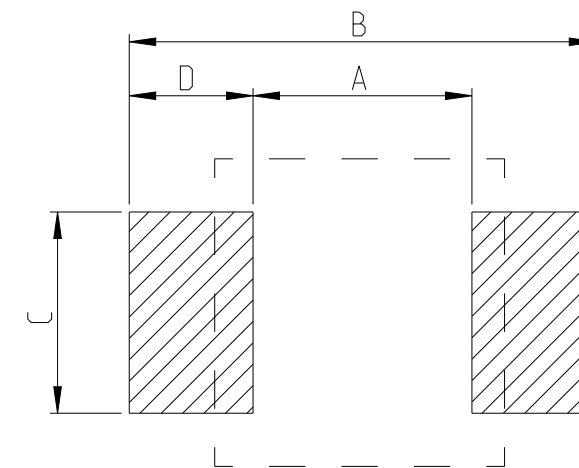

TYPE	SIZE (INCH)	A (mm)	B (mm)	C (mm)	D (mm)
RT73 1J	0603	1	2	0.6	0.5

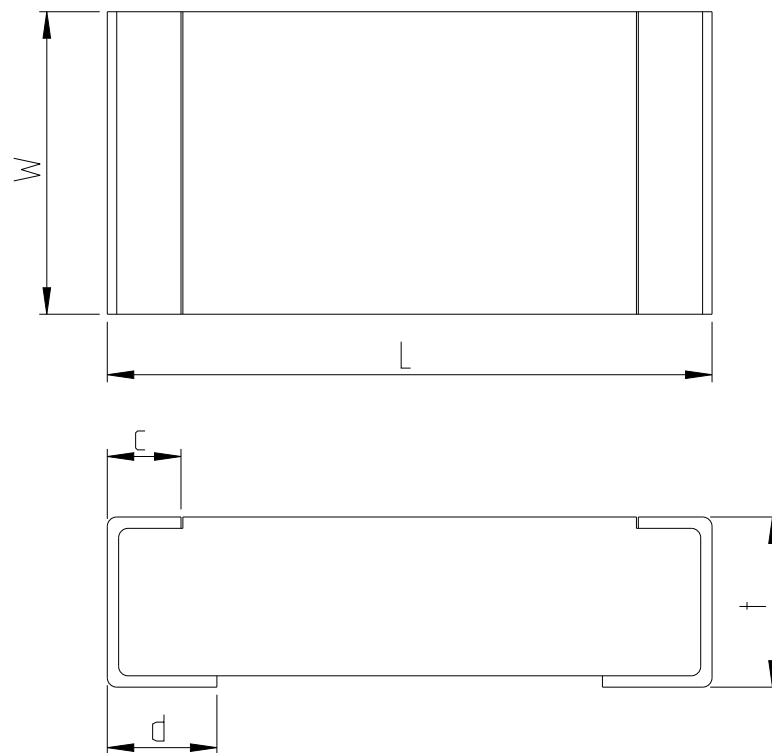

TYPE (INCH SIZE CODE)	L (mm)	W (mm)	c (mm)	d (mm)	t (mm)
1J (0603)	1.6±0.2	0.8±0.1	0.2±0.1	0.3±0.1	0.45±0.1

RoHS Compliant

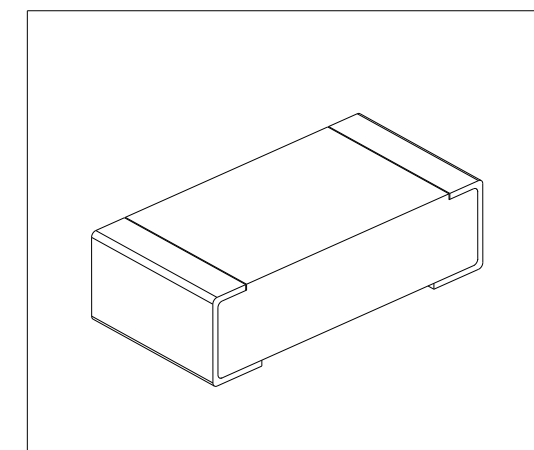

THIS DRAWING IS A CONTROLLED DOCUMENT.

DIMENSIONS:	TOLERANCES UNLESS OTHERWISE SPECIFIED:
mm	
	0 PLC ±
	1 PLC ±
	2 PLC ±
	3 PLC ±
	4 PLC ±
	ANGLES ±
MATERIAL	FINISH
-	-
-	-

DWN	ASHOK RAJ	04SEP2024
CHK	TRACY G	04SEP2024
APVD	TRACY G	04SEP2024
PRODUCT SPEC	-	
APPLICATION SPEC	-	
WEIGHT	-	
CUSTOMER DRAWING		



THICK FILM PRECISION RESISTOR TYPE RT73 1J SERIES

SIZE	CAGE CODE	DRAWING NO	RESTRICTED TO
A3	00779	C=2176760	-
SCALE 50:1		SHEET 1 OF 5	REV BA

REVISIONS

P	LTR	DESCRIPTION	DATE	DWN	APVD
-		SEE SHEET 1	-	-	-

SCHEDULE

TCPN	CATALOGUE NUMBER	PART DESCRIPTION	PART STATUS
2176760-1	RT73F1J12K4BTD	RT 1J 0.2W 12K4 0.1% 25PPM 5K RL	PRODUCTION
2176760-2	RT73F1J12K7BTD	RT 1J 0.2W 12K7 0.1% 25PPM 5K RL	PRODUCTION
2176760-3	RT73F1J13KBTD	RT 1J 0.2W 13K 0.1% 25PPM 5K RL	PRODUCTION
2176760-4	RT73F1J13K3BTD	RT 1J 0.2W 13K3 0.1% 25PPM 5K RL	PRODUCTION
2176760-5	RT73F1J13K7BTD	RT 1J 0.2W 13K7 0.1% 25PPM 5K RL	PRODUCTION
2176760-6	RT73F1J14KBTD	RT 1J 0.2W 14K 0.1% 25PPM 5K RL	PRODUCTION
2176760-7	RT73F1J14K3BTD	RT 1J 0.2W 14K3 0.1% 25PPM 5K RL	PRODUCTION
2176760-8	RT73F1J14K7BTD	RT 1J 0.2W 14K7 0.1% 25PPM 5K RL	PRODUCTION
2176760-9	RT73F1J15KBTD	RT 1J 0.2W 15K 0.1% 25PPM 5K RL	PRODUCTION
1-2176760-0	RT73F1J15K4BTD	RT 1J 0.2W 15K4 0.1% 25PPM 5K RL	PRODUCTION
1-2176760-1	RT73F1J15K8BTD	RT 1J 0.2W 15K8 0.1% 25PPM 5K RL	PRODUCTION
1-2176760-2	RT73F1J16K2BTD	RT 1J 0.2W 16K2 0.1% 25PPM 5K RL	PRODUCTION
1-2176760-3	RT73F1J16K5BTD	RT 1J 0.2W 16K5 0.1% 25PPM 5K RL	PRODUCTION
1-2176760-4	RT73F1J16K9BTD	RT 1J 0.2W 16K9 0.1% 25PPM 5K RL	PRODUCTION
1-2176760-5	RT73F1J17K4BTD	RT 1J 0.2W 17K4 0.1% 25PPM 5K RL	PRODUCTION
1-2176760-6	RT73F1J17K8BTD	RT 1J 0.2W 17K8 0.1% 25PPM 5K RL	PRODUCTION
1-2176760-7	RT73F1J18K2BTD	RT 1J 0.2W 18K2 0.1% 25PPM 5K RL	PRODUCTION
1-2176760-8	RT73F1J18K7BTD	RT 1J 0.2W 18K7 0.1% 25PPM 5K RL	PRODUCTION
1-2176760-9	RT73F1J19K1BTD	RT 1J 0.2W 19K1 0.1% 25PPM 5K RL	PRODUCTION
2-2176760-0	RT73F1J19K6BTD	RT 1J 0.2W 19K6 0.1% 25PPM 5K RL	PRODUCTION
2-2176760-1	RT73F1J20KBTD	RT 1J 0.2W 20K 0.1% 25PPM 5K RL	PRODUCTION
2-2176760-2	RT73F1J20K5BTD	RT 1J 0.2W 20K5 0.1% 25PPM 5K RL	PRODUCTION
2-2176760-3	RT73F1J21KBTD	RT 1J 0.2W 21K 0.1% 25PPM 5K RL	PRODUCTION
2-2176760-4	RT73F1J21K5BTD	RT 1J 0.2W 21K5 0.1% 25PPM 5K RL	PRODUCTION
2-2176760-5	RT73F1J22K1BTD	RT 1J 0.2W 22K1 0.1% 25PPM 5K RL	PRODUCTION

THIS DRAWING IS A CONTROLLED DOCUMENT.

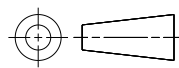
DIMENSIONS: mm	TOLERANCES UNLESS OTHERWISE SPECIFIED:
	0 PLC ± 1 PLC ± 2 PLC ± 3 PLC ± 4 PLC ± ANGLES ±
MATERIAL	FINISH
-	-
-	-

DWN	04SEP2024
ASHOK RAJ	
CHK	04SEP2024
TRACY G	
APVD	04SEP2024
TRACY G	
PRODUCT SPEC	
-	
APPLICATION SPEC	
-	
WEIGHT	-
CUSTOMER DRAWING	



TE Connectivity

NAME THICK FILM PRECISION RESISTOR
TYPE RT73 1J SERIES

SIZE	CAGE CODE	DRAWING NO	RESTRICTED TO
A3	00779	©=2176760	-

SCALE 1:1 SHEET 2 OF 5 REV BA

REVISIONS

P	LTR	DESCRIPTION	DATE	DWN	APVD
-		SEE SHEET 1	-	-	-

SCHEDULE

TCPN	CATALOGUE NUMBER	PART DESCRIPTION	PART STATUS
2-2176760-6	RT73F1J22K6BTD	RT 1J 0.2W 22K6 0.1% 25PPM 5K RL	PRODUCTION
2-2176760-7	RT73F1J23K2BTD	RT 1J 0.2W 23K2 0.1% 25PPM 5K RL	PRODUCTION
2-2176760-8	RT73F1J23K7BTD	RT 1J 0.2W 23K7 0.1% 25PPM 5K RL	PRODUCTION
2-2176760-9	RT73F1J24K3BTD	RT 1J 0.2W 24K3 0.1% 25PPM 5K RL	PRODUCTION
3-2176760-0	RT73F1J24K9BTD	RT 1J 0.2W 24K9 0.1% 25PPM 5K RL	PRODUCTION
3-2176760-1	RT73F1J25K5BTD	RT 1J 0.2W 25K5 0.1% 25PPM 5K RL	PRODUCTION
3-2176760-2	RT73F1J26K1BTD	RT 1J 0.2W 26K1 0.1% 25PPM 5K RL	PRODUCTION
3-2176760-3	RT73F1J26K7BTD	RT 1J 0.2W 26K7 0.1% 25PPM 5K RL	PRODUCTION
3-2176760-4	RT73F1J27K4BTD	RT 1J 0.2W 27K4 0.1% 25PPM 5K RL	PRODUCTION
3-2176760-5	RT73F1J28KBTD	RT 1J 0.2W 28K 0.1% 25PPM 5K RL	PRODUCTION
3-2176760-6	RT73F1J28K7BTD	RT 1J 0.2W 28K7 0.1% 25PPM 5K RL	PRODUCTION
3-2176760-7	RT73F1J29K4BTD	RT 1J 0.2W 29K4 0.1% 25PPM 5K RL	PRODUCTION
3-2176760-8	RT73F1J30K1BTD	RT 1J 0.2W 30K1 0.1% 25PPM 5K RL	PRODUCTION
3-2176760-9	RT73F1J30K9BTD	RT 1J 0.2W 30K9 0.1% 25PPM 5K RL	PRODUCTION
4-2176760-0	RT73F1J31K6BTD	RT 1J 0.2W 31K6 0.1% 25PPM 5K RL	PRODUCTION
4-2176760-1	RT73F1J32K4BTD	RT 1J 0.2W 32K4 0.1% 25PPM 5K RL	PRODUCTION
4-2176760-2	RT73F1J33K2BTD	RT 1J 0.2W 33K2 0.1% 25PPM 5K RL	PRODUCTION
4-2176760-3	RT73F1J34KBTD	RT 1J 0.2W 34K 0.1% 25PPM 5K RL	PRODUCTION
4-2176760-4	RT73F1J34K8BTD	RT 1J 0.2W 34K8 0.1% 25PPM 5K RL	PRODUCTION
4-2176760-5	RT73F1J35K7BTD	RT 1J 0.2W 35K7 0.1% 25PPM 5K RL	PRODUCTION
4-2176760-6	RT73F1J36K5BTD	RT 1J 0.2W 36K5 0.1% 25PPM 5K RL	PRODUCTION
4-2176760-7	RT73F1J37K4BTD	RT 1J 0.2W 37K4 0.1% 25PPM 5K RL	PRODUCTION
4-2176760-8	RT73F1J38K3BTD	RT 1J 0.2W 38K3 0.1% 25PPM 5K RL	PRODUCTION
4-2176760-9	RT73F1J39K2BTD	RT 1J 0.2W 39K2 0.1% 25PPM 5K RL	PRODUCTION
5-2176760-0	RT73F1J40K2BTD	RT 1J 0.2W 40K2 0.1% 25PPM 5K RL	PRODUCTION

THIS DRAWING IS A CONTROLLED DOCUMENT.

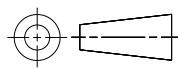
DIMENSIONS: mm	TOLERANCES UNLESS OTHERWISE SPECIFIED:
	0 PLC ± 1 PLC ± 2 PLC ± 3 PLC ± 4 PLC ± ANGLES ± FINISH -
MATERIAL -	-

DWN ASHOK RAJ	04SEP2024
CHK TRACY G	04SEP2024
APVD TRACY G	04SEP2024
PRODUCT SPEC	-
APPLICATION SPEC	-
WEIGHT	-
CUSTOMER DRAWING	

		TE Connectivity	
NAME THICK FILM PRECISION RESISTOR TYPE RT73 1J SERIES			
SIZE A3	CAGE CODE 00779	DRAWING NO C=2176760	RESTRICTED TO -
SCALE 1:1		SHEET 3 OF 5	REV BA

REVISIONS

P	LTR	DESCRIPTION	DATE	DWN	APVD
-		SEE SHEET 1	-	-	-

SCHEDULE

TCPN	CATALOGUE NUMBER	PART DESCRIPTION	PART STATUS
5-2176760-1	RT73F1J41K2BTD	RT 1J 0.2W 41K2 0.1% 25PPM 5K RL	PRODUCTION
5-2176760-2	RT73F1J42K2BTD	RT 1J 0.2W 42K2 0.1% 25PPM 5K RL	PRODUCTION
5-2176760-3	RT73F1J43K2BTD	RT 1J 0.2W 43K2 0.1% 25PPM 5K RL	PRODUCTION
5-2176760-4	RT73F1J44K2BTD	RT 1J 0.2W 44K2 0.1% 25PPM 5K RL	PRODUCTION
5-2176760-5	RT73F1J45K3BTD	RT 1J 0.2W 45K3 0.1% 25PPM 5K RL	PRODUCTION
5-2176760-6	RT73F1J46K4BTD	RT 1J 0.2W 46K4 0.1% 25PPM 5K RL	PRODUCTION
5-2176760-7	RT73F1J47K5BTD	RT 1J 0.2W 47K5 0.1% 25PPM 5K RL	PRODUCTION
5-2176760-8	RT73F1J48K7BTD	RT 1J 0.2W 48K7 0.1% 25PPM 5K RL	PRODUCTION
5-2176760-9	RT73F1J49K9BTD	RT 1J 0.2W 49K9 0.1% 25PPM 5K RL	PRODUCTION
6-2176760-0	RT73F1J51K1BTD	RT 1J 0.2W 51K1 0.1% 25PPM 5K RL	PRODUCTION
6-2176760-1	RT73F1J52K3BTD	RT 1J 0.2W 52K3 0.1% 25PPM 5K RL	PRODUCTION
6-2176760-2	RT73F1J53K6BTD	RT 1J 0.2W 53K6 0.1% 25PPM 5K RL	PRODUCTION
6-2176760-3	RT73F1J54K9BTD	RT 1J 0.2W 54K9 0.1% 25PPM 5K RL	PRODUCTION
6-2176760-4	RT73F1J56K2BTD	RT 1J 0.2W 56K2 0.1% 25PPM 5K RL	PRODUCTION
6-2176760-5	RT73F1J57K6BTD	RT 1J 0.2W 57K6 0.1% 25PPM 5K RL	PRODUCTION
6-2176760-6	RT73F1J59KBTD	RT 1J 0.2W 59K 0.1% 25PPM 5K RL	PRODUCTION
6-2176760-7	RT73F1J60K4BTD	RT 1J 0.2W 60K4 0.1% 25PPM 5K RL	PRODUCTION
6-2176760-8	RT73F1J61K9BTD	RT 1J 0.2W 61K9 0.1% 25PPM 5K RL	PRODUCTION
6-2176760-9	RT73F1J63K4BTD	RT 1J 0.2W 63K4 0.1% 25PPM 5K RL	PRODUCTION
7-2176760-0	RT73F1J64K9BTD	RT 1J 0.2W 64K9 0.1% 25PPM 5K RL	PRODUCTION
7-2176760-1	RT73F1J66K5BTD	RT 1J 0.2W 66K5 0.1% 25PPM 5K RL	PRODUCTION
7-2176760-2	RT73F1J68K1BTD	RT 1J 0.2W 68K1 0.1% 25PPM 5K RL	PRODUCTION
7-2176760-3	RT73F1J69K8BTD	RT 1J 0.2W 69K8 0.1% 25PPM 5K RL	PRODUCTION
7-2176760-4	RT73F1J71K5BTD	RT 1J 0.2W 71K5 0.1% 25PPM 5K RL	PRODUCTION
7-2176760-5	RT73F1J73K2BTD	RT 1J 0.2W 73K2 0.1% 25PPM 5K RL	PRODUCTION

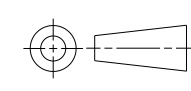
THIS DRAWING IS A CONTROLLED DOCUMENT.		DWN ASHOK RAJ	04SEP2024	 TE Connectivity	
DIMENSIONS: mm		CHK TRACY G	04SEP2024		
TOLERANCES UNLESS OTHERWISE SPECIFIED:		APVD TRACY G	04SEP2024	NAME THICK FILM PRECISION RESISTOR TYPE RT73 1J SERIES	
		PRODUCT SPEC		RESTRICTED TO	
MATERIAL		APPLICATION SPEC		SIZE	CAGE CODE
-		-		A3	00779
FINISH		WEIGHT		DRAWING NO	REV
-		-		©=2176760	BA
CUSTOMER DRAWING				SCALE	SHEET
				1:1	4 OF 5

REVISIONS

P	LTR	DESCRIPTION	DATE	DWN	APVD
-		SEE SHEET 1	-	-	-

SCHEDULE

TCPN	CATALOGUE NUMBER	PART DESCRIPTION	PART STATUS
7-2176760-6	RT73F1J75KBTD	RT 1J 0.2W 75K 0.1% 25PPM 5K RL	PRODUCTION
7-2176760-7	RT73F1J76K8BTD	RT 1J 0.2W 76K8 0.1% 25PPM 5K RL	PRODUCTION
7-2176760-8	RT73F1J78K7BTD	RT 1J 0.2W 78K7 0.1% 25PPM 5K RL	PRODUCTION
7-2176760-9	RT73F1J80K6BTD	RT 1J 0.2W 80K6 0.1% 25PPM 5K RL	PRODUCTION
8-2176760-0	RT73F1J82K5BTD	RT 1J 0.2W 82K5 0.1% 25PPM 5K RL	PRODUCTION
8-2176760-1	RT73F1J84K5BTD	RT 1J 0.2W 84K5 0.1% 25PPM 5K RL	PRODUCTION
8-2176760-2	RT73F1J86K6BTD	RT 1J 0.2W 86K6 0.1% 25PPM 5K RL	PRODUCTION
8-2176760-3	RT73F1J88K7BTD	RT 1J 0.2W 88K7 0.1% 25PPM 5K RL	PRODUCTION
8-2176760-4	RT73F1J90K9BTD	RT 1J 0.2W 90K9 0.1% 25PPM 5K RL	PRODUCTION
8-2176760-5	RT73F1J93K1BTD	RT 1J 0.2W 93K1 0.1% 25PPM 5K RL	PRODUCTION
8-2176760-6	RT73F1J95K3BTD	RT 1J 0.2W 95K3 0.1% 25PPM 5K RL	PRODUCTION
8-2176760-7	RT73F1J97K6BTD	RT 1J 0.2W 97K6 0.1% 25PPM 5K RL	PRODUCTION
8-2176760-8	RT73F1J100KBTD	RT 1J 0.2W 100K 0.1% 25PPM 5K RL	PRODUCTION
8-2176760-9	RT73F1J102KBTD	RT 1J 0.2W 102K 0.1% 25PPM 5K RL	PRODUCTION
9-2176760-0	RT73F1J105KBTD	RT 1J 0.2W 105K 0.1% 25PPM 5K RL	PRODUCTION
9-2176760-1	RT73F1J107KBTD	RT 1J 0.2W 107K 0.1% 25PPM 5K RL	PRODUCTION
9-2176760-2	RT73F1J110KBTD	RT 1J 0.2W 110K 0.1% 25PPM 5K RL	PRODUCTION
9-2176760-3	RT73F1J113KBTD	RT 1J 0.2W 113K 0.1% 25PPM 5K RL	PRODUCTION
9-2176760-4	RT73F1J115KBTD	RT 1J 0.2W 115K 0.1% 25PPM 5K RL	PRODUCTION
9-2176760-5	RT73F1J118KBTD	RT 1J 0.2W 118K 0.1% 25PPM 5K RL	PRODUCTION
9-2176760-6	RT73F1J121KBTD	RT 1J 0.2W 121K 0.1% 25PPM 5K RL	PRODUCTION
9-2176760-7	RT73F1J124KBTD	RT 1J 0.2W 124K 0.1% 25PPM 5K RL	PRODUCTION
9-2176760-8	RT73F1J127KBTD	RT 1J 0.2W 127K 0.1% 25PPM 5K RL	PRODUCTION
9-2176760-9	RT73F1J130KBTD	RT 1J 0.2W 130K 0.1% 25PPM 5K RL	PRODUCTION

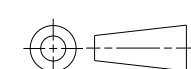
THIS DRAWING IS A CONTROLLED DOCUMENT.		DWN ASHOK RAJ	04SEP2024	 TE Connectivity	
DIMENSIONS: mm		CHK TRACY G	04SEP2024		
TOLERANCES UNLESS OTHERWISE SPECIFIED:		APVD TRACY G	04SEP2024	NAME THICK FILM PRECISION RESISTOR TYPE RT73 1J SERIES	
		PRODUCT SPEC	-	RESTRICTED TO	
MATERIAL		APPLICATION SPEC	-	SIZE	CAGE CODE
FINISH		WEIGHT	-	DRAWING NO	REV
-		CUSTOMER DRAWING		A3	00779
-		SCALE		1:1	SHEET
		SCALE		1:1	SHEET
		SHEET		5	OF
		SHEET		5	OF
		REV		BA	