

DORMER  PRAMET

TURNING

2021 – 2022

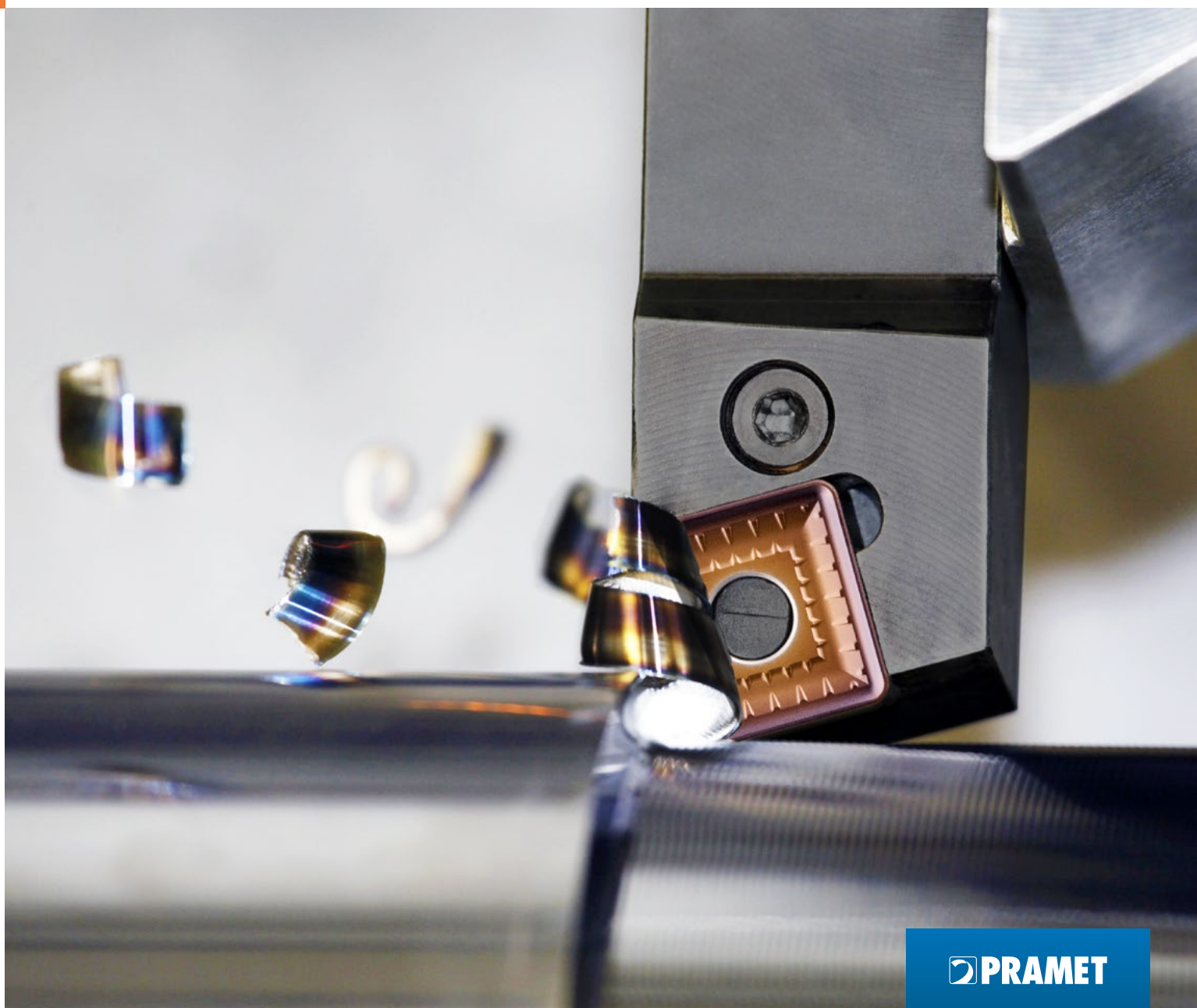



TURNING – GENERAL CONTENT

6	ISO TURNING	WMG & ISO 13399
10		INSTRUCTIONS
18		NAVIGATORS
57		POSITIVE INSERTS
219		NEGATIVE INSERTS
386		PARTING-OFF & GROOVING
482		THREAD TURNING
528		BROACHING
536		GENERAL TECHNICAL INFORMATION



PRODUCT FAMILY		PRODUCT FAMILY		PRODUCT FAMILY		PRODUCT FAMILY	
C		DTGN(RL) EXT	346	PCLN(RL) EXT	247	SEUP(RL) INT	113
C.-DCLN(RL) EXT	249	DU, D	415, 441, 460, 467	PCLN(RL) INT	255	SEXP(RL) INT	114
C.-DCLN(RL) INT	257	DVJN(RL) EXT	360	PDJN(RL) EXT	274	SEXP(RL)-E INT	115
C.-DDJN(RL) EXT	277	DVPN(RL) EXT	361	PDNN(RL) EXT	275	SI(RL)	479, 524
C.-DDNN EXT	278	DVUN(RL) INT	364	PDUN(RL) INT	281	SI(RL)-S	526
C.-DDUN(RL) EXT	279	DWLN(RL) EXT	377	PDXN(RL) EXT	276	SRDC(RL) EXT	126
C.-DDUN(RL) INT	282	DWLN(RL) INT	382	PHZ	533	SRDCN EXT	127
C.-DRSN(RL) EXT	297	G		PHZ-2	534	SRSC(RL) EXT	128
C.-DSDNN EXT	324	GFI(RL) EXT	437	PLBN(RL) EXT	290	SSBC(RL) EXT	139
C.-DSKN(RL) EXT	325	GFIL-L AXIAL	422, 444	PRDCN EXT	124	SSDCN EXT	140
C.-DSRN(RL) EXT	326	GFIL-R AXIAL	423, 445	PRSC(RL) EXT	125	SSKC(RL) EXT	141
C.-DSSN(RL) EXT	327	GFIR-L AXIAL	424, 446	PRSN(RL) EXT	296	SSSC(RL) INT	144
C.-DTFN(RL) INT	354	GFIR-R AXIAL	425, 447	PSBN(RL) EXT	318	STFC(RL) EXT	155
C.-DTJN(RL) EXT	351	GFK(RL) EXT	455	PSDNN EXT	320	STFC(RL) INT	158
C.-DVJN(RL) EXT	363	GFM(RL) EXT	439	PSKN(RL) EXT	321	STFC(RL)-A EXT	156
C.-DWLN(RL) EXT	381	GFML-L AXIAL	426, 448	PSKN(RL) INT	331	STFC(RL)-E INT	160
C.-DWLN(RL) INT	385	GFML-R AXIAL	427, 449	PSSN(RL) EXT	323	STJC(RL) EXT	157
C.-SCLC(RL) EXT	75	GFMR-L AXIAL	428, 450	PTFN(RL) EXT	348	SVAC(RL)-DC EXT	193
C.-SCLC(RL) INT	81	GFMR-R AXIAL	429, 450	PTFN(RL) INT	353	SVGC(RL) EXT	194
C.-SDJC(RL) EXT	96	GG.(RL) INT	421	PTGN(RL) EXT	349	SVHB(C)(RL) EXT	172, 195
C.-SDNCN EXT	97	GGI(RL)-90 AXIAL	430, 452	PTTN(RL) EXT	350	SVJB(C)(RL) EXT	173, 196
C.-SDUC(RL) INT	102	GLS B	414	PWLN(RL) EXT	380	SVJB(RL) INT	180, 204
C.-SRDCN EXT	130	GLSF(RL) EXT	410	PWLN(RL) INT	383	SVJC(RL)-DC EXT	197
C.-SVHB(RL) EXT	177, 201	GLSF(RL) EXT-G	412	S		SVLC(RL) INT	205
C.-SVJB(RL) EXT	178, 202	GLSF(RL) EXT-S	413	SCAC(RL) EXT	70	SVPB(C)(RL) EXT	174, 198
C.-SVQB(RL) INT	183, 210	K		SCBC(RL) EXT	71	SVQB(C)(RL) INT	181, 206
C.-SVVBN EXT	179, 203	KHP-CBN(RL)	251	SCDCR EXT	72	SVUB(C)(RL) INT	182, 207
CKJN(RL) EXT	287	KHP-CLN(RL)	252	SCFC(RL) EXT	73	SVVB(C)N EXT	175, 199
D		KHP-LBN(RL)	291	SCFC(RL) INT	76	SVXB(C)(RL) EXT	176, 200
DCBN(RL) EXT	240	KHP-RSC(RL)	131	SCKC(RL) INT	77	SVXC(RL) INT	208
DCKN(RL) EXT	242	KHP-SBN(RL)	328	SCLC(RL) EXT	74	SVXC(RL)-E INT	209
DCLN(RL) EXT	243	KHP-SSN(RL)	329	SCLC(RL) INT	78	SWLC(RL) EXT	215
DCLN(RL) INT	254	KHS-SBC(RL)	142	SCXC(RL) INT	80	SWLC(RL) INT	216
DDJN(RL) EXT	273	M		SDJC(RL) EXT	94	SWUC(RL) INT	217
DDUN(RL) INT	280	MS-EN	443, 463	SDNCN EXT	95	SWUC(RL)-E INT	218
DKH(RL)	132, 143, 253, 292, 330	MTJN(RL) EXT	347	SDQC(RL) INT	98	X	
DRSN(RL) EXT	295	MVJN(RL) EXT	362	SDUC(RL) INT	99	XLCCN 25 BS	442
DSBN(RL) EXT	313	MWLN(RL) EXT	379	SDUC(RL)-E INT	100	XLCCN B	440
DSDNN EXT	315	P		SDZC(RL) INT	101	XLCF(NRL) BS	461
DSKN(RL) EXT	316	P61(RL) EXT	470	SE(RL)	478, 522	XLCF(RL)	465
DSSN(RL) EXT	317	P61(RL) INT	471	SE(RL)-S	523	XLCFN B	459
DTFN(RL) EXT	345	P61S(RL)-1 INT	474	SEGC(RL) EXT	107	XLCFN B LFUX	466
DTFN(RL) INT	352	PCBN(RL) EXT	245	SELP(RL) INT	111	XLXFL BS AXIAL	462
		PCKN(RL) EXT	246	SELP(RL)-E INT	112		
				SEUC(RL) INT	108		



PRODUCT FAMILY		PRODUCT FAMILY		PRODUCT FAMILY		PRODUCT FAMILY	
C		L		SPMR		TNGA CBN	
CCGT	60	LCMF 13 – CM	418	SPUN	146	TNGA CER	343
CCGW CBN	69	LCMF 13 – F	418	T		TNGN CER	344
CCMT	62	LCMF 13 – MP	419	TCGT	149	TNMA	334
CCMW	68	LCMF 16 – CM	431	TCGW CBN	154	TNMG	335
CNGA CBN	239	LCMF 16 – M	433	TCMT	150	TNMM	342
CNGA CER	238	LCMF 16, LCMF 30 – F	432	TCMW	154	TPGN CER	164
CNGG	222	LCMF 16, LCMF 30 – MP	433	TN 55° PP EXT	508	TPGX	162
CNGN CER	238	LCMF 20 – F1	453	TN 55° PP INT	509	TPMR	163
CNMA	222	LCMF 20 – M2	453	TN 60° PP EXT	499	TPUN	164
CNMG	223	LCMF 20 – MP	454	TN 60° PP INT	500	V	
CNMM	234	LCMR 13 – F	419	TN 60°-S PP EXT	501	VBGW CBN	171
CPGX	83	LCMR 13 – MP	420	TN 60°-S PP INT	501	VBMT	168
D		LCMR 16 – CM	434	TN ACME EXT	515	VCGT	186
DCGT	86	LCMR 16 – M	435	TN ACME INT	516	VCGW	189
DCGW CBN	92	LCMR 16 – MP	436	TN API RD EXT	519	VCGX	189
DCMT	87	LCMR 16, LCMR 30 – F	435	TN API RD INT	519	VCMT	190
DCMW	92	LFMX – F1	456	TN BSPT EXT	510	VCMW	191
DCMW PCD	93	LFMX – F2	456	TN BSPT INT	510	VCMW PCD	192
DNGA CBN	272	LFMX – M2	457	TN M EXT	495	VNGA CBN	359
DNGA CER	271	LFUX	464	TN M INT	497	VNGA CER	359
DNGN CER	271	LNUX 40, LN.X 50	289	TN MJ EXT	499	VNMG	356
DNMA	260	R		TN NPT EXT	511	W	
DNMG	260	RCGT	118	TN NPT INT	512	WCGT	212
DNMM	270	RCGX CER	123	TN R EXT	475	WCGX	213
E		RCMT	118	TN R INT	475	WCMT	213
ECGT	104	RCMW	120	TN RD EXT	520	WNGA CBN	376
ECMT	105	RCMX	121	TN RD INT	520	WNMA	366
ECMW	106	RNGN CER	294	TN STACME EXT	517	WNMG	366
EPGX	110	RNMG	294	TN STACME INT	518	WNMM	375
EPMT	110	S		TN TR EXT	512	X	
G		SCGT	134	TN TR INT	513	X 61	468
GL. D – GM	406	SCMT	135	TN TR-S EXT	514	X 61 R	469
GL. D – MM	406	SCMW	138	TN TR-S INT	514	X 61 R-1	473
GL. D – PM	407	SNGA CER	311	TN UN EXT	502	X 61-1	472
GL. D – PR	408	SNGN CER	312	TN UN INT	503		
H		SNMA	300	TN UNJ EXT	504		
HZ	531	SNMG	301	TN W EXT	505		
HZ-2	532	SNMM	307	TN W INT	506		
K		SNMX	311	TN ZZ EXT	476		
KNUX	284	SPGN CER	147	TN ZZ INT	477		



TURNING – GENERAL CONTENT

6		WMG & ISO 13399
10	ISO TURNING	INSTRUCTIONS
18		NAVIGATORS
57		POSITIVE INSERTS
219		NEGATIVE INSERTS
386		PARTING-OFF & GROOVING
482		THREAD TURNING
528		BROACHING
536		GENERAL TECHNICAL INFORMATION



WORKPIECE MATERIAL GROUPS (WMG)

ISO To select a cutting grade and geometry for a broad range of workpiece materials

General definition
i.e. Steel, Stainless Steel...

P **M** **K** **N** **S** **H**

Subgroup To navigate and select a tool by suitability for a more specific range of workpiece materials

Definition by structure/composition
i.e. Plain Carbon Steel, Alloy Steel...

P **M** **K** **N** **S** **H**

P1

P2

P3

P4

WMG To select and provide cutting conditions within a bandwidth of $\pm 10\%$

Definition by hardness/ultimate tensile strength
i.e. $160 < 220$ HB, $620 < 900$ N/mm² ...

P

P1 **P1.1** **P1.2** **P1.3**

P2 **P2.1** **P2.2** **P2.3**

P3 **P3.1** **P3.2** **P3.3**

P4 **P4.1** **P4.2** **P4.3**

ABOUT DORMER PRAMET'S WORKPIECE MATERIAL CLASSIFICATION

Workpiece **Material Groups (WMG)** are used to support easy and reliable selection of the right cutting tool and starting values for machining conditions in particular applications.

Dormer Pramet classifies workpiece materials into six different coloured groups;

- **Blue:** Steel and cast steel (P-group)
- **Yellow:** Stainless steel (M-group)
- **Red:** Cast iron (K-group)
- **Green:** Non-ferrous metals (N-group)
- **Brown:** High-temperature alloys (S-group)
- **Grey:** Hardened materials (H-group)

Each of these are divided into subgroups on the basis of their structure and/or composition. For example, P-group steel and cast steel is split into four subgroups, namely;

- **P1** – Free machining steel
- **P2** – Plain carbon steel
- **P3** – Alloy steel
- **P4** – Tool steel

A final division includes material properties, such as hardness and ultimate tensile strength. This is to provide our customers with a complete tool recommendation, including starting values for cutting speed and feed.

The table on the next page includes a description of each workpiece material group, as well as examples of commonly used designations.



WMG (WORK MATERIAL GROUP)

ISO group	WMG (Work Material Group)		Hardness (HB or HRC)	Ultimate Tensile Strength (MPa)	Examples	
P	P1	P1.1	Sulfurized	< 240 HB	≤ 830	
		P1.2	Free machining steel	Sulfurized and phosphorized	< 180 HB	≤ 620
		P1.3	(carbon steels with increased machinability)	Sulfurized/phosphorized and leaded	< 180 HB	≤ 620
	P2	P2.1	Plain carbon steel (steels comprised of mainly iron and carbon)	Containing <0.25 % C	< 180 HB	≤ 620
		P2.2		Containing <0.55 % C	< 240 HB	≤ 830
		P2.3		Containing >0.55 % C	< 300 HB	≤ 1030
	P3	P3.1	Alloy steel (carbon steels with an alloying content ≤ 10%)	Annealed	< 180 HB	≤ 620
		P3.2		Hardened and tempered	180 – 260 HB	> 620 ≤ 900
		P3.3			260 – 360 HB	> 900 ≤ 1240
	P4	P4.1	Tool steel (special alloy steel for tools, dies and molds)	Annealed	< 26 HRC	≤ 900
P4.2		Hardened and tempered		26 – 39 HRC	> 900 ≤ 1240	
P4.3				39 – 45 HRC	> 1240 ≤ 1450	
M	M1	M1.1	Ferritic stainless steel (straight chromium non-hardenable alloys)	< 160 HB	≤ 520	
		M1.2		160 – 220 HB	> 520 ≤ 700	
	M2	M2.1	Martensitic stainless steel (straight chromium hardenable alloys)	Annealed	< 200 HB	≤ 670
		M2.2		Quenched and tempered	200 – 280 HB	> 670 ≤ 950
		M2.3		Precipitation-hardened	280 – 380 HB	> 950 ≤ 1300
	M3	M3.1	Austenitic stainless steel (chromium-nickel and chromium-nickel-manganese alloys)	< 200 HB	≤ 750	
		M3.2		200 – 260 HB	> 750 ≤ 870	
		M3.3		260 – 300 HB	> 870 ≤ 1040	
	M4	M4.1	Austenitic-ferritic (DUPLEX) or super-austenitic stainless steel	< 300 HB	≤ 990	
		M4.2	Precipitation hardening austenitic stainless steel	300 – 380 HB	≤ 1320	
K	K1	K1.1	Gray iron or Automotive Gray iron (GG) (iron-carbon castings with a lamellar graphite microstructure)	Ferritic or ferritic-pearlitic	< 180 HB	≤ 190
		K1.2		Ferritic-pearlitic or pearlitic	180 – 240 HB	> 190 ≤ 310
		K1.3		Pearlitic	240 – 280 HB	> 310 ≤ 390
	K2	K2.1	Malleable iron (GTS/GTW) (iron-carbon castings with a graphite-free microstructure)	Ferritic	< 160 HB	≤ 400
		K2.2		Ferritic or pearlitic	160 – 200 HB	> 400 ≤ 550
		K2.3		Pearlitic	200 – 240 HB	> 550 ≤ 660
	K3	K3.1	Ductile iron (GGG) (iron-carbon castings with a nodular graphite microstructure)	Ferritic	< 180 HB	≤ 560
		K3.2		Ferritic or pearlitic	180 – 220 HB	> 560 ≤ 680
		K3.3		Pearlitic	220 – 260 HB	> 680 ≤ 800
	K4	K4.1	Austenitic gray iron (ASTM A436) (iron-carbon alloy castings with an austenitic lamellar graphite microstructure)	< 180 HB	≤ 190	
K4.2		Austenitic ductile iron (ASTM A439 or ASTM A571) (iron-carbon alloy castings with an austenitic nodular graphite microstructure)	< 240 HB	≤ 740		
K4.3		Austempered ductile iron (ASTM A897) (iron-carbon alloy castings with an ausferrite microstructure)	< 280 HB	> 840 ≤ 980		
K4.4			280 – 320 HB	> 980 ≤ 1130		
K4.5			320 – 360 HB	> 1130 ≤ 1280		
K5	K5.1	Compacted graphite iron CGI (ASTM A842) (iron-carbon castings with a vermicular graphite structure)	Ferritic	< 180 HB	≤ 400	
	K5.2		Ferritic-pearlitic	180 – 220 HB	> 400 ≤ 450	
	K5.3		Pearlitic	220 – 260 HB	> 450 ≤ 500	
N	N1	N1.1	Commercially pure wrought aluminium	< 60 HB	≤ 240	
		N1.2		Half hard tempered	60 – 100 HB	> 240 ≤ 400
		N1.3		Full hard tempered	100 – 150 HB	> 400 ≤ 590
	N2	N2.1	Cast aluminium alloys	< 75 HB	≤ 240	
		N2.2		75 – 90 HB	> 240 ≤ 270	
		N2.3		90 – 140 HB	> 270 ≤ 440	
	N3	N3.1	Free-cutting copper-alloys materials with excellent machining properties	–	–	
		N3.2	Short-chip copper-alloys with good to moderate machining properties	–	–	
		N3.3	Electrolytic copper and long-chip copper-alloys with moderate to poor machining properties	–	–	
	N4	N4.1	Thermoplastic polymers	–	–	
N4.2		Thermosetting polymers	–	–		
N4.3		Reinforced polymers or composites	–	–		
N5	N5.1	Graphite	–	–		
S	S1	S1.1	Titanium or titanium alloys	< 200 HB	≤ 660	
		S1.2		200 – 280 HB	> 660 ≤ 950	
		S1.3		280 – 360 HB	> 950 ≤ 1200	
	S2	S2.1	Fe-based high-temperature alloys	< 200 HB	≤ 690	
		S2.2		200 – 280 HB	> 690 ≤ 970	
	S3	S3.1	Ni-based high-temperature alloys	< 280 HB	≤ 940	
		S3.2		280 – 360 HB	> 940 ≤ 1200	
	S4	S4.1	Co-based high-temperature alloys	< 240 HB	≤ 800	
S4.2		240 – 320 HB		> 800 ≤ 1070		
H	H1	H1.1	Chilled cast iron	< 440 HB	–	
		H1.2		–	–	
	H2	H2.1	Hardened cast iron	< 55 HRC	–	
		H2.2		> 55 HRC	–	
	H3	H3.1	Hardened steel <55 HRC	< 51 HRC	–	
		H3.2		51 – 55 HRC	–	
	H4	H4.1	Hardened steel >55 HRC	55 – 59 HRC	–	
		H4.2		> 59 HRC	–	

Examples of machining materials – see chapter GENERAL TECHNICAL INFORMATION (page 539).



CUTTING TOOL PARAMETERS ACCORDING TO ISO 13399

All cutting tools are defined by a number of parameters according to the standard ISO 13399. This list contains all the parameters used in this catalogue and their definitions.

ISO 13399 is an international cutting tool information standard. It provides dimensions and parameters in a neutral format that is independent of any particular system or company nomenclature. When cutting tools are clearly defined according to a global standard, all types of software can process the electronic data more quickly, improving the quality of communication and helping to make the exchange of information run smoothly. Supporting a common language in our cutting tool descriptions this will assist system to system communication. It will save you a significant amount of time, providing an easier gathering of high-quality data across our 40,000 solid and indexable tools. By using an ISO 13399 compliant system, there will be no need to manually interpret data and key-enter it into your system.

EXAMPLES ONLY!

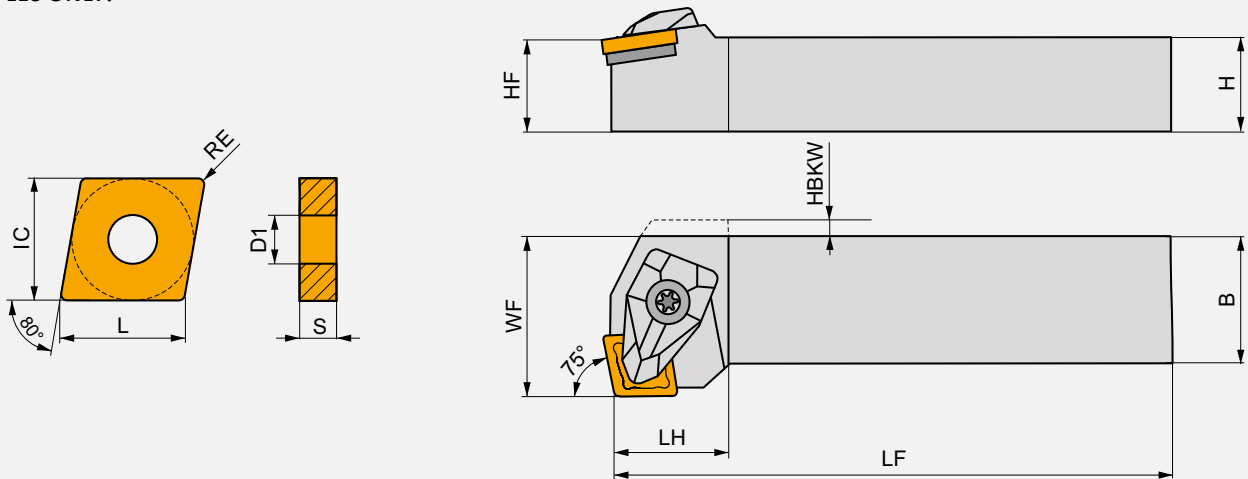

ISO 13399	Description
APMX	Depth of cut maximum
B	Shank width
BD	Body diameter
BLRAD	Blade reinforcement radius
BW	Insert body width
CDX	Cutting depth maximum
CND	Coolant entry diameter
CUTDIA	Work piece parting diameter maximum
CW	Cutting width
CWTOLL	Cutting width lower tolerance
CWTOLU	Cutting width upper tolerance
D1	Fixing hole diameter
DAXIN	Minimum axial groove inside diameter
DAXN	Minimum axial groove outside diameter
DAXX	Maximum axial groove outside diameter
DCON MS	Connection diameter
DMIN	Minimum bore diameter
DMINP	Minimum bore diameter perpendicular
GAMO	Orthogonal rake angle
GAMP	Axial rake angle
H	Shank height
HBH	Head bottom offset height
HBKW	Head bottom offset width
HF	Functional height
IC	Inscribed circle diameter
INSD	Insert diameter
INSL	Insert length

ISO 13399	Description
KAPR	Tool cutting edge angle
L	Cutting edge length
LAMS	Inclination angle
LB	Body length
LF	Functional length
LFA	A dimension on LF
LFS	Functional length secondary
LH	Head length
LU	Usable length
M	M-dimension
OAL	Overall length
PDX	Profile distance X
PDY	Profile distance Y
PSIRL	Tool lead angle left
PSIRR	Tool lead angle right
RE	Corner radius
S	Insert thickness
S1	Insert thickness total
TP	Thread pitch
TPI	Threads per inch
TPIN	Threads per inch
TPIX	Threads per inch
TPN	Thread pitch minimum
TPX	Thread pitch maximum
W1	Insert width
WF	Functional width
WFS	Functional width secondary



DORMER PRAMET



YOUR PERSONAL LIBRARY

Always revisiting the same sections of our publications? Our library app allows you to save key pages that you can revert back to again and again, whenever you need to. Simply Reliable. **Simply Reliable.**



ISO TURNING





TURNING – GENERAL CONTENT

6		WMG & ISO 13399
10	ISO TURNING	INSTRUCTIONS
18		NAVIGATORS
57		POSITIVE INSERTS
219		NEGATIVE INSERTS
386		PARTING-OFF & GROOVING
482		THREAD TURNING
526		BROACHING
533		TECHNICAL INFORMATION



TURNING INSERTS – PAGE OVERVIEW



1 CNMM

	IC [mm]	D1 [mm]	L [mm]	S [mm]
1204	12.700	5.16	12.90	4.76
1606	15.875	6.35	16.10	6.35
1906	19.050	7.94	19.30	6.35
2509	25.400	9.12	25.80	9.53

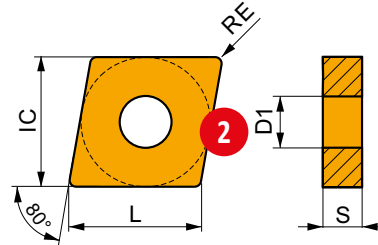

Suitability and starting values for cutting speed (vc), feed (f) and depth of cut (ap). Refer to our Machining Calculator app for further calculations.

Product	RE [mm]	P			M			K			N			S			H		
		vc [m/min]	f [mm/rev]	ap [mm]	vc [m/min]	f [mm/rev]	ap [mm]	vc [m/min]	f [mm/rev]	ap [mm]	vc [m/min]	f [mm/rev]	ap [mm]	vc [m/min]	f [mm/rev]	ap [mm]	vc [m/min]	f [mm/rev]	ap [mm]

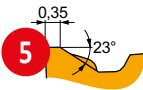

DR geometry for semi-rough to rough machining, and continuous to interrupted cuts.

CNMM 160612E-DR	T9315	1.2	225	0.45	6.0	–	–	–	210	0.45	6.0	–	–	–	–	–	–	–
	T8345	1.2	200	0.45	6.0	120	0.41	6.0	190	0.45	6.0	–	–	–	–	–	–	–
	T9335	1.2	170	0.45	6.0	100	0.41	6.0	–	–	–	–	–	–	–	–	–	–
CNMM 190608E-DR	T9315	0.8	215	0.40	8.0	–	–	–	200	0.40	8.0	–	–	–	–	–	–	–
	T9325	0.8	190	0.40	8.0	110	0.36	8.0	180	0.40	8.0	–	–	–	–	–	–	–
CNMM 190612E-DR	T9315	1.2	220	0.45	8.0	–	–	–	205	0.45	8.0	–	–	–	–	–	–	–
	T9325	1.2	195	0.45	8.0	115	0.41	8.0	185	0.45	8.0	–	–	–	–	–	–	–
	T9335	1.2	170	0.45	8.0	100	0.41	8.0	–	–	–	–	–	–	–	–	–	–
CNMM 190616E-DR	T9325	1.6	195	0.50	9.0	115	0.45	9.0	185	0.50	9.0	–	–	–	–	–	–	–
	T9335	1.6	170	0.50	9.0	100	0.45	9.0	–	–	–	–	–	–	–	–	–	–

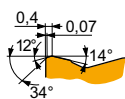

HR geometry for rough to heavy-rough machining, and continuous to interrupted cuts.

CNMM 190616E-HR	6640	1.6	75	0.60	10.0	45	0.54	10.0	70	0.60	10.0	–	–	–	–	–	–	–
	T8345	1.6	55	0.60	10.0	30	0.54	10.0	50	0.60	10.0	–	–	–	–	–	–	–
	T9325	1.6	105	0.60	10.0	60	0.54	10.0	95	0.60	10.0	–	–	–	–	–	–	–
	T9335	1.6	80	0.60	10.0	45	0.54	10.0	–	–	–	–	–	–	–	–	–	–

CNMM190616E-HR:T8345 Use full insert specification code when ordering!

Grade

Include colon

ISO insert code



TURNING INSERTS – PAGE OVERVIEW

Pos.	Description	Pos.	Description
1	Designation of insert	7	ISO insert code
2	Schematic drawing of insert	8	Grade
3	Table with insert sizes [mm]	9	Insert radii [mm]
4	Picture of representative insert	10	Geometry description
5	Profile of main cutting edge	11	Application area of insert
6	Icons – specific features and cutting edge type		

1

DDUN(RL) INT

P M K N S I 2

PRAMET 3 **D**



Internal Double Clamp Boring Bar with 93° Cutting Angle for DN.. Insert

Internal Right/Left hand double clamp boring bar, through **5** flant, 93° cutting angle for DN.. 11 and 15 inserts. Minimum internal turning diameter Ø32 mm. Suited for wide range of internal turning applications, copy turning up to 27°. Available with shank size Ø25 up to Ø50 mm. Body treated for longer tool life.

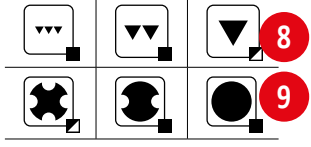
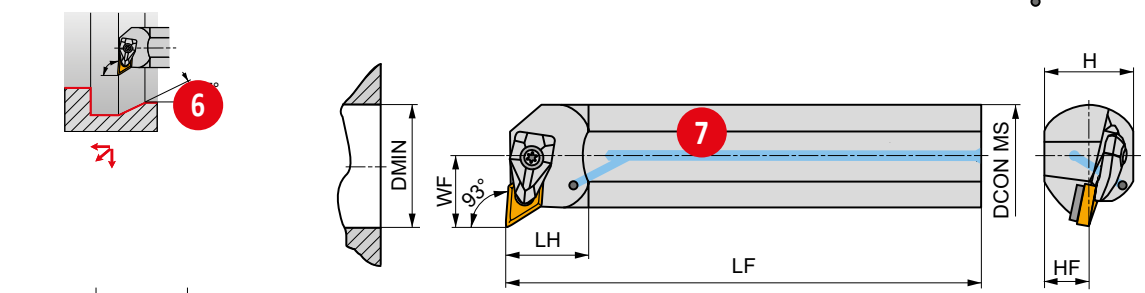

Product	DCON MS [mm]	DMIN [mm]	WF [mm]	H [mm]	HF [mm]	LF [mm]	LH [mm]	LAMS [°]	GAMO [°]	✓	kg	GI046	DD11	AT002
R A25T-DDUNR 11	25	32	17	23	11.5	300	28	-12	-6	✓	0.96	GI046	DD11	-
A32T-DDUNR 11	32	40	22	30	15	300	30	-10	-6	✓	1.68	GI046	DD11	-
A40T-DDUNR 15	40	50	27	37	18.5	300	36	-11	-6	✓	2.59	GI044	DD154	AT002
A50U-DDUNR 15	50	63	35	47	23.5	350	39	-8	-6	✓	5.25	GI044	DD154	AT002
L A25T-DDUNL 11	25	32	17	23	11.5	300	28	-12	-6	✓	0.96	GI046	DD11	-
A32T-DDUNL 11	32	40	22	30	15	300	30	-10	-6	✓	1.69	GI046	DD11	-
A40T-DDUNL 15	40	50	27	37	18.5	300	36	-11	-6	✓	2.59	GI044	DD154	AT002
A50U-DDUNL 15	50	63	35	47	23.5	350	39	-8	-6	✓	5.25	GI044	DD154	AT002

GI044	DN.. 1506..	19
GI046	DN.. 1104..	

DD11	DCS 09	1.7	DDS 267-01	US 2004-T09P	FLAG T09P	20
DD154	DCS 12	3.9	DDS 266-02	US 2002-T15P	FLAG T15P/3,5	

AT002a	DN.. 1504..	-	DDS 266-01	21
AT002b	CER DN.N 1506..	DCS 12C4	-	
AT002c	CER DN.A 1506..	DCS 12C2	-	



TURNING HOLDERS – PAGE OVERVIEW

Pos.	Description
1	Designation of turning holder
2	Material group recommendations
3	Clamping system of insert
4	Illustrative picture ¹⁾
5	Tool description
6	Workpiece profile
7	Schematic drawing of tool
8	Achievable quality of surface
9	Character of cut/working conditions
10	Product applications
11	Tool design

Pos.	Description
12	ISO code of holder
13	Dimensions [mm] and angles ²⁾ [°] of holder
14	Internal coolant supply
15	Weight [kg]
16	Group of compatible inserts ³⁾
17	Group of spare parts ^{3),4)}
18	Group of accessories ^{3),4)}
19	Compatible inserts
20	Spare parts
21	Special accessories

¹⁾ Turning holder is primarily displayed in its right design (R)

²⁾ GAMO = orthogonal rake angle (see technical pages)

LAMS = inclination angle of main cutting edge (see technical pages)

³⁾ Code of Group of compatible inserts, spare parts and special accessories is used only for purposes of this catalogue. It cannot be used for orders.

⁴⁾ Spare parts and special accessories icons are designed schematically for ease of understanding. They aren't included in list of icons. Screws are, in some cases, completed with info on torque value in Nm, length of screw and size of thread.



TURNING HOLDERS – ICONS OVERVIEW

GENERAL ICONS

	Primary use		Finishing – very good surface quality		Suitable for stable working conditions
	Possible use		Medium machining – good surface quality		Suitable for unstable working conditions
			Roughing – unlimited surface roughness		Suitable for very unstable working conditions

FEATURES

	First choice		Insert with Wiper geometry		Sharp edge
	For short chipping materials		Large overhang		Rounded edge
	For tough materials (long chipping)		Railway wheel machining		Edge with facet
	Heavy working conditions		Thin-walled and slim workpieces		Rounded edge with facet
	High Feed Cutting		Universal wide range option		Edge with double facet
	High Speed Cutting				Rounded edge with double facet





















TURNING OPERATIONS

	Cone turning – external		Chamfering (beveling)		Machining the rear face (shoulder) from the back
	Cone turning – internal		Chamfering (beveling) from the back		Multi directional copy turning – external
	Copy turning (multi directional machining)		Chamfering (beveling) in hole		Multi directional copy turning – internal
	Face copy turning		Longitudinal turning with shoulder – external		One directional copy turning – external
	Face copy turning in hole		Longitudinal turning with shoulder – internal		One directional copy turning – internal
	Face turning with shoulder		Longitudinal turning without shoulder – external		Shallow radial groove
	Face turning without shoulder		Longitudinal turning without shoulder – internal		



TURNING HOLDERS – ICONS OVERVIEW

TECHNICAL PAGES

	Fine finishing		Feed [mm/rev]		Very high cutting speed, excellent system rigidity (stable working conditions)
	Finishing		Durability [min]		High cutting speed, high system rigidity (stable working conditions)
	Medium machining		Grade		High cutting speed, system rigidity slightly limited (depth of cut changing)
	Roughing		Coating		Medium cutting speed, system rigidity limited (slightly interrupted cut)
	Heavy roughing		Cutting speed		Low cutting speed, low system rigidity (interrupted cut)
	Multiplication factor for cutting speed		Cutting edge profile		Very low cutting speed, very low system rigidity (very unstable working conditions)
	Depth of cut [mm]		Cooling		

OTHERS

	Clamping torque of screw [Nm]		Group of heads for roughing		Internal supply of coolant
---	-------------------------------	---	-----------------------------	---	----------------------------

ISO INSERTS POSITIVE – NAVIGATOR

CCGT



📖 60

CCMT



📖 62

CCMW



📖 68

CCGW CBN



📖 69

DCGT



📖 86

DCMT



📖 87

DCMW



📖 92

DCGW CBN



📖 92

DCMW PCD



📖 93

ECGT



📖 104

ECMT



📖 105

ECMW



📖 106

EPGX



📖 110

EPMT



📖 110

RCGT



📖 118

RCMT



📖 118

RCMW



📖 120

RCMX



📖 121

RCGX CER



📖 123

SCGT



📖 134

SCMT



📖 135

SCMW



📖 138

SPMR



📖 146

SPUN



📖 146

SPGN CER



📖 147

TCGT



📖 149

TCMT



📖 150

TCMW





















📖 154

TCGW CBN





📖 154

<p>TPGX</p>  <p> 162</p>	<p>TPMR</p>  <p> 163</p>	<p>TPUN</p>  <p> 164</p>	<p>TPGN CER</p>  <p> 164</p>	
<p>VBMT</p>  <p> 168</p>	<p>VBGW CBN</p>  <p> 171</p>	<p>VCGT</p>  <p> 186</p>	<p>VCGW</p>  <p> 189</p>	<p>VCGX</p>  <p> 189</p>
<p>VCMT</p>  <p> 190</p>	<p>VCMW</p>  <p> 191</p>	<p>VCMW PCD</p>  <p> 192</p>		
<p>WCGT</p>  <p> 212</p>	<p>WCGX</p>  <p> 213</p>	<p>WCMT</p>  <p> 213</p>		

ISO INSERTS NEGATIVE – NAVIGATOR

CNGG



 222

CNMA



 222

CNMG



 223

CNMM

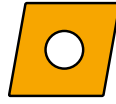

 234

CNGA CER



 238

CNGN CER



 238

CNGA CBN



 239

DNMA



 260

DNMG



 260

DNMM



 270

DNGA CER



 271

DNGN CER



 271

DNGA CBN



 272

KNUX



 284

LNUX 40, LN.X 50

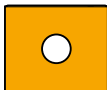

 289

RNMG



 294

RNGN CER



 294

ISO INSERTS NEGATIVE – NAVIGATOR

SNMA



300

SNMG



301

SNMM

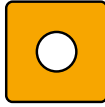

307

SNMX



311

SNGA CER



311

SNGN CER



312

TNMA



334

TNMG



335

TNMM



342

TNGA CER



343

TNGN CER



344

TNGA CBN



344

VNMG



356

VNGA CER



359

VNGA CBN



359

WNMA



366

WNMG



366

WNMM



375

WNGA CBN



376



ISO INSERTS POSITIVE – CHIPBREAKER NAVIGATOR

P

1st choice
 Possible use

Very unstable working conditions

Unstable working conditions

Stable working conditions

Thin-walled and slim workpieces

RF

SR

FF2

FM2

RM3

OR

FF

UR

FM

RM

DR4

SF3



	0.05 – 0.2 mm/rev	0.05 – 0.2 mm/rev	0.2 – 0.4 mm/rev	0.4 – 1.0 mm/rev	> 1.0 mm/rev
	0.05 – 2 mm	0.05 – 2 mm	2 – 4 mm	4 – 10 mm	> 10 mm

UR		Designed for fine to finish machining, steels and cast irons and potentially stainless steel, continuous and interrupted cuts
FM		Designed for finish to semi-rough machining, steels and stainless steels, potentially cast irons and non ferrous materials, continuous and moderately interrupted cuts
RM		Designed for semi-rough machining, steels, stainless steels and cast irons, potentially super alloys and hardened materials, continuous and interrupted cuts

OR		Designed for rough and heavy rough machining, steels, stainless steels and cast irons, potentially super alloys, continuous and interrupted cuts
-----------	--	--

M



Very unstable working conditions



Unstable working conditions



Stable working conditions



Thin-walled and slim workpieces



1st choice
Possible use



NF1



FM2



RF



SR

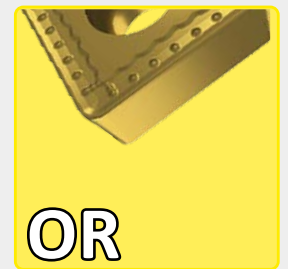

OR



SF2

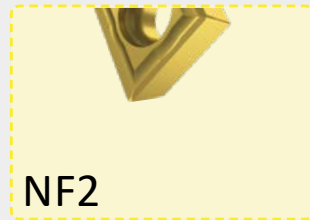

NF2



FM



RM



DR4



SF3

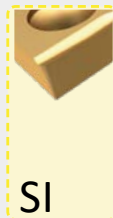

SI



0.05 – 0.2 mm/rev

0.05 – 0.2 mm/rev

0.2 – 0.4 mm/rev

0.4 – 1.0 mm/rev

> 1.0 mm/rev





0.05 – 2 mm

0.05 – 2 mm

2 – 4 mm

4 – 10 mm

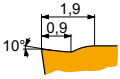
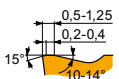
> 10 mm

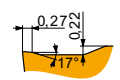
<p>NF1</p> 	<p>Positive design for fine-finish to medium machining, stainless steels and super alloys, potentially steels, non ferrous and hard materials, continuous cuts</p>	<p>OR</p> 	<p>Designed for rough and heavy rough machining, steels, stainless steels and cast irons, potentially super alloys. continuous and interrupted cuts</p>
<p>FM</p> 	<p>Designed for finish to semi-rough machining, steels and stainless steels, potentially cast irons and non ferrous materials, continuous and moderately interrupted cuts</p>		
<p>RM</p> 	<p>Designed for semi-rough machining, steels, stainless steels and cast irons, potentially super alloys and hardened materials, continuous and interrupted cuts</p>		



ISO INSERTS POSITIVE – CHIPBREAKER NAVIGATOR

K



Very unstable working conditions



Unstable working conditions



Stable working conditions



Thin-walled and slim workpieces



1st choice



Possible use

RM3

.CMW

RF

RM

SF3

SR

OR

DR4

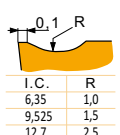
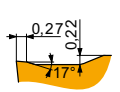
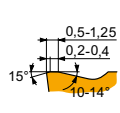

	0.05 – 0.2 mm/rev	0.05 – 0.2 mm/rev	0.2 – 0.4 mm/rev	0.4 – 1.0 mm/rev	> 1.0 mm/rev
	0.05 – 2 mm	0.05 – 2 mm	2 – 4 mm	4 – 10 mm	> 10 mm

<p>RF</p>  <table border="1" data-bbox="175 1758 295 1825"> <tr> <td>I. C.</td> <td>R</td> </tr> <tr> <td>6,35</td> <td>1,0</td> </tr> <tr> <td>9,525</td> <td>1,5</td> </tr> <tr> <td>12,7</td> <td>2,5</td> </tr> </table>	I. C.	R	6,35	1,0	9,525	1,5	12,7	2,5	<p>Designed for rough machining, cast irons, potentially steels, stainless steels and hard materials, continuous and interrupted cuts</p>			
I. C.	R											
6,35	1,0											
9,525	1,5											
12,7	2,5											
<p>RM</p> 	<p>Designed for semi-rough machining, steels, stainless steels and cast irons, potentially super alloys and hardened materials, continuous and interrupted cuts</p>											
<p>OR</p> 	<p>Designed for rough and heavy rough machining, steels, stainless steels and cast irons, potentially super alloys. continuous and interrupted cuts</p>											



ISO INSERTS POSITIVE – CHIPBREAKER NAVIGATOR

N



Very unstable working conditions



Unstable working conditions



Stable working conditions



Thin-walled and slim workpieces



1st choice

Possible use



SF3

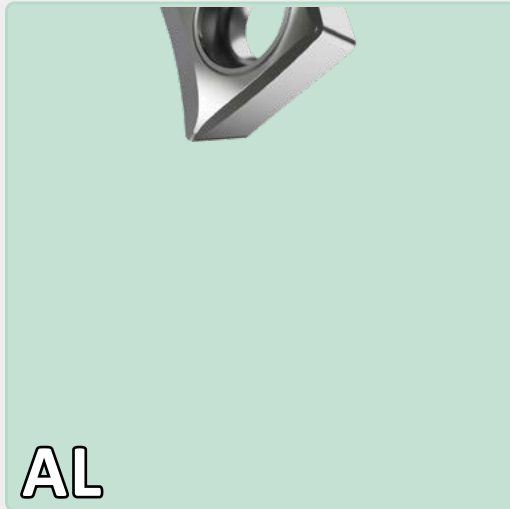

AL



NF1



FM



0.05 – 0.2 mm/rev

0.05 – 0.2 mm/rev

0.2 – 0.4 mm/rev

0.4 – 1.0 mm/rev

> 1.0 mm/rev



0.05 – 2 mm

0.05 – 2 mm

2 – 4 mm

4 – 10 mm

> 10 mm

SF3		<p>Very positive design for fine and finish machining, super alloys, stainless steels and non ferrous materials, potentially steel, cast irons and hard materials, continuous cuts</p>		
AL		<p>Highly positive design for fine finish to rough machining, aluminium, aluminium alloys and other non ferrous materials, potentially super alloys, continuous cuts</p>		



ISO INSERTS POSITIVE – CHIPBREAKER NAVIGATOR

S



Very unstable working conditions



Unstable working conditions



Stable working conditions



Thin-walled and slim workpieces



1st choice



Possible use



SF2



SF3

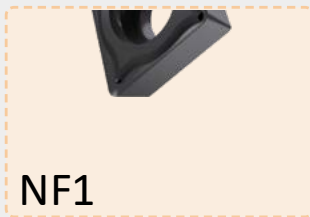

NF1



NF2



	0.05 – 0.2 mm/rev	0.05 – 0.2 mm/rev	0.2 – 0.4 mm/rev	0.4 – 1.0 mm/rev	> 1.0 mm/rev
	0.05 – 2 mm	0.05 – 2 mm	2 – 4 mm	4 – 10 mm	> 10 mm

SF2		Very positive design for fine and finish machining, super alloys, potentially stainless steels, steels and non ferrous materials, continuous cuts		
SF3		Very positive design for fine and finish machining, super alloys, stainless steels and non ferrous materials, potentially steel, cast irons and hard materials, continuous cuts		
NF2		Positive design for fine-finish to semi rough machining, stainless steels and super alloys, continuous cuts		

H



Very unstable working conditions



Unstable working conditions



Stable working conditions



Thin-walled and slim workpieces



1st choice



Possible use



RM3



NF1



.CMW



SF3



0.05 – 0.2 mm/rev

0.05 – 0.2 mm/rev

0.2 – 0.4 mm/rev

0.4 – 1.0 mm/rev

> 1.0 mm/rev





0.05 – 2 mm

0.05 – 2 mm

2 – 4 mm

4 – 10 mm

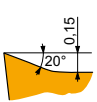
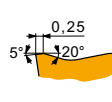
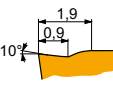
> 10 mm

SF3		Very positive design for fine and finish machining, super alloys, stainless steels and non ferrous materials, potentially steel, cast irons and hard materials, continuous cuts	RM3		Designed for rough machining, cast irons, potentially steels, stainless steels and hard materials, continuous and interrupted cuts
NF1		Positive design for fine-finish to medium machining, stainless steels and super alloys, potentially steels, non ferrous and hard materials, continuous cuts			
.CMW		Designed for fine finish to semi rough machining, cast irons, potentially hard materials, continuous and slightly interrupted cuts			



ISO INSERTS NEGATIVE – CHIPBREAKER NAVIGATOR

P

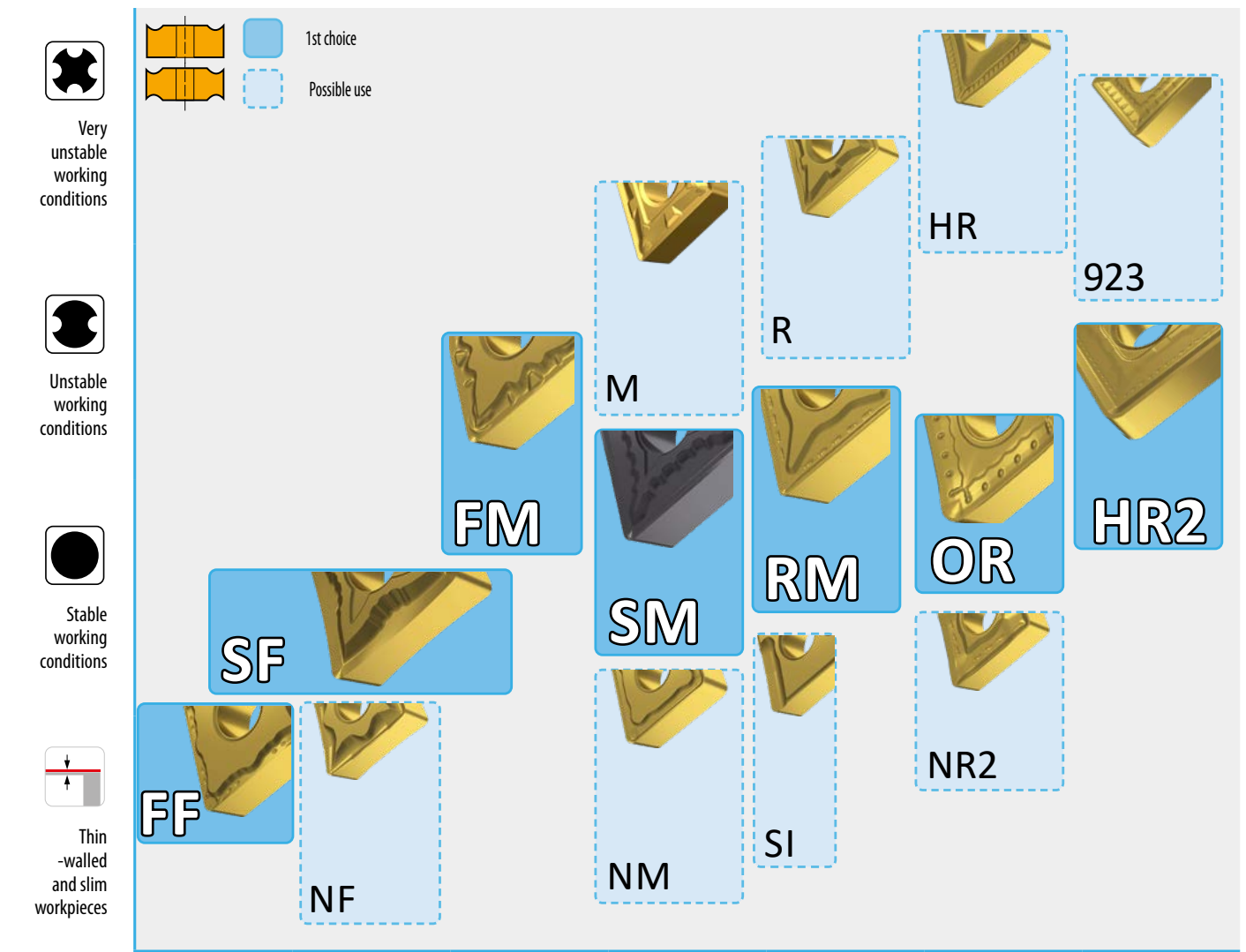

	0.05 – 0.2 mm/rev	0.05 – 0.2 mm/rev	0.2 – 0.4 mm/rev	0.4 – 1.0 mm/rev	> 1.0 mm/rev
	0.05 – 2 mm	0.05 – 2 mm	2 – 4 mm	4 – 10 mm	> 10 mm

FF		Highly positive geometry designed for fine finish machining, stainless steel and steel, potentially cast irons, continuous cuts
SF		Versatile positive geometry designed for fine finish machining, steels, stainless steels, cast irons and super alloys and hard materials, potentially non ferrous materials and for machining thin walls, with continuous cuts
FM		Positive geometry designed for finish to semi-rough machining, steel and cast irons, potentially and super alloys, continuous and moderately interrupted cuts

SM		Positive geometry designed for medium machining, stainless steels, super alloys, steels and cast irons, potentially non ferrous and hard materials and for machining thin walls, continuous and interrupted cuts
RM		Designed for semi-rough and rough machining, steels, stainless steels and cast irons, potentially super alloys, continuous and interrupted cuts
OR		Designed for finish to heavy rough machining, steels and cast irons, potentially stainless steel and super alloys, continuous and interrupted cuts

M



Very unstable working conditions



Unstable working conditions



Stable working conditions



Thin-walled and slim workpieces

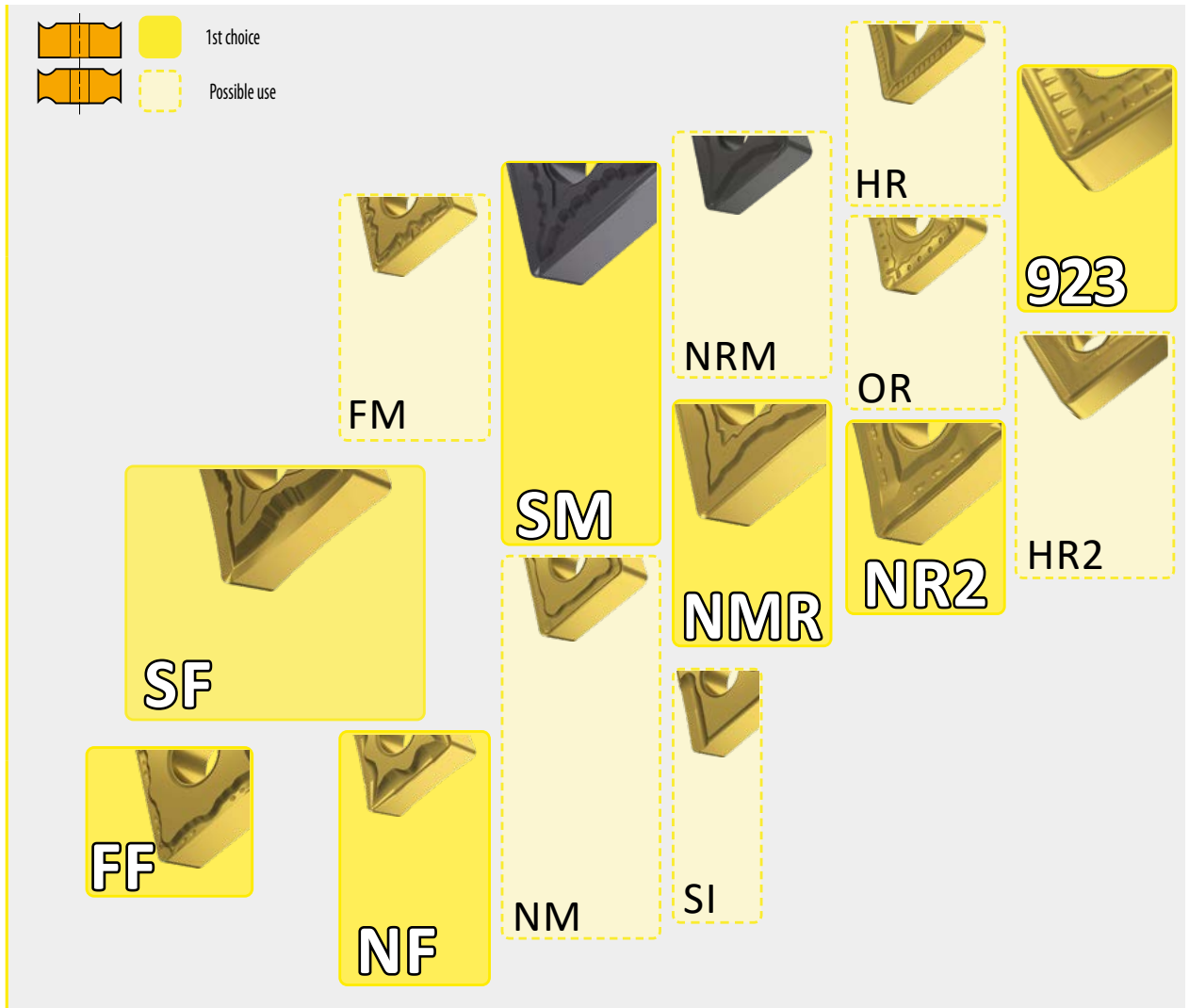
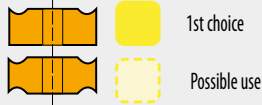

0.05 – 0.2 mm/rev

0.05 – 0.2 mm/rev

0.2 – 0.4 mm/rev

0.4 – 1.0 mm/rev

> 1.0 mm/rev



0.05 – 2 mm

0.05 – 2 mm

2 – 4 mm

4 – 10 mm

> 10 mm

FF		Highly positive geometry designed for fine finish machining, stainless steel and steel, potentially cast irons, continuous cuts	SM		Positive geometry designed for medium machining, stainless steels, super alloys, steels and cast irons, potentially non ferrous and hard materials and for machining thin walls, continuous and interrupted cuts
SF		Versatile positive geometry designed for fine finish machining, steels, stainless steels, cast irons and super alloys and hard materials, potentially non ferrous materials and for machining thin walls, with continuous cuts	NMR		Positive design for medium to rough machining, stainless steels as well as soft steels and super alloys, continuous cuts
NF		Highly positive design for fine finish and medium machining, stainless steels, steel, potentially cast irons, non ferrous materials and super alloys, continuous cuts	NR2		Designed for finish to rough machining, stainless steels and steels, potentially cast irons and super alloys, continuous and interrupted cuts



ISO INSERTS NEGATIVE – CHIPBREAKER NAVIGATOR

K



Very unstable working conditions



Unstable working conditions





Stable working conditions



Thin-walled and slim workpieces

1st choice



Possible use



.NMA

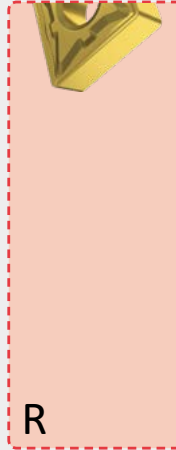

M



R



OR

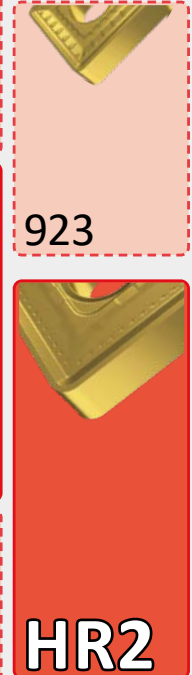

HR2



SF

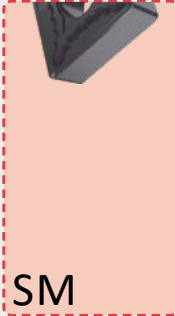

SM



KR



NR2

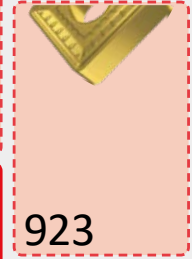

923

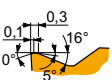
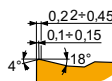
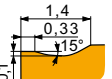
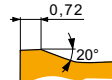

	0.05 – 0.2 mm/rev	0.05 – 0.2 mm/rev	0.2 – 0.4 mm/rev	0.4 – 1.0 mm/rev	> 1.0 mm/rev
	0.05 – 2 mm	0.05 – 2 mm	2 – 4 mm	4 – 10 mm	> 10 mm

.NMA		Designed for fine finish to semi rough machining, cast irons, potentially hard materials, continuous and slightly interrupted cuts			
M		Designed for finish and semi-rough machining, cast irons, potentially steels and hard materials, continuous and interrupted cuts	OR		Designed for finish to heavy rough machining, steels and cast irons, potentially stainless steel and super alloys, continuous and interrupted cuts
KR		Designed for semi-rough and rough machining, cast irons, potentially steel and hard materials, continuous and interrupted cuts	HR2		Designed for rough to heavy rough machining with high feeds, steels and cast irons, potentially stainless steels, continuous and interrupted cuts

N



Very unstable working conditions



Unstable working conditions



Stable working conditions



Thin-walled and slim workpieces

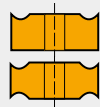

1st choice
Possible use

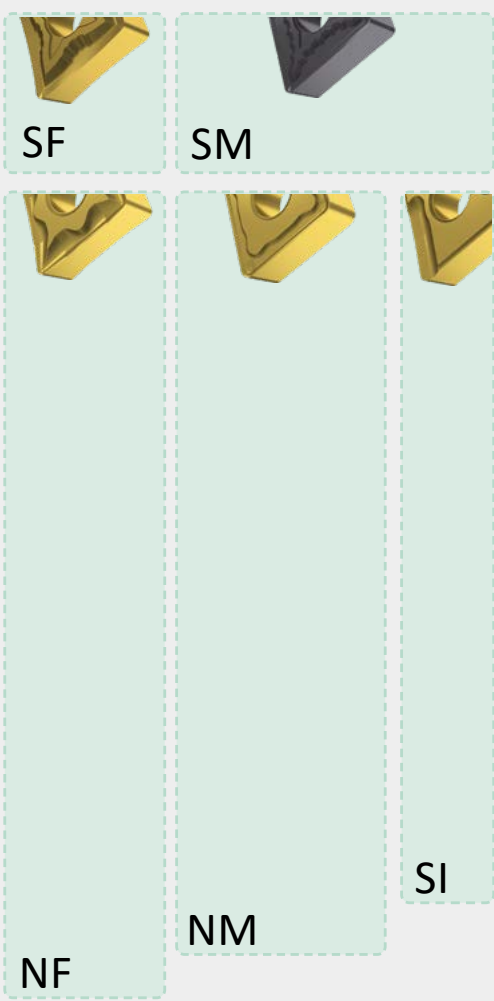

0.05 – 0.2 mm/rev

0.05 – 0.2 mm/rev

0.2 – 0.4 mm/rev

0.4 – 1.0 mm/rev

> 1.0 mm/rev



0.05 – 2 mm

0.05 – 2 mm

2 – 4 mm

4 – 10 mm

> 10 mm

SF		Versatile positive geometry designed for fine finish machining, steels, stainless steels, cast irons and super alloys and hard materials, potentially non ferrous materials and for machining thin walls, with continuous cuts
NF		Highly positive design for fine finish and medium machining, stainless steels, steel, potentially cast irons, non ferrous materials and super alloys, continuous cuts
SM		Positive geometry designed for medium machining, stainless steels, super alloys, steels and cast irons, potentially non ferrous and hard materials and for machining thin walls, continuous and interrupted cuts

NM		Highly positive design for fine finish, medium and rough machining, stainless steels, steels, potentially non ferrous materials and super alloys, continuous cuts
SI		Positive geometry for fine finish to semi-rough machining, steels, stainless steels and cast irons and potentially non ferrous materials, continuous cuts



ISO INSERTS NEGATIVE – CHIPBREAKER NAVIGATOR

S



Very unstable working conditions



Unstable working conditions



Stable working conditions



Thin-walled and slim workpieces

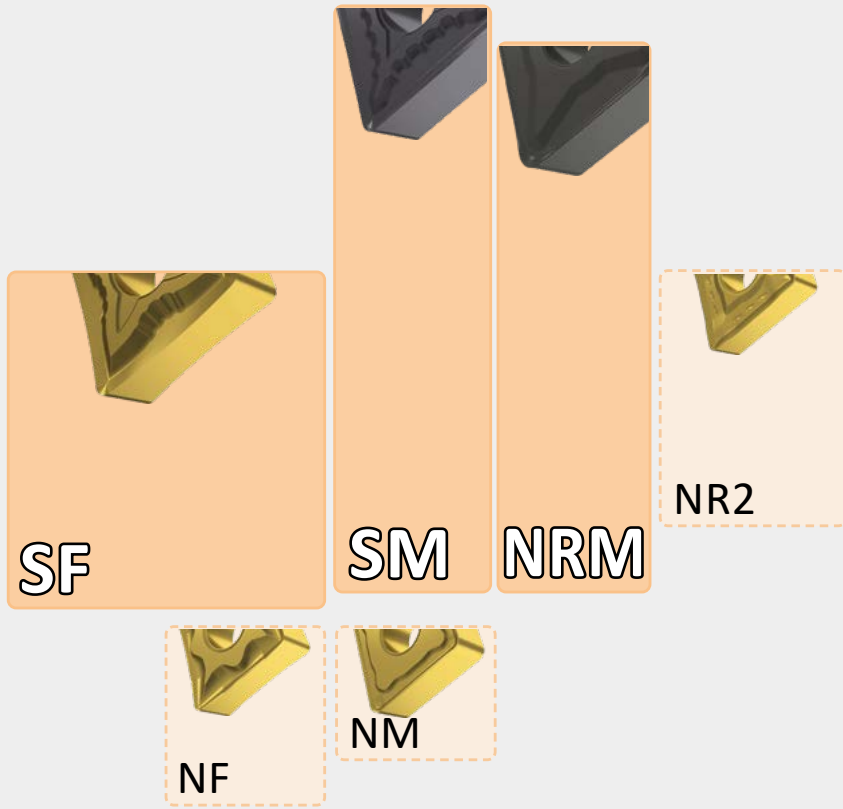

	0.05 – 0.2 mm/rev	0.05 – 0.2 mm/rev	0.2 – 0.4 mm/rev	0.4 – 1.0 mm/rev	> 1.0 mm/rev
	0.05 – 2 mm	0.05 – 2 mm	2 – 4 mm	4 – 10 mm	> 10 mm

SF		Versatile positive geometry designed for fine finish machining, steels, stainless steels, cast irons and super alloys and hard materials, potentially non ferrous materials and for machining thin walls, with continuous cuts
SM		Positive geometry designed for medium machining, stainless steels, super alloys, steels and cast irons, potentially non ferrous and hard materials and for machining thin walls, continuous and interrupted cuts
NRM		Positive design for semi-rough and rough machining, stainless steel, soft steels and super alloys, continuous cuts



ISO INSERTS NEGATIVE – CHIPBREAKER NAVIGATOR

H



Very unstable working conditions



Unstable working conditions



Stable working conditions



Thin-walled and slim workpieces



0.05 – 0.2 mm/rev

0.05 – 0.2 mm/rev

0.2 – 0.4 mm/rev

0.4 – 1.0 mm/rev

> 1.0 mm/rev



0.05 – 2 mm

0.05 – 2 mm

2 – 4 mm

4 – 10 mm

> 10 mm

SF		Versatile positive geometry designed for fine finish machining, steels, stainless steels, cast irons and super alloys and hard materials, potentially non ferrous materials and for machining thin walls, with continuous cuts	R		Designed for semi-rough and rough machining, cast irons, potentially steel and hard materials, continuous and interrupted cuts
SM		Positive geometry designed for medium machining, stainless steels, super alloys, steels and cast irons, potentially non ferrous and hard materials and for machining thin walls, continuous and interrupted cuts			
.NMA		Designed for fine finish to semi rough machining, cast irons, potentially hard materials, continuous and slightly interrupted cuts			



TURNING GRADES – NAVIGATOR

Group	Cemented carbide with MTCVD	Cemented carbide with PVD	Cemented carbide	CERMET
P01				
P05	T9310	T6310		TT010
P10				
P15	T9315			TT310
P20				
P25	T9325	T8430		
P30				
P35	T9335			
P40				
P45				
P50				

Group	Cemented carbide with MTCVD	Cemented carbide with PVD	Cemented carbide	CERMET
M01				
M05				
M10		T6310		
M15				
M20	T7325	T8315		
M25				
M30	T7335	T8430		
M35				
M40				

Group	Cemented carbide with MTCVD	Cemented carbide with PVD	Cemented carbide	CERMET
K01				
K05	T5305			
K10				
K15	T5315			
K20			HF7	
K25		T8430		
K30				
K35				
K40				

Group	Cemented carbide with MTCVD	Cemented carbide with PVD	Cemented carbide	CERMET
N01				
N05				
N10		T0315		
N15				
N20			HF7	
N25				
N30				

Group	Cemented carbide with MTCVD	Cemented carbide with PVD	Cemented carbide	CERMET
S01				
S05		T6310		
S10			H07	
S15	T7325			
S20	T7335			
S25				
S30				

Group	Cemented carbide with MTCVD	Cemented carbide with PVD	Cemented carbide	CERMET
H01				
H05				
H10	T5305	T6310		
H15		T8315		
H20	T9315			
H25				
H30				



TURNING GRADES – NAVIGATOR

Grade Identification	Area of Application	Application	Feed	Cutting speed	Resistance to adverse Working Conditions	Coating	Colour	Substrate	Coolant benefit	Grade description
T9310	P01 - P15	■				MT-CVD	FGM	FGM	++	Grade with high abrasion resistance which can be used for slightly interrupted cutting. It will be used for finishing or semi-roughing operations. This material can also be used for roughing operations provided the machine-tool-workpiece configuration is sufficiently rigid.
	K05 - K20	▣	▣	▣						
	H10 - H20	▣								
T9315	P05 - P25	■				MT-CVD	FGM	FGM	++	A versatile grade with excellent wear resistance properties even under intense cutting conditions. It can also be used for operations with interrupted cuts. With its well balanced properties this grade can be first choice for a wide range of turning operations. Not suited to low cutting speeds.
	K05 - K25	▣	▣	▣						
	H10 - H20	▣								
T9325	P15 - P35	■				MT-CVD	FGM	FGM	++	From a technological perspective this is an extremely versatile grade with high resistance to mechanical damage in adverse cutting conditions and retains excellent wear resistance. The correct application of this material requires high cutting speeds.
	M10 - M30	■	▣	▣						
	K15 - K35	▣	▣	▣						
	S10 - S20	▣								
T9335	P20 - P45	■				MT-CVD	FGM	FGM	+++	One of the toughest grades which is especially suitable for adverse cutting conditions at medium to high feed rates and medium cutting speeds. Compared to its predecessors, M15 – M40 it is not only tougher, but also more abrasion resistant which will be useful when using intensive cutting conditions.
	M15 - M40	■	▣	▣						
	S15 - S25	▣								
T7325	P15 - P35	▣				MT-CVD	FGM	FGM	+++	One of the most universal turning grades. Especially designed for stainless steel machining. Optimal balance between wear resistance and performance reliability. Suitable for broad variety of application in turning operations.
	M10 - M25	■	▣	▣						
	S10 - S25	■								
T7335	P20 - P40	▣				MT-CVD	FGM	FGM	+++	Grade with functionally graded substrate, featuring very high operational reliability and very good wear-resistance. It is best suited to use in the machining of very tough M20 – M40 materials.
	M20 - M40	■	▣	▣						
	S15 - S25	■								
T5305	P05 - P15	▣				MT-CVD	H	H	+	Grade with very high resistance to chemical wear; suitable for finishing operations using high cutting speeds. With its high abrasion resistance, it is also suitable for productive K01 – K15, machining of hardened and treated materials.
	K01 - K15	■	▣	▣						
	H05 - H15	▣								
T5315	P10 - P25	▣				MT-CVD	H	H	+	Grade intended primarily for productive machining which has high abrasion resistance and good operational reliability. Due to its properties, this material is particularly suitable for roughing and finishing operations for good or slightly adverse cutting conditions.
	K10 - K25	■	▣	▣						
	H15 - H25	▣								
6640	P20 - P40	■				MT-CVD	H	H	+++	One of the toughest turning materials which can be used especially in roughing operations, or where operational reliability under adverse cutting conditions is a priority. Another ideal choice for machines working with low to medium cutting speeds and medium to high feed rates.
	M20 - M35	■	▣	▣						
	K25 - K40	■								



TURNING GRADES – NAVIGATOR

Grade Identification	Area of Application	Application	Feed	Cutting speed	Resistance to adverse Working Conditions	Coating	Colour	Substrate	Coolant benefit	Grade description
T8315	P05 - P20	☑				PVD	Yellow	submicron H	++	Grade featuring excellent abrasion resistance while maintaining above average operational reliability, it is suitable for machining at medium to high cutting speeds in short chipping harder materials.
	M05 - M20	☑								
	K05 - K25	☑								
	N05 - N25	☑								
	S05 - S15	☑								
H05 - H15	☑									
T8430	P20 - P40	☑				PVD	Brown	submicron H	+++	Undoubtedly the most versatile cutting material, this is useful for machining of all types of machined materials and is practically applicable in almost all types of turning operations. Its main benefits are its high operational reliability and very good frictional properties; it is therefore suitable for applications at medium and lower cutting speeds.
	M20 - M35	☑								
	K25 - K40	☑								
	N15 - N30	☑								
	S15 - S25	☑								
H15 - H25	☑									
T8330	P25 - P40	☑				PVD	Yellow	submicron H	+++	Versatile cutting material, this is useful for machining of all types of machined materials and is practically applicable in almost all types of turning operations. Its main benefits are its high operational reliability and very good frictional properties; it is therefore suitable for applications at medium and lower cutting speeds.
	M20 - M35	☑								
	K20 - K40	☑								
	N15 - N30	☑								
	S15 - S25	☑								
H15 - H25	☑									
T8345	P30 - P50	☑				PVD	Yellow	submicron H	+++	This is the toughest turning grade, which is intended mainly for machining under the worst cutting conditions and in applications with the highest requirements for operating reliability. Because of these properties, this material is recommended for lower cutting speeds.
	M20 - M40	☑								
	K30 - K40	☑								
	S20 - S30	☑								
T6310	P01 - P15	☑				PVD	Grey	ultra submicron H	+++	High wear resistant turning grade with top PVD coating. Suitable for finishing operation and applications, where sharp cutting edge together with high flank wear resistance is of high importance
	M01 - M15	☑								
	K05 - K20	☑								
	N05 - N20	☑								
	S01 - S15	☑								
H01 - H15	☑									
T0315	N05 - N20	☑				PVD	Grey	submicron H	++	Submicron grade for turning non-ferrous metals and their alloys with a balance of wear resistance and toughness. It is provided with a unique coating with excellent friction properties.
HF7	M10 - M20	☑				X	Grey	submicron H	++	Uncoated grade which is primarily designed for machining non-ferrous metals; but can also be used for other machined materials (except steel). This material can be used in turning, milling, and even boring.
	K10 - K25	☑								
	N10 - N25	☑								
H07	M05 - M15	☑				X	Grey	submicron H	++	Uncoated turning grade suitable for machining applications where oxidation resistance is not dominating criterion of tool life. Designed for machining of Ti-based alloys. Grade exhibits high strength of cutting edge together with good wear resistance.
	K10 - K25	☑								
	N10 - N30	☑								
	S01 - S20	☑								
TT310	P10 - P25	☑				PVD	Grey	cermet	+/-	Coated cermet used for fine and finish turning of carbon and alloy steels (including stainless). Its excellent friction properties are further improved by the coating applied using the PVD technique.
	M15 - M25	☑								
TT010	P01 - P10	☑				X	Grey	cermet	+/-	Uncoated cermet, which is suitable for fine machining of all types of steel (including stainless) at very low feed rates. Its main advantage is the minimal radius of the cutting edge and its high resistance to physical and chemical wear mechanisms.
	M01 - M10	☑								



TURNING GRADES – NAVIGATOR

Grade Identification	Area of Application	Application	Feed	Cutting speed	Resistance to adverse Working Conditions	Coating	Colour	Substrate	Coolant benefit	Grade description
TC100	K01 - K15	■				×		ceramics	-	Ceramic grade for cast iron machining. Suitable for machining with high cutting speed at stable conditions.
TB310	K01 - K10	■				×		CBN	-	CBN grade for machining of hardened materials. Suitable for machining with high cutting speed and small feeds at stable conditions.
	S05 - S10	▣								
	H01 - H10	▣								
PD1	N05 - N25	■				×		PKD	-	PKD grade for turning non-ferrous materials. Ideal choice for working with high cutting speed and small feeds at stable conditions.
333TN	P45 - P50	■				PVD		HSS	+++	Special grade composed of HSS substrate and thin hard PVD coating. The most tough cutting grade in the portfolio. Inserts with this grade are one and only used for slotting of key groove.
	M35 - M40	▣								
	K35 - K40	▣								

Substrat	
H	WC-Co based substrate
submicron H	WC-Co based substrate fine grained (< 1 µm)
ultra submicron H	WC-Co based substrate very fine grained (< 0.5 µm)
FGM	Functionally graded substrate
Cermet	Cemented carbide without WC
ceramics	Cutting ceramics
PCD	Polycrystalline Diamond
CBN	Cubic Boron Nitride
HSS	High speed steel

Coating	
MT-CVD	Medium-temperature chemical method of coating
PVD	Low-temperature physical method of coating
×	Uncoated grade

Benefits of cutting fluid	
+++	Use of coolant is essential
++	Highly recommended
+	Recommended
+/-	Optional
--	Do not use coolant
-	Coolant not recommended

ISO TURNING – EXTERNAL

LONG AND UNSTABLE COMPONENTS (positive inserts)

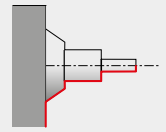

<p>SCAC(RL) EXT</p> <p>90°</p> <p>CC..</p> <p>06 09</p> <p>08×08 16×16</p> <p>70</p> <p>60–69</p>	<p>SCBC(RL) EXT</p> <p>75°</p> <p>CC..</p> <p>09 12</p> <p>12×12 25×25</p> <p>71</p> <p>60–69</p>	<p>SCDCR EXT</p> <p>45°</p> <p>CC..</p> <p>06</p> <p>10×10</p> <p>72</p> <p>60–69</p>	<p>SCFC(RL) EXT</p> <p>90°</p> <p>CC..</p> <p>06 09</p> <p>08×08 16×16</p> <p>73</p> <p>60–69</p>
<p>SCLC(RL) EXT</p> <p>95°</p> <p>CC..</p> <p>06 08 09 12</p> <p>08×08 25×25</p> <p>74</p> <p>60–69</p>	<p>SDJC(RL) EXT</p> <p>93°</p> <p>DC..</p> <p>07 11 15</p> <p>08×08 25×25</p> <p>94</p> <p>86–93</p>	<p>SDNCN EXT</p> <p>62°30'</p> <p>DC..</p> <p>7 11</p> <p>08×08 25×25</p> <p>95</p> <p>86–93</p>	<p>SEGC(RL) EXT</p> <p>90°</p> <p>EC..</p> <p>08</p> <p>12×12 16×16</p> <p>107</p> <p>104–106</p>
<p>SRDC(RL) EXT</p> <p>RC..</p> <p>08</p> <p>20×20 32×25</p> <p>126</p> <p>118–123</p>	<p>SRDCN EXT</p> <p>RC..</p> <p>06 08 10 12 16</p> <p>12×12 32×25</p> <p>127</p> <p>118–123</p>	<p>SRSC(RL) EXT</p> <p>RC..</p> <p>06 08 10 12 16</p> <p>12×12 32×25</p> <p>128</p> <p>118–123</p>	<p>SSBC(RL) EXT</p> <p>75°</p> <p>SC..</p> <p>09 12 25 38</p> <p>12×12 60×60</p> <p>139</p> <p>134–138</p>
<p>SSDCN EXT</p> <p>45°</p> <p>SC..</p> <p>09 12</p> <p>12×12 25×25</p> <p>140</p> <p>134–138</p>	<p>SSKC(RL) EXT</p> <p>75°</p> <p>SC..</p> <p>09 12</p> <p>12×12 25×25</p> <p>141</p> <p>134–138</p>	<p>STFC(RL) EXT</p> <p>90°</p> <p>TC..</p> <p>11 16</p> <p>16×16 25×25</p> <p>155</p> <p>149–154</p>	<p>STFC(RL)-A EXT</p> <p>90°</p> <p>TC..</p> <p>11</p> <p>20×20</p> <p>156</p> <p>149–154</p>

ISO TURNING – EXTERNAL

LONG AND UNSTABLE COMPONENTS (positive inserts)

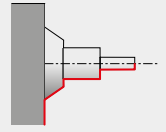

<p>STJC(RL) EXT</p> <p>93°</p> <p>TC..</p> <p>11 16</p> <p>16×16 25×25</p> <p>157 149 – 154</p>	<p>SVAC(RL)-DC EXT</p> <p>90°</p> <p>VC..</p> <p>13</p> <p>10×10 25×25</p> <p>193 186 – 192</p>	<p>SVGC(RL) EXT</p> <p>90°</p> <p>VC..</p> <p>07</p> <p>08×08 16×16</p> <p>194 186 – 192</p>	<p>SVHB(C)(RL) EXT</p> <p>107°30'</p> <p>VB, VC..</p> <p>11 16</p> <p>16×16 25×25</p> <p>172, 195 168 – 171 186 – 192</p>
<p>SVJB(C)(RL) EXT</p> <p>93°</p> <p>VB, VC..</p> <p>11 13 16</p> <p>12×12 32×25</p> <p>173, 196 168 – 171 186 – 192</p>	<p>SVJC(RL)-DC EXT</p> <p>93°</p> <p>VC..</p> <p>13</p> <p>10×10 25×25</p> <p>197 186 – 192</p>	<p>SVPB(C)(RL) EXT</p> <p>117°30'</p> <p>VB, VC..</p> <p>11 16</p> <p>16×16 32×25</p> <p>174, 198 168 – 171 186 – 192</p>	<p>SVVB(C)N EXT</p> <p>72°30'</p> <p>VB, VC..</p> <p>11 13 16</p> <p>12×12 32×25</p> <p>175, 199 168 – 171 186 – 192</p>
<p>SVXB(C)(RL) EXT</p> <p>98°</p> <p>VB, VC..</p> <p>11 13 16</p> <p>12×12 32×25</p> <p>176, 200 168 – 171 186 – 192</p>	<p>SWLC(RL) EXT</p> <p>95°</p> <p>WC..</p> <p>06 08</p> <p>16×16 25×25</p> <p>215 212 – 214</p>	<p>CKJN(RL) EXT</p> <p>93°</p> <p>KN..</p> <p>16</p> <p>20×20 32×25</p> <p>287 284 – 286</p>	<p>C.-SCLC(RL) EXT</p> <p>95°</p> <p>CC..</p> <p>09 12</p> <p>20 32</p> <p>75 60 – 69</p>
<p>C.-SDJC(RL) EXT</p> <p>93°</p> <p>DC..</p> <p>11</p> <p>C3 C5</p> <p>96 86 – 93</p>	<p>C.-SDNCN EXT</p> <p>62°30'</p> <p>DC..</p> <p>11</p> <p>C4 C5</p> <p>97 86 – 93</p>	<p>C.-SRDCN EXT</p> <p>90°</p> <p>RC..</p> <p>10 12</p> <p>C4 C5</p> <p>130 118 – 123</p>	<p>C.-SVHB(RL) EXT</p> <p>107°30'</p> <p>VB, VC..</p> <p>16</p> <p>C4 C6</p> <p>177, 201 168 – 171 186 – 192</p>



ISO TURNING – EXTERNAL

LONG AND UNSTABLE COMPONENTS (positive inserts)

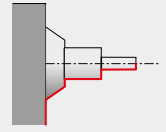

C.-SVJB(RL) EXT	
93°	VB, VC..
	11 16
	$\frac{C3}{C6}$
178, 202	168 – 171 186 – 192

C.-SVVBN EXT	
72°30'	VB, VC..
	16
	$\frac{C4}{C6}$
179, 203	168 – 171 186 – 192

ISO TURNING – INTERNAL

LONG AND UNSTABLE COMPONENTS (positive inserts)

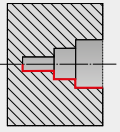

<p>SCFC(RL) INT</p> <p>90°</p> <p>CC..</p> <p>06</p> <p>$\frac{13}{16}$</p> <p>76</p> <p>60 – 69</p>	<p>SCKC(RL) INT</p> <p>75°</p> <p>CC..</p> <p>06 09 12</p> <p>$\frac{11}{40}$</p> <p>77</p> <p>60 – 69</p>	<p>SCLC(RL) INT</p> <p>95°</p> <p>CC..</p> <p>06 09 12</p> <p>$\frac{11}{40}$</p> <p>78</p> <p>60 – 69</p>	<p>SCXC(RL) INT</p> <p>40°</p> <p>CC..</p> <p>06</p> <p>$\frac{13}{20}$</p> <p>80</p> <p>60 – 69</p>
<p>SDQC(RL) INT</p> <p>107°30'</p> <p>DC..</p> <p>07 11</p> <p>$\frac{13}{40}$</p> <p>98</p> <p>86 – 93</p>	<p>SDUC(RL) INT</p> <p>93°</p> <p>DC..</p> <p>07 11</p> <p>$\frac{13}{40}$</p> <p>99</p> <p>86 – 93</p>	<p>SDUC(RL)-E INT</p> <p>93°</p> <p>DC..</p> <p>07 11</p> <p>$\frac{13}{40}$</p> <p>100</p> <p>86 – 93</p>	<p>SDZC(RL) INT</p> <p>93°</p> <p>DC..</p> <p>07 11</p> <p>$\frac{27}{65}$</p> <p>101</p> <p>86 – 93</p>
<p>SELP(RL) INT</p> <p>95°</p> <p>EP..</p> <p>05</p> <p>$\frac{8}{16}$</p> <p>111</p> <p>110</p>	<p>SELP(RL)-E INT</p> <p>95°</p> <p>EP..</p> <p>05</p> <p>$\frac{8}{16}$</p> <p>112</p> <p>110</p>	<p>SEUC(RL) INT</p> <p>93°</p> <p>EC..</p> <p>06 08</p> <p>$\frac{11}{32}$</p> <p>108</p> <p>104 – 106</p>	<p>SEUP(RL) INT</p> <p>93°</p> <p>EP..</p> <p>05</p> <p>8.3</p> <p>113</p> <p>110</p>
<p>SEXP(RL) INT</p> <p>52°30'</p> <p>EP..</p> <p>05</p> <p>$\frac{9.5}{16}$</p> <p>114</p> <p>110</p>	<p>SEXP(RL)-E INT</p> <p>52°30'</p> <p>EP..</p> <p>05</p> <p>$\frac{9.5}{16}$</p> <p>115</p> <p>110</p>	<p>SSSC(RL) INT</p> <p>45°</p> <p>SC..</p> <p>09</p> <p>$\frac{25}{32}$</p> <p>144</p> <p>134 – 138</p>	<p>STFC(RL) INT</p> <p>90°</p> <p>TC..</p> <p>06 09 11 16</p> <p>$\frac{8.5}{40}$</p> <p>158</p> <p>149 – 154</p>

ISO TURNING – INTERNAL

LONG AND UNSTABLE COMPONENTS (positive inserts)

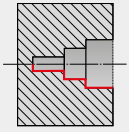

STFC(RL)-E INT	
90°	TC..
	 06 09 11
	$\frac{8.5}{20}$
160	149 – 154

SVJB(RL) INT	
93°	VB, VC..
	 11
	$\frac{25}{32}$
180, 204	168 – 171 186 – 192

SVLC(RL) INT	
95°	VC..
	 13
	$\frac{27}{43}$
205	186 – 192

SVQB(C)(RL) INT	
107°30'	VB, VC..
	 11 13 16
	$\frac{20}{50}$
181, 206	168 – 171 186 – 192

SVUB(C)(RL) INT	
93°	VB, VC..
	 11 13 16
	$\frac{20}{50}$
182, 207	168 – 171 186 – 192

SVXC(RL) INT	
113°	VC..
	 07
	$\frac{12.5}{17.5}$
208	186 – 192

SVXC(RL)-E INT	
113°	VC..
	 07
	$\frac{12.5}{17.5}$
209	186 – 192

SWLC(RL) INT	
95°	WC..
	 06 08
	$\frac{25}{40}$
216	212 – 214

SWUC(RL) INT	
93°	WC..
	 02
	$\frac{5.8}{7.8}$
217	212 – 214

SWUC(RL)-E INT	
93°	WC..
	 02
	$\frac{5.8}{7.8}$
218	212 – 214

C.-SCLC(RL) INT	
95°	CC..
	 09
	$\frac{C3}{C5}$
81	60 – 69

C.-SDUC(RL) INT	
93°	DC..
	 07 11
	$\frac{20}{32}$
102	86 – 93

C.-SVQB(C)(RL) INT	
108°	VB, VC..
	 16
	33
183, 210	168 – 171 186 – 192

ISO TURNING – EXTERNAL

SHORT AND STABLE COMPONENTS (negative inserts)

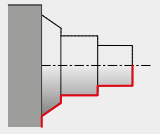

DCBN(RL) EXT 75° 240 222 – 239		CN.. 12 16 19 25 245 222 – 239		DCKN(RL) EXT 75° 242 222 – 239		CN.. 12 16 19 25 246 222 – 239	
DCLN(RL) EXT 95° 243 222 – 239		CN.. 09 12 16 19 25 247 222 – 239		DDJN(RL) EXT 93° 273 260 – 272		DN.. 11 15 15 15 274 260 – 272	
PDNN(RL) EXT 62°30' 275 260 – 272		DN.. 11 15 15 15 276 260 – 272		PDXN(RL) EXT 98° 276 260 – 272		DN.. 15 15 15 15 124 118 – 123	
PRDCN EXT 124 118 – 123		PRSC(RL) EXT 125 118 – 123		RC.. 16 20 25 32 125 118 – 123		RC.. 16 20 25 25 125 118 – 123	
DRSN(RL) EXT 295 294		RN.. 12 12 15 19 296 294		DSBN(RL) EXT 75° 313 300 – 312		SN.. 12 15 19 19 318 300 – 312	
PSBN(RL) EXT 75° 318 300 – 312		SN.. 12 15 19 25 318 300 – 312		SN.. 12 15 19 25 318 300 – 312		SN.. 12 15 19 25 318 300 – 312	

ISO TURNING – EXTERNAL

SHORT AND STABLE COMPONENTS (negative inserts)

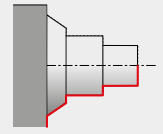

DSDNN EXT 45° 		SN.. 12 15 19 25 20×20 40×40 315 300–312
PSDNN EXT 45° 		SN.. 12 15 19 25 20×20 50×50 320 300–312
DSKN(RL) EXT 75° 		SN.. 12 19 25×25 32×32 316 300–312
PSKN(RL) EXT 75° 		SN.. 12 15 19 25 20×20 50×50 321 300–312
DSSN(RL) EXT 45° 		SN.. 12 15 19 20×20 40×40 317 300–312
PSSN(RL) EXT 45° 		SN.. 12 15 19 25 20×20 50×50 323 300–312
DTFN(RL) EXT 90° 		TN.. 16 22 20×20 25×25 345 334–344
PTFN(RL) EXT 90° 		TN.. 16 22 27 16×16 40×40 348 334–344
DTGN(RL) EXT 90° 		TN.. 16 22 20×20 32×25 346 334–344
PTGN(RL) EXT 90° 		TN.. 16 22 27 16×16 40×40 349 334–344
MTJN(RL) EXT 93° 		TN.. 16 22 16×16 32×32 347 334–344
PTTN(RL) EXT 60° 		TN.. 16 22 20×20 32×25 350 334–344
DVJN(RL) EXT 93° 		VN.. 16 20×20 32×25 360 356–376
MVJN(RL) EXT 93° 		VN.. 16 20×20 32×25 362 356–376
DVPN(RL) EXT 62°30' 		VN.. 16 20×20 32×25 361 356–376
DWLN(RL) EXT 95° 		WN.. 06 08 10 13 16×16 40×40 377 366–376

ISO TURNING – EXTERNAL

SHORT AND STABLE COMPONENTS (negative inserts)

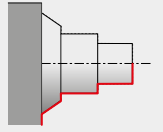

MWLN(RL) EXT

95°	WN..
	 08
	25×25 40×40
	379
	366 – 376

PWLN(RL) EXT

95°	WN..
	 06 08
	16×16 32×25
	380
	366 – 376

C.-DCLN(RL) EXT

95°	CN..
	 12 16 19
	C3 C8
	249
	222 – 239

C.-DDJN(RL) EXT

93°	DN..
	 11 15
	C4 C6
	277
	260 – 272

C.-DDNNN EXT

62.5°	DN..
	 15
	C5 C6
	278
	260 – 272

C.-DDUN(RL) EXT

93°	DN..
	 15
	C5 C6
	279
	260 – 272

C.-DRSN(RL) EXT

	RN..
	 12
	C6
	297
	294

C.-DSRN(RL) EXT

75°	SN..
	 12 19
	C4 C6
	326
	300 – 312

C.-DSDNN EXT

45°	SN..
	 12 19
	C4 C6
	324
	300 – 312

C.-DSKN(RL) EXT

75°	SN..
	 12
	C4
	325
	300 – 312

C.-DSSN(RL) EXT

45°	SN..
	 12
	C4 C5
	327
	300 – 312

C.-DTJN(RL) EXT

93°	TN..
	 16
	C4 C5
	351
	334 – 344

C.-DVJN(RL) EXT

93°	VN..
	 16
	C4 C6
	363
	356 – 376

C.-DWLN(RL) EXT

95°	WN..
	 06 08
	C4 C6
	381
	366 – 376

ISO TURNING – INTERNAL

SHORT AND STABLE COMPONENTS (negative inserts)

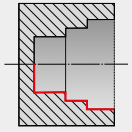

DCLN(RL) INT	
95°	CN..
	 09 12
254	222 – 239

PCLN(RL) INT	
95°	CN..
	 09 12 16 19
255	222 – 239

DDUN(RL) INT	
93°	DN..
	 11 15
280	260 – 272

PDUN(RL) INT	
93°	DN..
	 11 15
281	260 – 272

PSKN(RL) INT	
93°	SN..
	 11 15
331	300 – 312

DTFN(RL) INT	
90°	TN..
	 16 22
352	334 – 344

PTFN(RL) INT	
90°	TN..
	 16 22
353	334 – 344

DVUN(RL) INT	
	VN..
	 16
364	356 – 376

DWLN(RL) INT	
95°	WN..
	 06 08
382	366 – 376

PWLN(RL) INT	
95°	WN..
	 06 08
383	366 – 376

C.-DCLN(RL) INT	
95°	CN..
	 09 12 16
257	222 – 239

C.-DDUN(RL) INT	
93°	DN..
	 11
282	260 – 272

C.-DTFN(RL) INT	
91°	TN..
	 16
354	334 – 344

C.-DWLN(RL) INT	
95°	WN..
	 06 08
385	366 – 376

ISO TURNING – HEAVY ROUGHING – EXTERNAL
FIXED TOOL HOLDERS

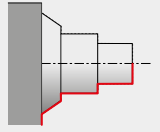

<p>DCBN(RL) EXT</p> <p>75°</p> <p>CN..</p> <p>19</p> <p>40×40</p> <p>240</p> <p>222 – 239</p>	<p>PCBN(RL) EXT</p> <p>75°</p> <p>CN..</p> <p>19</p> <p>25</p> <p>40×40</p> <p>50×50</p> <p>245</p> <p>222 – 239</p>	<p>PCKN(RL) EXT</p> <p>75°</p> <p>CN..</p> <p>19</p> <p>40×40</p> <p>246</p> <p>222 – 239</p>	<p>DCLN(RL) EXT</p> <p>95°</p> <p>CN..</p> <p>19</p> <p>40×40</p> <p>243</p> <p>222 – 239</p>
<p>PCLN(RL) EXT</p> <p>95°</p> <p>CN..</p> <p>19</p> <p>25</p> <p>40×40</p> <p>50×50</p> <p>247</p> <p>222 – 239</p>	<p>PLBN(RL) EXT</p> <p>75°</p> <p>LN..</p> <p>40</p> <p>50</p> <p>60×60</p> <p>290</p> <p>289</p>	<p>PRDCN EXT</p> <p>RC..</p> <p>20</p> <p>25</p> <p>32</p> <p>40×40</p> <p>50×50</p> <p>124</p> <p>118 – 123</p>	<p>PRSC(RL) EXT</p> <p>RC..</p> <p>16</p> <p>25</p> <p>40×40</p> <p>125</p> <p>118 – 123</p>
<p>PRSN(RL) EXT</p> <p>RN..</p> <p>19</p> <p>40×40</p> <p>296</p> <p>294</p>	<p>DSBN(RL) EXT</p> <p>75°</p> <p>SN..</p> <p>19</p> <p>40×40</p> <p>313</p> <p>300 – 312</p>	<p>PSBN(RL) EXT</p> <p>75°</p> <p>SN..</p> <p>19</p> <p>25</p> <p>40×40</p> <p>50×50</p> <p>318</p> <p>300 – 312</p>	<p>DSDNN EXT</p> <p>45°</p> <p>SN..</p> <p>19</p> <p>25</p> <p>40×40</p> <p>315</p> <p>300 – 312</p>
<p>PSDNN EXT</p> <p>45°</p> <p>SN..</p> <p>19</p> <p>25</p> <p>40×40</p> <p>50×50</p> <p>320</p> <p>300 – 312</p>	<p>PSKN(RL) EXT</p> <p>75°</p> <p>SN..</p> <p>19</p> <p>25</p> <p>40×40</p> <p>50×50</p> <p>321</p> <p>300 – 312</p>	<p>DSSN(RL) EXT</p> <p>45°</p> <p>SN..</p> <p>19</p> <p>40×40</p> <p>317</p> <p>300 – 312</p>	<p>PSSN(RL) EXT</p> <p>45°</p> <p>SN..</p> <p>19</p> <p>25</p> <p>40×40</p> <p>50×50</p> <p>323</p> <p>300 – 312</p>



ISO TURNING – HEAVY ROUGHING – EXTERNAL
FIXED TOOL HOLDERS

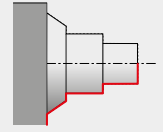

SSBC(RL) EXT	
75°	SC..
	25 38
	40x40 60x60
139	134 – 138

DWLN(RL) EXT	
95°	WN..
	13
	40x40
377	366 – 376

ISO TURNING – HEAVY ROUGHING – EXTERNAL HEAD (KH)

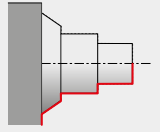

KHP-CBNR + DKH(RL)

75°

CN..

25

DKHR+KHP-CBNR

	40×50 60×80
--	----------------

251, 253 222 – 239

KHP-CBNL + DKH(RL)

75°

CN..

25

DKHR+KHP-CBNL

	40×50 60×80
--	----------------

251, 253 222 – 239

KHP-CLNR/L + DKH(RL)

95°

CN..

19
25

DKHR+KHP-CLNR

	40×50 60×80
--	----------------

252, 253 222 – 239

KHP-LBNR + DKH(RL)

75°

LN..

40

DKHR+KHP-LBNR

	40×50 60×80
--	----------------

291, 292 289

KHP-LBNL + DKH(RL)

75°

LN..

40

DKHR+KHP-LBNL

	40×50 60×80
--	----------------

291, 292 289

KHP-RSCR/L + DKH(RL)

RC..

20
25
32

DKHR+KHP-RSCR

	40×50 60×80
--	----------------

131, 132 118 – 123

KHP-SBNR + DKH(RL)

75°

SN..

25

DKHR+KHP-SBNR

	40×50 60×80
--	----------------

328, 330 300 – 312

KHP-SBNL + DKH(RL)

75°

SN..

25

DKHR+KHP-SBNL

	40×50 60×80
--	----------------

328, 330 300 – 312

KHP-SSNR/L + DKH(RL)

45°

SN..

19
25

DKHR+KHP-SSNR

	40×50 60×80
--	----------------

329, 330 300 – 312

KHS-SBCR + DKH(RL)

75°

SC..

25
38

DKHR+KHS-SBC

	40×50 60×80
--	----------------

142, 143 134 – 138

KHS-SBCL + DKH(RL)

75°

SC..

25
38

DKHR+KHS-SBCL





	40×50 60×80
--	----------------



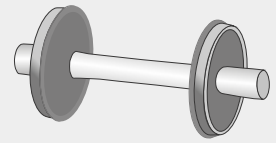

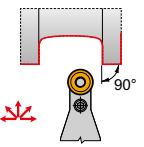
142, 143 134 – 138



ISO TURNING – HEAVY ROUGHING – EXTERNAL
RAILWAY WHEEL MACHINING

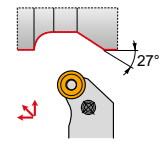

PRDCN EXT	
	RC..  20 25 32
 32×25 50×50	
 124	 118 – 123

PRSC(RL) EXT	
	RC..  20 25
 32×25 40×40	
 125	 118 – 123



DORMER PRAMET

FOLLOW US



SHARE



LIKE



COMMENT



TAG



RE-TWEET





INSERTS – ISO CODE DESIGNATION

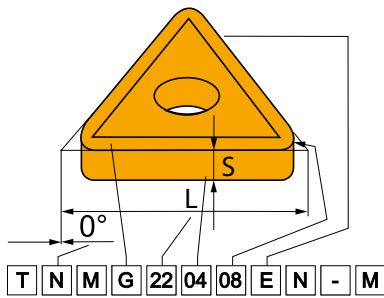

ISO	1	2	3	4
	T	N	U	N
ANSI	1	2	3	4
	T	N	U	G

1				2		4	
Insert shape				Insert clearance angle		Insert type	
H	O	P	R	A	B	N	
						R	
S	T	C	D	C	D	F	
						A	
E	M	V	W	E	F	M	
						G	
L	A	B	K	G	N	W	
						T	
				P	O	Q	
					Special	U	
						B	
						H	
						C	
						J	
						X	Special

3							3		
Tolerances									
	[mm]			["]					
	M (±)	S (±)	IC (±)	M (±)	S (±)	IC (±)			
A	0.005	0.025	0.025	.0002"	.001"	.0010"			
F	0.005	0.025	0.013	.0002"	.001"	.0005"			
C	0.013	0.025	0.025	.0005"	.001"	.0010"			
H	0.013	0.025	0.013	.0005"	.001"	.0005"			
E	0.025	0.025	0.025	.0010"	.001"	.0010"			
G	0.025	0.130	0.025	.0010"	.005"	.0010"			
J	0.005	0.025	0.05 – 0.13	.0002"	.001"	.002 – 0.005"			
K	0.013	0.025	0.05 – 0.13	.0005"	.001"	.002 – 0.005"			
L	0.025	0.025	0.05 – 0.13	.0010"	.001"	.002 – 0.005"			
M	0.08 – 0.18	0.130	0.05 – 0.13	.003 – 0.007"	.005"	.002 – 0.005"			
N	0.08 – 0.18	0.025	0.05 – 0.13	.003 – 0.007"	.001"	.002 – 0.005"			
U	0.05 – 0.38	0.130	0.05 – 0.13	.005 – 0.015"	.005"	.003 – 0.010"			

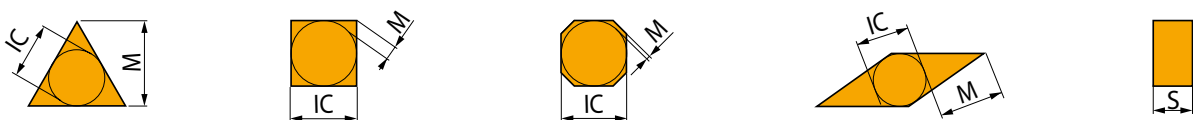

INSERTS – ISO CODE DESIGNATION

5	6	7	8	9	10
22	04	08			
22	04	08	E	N	-
5	6	7	8	9	10
4	3	2			
4	3	2	E	N	-
					M

5		5												
Insert cutting edge length (insert size)														
d = IC		H	O	P	S	T	C	D	E	M	V	W	R	K
[mm]	[in]													
3.97	5/32"				03	06		04			06	02		
4.76	3/16"				04	08	04	05	04	04	08	L3		
5.56	7/32"				05	09	05	06	05	05	09	03		
6.35	1/4"	03	02	04	08	11	06	07	08	08	11	04	06	
7.94	5/16"	04	03	05	07	13	08	09	06	07	13	05	07	
9.525	3/8"	05	04	07	09	16	09	11	09	09	16	06	09	16
12.7	1/2"	07	05	09	12	22	12	15	13	12	22	08	12	
15.875	5/8"	09	06	11	15	27	16	19	16	15	27	10	15	
19.05	3/4"	11	07	13	19	33	19	23	19	19	33	13	19	
25.40	1"	14	10	18	25	44	25	31	26	25	44	17	25	
31.75	1 1/4"	18	13	23	31	54	32	38	32	31	54	21	31	

6		7	
Insert thickness		Insert nose radius	
	S		RE
	[mm]	[mm]	["]
01	1.59	0	0"
T1	1.98	0.2	1/128"
02	2.38	0.4	1/64"
03	3.18	0.8	1/32"
T3	3.97	1.2	3/64"
04	4.76	1.6	1/16"
05	5.56	2.4	3/32"
06	6.35	3.2	1/8"
07	7.94		
09	9.52		

7		8	
Insert cutting edge design		Insert cutting edge design	
		Sharp edges	Rounded edges
		Edges with facet	Rounded edges with facet
		Edges with double facet	Rounded edges with double facet

9		9	
Feed direction			
R		N	
L			

10		10	
Chip breaker designation			

ANSI					
5		6		7	
Inscribed circle		Insert thickness		Insert nose radius	
Symbol		Symbol		Symbol	
d = I.C.		S		RE	
	[mm]	[mm]	["]	[mm]	["]
1	3.175	1	1.588	0	0
1.2	3.969	1.2	1.984	0.099	1/256"
1.5	4.763	1.5	2.381	0.198	1/128"
1.8	5.556	2	3.175	0.397	1/64"
2	6.350	2.5	3.969	0.794	1/32"
2.5	7.938	3	4.763	1.191	3/64"
3	9.525	3.5	5.556	1.588	1/16"
4	12.700	4	6.350	1.984	5/64"
5	15.875	5	7.938	2.381	3/32"
6	19.050	6	9.525	3.175	1/8"
7	22.225	7	11.113	3.969	5/32"
8	25.400	8	12.700	4.763	3/16"
10	31.750	9	14.288	5.556	7/32"
12	38.100	10	15.875	6.350	1/4"

8		8	
Insert cutting edge design			
	Sharp edges		Rounded edges
	Edges with facet		Rounded edges with facet
	Edges with double facet		Rounded edges with double facet

9		9	
Feed direction			
R		N	
L			

10		10	
Chip breaker designation			



EXTERNAL TURNING TOOLS – ISO CODE DESIGNATION

Shank tool	ISO	2	3	4	5	6	7	8	11	12	13
		P	C	L	N	R	- 32	25	L	12	- M
PSC	ISO	1	2	3	4	5	6	9	10	12	
		C4	- D	C	L	N	R	- 27	050	- 12	
Shank tool	ANSI	2	3	4	5	6	7 & 8	12	11		
		D	C	L	N	R	- 16	4	D		

1		2		3				4							
Coupling size		Clamping designation		Insert shape				Holder style – cutting edge angle							
	C														
	C3	32													
	C4	40													
	C5	50													
	C6	63													
	C8	80													

5		6			
Insert clearance angle		Direction of cut			
N	B	C	P		
0°	5°	7°	11°		

7		8	
Shank height [mm]		Shank width [mm]	
08	10	12	16
20	25	32	38
40	45	50	60

7 & 8		
Shank width & Shank height ["]		
Symbol	B ["]	H ["]
05	5/16"	5/16"
06	3/8"	3/8"
08	1/2"	1/2"
10	5/8"	5/8"
12	3/4"	3/4"
16	1"	1"
85	1"	1 1/4"
86	1"	1 1/2"
20	1 1/4"	1 1/4"
24	1 1/2"	1 1/2"
32	2"	2"

11		11	
Holder total length		Holder total length	
	LF [mm]		
D	60	A	4.000"
E	70	B	4.500"
F	80	C	5.000"
H	100	D	6.000"
J	110	E	7.000"
K	125	F	8.000"
L	140	M	4.000"
M	150	N	4.500"
N	160	P	6.000"
P	170	Q	7.000"
Q	180	R	8.000"
R	200	S	4.000"
S	250	T	4.500"
T	300	U	6.000"
U	350	V	7.000"
V	400	W	8.000"
W	450	X	Spec.
X	Spec.	Y	500
Y	500		

For square shanks, the number is the width or height in terms of 16ths. For rectangular shanks the first digit is the width in terms of 8ths and the second digit is the height in terms of 4ths.

9		10	
Functional width [mm]		Functional length [mm]	



INTERNAL TURNING TOOLS – ISO CODE DESIGNATION

ISO	15	16	17	-	2	3	4	5	6	12	-	14
ANSI	A	16	T	-	D	C	L	N	L	4		

12		12												
Insert cutting edge length (insert size)														
d=I.C.		H	O	P	S	T	C	D	E	M	V	W	R	K
[mm]	["]													
3.97					03	06		04			06	02		
	5/32"					1.2								
4.76					04	08	04	05	04	04	08	L3		
	3/16"					1.5								
5.56					05	09	05	06	05	05	09	03		
	7/32"					1.8								
6.35		03	02	04	08	11	06	07	08	08	11	04	06	
	1/4"					2								
7.94		04	03	05	07	13	08	09	06	07	13	05	07	
	5/16"					2.5								
9.525		05	04	07	09	16	09	11	09	09	16	06	09	16
	3/8"					3								
12.7		07	05	09	12	22	12	15	13	12	22	08	12	
	1/2"					4								
15.875		09	06	11	15	27	16	19	16	15	27	10	15	
	5/8"					5								
19.05		11	07	13	19	33	19	23	19	19	33	13	19	
	3/4"					6								
25.40		14	10	18	25	44	25	31	26	25	44	17	25	
	1"					8								
31.75		18	13	23	31	54	32	38	32	31	54	21	31	
	1 1/4"					10								

13	
Manufacturer's designation	
M	Clamping system "S" with shim

14	
Manufacturer's designation	
X	Special shank style
•	
•	
93	Z – style tool setting angle
•	
•	

15		15
Shank		
S	Steel shank	
A	Steel shank with coolant hole	
E	Tungsten carbide shank with coolant hole	

16		16	
Shank Ø [mm]			
DCON MS [mm]		DCON MS ["]	
08	8	03	.1875"
10	10	04	.250"
12	12	05	.3125"
16	16	06	.375"
20	20	08	.500"
25	25	10	.625"
32	32	12	.750"
40	40	16	1.000"
50	50	20	1.250"
60	60	24	1.500"
		32	2.000"

17		17	
Holder total Length			
		LF [mm]	
		D	60
		E	70
		F	80
		H	100
		J	110
		K	125
		L	140
		M	150
		N	160
		P	170
		Q	180
		R	200
		S	250
		T	300
		U	350
		V	400
		W	450
		X	Spec.
		Y	500



HEADS – ISO CODE DESIGNATION

CARTRIDGE

1	2		3	4	5	6	7
KH	P	-	C	L	N	R	25

HOLDER

8	6	9	10	11
DKH	R	50	60	W

1	2	3	4
Cartridge	Clamping designation	Insert shape	Holder style – cutting edge angle
5 Insert clearance angle	C	S	A
	D	C	B
N 0°	P	T	C
C 7°	M	D	D
P 11°	S	R	D
6 Direction of cut	X	K	E
R	S	W	F
L	X	V	G
N	G	L	H
		X Special	J
			K
			L
			M
			N
			P
			Q
			R
			S
			S
			T
			U
			V
			W
			X Special
			Y
			Z

7		Insert cutting edge length (insert size)												
d = I.C.		H	O	P	S	T	C	D	E	M	V	W	R	K
[mm]	["]													
3.97	5/32"				03	06					06	02		
4.76	3/16"				04	08	04	05	04	04	08	L3		
5.56	7/32"				05	09	05	06	05	05	09	03		
6.35	1/4"	03	02	04	08	11	06	07	08	08	11	04	06	
7.94	5/16"	04	03	05	07	13	08	09	06	07	13	05	07	
9.525	3/8"	05	04	07	09	16	09	11	09	09	16	06	09	16
12.7	1/2"	07	05	09	12	22	12	15	13	12	22	08	12	
15.875	5/8"	09	06	11	15	27	16	19	16	15	27	10	15	
19.05	3/4"	11	07	13	19	33	19	23	19	19	33	13	19	
25.40	1"	14	10	18	25	44	25	31	26	25	44	17	25	
31.75	1 1/4"	18	13	23	31	54	32	38	32	31	54	21	31	

8
Cartridge holder

9
Shank height [mm]

08	10	12	16	20	25
32	40	50	60	70	80

10
Shank width [mm]

08	10	12	16	20	25
32	40	50	60	70	80

11
Holder total length

	LF [mm]
H	100
J	110
K	125
L	140
M	150
N	160
P	170
Q	180
R	200
S	250
T	300
U	350
V	400
W	450
X	Spec.
Y	500

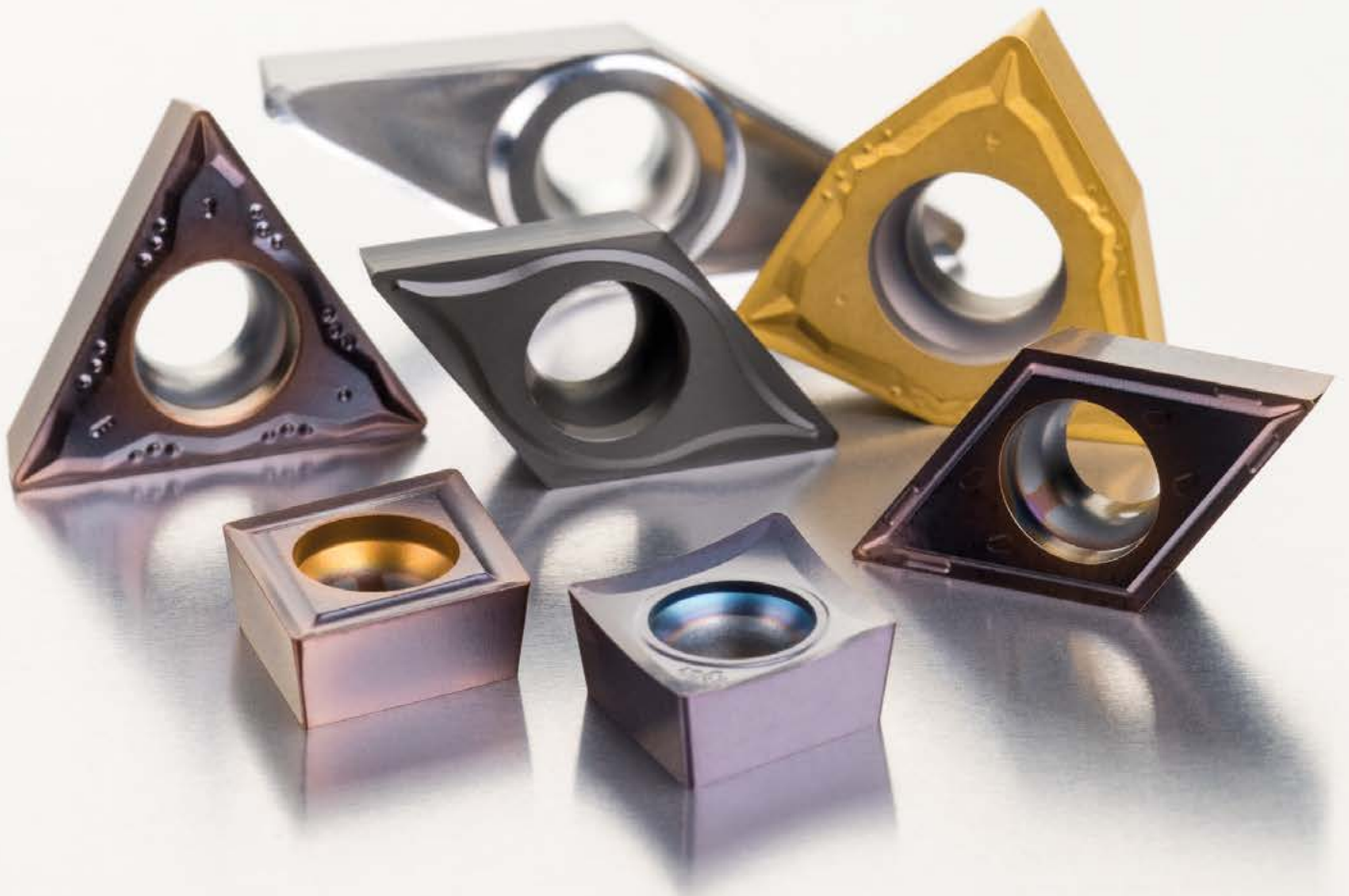

POSITIVE INSERTS



CC

06 / 08 / 09 / 12

CARBIDE INSERTS

CCGT



60

CCMT



62

CCMW



68

CBN INSERTS

CCGW CBN



69

MATCH THE RIGHT SIZE (example)

Insert	Tool Holder
CCMT 120404E-UR	S32U-SCKCR 12-A

ISO TURNING – EXTERNAL

SCAC(RL) EXT

90°

CC..

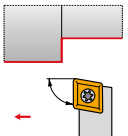

06
09

$\frac{08 \times 08}{16 \times 16}$

70 60 – 69

SCBC(RL) EXT

75°

CC..

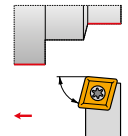

09
12

$\frac{12 \times 12}{25 \times 25}$

71 60 – 69

SCDCR EXT

45°

CC..

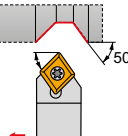

06

10×10

72 60 – 69

SCFC(RL) EXT

90°

CC..

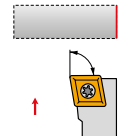

06
09

$\frac{08 \times 08}{16 \times 16}$

73 60 – 69

SCLC(RL) EXT

95°

CC..

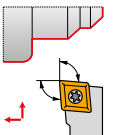

06
08
09
12

$\frac{08 \times 08}{25 \times 25}$

74 60 – 69

C.-SCLC(RL) EXT

95°

CC..

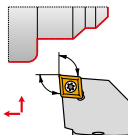

09
12

$\frac{C3}{C5}$

75 60 – 69



CC

06 / 08 / 09 / 12

ISO TURNING – INTERNAL

SCFC(RL) INT

90°

CC..

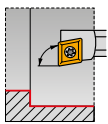

06

 $\frac{13}{16}$

76

60 – 69

SCKC(RL) INT

75°

CC..

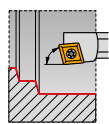
06
09
12
 $\frac{11}{40}$

77

60 – 69

SCLC(RL) INT

95°

CC..

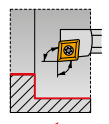
06
09
12
 $\frac{11}{40}$

78

60 – 69

SCXC(RL) INT

40°

CC..

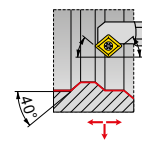

06

 $\frac{13}{20}$

80

60 – 69

C.-SCLC(RL) INT

95°

CC..

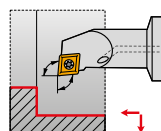

09

 $\frac{20}{32}$

81

60 – 69



CCGT



	IC	D1	L	S
	[mm]	[mm]	[mm]	[mm]
0602	6.350	2.80	6.40	2.38
0602-SF3	6.350	2.80	6.40	2.58
0803-AL	7.940	3.40	8.10	3.43
0803-SF3	7.940	3.40	8.10	3.43
09T3	9.525	4.40	9.70	3.97
09T3-SF3	9.525	4.40	9.70	4.22
1204	12.700	5.50	12.90	4.76
1204-SF3	12.700	5.50	12.90	5.01

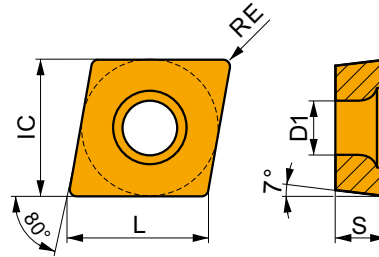

Suitability and starting values for cutting speed (vc), feed (f) and depth of cut (ap). Refer to our Machining Calculator app for further calculations.

Product	RE	P			M			K			N			S			H		
		vc	f	ap	vc	f	ap	vc	f	ap	vc	f	ap	vc	f	ap	vc	f	ap
	[mm]	[m/min]	[mm/rev]	[mm]	[m/min]	[mm/rev]	[mm]	[m/min]	[mm/rev]	[mm]	[m/min]	[mm/rev]	[mm]	[m/min]	[mm/rev]	[mm]	[m/min]	[mm/rev]	[mm]



AL geometry with highly positive design for fine-finish to rough machining, continuous to slightly interrupted cuts.

CCGT 060202F-AL	HF7	0.2	-	-	-	-	-	-	-	450	0.12	1.0	-	-	-	-	-	-
	T0315	0.2	-	-	-	-	-	-	-	645	0.12	1.0	-	-	-	-	-	-
CCGT 060204F-AL	HF7	0.4	-	-	-	-	-	-	-	360	0.24	1.0	-	-	-	-	-	-
	T0315	0.4	-	-	-	-	-	-	-	525	0.24	1.0	-	-	-	-	-	-
CCGT 080302F-AL	T0315	0.2	-	-	-	-	-	-	-	645	0.12	1.0	-	-	-	-	-	-
CCGT 080304F-AL	HF7	0.4	-	-	-	-	-	-	-	360	0.24	1.0	-	-	-	-	-	-
	T0315	0.4	-	-	-	-	-	-	-	525	0.24	1.0	-	-	-	-	-	-
CCGT 09T302F-AL	HF7	0.2	-	-	-	-	-	-	-	450	0.12	1.0	-	-	-	-	-	-
	T0315	0.2	-	-	-	-	-	-	-	645	0.12	1.0	-	-	-	-	-	-
CCGT 09T304F-AL	HF7	0.4	-	-	-	-	-	-	-	345	0.24	1.5	-	-	-	-	-	-
	T0315	0.4	-	-	-	-	-	-	-	495	0.24	1.5	-	-	-	-	-	-
CCGT 09T308F-AL	HF7	0.8	-	-	-	-	-	-	-	315	0.48	1.5	-	-	-	-	-	-
	T0315	0.8	-	-	-	-	-	-	-	450	0.48	1.5	-	-	-	-	-	-
CCGT 120404F-AL	HF7	0.4	-	-	-	-	-	-	-	330	0.24	2.4	-	-	-	-	-	-
	T0315	0.4	-	-	-	-	-	-	-	480	0.24	2.4	-	-	-	-	-	-
CCGT 120408F-AL	HF7	0.8	-	-	-	-	-	-	-	300	0.48	2.4	-	-	-	-	-	-
	T0315	0.8	-	-	-	-	-	-	-	435	0.48	2.4	-	-	-	-	-	-

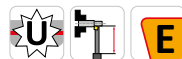
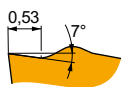

FF2 geometry with positive design for fine-finish to finish machining, continuous to slightly interrupted cuts.

CCGT 09T302E-FF2	T7325	0.2	235	0.05	1.0	-	-	-	-	-	-	-	-	-	-	-	-	-
	T9325	0.2	345	0.05	1.0	-	-	-	325	0.05	1.0	-	-	-	-	-	-	-

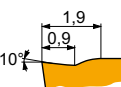

NF1 geometry with positive design for fine-finish to medium machining and continuous cuts.

CCGT 060204E-NF1	H07	0.4	-	-	-	95	0.09	0.8	-	-	-	485	0.12	0.8	45	0.07	0.6	-	-	-
	T6310	0.4	180	0.10	0.8	125	0.09	0.8	-	-	-	540	0.12	0.8	50	0.07	0.6	35	0.15	1.0
	T7325	0.4	210	0.10	0.8	160	0.09	0.8	-	-	-	-	-	-	65	0.07	0.6	-	-	-
CCGT 060208E-NF1	T6310	0.8	205	0.12	0.8	145	0.11	0.8	-	-	-	615	0.14	0.8	60	0.11	0.6	40	0.15	1.0
	T7325	0.8	235	0.12	0.8	180	0.11	0.8	-	-	-	-	-	-	75	0.11	0.6	-	-	-
CCGT 09T304E-NF1	H07	0.4	-	-	-	90	0.09	1.2	-	-	-	470	0.12	1.2	45	0.07	1.0	-	-	-
	T6310	0.4	175	0.10	1.2	125	0.09	1.2	-	-	-	525	0.12	1.2	50	0.07	1.0	35	0.15	1.0
	T7325	0.4	200	0.10	1.2	155	0.09	1.2	-	-	-	-	-	-	65	0.07	1.0	-	-	-
CCGT 09T308E-NF1	T6310	0.8	190	0.14	1.2	135	0.13	1.2	-	-	-	570	0.17	1.2	55	0.13	1.0	35	0.15	1.0
	T7325	0.8	215	0.14	1.2	165	0.13	1.2	-	-	-	-	-	-	65	0.13	1.0	-	-	-



Suitability and starting values for cutting speed (vc), feed (f) and depth of cut (ap). Refer to our Machining Calculator app for further calculations.

Product	RE [mm]	P			M			K			N			S			H		
		vc	f	ap	vc	f	ap	vc	f	ap	vc	f	ap	vc	f	ap	vc	f	ap
		[m/min]	[mm/rev]	[mm]	[m/min]	[mm/rev]	[mm]	[m/min]	[mm/rev]	[mm]	[m/min]	[mm/rev]	[mm]	[m/min]	[mm/rev]	[mm]	[m/min]	[mm/rev]	[mm]

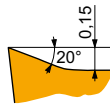

SF3 geometry with highly positive design for fine to finish machining, and continuous cuts.

CCGT 060201E-SF3	T6310	0.1	200	0.05	0.5	140	0.05	0.5	160	0.05	0.5	600	0.06	0.5	60	0.04	0.4	40	0.15	1.0
CCGT 060202E-SF3	H07	0.2	-	-	-	120	0.05	0.8	190	0.05	0.8	605	0.06	0.8	60	0.04	0.6	-	-	-
	T6310	0.2	205	0.05	0.8	145	0.05	0.8	165	0.05	0.8	615	0.06	0.8	60	0.04	0.6	40	0.15	1.0
	T8315	0.2	215	0.05	0.8	125	0.05	0.8	200	0.05	0.8	645	0.06	0.8	50	0.04	0.6	40	0.15	1.0
CCGT 060204E-SF3	H07	0.4	-	-	-	95	0.09	0.8	150	0.10	0.8	485	0.12	0.8	45	0.07	0.6	-	-	-
	T6310	0.4	180	0.10	0.8	125	0.09	0.8	145	0.10	0.8	540	0.12	0.8	50	0.07	0.6	35	0.15	1.0
	T8315	0.4	190	0.10	0.8	110	0.09	0.8	180	0.10	0.8	570	0.12	0.8	45	0.07	0.6	35	0.15	1.0
CCGT 080302E-SF3	T6310	0.2	205	0.05	0.8	145	0.05	0.8	165	0.05	0.8	615	0.06	0.8	60	0.04	0.6	40	0.15	1.0
	T8315	0.2	215	0.05	0.8	125	0.05	0.8	200	0.05	0.8	645	0.06	0.8	50	0.04	0.6	40	0.15	1.0
CCGT 080304E-SF3	H07	0.4	-	-	-	95	0.09	1.0	150	0.10	1.0	485	0.12	1.0	45	0.07	0.8	-	-	-
	T6310	0.4	180	0.10	1.0	125	0.09	1.0	145	0.10	1.0	540	0.12	1.0	50	0.07	0.8	35	0.15	1.0
	T8315	0.4	190	0.10	1.0	110	0.09	1.0	180	0.10	1.0	570	0.12	1.0	45	0.07	0.8	35	0.15	1.0
CCGT 09T301E-SF3	T6310	0.1	200	0.05	0.5	140	0.05	0.5	160	0.05	0.5	600	0.06	0.5	60	0.04	0.4	40	0.15	1.0
CCGT 09T302E-SF3	H07	0.2	-	-	-	120	0.05	0.8	190	0.05	0.8	605	0.06	0.8	60	0.04	0.6	-	-	-
	T6310	0.2	205	0.05	0.8	145	0.05	0.8	165	0.05	0.8	615	0.06	0.8	60	0.04	0.6	40	0.15	1.0
	T8315	0.2	215	0.05	0.8	125	0.05	0.8	200	0.05	0.8	645	0.06	0.8	50	0.04	0.6	40	0.15	1.0
CCGT 09T304E-SF3	H07	0.4	-	-	-	95	0.09	1.0	150	0.10	1.0	485	0.12	1.0	45	0.07	0.8	-	-	-
	T6310	0.4	180	0.10	1.0	125	0.09	1.0	145	0.10	1.0	540	0.12	1.0	50	0.07	0.8	35	0.15	1.0
	T8315	0.4	190	0.10	1.0	110	0.09	1.0	180	0.10	1.0	570	0.12	1.0	45	0.07	0.8	35	0.15	1.0
CCGT 09T308E-SF3	H07	0.8	-	-	-	110	0.09	1.0	175	0.10	1.0	565	0.12	1.0	55	0.08	0.8	-	-	-
	T6310	0.8	210	0.10	1.0	150	0.09	1.0	165	0.10	1.0	630	0.12	1.0	60	0.08	0.8	40	0.15	1.0
	T8315	0.8	225	0.10	1.0	135	0.09	1.0	210	0.10	1.0	675	0.12	1.0	55	0.08	0.8	45	0.15	1.0
CCGT 120404E-SF3	T6310	0.4	180	0.10	1.0	125	0.09	1.0	145	0.10	1.0	540	0.12	1.0	50	0.07	0.8	35	0.15	1.0
CCGT 120408E-SF3	H07	0.8	-	-	-	105	0.12	1.0	165	0.12	1.0	525	0.14	1.0	50	0.11	0.8	-	-	-
	T6310	0.8	200	0.12	1.0	140	0.12	1.0	160	0.12	1.0	600	0.14	1.0	60	0.11	0.8	40	0.15	1.0
	T8315	0.8	210	0.12	1.0	125	0.12	1.0	195	0.12	1.0	630	0.14	1.0	50	0.11	0.8	40	0.15	1.0

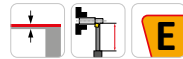

ER-SI geometry with positive right-handed design for fine-finish machining, and continuous cuts.

CCGT 060202ER-SI	T8330	0.2	215	0.10	0.8	125	0.09	0.8	200	0.10	0.8	-	-	-	50	0.08	0.6	-	-	-
	T8430	0.2	260	0.10	0.8	140	0.09	0.8	215	0.10	0.8	-	-	-	55	0.08	0.6	-	-	-
CCGT 060204ER-SI	T8315	0.4	225	0.12	0.8	135	0.11	0.8	210	0.12	0.8	-	-	-	55	0.10	0.6	-	-	-
	T8330	0.4	215	0.12	0.8	125	0.11	0.8	200	0.12	0.8	-	-	-	50	0.10	0.6	-	-	-
	T8430	0.4	260	0.12	0.8	140	0.11	0.8	215	0.12	0.8	-	-	-	55	0.10	0.6	-	-	-
CCGT 09T304ER-SI	T8315	0.4	205	0.17	0.8	120	0.15	0.8	190	0.17	0.8	-	-	-	50	0.15	0.6	-	-	-
	T8330	0.4	195	0.17	0.8	115	0.15	0.8	185	0.17	0.8	-	-	-	45	0.15	0.6	-	-	-
	T8430	0.4	230	0.17	0.8	125	0.15	0.8	185	0.17	0.8	-	-	-	45	0.15	0.6	-	-	-
CCGT 120408ER-SI	T8330	0.8	205	0.23	1.0	120	0.21	1.0	190	0.23	1.0	-	-	-	50	0.21	0.8	-	-	-
	T8430	0.8	230	0.24	1.0	125	0.22	1.0	185	0.24	1.0	-	-	-	45	0.22	0.8	-	-	-

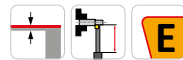

EL-SI geometry with positive left-handed design for fine-finish machining, and continuous cuts.

CCGT 060202EL-SI	T8330	0.2	215	0.10	0.8	125	0.09	0.8	200	0.10	0.8	-	-	-	50	0.08	0.6	-	-	-
	T8430	0.2	260	0.10	0.8	140	0.09	0.8	215	0.10	0.8	-	-	-	55	0.08	0.6	-	-	-
CCGT 060204EL-SI	T8315	0.4	225	0.12	0.8	135	0.11	0.8	210	0.12	0.8	-	-	-	55	0.10	0.6	-	-	-
	T8330	0.4	215	0.12	0.8	125	0.11	0.8	200	0.12	0.8	-	-	-	50	0.10	0.6	-	-	-
	T8430	0.4	260	0.12	0.8	140	0.11	0.8	215	0.12	0.8	-	-	-	55	0.10	0.6	-	-	-
CCGT 09T304EL-SI	T8315	0.4	205	0.17	0.8	120	0.15	0.8	190	0.17	0.8	-	-	-	50	0.15	0.6	-	-	-
	T8330	0.4	195	0.17	0.8	115	0.15	0.8	185	0.17	0.8	-	-	-	45	0.15	0.6	-	-	-
	T8430	0.4	230	0.17	0.8	125	0.15	0.8	185	0.17	0.8	-	-	-	45	0.15	0.6	-	-	-
CCGT 120408EL-SI	T8330	0.8	205	0.23	1.0	120	0.21	1.0	190	0.23	1.0	-	-	-	50	0.21	0.8	-	-	-
	T8430	0.8	230	0.24	1.0	125	0.22	1.0	185	0.24	1.0	-	-	-	45	0.22	0.8	-	-	-



CCMT



	IC	D1	L	S
	[mm]	[mm]	[mm]	[mm]
0602	6.350	2.80	6.40	2.38
0803	7.940	3.40	8.10	3.18
09T3	9.525	4.40	9.70	3.97
1204	12.700	5.50	12.90	4.76

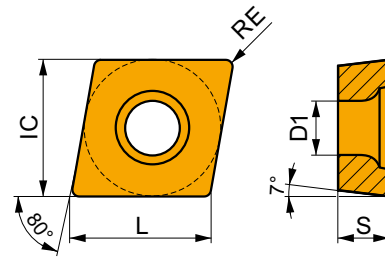

Suitability and starting values for cutting speed (vc), feed (f) and depth of cut (ap). Refer to our Machining Calculator app for further calculations.

Product	RE	P			M			K			N			S			H		
		vc	f	ap	vc	f	ap	vc	f	ap	vc	f	ap	vc	f	ap	vc	f	ap
	[mm]	[m/min]	[mm/rev]	[mm]	[m/min]	[mm/rev]	[mm]	[m/min]	[mm/rev]	[mm]	[m/min]	[mm/rev]	[mm]	[m/min]	[mm/rev]	[mm]	[m/min]	[mm/rev]	[mm]

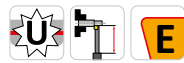
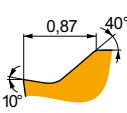

FF geometry with positive design for fine-finish to finish machining, and continuous to slightly interrupted cuts.

CCMT 060202E-FF	T8315	0.2	195	0.10	1.0	115	0.09	1.0	-	-	-	-	-	-	-	-	-	-	-
	T8330	0.2	185	0.10	1.0	110	0.09	1.0	-	-	-	-	-	-	-	-	-	-	-
	T8430	0.2	230	0.10	1.0	125	0.09	1.0	-	-	-	-	-	-	-	-	-	-	-
	T9315	0.2	315	0.10	1.0	-	-	-	-	-	-	-	-	-	-	-	-	-	-
CCMT 060204E-FF	T8315	0.4	195	0.12	1.0	115	0.11	1.0	-	-	-	-	-	-	-	-	-	-	-
	T8330	0.4	185	0.12	1.0	110	0.11	1.0	-	-	-	-	-	-	-	-	-	-	-
	T8430	0.4	225	0.12	1.0	120	0.11	1.0	-	-	-	-	-	-	-	-	-	-	-
	T9315	0.4	310	0.12	1.0	-	-	-	-	-	-	-	-	-	-	-	-	-	-
CCMT 09T304E-FF	T8315	0.4	190	0.12	1.2	110	0.11	1.2	-	-	-	-	-	-	-	-	-	-	-
	T8330	0.4	185	0.12	1.2	110	0.11	1.2	-	-	-	-	-	-	-	-	-	-	-
	T8430	0.4	225	0.12	1.2	120	0.11	1.2	-	-	-	-	-	-	-	-	-	-	-
	T9315	0.4	300	0.12	1.2	-	-	-	-	-	-	-	-	-	-	-	-	-	-

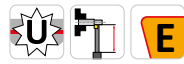
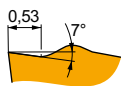

FF2 geometry with positive design for fine-finish to finish machining, and continuous to slightly interrupted cuts.

CCMT 060202E-FF2	T7325	0.2	240	0.05	0.8	-	-	-	-	-	-	-	-	-	-	-	-	-	-
	T8330	0.2	205	0.05	0.8	190	0.05	0.8	-	-	-	-	-	-	-	-	-	-	-
	T8430	0.2	280	0.05	0.8	230	0.05	0.8	-	-	-	-	-	-	-	-	-	-	-
	T9315	0.2	390	0.05	0.8	370	0.05	0.8	-	-	-	-	-	-	-	-	-	-	-
	T9325	0.2	350	0.05	0.8	330	0.05	0.8	-	-	-	-	-	-	-	-	-	-	-
CCMT 060204E-FF2	TT010	0.2	345	0.05	0.5	-	-	-	-	-	-	-	-	-	-	-	-	-	-
	T7325	0.4	190	0.12	1.0	-	-	-	-	-	-	-	-	-	-	-	-	-	-
	T8330	0.4	165	0.12	1.0	155	0.12	1.0	-	-	-	-	-	-	-	-	-	-	-
	T8430	0.4	205	0.12	1.0	170	0.12	1.0	-	-	-	-	-	-	-	-	-	-	-
	T9315	0.4	280	0.12	1.0	265	0.12	1.0	-	-	-	-	-	-	-	-	-	-	-
	T9325	0.4	255	0.12	1.0	240	0.12	1.0	-	-	-	-	-	-	-	-	-	-	-
CCMT 080302E-FF2	TT010	0.4	215	0.12	1.0	-	-	-	-	-	-	-	-	-	-	-	-	-	-
	T7325	0.2	240	0.05	0.8	-	-	-	-	-	-	-	-	-	-	-	-	-	-
	T8330	0.2	205	0.05	0.8	190	0.05	0.8	-	-	-	-	-	-	-	-	-	-	-
	T8430	0.2	280	0.05	0.8	230	0.05	0.8	-	-	-	-	-	-	-	-	-	-	-
	T9325	0.2	350	0.05	0.8	330	0.05	0.8	-	-	-	-	-	-	-	-	-	-	-
CCMT 080304E-FF2	TT010	0.2	345	0.05	0.5	-	-	-	-	-	-	-	-	-	-	-	-	-	-
	T7325	0.4	190	0.12	1.0	-	-	-	-	-	-	-	-	-	-	-	-	-	-
	T8330	0.4	165	0.12	1.0	155	0.12	1.0	-	-	-	-	-	-	-	-	-	-	-
	T8430	0.4	205	0.12	1.0	170	0.12	1.0	-	-	-	-	-	-	-	-	-	-	-
	T9325	0.4	255	0.12	1.0	240	0.12	1.0	-	-	-	-	-	-	-	-	-	-	-
TT010	0.4	350	0.06	0.5	-	-	-	-	-	-	-	-	-	-	-	-	-	-	-



Suitability and starting values for cutting speed (vc), feed (f) and depth of cut (ap). Refer to our Machining Calculator app for further calculations.

Product	RE [mm]	P			M			K			N			S			H		
		vc	f	ap	vc	f	ap	vc	f	ap	vc	f	ap	vc	f	ap	vc	f	ap
		[m/min]	[mm/rev]	[mm]	[m/min]	[mm/rev]	[mm]	[m/min]	[mm/rev]	[mm]	[m/min]	[mm/rev]	[mm]	[m/min]	[mm/rev]	[mm]	[m/min]	[mm/rev]	[mm]

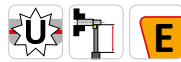
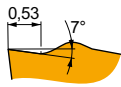

FF2 geometry with positive design for fine-finish to finish machining, and continuous to slightly interrupted cuts.

CCMT 080308E-FF2	T7325	0.8	205	0.17	1.0	-	-	-	-	-	-	-	-	-	-	-	-	-	-
	T8330	0.8	180	0.17	1.0	-	-	-	170	0.17	1.0	-	-	-	-	-	-	-	-
	T8430	0.8	210	0.17	1.0	-	-	-	175	0.17	1.0	-	-	-	-	-	-	-	-
	T9325	0.8	260	0.17	1.0	-	-	-	245	0.17	1.0	-	-	-	-	-	-	-	-
CCMT 09T304E-FF2	T7325	0.4	190	0.12	1.2	-	-	-	-	-	-	-	-	-	-	-	-	-	-
	T8330	0.4	165	0.12	1.2	-	-	-	155	0.12	1.2	-	-	-	-	-	-	-	-
	T8430	0.4	200	0.12	1.2	-	-	-	165	0.12	1.2	-	-	-	-	-	-	-	-
	T9315	0.4	275	0.12	1.2	-	-	-	260	0.12	1.2	-	-	-	-	-	-	-	-
	T9325	0.4	250	0.12	1.2	-	-	-	235	0.12	1.2	-	-	-	-	-	-	-	-
	T9335	0.4	215	0.12	1.2	-	-	-	-	-	-	-	-	-	-	-	-	-	-
CCMT 09T308E-FF2	TT010	0.4	350	0.06	0.5	-	-	-	-	-	-	-	-	-	-	-	-	-	-
	T7325	0.8	205	0.17	1.2	-	-	-	-	-	-	-	-	-	-	-	-	-	-
	T8330	0.8	175	0.17	1.2	-	-	-	165	0.17	1.2	-	-	-	-	-	-	-	-
	T8430	0.8	205	0.17	1.2	-	-	-	170	0.17	1.2	-	-	-	-	-	-	-	-
	T9315	0.8	285	0.17	1.2	-	-	-	270	0.17	1.2	-	-	-	-	-	-	-	-
	T9325	0.8	255	0.17	1.2	-	-	-	240	0.17	1.2	-	-	-	-	-	-	-	-

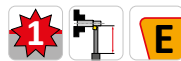

FM geometry for finish to semi-rough machining, and continuous to slightly interrupted cuts.

CCMT 060202E-FM	T7325	0.2	210	0.10	1.0	160	0.09	1.0	-	-	-	-	-	-	-	-	-	-
	T7335	0.2	210	0.10	1.0	160	0.09	1.0	-	-	-	-	-	-	-	-	-	-
	T8315	0.2	195	0.10	1.0	115	0.09	1.0	185	0.10	1.0	585	0.12	1.0	-	-	-	-
	T8330	0.2	185	0.10	1.0	110	0.09	1.0	175	0.10	1.0	555	0.12	1.0	-	-	-	-
	T8430	0.2	230	0.10	1.0	125	0.09	1.0	185	0.10	1.0	630	0.12	1.0	-	-	-	-
	T9315	0.2	315	0.10	1.0	-	-	-	295	0.10	1.0	-	-	-	-	-	-	-
CCMT 060204E-FM	T9325	0.2	285	0.10	1.0	170	0.09	1.0	270	0.10	1.0	-	-	-	-	-	-	-
	T7325	0.4	200	0.15	1.0	155	0.15	1.0	-	-	-	-	-	-	-	-	-	-
	T7335	0.4	195	0.15	1.0	150	0.15	1.0	-	-	-	-	-	-	-	-	-	-
	T8315	0.4	185	0.15	1.0	110	0.14	1.0	175	0.15	1.0	555	0.18	1.0	-	-	-	-
	T8330	0.4	170	0.15	1.0	100	0.14	1.0	160	0.15	1.0	510	0.18	1.0	-	-	-	-
	T8430	0.4	205	0.15	1.0	110	0.14	1.0	170	0.15	1.0	570	0.18	1.0	-	-	-	-
CCMT 060208E-FM	T9315	0.4	285	0.15	1.0	-	-	-	270	0.15	1.0	-	-	-	-	-	-	-
	T9325	0.4	250	0.15	1.0	150	0.15	1.0	235	0.15	1.0	-	-	-	-	-	-	-
	T7325	0.8	220	0.20	1.0	170	0.18	1.0	-	-	-	-	-	-	-	-	-	-
	T8330	0.8	190	0.20	1.0	110	0.18	1.0	180	0.20	1.0	570	0.24	1.0	-	-	-	-
	T8430	0.8	220	0.20	1.0	120	0.18	1.0	180	0.20	1.0	600	0.24	1.0	-	-	-	-
	T9315	0.8	300	0.20	1.0	-	-	-	285	0.20	1.0	-	-	-	-	-	-	-
CCMT 09T302E-FM	T9325	0.8	265	0.20	1.0	155	0.18	1.0	250	0.20	1.0	-	-	-	-	-	-	-
	T7325	0.2	205	0.10	1.2	155	0.09	1.2	-	-	-	-	-	-	-	-	-	-
	T7335	0.2	205	0.10	1.2	155	0.09	1.2	-	-	-	-	-	-	-	-	-	-
	T8315	0.2	190	0.10	1.2	110	0.09	1.2	180	0.10	1.2	570	0.12	1.2	-	-	-	-
	T8330	0.2	180	0.10	1.2	105	0.09	1.2	170	0.10	1.2	540	0.12	1.2	-	-	-	-
	T8430	0.2	225	0.10	1.2	120	0.09	1.2	185	0.10	1.2	615	0.12	1.2	-	-	-	-
CCMT 09T304E-FM	T9315	0.2	310	0.10	1.2	-	-	-	290	0.10	1.2	-	-	-	-	-	-	-
	T9325	0.2	275	0.10	1.2	165	0.09	1.2	260	0.10	1.2	-	-	-	-	-	-	-
	T7325	0.4	195	0.15	1.2	150	0.15	1.2	-	-	-	-	-	-	-	-	-	-
	T7335	0.4	190	0.15	1.2	145	0.15	1.2	-	-	-	-	-	-	-	-	-	-
	T8315	0.4	180	0.15	1.2	105	0.14	1.2	170	0.15	1.2	540	0.18	1.2	-	-	-	-
	T8330	0.4	170	0.15	1.2	100	0.14	1.2	160	0.15	1.2	510	0.18	1.2	-	-	-	-
CCMT 09T304E-FM	T8430	0.4	200	0.15	1.2	110	0.14	1.2	165	0.15	1.2	555	0.18	1.2	-	-	-	-
	T9315	0.4	275	0.15	1.2	-	-	-	260	0.15	1.2	-	-	-	-	-	-	-
	T9325	0.4	245	0.15	1.2	145	0.15	1.2	230	0.15	1.2	-	-	-	-	-	-	-



Suitability and starting values for cutting speed (vc), feed (f) and depth of cut (ap). Refer to our Machining Calculator app for further calculations.

Product	RE (mm)	P			M			K			N			S			H		
		vc (m/min)	f (mm/rev)	ap (mm)	vc (m/min)	f (mm/rev)	ap (mm)	vc (m/min)	f (mm/rev)	ap (mm)	vc (m/min)	f (mm/rev)	ap (mm)	vc (m/min)	f (mm/rev)	ap (mm)	vc (m/min)	f (mm/rev)	ap (mm)

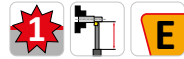
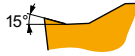

FM geometry for finish to semi-rough machining, and continuous to slightly interrupted cuts.

CCMT 09T308E-FM	T7325	0.8	215	0.20	1.2	165	0.18	1.2	-	-	-	-	-	-	-	-	-	-	
	T7335	0.8	205	0.20	1.2	155	0.18	1.2	-	-	-	-	-	-	-	-	-	-	
	T8315	0.8	195	0.20	1.2	115	0.18	1.2	185	0.20	1.2	585	0.24	1.2	-	-	-	-	
	T8330	0.8	185	0.20	1.2	110	0.18	1.2	175	0.20	1.2	555	0.24	1.2	-	-	-	-	
	T8430	0.8	210	0.20	1.2	115	0.18	1.2	175	0.20	1.2	585	0.24	1.2	-	-	-	-	
	T9315	0.8	290	0.20	1.2	-	-	-	275	0.20	1.2	-	-	-	-	-	-	-	-
	T9325	0.8	260	0.20	1.2	155	0.18	1.2	245	0.20	1.2	-	-	-	-	-	-	-	
CCMT 120404E-FM	T7325	0.4	190	0.15	1.7	145	0.15	1.7	-	-	-	-	-	-	-	-	-	-	
	T7335	0.4	185	0.15	1.7	140	0.15	1.7	-	-	-	-	-	-	-	-	-	-	
	T8315	0.4	170	0.15	1.7	100	0.14	1.7	160	0.15	1.7	510	0.18	1.7	-	-	-	-	
	T8330	0.4	165	0.15	1.7	95	0.14	1.7	155	0.15	1.7	495	0.18	1.7	-	-	-	-	
	T8430	0.4	195	0.15	1.7	105	0.14	1.7	160	0.15	1.7	540	0.18	1.7	-	-	-	-	
	T9315	0.4	265	0.15	1.7	-	-	-	250	0.15	1.7	-	-	-	-	-	-	-	
	T9325	0.4	240	0.15	1.7	140	0.15	1.7	225	0.15	1.7	-	-	-	-	-	-	-	
CCMT 120408E-FM	T7325	0.8	205	0.20	1.7	155	0.18	1.7	-	-	-	-	-	-	-	-	-	-	
	T7335	0.8	200	0.20	1.7	155	0.18	1.7	-	-	-	-	-	-	-	-	-	-	
	T8315	0.8	190	0.20	1.7	110	0.18	1.7	180	0.20	1.7	570	0.24	1.7	-	-	-	-	
	T8330	0.8	180	0.20	1.7	105	0.18	1.7	170	0.20	1.7	540	0.24	1.7	-	-	-	-	
	T8430	0.8	205	0.20	1.7	110	0.18	1.7	170	0.20	1.7	570	0.24	1.7	-	-	-	-	
	T9315	0.8	280	0.20	1.7	-	-	-	265	0.20	1.7	-	-	-	-	-	-	-	
	T9325	0.8	250	0.20	1.7	150	0.18	1.7	235	0.20	1.7	-	-	-	-	-	-	-	
CCMT 120412E-FM	T8330	1.2	175	0.27	1.7	105	0.24	1.7	165	0.27	1.7	525	0.32	1.7	-	-	-	-	
	T8430	1.2	190	0.27	1.7	105	0.24	1.7	155	0.27	1.7	525	0.32	1.7	-	-	-	-	
	T9325	1.2	235	0.27	1.7	140	0.24	1.7	220	0.27	1.7	-	-	-	-	-	-		

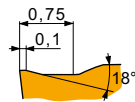

FM2 geometry for finish to medium machining, and continuous to interrupted cuts.

CCMT 080304E-FM2	T8330	0.4	165	0.12	1.0	95	0.11	1.0	155	0.12	1.0	-	-	-	-	-	-
	T8430	0.4	205	0.12	1.0	110	0.11	1.0	170	0.12	1.0	-	-	-	-	-	-
	T9315	0.4	280	0.12	1.0	-	-	-	265	0.12	1.0	-	-	-	-	-	-
	T9325	0.4	255	0.12	1.0	150	0.11	1.0	240	0.12	1.0	-	-	-	-	-	-
	T9335	0.4	215	0.12	1.0	125	0.11	1.0	-	-	-	-	-	-	-	-	-
CCMT 080308E-FM2	T8330	0.8	180	0.17	1.0	105	0.15	1.0	170	0.17	1.0	-	-	-	-	-	-
	T8430	0.8	210	0.17	1.0	115	0.15	1.0	175	0.17	1.0	-	-	-	-	-	-
	T9325	0.8	260	0.17	1.0	155	0.15	1.0	245	0.17	1.0	-	-	-	-	-	-
	T9335	0.8	225	0.17	1.0	135	0.15	1.0	-	-	-	-	-	-	-	-	-
CCMT 09T304E-FM2	T6310	0.4	165	0.12	1.0	115	0.11	1.0	130	0.12	1.0	-	-	-	-	-	-
	T8330	0.4	165	0.12	1.0	95	0.11	1.0	155	0.12	1.0	-	-	-	-	-	-
	T8430	0.4	205	0.12	1.0	110	0.11	1.0	170	0.12	1.0	-	-	-	-	-	-
	T9315	0.4	280	0.12	1.0	-	-	-	265	0.12	1.0	-	-	-	-	-	-
	T9325	0.4	255	0.12	1.0	150	0.11	1.0	240	0.12	1.0	-	-	-	-	-	-
CCMT 09T308E-FM2	T6310	0.8	180	0.17	1.0	125	0.15	1.0	145	0.17	1.0	-	-	-	-	-	-
	T7325	0.8	205	0.17	1.0	155	0.15	1.0	-	-	-	-	-	-	-	-	-
	T8330	0.8	180	0.17	1.0	105	0.15	1.0	170	0.17	1.0	-	-	-	-	-	-
	T8430	0.8	210	0.17	1.0	115	0.15	1.0	175	0.17	1.0	-	-	-	-	-	-
	T9315	0.8	290	0.17	1.0	-	-	-	275	0.17	1.0	-	-	-	-	-	-
	T9325	0.8	260	0.17	1.0	155	0.15	1.0	245	0.17	1.0	-	-	-	-	-	-
CCMT 120408E-FM2	T7325	0.8	190	0.20	1.5	145	0.18	1.5	-	-	-	-	-	-	-	-	-
	T8330	0.8	165	0.20	1.5	95	0.18	1.5	155	0.20	1.5	-	-	-	-	-	-
	T8430	0.8	190	0.20	1.5	105	0.18	1.5	155	0.20	1.5	-	-	-	-	-	-
	T9325	0.8	235	0.20	1.5	140	0.18	1.5	220	0.20	1.5	-	-	-	-	-	-
	T9335	0.8	200	0.20	1.5	120	0.18	1.5	-	-	-	-	-	-	-	-	-



Suitability and starting values for cutting speed (vc), feed (f) and depth of cut (ap). Refer to our Machining Calculator app for further calculations.

Product	RE [mm]	P			M			K			N			S			H		
		vc	f	ap	vc	f	ap	vc	f	ap	vc	f	ap	vc	f	ap	vc	f	ap
		[m/min]	[mm/rev]	[mm]	[m/min]	[mm/rev]	[mm]	[m/min]	[mm/rev]	[mm]	[m/min]	[mm/rev]	[mm]	[m/min]	[mm/rev]	[mm]	[m/min]	[mm/rev]	[mm]

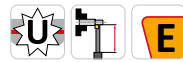
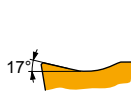

NF2 geometry with positive design for fine-finish to semi-rough machining, and continuous cuts.

CCMT 060202E-NF2	T6310	0.2	✓	170	0.10	0.8	■	120	0.09	0.8	✓	135	0.10	0.8	■	510	0.12	0.8	■	50	0.08	0.6	-	-	-
	T7325	0.2	✓	195	0.10	0.8	■	150	0.09	0.8	-	-	-	-	-	-	-	-	■	60	0.08	0.6	-	-	-
	T8330	0.2	✓	170	0.10	0.8	■	100	0.09	0.8	✓	160	0.10	0.8	■	510	0.12	0.8	✓	40	0.08	0.6	-	-	-
	T8430	0.2	✓	210	0.10	0.8	■	115	0.09	0.8	✓	175	0.10	0.8	■	585	0.12	0.8	✓	45	0.08	0.6	-	-	-
	T9325	0.2	✓	260	0.10	0.8	■	155	0.09	0.8	✓	245	0.10	0.8	-	-	-	-	■	55	0.08	0.6	-	-	-
CCMT 060204E-NF2	H07	0.4	-	-	-	-	■	85	0.11	0.8	✓	140	0.12	0.8	■	445	0.14	0.8	■	45	0.11	0.6	-	-	-
	T6310	0.4	✓	170	0.12	0.8	■	120	0.11	0.8	✓	135	0.12	0.8	■	510	0.14	0.8	■	50	0.11	0.6	-	-	-
	T7325	0.4	✓	200	0.12	0.8	■	155	0.11	0.8	-	-	-	-	-	-	-	-	■	65	0.11	0.6	-	-	-
	T8330	0.4	✓	170	0.12	0.8	■	100	0.11	0.8	✓	160	0.12	0.8	■	510	0.14	0.8	✓	40	0.11	0.6	-	-	-
	T8430	0.4	✓	205	0.12	0.8	■	110	0.11	0.8	✓	170	0.12	0.8	■	570	0.14	0.8	✓	45	0.11	0.6	-	-	-
	T9315	0.4	✓	290	0.12	0.8	-	-	-	-	✓	275	0.12	0.8	-	-	-	-	-	-	-	-	-	-	-
	T9325	0.4	✓	255	0.12	0.8	■	150	0.11	0.8	✓	240	0.12	0.8	-	-	-	-	■	55	0.11	0.6	-	-	-
	T9335	0.4	✓	220	0.12	0.8	■	130	0.11	0.8	-	-	-	-	-	-	-	-	■	45	0.11	0.6	-	-	-
CCMT 080304E-NF2	T5315	0.4	✓	280	0.12	1.0	-	-	-	✓	265	0.12	1.0	-	-	-	-	-	-	-	-	-	-	-	
	T7325	0.4	✓	190	0.12	1.0	■	145	0.11	1.0	-	-	-	-	-	-	-	-	■	60	0.11	0.8	-	-	-
	T7335	0.4	✓	190	0.12	1.0	■	145	0.11	1.0	-	-	-	-	-	-	-	-	■	60	0.11	0.8	-	-	-
	T9315	0.4	✓	280	0.12	1.0	-	-	-	-	✓	265	0.12	1.0	-	-	-	-	-	-	-	-	-	-	
	T9325	0.4	✓	255	0.12	1.0	■	150	0.11	1.0	✓	240	0.12	1.0	-	-	-	-	■	55	0.11	0.8	-	-	-
CCMT 080308E-NF2	H07	0.8	-	-	-	-	■	95	0.13	1.2	✓	150	0.14	1.2	■	485	0.17	1.2	■	45	0.13	1.0	-	-	-
	T5315	0.8	✓	295	0.17	1.0	-	-	-	✓	280	0.17	1.0	-	-	-	-	-	-	-	-	-	-	-	
	T7325	0.8	✓	205	0.17	1.0	■	155	0.15	1.0	-	-	-	-	-	-	-	-	■	65	0.14	0.8	-	-	-
	T7335	0.8	✓	205	0.17	1.0	■	155	0.15	1.0	-	-	-	-	-	-	-	-	■	65	0.14	0.8	-	-	-
	T9325	0.8	✓	260	0.17	1.0	■	155	0.15	1.0	✓	245	0.17	1.0	-	-	-	-	■	55	0.14	0.8	-	-	-
CCMT 09T304E-NF2	H07	0.4	-	-	-	-	■	85	0.11	1.2	✓	135	0.12	1.2	■	430	0.14	1.2	■	40	0.11	1.0	-	-	-
	T6310	0.4	✓	165	0.12	1.2	■	115	0.11	1.2	✓	130	0.12	1.2	■	495	0.14	1.2	■	45	0.11	1.0	-	-	-
	T7325	0.4	✓	190	0.12	1.2	■	145	0.11	1.2	-	-	-	-	-	-	-	-	■	60	0.11	1.0	-	-	-
	T8330	0.4	✓	165	0.12	1.2	■	95	0.11	1.2	✓	155	0.12	1.2	■	495	0.14	1.2	✓	40	0.11	1.0	-	-	-
	T8430	0.4	✓	200	0.12	1.2	■	110	0.11	1.2	✓	165	0.12	1.2	■	555	0.14	1.2	✓	40	0.11	1.0	-	-	-
	T9315	0.4	✓	275	0.12	1.2	-	-	-	-	✓	260	0.12	1.2	-	-	-	-	-	-	-	-	-	-	
	T9325	0.4	✓	250	0.12	1.2	■	150	0.11	1.2	✓	235	0.12	1.2	-	-	-	-	■	55	0.11	1.0	-	-	-
	T9335	0.4	✓	215	0.12	1.2	■	125	0.11	1.2	-	-	-	-	-	-	-	-	■	45	0.11	1.0	-	-	-
CCMT 09T308E-NF2	H07	0.8	-	-	-	-	■	95	0.13	1.2	✓	150	0.14	1.2	■	485	0.17	1.2	■	45	0.13	1.0	-	-	-
	T6310	0.8	✓	190	0.14	1.2	■	135	0.13	1.2	✓	150	0.14	1.2	■	570	0.17	1.2	■	55	0.13	1.0	-	-	-
	T7325	0.8	✓	215	0.14	1.2	■	165	0.13	1.2	-	-	-	-	-	-	-	-	■	65	0.13	1.0	-	-	-
	T8330	0.8	✓	190	0.14	1.2	■	110	0.13	1.2	✓	180	0.14	1.2	■	570	0.17	1.2	✓	45	0.13	1.0	-	-	-
	T8430	0.8	✓	225	0.14	1.2	■	120	0.13	1.2	✓	185	0.14	1.2	■	615	0.17	1.2	✓	45	0.13	1.0	-	-	-
	T9315	0.8	✓	310	0.14	1.2	-	-	-	-	✓	290	0.14	1.2	-	-	-	-	-	-	-	-	-	-	
	T9325	0.8	✓	275	0.14	1.2	■	165	0.13	1.2	✓	260	0.14	1.2	-	-	-	-	■	60	0.13	1.0	-	-	-
	T9335	0.8	✓	235	0.14	1.2	■	140	0.13	1.2	-	-	-	-	-	-	-	-	■	50	0.13	1.0	-	-	-

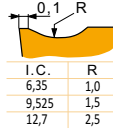

RF geometry for semi-rough to rough machining, and continuous to interrupted cuts.

CCMT 060202E-RF	T7335	0.2	✓	150	0.15	1.0	■	115	0.14	1.0	-	-	-	-	-	-	-	-	-	-	-	-	-	-	
CCMT 060204E-RF	T5315	0.4	✓	235	0.15	1.0	-	-	-	■	220	0.15	1.0	-	-	-	-	-	■	45	0.15	1.0	-	-	-
	T7335	0.4	✓	160	0.15	1.0	■	120	0.15	1.0	-	-	-	-	-	-	-	-	-	-	-	-	-		
	T9325	0.4	■	205	0.15	1.0	■	120	0.15	1.0	✓	190	0.15	1.0	-	-	-	-	-	-	-	-	-		
CCMT 09T304E-RF	T7335	0.4	✓	135	0.20	1.5	■	105	0.18	1.5	-	-	-	-	-	-	-	-	-	-	-	-	-		
	T9325	0.4	■	175	0.20	1.5	■	105	0.18	1.5	✓	165	0.20	1.5	-	-	-	-	-	-	-	-	-		
CCMT 09T308E-RF	T5315	0.8	✓	245	0.20	1.5	-	-	-	■	230	0.20	1.5	-	-	-	-	-	■	45	0.15	1.0	-	-	-
	T7335	0.8	✓	165	0.20	1.5	■	125	0.18	1.5	-	-	-	-	-	-	-	-	-	-	-	-	-		
	T9325	0.8	■	210	0.20	1.5	■	125	0.18	1.5	✓	195	0.20	1.5	-	-	-	-	-	-	-	-	-		
CCMT 120408E-RF	T5315	0.8	✓	230	0.22	2.2	-	-	-	■	215	0.22	2.2	-	-	-	-	-	■	45	0.15	1.0	-	-	-
	T7335	0.8	✓	150	0.22	2.2	■	115	0.22	2.2	-	-	-	-	-	-	-	-	-	-	-	-	-		
	T9325	0.8	■	195	0.22	2.2	■	115	0.22	2.2	✓	185	0.22	2.2	-	-	-	-	-	-	-	-	-		



Suitability and starting values for cutting speed (vc), feed (f) and depth of cut (ap). Refer to our Machining Calculator app for further calculations.

Product	RE (mm)	P			M			K			N			S			H		
		vc (m/min)	f (mm/rev)	ap (mm)	vc (m/min)	f (mm/rev)	ap (mm)	vc (m/min)	f (mm/rev)	ap (mm)	vc (m/min)	f (mm/rev)	ap (mm)	vc (m/min)	f (mm/rev)	ap (mm)	vc (m/min)	f (mm/rev)	ap (mm)

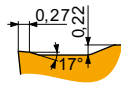
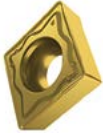

RM geometry for semi-rough to rough machining, and continuous to interrupted cuts.

CCMT 09T304E-RM	T5305	0.4	260	0.27	2.2	-	-	-	245	0.27	2.2	-	-	-	-	-	50	0.15	1.0	
	T5315	0.4	230	0.27	2.2	-	-	-	215	0.27	2.2	-	-	-	-	-	45	0.15	1.0	
	T7335	0.4	155	0.27	2.2	120	0.24	2.2	-	-	-	50	0.19	1.8	-	-	-	-	-	
	T8330	0.4	140	0.27	2.2	80	0.24	2.2	130	0.27	2.2	-	-	-	35	0.19	1.8	25	0.15	1.0
	T8430	0.4	150	0.27	2.2	80	0.24	2.2	125	0.27	2.2	-	-	-	30	0.19	1.8	25	0.15	1.0
	T9315	0.4	215	0.27	2.2	-	-	-	200	0.27	2.2	-	-	-	-	-	-	40	0.15	1.0
	T9325	0.4	190	0.27	2.2	110	0.24	2.2	180	0.27	2.2	-	-	-	40	0.19	1.8	-	-	-
CCMT 09T308E-RM	T5305	0.8	290	0.30	2.2	-	-	-	275	0.30	2.2	-	-	-	-	-	55	0.15	1.0	
	T5315	0.8	265	0.30	2.2	-	-	-	250	0.30	2.2	-	-	-	-	-	50	0.15	1.0	
	T7335	0.8	175	0.30	2.2	135	0.27	2.2	-	-	-	55	0.24	1.8	-	-	-	-		
	T8330	0.8	165	0.30	2.2	95	0.27	2.2	155	0.30	2.2	-	-	-	40	0.24	1.8	30	0.15	1.0
	T8430	0.8	180	0.30	2.2	95	0.27	2.2	145	0.30	2.2	-	-	-	35	0.24	1.8	30	0.15	1.0
	T9315	0.8	240	0.30	2.2	-	-	-	225	0.30	2.2	-	-	-	-	-	-	45	0.15	1.0
	T9325	0.8	215	0.30	2.2	125	0.27	2.2	200	0.30	2.2	-	-	-	45	0.24	1.8	-	-	-
CCMT 120408E-RM	T5305	0.8	290	0.30	2.7	-	-	-	275	0.30	2.7	-	-	-	-	-	55	0.15	1.0	
	T5315	0.8	260	0.30	2.7	-	-	-	245	0.30	2.7	-	-	-	-	-	50	0.15	1.0	
	T7335	0.8	175	0.30	2.7	135	0.27	2.7	-	-	-	55	0.24	2.2	-	-	-	-		
	T8330	0.8	160	0.30	2.7	95	0.27	2.7	150	0.30	2.7	-	-	-	40	0.24	2.2	30	0.15	1.0
	T8430	0.8	175	0.30	2.7	95	0.27	2.7	140	0.30	2.7	-	-	-	35	0.24	2.2	30	0.15	1.0
	T9315	0.8	235	0.30	2.7	-	-	-	220	0.30	2.7	-	-	-	-	-	-	45	0.15	1.0
	T9325	0.8	210	0.30	2.7	125	0.27	2.7	195	0.30	2.7	-	-	-	45	0.24	2.2	-	-	-
CCMT 120412E-RM	T8330	1.2	165	0.33	2.7	95	0.30	2.7	155	0.33	2.7	-	-	-	40	0.23	2.2	30	0.15	1.0
	T8430	1.2	180	0.33	2.7	95	0.30	2.7	145	0.33	2.7	-	-	-	35	0.23	2.2	30	0.15	1.0
	T9315	1.2	235	0.33	2.7	-	-	-	220	0.33	2.7	-	-	-	-	-	-	45	0.15	1.0
	T9325	1.2	215	0.33	2.7	125	0.30	2.7	200	0.33	2.7	-	-	-	45	0.23	2.2	-	-	-

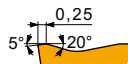

RM3 geometry for semi-rough to rough machining, and continuous to interrupted cuts.

CCMT 120404E-RM3	T7325	0.4	140	0.25	2.5	105	0.25	2.5	-	-	-	-	-	-	-	-	-	-	-	
	T9315	0.4	190	0.25	2.5	-	-	-	180	0.25	2.5	-	-	-	-	-	35	0.15	1.0	
	T9325	0.4	165	0.25	2.5	95	0.25	2.5	155	0.25	2.5	-	-	-	-	-	-	-	-	
CCMT 120408E-RM3	T6310	0.8	145	0.27	2.5	100	0.27	2.5	115	0.27	2.5	-	-	-	-	-	25	0.15	1.0	
	T7325	0.8	165	0.27	2.5	125	0.27	2.5	-	-	-	-	-	-	-	-	-	-		
	T9315	0.8	215	0.27	2.5	-	-	-	200	0.27	2.5	-	-	-	-	-	-	40	0.15	1.0
	T9325	0.8	195	0.27	2.5	115	0.27	2.5	185	0.27	2.5	-	-	-	-	-	-	-	-	
CCMT 120412E-RM3	T7325	1.2	170	0.30	2.5	130	0.27	2.5	-	-	-	-	-	-	-	-	-	-	-	
	T9315	1.2	220	0.30	2.5	-	-	-	205	0.30	2.5	-	-	-	-	-	-	40	0.15	1.0

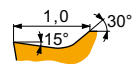

UR geometry for fine to finish machining, and continuous to slightly interrupted cuts.

CCMT 060202E-UR	T7325	0.2	185	0.10	0.8	140	0.09	0.8	-	-	-	-	-	-	-	-	-	-	-	
	T7335	0.2	185	0.10	0.8	140	0.09	0.8	-	-	-	-	-	-	-	-	-	-	-	
	T8315	0.2	170	0.10	0.8	100	0.09	0.8	160	0.10	0.8	-	-	-	-	-	-	-	-	
	T8330	0.2	160	0.10	0.8	95	0.09	0.8	150	0.10	0.8	-	-	-	-	-	-	-	-	
	T8430	0.2	200	0.10	0.8	110	0.09	0.8	165	0.10	0.8	-	-	-	-	-	-	-	-	
	T9315	0.2	275	0.10	0.8	-	-	-	260	0.10	0.8	-	-	-	-	-	-	-	-	-
	T9325	0.2	250	0.10	0.8	150	0.09	0.8	235	0.10	0.8	-	-	-	-	-	-	-	-	
	TT310	0.2	275	0.10	0.5	165	0.09	0.5	-	-	-	-	-	-	-	-	-	-	-	



Suitability and starting values for cutting speed (vc), feed (f) and depth of cut (ap). Refer to our Machining Calculator app for further calculations.

Product	RE [mm]	P			M			K			N			S			H		
		vc [m/min]	f [mm/rev]	ap [mm]	vc [m/min]	f [mm/rev]	ap [mm]	vc [m/min]	f [mm/rev]	ap [mm]	vc [m/min]	f [mm/rev]	ap [mm]	vc [m/min]	f [mm/rev]	ap [mm]	vc [m/min]	f [mm/rev]	ap [mm]

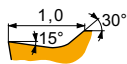
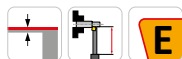

UR geometry for fine to finish machining, and continuous to slightly interrupted cuts.

CCMT 060204E-UR	T5315	0.4	245	0.15	1.0	-	-	-	230	0.15	1.0	-	-	-	-	-	-	-	
	T7325	0.4	170	0.15	1.0	130	0.15	1.0	-	-	-	-	-	-	-	-	-	-	
	T7335	0.4	170	0.15	1.0	130	0.15	1.0	-	-	-	-	-	-	-	-	-	-	
	T8315	0.4	160	0.15	1.0	95	0.14	1.0	150	0.15	1.0	-	-	-	-	-	-	-	
	T8330	0.4	150	0.15	1.0	90	0.14	1.0	140	0.15	1.0	-	-	-	-	-	-	-	
	T8430	0.4	175	0.15	1.0	95	0.14	1.0	140	0.15	1.0	-	-	-	-	-	-	-	-
	T9315	0.4	245	0.15	1.0	-	-	-	230	0.15	1.0	-	-	-	-	-	-	-	-
	T9325	0.4	215	0.15	1.0	125	0.15	1.0	200	0.15	1.0	-	-	-	-	-	-	-	-
	TT310	0.4	255	0.15	0.5	150	0.14	0.5	-	-	-	-	-	-	-	-	-	-	-
	CCMT 060208E-UR	T5315	0.8	270	0.20	1.0	-	-	-	255	0.20	1.0	-	-	-	-	-	-	-
T7325		0.8	190	0.20	1.0	145	0.18	1.0	-	-	-	-	-	-	-	-	-	-	
T8330		0.8	165	0.20	1.0	95	0.18	1.0	155	0.20	1.0	-	-	-	-	-	-	-	
T8430		0.8	185	0.20	1.0	100	0.18	1.0	150	0.20	1.0	-	-	-	-	-	-	-	
T9315		0.8	255	0.20	1.0	-	-	-	240	0.20	1.0	-	-	-	-	-	-	-	-
CCMT 09T302E-UR	T6310	0.2	160	0.10	1.0	115	0.09	1.0	125	0.10	1.0	-	-	-	-	-	-	-	
	T8430	0.2	195	0.10	1.0	105	0.09	1.0	160	0.10	1.0	-	-	-	-	-	-	-	
	TT310	0.2	255	0.10	1.0	150	0.09	1.0	-	-	-	-	-	-	-	-	-	-	
CCMT 09T304E-UR	T5315	0.4	245	0.15	1.2	-	-	-	230	0.15	1.2	-	-	-	-	-	-	-	
	T7325	0.4	170	0.15	1.2	130	0.15	1.2	-	-	-	-	-	-	-	-	-	-	
	T7335	0.4	165	0.15	1.2	125	0.15	1.2	-	-	-	-	-	-	-	-	-	-	
	T8315	0.4	155	0.15	1.2	90	0.14	1.2	145	0.15	1.2	-	-	-	-	-	-	-	
	T8330	0.4	150	0.15	1.2	90	0.14	1.2	140	0.15	1.2	-	-	-	-	-	-	-	
	T8430	0.4	175	0.15	1.2	95	0.14	1.2	140	0.15	1.2	-	-	-	-	-	-	-	
	T9310	0.4	265	0.15	1.2	-	-	-	250	0.15	1.2	-	-	-	-	-	-	-	-
	T9315	0.4	235	0.15	1.2	-	-	-	220	0.15	1.2	-	-	-	-	-	-	-	-
	T9325	0.4	215	0.15	1.2	125	0.15	1.2	200	0.15	1.2	-	-	-	-	-	-	-	-
	TT310	0.4	235	0.15	1.2	140	0.14	1.2	-	-	-	-	-	-	-	-	-	-	-
CCMT 09T308E-UR	T5315	0.8	265	0.20	1.2	-	-	-	250	0.20	1.2	-	-	-	-	-	-	-	
	T7325	0.8	185	0.20	1.2	140	0.18	1.2	-	-	-	-	-	-	-	-	-	-	
	T7335	0.8	175	0.20	1.2	135	0.18	1.2	-	-	-	-	-	-	-	-	-	-	
	T8315	0.8	170	0.20	1.2	100	0.18	1.2	160	0.20	1.2	-	-	-	-	-	-	-	
	T8330	0.8	160	0.20	1.2	95	0.18	1.2	150	0.20	1.2	-	-	-	-	-	-	-	
	T8430	0.8	185	0.20	1.2	100	0.18	1.2	150	0.20	1.2	-	-	-	-	-	-	-	
	T9310	0.8	280	0.20	1.2	-	-	-	265	0.20	1.2	-	-	-	-	-	-	-	-
	T9315	0.8	250	0.20	1.2	-	-	-	235	0.20	1.2	-	-	-	-	-	-	-	-
	T9325	0.8	225	0.20	1.2	135	0.18	1.2	210	0.20	1.2	-	-	-	-	-	-	-	-
	TT310	0.8	255	0.20	1.2	150	0.18	1.2	-	-	-	-	-	-	-	-	-	-	-
CCMT 120404E-UR	T5315	0.4	235	0.15	1.7	-	-	-	220	0.15	1.7	-	-	-	-	-	-	-	
	T7325	0.4	160	0.15	1.7	120	0.15	1.7	-	-	-	-	-	-	-	-	-	-	
	T8330	0.4	140	0.15	1.7	80	0.14	1.7	130	0.15	1.7	-	-	-	-	-	-	-	
	T8430	0.4	170	0.15	1.7	90	0.14	1.7	135	0.15	1.7	-	-	-	-	-	-	-	
	T9315	0.4	230	0.15	1.7	-	-	-	215	0.15	1.7	-	-	-	-	-	-	-	-
CCMT 120408E-UR	T9325	0.4	205	0.15	1.7	120	0.15	1.7	190	0.15	1.7	-	-	-	-	-	-	-	
	T5315	0.8	255	0.20	1.7	-	-	-	240	0.20	1.7	-	-	-	-	-	-	-	-
	T7325	0.8	175	0.20	1.7	135	0.18	1.7	-	-	-	-	-	-	-	-	-	-	
	T7335	0.8	170	0.20	1.7	130	0.18	1.7	-	-	-	-	-	-	-	-	-	-	
	T8330	0.8	155	0.20	1.7	90	0.18	1.7	145	0.20	1.7	-	-	-	-	-	-	-	
	T8430	0.8	180	0.20	1.7	95	0.18	1.7	145	0.20	1.7	-	-	-	-	-	-	-	
	T9315	0.8	240	0.20	1.7	-	-	-	225	0.20	1.7	-	-	-	-	-	-	-	-
CCMT 120412E-UR	T9325	0.8	215	0.20	1.7	125	0.18	1.7	200	0.20	1.7	-	-	-	-	-	-	-	
	T5315	1.2	240	0.27	1.7	-	-	-	225	0.27	1.7	-	-	-	-	-	-	-	
	T7325	1.2	170	0.27	1.7	130	0.24	1.7	-	-	-	-	-	-	-	-	-	-	
	T8430	1.2	165	0.27	1.7	90	0.24	1.7	135	0.27	1.7	-	-	-	-	-	-	-	
	T9315	1.2	225	0.27	1.7	-	-	-	210	0.27	1.7	-	-	-	-	-	-	-	-
T9325	1.2	205	0.27	1.7	120	0.24	1.7	190	0.27	1.7	-	-	-	-	-	-	-	-	



Suitability and starting values for cutting speed (vc), feed (f) and depth of cut (ap). Refer to our Machining Calculator app for further calculations.

Product	RE [mm]	P			M			K			N			S			H		
		vc [m/min]	f [mm/rev]	ap [mm]	vc [m/min]	f [mm/rev]	ap [mm]	vc [m/min]	f [mm/rev]	ap [mm]	vc [m/min]	f [mm/rev]	ap [mm]	vc [m/min]	f [mm/rev]	ap [mm]	vc [m/min]	f [mm/rev]	ap [mm]

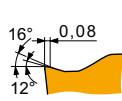
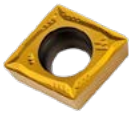

W-FM wiper geometry for fine to finish machining with increased feed rates and improved surface finish.

CCMT 060204W-FM	T7325	0.4	165	0.30	0.8	125	0.27	0.8	-	-	-	-	-	-	-	-	-	-
	T8430	0.4	165	0.30	0.8	90	0.27	0.8	135	0.30	0.8	-	-	-	-	-	-	-
	T9315	0.4	215	0.30	0.8	-	-	-	200	0.30	0.8	-	-	-	-	-	-	-
	T9325	0.4	190	0.30	0.8	110	0.27	0.8	180	0.30	0.8	-	-	-	-	-	-	-
CCMT 09T304W-FM	T7325	0.4	165	0.30	0.8	125	0.27	0.8	-	-	-	-	-	-	-	-	-	-
	T8330	0.4	145	0.30	0.8	85	0.27	0.8	135	0.30	0.8	-	-	-	-	-	-	-
	T8430	0.4	165	0.30	0.8	90	0.27	0.8	135	0.30	0.8	-	-	-	-	-	-	-
	T9315	0.4	215	0.30	0.8	-	-	-	200	0.30	0.8	-	-	-	-	-	-	-
CCMT 09T308W-FM	T9325	0.4	190	0.30	0.8	110	0.27	0.8	180	0.30	0.8	-	-	-	-	-	-	-
	T8330	0.8	155	0.40	1.0	90	0.36	1.0	145	0.40	1.0	-	-	-	-	-	-	-
	T8430	0.8	170	0.40	1.0	90	0.36	1.0	135	0.40	1.0	-	-	-	-	-	-	-
	T9315	0.8	220	0.40	1.0	-	-	-	205	0.40	1.0	-	-	-	-	-	-	-
CCMT 09T308W-FM	T9325	0.8	200	0.40	1.0	120	0.36	1.0	190	0.40	1.0	-	-	-	-	-	-	-

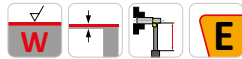
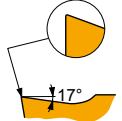
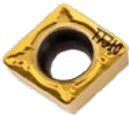

W-UR wiper geometry for fine to finish machining with increased feed rates and improved surface finish.

CCMT 060204W-UR	TT310	0.4	255	0.15	0.5	150	0.14	0.5	-	-	-	-	-	-	-	-	-	-
CCMT 09T308W-UR	TT310	0.8	255	0.20	1.2	150	0.18	1.2	-	-	-	-	-	-	-	-	-	-

CCMW



	IC [mm]	D1 [mm]	L [mm]	S [mm]
0602	6.350	2.80	6.40	2.38
09T3	9.525	4.40	9.70	3.97
1204	12.700	5.50	12.90	4.76

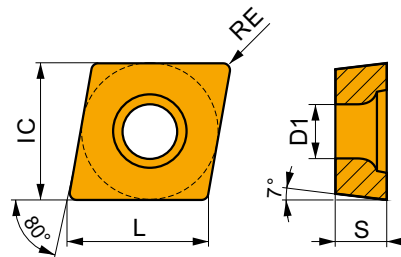

Suitability and starting values for cutting speed (vc), feed (f) and depth of cut (ap). Refer to our Machining Calculator app for further calculations.

Product	RE [mm]	P			M			K			N			S			H		
		vc [m/min]	f [mm/rev]	ap [mm]	vc [m/min]	f [mm/rev]	ap [mm]	vc [m/min]	f [mm/rev]	ap [mm]	vc [m/min]	f [mm/rev]	ap [mm]	vc [m/min]	f [mm/rev]	ap [mm]	vc [m/min]	f [mm/rev]	ap [mm]

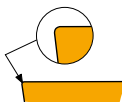

For fine-finish to semi-rough machining, and continuous to slightly interrupted cuts.

CCMW 060202	T5305	0.2	-	-	-	-	-	-	230	0.08	2.0	-	-	-	-	-	45	0.15	1.0
	T6310	0.2	-	-	-	-	-	-	100	0.08	2.0	-	-	-	-	-	25	0.15	1.0
CCMW 060204	T5305	0.4	-	-	-	-	-	-	230	0.10	2.0	-	-	-	-	-	45	0.15	1.0
	T5315	0.4	-	-	-	-	-	-	195	0.10	2.0	-	-	-	-	-	40	0.15	1.0
	T6310	0.4	-	-	-	-	-	-	95	0.10	2.0	-	-	-	-	-	20	0.15	1.0
CCMW 09T304	T5305	0.4	-	-	-	-	-	-	215	0.10	3.0	-	-	-	-	-	45	0.15	1.0
	T5315	0.4	-	-	-	-	-	-	190	0.10	3.0	-	-	-	-	-	40	0.15	1.0
	T6310	0.4	-	-	-	-	-	-	95	0.10	3.0	-	-	-	-	-	20	0.15	1.0
CCMW 09T308	T5305	0.8	-	-	-	-	-	-	200	0.20	3.0	-	-	-	-	-	40	0.15	1.0
	T5315	0.8	-	-	-	-	-	-	180	0.20	3.0	-	-	-	-	-	35	0.15	1.0
	T6310	0.8	-	-	-	-	-	-	90	0.20	3.0	-	-	-	-	-	20	0.15	1.0



Suitability and starting values for cutting speed (vc), feed (f) and depth of cut (ap). Refer to our Machining Calculator app for further calculations.

Product	RE [mm]	P			M			K			N			S			H				
		vc [m/min]	f [mm/rev]	ap [mm]	vc [m/min]	f [mm/rev]	ap [mm]	vc [m/min]	f [mm/rev]	ap [mm]	vc [m/min]	f [mm/rev]	ap [mm]	vc [m/min]	f [mm/rev]	ap [mm]	vc [m/min]	f [mm/rev]	ap [mm]		
	0.4	T5305	—	—	—	—	—	—	—	—	—	—	—	—	—	—	—	—	—	—	
		T5315	—	—	—	—	—	—	—	—	—	—	—	—	—	—	—	—	—	—	—
		T6310	—	—	—	—	—	—	—	—	—	—	—	—	—	—	—	—	—	—	—
CCMW 120408	0.8	T5305	—	—	—	—	—	—	—	—	—	—	—	—	—	—	—	—	—	—	
		T5315	—	—	—	—	—	—	—	—	—	—	—	—	—	—	—	—	—	—	
		T6310	—	—	—	—	—	—	—	—	—	—	—	—	—	—	—	—	—	—	



For fine-finish to semi-rough machining, and continuous to slightly interrupted cuts.

CCGW CBN

PRAMET

	IC [mm]	D1 [mm]	L [mm]	S [mm]
0602	6.350	2.80	6.50	2.38
09T3	9.525	4.50	9.70	3.97

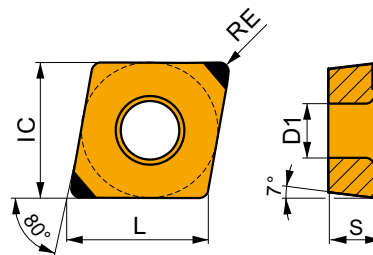

Suitability and starting values for cutting speed (vc), feed (f) and depth of cut (ap). Refer to our Machining Calculator app for further calculations.

Product	RE [mm]	P			M			K			N			S			H		
		vc [m/min]	f [mm/rev]	ap [mm]	vc [m/min]	f [mm/rev]	ap [mm]	vc [m/min]	f [mm/rev]	ap [mm]	vc [m/min]	f [mm/rev]	ap [mm]	vc [m/min]	f [mm/rev]	ap [mm]	vc [m/min]	f [mm/rev]	ap [mm]
	0.4	TB310	—	—	—	—	—	—	—	—	—	—	—	—	—	—	—	—	—
		TB310	—	—	—	—	—	—	—	—	—	—	—	—	—	—	—	—	—
	0.4	TB310	—	—	—	—	—	—	—	—	—	—	—	—	—	—	—	—	—
		TB310	—	—	—	—	—	—	—	—	—	—	—	—	—	—	—	—	—
	0.4	TB310	—	—	—	—	—	—	—	—	—	—	—	—	—	—	—	—	—
		TB310	—	—	—	—	—	—	—	—	—	—	—	—	—	—	—	—	—
	0.4	TB310	—	—	—	—	—	—	—	—	—	—	—	—	—	—	—	—	—
		TB310	—	—	—	—	—	—	—	—	—	—	—	—	—	—	—	—	—



SCAC(RL) EXT



PRAMET

S



External Screw Lock Tool Holder with 90° Cutting Angle for CC.. Insert

External Right/Left hand tool holder with 90° cutting angle for screw type positive CC.. 06 or 09 inserts. Suited for external longitudinal, taper and chamfer turning. Available with shank size 08x08 up to 16x16 mm. Body treated for longer tool life.

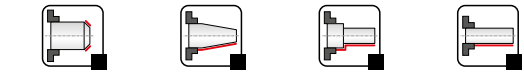
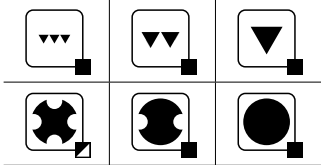
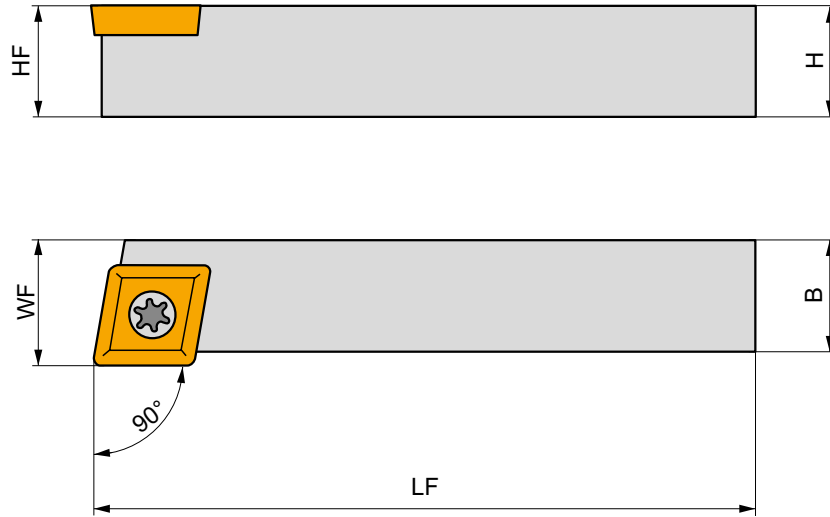
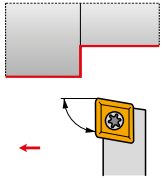

Product	H	B	HF	WF	LF	LAMS	GAMO	kg		
	[mm]	[mm]	[mm]	[mm]	[mm]	[°]	[°]			
R SCACR 0808 D 06	8	8	8	8.5	60	0	0	0.04	G1045	S07
SCACR 1010 E 06	10	10	10	10.5	70	0	0	0.09	G1045	S07
SCACR 1212 F 09	12	12	12	12.5	80	0	0	0.12	G1041	S04
SCACR 1616 H 09	16	16	16	16.5	100	0	0	0.22	G1041	S04
L SCACL 0808 D 06	8	8	8	8.5	60	0	0	0.07	G1045	S07
SCACL 1010 E 06	10	10	10	10.5	70	0	0	0.06	G1045	S07
SCACL 1212 F 09	12	12	12	12.5	80	0	0	0.12	G1041	S04
SCACL 1616 H 09	16	16	16	16.5	100	0	0	0.22	G1041	S04

G1041		CC.. 09T3..	
G1045		CC.. 0602..	

S04	US 3510-T15P	3.0	M 3.5	10.6	FLAG T15P
S07	US 2506-T07P	0.9	M 2.5	6.3	FLAG T07P



SCBC(RL) EXT



External Screw Lock Tool Holder with 75° Cutting Angle for CC.. Insert

External Right/Left hand tool holder with 75° cutting angle for screw type positive CC.. 09 or 12 inserts. Suited for external longitudinal without shoulder and chamfer turning. Available with shank size 12x12 up to 25x25 mm. Body treated for longer tool life.

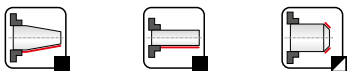
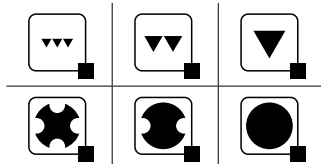
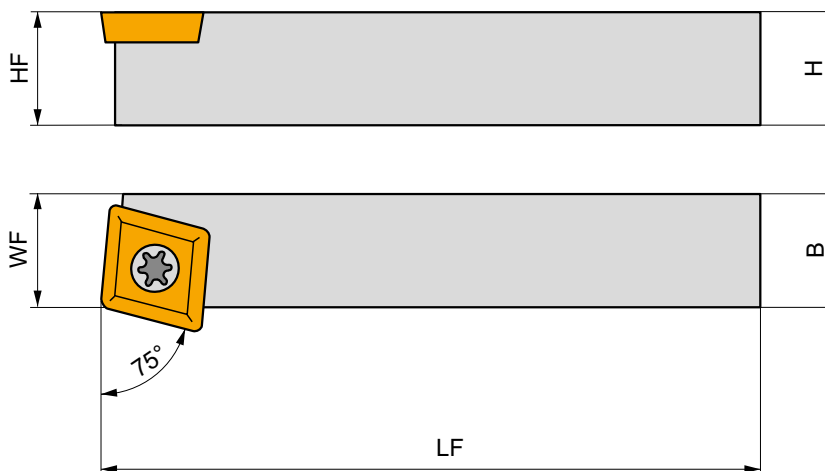
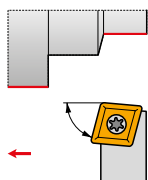

Product	H	B	HF	WF	LF	LAMS	GAMO	kg		
	[mm]	[mm]	[mm]	[mm]	[mm]	[°]	[°]			
R SCBCR 1212 F 09	12	12	12	11	80	0	0	0.10	GI041	S08
SCBCR 1616 H 09	16	16	16	13	100	0	0	0.20	GI041	S08
SCBCR 2020 K 12-M-A	20	20	20	17	125	0	0	0.45	GI011	SC20
SCBCR 2525 M 12-M-A	25	25	25	22	150	0	0	0.61	GI011	SC20
L SCBCL 1212 F 09	12	12	12	11	80	0	0	0.10	GI041	S08
SCBCL 1616 H 09	16	16	16	13	100	0	0	0.22	GI041	S08
SCBCL 2020 K 12-M-A	20	20	20	17	125	0	0	0.43	GI011	SC20
SCBCL 2525 M 12-M-A	25	25	25	22	150	0	0	0.75	GI011	SC20



GI011

CC.. 1204..

GI041

CC.. 09T3..



SC20

US 5012-T15P

5.0

M 5

12.2

SCN 120304

MS 5008

FLAG T15P

HXK 5

S08

US 3510-T15P

3.0

M 3.5

10.6

-

-

FLAG T15P

-



SCDCR EXT



External Screw Lock Tool Holder with 45° Cutting Angle for CC.. Insert

External right hand tool holder with 45° cutting angle for screw type positive CC.. 06 inserts. Suited for external longitudinal without shoulder, taper, multi-directional copy, and chamfer turning. Available with shank size 10x10 mm only. Body treated for longer tool life.

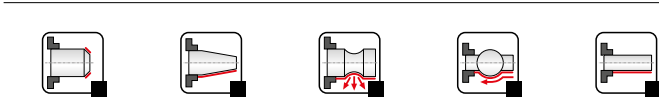
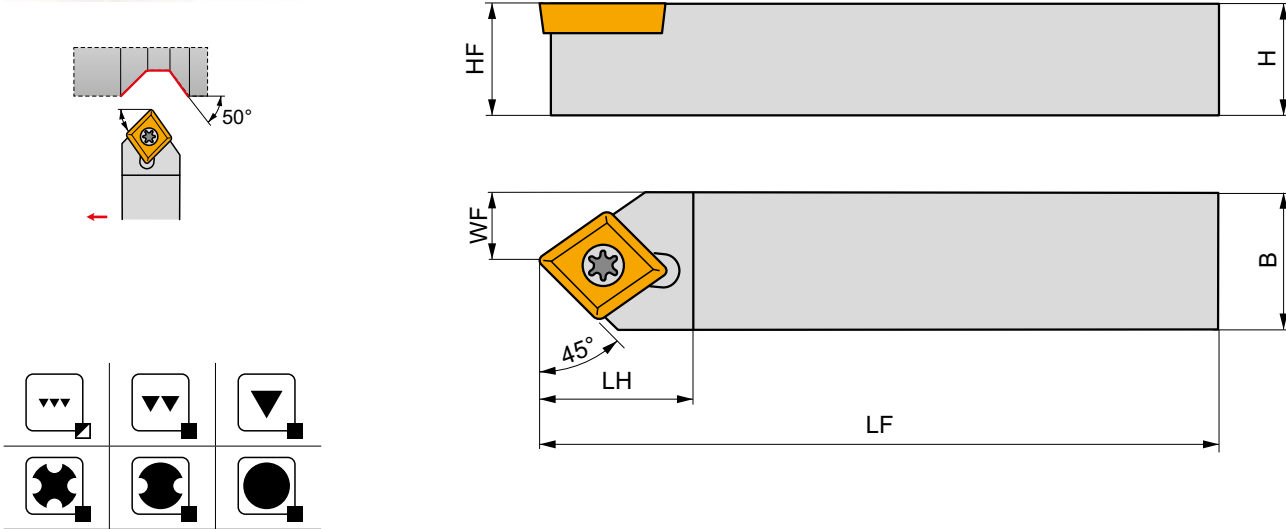

Product	H	B	HF	WF	LF	LH	LAMS	GAMO	kg	GI045	SC21
	[mm]	[mm]	[mm]	[mm]	[mm]	[mm]	[°]	[°]			
R SCDCR 1010 E 06	10	10	10	5.11	70	11	0	0	0.06	GI045	SC21

GI045	CC..0602..
-------	------------

SC21	5513 020-03	0.8 Nm	M 2.5	6.5	PT-8001
------	-------------	--------	-------	-----	---------



SCFC(RL) EXT



External Screw Lock Tool Holder with 90° Cutting Angle for CC.. Insert

External Right/Left hand tool holder with 90° cutting angle for screw type positive CC.. 06 or 09 inserts. Suited for external face and longitudinal turning with shoulder, taper and chamfer turning. Available with shank size 08x08 up to 16x16 mm. Body treated for longer tool life.

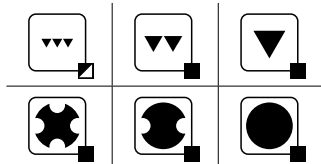
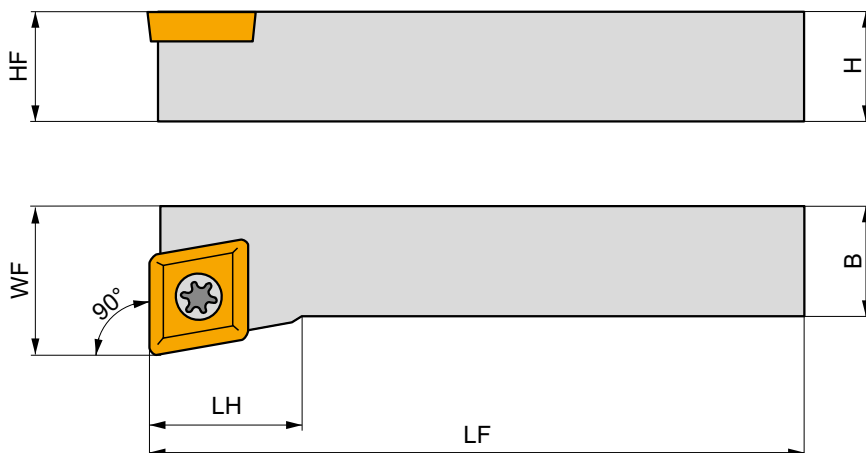
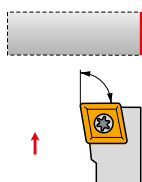

Product	H	B	HF	WF	LF	LH	LAMS	GAMO	kg		
	[mm]	[mm]	[mm]	[mm]	[mm]	[mm]	[°]	[°]			
R	SCFCR 0808 D 06	8	8	8	10	60	8	0	0.04	GI045	S07
	SCFCR 1010 E 06	10	10	10	12	70	8	0	0.07	GI045	S07
	SCFCR 1212 F 09	12	12	12	16	80	16	0	0.12	GI041	S04
	SCFCR 1616 H 09	16	16	16	20	100	16	0	0.22	GI041	S04
L	SCFCL 0808 D 06	8	8	8	10	60	8	0	0.04	GI045	S07
	SCFCL 1010 E 06	10	10	10	12	70	8	0	0.06	GI045	S07
	SCFCL 1212 F 09	12	12	12	16	80	16	0	0.10	GI041	S04
	SCFCL 1616 H 09	16	16	16	20	100	16	0	0.22	GI041	S04



GI041
GI045

CC.. 09T3..
CC.. 0602..



S04
S07

US 3510-T15P
US 2506-T07P

3.0
0.9

M 3.5
M 2.5

10.6
6.3

FLAG T15P
FLAG T07P



SCLC(RL) EXT



PRAMET

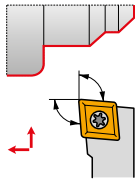

External Screw Lock Tool Holder with 95° Cutting Angle for CC.. Insert

External Right/Left hand tool holder with 95° cutting angle for screw type positive CC.. 06, 08, 09 or 12 inserts. Suited for external longitudinal turning with shoulder, taper and chamfer turning. Available with shank size 08x08 up to 25x25 mm. Body treated for longer tool life.

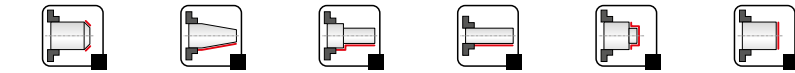
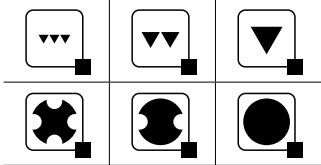
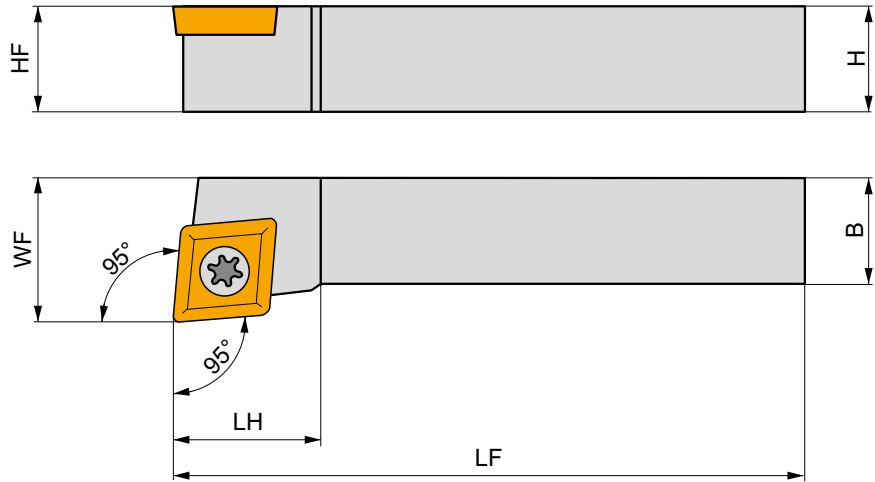

Product	H	B	HF	WF	LF	LH	LAMS	GAMO	kg	Icon 1	Icon 2	
	[mm]	[mm]	[mm]	[mm]	[mm]	[mm]	[°]	[°]				
R	SCLCR 0808 D 06	8	8	8	10	60	8	0	0	0.06	GI045	S01
	SCLCR 1010 E 06	10	10	10	12	70	8	0	0	0.09	GI045	S01
	SCLCR 1010 E 08	10	10	10	12	70	13.2	0	0	0.03	GI232	SC22
	SCLCR 1212 F 08	12	12	12	16	80	13.4	0	0	0.02	GI232	SC22
	SCLCR 1616 H 08	16	16	16	20	100	15.2	0	0	0.22	GI232	SC22
	SCLCR 1212 F 09	12	12	12	16	80	16	0	0	0.12	GI041	S08
	SCLCR 1616 H 09	16	16	16	20	100	16	0	0	0.22	GI041	S08
	SCLCR 2020 K 12-M-A	20	20	20	25	125	20	0	0	0.44	GI011	SC20
	SCLCR 2525 M 12-M-A	20	25	20	32	150	20	0	0	0.68	GI011	SC20
L	SCLCL 0808 D 06	8	8	8	10	60	8	0	0	0.06	GI045	S01
	SCLCL 1010 E 06	10	10	10	12	70	8	0	0	0.06	GI045	S01
	SCLCL 1212 F 08	12	12	12	16	80	13.4	0	0	0.03	GI232	SC22
	SCLCL 1616 H 08	16	16	16	20	100	15.2	0	0	0.23	GI232	SC22
	SCLCL 1212 F 09	12	12	12	16	80	16	0	0	0.10	GI041	S08
	SCLCL 1616 H 09	16	16	16	20	100	16	0	0	0.22	GI041	S08
	SCLCL 2020 K 12-M-A	20	20	20	25	125	20	0	0	0.40	GI011	SC20
	SCLCL 2525 M 12-M-A	25	25	25	32	150	20	0	0	0.78	GI011	SC20



GI011
GI041
GI045
GI232

CC.. 1204..
CC.. 09T3..
CC.. 0602..
CC.. 0803..



SC20
SC22
S01
S08

US 5012-T15P
5513 020-04
US 2506-T07P
US 3510-T15P

5.0
1.5
0.9
3.0

M 5
M 3
M 2.5
M 3.5

12.2
7.2
6.3
10.6

SCN 120304
-
-
-

MS 5008
-
-
-

FLAG T15P
PT-8003
FLAG T07P
FLAG T15P

HXK 5
-
-
-



C.-SCLC(RL) EXT



External PSC Quick Change Tool, Screw Lock, 95° Cutting Angle for CC.. Insert

External Right/Left hand tool, through coolant, with 95° cutting angle for screw type positive CC.. 09 and 12 inserts. Suited for external longitudinal turning with shoulder, taper and chamfer turning. PSC shank (Polygon Shank Coupling) size C3 up to C5. Body treated for longer tool life.

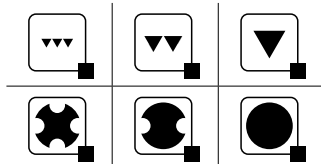
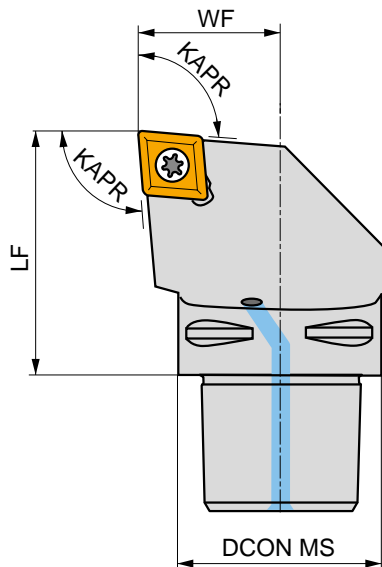
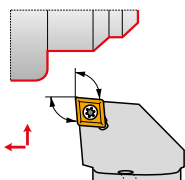

Product	DCON MS [mm]	WF [mm]	LF [mm]	KAPR [°]	LAMS [°]	GAMO [°]		kg			
R	C3-SCLCR-22040-09	32	22	40	95	0	0	✓	0.21	GI041	C-SC09S
	C4-SCLCR-27050-09	40	27	50	95	0	0	✓	0.39	GI041	C-SC09S
	C4-SCLCR-27050-12	40	27	50	95	0	0	✓	0.40	GI011	C-SC12-1
	C5-SCLCR-35060-12	50	35	60	95	0	0	✓	0.72	GI011	C-SC12-2
L	C3-SCLCL-22040-09	32	22	40	95	0	0	✓	0.21	GI041	C-SC09S
	C4-SCLCL-27050-09	40	27	50	95	0	0	✓	0.39	GI041	C-SC09S
	C5-SCLCL-35060-12	50	35	60	95	0	0	✓	0.72	GI011	C-SC12-2



GI011

CC.. 1204..

GI041

CC.. 09T3..



C-SC09S

US 2001-T15P

3.0

M 3.5

12.1

SCS 232-01

MS 9001

FLAG T15P/3,5

CN 034-01

C-SC12-1

US 2018-T15P

3.0

M 4

14

SCS 232-02

MS 9003

FLAG T15P/4

CN 034-01

C-SC12-2

US 2018-T15P

3.0

M 4

14

SCS 232-02

MS 9003

FLAG T15P/4

CN 034-02



SCFC(RL) INT

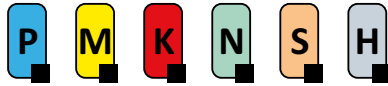

PRAMET

S



Internal Screw Lock Boring Bar with 90° Cutting Angle for CC.. Insert

Internal Right/Left hand boring bar with 90° cutting angle for screw type CC.. 06 inserts. Minimum internal turning diameter Ø13 mm. Suited for internal face and longitudinal turning with shoulder, taper and chamfer turning. Available with shank size Ø10 and Ø12 mm. Body treated for longer tool life.

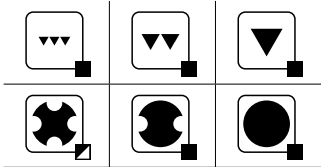
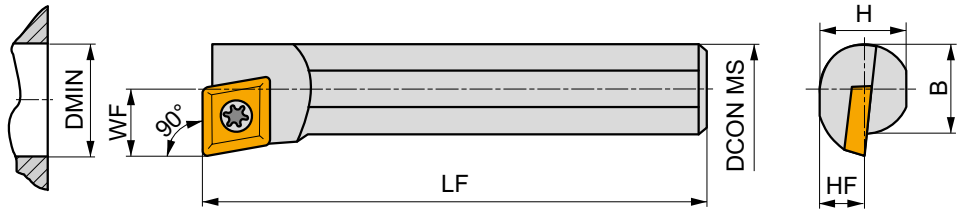
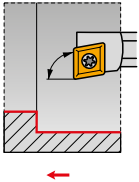

Product	DCON MS	DMIN	WF	H	B	LF	LAMS	GAMO	kg	G1045	S06
	[mm]	[mm]	[mm]	[mm]	[mm]	[mm]	[°]	[°]			
R S10H-SCFCR 06	10	13	7	9	9.5	100	-10	0	0.08	G1045	S06
	S12K-SCFCR 06	12	16	9	11	11.5	125	-7	0	0.11	G1045
L S10H-SCFCL 06	10	13	7	9	9.5	100	-10	0	0.10	G1045	S06
	S12K-SCFCL 06	12	16	9	11	11.5	125	-7	0	0.14	G1045

G1045	CC..0602..
-------	------------

S06	US 2505-T07P	0.9 Nm	M 2.5	5.2	FLAG T07P
-----	--------------	--------	-------	-----	-----------



SCKC(RL) INT



Internal Screw Lock Boring Bar with 75° Cutting Angle for CC.. Insert

Internal Right/Left hand boring bar with 75° cutting angle for screw type CC.. 06, 09 or 12 inserts. Minimum internal turning diameter Ø11 mm. Suited for internal longitudinal turning without shoulder, taper and chamfer turning. Available with shank size Ø8 up to Ø32 mm. Body treated for longer tool life.

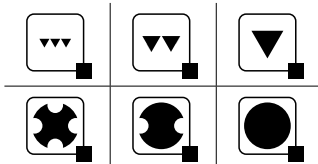
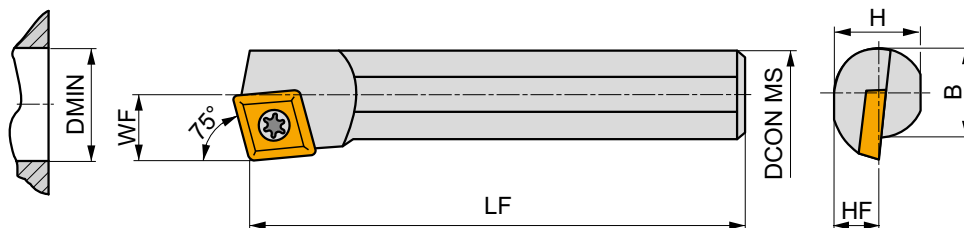
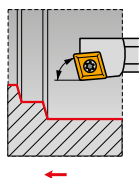

	Product	DCON MS	DMIN	WF	H	B	LF	LAMS	GAMO	kg	G1045	S02
		[mm]	[mm]	[mm]	[mm]	[mm]	[mm]	[°]	[°]			
R	S08F-SCKCR 06	8	11	6	7.2	7.6	80	-12	0	0.03	G1045	S02
	S12K-SCKCR 06	12	16	9	11	11.5	125	-8	0	0.11	G1045	S02
	S16M-SCKCR 09-A	16	20	11	14.5	15	150	-8	0	0.25	G1041	S05
	S20S-SCKCR 09	20	25	13	18.5	18.5	250	-5	0	0.60	G1041	S08
	S25T-SCKCR 09	25	32	17	23	23	300	-3	0	1.15	G1041	S08
	S32U-SCKCR 12-A	32	40	22	30	30	350	-10	0	2.10	G1011	SC20
L	S08F-SCKCL 06	8	11	6	7.2	7.6	80	-12	0	0.03	G1045	S02
	S12K-SCKCL 06	12	16	9	11	11.5	125	-8	0	0.11	G1045	S02
	S16M-SCKCL 09-A	16	20	11	14.5	15	150	-8	0	0.24	G1041	S05
	S20S-SCKCL 09	20	25	13	18.5	18.5	250	-5	0	0.60	G1041	S08
	S25T-SCKCL 09	25	32	17	23	23	300	-3	0	1.15	G1041	S08
	S32U-SCKCL 12-A	32	40	22	30	30	350	-10	0	2.10	G1011	SC20



G1011

CC.. 1204..

G1041

CC.. 09T3..

G1045

CC.. 0602..



SC20

US 5012-T15P

5.0

M 5

12.2

SCN 120304

MS 5008

FLAGT15P

HXK 5

S02

US 2505-T07P

0.9

M 2.5

5.2

-

-

FLAGT07P

-

S05

US 4008-T15P

3.5

M 4

8

-

-

FLAGT15P

-

S08

US 3510-T15P

3.0

M 3.5

10.6

-

-

FLAGT15P

-



SCLC(RL) INT



PRAMET

S



Internal Screw Lock Boring Bar with 95° Cutting Angle for CC.. Insert

Internal Right/Left hand boring bar, through coolant available, 95° cutting angle for screw type CC.. 06, 08, 09 or 12 inserts. Minimum internal turning diameter Ø11 mm. For internal longitudinal turning with shoulder, taper and chamfer turning. Available with shank size Ø8 to Ø32 mm. Body treated for longer tool life.

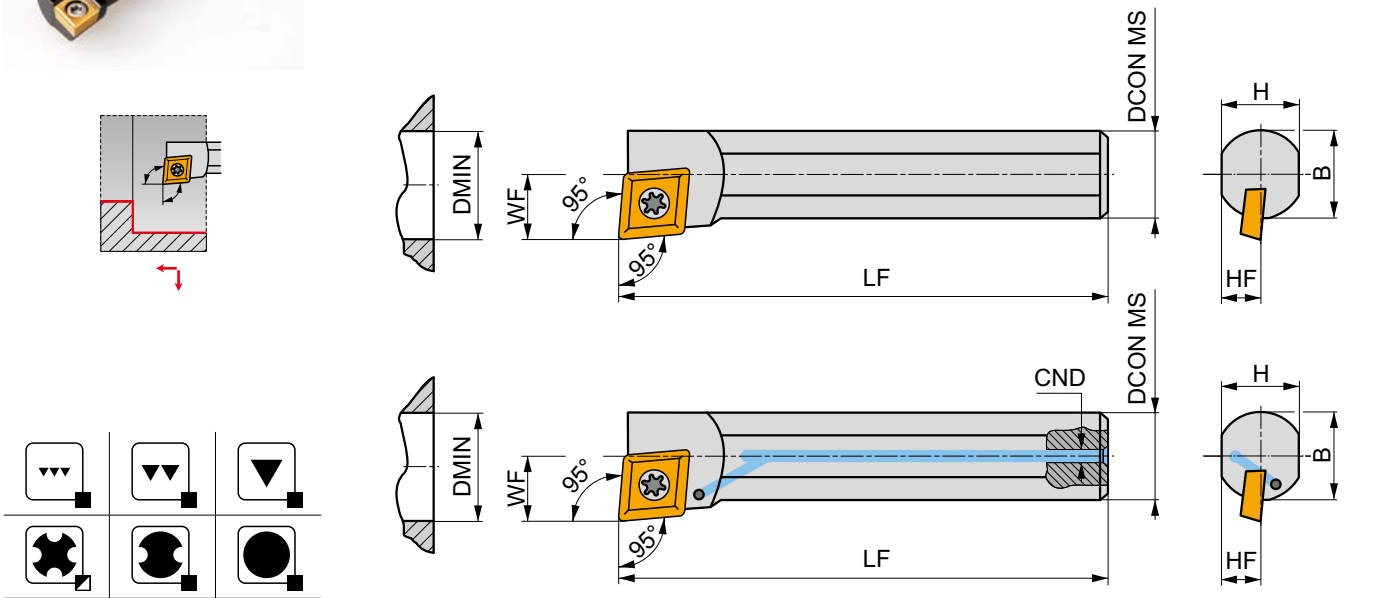

Product	DCON MS	DMIN	WF	H	B	LF	CND	LAMS	GAMO	Hand	kg	GI	SC
	[mm]	[mm]	[mm]	[mm]	[mm]	[mm]	[mm]	[°]	[°]				
R A08H-SCLCR 06	8	11	6	7.2	7.6	100	3.5	-13	0	✓	0.06	GI045	S02
S08F-SCLCR 06	8	11	6	7.2	7.6	80	-	-13	0	-	0.06	GI045	S02
A10H-SCLCR 06	10	13	7	9	-	100	4	-10	0	✓	0.07	GI045	S02
S10H-SCLCR 06	10	13	7	9	9.5	100	-	-10	0	-	0.08	GI045	S02
A12K-SCLCR 06	12	16	9	11	-	125	5	-8	0	✓	0.11	GI045	S01
S12K-SCLCR 06	12	16	9	11	11.5	125	-	-8	0	-	0.13	GI045	S01
S16M-SCLCR 06	16	20	11	14.5	15	150	-	-8	0	-	0.25	GI045	S01
A10K-SCLCR 08	10	12	6	9	9.5	125	4	-14	0	✓	0.09	GI232	SC22
A12M-SCLCR 08	12	16	9	11	11.5	150	5	-5	0	✓	0.14	GI232	SC22
A16R-SCLCR 08	16	20	11	14	15	200	6	-8	0	✓	0.28	GI232	SC22
A16M-SCLCR 09-A	16	20	11	14.5	-	150	6	-8	0	✓	0.22	GI041	S05
S16M-SCLCR 09-A	16	20	11	14.5	15	150	-	-8	0	-	0.25	GI041	S05
A20Q-SCLCR 09	20	25	13	18	-	180	8	-5	0	✓	0.38	GI041	S08
S20S-SCLCR 09	20	25	13	18	18.5	250	-	-5	0	-	0.62	GI041	S08
A25R-SCLCR 09	25	32	17	23	23	200	8	-3	0	✓	0.60	GI041	S08
S25T-SCLCR 09	25	32	17	23	23	300	-	-3	0	-	1.10	GI041	S08
A32S-SCLCR 12-A	32	40	22	30	30	250	8	-10	0	✓	1.35	GI011	SC20
S32U-SCLCR 12-A	32	40	22	30	30	350	-	-10	0	-	2.10	GI011	SC20
L A08H-SCLCL 06	8	11	6	7.2	7.6	100	-	-13	0	✓	0.06	GI045	S02
S08F-SCLCL 06	8	11	6	7.2	7.6	80	-	-13	0	-	0.05	GI045	S02
A10H-SCLCL 06	10	13	7	9	-	100	4	-10	0	✓	0.06	GI045	S02
S10H-SCLCL 06	10	13	7	9	9.5	100	-	-10	0	-	0.06	GI045	S02
A12K-SCLCL 06	12	16	9	11	-	125	5	-8	0	✓	0.10	GI045	S01
S12K-SCLCL 06	12	16	9	11	11.5	125	-	-8	0	-	0.11	GI045	S01
S16M-SCLCL 06	16	20	11	14.5	15	150	-	-8	0	-	0.26	GI045	S01
A10K-SCLCL 08	10	12	6	9	9.5	125	4	-14	0	✓	0.02	GI232	SC22
A12M-SCLCL 08	12	16	9	11	11.5	150	5	-5	0	✓	0.14	GI232	SC22



Product	DCON MS	DMIN	WF	H	B	LF	CND	LAMS	GAMO				
	[mm]	[mm]	[mm]	[mm]	[mm]	[mm]	[mm]	[°]	[°]				
A16R-SCLCL 08	16	20	11	14	15	200	6	-8	0	✓	0.30	GI232	SC22
A16M-SCLCL 09-A	16	20	11	14.5	-	150	6	-8	0	✓	0.22	GI041	S05
S16M-SCLCL 09-A	16	20	11	14.5	15	150	-	-8	0	-	0.24	GI041	S05
A20Q-SCLCL 09	20	25	13	18	-	180	8	-5	0	✓	0.40	GI041	S08
S20S-SCLCL 09	20	25	13	18	18.5	250	-	-5	0	-	0.60	GI041	S08
A25R-SCLCL 09	25	32	17	23	23	200	8	-3	0	✓	0.67	GI041	S08
S25T-SCLCL 09	25	32	17	23	23	300	-	-3	0	-	1.15	GI041	S08
A32S-SCLCL 12-A	32	40	22	30	30	250	8	-10	0	✓	1.35	GI011	SC20
S32U-SCLCL 12-A	32	40	22	30	30	350	-	-10	0	-	2.10	GI011	SC20

L



GI011	CC.. 1204..
GI041	CC.. 09T3..
GI045	CC.. 0602..
GI232	CC.. 0803..



SC20	US 5012-T15P	5.0	M 5	12.2	SCN 120304	MS 5008	FLAG T15P	HXK 5
SC22	5513 020-04	1.5	M 3	7.2	-	-	PT-8003	-
S01	US 2506-T07P	0.9	M 2.5	6.3	-	-	FLAG T07P	-
S02	US 2505-T07P	0.9	M 2.5	5.2	-	-	FLAG T07P	-
S05	US 4008-T15P	3.5	M 4	8	-	-	FLAG T15P	-
S08	US 3510-T15P	3.0	M 3.5	10.6	-	-	FLAG T15P	-



SCXC(RL) INT



PRAMET

S



Internal Screw Lock Boring Bar with 40° Cutting Angle for CC.. Insert

Internal Right/Left hand boring bar, 40° cutting angle for screw type CC.. 06 inserts. Minimum internal turning diameter Ø13 mm. Suited for internal front and back chamfering, longitudinal turning without shoulder and taper turning. Available with shank size Ø10 up to Ø16 mm. Body treated for longer tool life.

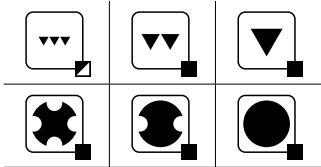
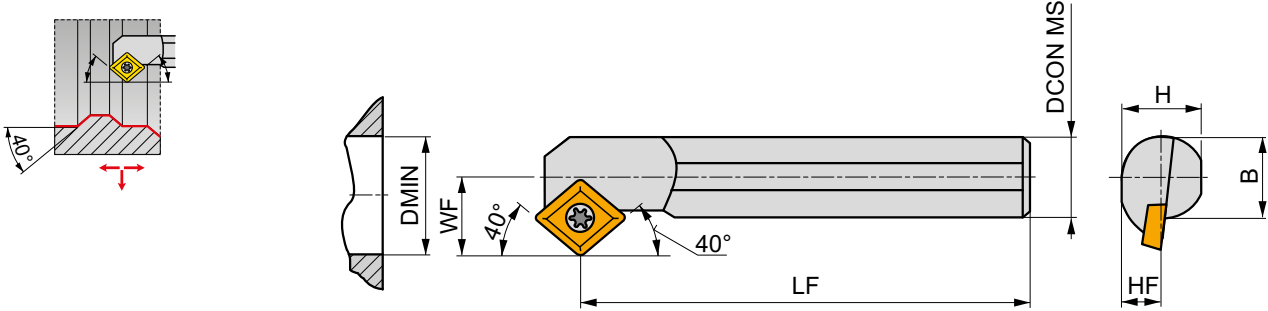

Product	DCON MS	DMIN	WF	H	B	LF	LAMS	GAMO	kg	Icons		
	[mm]	[mm]	[mm]	[mm]	[mm]	[mm]	[°]	[°]				
R	S10H-SCXCR 06	10	13	7	9	9.5	100	-10	0	0.06	GI045	S06
	S12K-SCXCR 06	12	16	9	11	11.5	125	-8	0	0.11	GI045	S06
	S16Q-SCXCR 06	16	20	11	14.5	15	180	-7	0	0.31	GI045	S07
L	S10H-SCXCL 06	10	13	7	9	9.5	100	-10	0	0.06	GI045	S06
	S12K-SCXCL 06	12	16	9	11	11.5	125	-8	0	0.11	GI045	S06
	S16Q-SCXCL 06	16	20	11	14.5	15	180	-7	0	0.30	GI045	S07

GI045	CC.. 0602..
-------	-------------

Icon	Icon	Nm	Icon	Icon	Icon
S06	US 2505-T07P	0.9	M 2.5	5.2	FLAGT07P
S07	US 2506-T07P	0.9	M 2.5	6.3	FLAGT07P



C.-SCLC(RL) INT

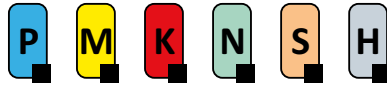

PRAMET

S



Internal PSC Quick Change Tool, Screw Lock, 95° Cutting Angle for CC.. Insert

Internal Right/Left hand tool, through coolant, with 95° cutting angle for screw type CC.. 09 inserts. Minimum internal turning diameter Ø20 mm. Suited for a wide range of internal turning applications. PSC shank (Polygon Shank Coupling) size C3 up to C5 with choice of lengths. Body treated for longer tool life.

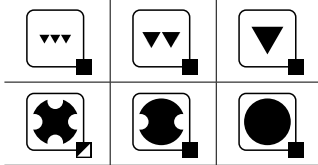
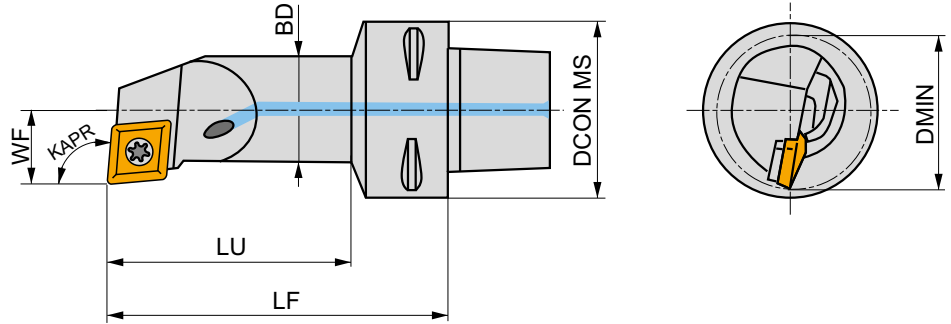
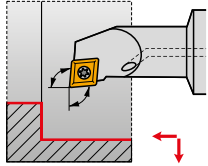

Product	DCON MS	DMIN	WF	LF	LU	BD	KAPR	LAMS	GAMO					
	[mm]	[mm]	[mm]	[mm]	[mm]	[mm]	[°]	[°]	[°]					
R	C3-SCLCR-11065-09	32	20	11	65	48	16	95	-8.4	0	✓	0.21	GI041	SC09M
	C3-SCLCR-13075-09	32	25	13	75	58	20	95	-5.8	0	✓	0.26	GI041	SC09M
	C4-SCLCR-11070-09	40	20	11	70	47	16	95	-8.4	0	✓	0.36	GI041	SC09M
	C4-SCLCR-13080-09	40	25	13	80	57	20	95	-5.8	0	✓	0.41	GI041	SC09M
	C4-SCLCR-17090-09	40	32	17	90	68	25	95	-3.4	0	✓	0.50	GI041	SC09M
	C5-SCLCR-11070-09	50	20	11	70	46	16	95	-8.4	0	✓	0.55	GI041	SC09M
L	C5-SCLCR-13080-09	50	25	13	80	56	20	95	-5.8	0	✓	0.60	GI041	SC09M
	C4-SCLCL-11070-09	40	20	11	70	47	16	95	-8.4	0	✓	0.36	GI041	SC09M
	C4-SCLCL-13080-09	40	25	13	80	57	20	95	-5.8	0	✓	0.62	GI041	SC09M
	C5-SCLCL-11070-09	50	20	11	70	46	16	95	-8.4	0	✓	0.55	GI041	SC09M
	C5-SCLCL-13080-09	50	25	13	80	56	20	95	-5.8	0	✓	0.60	GI041	SC09M



GI041



CC..09T3..



SC09M



US 2009-T15P



Nm

3.0



M 3.5



8.1



FLAGT15P/3,5



CP

05

CARBIDE INSERTS

CPGX

 83







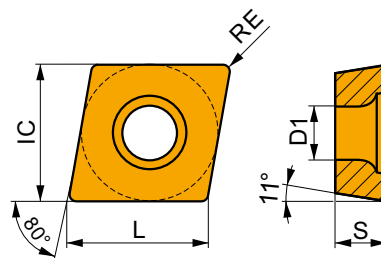



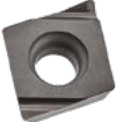
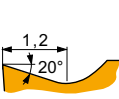

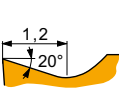
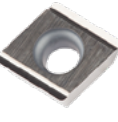
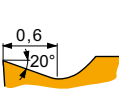
CPGX

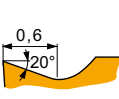
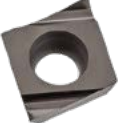
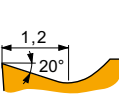
	IC	D1	L	S
	[mm]	[mm]	[mm]	[mm]
0602	6.350	2.80	6.40	2.38
0803	7.940	3.40	8.10	3.18
09T3	9.525	4.40	9.70	3.97

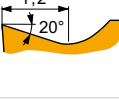

Suitability and starting values for cutting speed (vc), feed (f) and depth of cut (ap). Refer to our Machining Calculator app for further calculations.

Product	RE	[mm]	P			M			K			N			S			H		
			vc	f	ap	vc	f	ap	vc	f	ap	vc	f	ap	vc	f	ap	vc	f	ap
			[m/min]	[mm/rev]	[mm]	[m/min]	[mm/rev]	[mm]	[m/min]	[mm/rev]	[mm]	[m/min]	[mm/rev]	[mm]	[m/min]	[mm/rev]	[mm]	[m/min]	[mm/rev]	[mm]
		0.4	350	0.06	0.5	210	0.05	0.5	-	-	-	-	-	-	-	-	-	-	-	-
CPGX 080304FR-JQ	TT010	0.4	350	0.06	0.5	210	0.05	0.5	-	-	-	-	-	-	-	-	-	-	-	-
		0.4	350	0.06	0.5	210	0.05	0.5	-	-	-	-	-	-	-	-	-	-	-	-
CPGX 080304FL-JQ	TT010	0.4	350	0.06	0.5	210	0.05	0.5	-	-	-	-	-	-	-	-	-	-	-	-
		0.4	350	0.06	0.5	210	0.05	0.5	-	-	-	-	-	-	-	-	-	-	-	-
CPGX 09T304FL-JQ	TT010	0.4	350	0.06	0.5	210	0.05	0.5	-	-	-	-	-	-	-	-	-	-	-	-
		0.4	350	0.06	0.5	210	0.05	0.5	-	-	-	-	-	-	-	-	-	-	-	-
CPGX 060204FR-JR	TT010	0.4	350	0.06	0.5	210	0.05	0.5	-	-	-	-	-	-	-	-	-	-	-	-
		0.4	350	0.06	0.5	210	0.05	0.5	-	-	-	-	-	-	-	-	-	-	-	-
CPGX 080304FR-JR	TT010	0.4	350	0.06	0.5	210	0.05	0.5	-	-	-	-	-	-	-	-	-	-	-	-
		0.4	350	0.06	0.5	210	0.05	0.5	-	-	-	-	-	-	-	-	-	-	-	-
CPGX 060204FL-JR	TT010	0.4	350	0.06	0.5	210	0.05	0.5	-	-	-	-	-	-	-	-	-	-	-	-
		0.4	350	0.06	0.5	210	0.05	0.5	-	-	-	-	-	-	-	-	-	-	-	-
CPGX 080304FL-JR	TT010	0.4	350	0.06	0.5	210	0.05	0.5	-	-	-	-	-	-	-	-	-	-	-	-
		0.2	330	0.06	0.5	195	0.05	0.5	-	-	-	-	-	-	-	-	-	-	-	-
CPGX 060202FR-JZ	TT010	0.2	330	0.06	0.5	195	0.05	0.5	-	-	-	-	-	-	-	-	-	-	-	-
		0.2	330	0.06	0.5	195	0.05	0.5	-	-	-	-	-	-	-	-	-	-	-	-
CPGX 080302FR-JZ	TT010	0.2	330	0.06	0.5	195	0.05	0.5	-	-	-	-	-	-	-	-	-	-	-	-



DC

07 / 11 / 15

CARBIDE INSERTS

DCGT	DCMT	DCMW
86	87	92

CBN & PCD INSERTS

DCGW CBN	DCMW PCD
92	93

MATCH THE RIGHT SIZE (example)

Insert	Tool Holder
DCMT 070204E-UR	SDJCR 0808 D 07

ISO TURNING – EXTERNAL

SDJC(RL) EXT		SDNCN EXT		C.-SDNCN EXT		C.-SDJC(RL) EXT	
93°	DC..	62°30'	DC..	62°30'	DC..	93°	DC..
07 11 15		7 11		11		11	
08×08 25×25		08×08 25×25		C4 C5		C3 C5	
94	86–93	95	86–93	97	86–93	96	86–93



DC

07 / 11 / 15

ISO TURNING – INTERNAL

SDQC(RL) INT

107°30'

DC..

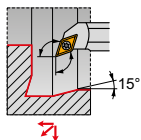
07
1113
40

98

86 – 93

SDUC(RL) INT

93°

DC..

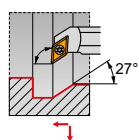
07
1113
40

99

86 – 93

SDUC(RL)-E INT

93°

DC..

07
1113
40

100

86 – 93

SDZC(RL) INT

93°

DC..

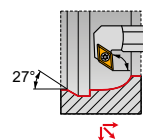
07
1127
65

101

86 – 93

C-SDUC(RL) INT

93°

DC..

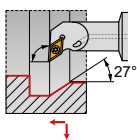
07
1120
32

102

86 – 93



DCGT



	IC	D1	L	S
	[mm]	[mm]	[mm]	[mm]
0702	6.350	2.80	7.80	2.38
0702-SF3	6.350	2.80	7.80	2.58
11T3	9.525	4.40	11.60	3.97
11T3-SF3	9.525	4.40	11.60	4.22

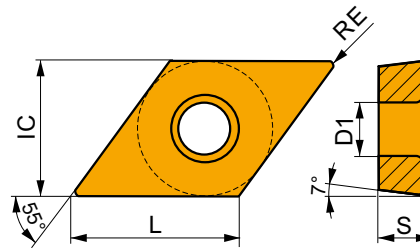

Suitability and starting values for cutting speed (vc), feed (f) and depth of cut (ap). Refer to our Machining Calculator app for further calculations.

Product	RE	P			M			K			N			S			H		
		vc	f	ap	vc	f	ap	vc	f	ap	vc	f	ap	vc	f	ap	vc	f	ap
	[mm]	[m/min]	[mm/rev]	[mm]	[m/min]	[mm/rev]	[mm]	[m/min]	[mm/rev]	[mm]	[m/min]	[mm/rev]	[mm]	[m/min]	[mm/rev]	[mm]	[m/min]	[mm/rev]	[mm]



AL geometry with highly positive design for fine-finish to rough machining, and continuous to slightly interrupted cuts.

DCGT 070202F-AL	HF7	0.2	-	-	-	-	-	-	-	-	-	360	0.12	1.0	-	-	-	-	-	-
	T0315	0.2	-	-	-	-	-	-	-	-	-	510	0.12	1.0	-	-	-	-	-	-
DCGT 070204F-AL	HF7	0.4	-	-	-	-	-	-	-	-	-	285	0.24	1.0	-	-	-	-	-	-
	T0315	0.4	-	-	-	-	-	-	-	-	-	420	0.24	1.0	-	-	-	-	-	-
DCGT 11T302F-AL	HF7	0.2	-	-	-	-	-	-	-	-	-	345	0.12	1.5	-	-	-	-	-	-
	T0315	0.2	-	-	-	-	-	-	-	-	-	495	0.12	1.5	-	-	-	-	-	-
DCGT 11T304F-AL	HF7	0.4	-	-	-	-	-	-	-	-	-	270	0.24	1.5	-	-	-	-	-	-
	T0315	0.4	-	-	-	-	-	-	-	-	-	390	0.24	1.5	-	-	-	-	-	-
DCGT 11T308F-AL	HF7	0.8	-	-	-	-	-	-	-	-	-	255	0.48	1.5	-	-	-	-	-	-
	T0315	0.8	-	-	-	-	-	-	-	-	-	360	0.48	1.5	-	-	-	-	-	-

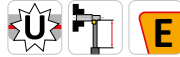
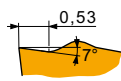

FF2 geometry with positive design for fine-finish to finish machining, and continuous to slightly interrupted cuts.

DCGT 11T302E-FF2	T7325	0.2	190	0.05	0.8	-	-	-	-	-	-	-	-	-	-	-	-	-	-	-
	T8330	0.2	165	0.05	0.8	-	-	-	155	0.05	0.8	-	-	-	-	-	-	-	-	-
	T8430	0.2	225	0.05	0.8	-	-	-	185	0.05	0.8	-	-	-	-	-	-	-	-	-
	T9325	0.2	280	0.05	0.8	-	-	-	265	0.05	0.8	-	-	-	-	-	-	-	-	-
	TT010	0.2	275	0.05	0.5	-	-	-	-	-	-	-	-	-	-	-	-	-	-	-

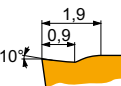

NF1 geometry with positive design for fine-finish to medium machining, and continuous cuts.

DCGT 11T304E-NF1	T6310	0.4	145	0.10	0.8	100	0.09	0.8	-	-	-	435	0.12	0.8	40	0.07	0.6	25	0.15	1.0
	T7325	0.4	165	0.10	0.8	125	0.09	0.8	-	-	-	-	-	-	50	0.07	0.6	-	-	-
DCGT 11T308E-NF1	T6310	0.8	155	0.14	0.8	110	0.13	0.8	-	-	-	465	0.17	0.8	45	0.13	0.6	30	0.15	1.0
	T7325	0.8	180	0.14	0.8	140	0.13	0.8	-	-	-	-	-	-	55	0.13	0.6	-	-	-

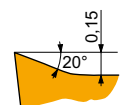

SF3 geometry with highly positive design for fine to finish machining, and continuous cuts.

DCGT 070201E-SF3	T6310	0.1	160	0.05	0.5	115	0.05	0.5	125	0.05	0.5	480	0.06	0.5	45	0.04	0.4	30	0.15	1.0
DCGT 070202E-SF3	H07	0.2	-	-	-	95	0.05	0.8	150	0.05	0.8	485	0.06	0.8	45	0.04	0.6	-	-	-
	T6310	0.2	165	0.05	0.8	115	0.05	0.8	130	0.05	0.8	495	0.06	0.8	45	0.04	0.6	30	0.15	1.0
	T8315	0.2	175	0.05	0.8	105	0.05	0.8	165	0.05	0.8	525	0.06	0.8	40	0.04	0.6	35	0.15	1.0
DCGT 070204E-SF3	H07	0.4	-	-	-	75	0.09	0.8	120	0.10	0.8	390	0.12	0.8	35	0.07	0.6	-	-	-
	T6310	0.4	145	0.10	0.8	100	0.09	0.8	115	0.10	0.8	435	0.12	0.8	40	0.07	0.6	25	0.15	1.0
	T8315	0.4	155	0.10	0.8	90	0.09	0.8	145	0.10	0.8	465	0.12	0.8	35	0.07	0.6	30	0.15	1.0
DCGT 11T301E-SF3	T6310	0.1	160	0.05	0.5	115	0.05	0.5	125	0.05	0.5	480	0.06	0.5	45	0.04	0.4	30	0.15	1.0



Suitability and starting values for cutting speed (vc), feed (f) and depth of cut (ap). Refer to our Machining Calculator app for further calculations.

Product	RE [mm]	P			M			K			N			S			H		
		vc [m/min]	f [mm/rev]	ap [mm]	vc [m/min]	f [mm/rev]	ap [mm]	vc [m/min]	f [mm/rev]	ap [mm]	vc [m/min]	f [mm/rev]	ap [mm]	vc [m/min]	f [mm/rev]	ap [mm]	vc [m/min]	f [mm/rev]	ap [mm]

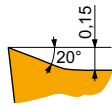

SF3 geometry with highly positive design for fine to finish machining, and continuous cuts.

DCGT 11T302E-SF3	H07	0.2	–	–	–	95	0.05	0.8	150	0.05	0.8	485	0.06	0.8	45	0.04	0.6	–	–	–
	T6310	0.2	165	0.05	0.8	115	0.05	0.8	130	0.05	0.8	495	0.06	0.8	45	0.04	0.6	30	0.15	1.0
DCGT 11T304E-SF3	H07	0.4	–	–	–	75	0.09	0.8	120	0.10	0.8	390	0.12	0.8	35	0.07	0.6	–	–	–
	T6310	0.4	145	0.10	0.8	100	0.09	0.8	115	0.10	0.8	435	0.12	0.8	40	0.07	0.6	25	0.15	1.0
	T8315	0.4	155	0.10	0.8	90	0.09	0.8	145	0.10	0.8	465	0.12	0.8	35	0.07	0.6	30	0.15	1.0
DCGT 11T308E-SF3	H07	0.8	–	–	–	90	0.09	0.8	145	0.10	0.8	455	0.12	0.8	45	0.08	0.6	–	–	–
	T6310	0.8	170	0.10	0.8	120	0.09	0.8	135	0.10	0.8	510	0.12	0.8	50	0.08	0.6	30	0.15	1.0
	T8315	0.8	180	0.10	0.8	105	0.09	0.8	170	0.10	0.8	540	0.12	0.8	45	0.08	0.6	35	0.15	1.0

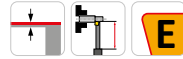
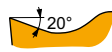

ER-SI geometry with positive right-handed design for fine-finish machining, and continuous cuts.

DCGT 11T304ER-SI	T8330	0.4	170	0.12	0.8	100	0.11	0.8	160	0.12	0.8	–	–	–	40	0.10	0.6	–	–	–
	T8430	0.4	205	0.12	0.8	110	0.11	0.8	170	0.12	0.8	–	–	–	45	0.10	0.6	–	–	–
DCGT 11T308ER-SI	T8330	0.8	170	0.22	1.0	100	0.20	1.0	160	0.22	1.0	–	–	–	40	0.18	0.8	–	–	–
	T8430	0.8	190	0.22	1.0	105	0.20	1.0	155	0.22	1.0	–	–	–	40	0.18	0.8	–	–	–



EL-SI geometry with positive left-handed design for fine-finish machining, and continuous cuts.

DCGT 11T304EL-SI	T8330	0.4	170	0.12	0.8	100	0.11	0.8	160	0.12	0.8	–	–	–	40	0.10	0.6	–	–	–
	T8430	0.4	205	0.12	0.8	110	0.11	0.8	170	0.12	0.8	–	–	–	45	0.10	0.6	–	–	–
DCGT 11T308EL-SI	T8430	0.8	190	0.22	1.0	105	0.20	1.0	155	0.22	1.0	–	–	–	40	0.18	0.8	–	–	–

DCMT



	IC [mm]	D1 [mm]	L [mm]	S [mm]
0702	6.350	2.80	7.80	2.38
11T3	9.525	4.40	11.60	3.97
1504	12.700	5.50	15.50	4.76

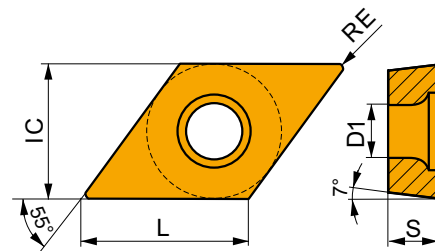

Suitability and starting values for cutting speed (vc), feed (f) and depth of cut (ap). Refer to our Machining Calculator app for further calculations.

Product	RE [mm]	P			M			K			N			S			H		
		vc [m/min]	f [mm/rev]	ap [mm]	vc [m/min]	f [mm/rev]	ap [mm]	vc [m/min]	f [mm/rev]	ap [mm]	vc [m/min]	f [mm/rev]	ap [mm]	vc [m/min]	f [mm/rev]	ap [mm]	vc [m/min]	f [mm/rev]	ap [mm]

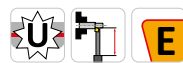
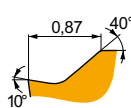

FF geometry with positive design for fine-finish to finish machining, and continuous to slightly interrupted cuts.

DCMT 11T302E-FF	T8315	0.2	160	0.10	0.8	95	0.09	0.8	–	–	–	–	–	–	–	–	–	–	–	–
	T8330	0.2	150	0.10	0.8	90	0.09	0.8	–	–	–	–	–	–	–	–	–	–	–	–
	T8430	0.2	185	0.10	0.8	100	0.09	0.8	–	–	–	–	–	–	–	–	–	–	–	–
	T9315	0.2	255	0.10	0.8	–	–	–	–	–	–	–	–	–	–	–	–	–	–	–



Suitability and starting values for cutting speed (vc), feed (f) and depth of cut (ap). Refer to our Machining Calculator app for further calculations.

Product	RE  (mm)	P			M			K			N			S			H		
		vc [m/min]	f [mm/rev]	ap [mm]	vc [m/min]	f [mm/rev]	ap [mm]	vc [m/min]	f [mm/rev]	ap [mm]	vc [m/min]	f [mm/rev]	ap [mm]	vc [m/min]	f [mm/rev]	ap [mm]	vc [m/min]	f [mm/rev]	ap [mm]

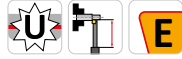
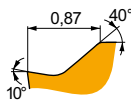

FF geometry with positive design for fine-finish to finish machining, and continuous to slightly interrupted cuts.

DCMT 11T304E-FF	T8315	0.4	✓	160	0.12	0.8	✓	95	0.11	0.8	–	–	–	–	–	–	–	–	–
	T8330	0.4	■	150	0.12	0.8	✓	90	0.11	0.8	–	–	–	–	–	–	–	–	–
	T8430	0.4	■	185	0.12	0.8	✓	100	0.11	0.8	–	–	–	–	–	–	–	–	–
	T9315	0.4	■	255	0.12	0.8	–	–	–	–	–	–	–	–	–	–	–	–	–
DCMT 11T308E-FF	T8315	0.8	✓	180	0.15	0.8	✓	105	0.14	0.8	–	–	–	–	–	–	–	–	–
	T8330	0.8	■	170	0.15	0.8	✓	100	0.14	0.8	–	–	–	–	–	–	–	–	–
	T8430	0.8	■	200	0.15	0.8	✓	110	0.14	0.8	–	–	–	–	–	–	–	–	–
	T9315	0.8	■	270	0.15	0.8	–	–	–	–	–	–	–	–	–	–	–	–	–

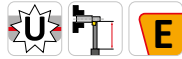
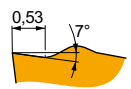

FF2 geometry with positive design for fine-finish to finish machining, and continuous to slightly interrupted cuts.

DCMT 070202E-FF2	T7325	0.2	✓	190	0.05	0.8	–	–	–	–	–	–	–	–	–	–	–	–
	T8330	0.2	■	165	0.05	0.8	–	–	–	■	155	0.05	0.8	–	–	–	–	–
	T8430	0.2	■	225	0.05	0.8	–	–	–	✓	185	0.05	0.8	–	–	–	–	–
	T9325	0.2	■	280	0.05	0.8	–	–	–	✓	265	0.05	0.8	–	–	–	–	–
	TT010	0.2	■	275	0.05	0.5	–	–	–	–	–	–	–	–	–	–	–	–
DCMT 070204E-FF2	T7325	0.4	✓	160	0.12	0.8	–	–	–	–	–	–	–	–	–	–	–	–
	T8330	0.4	■	135	0.12	0.8	–	–	–	■	125	0.12	0.8	–	–	–	–	–
	T8430	0.4	■	170	0.12	0.8	–	–	–	✓	135	0.12	0.8	–	–	–	–	–
	T9315	0.4	■	230	0.12	0.8	–	–	–	✓	215	0.12	0.8	–	–	–	–	–
	T9325	0.4	■	205	0.12	0.8	–	–	–	✓	190	0.12	0.8	–	–	–	–	–
DCMT 070208E-FF2	T7325	0.8	✓	170	0.17	0.8	–	–	–	–	–	–	–	–	–	–	–	–
	T8330	0.8	■	150	0.17	0.8	–	–	–	■	140	0.17	0.8	–	–	–	–	–
	T8430	0.8	■	175	0.17	0.8	–	–	–	✓	140	0.17	0.8	–	–	–	–	–
	T9315	0.8	■	235	0.17	0.8	–	–	–	✓	220	0.17	0.8	–	–	–	–	–
	T9325	0.8	■	215	0.17	0.8	–	–	–	✓	200	0.17	0.8	–	–	–	–	–
DCMT 11T304E-FF2	T7325	0.4	✓	160	0.12	0.8	–	–	–	–	–	–	–	–	–	–	–	–
	T8330	0.4	■	135	0.12	0.8	–	–	–	■	125	0.12	0.8	–	–	–	–	–
	T8430	0.4	■	170	0.12	0.8	–	–	–	✓	135	0.12	0.8	–	–	–	–	–
	T9315	0.4	■	230	0.12	0.8	–	–	–	✓	215	0.12	0.8	–	–	–	–	–
	T9325	0.4	■	205	0.12	0.8	–	–	–	✓	190	0.12	0.8	–	–	–	–	–
	T9335	0.4	■	175	0.12	0.8	–	–	–	–	–	–	–	–	–	–	–	–
DCMT 11T308E-FF2	TT010	0.4	■	280	0.06	0.5	–	–	–	–	–	–	–	–	–	–	–	–
	T7325	0.8	✓	170	0.17	0.8	–	–	–	–	–	–	–	–	–	–	–	–
	T8330	0.8	■	150	0.17	0.8	–	–	–	■	140	0.17	0.8	–	–	–	–	–
	T8430	0.8	■	175	0.17	0.8	–	–	–	✓	140	0.17	0.8	–	–	–	–	–
	T9315	0.8	■	235	0.17	0.8	–	–	–	✓	220	0.17	0.8	–	–	–	–	–

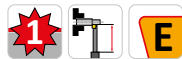

FM geometry for finish to semi-rough machining, and continuous to slightly interrupted cuts.

DCMT 070202E-FM	T7325	0.2	✓	175	0.10	0.8	■	135	0.09	0.8	–	–	–	–	–	–	–	–	
	T8315	0.2	✓	160	0.10	0.8	■	95	0.09	0.8	✓	150	0.10	0.8	✓	480	0.12	0.8	–
	T8330	0.2	■	150	0.10	0.8	■	90	0.09	0.8	✓	140	0.10	0.8	✓	450	0.12	0.8	–
	T8430	0.2	■	185	0.10	0.8	■	100	0.09	0.8	✓	150	0.10	0.8	✓	510	0.12	0.8	–
	T9315	0.2	■	255	0.10	0.8	–	–	–	–	–	–	–	–	–	–	–	–	
	T9325	0.2	■	230	0.10	0.8	■	135	0.09	0.8	✓	215	0.10	0.8	–	–	–	–	



Suitability and starting values for cutting speed (vc), feed (f) and depth of cut (ap). Refer to our Machining Calculator app for further calculations.

Product	RE [mm]	P			M			K			N			S			H		
		vc [m/min]	f [mm/rev]	ap [mm]	vc [m/min]	f [mm/rev]	ap [mm]	vc [m/min]	f [mm/rev]	ap [mm]	vc [m/min]	f [mm/rev]	ap [mm]	vc [m/min]	f [mm/rev]	ap [mm]	vc [m/min]	f [mm/rev]	ap [mm]

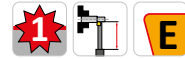
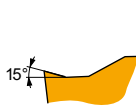

FM geometry for finish to semi-rough machining, and continuous to slightly interrupted cuts.

DCMT 070204E-FM	T7325	0.4	155	0.17	0.8	120	0.15	0.8	-	-	-	-	-	-	-	-	-	-
	T7335	0.4	155	0.17	0.8	120	0.15	0.8	-	-	-	-	-	-	-	-	-	-
	T8315	0.4	160	0.12	0.8	95	0.11	0.8	150	0.12	0.8	480	0.14	0.8	-	-	-	-
	T8330	0.4	150	0.12	0.8	90	0.11	0.8	140	0.12	0.8	450	0.14	0.8	-	-	-	-
	T8430	0.4	185	0.12	0.8	100	0.11	0.8	150	0.12	0.8	510	0.14	0.8	-	-	-	-
	T9315	0.4	255	0.12	0.8	-	-	-	240	0.12	0.8	-	-	-	-	-	-	-
DCMT 11T302E-FM	T7325	0.2	175	0.10	0.8	135	0.09	0.8	-	-	-	-	-	-	-	-	-	-
	T8315	0.2	160	0.10	0.8	95	0.09	0.8	150	0.10	0.8	480	0.12	0.8	-	-	-	-
	T8330	0.2	150	0.10	0.8	90	0.09	0.8	140	0.10	0.8	450	0.12	0.8	-	-	-	-
	T8430	0.2	185	0.10	0.8	100	0.09	0.8	150	0.10	0.8	510	0.12	0.8	-	-	-	-
	T9315	0.2	255	0.10	0.8	-	-	-	240	0.10	0.8	-	-	-	-	-	-	-
	T9325	0.2	230	0.10	0.8	135	0.09	0.8	215	0.10	0.8	-	-	-	-	-	-	-
DCMT 11T304E-FM	T7325	0.4	155	0.17	0.8	120	0.15	0.8	-	-	-	-	-	-	-	-	-	-
	T7335	0.4	155	0.17	0.8	120	0.15	0.8	-	-	-	-	-	-	-	-	-	-
	T8315	0.4	160	0.12	0.8	95	0.11	0.8	150	0.12	0.8	480	0.14	0.8	-	-	-	-
	T8330	0.4	135	0.17	0.8	80	0.15	0.8	125	0.17	0.8	405	0.20	0.8	-	-	-	-
	T8430	0.4	155	0.17	0.8	85	0.15	0.8	130	0.17	0.8	435	0.20	0.8	-	-	-	-
	T9310	0.4	285	0.12	0.8	-	-	-	270	0.12	0.8	-	-	-	-	-	-	-
	T9315	0.4	255	0.12	0.8	-	-	-	240	0.12	0.8	-	-	-	-	-	-	-
	T9325	0.4	190	0.18	0.8	110	0.16	0.8	180	0.18	0.8	-	-	-	-	-	-	-
DCMT 11T308E-FM	T7325	0.8	185	0.17	0.8	140	0.15	0.8	-	-	-	-	-	-	-	-	-	-
	T7335	0.8	180	0.17	0.8	140	0.15	0.8	-	-	-	-	-	-	-	-	-	-
	T8315	0.8	170	0.17	0.8	100	0.15	0.8	160	0.17	0.8	510	0.20	0.8	-	-	-	-
	T8330	0.8	165	0.17	0.8	95	0.15	0.8	155	0.17	0.8	495	0.20	0.8	-	-	-	-
	T8430	0.8	190	0.17	0.8	105	0.15	0.8	155	0.17	0.8	525	0.20	0.8	-	-	-	-
	T9310	0.8	285	0.17	0.8	-	-	-	270	0.17	0.8	-	-	-	-	-	-	-
	T9315	0.8	260	0.17	0.8	-	-	-	245	0.17	0.8	-	-	-	-	-	-	-
	T9325	0.8	235	0.17	0.8	140	0.15	0.8	220	0.17	0.8	-	-	-	-	-	-	-
DCMT 11T312E-FM	T8330	1.2	150	0.22	1.2	90	0.22	1.2	140	0.22	1.2	450	0.26	1.2	-	-	-	-
	T8430	1.2	175	0.22	1.2	95	0.22	1.2	140	0.22	1.2	480	0.26	1.2	-	-	-	-
	T9315	1.2	235	0.22	1.2	-	-	-	220	0.22	1.2	-	-	-	-	-	-	-
	T9325	1.2	210	0.22	1.2	125	0.22	1.2	195	0.22	1.2	-	-	-	-	-	-	-

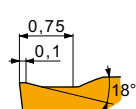

FM2 geometry for finish to medium machining, and continuous to interrupted cuts.

DCMT 070204E-FM2	T6310	0.4	135	0.12	0.8	95	0.11	0.8	105	0.12	0.8	-	-	-	-	-	-	-
	T7325	0.4	160	0.12	0.8	120	0.11	0.8	-	-	-	-	-	-	-	-	-	-
	T8330	0.4	135	0.12	0.8	80	0.11	0.8	125	0.12	0.8	-	-	-	-	-	-	-
	T8430	0.4	170	0.12	0.8	90	0.11	0.8	135	0.12	0.8	-	-	-	-	-	-	-
	T9315	0.4	230	0.12	0.8	-	-	-	215	0.12	0.8	-	-	-	-	-	-	-
DCMT 11T304E-FM2	T9325	0.4	205	0.12	0.8	120	0.11	0.8	190	0.12	0.8	-	-	-	-	-	-	-
	T6310	0.4	135	0.12	0.8	95	0.11	0.8	105	0.12	0.8	-	-	-	-	-	-	-
	T7325	0.4	160	0.12	0.8	120	0.11	0.8	-	-	-	-	-	-	-	-	-	-
	T8330	0.4	135	0.12	0.8	80	0.11	0.8	125	0.12	0.8	-	-	-	-	-	-	-
	T8430	0.4	170	0.12	0.8	90	0.11	0.8	135	0.12	0.8	-	-	-	-	-	-	-
	T9315	0.4	230	0.12	0.8	-	-	-	215	0.12	0.8	-	-	-	-	-	-	-
	T9325	0.4	205	0.12	0.8	120	0.11	0.8	190	0.12	0.8	-	-	-	-	-	-	-
	T9335	0.4	175	0.12	0.8	105	0.11	0.8	-	-	-	-	-	-	-	-	-	-



Suitability and starting values for cutting speed (vc), feed (f) and depth of cut (ap). Refer to our Machining Calculator app for further calculations.

Product	RE  (mm)	P			M			K			N			S			H		
		vc [m/min]	f [mm/rev]	ap [mm]	vc [m/min]	f [mm/rev]	ap [mm]	vc [m/min]	f [mm/rev]	ap [mm]	vc [m/min]	f [mm/rev]	ap [mm]	vc [m/min]	f [mm/rev]	ap [mm]	vc [m/min]	f [mm/rev]	ap [mm]

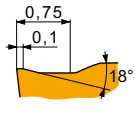

FM2 geometry for finish to medium machining, and continuous to interrupted cuts.

DCMT 11T308E-FM2	T6310	0.8	█	150	0.17	0.8	█	105	0.15	0.8	█	120	0.17	0.8	–	–	–	–	–	–
	T7325	0.8	█	170	0.17	0.8	█	130	0.15	0.8	–	–	–	–	–	–	–	–	–	–
	T8330	0.8	█	150	0.17	0.8	█	90	0.15	0.8	█	140	0.17	0.8	–	–	–	–	–	–
	T8430	0.8	█	175	0.17	0.8	█	95	0.15	0.8	█	140	0.17	0.8	–	–	–	–	–	–
	T9315	0.8	█	235	0.17	0.8	–	–	–	–	█	220	0.17	0.8	–	–	–	–	–	–
	T9325	0.8	█	215	0.17	0.8	█	125	0.15	0.8	█	200	0.17	0.8	–	–	–	–	–	–
	T9335	0.8	█	180	0.17	0.8	█	105	0.15	0.8	–	–	–	–	–	–	–	–	–	–
DCMT 11T312E-FM2	T8430	1.2	█	155	0.22	1.2	█	85	0.20	1.2	█	130	0.22	1.2	–	–	–	–	–	–
	T9325	1.2	█	190	0.22	1.2	█	110	0.20	1.2	█	180	0.22	1.2	–	–	–	–	–	–
DCMT 150408E-FM2	T9315	0.8	█	205	0.20	1.5	–	–	–	–	█	190	0.20	1.5	–	–	–	–	–	–
	T9325	0.8	█	185	0.20	1.5	█	110	0.18	1.5	█	175	0.20	1.5	–	–	–	–	–	–
	T9335	0.8	█	160	0.20	1.5	█	95	0.18	1.5	–	–	–	–	–	–	–	–	–	

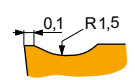

RF geometry for semi-rough to rough machining, and continuous to interrupted cuts.

DCMT 11T304E-RF	T5315	0.4	█	175	0.20	0.8	–	–	–	–	█	165	0.20	0.8	–	–	–	–	█	35	0.15	1.0	
	T7335	0.4	█	115	0.20	0.8	█	85	0.18	0.8	–	–	–	–	–	–	–	–	–	–	–		
	T9325	0.4	█	150	0.20	0.8	█	90	0.18	0.8	█	140	0.20	0.8	–	–	–	–	–	–	–		
DCMT 11T308E-RF	T5315	0.8	█	205	0.20	0.8	–	–	–	–	█	190	0.20	0.8	–	–	–	–	–	█	40	0.15	1.0
	T7335	0.8	█	140	0.20	0.8	█	105	0.18	0.8	–	–	–	–	–	–	–	–	–	–	–		
	T9325	0.8	█	175	0.20	0.8	█	105	0.18	0.8	█	165	0.20	0.8	–	–	–	–	–	–	–		

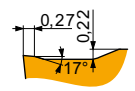

RM geometry for semi-rough to rough machining, and continuous to interrupted cuts.

DCMT 11T304E-RM	T5305	0.4	█	225	0.27	0.8	–	–	–	–	█	210	0.27	0.8	–	–	–	–	–	█	45	0.15	1.0	
	T5315	0.4	█	205	0.27	0.8	–	–	–	–	█	190	0.27	0.8	–	–	–	–	–	█	40	0.15	1.0	
	T7335	0.4	█	135	0.27	0.8	█	105	0.24	0.8	–	–	–	–	█	40	0.19	0.6	–	–	–			
	T8330	0.4	█	125	0.27	0.8	█	75	0.24	0.8	█	115	0.27	0.8	–	–	–	–	–	█	25	0.15	1.0	
	T8430	0.4	█	135	0.27	0.8	█	75	0.24	0.8	█	110	0.27	0.8	–	–	–	–	–	█	20	0.15	1.0	
	T9315	0.4	█	185	0.27	0.8	–	–	–	–	█	175	0.27	0.8	–	–	–	–	–	–	█	35	0.15	1.0
	T9325	0.4	█	165	0.27	0.8	█	95	0.24	0.8	█	155	0.27	0.8	–	–	–	–	–	–	█	35	0.19	0.6
DCMT 11T308E-RM	T5305	0.8	█	270	0.27	0.8	–	–	–	–	█	255	0.27	0.8	–	–	–	–	–	–	█	50	0.15	1.0
	T5315	0.8	█	240	0.27	0.8	–	–	–	–	█	225	0.27	0.8	–	–	–	–	–	–	█	45	0.15	1.0
	T7335	0.8	█	165	0.27	0.8	█	125	0.24	0.8	–	–	–	–	█	50	0.19	0.6	–	–	–			
	T8330	0.8	█	150	0.27	0.8	█	90	0.24	0.8	█	140	0.27	0.8	–	–	–	–	–	█	30	0.15	1.0	
	T8430	0.8	█	165	0.27	0.8	█	90	0.24	0.8	█	135	0.27	0.8	–	–	–	–	–	█	25	0.15	1.0	
	T9315	0.8	█	220	0.27	0.8	–	–	–	–	█	205	0.27	0.8	–	–	–	–	–	–	█	40	0.15	1.0
	T9325	0.8	█	200	0.27	0.8	█	120	0.24	0.8	█	190	0.27	0.8	–	–	–	–	–	–	█	45	0.19	0.6
DCMT 11T312E-RM	T7335	1.2	█	165	0.27	1.2	█	125	0.24	1.2	–	–	–	–	█	50	0.19	1.2	–	–	–			
	T8330	1.2	█	150	0.27	1.2	█	90	0.24	1.2	█	140	0.27	1.2	–	–	–	–	–	█	30	0.15	1.0	
	T8430	1.2	█	170	0.27	1.2	█	90	0.24	1.2	█	135	0.27	1.2	–	–	–	–	–	█	25	0.15	1.0	
	T9315	1.2	█	225	0.27	1.2	–	–	–	–	█	210	0.27	1.2	–	–	–	–	–	–	█	45	0.15	1.0
	T9325	1.2	█	200	0.27	1.2	█	120	0.24	1.2	█	190	0.27	1.2	–	–	–	–	–	–	█	45	0.19	1.2
DCMT 150408E-RM	T8330	0.8	█	135	0.27	1.9	█	80	0.24	1.9	█	125	0.27	1.9	–	–	–	–	–	█	25	0.15	1.0	
	T8430	0.8	█	150	0.27	1.9	█	80	0.24	1.9	█	125	0.27	1.9	–	–	–	–	–	█	25	0.15	1.0	
	T9315	0.8	█	200	0.27	1.9	–	–	–	–	█	190	0.27	1.9	–	–	–	–	–	–	█	40	0.15	1.0
	T9325	0.8	█	180	0.27	1.9	█	105	0.24	1.9	█	170	0.27	1.9	–	–	–	–	–	–	█	40	0.22	1.5



Suitability and starting values for cutting speed (vc), feed (f) and depth of cut (ap). Refer to our Machining Calculator app for further calculations.

Product	RE (mm)	P			M			K			N			S			H		
		vc (m/min)	f (mm/rev)	ap (mm)	vc (m/min)	f (mm/rev)	ap (mm)	vc (m/min)	f (mm/rev)	ap (mm)	vc (m/min)	f (mm/rev)	ap (mm)	vc (m/min)	f (mm/rev)	ap (mm)	vc (m/min)	f (mm/rev)	ap (mm)

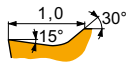

UR geometry for fine to finish machining, and continuous to slightly interrupted cuts.

DCMT 070202E-UR	T7325	0.2	150	0.10	0.8	115	0.09	0.8	-	-	-	-	-	-	-	-	-	-	
	T8315	0.2	135	0.10	0.8	80	0.09	0.8	125	0.10	0.8	-	-	-	-	-	-	-	
	T8330	0.2	130	0.10	0.8	75	0.09	0.8	120	0.10	0.8	-	-	-	-	-	-	-	
	T8430	0.2	155	0.10	0.8	85	0.09	0.8	130	0.10	0.8	-	-	-	-	-	-	-	
	T9315	0.2	220	0.10	0.8	-	-	-	205	0.10	0.8	-	-	-	-	-	-	-	-
	T9325	0.2	200	0.10	0.8	120	0.09	0.8	190	0.10	0.8	-	-	-	-	-	-	-	-
DCMT 070204E-UR	T7325	0.4	135	0.17	0.8	105	0.15	0.8	-	-	-	-	-	-	-	-	-	-	
	T8315	0.4	135	0.12	0.8	80	0.11	0.8	125	0.12	0.8	-	-	-	-	-	-	-	
	T8330	0.4	130	0.12	0.8	75	0.11	0.8	120	0.12	0.8	-	-	-	-	-	-	-	
	T8430	0.4	155	0.12	0.8	85	0.11	0.8	130	0.12	0.8	-	-	-	-	-	-	-	
	T9315	0.4	220	0.12	0.8	-	-	-	205	0.12	0.8	-	-	-	-	-	-	-	-
	T9325	0.4	165	0.18	0.8	95	0.16	0.8	155	0.18	0.8	-	-	-	-	-	-	-	-
DCMT 11T302E-UR	T7325	0.2	150	0.10	0.8	115	0.09	0.8	-	-	-	-	-	-	-	-	-	-	
	T8330	0.2	130	0.10	0.8	75	0.09	0.8	120	0.10	0.8	-	-	-	-	-	-	-	
	T8430	0.2	155	0.10	0.8	85	0.09	0.8	130	0.10	0.8	-	-	-	-	-	-	-	
	T9315	0.2	220	0.10	0.8	-	-	-	205	0.10	0.8	-	-	-	-	-	-	-	-
	T9325	0.2	200	0.10	0.8	120	0.09	0.8	190	0.10	0.8	-	-	-	-	-	-	-	-
	TT310	0.2	210	0.10	0.8	125	0.09	0.8	-	-	-	-	-	-	-	-	-	-	-
DCMT 11T304E-UR	T5315	0.4	220	0.12	0.8	-	-	-	205	0.12	0.8	-	-	-	-	-	-	-	
	T7325	0.4	135	0.17	0.8	105	0.15	0.8	-	-	-	-	-	-	-	-	-	-	
	T7335	0.4	130	0.17	0.8	100	0.15	0.8	-	-	-	-	-	-	-	-	-	-	
	T8315	0.4	135	0.12	0.8	80	0.11	0.8	125	0.12	0.8	-	-	-	-	-	-	-	
	T8330	0.4	130	0.12	0.8	75	0.11	0.8	120	0.12	0.8	-	-	-	-	-	-	-	
	T8430	0.4	155	0.12	0.8	85	0.11	0.8	130	0.12	0.8	-	-	-	-	-	-	-	
	T9315	0.4	220	0.12	0.8	-	-	-	205	0.12	0.8	-	-	-	-	-	-	-	-
	T9325	0.4	165	0.18	0.8	95	0.16	0.8	155	0.18	0.8	-	-	-	-	-	-	-	-
	TT310	0.4	210	0.12	0.8	125	0.11	0.8	-	-	-	-	-	-	-	-	-	-	-
	DCMT 11T308E-UR	T5315	0.8	230	0.17	0.8	-	-	-	215	0.17	0.8	-	-	-	-	-	-	-
T7325		0.8	160	0.17	0.8	120	0.15	0.8	-	-	-	-	-	-	-	-	-	-	
T7335		0.8	155	0.17	0.8	120	0.15	0.8	-	-	-	-	-	-	-	-	-	-	
T8315		0.8	145	0.17	0.8	85	0.15	0.8	135	0.17	0.8	-	-	-	-	-	-	-	
T8330		0.8	140	0.17	0.8	80	0.15	0.8	130	0.17	0.8	-	-	-	-	-	-	-	
T8430		0.8	165	0.17	0.8	90	0.15	0.8	135	0.17	0.8	-	-	-	-	-	-	-	
T9315		0.8	225	0.17	0.8	-	-	-	210	0.17	0.8	-	-	-	-	-	-	-	
T9325		0.8	200	0.17	0.8	120	0.15	0.8	190	0.17	0.8	-	-	-	-	-	-	-	
TT310		0.8	225	0.17	0.8	135	0.15	0.8	-	-	-	-	-	-	-	-	-	-	
DCMT 11T312E-UR		T9315	1.2	205	0.22	1.2	-	-	-	190	0.22	1.2	-	-	-	-	-	-	-
	T9325	1.2	180	0.22	1.2	105	0.20	1.2	170	0.22	1.2	-	-	-	-	-	-	-	

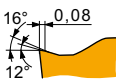

W-FM wiper geometry for fine to finish machining with increased feed rates and improved surface finish.

DCMX 11T304W-FM	T7325	0.4	130	0.30	0.8	100	0.27	0.8	-	-	-	-	-	-	-	-	-	
	T8330	0.4	115	0.30	0.8	65	0.27	0.8	105	0.30	0.8	-	-	-	-	-	-	
	T8430	0.4	130	0.30	0.8	70	0.27	0.8	105	0.30	0.8	-	-	-	-	-	-	
	T9315	0.4	170	0.30	0.8	-	-	-	160	0.30	0.8	-	-	-	-	-	-	-
	T9325	0.4	155	0.30	0.8	90	0.27	0.8	145	0.30	0.8	-	-	-	-	-	-	-
DCMX 11T308W-FM	T7325	0.8	140	0.40	1.0	105	0.36	1.0	-	-	-	-	-	-	-	-	-	
	T8430	0.8	130	0.40	1.0	70	0.36	1.0	105	0.40	1.0	-	-	-	-	-	-	
	T9315	0.8	175	0.40	1.0	-	-	-	165	0.40	1.0	-	-	-	-	-	-	
	T9325	0.8	160	0.40	1.0	95	0.36	1.0	150	0.40	1.0	-	-	-	-	-	-	



DCMW



	IC	D1	L	S
	[mm]	[mm]	[mm]	[mm]
0702	6.350	2.80	7.80	2.38
11T3	9.525	4.40	11.60	3.97

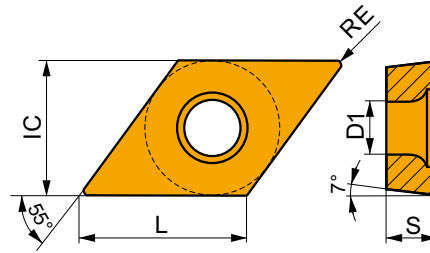

Suitability and starting values for cutting speed (vc), feed (f) and depth of cut (ap). Refer to our Machining Calculator app for further calculations.

Product	RE	P			M			K			N			S			H		
		vc	f	ap	vc	f	ap	vc	f	ap	vc	f	ap	vc	f	ap	vc	f	ap
	[mm]	[m/min]	[mm/rev]	[mm]	[m/min]	[mm/rev]	[mm]	[m/min]	[mm/rev]	[mm]	[m/min]	[mm/rev]	[mm]	[m/min]	[mm/rev]	[mm]	[m/min]	[mm/rev]	[mm]



For fine-finish to semi-rough machining, and continuous to slightly interrupted cuts.

DCMW 070202	T5305	0.2	-	-	-	-	-	-	200	0.08	0.8	-	-	-	-	-	-	40	0.15	1.0
	T6310	0.2	-	-	-	-	-	-	80	0.08	0.8	-	-	-	-	-	-	20	0.15	1.0
DCMW 070204	T5305	0.4	-	-	-	-	-	-	195	0.10	0.8	-	-	-	-	-	-	40	0.15	1.0
	T5315	0.4	-	-	-	-	-	-	175	0.10	0.8	-	-	-	-	-	-	35	0.15	1.0
	T6310	0.4	-	-	-	-	-	-	85	0.10	0.8	-	-	-	-	-	-	20	0.15	1.0
DCMW 11T304	T5305	0.4	-	-	-	-	-	-	190	0.10	1.2	-	-	-	-	-	-	40	0.15	1.0
	T5315	0.4	-	-	-	-	-	-	165	0.10	1.2	-	-	-	-	-	-	35	0.15	1.0
	T6310	0.4	-	-	-	-	-	-	80	0.10	1.2	-	-	-	-	-	-	20	0.15	1.0
DCMW 11T308	T5305	0.8	-	-	-	-	-	-	185	0.18	1.2	-	-	-	-	-	-	35	0.15	1.0
	T5315	0.8	-	-	-	-	-	-	160	0.18	1.2	-	-	-	-	-	-	30	0.15	1.0
	T6310	0.8	-	-	-	-	-	-	80	0.18	1.2	-	-	-	-	-	-	20	0.15	1.0

DCGW CBN



	IC	D1	L	S
	[mm]	[mm]	[mm]	[mm]
11T3	9.525	4.50	11.60	3.97

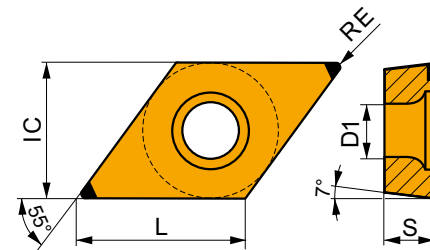

Suitability and starting values for cutting speed (vc), feed (f) and depth of cut (ap). Refer to our Machining Calculator app for further calculations.

Product	RE	P			M			K			N			S			H		
		vc	f	ap	vc	f	ap	vc	f	ap	vc	f	ap	vc	f	ap	vc	f	ap
	[mm]	[m/min]	[mm/rev]	[mm]	[m/min]	[mm/rev]	[mm]	[m/min]	[mm/rev]	[mm]	[m/min]	[mm/rev]	[mm]	[m/min]	[mm/rev]	[mm]	[m/min]	[mm/rev]	[mm]

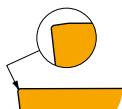
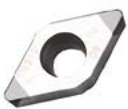

For finish machining.

DCGW 11T304S01020B	TB310	0.4	-	-	-	-	-	-	370	0.10	0.4	-	-	-	95	0.07	0.3	75	0.15	1.0
DCGW 11T308S01020B	TB310	0.8	-	-	-	-	-	-	380	0.15	0.6	-	-	-	100	0.11	0.5	80	0.15	1.0



DCMW PCD

	IC	D1	L	S
	[mm]	[mm]	[mm]	[mm]
11T3	9.525	4.40	11.60	3.97

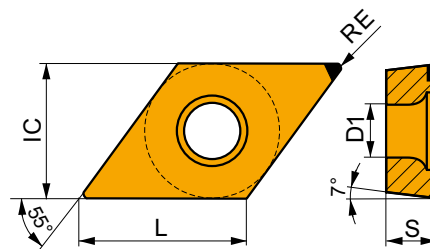

Suitability and starting values for cutting speed (vc), feed (f) and depth of cut (ap). Refer to our Machining Calculator app for further calculations.

Product	RE	P			M			K			N			S			H		
		vc	f	ap	vc	f	ap	vc	f	ap	vc	f	ap	vc	f	ap			
	[mm]	[m/min]	[mm/rev]	[mm]	[m/min]	[mm/rev]	[mm]	[m/min]	[mm/rev]	[mm]	[m/min]	[mm/rev]	[mm]	[m/min]	[mm/rev]	[mm]	[m/min]	[mm/rev]	[mm]

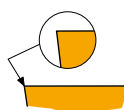
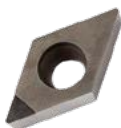

For finish machining, high speeds and stable cutting conditions.

DCMW 11T304FN	PD1	0.4																	
DCMW 11T308FN	PD1	0.8																	



SDJC(RL) EXT

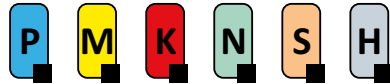

PRAMET

S



External Screw Lock Tool Holder with 93° Cutting Angle for DC.. Insert

External Right/Left hand tool holder with 93° cutting angle for screw type positive DC.. 07, 11 or 15 inserts. Suited for external longitudinal turning with shoulder, copy, taper and chamfer turning. Available with shank size 08x08 up to 25x25 mm. Body treated for longer tool life.

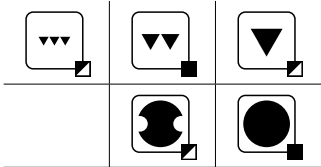
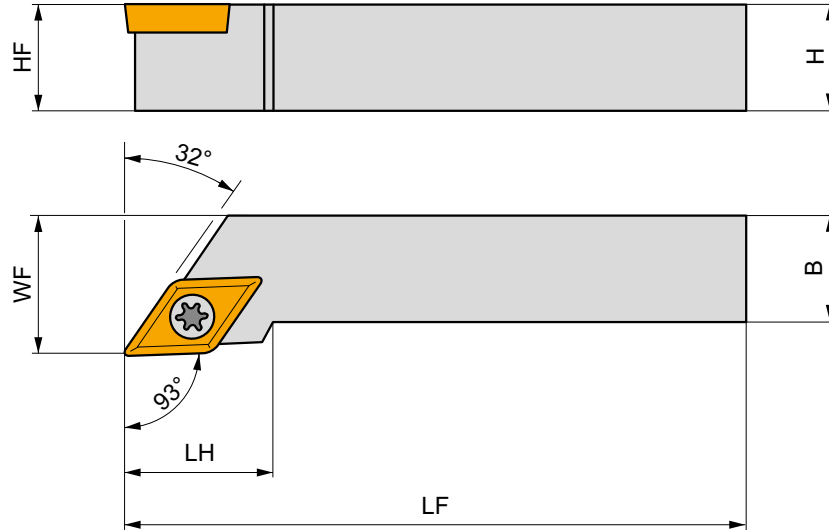
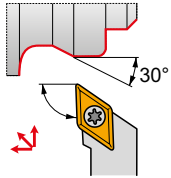

Product	H	B	HF	WF	LF	LH	LAMS	GAMO	kg	GI	SO
	[mm]	[mm]	[mm]	[mm]	[mm]	[mm]	[°]	[°]			
R SDJCR 0808 D 07	8	8	8	10	60	14	0	0	0.06	GI052	S01
SDJCR 1010 E 07	10	10	10	12	70	14	0	0	0.06	GI052	S01
SDJCR 1212 F 07	12	12	12	16	80	14	0	0	0.11	GI052	S01
SDJCR 1212 F 11	12	12	12	16	80	20	0	0	0.10	GI012	S08
SDJCR 1616 H 11	16	16	16	20	100	20	0	0	0.22	GI012	S08
SDJCR 2020 K 11-M-A	20	20	20	25	125	20	0	0	0.40	GI012	SD10
SDJCR 2525 M 11-M-A	25	25	25	32	150	20	0	0	0.74	GI012	SD10
SDJCR 2525 M 15	25	25	25	32	150	28	0	0	0.75	GI243	SD11
L SDJCL 0808 D 07	8	8	8	10	60	14	0	0	0.04	GI052	S01
SDJCL 1010 E 07	10	10	10	12	70	14	0	0	0.08	GI052	S01
SDJCL 1212 F 07	12	12	12	16	80	14	0	0	0.12	GI052	S01
SDJCL 1212 F 11	12	12	12	16	80	20	0	0	0.12	GI012	S08
SDJCL 1616 H 11	16	16	16	20	100	20	0	0	0.20	GI012	S08
SDJCL 2020 K 11-M-A	20	20	20	25	125	20	0	0	0.41	GI012	SD10
SDJCL 2525 M 11-M-A	25	25	25	32	150	20	0	0	0.74	GI012	SD10
SDJCL 2525 M 15	25	25	25	32	150	28	0	0	0.07	GI243	SD11



GI012	DC.. 11T3..
GI052	DC.. 0702..
GI243	DC.. 1504..



	US	Nm	M		SDN	MS	FLAG	HXX
SD10	US 3510-T15P	3.0	M 3.5	10.6	SDN 110304	MS 3510	FLAG T15P	HXX 3.5
SD11	US 64518-T15P	5.0	M 4.5	18	SDN 150304	MS 4512	FLAG T15P	HXX 5
S01	US 2506-T07P	0.9	M 2.5	6.3	-	-	FLAG T07P	-
S08	US 3510-T15P	3.0	M 3.5	10.6	-	-	FLAG T15P	-



SDNCN EXT



External Screw Lock Tool Holder with 62.5° Cutting Angle for DC.. Insert

External neutral tool holder with 62.5° cutting angle for screw type positive DC.. 07 or 11 inserts. Suited for external longitudinal turning without shoulder, copy, taper and chamfer turning. Available with shank size 08x08 up to 25x25 mm. Body treated for longer tool life.

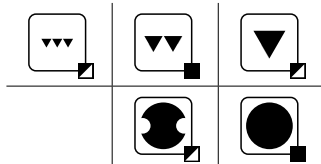
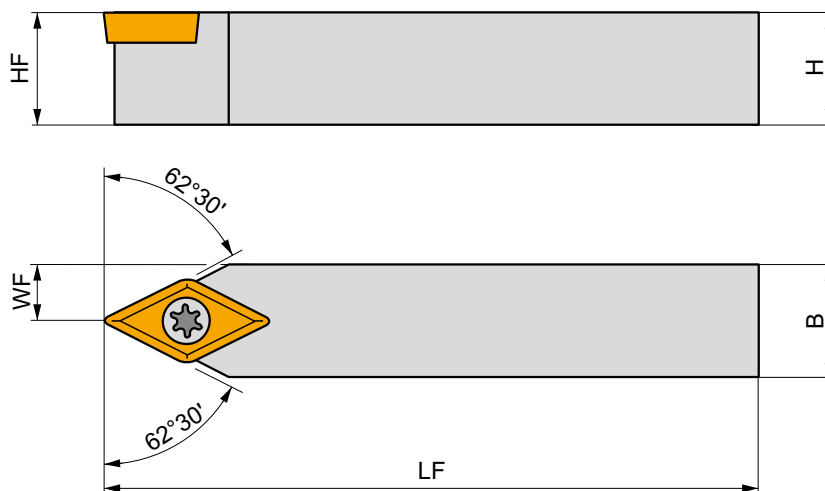
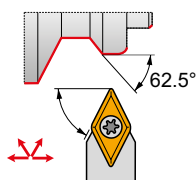

Product	H	B	HF	WF	LF	LAMS	GAMO	kg		
	[mm]	[mm]	[mm]	[mm]	[mm]	[°]	[°]			
N SDNCN 0808 D 07	8	8	8	4	60	0	0	0.06	GI052	S01
SDNCN 1010 E 07	10	10	10	5	70	0	0	0.08	GI052	S01
SDNCN 1212 F 07	12	12	12	6	80	0	0	0.12	GI052	S01
SDNCN 1212 F 11	12	12	12	6	80	0	0	0.12	GI012	S08
SDNCN 1616 H 11	16	16	16	8	100	0	0	0.18	GI012	S08
SDNCN 2020 K 11-M-A	20	20	20	10	125	0	0	0.35	GI012	SD10
SDNCN 2525 M 11-M-A	25	25	25	12.5	150	0	0	0.70	GI012	SD10



GI012

DC.. 11T3..

GI052

DC.. 0702..



SD10

US 3510-T15P

3.0

M 3.5

10.6

SDN 110304

MS 3510

FLAGT15P

HXK 3.5

S01

US 2506-T07P

0.9

M 2.5

6.3

-

-

FLAGT07P

-

S08

US 3510-T15P

3.0

M 3.5

10.6

-

-

FLAGT15P

-



C.-SDJC(RL) EXT

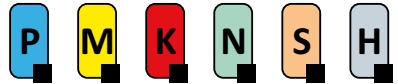

External PSC Quick Change Tool, Screw Lock, 93° Cutting Angle for DC.. Insert

External Right/Left hand tool, through coolant, with 93° cutting angle for screw type positive DC.. 07, 11 or 15 inserts. Suited for external longitudinal turning with shoulder, copy, taper and chamfer turning. Available with PSC (Polygon Shank Coupling) size C3 up to C5. Body treated for longer tool life.

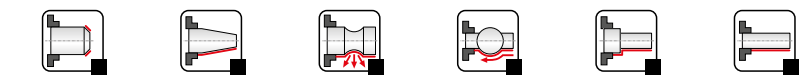
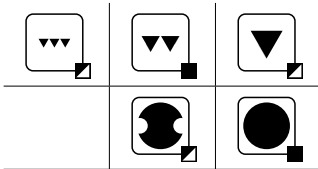
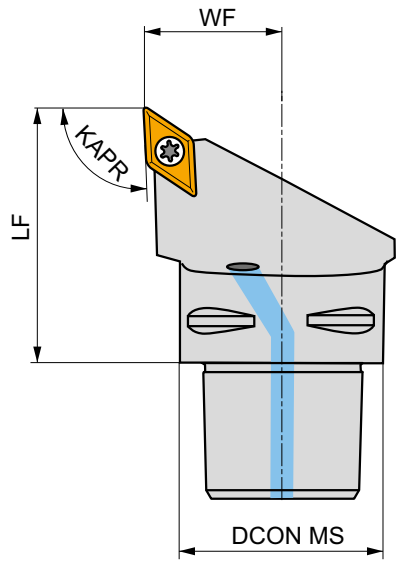
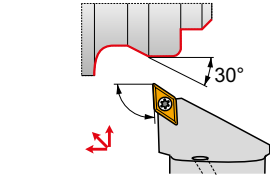

Product	DCON MS	WF	LF	KAPR	LAMS	GAMO				
	[mm]	[mm]	[mm]	[°]	[°]	[°]				
R C3-SDJCR-22040-11	32	22	40	93	0	0	✓	0.21	GI012	C-SD11V-1
C4-SDJCR-27050-11	40	27	50	93	0	0	✓	0.38	GI012	C-SD11V-1
C5-SDJCR-35060-11	50	35	60	93	0	0	✓	0.69	GI012	C-SD11V-2
L C3-SDJCL-22040-11	32	22	40	93	0	0	✓	0.21	GI012	C-SD11V-1
C4-SDJCL-27050-11	40	27	50	93	0	0	✓	0.38	GI012	C-SD11V-1
C5-SDJCL-35060-11	50	35	60	93	0	0	✓	0.70	GI012	C-SD11V-2

GI012	DC.. 11T3..

C-SD11V-1	US 2001-T15P	3.0	M 3.5	12.1	SDS 263-01	MS 9001	FLAG T15P/3,5	CN 034-01
C-SD11V-2	US 2001-T15P	3.0	M 3.5	12.1	SDS 263-01	MS 9001	FLAG T15P/3,5	CN 034-02



C.-SDNCN EXT



External PSC Quick Change Tool, Screw Lock, 62.5° Cutting Angle, DC.. Insert

External Right/Left hand tool, through coolant, with 62.5° cutting angle for screw type positive DC.. 11 inserts. Suited for external longitudinal turning without shoulder, copy, taper and chamfer turning. Available with PSC (Polygon Shank Coupling) size C4 and C5. Body treated for longer tool life.

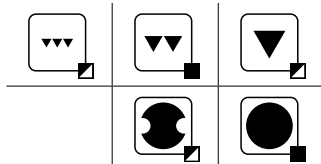
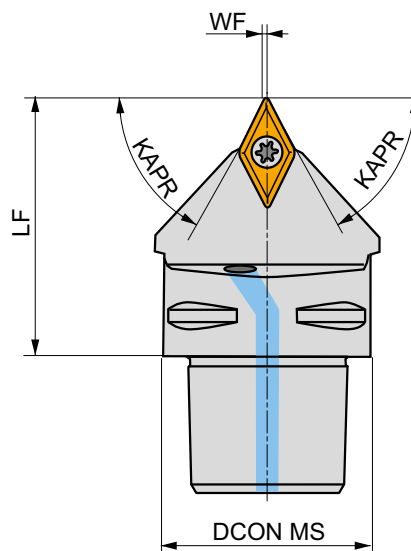
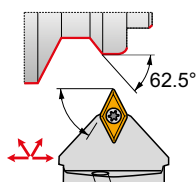

Product	DCON MS	WF	LF	KAPR	LAMS	GAMO				
	[mm]	[mm]	[mm]	[°]	[°]	[°]				
N C4-SDNCN-00050-11	40	0.5	50	62.5	0	0	✓	0.35	GI012	C-SD11V-1
C5-SDNCN-00060-11	50	0.5	60	62.5	0	0	✓	0.62	GI012	C-SD11V-2



GI012



DC.. 11T3..



C-SD11V-1

US 2001-T15P

3.0

M 3.5

12.1

SDS 263-01

MS 9001

FLAG T15P/3,5

CN 034-01

C-SD11V-2

US 2001-T15P

3.0

M 3.5

12.1

SDS 263-01

MS 9001

FLAG T15P/3,5

CN 034-02



SDQC(RL) INT

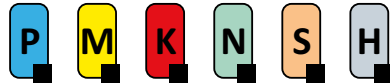

PRAMET

S



Internal Screw Lock Boring Bar with 107.5° Cutting Angle for DC.. Insert

Internal Right/Left hand boring bar, through coolant available, 107.5° cutting angle for screw type DC.. 07 or 11 inserts. Minimum internal turning diameter Ø13 mm. For internal longitudinal turning with shoulder, taper, copying and chamfer turning. Ø10 to Ø32 mm shanks available. Body treated for longer tool life.

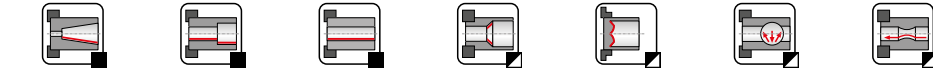
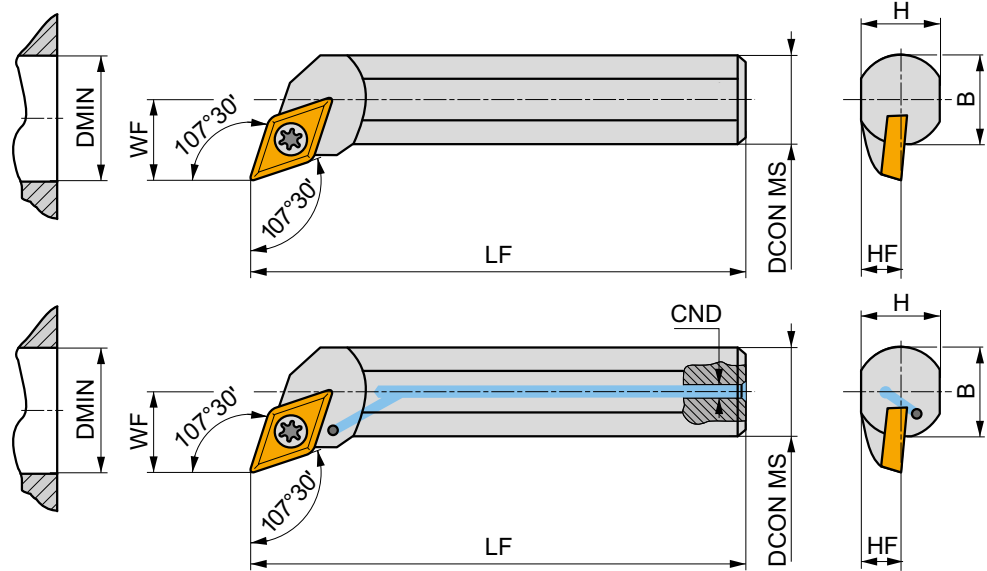
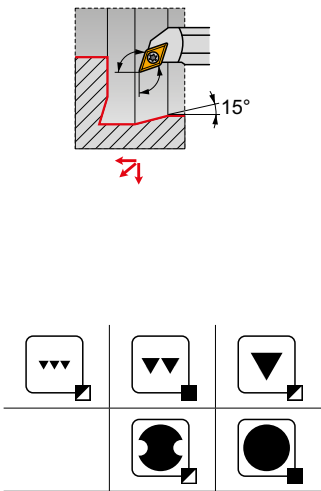

Product	DCON MS	DMIN	WF	H	B	LF	CND	LAMS	GAMO	✓	kg	GI052	S02
	[mm]	[mm]	[mm]	[mm]	[mm]	[mm]	[mm]	[°]	[°]				
R A10H-SDQCR 07	10	13	7	9	-	100	4	-10	0	✓	0.07	GI052	S02
A12K-SDQCR 07	12	16	9	11	-	125	5	-7	0	✓	0.10	GI052	S02
A16M-SDQCR 07	16	20	11	14.5	-	150	6	-7	0	✓	0.24	GI052	S01
A20Q-SDQCR 11	20	25	13	18	-	180	8	-5	0	✓	0.40	GI012	S08
S20S-SDQCR 11	20	25	13	18	18.5	250	-	-5	0	-	0.60	GI012	S08
A25R-SDQCR 11	25	32	17	23	23	200	8	-3	0	✓	0.67	GI012	S08
S25T-SDQCR 11	25	32	17	23	23	300	-	-3	0	-	1.09	GI012	S08
A32S-SDQCR 11-A	32	40	22	30	30	250	8	-10	0	✓	1.25	GI012	SD10
S32U-SDQCR 11-A	32	40	22	30	30	350	-	-10	0	-	2.10	GI012	SD10
L A10H-SDQCL 07	10	13	7	9	-	100	4	-10	0	✓	0.06	GI052	S02
A12K-SDQCL 07	12	16	9	11	-	125	5	-7	0	✓	0.11	GI052	S02
A16M-SDQCL 07	16	20	11	14.5	-	150	6	-7	0	✓	0.24	GI052	S01
A20Q-SDQCL 11	20	25	13	18	-	180	8	-5	0	✓	0.37	GI012	S08
S20S-SDQCL 11	20	25	13	18	18.5	250	-	-5	0	-	0.63	GI012	S08
A25R-SDQCL 11	25	32	17	23	23	200	8	-3	0	✓	0.64	GI012	S08
S25T-SDQCL 11	25	32	17	23	23	300	-	-3	0	-	1.15	GI012	S08
A32S-SDQCL 11-A	32	40	22	30	30	250	8	-10	0	✓	1.33	GI012	SD10
S32U-SDQCL 11-A	32	40	22	30	30	350	-	-10	0	-	2.08	GI012	SD10

GI012	DC.. 11T3..
GI052	DC.. 0702..

SD10	US 3510-T15P	3.0	M 3.5	10.6	SDN 110304	MS 3510	FLAG T15P	HXK 3.5
S01	US 2506-T07P	0.9	M 2.5	6.3	-	-	FLAG T07P	-
S02	US 2505-T07P	0.9	M 2.5	5.2	-	-	FLAG T07P	-
S08	US 3510-T15P	3.0	M 3.5	10.6	-	-	FLAG T15P	-



SDUC(RL) INT



Internal Screw Lock Boring Bar with 93° Cutting Angle for DC.. Insert

Internal Right/Left hand boring bar, through coolant available, 93° cutting angle for screw type DC.. 07 or 11 inserts. Minimum internal turning diameter Ø13 mm. For internal longitudinal turning with shoulder, taper, copying and chamfer turning. Ø10 up to Ø32 mm shanks available. Body treated for longer tool life.

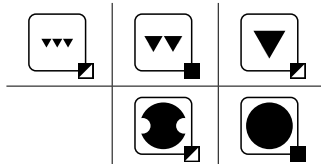
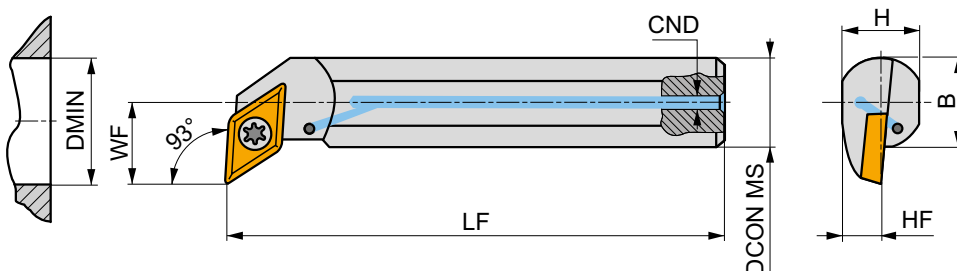
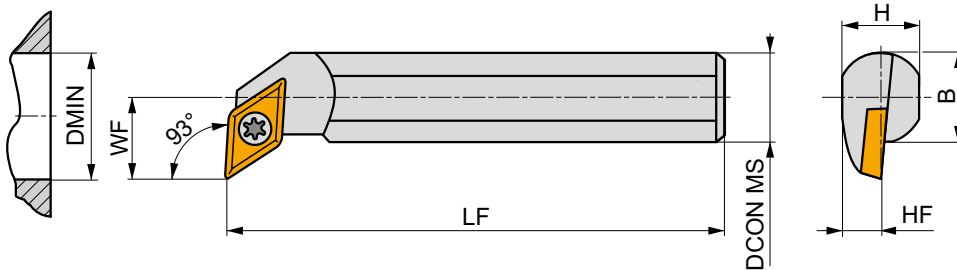
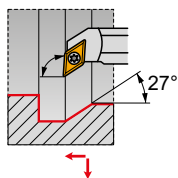

Product	DCON MS	DMIN	WF	H	B	LF	CND	LAMS	GAMO					
	[mm]	[mm]	[mm]	[mm]	[mm]	[mm]	[°]	[°]						
R	A10H-SDUCR 07	10	13	7	9	-	100	4	-10	0	✓	0.05	GI052	S02
	A12K-SDUCR 07	12	16	9	11	-	125	5	-7	0	✓	0.12	GI052	S02
	A16M-SDUCR 07	16	20	11	14.5	-	150	6	-7	0	✓	0.22	GI052	S01
	A20Q-SDUCR 11	20	25	13	18	-	180	8	-3	0	✓	0.38	GI012	S08
	S20S-SDUCR 11	20	25	13	18	18.5	250	-	-5	0	-	0.60	GI012	S08
	A25R-SDUCR 11	25	32	17	23	23	200	8	-3	0	✓	0.60	GI012	S08
	S25T-SDUCR 11	25	32	17	23	23	300	-	-3	0	-	1.15	GI012	S08
	A32S-SDUCR 11-A	32	40	22	30	30	250	8	-10	0	✓	1.30	GI012	SD10
	S32U-SDUCR 11-A	32	40	22	30	30	350	-	-10	0	-	2.10	GI012	SD10
L	A10H-SDUCL 07	10	13	7	9	-	100	4	-10	0	✓	0.06	GI052	S02
	A12K-SDUCL 07	12	16	9	11	-	125	5	-7	0	✓	0.11	GI052	S02
	A16M-SDUCL 07	16	20	11	14.5	-	150	6	-7	0	✓	0.21	GI052	S01
	A20Q-SDUCL 11	20	25	13	18	-	180	8	-3	0	✓	0.38	GI012	S08
	S20S-SDUCL 11	20	25	13	18	18.5	250	-	-5	0	-	0.60	GI012	S08
	A25R-SDUCL 11	25	32	17	23	23	200	8	-3	0	✓	0.67	GI012	S08
	S25T-SDUCL 11	25	32	17	23	23	300	-	-3	0	-	1.15	GI012	S08
	A32S-SDUCL 11-A	32	40	22	30	30	250	8	-10	0	✓	1.35	GI012	SD10
	S32U-SDUCL 11-A	32	40	22	30	30	350	-	-10	0	-	2.09	GI012	SD10



GI012

DC.. 11T3..

GI052

DC.. 0702..



SD10

US 3510-T15P

3.0

M 3.5

10.6

SDN 110304

MS 3510

FLAG T15P

HXK 3.5

S01

US 2506-T07P

0.9

M 2.5

6.3

-

-

FLAG T07P

-

S02

US 2505-T07P

0.9

M 2.5

5.2

-

-

FLAG T07P

-

S08

US 3510-T15P

3.0

M 3.5

10.6

-

-

FLAG T15P

-



SDUC(RL)-E INT

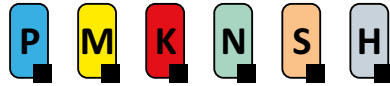

PRAMET

S



Internal Carbide Screw Lock Boring Bar with 93° Cutting Angle for DC.. Insert

Internal Right/Left hand carbide boring bar, through coolant, 93° cutting angle for screw type positive DC.. 07 inserts. Minimum internal turning diameter Ø15 mm. For internal longitudinal turning with shoulder, taper, copying and chamfer turning. Ø10 up to Ø16 mm shanks available. For tool overhang >3xD.

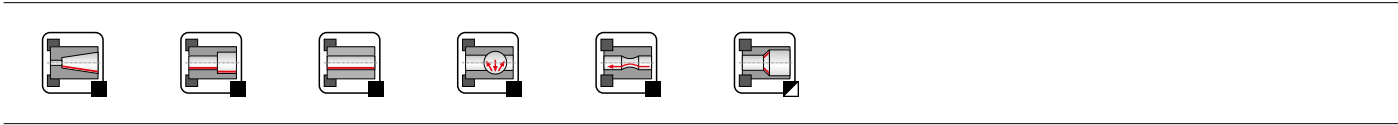
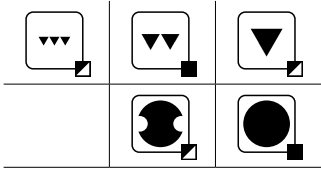
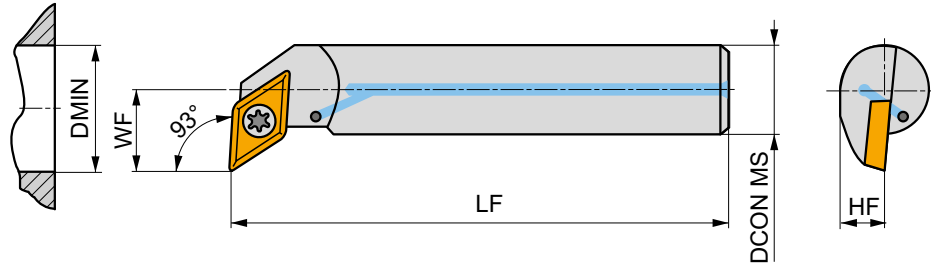
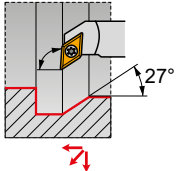

Product	DCON MS	DMIN	WF	HF	LF	LAMS	GAMO					
	[mm]	[mm]	[mm]	[mm]	[mm]	[°]	[°]					
R	E10M-SDUCR 07-ER	10	15	9	5.6	150	-5	0	✓	0.14	G1052	SD21
	E12Q-SDUCR 07-ER	12	18	11	6.5	150	-5	0	✓	0.26	G1052	SD21
	E16R-SDUCR 07-ER	16	22	13	8.5	150	-5	0	✓	0.49	G1052	SD21
L	E10M-SDUCL 07-ER	10	15	9	5.6	150	-5	0	✓	0.15	G1052	SD21
	E12Q-SDUCL 07-ER	12	18	11	6.5	150	-5	0	✓	0.26	G1052	SD21
	E16R-SDUCL 07-ER	16	22	13	8.5	150	-5	0	✓	0.50	G1052	SD21



SDZC(RL) INT



Internal Screw Lock Boring Bar with 93° Cutting Angle for DC.. Insert

Internal Right/Left hand boring bar with 93° cutting angle for screw type DC.. 07 or 11 inserts. Minimum internal turning diameter Ø27 mm. Suited for internal longitudinal back turning with shoulder, taper, copying and chamfer turning. Available with shank size Ø16 up to Ø40 mm. Body treated for longer tool life.

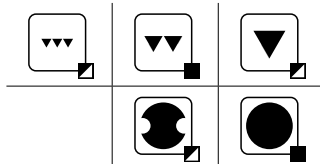
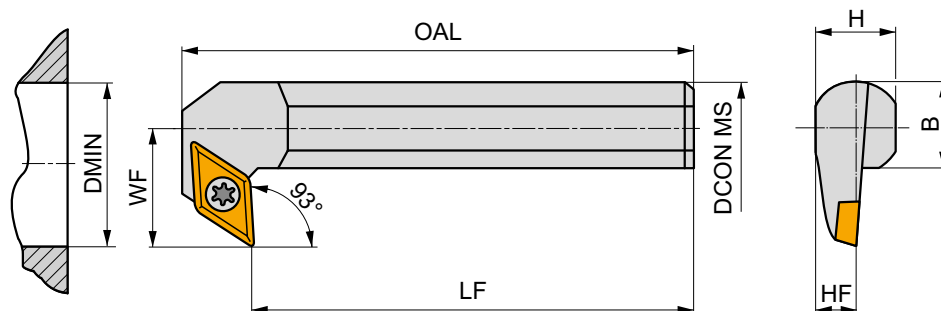
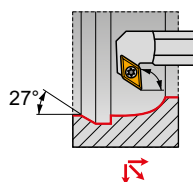

Product	DCON MS	DMIN	WF	H	B	LF	OAL	LAMS	GAMO	kg			
	[mm]	[mm]	[mm]	[mm]	[mm]	[mm]	[mm]	[°]	[°]				
R	S16M-SDZCR 07-93	16	27	17	14.5	15	150	163	-4	0	0.26	GI052	S01
	S20Q-SDZCR 11-93	20	35	22	18	18.5	180	198	-5	0	0.50	GI012	S08
	S25R-SDZCR 11-93	25	42	27	23	23	200	218	-3	0	0.83	GI012	S08
	S32S-SDZCR 11-93-A	32	53	35	30	30	250	268	-6	0	1.64	GI012	SD10
	S40T-SDZCR 11-93-A	40	65	43	38	38	300	322	-5	0	3.00	GI012	SD10
L	S16M-SDZCL 07-93	16	27	17	14.5	15	150	163	-4	0	0.27	GI052	S01
	S20Q-SDZCL 11-93	20	35	22	18	18.5	180	198	-5	0	0.60	GI012	S08
	S25R-SDZCL 11-93	25	42	27	23	23	200	218	-3	0	0.80	GI012	S08
	S32S-SDZCL 11-93-A	32	53	35	30	30	250	268	-6	0	1.60	GI012	SD10
	S40T-SDZCL 11-93-A	40	65	43	38	38	300	322	-5	0	3.00	GI012	SD10



GI012

DC.. 11T3..

GI052

DC.. 0702..



SD10

US 3510-T15P

3.0

M 3.5

10.6

SDN 110304

MS 3510

FLAG T15P

HXK 3.5

S01

US 2506-T07P

0.9

M 2.5

6.3

-

-

FLAG T07P

-

S08

US 3510-T15P

3.0

M 3.5

10.6

-

-

FLAG T15P

-



C.-SDUC(RL) INT

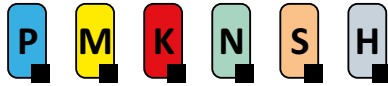

PRAMET

S



Internal PSC Quick Change Tool, Screw Lock, 93° Cutting Angle for DC.. Insert

Internal Right/Left hand tool, through coolant, with 93° cutting angle for screw type DC.. 07 or 11 inserts. Minimum internal turning diameter Ø20 mm. Suited for a wide range of internal turning applications. PSC shank (Polygon Shank Coupling) size C3 up to C5 with choice of lengths. Body treated for longer tool life.

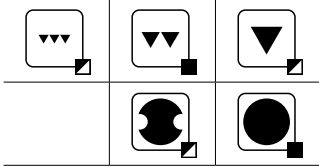
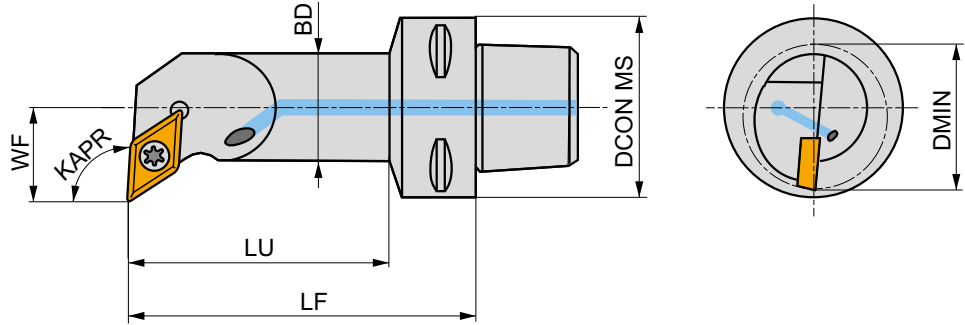
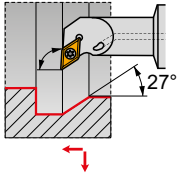

Product	DCON MS	DMIN	WF	LF	LU	BD	KAPR	LAMS	GAMO	Hand	kg	GI	SV	
	[mm]	[mm]	[mm]	[mm]	[mm]	[mm]	[°]	[°]	[°]					
R	C3-SDUCR-11065-07	50	20	11	65	48	16	93	-4.3	0	✓	0.20	GI052	SV11
	C4-SDUCR-11070-07	40	20	11	70	47	16	93	-4.3	0	✓	0.35	GI052	SV11
	C4-SDUCR-13080-11	40	25	13	80	57	20	93	-5.8	0	✓	0.41	GI012	SC09M
	C4-SDUCR-17090-11	40	32	17	90	68	25	93	-3.4	0	✓	0.49	GI012	SV16
	C5-SDUCR-13080-11	50	25	13	80	56	20	93	-5.8	0	✓	0.60	GI012	SC09M
	C5-SDUCR-17090-11	50	32	17	90	67	25	93	-3.4	0	✓	0.68	GI012	SV16
L	C4-SDUCL-11070-07	40	20	11	70	47	16	93	-4.3	0	✓	0.35	GI052	SV11
	C4-SDUCL-13080-11	40	25	13	80	57	20	93	-5.8	0	✓	0.41	GI012	SC09M
	C4-SDUCL-17090-11	40	32	17	90	68	25	93	-3.4	0	✓	0.49	GI012	SV16
	C5-SDUCL-13080-11	50	25	13	80	56	20	93	-5.8	0	✓	0.60	GI012	SC09M



GI012	DC.. 11T3..
GI052	DC.. 0702..



SC09M	US 2009-T15P	3.0	M 3.5	8.1	FLAG T15P/3,5	-
SV11	US 2003-T07P	0.8	M 2.5	6.5	-	FLAG T07P
SV16	US 2010-T15P	3.0	M 3.5	10.1	-	FLAG T15P/3,5



EC

06 / 08

CARBIDE INSERTS

ECGT



104

ECMT



105

ECMW



106

MATCH THE RIGHT SIZE (example)

Insert

ECMT 060204E-FM2

Tool Holder

S08K-SEUCR 06

ISO TURNING – EXTERNAL

SEGC(RL) EXT

90°

EC..

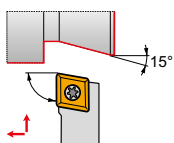

08

 $\frac{12 \times 12}{16 \times 16}$

107

104 – 106

ISO TURNING – INTERNAL

SEUC(RL) INT

93°

EC..



06

08

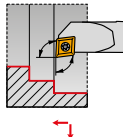
 $\frac{11}{32}$

108

104 – 106



ECGT



	IC	D1	L	S
	[mm]	[mm]	[mm]	[mm]
0602	6.350	2.80	6.50	2.38
0602-SF3	6.350	2.80	6.50	2.58
0803	7.940	3.40	8.20	3.18
0803-SF3	7.940	3.40	8.20	3.43

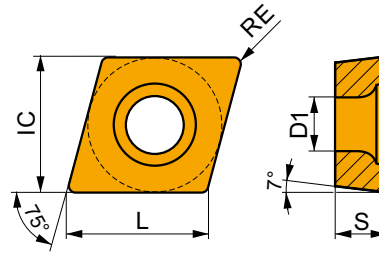

Suitability and starting values for cutting speed (vc), feed (f) and depth of cut (ap). Refer to our Machining Calculator app for further calculations.

Product	RE	P			M			K			N			S			H		
		vc	f	ap	vc	f	ap	vc	f	ap	vc	f	ap	vc	f	ap			
	[mm]	[m/min]	[mm/rev]	[mm]	[m/min]	[mm/rev]	[mm]	[m/min]	[mm/rev]	[mm]	[m/min]	[mm/rev]	[mm]	[m/min]	[mm/rev]	[mm]	[m/min]	[mm/rev]	[mm]

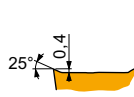

SF2 geometry with highly positive design for fine to finish machining, and continuous cuts.

ECGT 060202E-SF2	H07	0.2	–	–	–	105	0.05	1.0	–	–	–	525	0.06	1.0	50	0.04	0.8	–	–	–
	T6310	0.2	185	0.05	1.0	130	0.05	1.0	–	–	–	555	0.06	1.0	55	0.04	0.8	–	–	–
ECGT 060204E-SF2	H07	0.4	–	–	–	85	0.09	1.0	–	–	–	430	0.12	1.0	40	0.07	0.8	–	–	–
	T6310	0.4	160	0.10	1.0	115	0.09	1.0	–	–	–	480	0.12	1.0	45	0.07	0.8	–	–	–
ECGT 080302E-SF2	H07	0.2	–	–	–	105	0.05	1.0	–	–	–	525	0.06	1.0	50	0.04	0.8	–	–	–
	T6310	0.2	185	0.05	1.0	130	0.05	1.0	–	–	–	555	0.06	1.0	55	0.04	0.8	–	–	–
ECGT 080304E-SF2	H07	0.4	–	–	–	85	0.09	1.0	–	–	–	430	0.12	1.0	40	0.07	0.8	–	–	–
	T6310	0.4	160	0.10	1.0	115	0.09	1.0	–	–	–	480	0.12	1.0	45	0.07	0.8	–	–	–

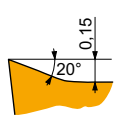

SF3 geometry with highly positive design for fine to finish machining, and continuous cuts.

ECGT 060202E-SF3	H07	0.2	–	–	–	105	0.05	0.8	170	0.05	0.8	540	0.06	0.8	55	0.04	0.6	–	–	–
	T6310	0.2	185	0.05	0.8	130	0.05	0.8	145	0.05	0.8	555	0.06	0.8	55	0.04	0.6	35	0.15	1.0
ECGT 080304E-SF3	H07	0.4	–	–	–	85	0.09	1.0	135	0.10	1.0	430	0.12	1.0	40	0.07	0.8	–	–	–
	T6310	0.4	160	0.10	1.0	115	0.09	1.0	125	0.10	1.0	480	0.12	1.0	45	0.07	0.8	30	0.15	1.0



ECMT

	IC	D1	L	S
	[mm]	[mm]	[mm]	[mm]
0602	6.350	2.80	6.50	2.38
0803	7.940	3.40	8.20	3.18

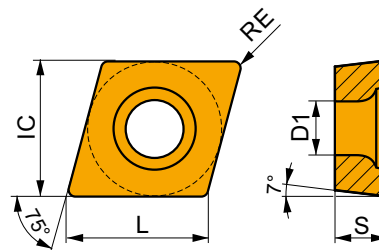

Suitability and starting values for cutting speed (vc), feed (f) and depth of cut (ap). Refer to our Machining Calculator app for further calculations.

Product	RE	P			M			K			N			S			H		
		vc	f	ap	vc	f	ap	vc	f	ap	vc	f	ap	vc	f	ap			
	[mm]	[m/min]	[mm/rev]	[mm]	[m/min]	[mm/rev]	[mm]	[m/min]	[mm/rev]	[mm]	[m/min]	[mm/rev]	[mm]	[m/min]	[mm/rev]	[mm]	[m/min]	[mm/rev]	[mm]

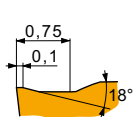
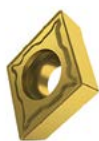

FM2 geometry for finish to medium machining, and continuous to interrupted cuts.

ECMT 060204E-FM2	T7325	0.4	✓	180	0.12	0.8	✓	140	0.11	0.8	–	–	–	–	–	–	–	–	–
	T8330	0.4	■	155	0.12	0.8	✓	90	0.11	0.8	■	145	0.12	0.8	–	–	–	–	–
	T8430	0.4	■	205	0.12	0.8	✓	110	0.11	0.8	✓	170	0.12	0.8	–	–	–	–	–
	T9315	0.4	■	290	0.12	0.8	–	–	–	–	✓	275	0.12	0.8	–	–	–	–	–
	T9325	0.4	■	255	0.12	0.8	✓	150	0.11	0.8	✓	240	0.12	0.8	–	–	–	–	–
	T9335	0.4	■	220	0.12	0.8	✓	130	0.11	0.8	–	–	–	–	–	–	–	–	–
ECMT 080304E-FM2	T5315	0.4	✓	280	0.12	1.0	–	–	–	■	265	0.12	1.0	–	–	–	–	–	–
	T7325	0.4	✓	170	0.12	1.0	✓	130	0.11	1.0	–	–	–	–	–	–	–	–	
	T8330	0.4	■	150	0.12	1.0	✓	90	0.11	1.0	■	140	0.12	1.0	–	–	–	–	–
	T8430	0.4	■	205	0.12	1.0	✓	110	0.11	1.0	✓	170	0.12	1.0	–	–	–	–	–
	T9315	0.4	■	280	0.12	1.0	–	–	–	–	✓	265	0.12	1.0	–	–	–	–	–
	T9325	0.4	■	255	0.12	1.0	✓	150	0.11	1.0	✓	240	0.12	1.0	–	–	–	–	–
T9335	0.4	■	215	0.12	1.0	✓	125	0.11	1.0	–	–	–	–	–	–	–	–	–	
ECMT 080308E-FM2	T7325	0.8	✓	185	0.17	1.0	✓	140	0.15	1.0	–	–	–	–	–	–	–	–	
	T8330	0.8	■	165	0.17	1.0	✓	95	0.15	1.0	■	155	0.17	1.0	–	–	–	–	–
	T8430	0.8	■	210	0.17	1.0	✓	115	0.15	1.0	✓	175	0.17	1.0	–	–	–	–	–
	T9315	0.8	■	290	0.17	1.0	–	–	–	–	✓	275	0.17	1.0	–	–	–	–	–
	T9325	0.8	■	260	0.17	1.0	✓	155	0.15	1.0	✓	245	0.17	1.0	–	–	–	–	–
	T9335	0.8	■	225	0.17	1.0	✓	135	0.15	1.0	–	–	–	–	–	–	–	–	–



ECMW



	IC [mm]	D1 [mm]	L [mm]	S [mm]
0602	6.350	2.80	6.50	2.38
0803	7.940	3.40	8.20	3.18

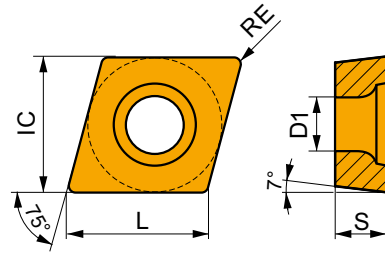

Suitability and starting values for cutting speed (vc), feed (f) and depth of cut (ap). Refer to our Machining Calculator app for further calculations.

Product	RE [mm]	P			M			K			N			S			H		
		vc [m/min]	f [mm/rev]	ap [mm]	vc [m/min]	f [mm/rev]	ap [mm]	vc [m/min]	f [mm/rev]	ap [mm]	vc [m/min]	f [mm/rev]	ap [mm]	vc [m/min]	f [mm/rev]	ap [mm]	vc [m/min]	f [mm/rev]	ap [mm]

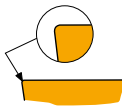
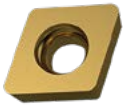

For fine-finish to semi-rough machining, and continuous to slightly interrupted cuts.

ECMW 060204	H07	0.4	-	-	-	-	-	-	100	0.10	2.0	-	-	-	-	-	-	-
ECMW 080304	H07	0.4	-	-	-	-	-	-	100	0.10	2.5	-	-	-	-	-	-	-
ECMW 080308	H07	0.8	-	-	-	-	-	-	95	0.18	2.5	-	-	-	-	-	-	-



SEGC(RL) EXT



External Screw Lock Tool Holder with 90° Cutting Angle for EC.. Insert

External Right/Left hand tool holder with 90° cutting angle for screw type positive EC.. 08 inserts. Suited for external face and longitudinal turning with shoulder, taper, chamfer and face turning. Available with shank size 12x12 and 16x16 mm. Body treated for longer tool life.

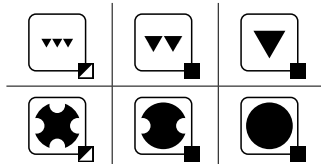
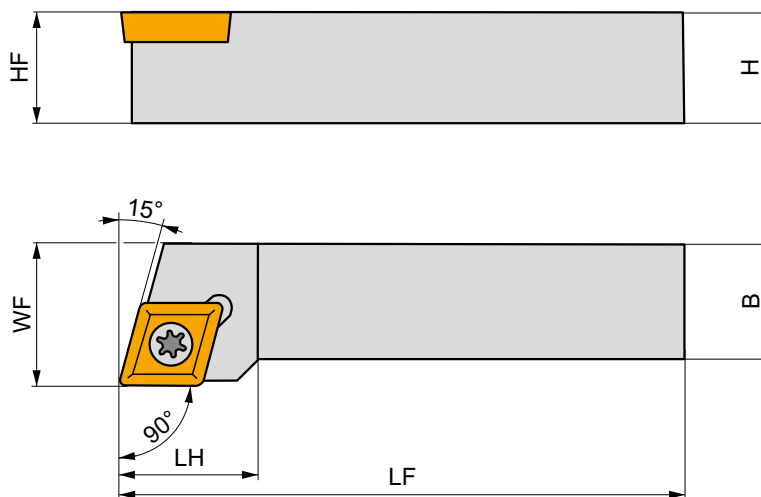
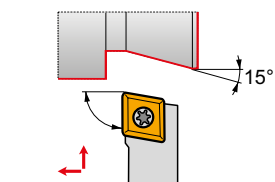

Product		H	B	HF	WF	LF	LH	LAMS	GAMO	kg		
		[mm]	[mm]	[mm]	[mm]	[mm]	[mm]	[°]	[°]			
R	SEGCR 1212 N 08	12	12	12	16	160	12	0	0	0.15	GI210	SE08
	SEGCR 1616 H 08	16	16	16	20	100	12	0	0	0.22	GI210	SE08
L	SEGCL 1212 N 08	12	12	12	16	160	12	0	0	0.22	GI210	SE08
	SEGCL 1616 H 08	16	16	16	20	100	12	0	0	2.14	GI210	SE08



GI210



EC.. 0803..



SE08



416.1-832



3.6



M 3



8.5



PT-8002



SEUC(RL) INT

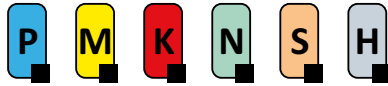

PRAMET

S



Internal Screw Lock Boring Bar with 93° Cutting Angle for EC.. Insert

Internal Right/Left hand boring bar with 93° cutting angle for screw type EC.. 06 and 08 inserts. Minimum internal turning diameter Ø11 mm. Suited for internal taper and longitudinal turning with shoulder and chamfer turning. Available with shank size Ø8 up to Ø25 mm. Body treated for longer tool life.

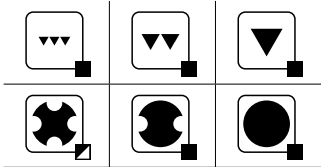
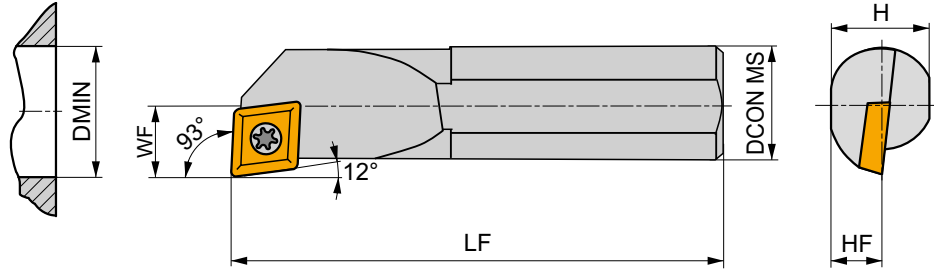
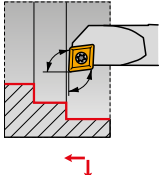

Product	DCON MS	DMIN	WF	H	HF	LF	LAMS	GAMO	kg	G120	G123	SE23	SE24
	[mm]	[mm]	[mm]	[mm]	[mm]	[mm]	[°]	[°]					
R	S08K-SEUCR 06	8	11	7	7	3.5	125	-5	0	0.06	G1213	SE23	SE23
	S10M-SEUCR 06	10	13	8	9	4.5	150	-5	0	0.10	G1213	SE23	SE23
	S12M-SEUCR 08	12	15	9	11	5.5	150	-5	0	0.14	G1210	SE24	SE24
	S16R-SEUCR 08	16	20	11	15	7.5	200	-5	0	0.32	G1210	SE24	SE24
	S20S-SEUCR 08	20	25	13	18	9	250	-5	0	0.58	G1210	SE24	SE24
	S25T-SEUCR 08	25	32	17	23	11.5	300	-4	0	1.06	G1210	SE24	SE24
L	S08K-SEUCL 06	8	11	7	7	3.5	125	-5	0	0.06	G1213	SE23	SE23
	S10M-SEUCL 06	10	13	8	9	4.5	150	-5	0	0.10	G1213	SE23	SE23
	S12M-SEUCL 08	12	15	9	11	5.5	150	-5	0	0.14	G1210	SE24	SE24
	S16R-SEUCL 08	16	20	11	15	7.5	200	-5	0	0.32	G1210	SE24	SE24
	S20S-SEUCL 08	20	25	13	18	9	250	-5	0	0.58	G1210	SE24	SE24
	S25T-SEUCL 08	25	32	17	23	11.5	300	-4	0	1.06	G1210	SE24	SE24

G1210		G1213		EC.. 0803..		EC.. 0602..	
-------	--	-------	--	-------------	--	-------------	--

SE23	5513 020-03	0.8	M 2.5	6.5	PT-8001
SE24	416.1-832	3.6	M 3	8.5	PT-8003



EP

05

CARBIDE INSERTS

EPGX



110

EPMT



110

MATCH THE RIGHT SIZE (example)

Insert

EPGX 050202FR-JZ

Tool Holder

S0608H-SELPR 05

ISO TURNING – INTERNAL

SELP(RL) INT

95°

EP..

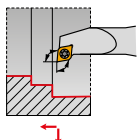

05

 $\frac{8}{16}$

111

110

SELP(RL)-E INT

95°

EP..

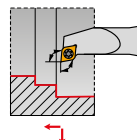

05

 $\frac{8}{16}$

112

110

SEUP(RL) INT

93°

EP..



05

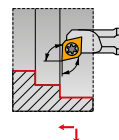

8,3

113

110

SEXP(RL) INT

52°30'

EP..

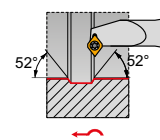

05

 $\frac{9,5}{16}$

114

110

SEXP(RL)-E INT

52°30'

EP..

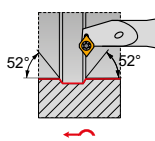

05

 $\frac{9,5}{16}$

115

110



EPGX



	IC	D1	L	S
	[mm]	[mm]	[mm]	[mm]
0502	5.560	2.50	5.70	2.38

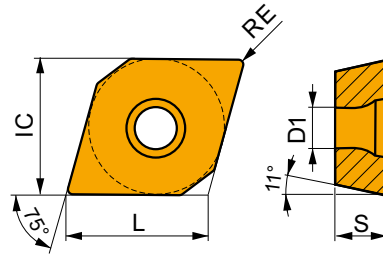

Suitability and starting values for cutting speed (vc), feed (f) and depth of cut (ap). Refer to our Machining Calculator app for further calculations.

Product	RE	P			M			K			N			S			H		
		vc	f	ap	vc	f	ap	vc	f	ap	vc	f	ap	vc	f	ap	vc	f	ap
	[mm]	[m/min]	[mm/rev]	[mm]	[m/min]	[mm/rev]	[mm]	[m/min]	[mm/rev]	[mm]	[m/min]	[mm/rev]	[mm]	[m/min]	[mm/rev]	[mm]	[m/min]	[mm/rev]	[mm]

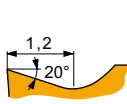

FR-JZ geometry with positive right-handed design for fine-finish machining and continuous cuts.

EPGX 050202FR-JZ	TT010	0.2	295	0.06	0.5	175	0.05	0.5	-	-	-	-	-	-	-	-	-	-	-
-------------------------	--------------	-----	-----	------	-----	-----	------	-----	---	---	---	---	---	---	---	---	---	---	---

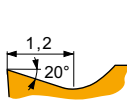

FL-JZ geometry with positive left-handed design for fine-finish machining, and continuous cuts.

EPGX 050202FL-JZ	TT010	0.2	295	0.06	0.5	175	0.05	0.5	-	-	-	-	-	-	-	-	-	-	-
-------------------------	--------------	-----	-----	------	-----	-----	------	-----	---	---	---	---	---	---	---	---	---	---	---

EPMT



	IC	D1	L	S
	[mm]	[mm]	[mm]	[mm]
0502	5.560	2.50	5.70	2.38

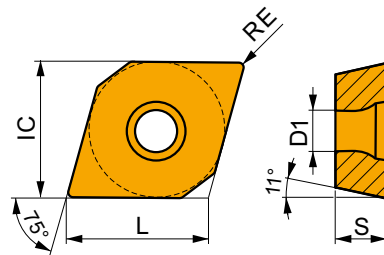

Suitability and starting values for cutting speed (vc), feed (f) and depth of cut (ap). Refer to our Machining Calculator app for further calculations.

Product	RE	P			M			K			N			S			H		
		vc	f	ap	vc	f	ap	vc	f	ap	vc	f	ap	vc	f	ap	vc	f	ap
	[mm]	[m/min]	[mm/rev]	[mm]	[m/min]	[mm/rev]	[mm]	[m/min]	[mm/rev]	[mm]	[m/min]	[mm/rev]	[mm]	[m/min]	[mm/rev]	[mm]	[m/min]	[mm/rev]	[mm]

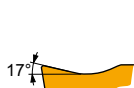

NF2 geometry with positive design for fine-finish to semi-rough machining, and continuous cuts.

EPMT 050202E-NF2	H07	0.2	-	-	-	80	0.09	0.8	125	0.10	0.8	405	0.12	0.8	40	0.07	0.6	-	-	-
	T7325	0.2	215	0.07	0.8	165	0.06	0.8	-	-	-	-	-	-	65	0.06	0.6	-	-	-
	T7335	0.2	220	0.07	0.8	170	0.06	0.8	-	-	-	-	-	-	70	0.06	0.6	-	-	-
	T9315	0.2	390	0.05	0.8	-	-	-	370	0.05	0.8	-	-	-	-	-	-	-	-	-
	T9325	0.2	305	0.07	0.8	180	0.06	0.8	285	0.07	0.8	-	-	-	65	0.06	0.6	-	-	-
	T9335	0.2	200	0.10	0.8	120	0.09	0.8	-	-	-	-	-	-	45	0.07	0.6	-	-	-
	TT010	0.2	345	0.05	0.5	205	0.05	0.5	-	-	-	-	-	-	-	-	-	-	-	-



SELP(RL) INT



Internal Screw Lock Boring Bar with 95° Cutting Angle for EP.. Insert

Internal Right/Left hand boring bar, through coolant available, with 95° cutting angle for screw type EP.. 0502 inserts. Minimum internal turning diameter Ø8 mm. Suited for internal taper and longitudinal turning with shoulder and chamfer turning. Ø8 up to Ø16 mm shanks available. Body treated for longer tool life.

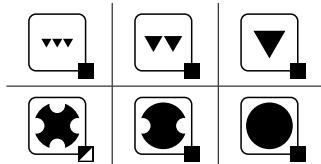
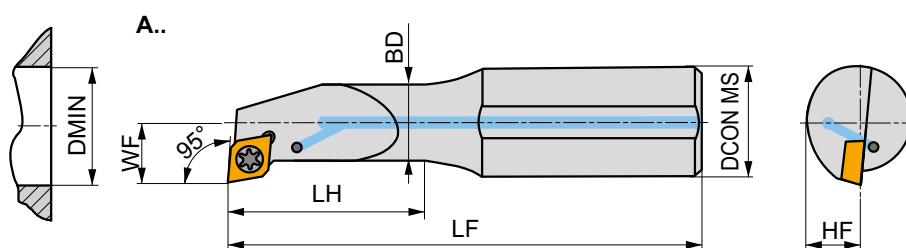
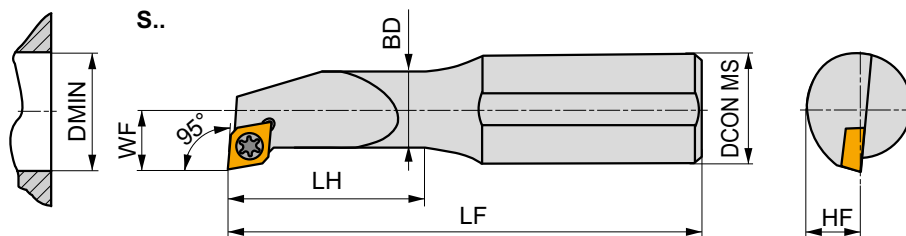
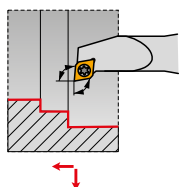

Product	DCON MS	DMIN	BD	WF	LF	LH	LAMS	GAMO				
	[mm]	[mm]	[mm]	[mm]	[mm]	[mm]	[°]	[°]				
R S0608H-SELPR 05	8	8	6	4.5	100	20	-10	0	-	0.04	GI212	SE21
S0810J-SELPR 05	10	11	8	6	110	26	-5	0	-	0.06	GI212	SE22
S1012K-SELPR 05	12	13	10	7	125	32	-5	0	-	0.11	GI212	SE22
A1216M-SELPR 05	16	16	12	9	150	40	-2	0	✓	0.18	GI212	SE22
S1216M-SELPR 05	16	16	12	9	150	40	-2	0	-	0.21	GI212	SE22
L S0608H-SELPL 05	8	8	6	4.5	100	20	-10	0	-	0.04	GI212	SE21
S0810J-SELPL 05	10	11	8	6	110	26	-5	0	-	0.06	GI212	SE22
S1012K-SELPL 05	12	13	10	7	125	32	-5	0	-	0.11	GI212	SE22
S1216M-SELPL 05	16	16	12	9	150	40	-2	0	-	0.21	GI212	SE22



GI212



EP.. 0502..



SE21



28992



0.8



M 2.2



4.2



MA2-8304

SE22

28588

0.8

M 2.2

5.6

MA2-8304



SELP(RL)-E INT



PRAMET

S



Internal Carbide Screw Lock Boring Bar with 95° Cutting Angle for EP. Insert

Internal Right/Left hand carbide boring bar, through coolant, with 95° cutting angle for screw type EP.. 0502 inserts. Minimum internal turning diameter Ø8 mm. Suited for internal taper and longitudinal turning with shoulder and chamfer turning. Available with shank size Ø8 up to Ø16 mm. For tool overhang >3xD.

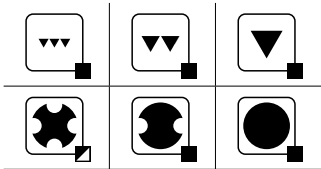
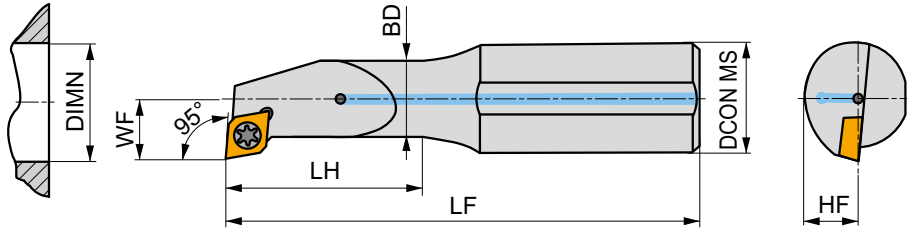
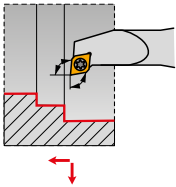

Product	DCON MS	DMIN	BD	WF	LF	LH	LAMS	GAMO	✓	kg	G1212	SE22
	[mm]	[mm]	[mm]	[mm]	[mm]	[mm]	[°]	[°]				
R E0608H-SELPR 05	8	8	6	4.5	100	28	-10	0	✓	0.06	G1212	SE22
E0810J-SELPR 05	10	11	8	6	110	36	-5	0	✓	0.10	G1212	SE22
E1012K-SELPR 05	12	13	10	7	125	44	-5	0	✓	0.18	G1212	SE22
L E0608H-SELPL 05	8	8	6	4.5	100	28	-10	0	✓	0.06	G1212	SE22
E0810J-SELPL 05	10	11	8	6	110	36	-5	0	✓	0.10	G1212	SE22
E1216M-SELPL 05	16	16	12	9	150	55	-2	0	✓	0.33	G1212	SE22

G1212	EP. 0502..

SE22	28588	0.8	M 2.2	5.6	MA2-8304



SEUP(RL) INT



Internal Screw Lock Boring Bar with 93° Cutting Angle for EP.. Insert

Internal Right/Left hand boring bar with 93° cutting angle for screw type EP.. 0502 inserts. Minimum internal turning diameter Ø8.3 mm. Suited for internal taper and longitudinal turning with shoulder and chamfer turning. Available with shank size Ø6 mm. Body treated for longer tool life.

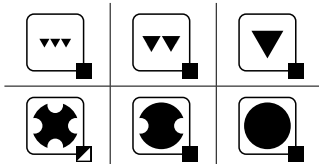
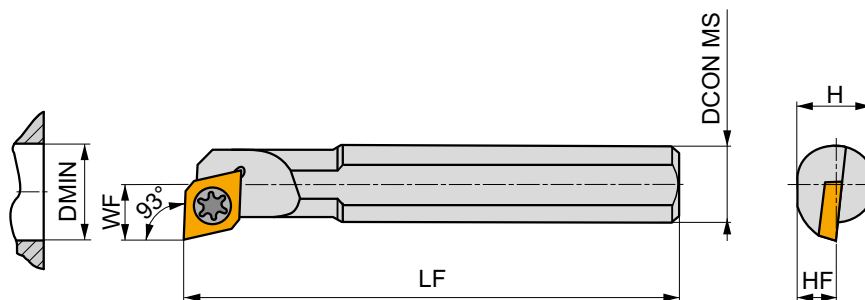
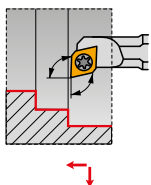

Product	DCON MS [mm]	DMIN [mm]	WF [mm]	H [mm]	HF [mm]	LF [mm]	LAMS [°]	GAMO [°]	kg		
R S06H-SEUPR 05	6	8.3	5	5.4	2.7	100	-7	0	0.03	G1212	SE21
L S06H-SEUPL 05	6	8.3	5	5.4	2.7	100	-7	0	0.03	G1212	SE21



G1212



EP.. 0502..



SE21



28992



0.8



M 2.2



4.2



MA2-8304



SEXP(RL) INT

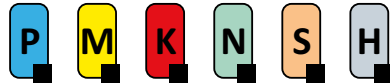

PRAMET

S



Internal Screw Lock Boring Bar with 52.5° Cutting Angle for EP.. Insert

Internal Right/Left hand boring bar, 52.5° cutting angle for screw type EP.. 0502 inserts. Minimum internal turning diameter Ø9.5mm. For internal back chamfer, taper, multi-directional, chamfer and longitudinal turning without shoulder. Available with shank size Ø8 up to Ø16mm. Body treated for longer tool life.

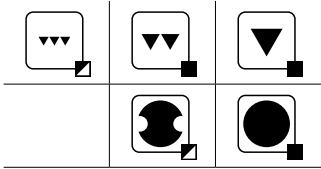
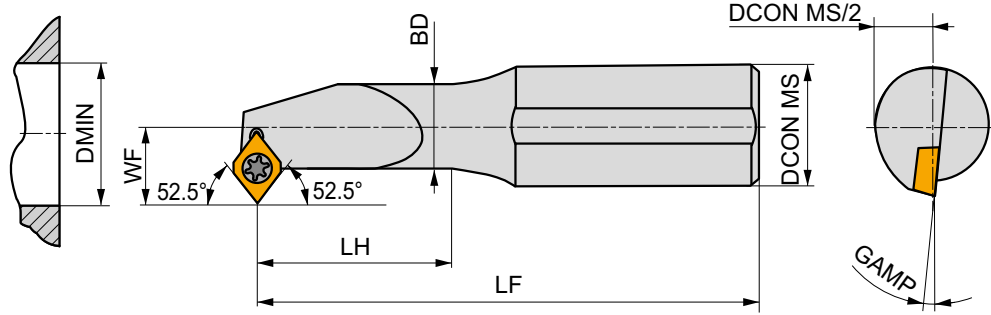
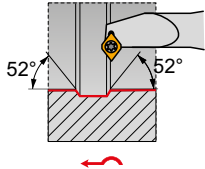

Product	DCON MS	DMIN	BD	WF	LF	LH	GAMP	kg	G1212	SE21
	[mm]	[mm]	[mm]	[mm]	[mm]	[mm]	[°]			
R S0608H-SEXPR 05	8	9.5	6	5.5	100	20	-7	0.04	G1212	SE21
S0810J-SEXPR 05	10	11	8	6	110	26	-5	0.06	G1212	SE22
S1012K-SEXPR 05	12	13	10	7	125	32	-5	0.11	G1212	SE22
S1216M-SEXPR 05	16	16	12	9	150	40	-2	0.21	G1212	SE22
L S0608H-SEXPL 05	8	9.5	6	5.5	100	20	-7	0.04	G1212	SE21
S0810J-SEXPL 05	10	11	8	6	110	26	-5	0.07	G1212	SE22
S1012K-SEXPL 05	12	13	10	7	125	32	-5	0.11	G1212	SE22
S1216M-SEXPL 05	16	16	12	9	150	40	-2	0.21	G1212	SE22

G1212	EP.. 0502..
-------	-------------

SE21	28992	0.8	M 2.2	4.2	MA2-8304
SE22	28588	0.8	M 2.2	5.6	MA2-8304



SEXP(RL)-E INT



PRAMET

S



Internal Carbide Screw Lock Boring Bar, 52.5° Cutting Angle for EP.. Insert

Internal Right/Left hand carbide boring bar, through coolant, 52.5° cutting angle for screw type EP.. 0502 inserts. Minimum internal turning diameter $\varnothing 9.5$ mm. For internal back chamfer, taper, multi-directional, chamfer and longitudinal turning without shoulder. $\varnothing 8$ to $\varnothing 16$ mm shanks available. For overhang $> 3xD$.

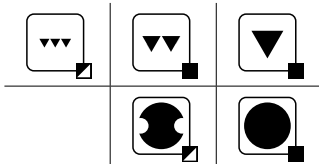
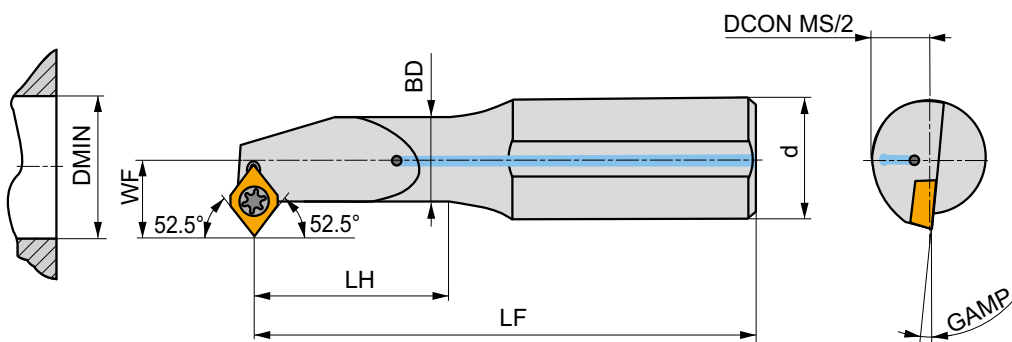
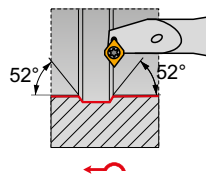

Product	DCON MS	DMIN	BD	WF	LF	LH	GAMP				
	[mm]	[mm]	[mm]	[mm]	[mm]	[mm]	[°]				
R E0608H-SEXPR 05	8	9.5	6	5.5	100	28	-7	✓	0.07	G1212	SE21
E0810J-SEXPR 05	10	11	8	6	110	36	-5	✓	0.11	G1212	SE22
E1012K-SEXPR 05	12	13	10	7	125	44	-5	✓	0.16	G1212	SE22
E1216M-SEXPR 05	16	16	12	9	150	55	-2	✓	0.32	G1212	SE22
L E0608H-SEXPL 05	8	9.5	6	5.5	100	28	-7	✓	0.06	G1212	SE21



G1212



EP..0502..



SE21



28992



0.8



M 2.2



4.2



MA2-8304

SE22

28588

0.8

M 2.2

5.6

MA2-8304



RC

06/ 08/ 12/ 16/ 20/ 25/ 32

CARBIDE INSERTS

RCGT	RCMT	RCMW	RCMX
118	118	120	121

CER INSERTS

RCGX CER
123

MATCH THE RIGHT SIZE (example)

Insert	Tool Holder
RCMT 1204MOE-RM3	SRDCN 3225 P 12-M

ISO TURNING – EXTERNAL

PRDCN EXT	PRSC(RL) EXT	SRDC(RL) EXT	SRDCN EXT															
124	125	126	127															
<table border="1"> <tr><th>RC..</th></tr> <tr><td>20</td></tr> <tr><td>25</td></tr> <tr><td>32</td></tr> </table>	RC..	20	25	32	<table border="1"> <tr><th>RC..</th></tr> <tr><td>16</td></tr> <tr><td>25</td></tr> </table>	RC..	16	25	<table border="1"> <tr><th>RC..</th></tr> <tr><td>08</td></tr> </table>	RC..	08	<table border="1"> <tr><th>RC..</th></tr> <tr><td>06</td></tr> <tr><td>08</td></tr> <tr><td>10</td></tr> <tr><td>12</td></tr> <tr><td>16</td></tr> </table>	RC..	06	08	10	12	16
RC..																		
20																		
25																		
32																		
RC..																		
16																		
25																		
RC..																		
08																		
RC..																		
06																		
08																		
10																		
12																		
16																		
<table border="1"> <tr><td>40x40</td></tr> <tr><td>50x50</td></tr> </table>	40x40	50x50	<table border="1"> <tr><td>40x40</td></tr> </table>	40x40	<table border="1"> <tr><td>20x20</td></tr> <tr><td>32x25</td></tr> </table>	20x20	32x25	<table border="1"> <tr><td>12x12</td></tr> <tr><td>32x25</td></tr> </table>	12x12	32x25								
40x40																		
50x50																		
40x40																		
20x20																		
32x25																		
12x12																		
32x25																		
118 – 123	118 – 123	118 – 123	118 – 123															
SRSC(RL) EXT	C.-SRDCN EXT																	
128	130																	
<table border="1"> <tr><th>RC..</th></tr> <tr><td>06</td></tr> <tr><td>08</td></tr> <tr><td>10</td></tr> <tr><td>12</td></tr> <tr><td>16</td></tr> </table>	RC..	06	08	10	12	16	<table border="1"> <tr><th>RC..</th></tr> <tr><td>10</td></tr> <tr><td>12</td></tr> </table>	RC..	10	12								
RC..																		
06																		
08																		
10																		
12																		
16																		
RC..																		
10																		
12																		
<table border="1"> <tr><td>12x12</td></tr> <tr><td>32x25</td></tr> </table>	12x12	32x25	<table border="1"> <tr><td>C4</td></tr> <tr><td>C5</td></tr> </table>	C4	C5													
12x12																		
32x25																		
C4																		
C5																		
118 – 123	118 – 123																	



RC

06/ 08/ 12/ 16/ 20/ 25/ 32

ISO TURNING – HEAVY ROUGHING – EXTERNAL

KHP-RSCR/L + DKH(RL)

<p>DKHR+KHP-RSCR</p>		RC..
		<p>20 25 32</p>
	<p>40×50 60×80</p>	
<p>131, 132</p>	<p>118 – 123</p>	



RCGT



	INSD	D1	S
	[mm]	[mm]	[mm]
0803	8.0	3.40	3.18
1003	10.0	4.40	3.18

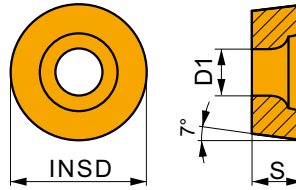

Suitability and starting values for cutting speed (vc), feed (f) and depth of cut (ap). Refer to our Machining Calculator app for further calculations.

Product	RE	P			M			K			N			S			H		
		vc	f	ap	vc	f	ap	vc	f	ap	vc	f	ap	vc	f	ap	vc	f	ap
	[mm]	[m/min]	[mm/rev]	[mm]	[m/min]	[mm/rev]	[mm]	[m/min]	[mm/rev]	[mm]	[m/min]	[mm/rev]	[mm]	[m/min]	[mm/rev]	[mm]	[m/min]	[mm/rev]	[mm]

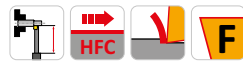
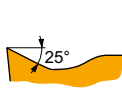

AL geometry with highly positive design for fine-finish to rough machining, and continuous to slightly interrupted cuts.

RCGT 0803MOF-AL	HF7	-	-	-	-	-	-	-	-	285	1.20	1.0	-	-	-	-	-	-
	T0315	-	-	-	-	-	-	-	-	420	1.20	1.0	-	-	-	-	-	-
RCGT 1003MOF-AL	HF7	-	-	-	-	-	-	-	-	255	1.50	1.0	-	-	-	-	-	-
	T0315	-	-	-	-	-	-	-	-	390	1.50	1.0	-	-	-	-	-	-

RCMT



	INSD	D1	S
	[mm]	[mm]	[mm]
0602	6.0	2.80	2.38
0803	8.0	3.40	3.18
10T3	10.0	4.40	3.97
1204	12.0	4.40	4.76
1606	16.0	5.50	6.35
2006	20.0	6.50	6.35
2507	25.0	8.60	7.94

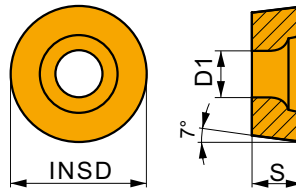

Suitability and starting values for cutting speed (vc), feed (f) and depth of cut (ap). Refer to our Machining Calculator app for further calculations.

Product	RE	P			M			K			N			S			H		
		vc	f	ap	vc	f	ap	vc	f	ap	vc	f	ap	vc	f	ap	vc	f	ap
	[mm]	[m/min]	[mm/rev]	[mm]	[m/min]	[mm/rev]	[mm]	[m/min]	[mm/rev]	[mm]	[m/min]	[mm/rev]	[mm]	[m/min]	[mm/rev]	[mm]	[m/min]	[mm/rev]	[mm]

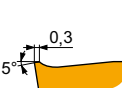

Geometry 37 for semi-rough to heavy-rough machining, and continuous to interrupted cuts.

RCMT 1606MOS-37	T9315	-	165	0.60	3.0	-	-	-	155	0.60	3.0	-	-	-	-	-	-	-
	T9325	-	145	0.60	3.0	-	-	-	135	0.60	3.0	-	-	-	-	-	-	-

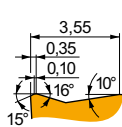

Geometry 371 for semi-rough to heavy-rough machining, and continuous to interrupted cuts.

RCMT 2006MOS-371	T9315	-	145	0.80	3.0	-	-	-	135	0.80	3.0	-	-	-	-	-	-	-
	T9325	-	125	0.80	3.0	-	-	-	115	0.80	3.0	-	-	-	-	-	-	-



Suitability and starting values for cutting speed (vc), feed (f) and depth of cut (ap). Refer to our Machining Calculator app for further calculations.

Product	RE [mm]	P			M			K			N			S			H		
		vc	f	ap	vc	f	ap	vc	f	ap	vc	f	ap	vc	f	ap	vc	f	ap
		[m/min]	[mm/rev]	[mm]	[m/min]	[mm/rev]	[mm]	[m/min]	[mm/rev]	[mm]	[m/min]	[mm/rev]	[mm]	[m/min]	[mm/rev]	[mm]	[m/min]	[mm/rev]	[mm]

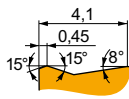

Geometry 372 for semi-rough to heavy-rough machining, continuous to interrupted cuts.

RCMT 2507M05-372	T9325	-	90	0.80	3.0	-	-	-	85	0.80	3.0	-	-	-	-	-	-	-	-
------------------	-------	---	----	------	-----	---	---	---	----	------	-----	---	---	---	---	---	---	---	---

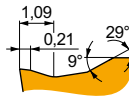

FM geometry for finish to semi-rough machining, and continuous to slightly interrupted cuts.

RCMT 0602M0E-FM	T7325	-	215	0.45	1.2	165	0.41	1.2	-	-	-	-	-	-	-	-	-	-	-
	T8330	-	190	0.45	1.2	110	0.41	1.2	180	0.45	1.2	570	0.54	1.2	-	-	-	-	-
	T8430	-	200	0.45	1.2	110	0.41	1.2	165	0.45	1.2	555	0.54	1.2	-	-	-	-	-
	T9315	-	260	0.45	1.2	-	-	-	245	0.45	1.2	-	-	-	-	-	-	-	-
	T9325	-	235	0.45	1.2	140	0.41	1.2	220	0.45	1.2	-	-	-	-	-	-	-	-
RCMT 0803M0E-FM	T7325	-	190	0.60	1.6	145	0.54	1.6	-	-	-	-	-	-	-	-	-	-	-
	T8330	-	170	0.60	1.6	100	0.54	1.6	160	0.60	1.6	510	0.72	1.6	-	-	-	-	-
	T8430	-	175	0.60	1.6	95	0.54	1.6	140	0.60	1.6	480	0.72	1.6	-	-	-	-	-
	T9315	-	225	0.60	1.6	-	-	-	210	0.60	1.6	-	-	-	-	-	-	-	-
	T9325	-	200	0.60	1.6	120	0.54	1.6	190	0.60	1.6	-	-	-	-	-	-	-	-
RCMT 10T3M0E-FM	T7325	-	185	0.65	1.7	140	0.59	1.7	-	-	-	-	-	-	-	-	-	-	-
	T8330	-	165	0.65	1.7	95	0.59	1.7	155	0.65	1.7	495	0.78	1.7	-	-	-	-	-
	T8430	-	170	0.65	1.7	90	0.59	1.7	135	0.65	1.7	465	0.78	1.7	-	-	-	-	-
	T9315	-	220	0.65	1.7	-	-	-	205	0.65	1.7	-	-	-	-	-	-	-	-
	T9325	-	195	0.65	1.7	115	0.59	1.7	185	0.65	1.7	-	-	-	-	-	-	-	-
RCMT 1204M0E-FM	T7325	-	175	0.70	1.8	135	0.63	1.8	-	-	-	-	-	-	-	-	-	-	-
	T8330	-	160	0.70	1.8	95	0.63	1.8	150	0.70	1.8	480	0.84	1.8	-	-	-	-	-
	T8430	-	155	0.70	1.8	85	0.63	1.8	130	0.70	1.8	435	0.84	1.8	-	-	-	-	-
	T9315	-	205	0.70	1.8	-	-	-	190	0.70	1.8	-	-	-	-	-	-	-	-
	T9325	-	190	0.70	1.8	110	0.63	1.8	180	0.70	1.8	-	-	-	-	-	-	-	-

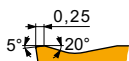

RM3 geometry for semi-rough to rough machining, and continuous to interrupted cuts.

RCMT 0803M0E-RM3	T7325	-	185	0.50	1.3	140	0.45	1.3	-	-	-	-	-	-	-	-	-	-	-
	T9315	-	225	0.50	1.3	-	-	-	210	0.50	1.3	-	-	-	45	0.15	1.0	-	-
RCMT 1204M0E-RM3	H07	-	-	-	-	65	0.54	1.8	105	0.60	1.8	-	-	-	-	-	-	-	-
	T7325	-	165	0.60	1.8	125	0.54	1.8	-	-	-	-	-	-	-	-	-	-	-
	T8330	-	150	0.60	1.8	90	0.54	1.8	140	0.60	1.8	-	-	-	30	0.15	1.0	-	-
	T8430	-	150	0.60	1.8	80	0.54	1.8	125	0.60	1.8	-	-	-	25	0.15	1.0	-	-
	T9315	-	205	0.60	1.8	-	-	-	190	0.60	1.8	-	-	-	40	0.15	1.0	-	-
RCMT 1606M0E-RM3	T7325	-	160	0.65	2.0	120	0.59	2.0	-	-	-	-	-	-	-	-	-	-	-
	T8330	-	145	0.65	2.0	85	0.59	2.0	135	0.65	2.0	-	-	-	25	0.15	1.0	-	-
	T8430	-	145	0.65	2.0	80	0.59	2.0	120	0.65	2.0	-	-	-	25	0.15	1.0	-	-
	T9315	-	195	0.65	2.0	-	-	-	185	0.65	2.0	-	-	-	35	0.15	1.0	-	-
RCMT 2507M0E-RM3	H07	-	-	-	-	60	0.54	3.0	95	0.60	3.0	-	-	-	-	-	-	-	

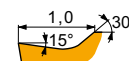

UR geometry for fine to finish machining, and continuous to slightly interrupted cuts.

RCMT 0602M0E-UR	T6310	-	170	0.40	1.2	120	0.36	1.2	135	0.40	1.2	-	-	-	-	-	-	-	-
	T7325	-	190	0.40	1.2	145	0.36	1.2	-	-	-	-	-	-	-	-	-	-	-
	T8330	-	170	0.40	1.2	100	0.36	1.2	160	0.40	1.2	-	-	-	-	-	-	-	-
	T8430	-	180	0.40	1.2	95	0.36	1.2	145	0.40	1.2	-	-	-	-	-	-	-	-
	T9315	-	240	0.40	1.2	-	-	-	225	0.40	1.2	-	-	-	-	-	-	-	-
	T9325	-	215	0.40	1.2	125	0.36	1.2	200	0.40	1.2	-	-	-	-	-	-	-	-



Suitability and starting values for cutting speed (vc), feed (f) and depth of cut (ap). Refer to our Machining Calculator app for further calculations.

Product	RE (mm)	P			M			K			N			S			H		
		vc [m/min]	f [mm/rev]	ap [mm]	vc [m/min]	f [mm/rev]	ap [mm]	vc [m/min]	f [mm/rev]	ap [mm]	vc [m/min]	f [mm/rev]	ap [mm]	vc [m/min]	f [mm/rev]	ap [mm]	vc [m/min]	f [mm/rev]	ap [mm]

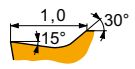

UR geometry for fine to finish machining, and continuous to slightly interrupted cuts.

RCMT 0803MOE-UR	T6310	-	160	0.45	1.6	115	0.41	1.6	125	0.45	1.6	-	-	-	-	-	-	-
	T7325	-	180	0.45	1.6	140	0.41	1.6	-	-	-	-	-	-	-	-	-	-
	T8330	-	160	0.45	1.6	95	0.41	1.6	150	0.45	1.6	-	-	-	-	-	-	-
	T8430	-	170	0.45	1.6	90	0.41	1.6	135	0.45	1.6	-	-	-	-	-	-	-
	T9315	-	220	0.45	1.6	-	-	-	205	0.45	1.6	-	-	-	-	-	-	-
RCMT 10T3MOE-UR	T6310	-	160	0.50	1.4	115	0.45	1.4	125	0.50	1.4	-	-	-	-	-	-	-
	T7325	-	175	0.50	1.4	135	0.45	1.4	-	-	-	-	-	-	-	-	-	-
	T8330	-	160	0.50	1.4	95	0.45	1.4	150	0.50	1.4	-	-	-	-	-	-	-
	T8430	-	165	0.50	1.4	90	0.45	1.4	135	0.50	1.4	-	-	-	-	-	-	-
	T9315	-	215	0.50	1.4	-	-	-	200	0.50	1.4	-	-	-	-	-	-	-
RCMT 1204MOE-UR	T6310	-	150	0.55	1.8	105	0.50	1.8	120	0.55	1.8	-	-	-	-	-	-	-
	T7325	-	165	0.55	1.8	125	0.50	1.8	-	-	-	-	-	-	-	-	-	-
	T8330	-	150	0.55	1.8	90	0.50	1.8	140	0.55	1.8	-	-	-	-	-	-	-
	T8430	-	145	0.55	1.8	80	0.50	1.8	120	0.55	1.8	-	-	-	-	-	-	-
	T9315	-	200	0.55	1.8	-	-	-	190	0.55	1.8	-	-	-	-	-	-	-
T9325	-	190	0.50	1.4	110	0.45	1.4	180	0.50	1.4	-	-	-	-	-	-	-	-
T9325	-	180	0.55	1.8	105	0.50	1.8	170	0.55	1.8	-	-	-	-	-	-	-	-

RCMW



	INSD (mm)	D1 (mm)	S (mm)
0602	6.0	2.80	2.38
0803	8.0	3.40	3.18
10T3	10.0	4.40	3.97
1204	12.0	4.40	4.76

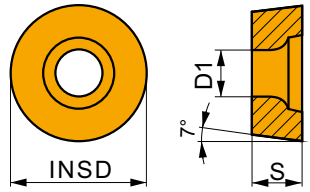

Suitability and starting values for cutting speed (vc), feed (f) and depth of cut (ap). Refer to our Machining Calculator app for further calculations.

Product	RE (mm)	P			M			K			N			S			H		
		vc [m/min]	f [mm/rev]	ap [mm]	vc [m/min]	f [mm/rev]	ap [mm]	vc [m/min]	f [mm/rev]	ap [mm]	vc [m/min]	f [mm/rev]	ap [mm]	vc [m/min]	f [mm/rev]	ap [mm]	vc [m/min]	f [mm/rev]	ap [mm]

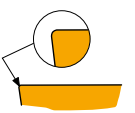

For fine-finish to semi-rough machining, and continuous to slightly interrupted cuts.

RCMW 0602MO	T5305	-	-	-	-	-	-	280	0.25	0.6	-	-	-	-	-	-	55	0.15	1.0
	T5315	-	-	-	-	-	-	250	0.25	0.6	-	-	-	-	-	-	50	0.15	1.0
RCMW 0803MO	T5305	-	-	-	-	-	-	255	0.30	0.8	-	-	-	-	-	-	50	0.15	1.0
	T5315	-	-	-	-	-	-	230	0.30	0.8	-	-	-	-	-	-	45	0.15	1.0
RCMW 10T3MO	T5305	-	-	-	-	-	-	225	0.40	1.0	-	-	-	-	-	-	45	0.15	1.0
	T5315	-	-	-	-	-	-	200	0.40	1.0	-	-	-	-	-	-	40	0.15	1.0
RCMW 1204MO	T5305	-	-	-	-	-	-	205	0.45	1.2	-	-	-	-	-	-	40	0.15	1.0
	T5315	-	-	-	-	-	-	190	0.45	1.2	-	-	-	-	-	-	40	0.15	1.0



RCMX

	INSD	D1	S
	[mm]	[mm]	[mm]
1003	10.0	3.60	3.18
1204	12.0	4.20	4.76
1606	16.0	5.20	6.35
2006	20.0	6.50	6.35
2507	25.0	7.20	7.94
3209	32.0	9.50	9.53

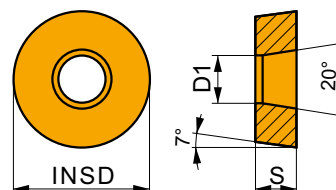

Suitability and starting values for cutting speed (vc), feed (f) and depth of cut (ap). Refer to our Machining Calculator app for further calculations.

Product	RE	P			M			K			N			S			H		
		vc	f	ap	vc	f	ap	vc	f	ap	vc	f	ap	vc	f	ap	vc	f	ap
	[mm]	[m/min]	[mm/rev]	[mm]	[m/min]	[mm/rev]	[mm]	[m/min]	[mm/rev]	[mm]	[m/min]	[mm/rev]	[mm]	[m/min]	[mm/rev]	[mm]	[m/min]	[mm/rev]	[mm]

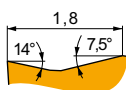

Geometry 31 for finish to semi-rough machining, and continuous to interrupted cuts.

RCMX 1003M05-31

T9325	-	165	0.50	2.0	95	0.45	2.0	155	0.50	2.0	-	-	-	-	-	-	-	-	-
T9335	-	140	0.50	2.0	80	0.45	2.0	-	-	-	-	-	-	-	-	-	-	-	-

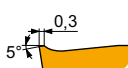

Geometry 37 for semi-rough to heavy-rough machining, and continuous to interrupted cuts.

RCMX 1606M05-37

T9315	-	165	0.60	3.0	-	-	-	155	0.60	3.0	-	-	-	-	-	-	-	-	-
T9325	-	145	0.60	3.0	-	-	-	135	0.60	3.0	-	-	-	-	-	-	-	-	-

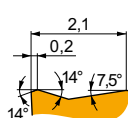

Geometry 321 for semi-rough to heavy-rough machining, and continuous to interrupted cuts.

RCMX 1204M05-321

T9315	-	130	1.00	3.0	-	-	-	120	1.00	3.0	-	-	-	-	-	-	-	-	-
T9325	-	120	1.00	3.0	-	-	-	110	1.00	3.0	-	-	-	-	-	-	-	-	-
T9335	-	105	1.00	3.0	-	-	-	-	-	-	-	-	-	-	-	-	-	-	-

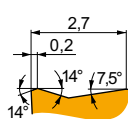

Geometry 331 for semi-rough to heavy-rough machining, and continuous to interrupted cuts.

RCMX 1606M05-331

T9315	-	120	1.20	3.5	-	-	-	110	1.20	3.5	-	-	-	-	-	-	-	-	-
T9325	-	105	1.20	3.5	-	-	-	95	1.20	3.5	-	-	-	-	-	-	-	-	-
T9335	-	110	0.80	3.5	-	-	-	-	-	-	-	-	-	-	-	-	-	-	-

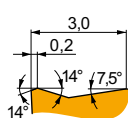

Geometry 341 for semi-rough to heavy-rough machining, and continuous to interrupted cuts.

RCMX 2006M05-341

6640	-	90	1.00	3.5	-	-	-	85	1.00	3.5	-	-	-	-	-	-	-	-	-
------	---	----	------	-----	---	---	---	----	------	-----	---	---	---	---	---	---	---	---	---

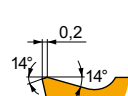

Geometry 351 for semi-rough to heavy-rough machining, and continuous to interrupted cuts.

RCMX 2507M05-351



6640	-	60	1.00	3.5	-	-	-	55	1.00	3.5	-	-	-	-	-	-	-	-	-
------	---	----	------	-----	---	---	---	----	------	-----	---	---	---	---	---	---	---	---	---



Suitability and starting values for cutting speed (vc), feed (f) and depth of cut (ap). Refer to our Machining Calculator app for further calculations.

Product	RE (mm)	P			M			K			N			S			H		
		vc [m/min]	f [mm/rev]	ap [mm]	vc [m/min]	f [mm/rev]	ap [mm]	vc [m/min]	f [mm/rev]	ap [mm]	vc [m/min]	f [mm/rev]	ap [mm]	vc [m/min]	f [mm/rev]	ap [mm]	vc [m/min]	f [mm/rev]	ap [mm]

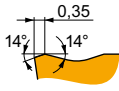



Geometry 361 for rough to heavy-rough machining and continuous to heavy interrupted cuts.

RCMX 3209M0S-361	6640	-	50	1.40	4.5	-	-	-	45	1.40	4.5	-	-	-	-	-	-	-	-
-------------------------	------	---	----	------	-----	---	---	---	----	------	-----	---	---	---	---	---	---	---	---



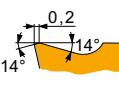

RF1 geometry for finish to semi-rough machining, and continuous to interrupted cuts.

RCMX 2006M0-RF1	T5305	-	105	0.80	3.5	-	-	-	95	0.80	3.5	-	-	-	-	-	-	-	-
	T9310	-	105	0.80	3.5	-	-	-	95	0.80	3.5	-	-	-	-	-	-	-	-
	T9315	-	100	0.80	3.5	-	-	-	95	0.80	3.5	-	-	-	-	-	-	-	-
	T9325	-	90	0.80	3.5	-	-	-	85	0.80	3.5	-	-	-	-	-	-	-	-
	T9335	-	110	0.80	3.5	-	-	-	-	-	-	-	-	-	-	-	-	-	-
RCMX 2507M0-RF1	T8345	-	45	1.00	3.5	-	-	-	40	1.00	3.5	-	-	-	-	-	-	-	-
	T9310	-	95	1.00	3.5	-	-	-	90	1.00	3.5	-	-	-	-	-	-	-	-
	T9315	-	90	1.00	3.5	-	-	-	85	1.00	3.5	-	-	-	-	-	-	-	-
	T9325	-	80	1.00	3.5	-	-	-	75	1.00	3.5	-	-	-	-	-	-	-	-
	T9335	-	65	1.00	3.5	-	-	-	-	-	-	-	-	-	-	-	-	-	-



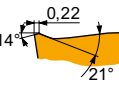

RM1 geometry for finish to rough machining, and continuous to interrupted cuts.

RCMX 2006M0-RM1	T9310	-	95	1.00	3.5	-	-	-	90	1.00	3.5	-	-	-	-	-	-	-	-
	T9315	-	90	1.00	3.5	-	-	-	85	1.00	3.5	-	-	-	-	-	-	-	-
	T9325	-	80	1.00	3.5	-	-	-	75	1.00	3.5	-	-	-	-	-	-	-	-
	T9335	-	125	0.60	3.0	-	-	-	-	-	-	-	-	-	-	-	-	-	-
RCMX 2507M0-RM1	T9310	-	95	1.00	3.5	-	-	-	90	1.00	3.5	-	-	-	-	-	-	-	-
	T9315	-	90	1.00	3.5	-	-	-	85	1.00	3.5	-	-	-	-	-	-	-	-
	T9325	-	80	1.00	3.5	-	-	-	75	1.00	3.5	-	-	-	-	-	-	-	-
	T9335	-	80	0.60	3.0	-	-	-	-	-	-	-	-	-	-	-	-	-	-



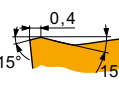

RM2 geometry for semi-rough to rough machining, and continuous to interrupted cuts.

RCMX 2507M0-RM2	T9310	-	90	1.10	3.5	-	-	-	85	1.10	3.5	-	-	-	-	-	-	-	-
	T9315	-	85	1.10	3.5	-	-	-	80	1.10	3.5	-	-	-	-	-	-	-	-
	T9325	-	75	1.10	3.5	-	-	-	70	1.10	3.5	-	-	-	-	-	-	-	-
RCMX 3209M0-RM2	T5315	-	95	1.00	4.5	-	-	-	90	1.00	4.5	-	-	-	-	-	-	-	-
	T9310	-	90	1.00	4.5	-	-	-	85	1.00	4.5	-	-	-	-	-	-	-	-
	T9315	-	85	1.00	4.5	-	-	-	80	1.00	4.5	-	-	-	-	-	-	-	-
	T9325	-	75	1.00	4.5	-	-	-	70	1.00	4.5	-	-	-	-	-	-	-	-
	T9335	-	55	1.40	4.5	-	-	-	-	-	-	-	-	-	-	-	-	-	-

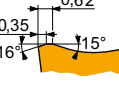

RR2 geometry for heavy rough machining, and continuous to interrupted cuts.

RCMX 3209M0-RR2	T9315	-	60	1.40	4.5	-	-	-	55	1.40	4.5	-	-	-	-	-	-	10	0.15	1.0
	T9316	-	60	1.40	4.5	-	-	-	55	1.40	4.5	-	-	-	-	-	-	-	-	-



RCGX CER

	INSD	S
	[mm]	[mm]
0606	6.350	6.35
0907	9.525	7.94
1207	12.700	7.94

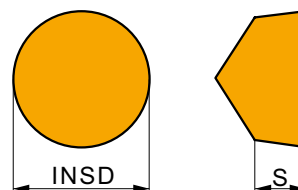

Suitability and starting values for cutting speed (vc), feed (f) and depth of cut (ap). Refer to our Machining Calculator app for further calculations.

Product	RE [mm]	P			M			K			N			S			H		
		vc [m/min]	f [mm/rev]	ap [mm]	vc [m/min]	f [mm/rev]	ap [mm]	vc [m/min]	f [mm/rev]	ap [mm]	vc [m/min]	f [mm/rev]	ap [mm]	vc [m/min]	f [mm/rev]	ap [mm]	vc [m/min]	f [mm/rev]	ap [mm]

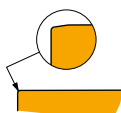

For machining with high speeds and continuous cuts.

RCGX 060600 K15015	TC100	-	-	-	-	-	-	-	☑	365	0.30	0.8	-	-	-	-	-	-	-
RCGX 090700 K15015	TC100	-	-	-	-	-	-	-	☑	410	0.20	1.2	-	-	-	-	-	-	-
RCGX 120700 K15015	TC100	-	-	-	-	-	-	-	☑	405	0.20	1.5	-	-	-	-	-	-	-



PRDCN EXT

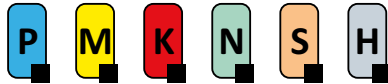

External Lever Lock Tool Holder for Round RC.. Insert

External neutral lever lock tool holder for positive RC.. 16 up to 32 inserts. Suited for external face and longitudinal turning without shoulder, copy turning up to 90°, taper and chamfer turning. Available with shank size 32x25 up to 50x50 mm. Body treated for longer tool life.

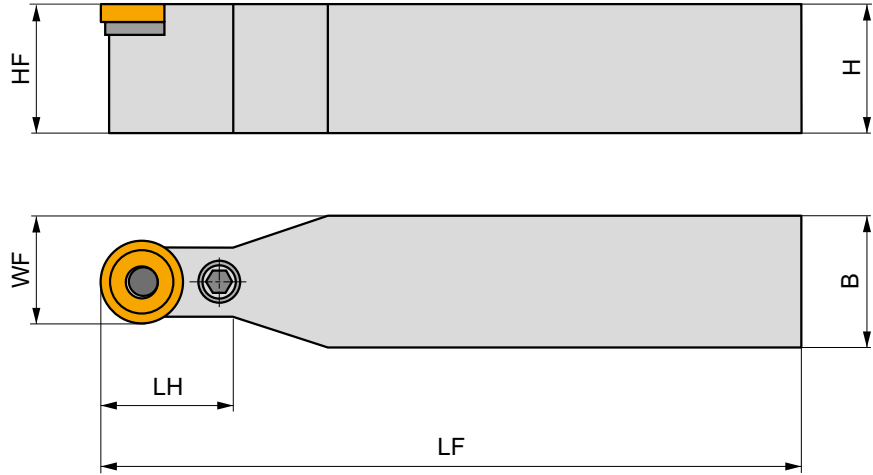
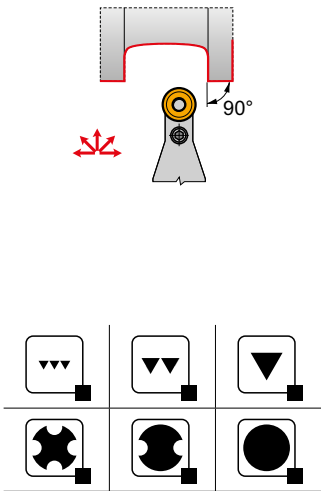

Product	H	B	HF	WF	LF	LH	LAMS	GAMO	kg	Icon 1	Icon 2
	[mm]	[mm]	[mm]	[mm]	[mm]	[mm]	[°]	[°]			
N PRDCN 3225 P 16	32	25	32	20.5	170	32	0	0	0.80	GI090	PRP70
PRDCN 3232 P 20	32	32	32	26	170	32	0	0	1.30	GI069	PRP90
PRDCN 4040 S 20	40	40	40	30	250	40	0	0	3.10	GI069	PRP90
PRDCN 4040 S 25	40	40	40	32.5	250	40	0	0	3.20	GI122	PRP80
PRDCN 5050 S 32	50	50	50	41	250	50	0	0	3.50	GI096	PRP32
PRDCN 5050 T 32	50	50	50	41	300	50	0	0	5.12	GI096	PRP32

Icon	Product
GI069	RCMX 2006MO
GI090	RCMX 1606MO
GI096	RCMX 3209MO
GI122	RCMX 2507MO

Icon 1	Icon 2	Icon 3	Icon 4	Icon 5	Icon 6	Icon 7	Icon 8	Icon 9	Icon 10
PRP32	RCU 320600	PU 10	US 47	8.0	M 12x1	36	NT 08	MT 08	HXK 5
PRP70	RCU 160300	PU 07	US 36	6.0	M 8x1	26	NT 05	MT 05	HXK 4
PRP80	RCU 250600	PU 08	US 38	8.0	M 10x1	29	NT 06	MT 06	HXK 5
PRP90	RCU 200400	PU 09	US 36	6.0	M 8x1	26	NT 07	MT 07	HXK 4



PRSC(RL) EXT



External Lever Lock Tool Holder for Round RC.. Insert

External Right/Left hand lever lock tool holder for positive RC.. 16 up to 25 inserts. Suited for external face and longitudinal turning without shoulder, copy turning up to 27°, taper and chamfer turning, including face copy turning. Available with shank size 32x25 up to 40x40 mm. Body treated for longer tool life.

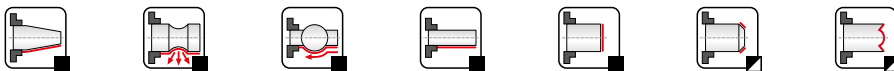
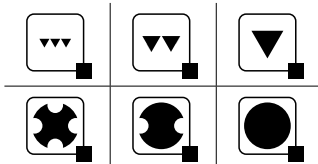
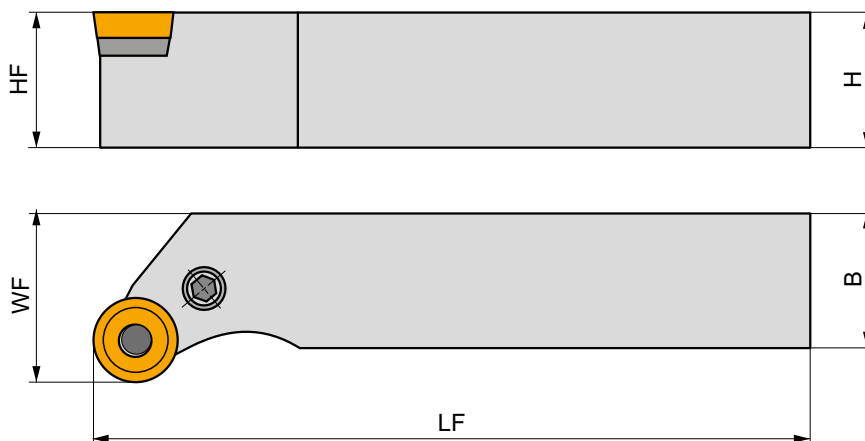
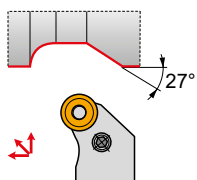

	Product	H	B	HF	WF	LF	LAMS	GAMO	kg		
		[mm]	[mm]	[mm]	[mm]	[mm]	[°]	[°]			
R	PRSCR 3225 P 16	32	25	32	32	170	0	0	0.90	GI090	PRP70
	PRSCR 4040 R 16	40	40	40	50	200	0	0	2.38	GI090	PRP70
	PRSCR 3232 P 20	32	32	32	40	170	0	0	1.40	GI069	PRP90
	PRSCR 4040 S 25	40	40	40	50	250	0	0	3.40	GI122	PRP80
L	PRSCL 3225 P 16	32	25	32	32	170	0	0	0.90	GI090	PRP70
	PRSCL 4040 R 16	40	40	40	50	200	0	0	2.38	GI090	PRP70
	PRSCL 3232 P 20	32	32	32	40	170	0	0	1.32	GI069	PRP90
	PRSCL 4040 S 25	40	40	40	50	250	0	0	3.40	GI122	PRP80



GI069
GI090
GI122

RCMX 2006MO
RCMX 1606MO
RCMX 2507MO



PRP70
PRP80
PRP90

RCU 160300
RCU 250600
RCU 200400

PU 07
PU 08
PU 09

US 36
US 38
US 36

6.0
8.0
6.0

M 8x1
M 10x1
M 8x1

26
29
26

NT 05
NT 06
NT 07

MT 05
MT 06
MT 07

HXK 4
HXK 5
HXK 4



SRDC(RL) EXT

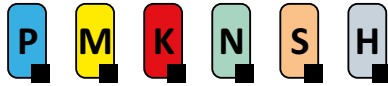

PRAMET

S



External Screw Lock Tool Holder for Round RC.. Insert

External Right/Left hand tool holder for screw type positive RC.. 08 inserts. Suited for external face and longitudinal turning without shoulder, taper and chamfer turning. Available with shank size 20x20 up to 32x25 mm. Body treated for longer tool life.

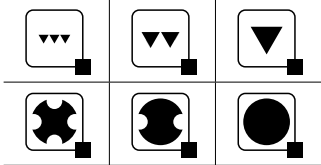
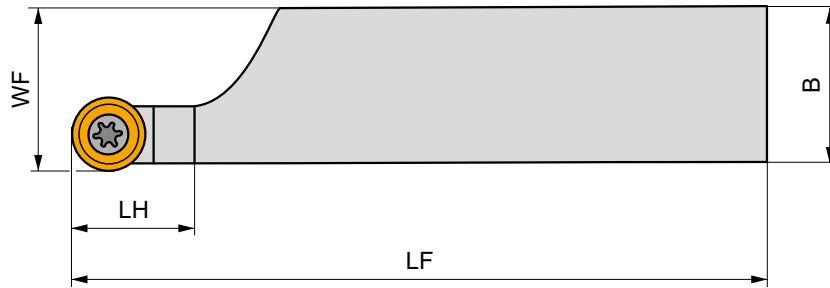

Product	H	B	HF	WF	LF	LH	LAMS	GAMO	kg	GI051	SR21
	[mm]	[mm]	[mm]	[mm]	[mm]	[mm]	[°]	[°]			
R SRDCR 2020 K 08-A	20	20	20	20.5	125	20	0	0	0.36	GI051	SR21
SRDCR 2525 M 08-A	25	25	25	25.5	150	20	0	0	0.66	GI051	SR21
SRDCR 3225 P 08-A	32	25	32	25.5	170	20	0	0	0.95	GI051	SR21
L SRDCL 2020 K 08-A	20	20	20	20.5	125	20	0	0	0.37	GI051	SR21
SRDCL 2525 M 08-A	25	25	25	25.5	150	20	0	0	0.66	GI051	SR21
SRDCL 3225 P 08-A	32	25	32	25.5	170	20	0	0	0.96	GI051	SR21

GI051 RC.. 0803M0

SR21 5513 020-04 1.5 Nm M3 7.2 PT-8002



SRDCN EXT



PRAMET

S



External Screw Lock Tool Holder for Round RC.. Insert

External neutral tool holder for screw type positive RC.. 06 up to 16 inserts. Suited for external face and longitudinal turning without shoulder, copy, taper and chamfer turning. Available with shank size 12x12 up to 32x25 mm. Body treated for longer tool life.

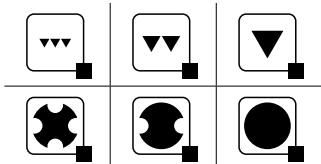
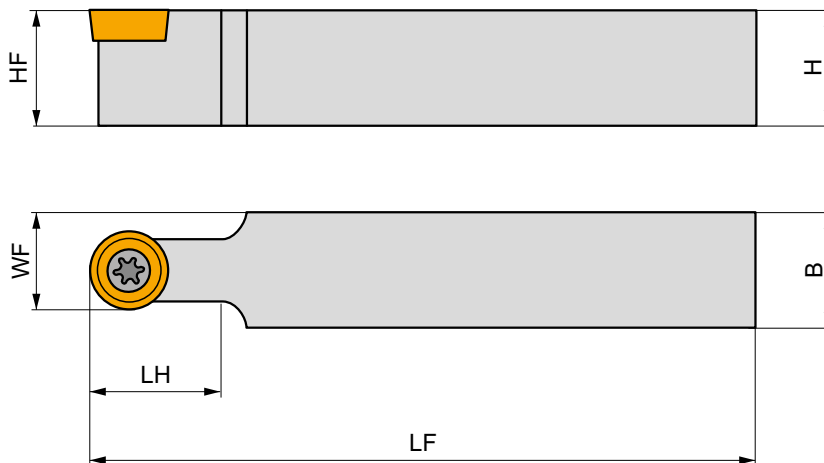
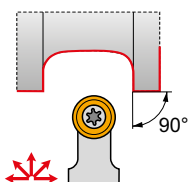

Product	H	B	HF	WF	LF	LH	LAMS	GAMO	kg	GI	SR
	[mm]	[mm]	[mm]	[mm]	[mm]	[mm]	[°]	[°]			
N SRDCN 1212 F 06	12	12	12	9	80	12	0	0	0.10	GI054	SO1
SRDCN 1616 H 06	16	16	16	11	100	12	0	0	0.20	GI054	SO1
SRDCN 2020 K 08	20	20	20	14	125	20	0	0	0.38	GI051	SO3
SRDCN 2020 K 1003-M-A	20	20	20	15	125	25	0	0	0.40	GI064	SR10
SRDCN 2020 K 10-M-A	20	20	20	15	125	25	0	0	0.40	GI013	SR10
SRDCN 2525 M 10-M-A	25	25	25	17.5	150	25	0	0	0.68	GI013	SR10
SRDCN 2525 M 12-M-A	25	25	25	18.5	150	30	0	0	0.68	GI014	SR12
SRDCN 3225 P 10-M	32	25	32	17.5	170	25	0	0	0.90	GI013	SR10
SRDCN 3225 P 12-M	32	25	32	18.5	170	30	0	0	0.90	GI014	SR12
SRDCN 3225 P 16-M	32	25	32	20.5	170	32	0	0	1.00	GI161	SR16

GI	RC..
GI013	RC.. 10T3MO
GI014	RC.. 1204MO
GI051	RC.. 0803MO
GI054	RC.. 0602MO
GI064	RC.. 1003MO
GI161	RC.. 1606MO

SR	US	Nm	M					
SO1	US 2506-T07P	0.9	M 2.5	6.3	-	-	FLAGT07P	-
SO3	US 3007-T09P	2.0	M 3	7.3	-	-	FLAGT09P	-
SR10	US 3510-T15P	3.0	M 3.5	10.6	SRN 100300	MS 3510	FLAGT15P	HXX 3.5
SR12	US 3510-T15P	3.0	M 3.5	10.6	SRN 120300	MS 3510	FLAGT15P	HXX 3.5
SR16	US 5018-T20P	5.0	M 5	18.2	SRN 16T3MO	MS 5015	FLAGT20P	HXX 5



SRSC(RL) EXT

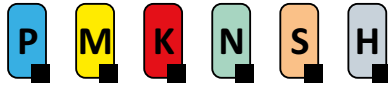

PRAMET

S



External Screw Lock Tool Holder for Round RC.. Insert



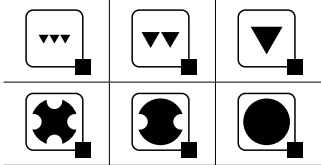
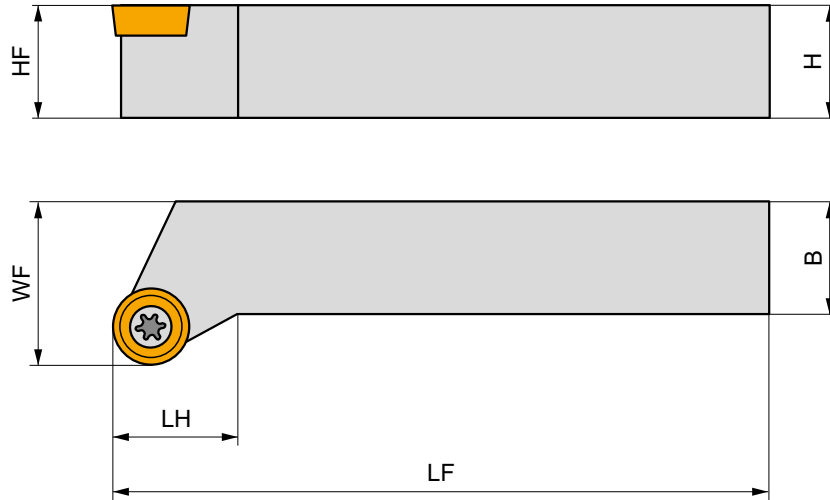
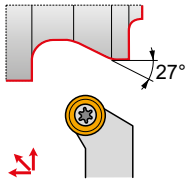





External Right/Left hand tool holder for screw type positive RC.. 06 up to 16 inserts. Suited for external face and longitudinal turning without shoulder, copy, taper and chamfer turning. Available with shank size 12x12 up to 32x25 mm. Body treated for longer tool life.



Product	∅	B	HF	WF	LF	LH	LAMS	GAMO	kg		
	[mm]	[mm]	[mm]	[mm]	[mm]	[mm]	[°]	[°]			
R SRSCR 1212 F 06	12	12	12	16	80	12	0	0	0.09	GI054	S01
SRSCR 1616 H 06	16	16	16	20	100	12	0	0	0.22	GI054	S01
SRSCR 2020 K 08	20	20	20	25	125	20	0	0	0.45	GI051	S03
SRSCR 2020 K 10-M-A	20	20	20	25	125	20	0	0	0.45	GI013	SR10
SRSCR 2525 M 10-M-A	25	25	25	32	150	20	0	0	0.75	GI013	SR10
SRSCR 3225 P 10-M	32	25	32	32	170	20	0	0	1.06	GI013	SR10
SRSCR 2525 M 12-M-A	25	25	25	32	150	20	0	0	0.75	GI014	SR12
SRSCR 3225 P 12-M	32	25	32	32	170	20	0	0	1.07	GI014	SR12
SRSCR 3225 P 16-M	32	25	32	32	170	20	0	0	1.10	GI161	SR16
L SRSCL 1212 F 06	12	12	12	16	80	12	0	0	0.10	GI054	S01
SRSCL 1616 H 06	16	16	16	20	100	12	0	0	0.22	GI054	S01
SRSCL 2020 K 08	20	20	20	25	125	20	0	0	0.45	GI051	S03
SRSCL 2020 K 10-M-A	20	20	20	25	125	20	0	0	0.45	GI013	SR10
SRSCL 2525 M 10-M-A	25	25	25	32	150	20	0	0	0.75	GI013	SR10
SRSCL 3225 P 10-M	32	25	32	32	170	20	0	0	1.06	GI013	SR10
SRSCL 2525 M 12-M-A	25	25	25	32	150	20	0	0	0.75	GI014	SR12
SRSCL 3225 P 12-M	32	25	32	32	170	20	0	0	1.07	GI014	SR12
SRSCL 3225 P 16-M	32	25	32	32	170	20	0	0	1.10	GI161	SR16

GI013	RC.. 10T3MO
GI014	RC.. 1204MO
GI051	RC.. 0803MO
GI054	RC.. 0602MO
GI161	RC.. 1606MO



								
S01	US 2506-T07P	0.9	M 2.5	6.3	–	–	FLAG T07P	–
S03	US 3007-T09P	2.0	M 3	7.3	–	–	FLAG T09P	–
SR10	US 3510-T15P	3.0	M 3.5	10.6	SRN 100300	MS 3510	FLAG T15P	HXK 3.5
SR12	US 3510-T15P	3.0	M 3.5	10.6	SRN 120300	MS 3510	FLAG T15P	HXK 3.5
SR16	US 5018-T20P	5.0	M 5	18.2	SRN 16T3MO	MS 5015	FLAG T20P	HXK 5



C.-SRDCN EXT



PRAMET

S

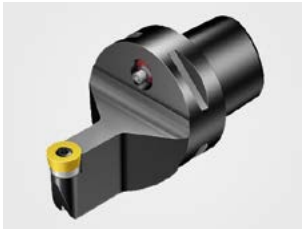

External PSC Quick Change Tool, Screw Lock for RC.. Insert

External neutral tool, through coolant, for screw type positive RC.. 10 up to 12 inserts. Suited for external face and longitudinal turning without shoulder, copy, taper and chamfer turning. Available with PSC (Polygon Shank Coupling) size C4 and C5. Body treated for longer tool life.

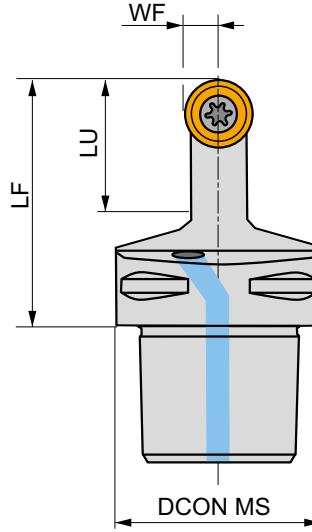
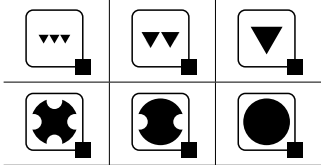
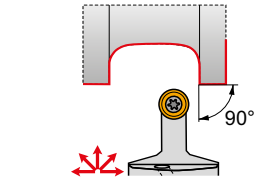

Product	DCON MS [mm]	WF [mm]	LF [mm]	LU [mm]	LAMS [°]	GAMO [°]		kg		
N C4-SRDCN-00050-12A	40	6	50	28	0	0	✓	0.32	GI014	C-SR12V-1
C5-SRDCN-00060-10A	50	5	60	25	0	0	✓	0.56	GI013	C-SR10V
C5-SRDCN-00060-12A	50	6	60	28	0	0	✓	0.56	GI014	C-SR12V-2

GI013	RC.. 10T3M0
GI014	RC.. 1204M0

C-SR10V	US 2010-T15P	3.0	M 3.5	10.1	SRS 110-01	MS 9001	FLAG T15P/3,5	CN 034-02
C-SR12V-1	US 2001-T15P	3.0	M 3.5	12.1	SRS 110-02	MS 9001	FLAG T15P/3,5	CN 034-01
C-SR12V-2	US 2001-T15P	3.0	M 3.5	12.1	SRS 110-02	MS 9001	FLAG T15P/3,5	CN 034-02



KHP-RSC(RL)



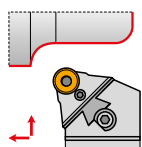

Modular KHP Lever Lock Turning Cartridge for RC.. Insert

Dovetailed Right/Left hand lever lock turning cartridge for mounting on DKH tool holder shank. Suited for heavy longitudinal turning without shoulder, face turning, taper and chamfer turning with positive RC.. 20 up to 32 inserts. Tool holder treated for longer tool life.

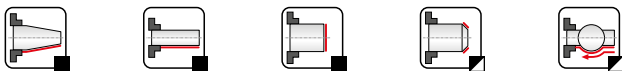
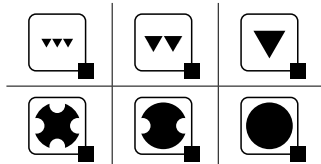
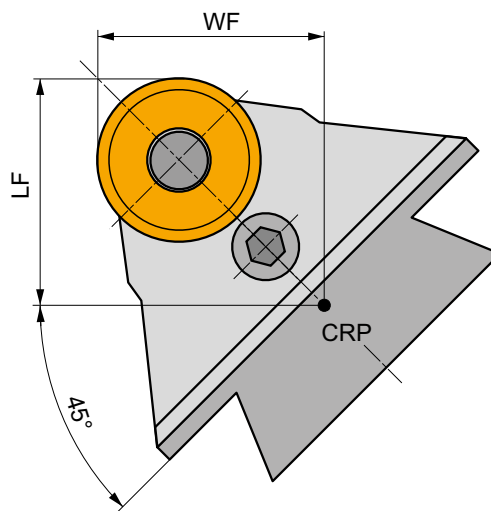

DKHR+KHP-RSCR



Product	WF	LF	LAMS	GAMO	kg			
	[mm]	[mm]	[°]	[°]				
R	KHP-RSCR 20	35	45	0	0	1.25	GI069	PRP90
	KHP-RSCR 25	35	45	0	0	1.30	GI122	PRP80
	KHP-RSCR 32	35	45	0	0	1.30	GI096	PRP32
	KHP-RSCL 20	35	45	0	0	1.30	GI069	PRP90
	KHP-RSCL 25	35	45	0	0	1.30	GI122	PRP80
	KHP-RSCL 32	35	45	0	0	1.30	GI096	PRP32



GI069

RCMX 2006MO

GI096

RCMX 3209MO

GI122

RCMX 2507MO



PRP32

RCU 320600

PU 10

US 47

8.0

M 12x1

36

NT 08

MT 08

HXK 5

PRP80

RCU 250600

PU 08

US 38

8.0

M 10x1

29

NT 06

MT 06

HXK 5

PRP90

RCU 200400

PU 09

US 36

6.0

M 8x1

26

NT 07

MT 07

HXK 4



DKH(RL)



External Tool Holder Shank for KHP/KHS Heavy Turning Cartridges

Dovetailed Right/Left hand modular tool shank for KHP/KHS cartridges. Suited for heavy turning applications. Available with shank size 40x50 up to 60x80 mm. Body treated for longer tool life.

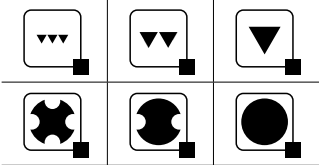
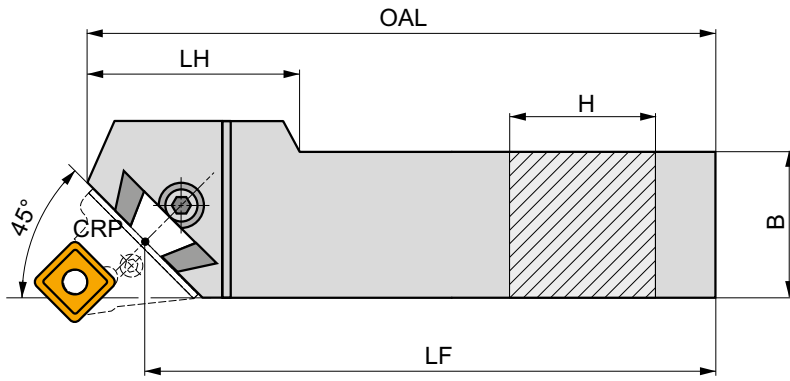
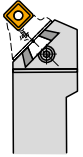

	Product	H	B	LF	OAL	LH	kg	Cartridge	Tool
		[mm]	[mm]	[mm]	[mm]	[mm]			
R	DKHR 4050 V	40	50	400	425	100	7.10	GI098	DKH10
	DKHR 5060 W	50	60	450	475	110	11.30	GI098	DKH10
	DKHR 6080 W-A	60	80	450	485	90	19.65	GI098	DKH10
L	DKHL 4050 V	40	50	400	425	100	7.10	GI098	DKH10
	DKHL 5060 W	50	60	450	475	110	11.30	GI098	DKH10
	DKHL 6080 W-A	60	80	450	485	90	19.28	GI098	DKH10

GI098	KHP	KHS

DKH10	SR 14	HXK 10



SC

09/ 12/ 25/ 38

CARBIDE INSERTS

SCGT



134

SCMT



135

SCMW



138

MATCH THE RIGHT SIZE (example)

Insert

SCMT 120408E-RM

Tool Holder

SSDCN 2020 K 12-M-A

ISO TURNING – EXTERNAL

SSBC(RL) EXT

75°

SC..

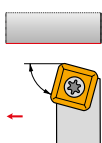
09
12
25
38
 $\frac{12 \times 12}{60 \times 60}$

139

134 – 138

SSDCN EXT

45°

SC..

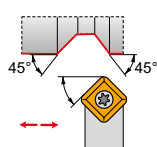
09
12
 $\frac{12 \times 12}{25 \times 25}$

140

134 – 138

SSKC(RL) EXT

75°

SC..

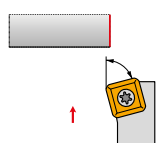
09
12
 $\frac{12 \times 12}{25 \times 25}$

141

134 – 138

ISO TURNING – HEAVY ROUGHING – EXTERNAL

KHS-SBCR + DKH(RL)

75°

SC..

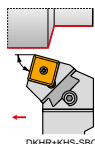
25
38

DKHR+KHS-SBC

 $\frac{40 \times 50}{60 \times 80}$

142, 143

134 – 138

ISO TURNING – INTERNAL

SSSC(RL) INT

45°

SC..

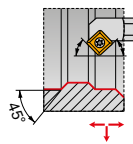

09

 $\frac{25}{32}$

144

134 – 138



SCGT



	IC	D1	L	S
	[mm]	[mm]	[mm]	[mm]
09T3	9.525	4.40	9.53	3.97
09T3-SF3	9.525	4.40	9.53	4.22
1204	12.700	5.50	12.70	4.76

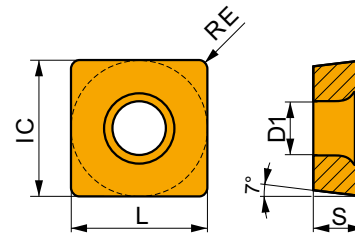

Suitability and starting values for cutting speed (vc), feed (f) and depth of cut (ap). Refer to our Machining Calculator app for further calculations.

Product	RE	P			M			K			N			S			H		
		vc	f	ap	vc	f	ap	vc	f	ap	vc	f	ap	vc	f	ap	vc	f	ap
	[mm]	[m/min]	[mm/rev]	[mm]	[m/min]	[mm/rev]	[mm]	[m/min]	[mm/rev]	[mm]	[m/min]	[mm/rev]	[mm]	[m/min]	[mm/rev]	[mm]	[m/min]	[mm/rev]	[mm]



AL geometry with highly positive design for fine-finish to rough machining, and continuous to slightly interrupted cuts.

SCGT 120408F-AL	H07	0.8	-	-	-	-	-	-	-	315	0.48	2.0	-	-	-	-	-	-	-
	T0315	0.8	-	-	-	-	-	-	-	465	0.48	2.0	-	-	-	-	-	-	-



NF1 geometry with positive design for fine-finish to medium machining and continuous cuts.

SCGT 09T308E-NF1	H07	0.8	-	-	-	100	0.13	1.2	-	-	-	510	0.17	1.2	50	0.13	1.0	-	-	-
	T6310	0.8	200	0.14	1.2	140	0.13	1.2	-	-	-	600	0.17	1.2	60	0.13	1.0	40	0.15	1.0
	T7325	0.8	225	0.14	1.2	175	0.13	1.2	-	-	-	-	-	-	70	0.13	1.0	-	-	-
SCGT 120408E-NF1	H07	0.8	-	-	-	90	0.16	1.4	-	-	-	455	0.22	1.4	45	0.16	1.1	-	-	-
	T6310	0.8	180	0.18	1.4	125	0.16	1.4	-	-	-	540	0.22	1.4	50	0.16	1.1	35	0.15	1.0
	T7325	0.8	205	0.18	1.4	155	0.16	1.4	-	-	-	-	-	-	65	0.16	1.1	-	-	-

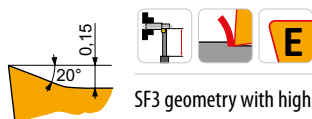
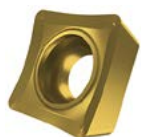

SF3 geometry with highly positive design for fine to finish machining, and continuous cuts.

SCGT 09T304E-SF3	H07	0.4	-	-	-	95	0.09	1.0	155	0.10	1.0	495	0.12	1.0	50	0.07	0.8	-	-	-
	T6310	0.4	185	0.10	1.0	130	0.09	1.0	145	0.10	1.0	555	0.12	1.0	55	0.07	0.8	35	0.15	1.0
	T8315	0.4	200	0.10	1.0	120	0.09	1.0	190	0.10	1.0	600	0.12	1.0	50	0.07	0.8	40	0.15	1.0
SCGT 09T308E-SF3	T6310	0.8	210	0.12	1.0	150	0.12	1.0	165	0.12	1.0	630	0.14	1.0	60	0.11	0.8	40	0.15	1.0
	T8315	0.8	220	0.12	1.0	130	0.12	1.0	205	0.12	1.0	660	0.14	1.0	55	0.11	0.8	40	0.15	1.0



SCMT



	IC [mm]	D1 [mm]	L [mm]	S [mm]
09T3	9.525	4.40	9.53	3.97
1204	12.700	5.50	12.70	4.76
2509	25.400	8.70	25.40	9.53
3809	38.100	8.70	38.10	9.53

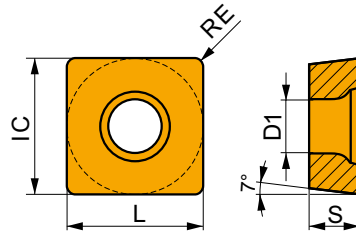

Suitability and starting values for cutting speed (vc), feed (f) and depth of cut (ap). Refer to our Machining Calculator app for further calculations.

Product	RE [mm]	P			M			K			N			S			H		
		vc [m/min]	f [mm/rev]	ap [mm]	vc [m/min]	f [mm/rev]	ap [mm]	vc [m/min]	f [mm/rev]	ap [mm]	vc [m/min]	f [mm/rev]	ap [mm]	vc [m/min]	f [mm/rev]	ap [mm]	vc [m/min]	f [mm/rev]	ap [mm]

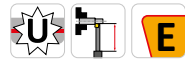
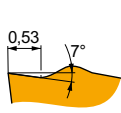

FF2 geometry with positive design for fine-finish to finish machining, and continuous to slightly interrupted cuts.

SCMT 09T304E-FF2	T8430	0.4	210	0.12	1.2	-	-	-	175	0.12	1.2	-	-	-	-	-	-	-
	T9325	0.4	260	0.12	1.2	-	-	-	245	0.12	1.2	-	-	-	-	-	-	-
SCMT 09T308E-FF2	T8330	0.8	185	0.17	1.2	-	-	-	175	0.17	1.2	-	-	-	-	-	-	-
	T8430	0.8	220	0.17	1.2	-	-	-	180	0.17	1.2	-	-	-	-	-	-	-
	T9325	0.8	265	0.17	1.2	-	-	-	250	0.17	1.2	-	-	-	-	-	-	-

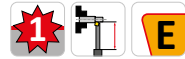
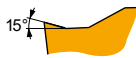
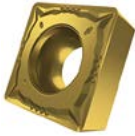

FM geometry for finish to semi-rough machining, and continuous to slightly interrupted cuts.

SCMT 09T304E-FM	T7325	0.4	205	0.15	1.2	155	0.15	1.2	-	-	-	-	-	-	-	-	-	-	
	T7335	0.4	200	0.15	1.2	155	0.15	1.2	-	-	-	-	-	-	-	-	-	-	
	T8315	0.4	190	0.15	1.2	110	0.14	1.2	180	0.15	1.2	570	0.18	1.2	-	-	-	-	
	T8330	0.4	180	0.15	1.2	105	0.14	1.2	170	0.15	1.2	540	0.18	1.2	-	-	-	-	
	T8430	0.4	210	0.15	1.2	115	0.14	1.2	175	0.15	1.2	585	0.18	1.2	-	-	-	-	
	T9315	0.4	290	0.15	1.2	-	-	-	275	0.15	1.2	-	-	-	-	-	-	-	-
	T9325	0.4	260	0.15	1.2	155	0.15	1.2	245	0.15	1.2	-	-	-	-	-	-	-	
SCMT 09T308E-FM	T7325	0.8	225	0.20	1.2	175	0.18	1.2	-	-	-	-	-	-	-	-	-	-	
	T7335	0.8	215	0.20	1.2	165	0.18	1.2	-	-	-	-	-	-	-	-	-	-	
	T8315	0.8	205	0.20	1.2	120	0.18	1.2	190	0.20	1.2	615	0.24	1.2	-	-	-	-	
	T8330	0.8	195	0.20	1.2	115	0.18	1.2	185	0.20	1.2	585	0.24	1.2	-	-	-	-	
	T8430	0.8	225	0.20	1.2	120	0.18	1.2	185	0.20	1.2	615	0.24	1.2	-	-	-	-	
	T9315	0.8	305	0.20	1.2	-	-	-	285	0.20	1.2	-	-	-	-	-	-	-	
	T9325	0.8	275	0.20	1.2	165	0.18	1.2	260	0.20	1.2	-	-	-	-	-	-	-	
SCMT 120404E-FM	T7325	0.4	195	0.15	1.6	150	0.15	1.6	-	-	-	-	-	-	-	-	-	-	
	T8315	0.4	185	0.15	1.6	110	0.14	1.6	175	0.15	1.6	555	0.18	1.6	-	-	-	-	
	T8330	0.4	170	0.15	1.6	100	0.14	1.6	160	0.15	1.6	510	0.18	1.6	-	-	-	-	
	T8430	0.4	205	0.15	1.6	110	0.14	1.6	170	0.15	1.6	570	0.18	1.6	-	-	-	-	
	T9315	0.4	280	0.15	1.6	-	-	-	265	0.15	1.6	-	-	-	-	-	-	-	
	T9325	0.4	250	0.15	1.6	150	0.15	1.6	235	0.15	1.6	-	-	-	-	-	-	-	
	T9325	0.4	250	0.15	1.6	150	0.15	1.6	235	0.15	1.6	-	-	-	-	-	-	-	
SCMT 120408E-FM	T7325	0.8	215	0.20	1.6	165	0.18	1.6	-	-	-	-	-	-	-	-	-	-	
	T7335	0.8	210	0.20	1.6	160	0.18	1.6	-	-	-	-	-	-	-	-	-	-	
	T8315	0.8	200	0.20	1.6	120	0.18	1.6	190	0.20	1.6	600	0.24	1.6	-	-	-	-	
	T8330	0.8	190	0.20	1.6	110	0.18	1.6	180	0.20	1.6	570	0.24	1.6	-	-	-	-	
	T8430	0.8	220	0.20	1.6	120	0.18	1.6	180	0.20	1.6	600	0.24	1.6	-	-	-	-	
	T9315	0.8	300	0.20	1.6	-	-	-	285	0.20	1.6	-	-	-	-	-	-	-	
	T9325	0.8	265	0.20	1.6	155	0.18	1.6	250	0.20	1.6	-	-	-	-	-	-	-	
SCMT 120412E-FM	T7325	1.2	210	0.27	1.6	160	0.24	1.6	-	-	-	-	-	-	-	-	-	-	
	T8330	1.2	185	0.27	1.6	110	0.24	1.6	175	0.27	1.6	555	0.32	1.6	-	-	-	-	
	T8430	1.2	200	0.27	1.6	110	0.24	1.6	165	0.27	1.6	555	0.32	1.6	-	-	-	-	
	T9315	1.2	275	0.27	1.6	-	-	-	260	0.27	1.6	-	-	-	-	-	-	-	
	T9325	1.2	245	0.27	1.6	145	0.24	1.6	230	0.27	1.6	-	-	-	-	-	-	-	



Suitability and starting values for cutting speed (vc), feed (f) and depth of cut (ap). Refer to our Machining Calculator app for further calculations.

Product	RE (mm)	P			M			K			N			S			H		
		vc [m/min]	f [mm/rev]	ap [mm]	vc [m/min]	f [mm/rev]	ap [mm]	vc [m/min]	f [mm/rev]	ap [mm]	vc [m/min]	f [mm/rev]	ap [mm]	vc [m/min]	f [mm/rev]	ap [mm]	vc [m/min]	f [mm/rev]	ap [mm]

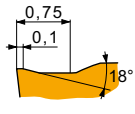

FM2 geometry for finish to medium machining, and continuous to interrupted cuts.

SCMT 09T304E-FM2	T7325	0.4	200	0.12	1.0	155	0.11	1.0	-	-	-	-	-	-	-	-	-	-
	T8430	0.4	220	0.12	1.0	120	0.11	1.0	180	0.12	1.0	-	-	-	-	-	-	-
	T9325	0.4	265	0.12	1.0	155	0.11	1.0	250	0.12	1.0	-	-	-	-	-	-	-
SCMT 09T308E-FM2	T8330	0.8	190	0.17	1.0	110	0.15	1.0	180	0.17	1.0	-	-	-	-	-	-	-
	T8430	0.8	225	0.17	1.0	120	0.15	1.0	185	0.17	1.0	-	-	-	-	-	-	-
	T9315	0.8	305	0.17	1.0	-	-	-	285	0.17	1.0	-	-	-	-	-	-	-
	T9325	0.8	270	0.17	1.0	160	0.15	1.0	255	0.17	1.0	-	-	-	-	-	-	-
	T9335	0.8	235	0.17	1.0	140	0.15	1.0	-	-	-	-	-	-	-	-	-	-

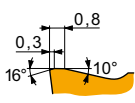

RF geometry for semi-rough to rough machining, and continuous to interrupted cuts.

SCMT 09T308E-RF	T5315	0.8	255	0.20	1.5	-	-	-	240	0.20	1.5	-	-	-	-	-	50	0.15	1.0
	T7335	0.8	170	0.20	1.5	130	0.18	1.5	-	-	-	-	-	-	-	-	-	-	
	T9325	0.8	220	0.20	1.5	130	0.18	1.5	205	0.20	1.5	-	-	-	-	-	-	-	
SCMT 120408E-RF	T5315	0.8	240	0.22	2.2	-	-	-	225	0.22	2.2	-	-	-	-	-	45	0.15	1.0
	T7335	0.8	160	0.22	2.2	120	0.22	2.2	-	-	-	-	-	-	-	-	-	-	
	T9325	0.8	205	0.22	2.2	120	0.22	2.2	190	0.22	2.2	-	-	-	-	-	-	-	

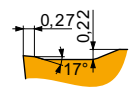

RM geometry for semi-rough to rough machining, and continuous to interrupted cuts.

SCMT 09T308E-RM	T5315	0.8	275	0.30	2.0	-	-	-	260	0.30	2.0	-	-	-	-	-	55	0.15	1.0	
	T7335	0.8	190	0.30	2.0	145	0.27	2.0	-	-	-	60	0.24	1.6	-	-	-	-		
	T8330	0.8	175	0.30	2.0	105	0.27	2.0	165	0.30	2.0	-	-	-	40	0.24	1.6	35	0.15	1.0
	T8430	0.8	190	0.30	2.0	105	0.27	2.0	155	0.30	2.0	-	-	-	40	0.24	1.6	30	0.15	1.0
	T9315	0.8	255	0.30	2.0	-	-	-	240	0.30	2.0	-	-	-	-	-	-	50	0.15	1.0
	T9325	0.8	230	0.30	2.0	135	0.27	2.0	215	0.30	2.0	-	-	-	50	0.24	1.6	-	-	-
SCMT 120408E-RM	T5305	0.8	305	0.30	2.3	-	-	-	285	0.30	2.3	-	-	-	-	-	60	0.15	1.0	
	T5315	0.8	275	0.30	2.3	-	-	-	260	0.30	2.3	-	-	-	-	-	55	0.15	1.0	
	T7335	0.8	185	0.30	2.3	140	0.27	2.3	-	-	-	60	0.24	1.8	-	-	-	-		
	T8330	0.8	175	0.30	2.3	105	0.27	2.3	165	0.30	2.3	-	-	-	40	0.24	1.8	35	0.15	1.0
	T8430	0.8	190	0.30	2.3	105	0.27	2.3	155	0.30	2.3	-	-	-	40	0.24	1.8	30	0.15	1.0
	T9315	0.8	250	0.30	2.3	-	-	-	235	0.30	2.3	-	-	-	-	-	-	50	0.15	1.0
	T9325	0.8	225	0.30	2.3	135	0.27	2.3	210	0.30	2.3	-	-	-	50	0.24	1.8	-	-	-

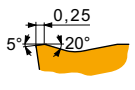

RM3 geometry for semi-rough to rough machining, and continuous to interrupted cuts.

SCMT 120408E-RM3	T6310	0.8	155	0.27	2.3	110	0.27	2.3	125	0.27	2.3	-	-	-	-	-	30	0.15	1.0
	T8330	0.8	155	0.27	2.3	90	0.27	2.3	145	0.27	2.3	-	-	-	-	-	30	0.15	1.0
	T8430	0.8	170	0.27	2.3	90	0.27	2.3	135	0.27	2.3	-	-	-	-	-	25	0.15	1.0
	T9315	0.8	225	0.27	2.3	-	-	-	210	0.27	2.3	-	-	-	-	-	45	0.15	1.0
	T9325	0.8	205	0.27	2.3	120	0.27	2.3	190	0.27	2.3	-	-	-	-	-	-	-	-
	T9335	0.8	175	0.27	2.3	105	0.27	2.3	-	-	-	-	-	-	-	-	-	-	-
SCMT 120412E-RM3	T7325	1.2	175	0.30	2.3	135	0.27	2.3	-	-	-	-	-	-	-	-	-	-	
	T9325	1.2	205	0.30	2.3	120	0.27	2.3	190	0.30	2.3	-	-	-	-	-	-	-	



Suitability and starting values for cutting speed (vc), feed (f) and depth of cut (ap). Refer to our Machining Calculator app for further calculations.

Product	RE [mm]	P			M			K			N			S			H		
		vc [m/min]	f [mm/rev]	ap [mm]	vc [m/min]	f [mm/rev]	ap [mm]	vc [m/min]	f [mm/rev]	ap [mm]	vc [m/min]	f [mm/rev]	ap [mm]	vc [m/min]	f [mm/rev]	ap [mm]	vc [m/min]	f [mm/rev]	ap [mm]

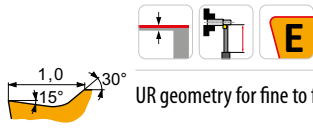
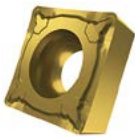

UR geometry for fine to finish machining, and continuous to slightly interrupted cuts.

SCMT 09T304E-UR	T7325	0.4	175	0.15	1.2	135	0.15	1.2	-	-	-	-	-	-	-	-	-	-	
	T8330	0.4	155	0.15	1.2	90	0.14	1.2	145	0.15	1.2	-	-	-	-	-	-	-	
	T8430	0.4	180	0.15	1.2	95	0.14	1.2	145	0.15	1.2	-	-	-	-	-	-	-	
	T9315	0.4	250	0.15	1.2	-	-	-	235	0.15	1.2	-	-	-	-	-	-	-	-
	T9325	0.4	225	0.15	1.2	135	0.15	1.2	210	0.15	1.2	-	-	-	-	-	-	-	
SCMT 09T308E-UR	T5315	0.8	280	0.20	1.2	-	-	-	265	0.20	1.2	-	-	-	-	-	-	-	
	T7325	0.8	195	0.20	1.2	150	0.18	1.2	-	-	-	-	-	-	-	-	-	-	
	T8330	0.8	170	0.20	1.2	100	0.18	1.2	160	0.20	1.2	-	-	-	-	-	-	-	
	T8430	0.8	190	0.20	1.2	105	0.18	1.2	155	0.20	1.2	-	-	-	-	-	-	-	
	T9315	0.8	260	0.20	1.2	-	-	-	245	0.20	1.2	-	-	-	-	-	-	-	
SCMT 120408E-UR	T5315	0.8	270	0.20	1.6	-	-	-	255	0.20	1.6	-	-	-	-	-	-	-	
	T7325	0.8	185	0.20	1.6	140	0.18	1.6	-	-	-	-	-	-	-	-	-	-	
	T8330	0.8	165	0.20	1.6	95	0.18	1.6	155	0.20	1.6	-	-	-	-	-	-	-	
	T8430	0.8	185	0.20	1.6	100	0.18	1.6	150	0.20	1.6	-	-	-	-	-	-	-	
	T9315	0.8	260	0.20	1.6	-	-	-	245	0.20	1.6	-	-	-	-	-	-	-	
SCMT 120412E-UR	T9325	0.8	230	0.20	1.6	135	0.18	1.6	215	0.20	1.6	-	-	-	-	-	-	-	
	T8330	1.2	160	0.27	1.6	95	0.24	1.6	150	0.27	1.6	-	-	-	-	-	-	-	
	T8430	1.2	175	0.27	1.6	95	0.24	1.6	140	0.27	1.6	-	-	-	-	-	-	-	
	T9325	1.2	215	0.27	1.6	125	0.24	1.6	200	0.27	1.6	-	-	-	-	-	-	-	

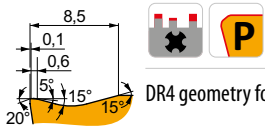

DR4 geometry for rough to heavy-rough machining, and continuous to interrupted cuts.

SCMT 380932E-DR4	T9335	3.2	50	1.33	16.0	30	1.20	16.0	-	-	-	-	-	-	-	-	-
------------------	-------	-----	----	------	------	----	------	------	---	---	---	---	---	---	---	---	---

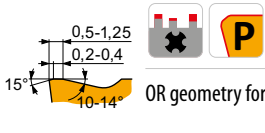

OR geometry for rough to heavy-rough machining, and continuous to interrupted cuts.

SCMT 250924E-OR	T9226	2.4	80	1.00	10.0	45	0.90	10.0	75	1.00	10.0	-	-	-	15	0.70	8.0	-	-	-
	T9325	2.4	90	1.00	10.0	50	0.90	10.0	85	1.00	10.0	-	-	-	20	0.70	8.0	-	-	-
	T9335	2.4	70	1.00	10.0	40	0.90	10.0	-	-	-	-	-	-	15	0.70	8.0	-	-	-
SCMT 380932E-OR	6635	3.2	60	1.20	18.0	35	1.08	18.0	-	-	-	-	-	-	15	1.08	9.9	-	-	-
	T9226	3.2	65	1.20	18.0	35	1.08	18.0	60	1.20	18.0	-	-	-	10	1.08	9.9	-	-	-
	T9315	3.2	85	1.20	18.0	-	-	-	80	1.20	18.0	-	-	-	-	-	-	-	-	-
	T9325	3.2	80	1.20	18.0	45	1.08	18.0	75	1.20	18.0	-	-	-	15	1.08	9.9	-	-	-
	T9335	3.2	60	1.20	18.0	35	1.08	18.0	-	-	-	-	-	-	10	1.08	9.9	-	-	-

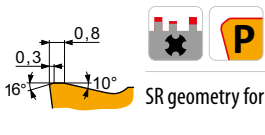

SR geometry for rough to heavy-rough machining, and continuous to interrupted cuts.

SCMT 250924E-SR	T9325	2.4	70	1.00	14.0	40	0.90	14.0	65	1.00	14.0	-	-	-	-	-	-
	T9335	2.4	60	1.00	14.0	35	0.90	14.0	-	-	-	-	-	-	-	-	-
SCMT 380932E-SR	T9335	3.2	50	1.30	20.0	30	1.30	20.0	-	-	-	-	-	-	-	-	-



SCMW



	IC	D1	L	S
	[mm]	[mm]	[mm]	[mm]
09T3	9.525	4.40	9.53	3.97
1204	12.700	5.50	12.70	4.76

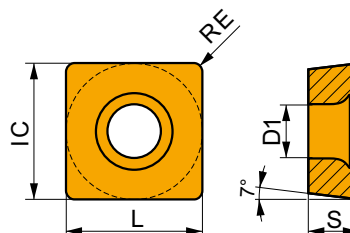

Suitability and starting values for cutting speed (vc), feed (f) and depth of cut (ap). Refer to our Machining Calculator app for further calculations.

Product	RE [mm]	P			M			K			N			S			H		
		vc [m/min]	f [mm/rev]	ap [mm]	vc [m/min]	f [mm/rev]	ap [mm]	vc [m/min]	f [mm/rev]	ap [mm]	vc [m/min]	f [mm/rev]	ap [mm]	vc [m/min]	f [mm/rev]	ap [mm]	vc [m/min]	f [mm/rev]	ap [mm]

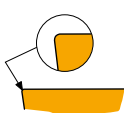

For fine-finish to semi-rough machining, and continuous to slightly interrupted cuts.

SCMW 09T304	T5305	0.4	-	-	-	-	-	-	240	0.10	2.0	-	-	-	-	-	-	50	0.15	1.0
	T5315	0.4	-	-	-	-	-	-	205	0.10	2.0	-	-	-	-	-	-	40	0.15	1.0
SCMW 09T308	T5305	0.8	-	-	-	-	-	-	220	0.20	2.0	-	-	-	-	-	-	45	0.15	1.0
	T5315	0.8	-	-	-	-	-	-	190	0.20	2.0	-	-	-	-	-	-	40	0.15	1.0
SCMW 120408	T5305	0.8	-	-	-	-	-	-	205	0.20	4.0	-	-	-	-	-	-	40	0.15	1.0
	T5315	0.8	-	-	-	-	-	-	185	0.20	4.0	-	-	-	-	-	-	35	0.15	1.0



SSBC(RL) EXT



External Screw Lock Tool Holder with 75° Cutting Angle for SC.. Insert

External Right/Left hand tool holder for screw type positive SC.. 09 up to 38 inserts. Suited for external longitudinal turning without shoulder, taper and chamfer turning. Available with shank size 12x12 up to 60x60 mm. Body treated for longer tool life.

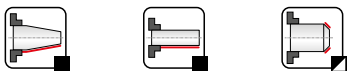
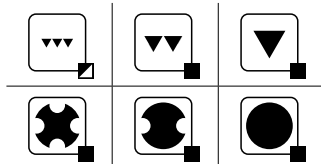
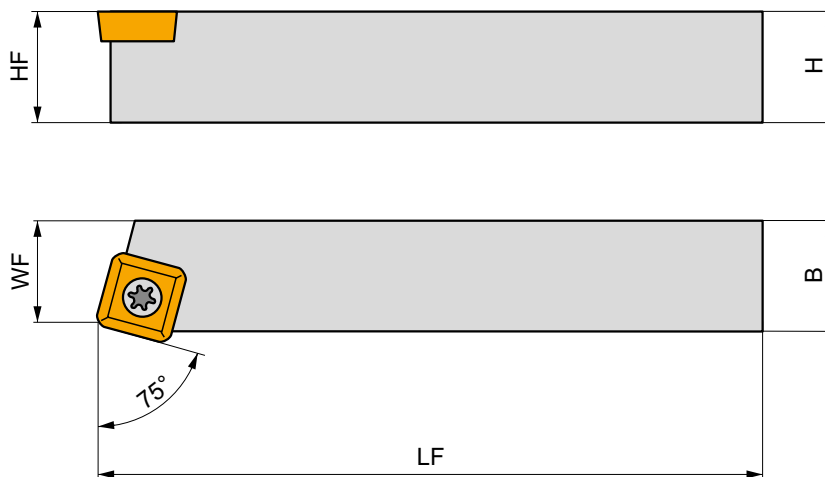
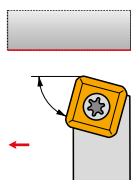

	Product	H	B	HF	WF	LF	LAMS	GAMO	kg		
		[mm]	[mm]	[mm]	[mm]	[mm]	[°]	[°]			
R	SSBCR 1212 F 09	12	12	12	11	80	0	0	0.10	GI053	S08
	SSBCR 1616 H 09	16	16	16	13	100	0	0	0.20	GI053	S08
	SSBCR 2020 K 12-M-A	20	20	20	17	125	0	0	0.40	GI015	SS20
	SSBCR 2525 M 12-M-A	25	25	25	22	150	0	0	0.76	GI015	SS20
	SSBCR 4040 S 25	40	40	40	35	250	0	0	3.01	GI131	SS25
	SSBCR 5050 T 25	50	50	50	43	300	0	0	5.65	GI131	SS25
	SSBCR 5050 T 38-A	50	50	50	43	300	0	0	4.84	GI164	SS38A
L	SSBCR 6060 V 38-A	60	60	60	53	400	0	0	11.10	GI164	SS38A
	SSBCL 1212 F 09	12	12	12	11	80	0	0	0.10	GI053	S08
	SSBCL 1616 H 09	16	16	16	13	100	0	0	0.22	GI053	S08
	SSBCL 2020 K 12-M-A	20	20	20	17	125	0	0	0.40	GI015	SS20
	SSBCL 2525 M 12-M-A	25	25	25	22	150	0	0	0.47	GI015	SS20
	SSBCL 4040 S 25	40	40	40	35	250	0	0	3.01	GI131	SS25
	SSBCL 5050 T 25	50	50	50	43	300	0	0	5.65	GI131	SS25
SSBCL 5050 T 38-A	50	50	50	43	300	0	0	5.78	GI164	SS38A	
SSBCL 6060 V 38-A	60	60	60	53	400	0	0	11.16	GI164	SS38A	



GI015	SC.. 1204..
GI053	SC.. 09T3..
GI131	SC.. 2509..
GI164	SC.. 3809..



S08	US 3510-T15P	3.0	M 3.5	10.6	-	-	FLAG T15P	-	-
SS20	US 5012-T15P	5.0	M 5	12.2	SSN 120304	MS 5008	FLAG T15P	HXK 5	-
SS25	US 8025-T30P	13.0	M 8	24.2	SSN 250620	MS 8020	-	HXK 5	SDR T30P
SS38A	US 8025-T30P	13.0	M 8	24.2	SSN 380920	MS 8020	-	HXK 5	SDR T30P



SSDCN EXT

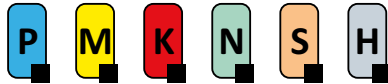

PRAMET

S



External Screw Lock Tool Holder with 45° Cutting Angle for SC.. Insert

External neutral tool holder for screw type positive SC.. 09 or 12 inserts. Suited for external longitudinal turning without shoulder, copy, taper and chamfer turning. Available with shank size 12x12 up to 25x25 mm. Body treated for longer tool life.

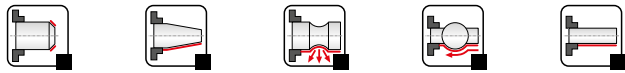
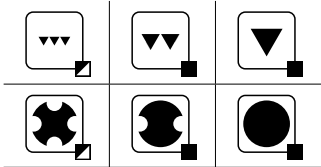
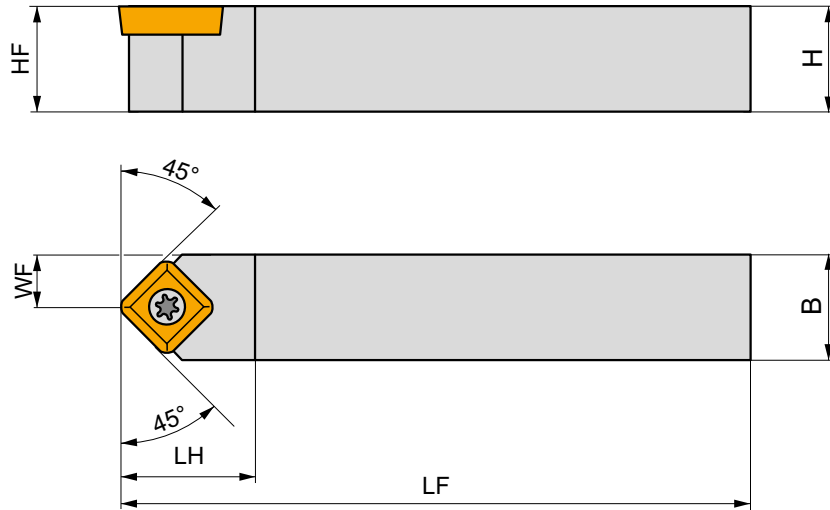
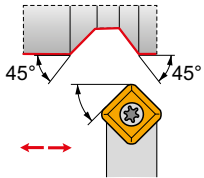

Product	H	B	HF	WF	LF	LH	LAMS	GAMO	kg	Icon 1	Icon 2
	[mm]	[mm]	[mm]	[mm]	[mm]	[mm]	[°]	[°]			
SSDCN 1212 F 09	12	12	12	6	80	-	0	0	0.12	GI053	S08
SSDCN 1616 H 09	16	16	16	8	100	-	0	0	0.20	GI053	S08
SSDCN 2020 K 12-M-A	20	20	20	10	125	-	0	0	0.42	GI015	SS20
SSDCN 2525 M 12-M-A	25	25	25	12.5	150	-	0	0	0.74	GI015	SS20

Icon	Icon
GI015	SC.. 1204..
GI053	SC.. 09T3..

Icon	Icon	Icon	Icon	Icon	Icon	Icon	Icon	Icon
S08	US 3510-T15P	3.0	M 3.5	10.6	-	-	FLAG T15P	-
SS20	US 5012-T15P	5.0	M 5	12.2	SSN 120304	MS 5008	FLAG T15P	HXK 5



SSKC(RL) EXT



Ext. Screw Lock Tool Holder, 75° (Face Turning) Cutting Angle for SC.. Insert

External Right/Left hand tool holder for screw type positive SC.. 09 up to 12 inserts. Suited for external face turning without shoulder and chamfer turning. Available with shank size 12x12 up to 25x25 mm. Body treated for longer tool life.

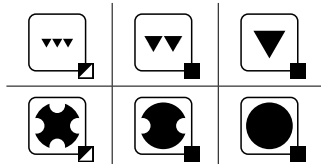
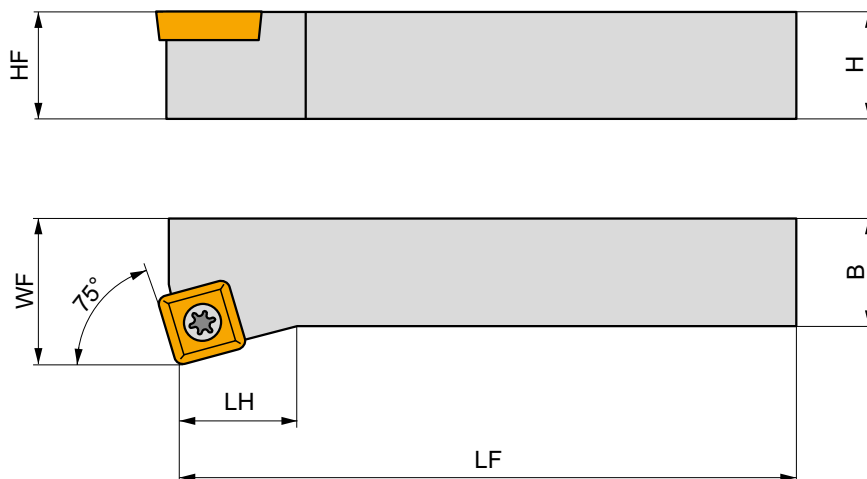
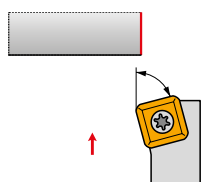

Product	H	B	HF	WF	LF	LH	LAMS	GAMO	kg			
	[mm]	[mm]	[mm]	[mm]	[mm]	[mm]	[°]	[°]				
R	SSKCR 1212 F 09	12	12	12	16	80	32	0	0	0.10	GI053	S08
	SSKCR 1616 H 09	16	16	16	20	100	32	0	0	0.25	GI053	S08
	SSKCR 2020 K 12-M-A	20	20	20	25	125	36	0	0	0.75	GI015	SS20
	SSKCR 2525 M 12-M-A	25	25	25	32	150	36	0	0	0.75	GI015	SS20
L	SSKCL 1212 F 09	12	12	12	16	80	32	0	0	0.10	GI053	S08
	SSKCL 1616 H 09	16	16	16	20	100	32	0	0	0.22	GI053	S08
	SSKCL 2020 K 12-M-A	20	20	20	25	125	36	0	0	0.45	GI015	SS20
	SSKCL 2525 M 12-M-A	25	25	25	32	150	36	0	0	0.80	GI015	SS20



GI015

GI053



SC.. 1204..

SC.. 09T3..



S08



US 3510-T15P



3.0



M 3.5



10.6



-



-



FLAG T15P



-

SS20

US 5012-T15P

5.0

M 5

12.2

SSN 120304

MS 5008

FLAG T15P

HXK 5



KHS-SBC(RL)



PRAMET

S



Modular KHS Screw Clamp Turning Cartridge 75° Cutting Angle for SC.. Insert

Dovetailed Right/Left hand lever lock turning cartridge, 75° cutting angle, for mounting on DKH tool holder shank. Suited for heavy longitudinal turning without shoulder, face turning, taper and chamfer turning with positive SC.. 25 or 38 inserts Tool holder treated for longer tool life.

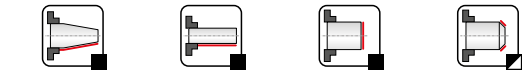
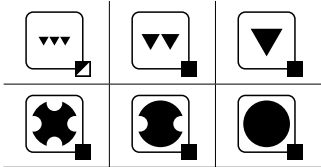
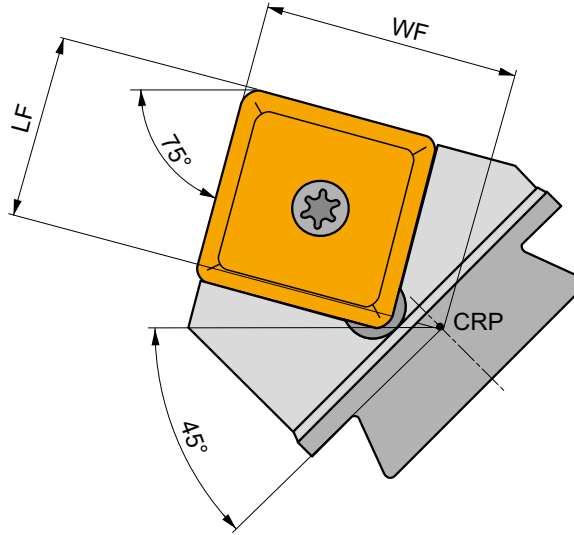
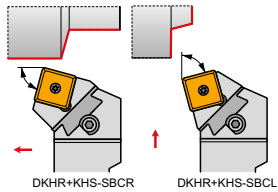

Product	WF	LF	LAMS	GAMO	kg	G1131 G1164	SS26 SS38
	[mm]	[mm]	[°]	[°]			
R KHS-SBCR 25	47	36	0	0	1.50	G1131	SS26
	KHS-SBCR 38-A	47	36	0	0	1.50	G1164
L KHS-SBCL 25	47	36	0	0	1.45	G1131	SS26
	KHS-SBCL 38-A	47	36	0	0	1.48	G1164

G1131		G1164	
SC.. 2509..		SC.. 3809..	

SS26	US 8025-T30P	13.0	M 8	24.2	SSN 250620	MS 8020	SDR T30P	HXK 5
SS38	US 8025-T30P	13.0	M 8	24.2	SSN 380620	MS 8020	SDR T30P	HXK 5



DKH(RL)



External Tool Holder Shank for KHP/KHS Heavy Turning Cartridges

Dovetailed Right/Left hand modular tool shank for KHP/KHS cartridges. Suited for heavy turning applications. Available with shank size 40x50 up to 60x80 mm. Body treated for longer tool life.

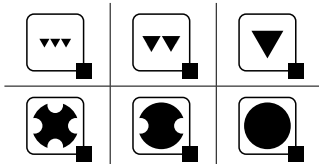
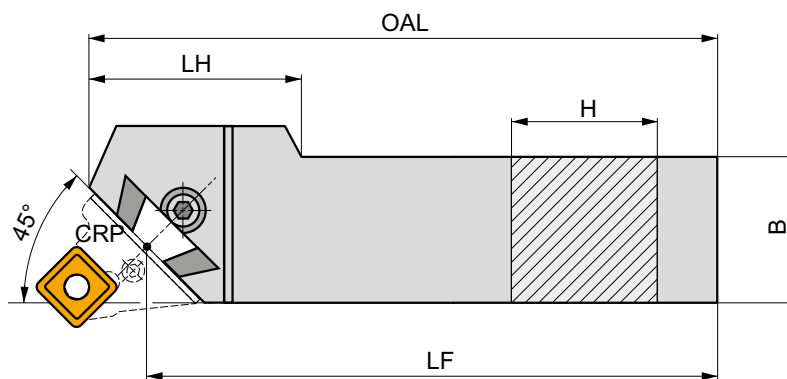
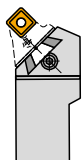

Product	H	B	LF	OAL	LH	kg		
	[mm]	[mm]	[mm]	[mm]	[mm]			
R	DKHR 4050 V	40	50	400	425	7.10	GI098	DKH10
	DKHR 5060 W	50	60	450	475	11.30	GI098	DKH10
	DKHR 6080 W-A	60	80	450	485	19.65	GI098	DKH10
L	DKHL 4050 V	40	50	400	425	7.10	GI098	DKH10
	DKHL 5060 W	50	60	450	475	11.30	GI098	DKH10
	DKHL 6080 W-A	60	80	450	485	19.28	GI098	DKH10



GI098



KHP



KHS



DKH10



SR 14



HXK 10



SSSC(RL) INT

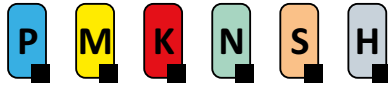

PRAMET

S



Internal Screw Lock Boring Bar with 45° Cutting Angle for SC.. 09 Insert

Internal Right/Left hand boring bar with 45° cutting angle for screw type SC.. 09 inserts. Minimum internal turning diameter Ø25 mm. For internal back chamfer, taper, multi-directional, chamfer and longitudinal turning without shoulder. Available with shank size Ø20 up to Ø25 mm. Body treated for longer tool life.

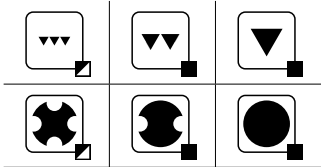
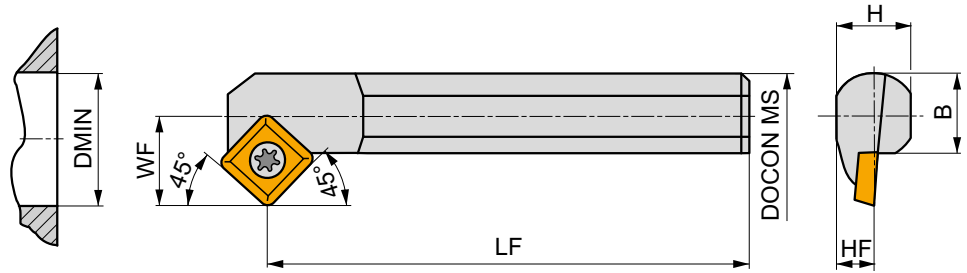
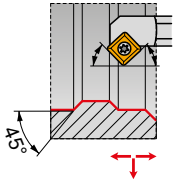

Product	DOCON MS	DMIN	WF	H	B	LF	LAMS	GAMO	kg	G1053	S04
	[mm]	[mm]	[mm]	[mm]	[mm]	[mm]	[°]	[°]			
R S20S-SSSCR 09	20	25	13	18	18.5	250	-5	0	0.61	G1053	S04
	S25T-SSSCR 09	25	32	17	23	23	300	-3	0		
L S20S-SSSCL 09	20	25	13	18	18.5	250	-5	0	0.05	G1053	S04
	S25T-SSSCL 09	25	32	17	23	23	300	-3	0		

G1053	SC..09T3..
-------	------------

S04	US 3510-T15P	3.0 Nm	M 3.5	10.6	FLAGT15P
-----	--------------	--------	-------	------	----------



SP

09/ 12/ 15/ 19/ 25

CARBIDE INSERTS

SPMR



146

SPUN



146

CER INSERTS

SPGN CER



147



SPMR



	IC [mm]	L [mm]	S [mm]
0903	9.525	9.53	3.18
1203	12.700	12.70	3.18

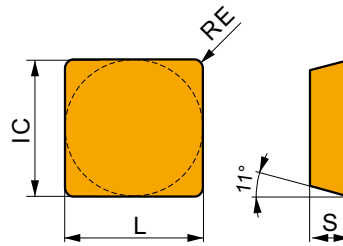

Suitability and starting values for cutting speed (vc), feed (f) and depth of cut (ap). Refer to our Machining Calculator app for further calculations.

Product	RE [mm]	P			M			K			N			S			H		
		vc [m/min]	f [mm/rev]	ap [mm]	vc [m/min]	f [mm/rev]	ap [mm]	vc [m/min]	f [mm/rev]	ap [mm]	vc [m/min]	f [mm/rev]	ap [mm]	vc [m/min]	f [mm/rev]	ap [mm]	vc [m/min]	f [mm/rev]	ap [mm]

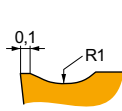

Geometry 46 for fine to finish machining, and continuous to interrupted cuts.

SPMR 090304E-46	T9325	0.4	215	0.15	1.0	125	0.15	1.0	200	0.15	1.0	-	-	-	-	-	-	-
SPMR 090308E-46	T9325	0.8	255	0.15	1.0	150	0.15	1.0	240	0.15	1.0	-	-	-	-	-	-	-

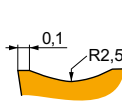

Geometry 48 for finish to semi-rough machining, and continuous to interrupted cuts.

SPMR 120304E-48	T9325	0.4	170	0.22	2.2	100	0.22	2.2	160	0.22	2.2	-	-	-	-	-	-	-
	T9335	0.4	145	0.22	2.2	85	0.22	2.2	-	-	-	-	-	-	-	-	-	-
SPMR 120308E-48	6640	0.8	160	0.22	2.2	95	0.22	2.2	150	0.22	2.2	-	-	-	-	-	-	-
	T9325	0.8	205	0.22	2.2	120	0.22	2.2	190	0.22	2.2	-	-	-	-	-	-	-
	T9335	0.8	175	0.22	2.2	105	0.22	2.2	-	-	-	-	-	-	-	-	-	-
SPMR 120312E-48	T9325	1.2	215	0.22	2.2	125	0.22	2.2	200	0.22	2.2	-	-	-	-	-	-	-

SPUN



	IC [mm]	L [mm]	M [mm]	S [mm]
1203	12.700	12.70	2	3.18
1504	15.875	15.88	3	4.76
1904	19.050	19.05	3	4.76
2506	25.400	25.40	4	6.35

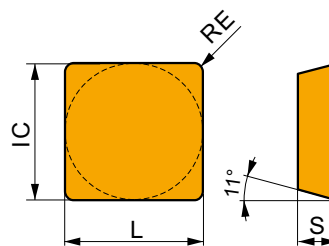

Suitability and starting values for cutting speed (vc), feed (f) and depth of cut (ap). Refer to our Machining Calculator app for further calculations.

Product	RE [mm]	P			M			K			N			S			H		
		vc [m/min]	f [mm/rev]	ap [mm]	vc [m/min]	f [mm/rev]	ap [mm]	vc [m/min]	f [mm/rev]	ap [mm]	vc [m/min]	f [mm/rev]	ap [mm]	vc [m/min]	f [mm/rev]	ap [mm]	vc [m/min]	f [mm/rev]	ap [mm]

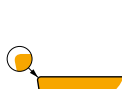
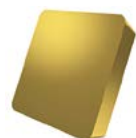

For fine-finish to semi-rough machining, and continuous to slightly interrupted cuts.

SPUN 120308	6640	0.8	180	0.15	4.0	-	-	-	170	0.15	4.0	-	-	-	-	-	-	-
SPUN 120312	6640	1.2	190	0.15	4.0	-	-	-	180	0.15	4.0	-	-	-	-	-	-	-
SPUN 150408	6640	0.8	155	0.20	5.0	-	-	-	145	0.20	5.0	-	-	-	-	-	-	-



TC

06/ 09/ 11/16

CARBIDE INSERTS

TCGT



149

TCMT



150

TCMW



154

CBN INSERTS

TCGW CBN



154

MATCH THE RIGHT SIZE (example)

Insert	Tool Holder
TCMT 110204E-FF2	STFCR 1616 H 11

ISO TURNING – EXTERNAL

STFC(RL) EXT

90°

TC..

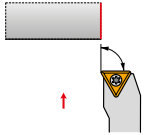

155

149 – 154

16x16
25x25

STFC(RL)-A EXT

90°

TC..

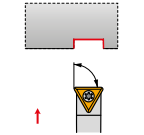

156

149 – 154

20x20

STJC(RL) EXT

93°

TC..

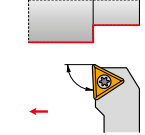

157

149 – 154

16x16
25x25

ISO TURNING – INTERNAL

STFC(RL) INT

90°

TC..

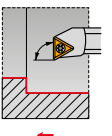

158

149 – 154

06
09
11
16

8,5
40

STFC(RL)-E INT

90°

TC..

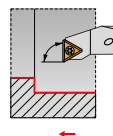

160

149 – 154

06
09
11

8,5
20



TCGT



	IC [mm]	D1 [mm]	L [mm]	S [mm]
06T1	3.970	2.20	6.90	1.98
0902	5.560	2.50	9.60	2.38
1102	6.350	2.80	11.00	2.38
1102-SF3	6.350	2.80	11.00	2.58
16T3	9.525	4.40	16.50	3.97
16T3-SF3	9.525	4.40	16.50	4.22

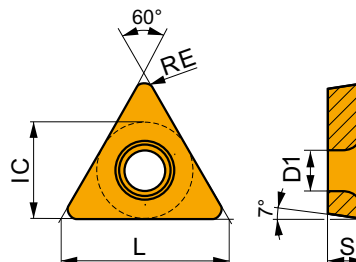

Suitability and starting values for cutting speed (vc), feed (f) and depth of cut (ap). Refer to our Machining Calculator app for further calculations.

Product	RE [mm]	P			M			K			N			S			H		
		vc [m/min]	f [mm/rev]	ap [mm]	vc [m/min]	f [mm/rev]	ap [mm]	vc [m/min]	f [mm/rev]	ap [mm]	vc [m/min]	f [mm/rev]	ap [mm]	vc [m/min]	f [mm/rev]	ap [mm]	vc [m/min]	f [mm/rev]	ap [mm]



AL geometry with highly positive design for fine-finish to rough machining, and continuous to slightly interrupted cuts.

TCGT 090202F-AL	HF7	0.2	-	-	-	-	-	-	-	-	-	375	0.12	1.0	-	-	-	-	-	-
	T0315	0.2	-	-	-	-	-	-	-	-	-	555	0.12	1.0	-	-	-	-	-	-
TCGT 090204F-AL	HF7	0.4	-	-	-	-	-	-	-	-	-	300	0.24	1.0	-	-	-	-	-	-
	T0315	0.4	-	-	-	-	-	-	-	-	-	450	0.24	1.0	-	-	-	-	-	-
TCGT 110202F-AL	HF7	0.2	-	-	-	-	-	-	-	-	-	360	0.12	1.5	-	-	-	-	-	-
	T0315	0.2	-	-	-	-	-	-	-	-	-	525	0.12	1.5	-	-	-	-	-	-
TCGT 110204F-AL	HF7	0.4	-	-	-	-	-	-	-	-	-	285	0.24	1.5	-	-	-	-	-	-
	T0315	0.4	-	-	-	-	-	-	-	-	-	420	0.24	1.5	-	-	-	-	-	-
TCGT 110208F-AL	HF7	0.8	-	-	-	-	-	-	-	-	-	270	0.48	1.5	-	-	-	-	-	-
TCGT 16T304F-AL	HF7	0.4	-	-	-	-	-	-	-	-	-	285	0.24	2.4	-	-	-	-	-	-
	T0315	0.4	-	-	-	-	-	-	-	-	-	405	0.24	2.4	-	-	-	-	-	-
TCGT 16T308F-AL	HF7	0.8	-	-	-	-	-	-	-	-	-	255	0.48	2.4	-	-	-	-	-	-
	T0315	0.8	-	-	-	-	-	-	-	-	-	360	0.48	2.4	-	-	-	-	-	-

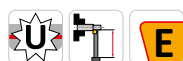
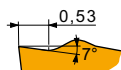

FF2 geometry with positive design for fine-finish to finish machining, and continuous to slightly interrupted cuts.

TCGT 06T102E-FF2	T8330	0.2	175	0.05	0.8	-	-	-	165	0.05	0.8	-	-	-	-	-	-	-	-	-
	T8430	0.2	235	0.05	0.8	-	-	-	190	0.05	0.8	-	-	-	-	-	-	-	-	-
TCGT 090202E-FF2	TT010	0.2	295	0.05	0.5	-	-	-	-	-	-	-	-	-	-	-	-	-	-	-
	TT010	0.2	295	0.05	0.5	-	-	-	-	-	-	-	-	-	-	-	-	-	-	-

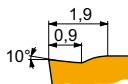
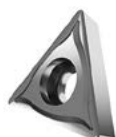

NF1 geometry with positive design for fine-finish to medium machining, and continuous cuts.

TCGT 110204E-NF1	H07	0.4	-	-	-	80	0.09	0.8	-	-	-	415	0.12	0.8	40	0.08	0.6	-	-	-
	T6310	0.4	155	0.10	0.8	110	0.09	0.8	-	-	-	465	0.12	0.8	45	0.08	0.6	30	0.15	1.0
	T7325	0.4	180	0.10	0.8	140	0.09	0.8	-	-	-	-	-	-	55	0.08	0.6	-	-	-

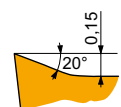

SF3 geometry with highly positive design for fine to finish machining, and continuous cuts.

TCGT 110202E-SF3	T6310	0.2	175	0.05	0.8	125	0.05	0.8	140	0.05	0.8	525	0.06	0.8	50	0.04	0.6	35	0.15	1.0
	T8315	0.2	185	0.05	0.8	110	0.05	0.8	175	0.05	0.8	555	0.06	0.8	45	0.04	0.6	35	0.15	1.0
TCGT 110204E-SF3	H07	0.4	-	-	-	80	0.09	0.8	130	0.10	0.8	415	0.12	0.8	40	0.07	0.6	-	-	-
	T6310	0.4	155	0.10	0.8	110	0.09	0.8	125	0.10	0.8	465	0.12	0.8	45	0.07	0.6	30	0.15	1.0
	T8315	0.4	165	0.10	0.8	95	0.09	0.8	155	0.10	0.8	495	0.12	0.8	40	0.07	0.6	30	0.15	1.0



Suitability and starting values for cutting speed (vc), feed (f) and depth of cut (ap). Refer to our Machining Calculator app for further calculations.

Product	RE [mm]	P			M			K			N			S			H		
		vc [m/min]	f [mm/rev]	ap [mm]	vc [m/min]	f [mm/rev]	ap [mm]	vc [m/min]	f [mm/rev]	ap [mm]	vc [m/min]	f [mm/rev]	ap [mm]	vc [m/min]	f [mm/rev]	ap [mm]	vc [m/min]	f [mm/rev]	ap [mm]

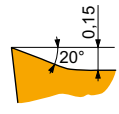

SF3 geometry with highly positive design for fine to finish machining, and continuous cuts.

TCGT 16T304E-SF3	H07	0.4	–	–	–	80	0.09	1.0	125	0.10	1.0	405	0.12	1.0	40	0.07	0.8	–	–	–
	T6310	0.4	150	0.10	1.0	105	0.09	1.0	120	0.10	1.0	450	0.12	1.0	45	0.07	0.8	30	0.15	1.0
	T8315	0.4	160	0.10	1.0	95	0.09	1.0	150	0.10	1.0	480	0.12	1.0	40	0.07	0.8	30	0.15	1.0
TCGT 16T308E-SF3	H07	0.8	–	–	–	90	0.09	1.2	145	0.10	1.2	470	0.12	1.2	45	0.08	1.0	–	–	–
	T6310	0.8	175	0.10	1.2	125	0.09	1.2	140	0.10	1.2	525	0.12	1.2	50	0.08	1.0	35	0.15	1.0
	T8315	0.8	185	0.10	1.2	110	0.09	1.2	175	0.10	1.2	555	0.12	1.2	45	0.08	1.0	35	0.15	1.0
TCGT 16T312E-SF3	T6310	1.2	150	0.20	1.2	105	0.18	1.2	120	0.20	1.2	450	0.24	1.2	45	0.14	1.0	30	0.15	1.0

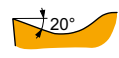

ER-SI geometry with positive right-handed design for fine-finish machining, and continuous cuts.

TCGT 110202ER-SI	T8315	0.2	190	0.10	0.8	110	0.09	0.8	180	0.10	0.8	–	–	–	45	0.08	0.6	–	–	–
	T8330	0.2	180	0.10	0.8	105	0.09	0.8	170	0.10	0.8	–	–	–	45	0.08	0.6	–	–	–
	T8430	0.2	225	0.10	0.8	120	0.09	0.8	185	0.10	0.8	–	–	–	45	0.08	0.6	–	–	–
TCGT 110204ER-SI	T8330	0.4	180	0.12	0.8	105	0.11	0.8	170	0.12	0.8	–	–	–	45	0.10	0.6	–	–	–
	T8430	0.4	225	0.12	0.8	120	0.11	0.8	185	0.12	0.8	–	–	–	45	0.10	0.6	–	–	–

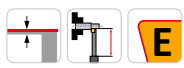
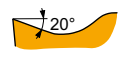

EL-SI geometry with positive left-handed design for fine-finish machining, and continuous cuts.

TCGT 110202EL-SI	T8315	0.2	190	0.10	0.8	110	0.09	0.8	180	0.10	0.8	–	–	–	45	0.08	0.6	–	–	–
	T8330	0.2	180	0.10	0.8	105	0.09	0.8	170	0.10	0.8	–	–	–	45	0.08	0.6	–	–	–
	T8430	0.2	225	0.10	0.8	120	0.09	0.8	185	0.10	0.8	–	–	–	45	0.08	0.6	–	–	–
TCGT 110204EL-SI	T8315	0.4	195	0.12	0.8	115	0.11	0.8	185	0.12	0.8	–	–	–	45	0.10	0.6	–	–	–
	T8330	0.4	180	0.12	0.8	105	0.11	0.8	170	0.12	0.8	–	–	–	45	0.10	0.6	–	–	–
	T8430	0.4	225	0.12	0.8	120	0.11	0.8	185	0.12	0.8	–	–	–	45	0.10	0.6	–	–	–

TCMT



	IC [mm]	D1 [mm]	L [mm]	S [mm]
06T1	3.970	2.20	6.90	1.98
0902	5.560	2.50	9.60	2.38
1102	6.350	2.80	11.00	2.38
16T3	9.525	4.40	16.50	3.97

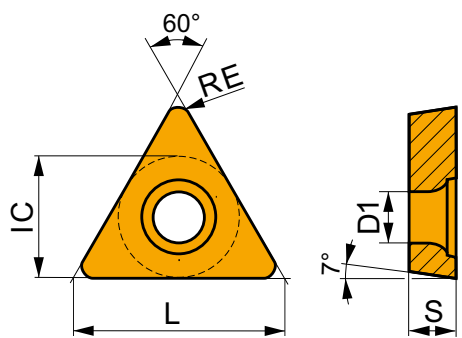

Suitability and starting values for cutting speed (vc), feed (f) and depth of cut (ap). Refer to our Machining Calculator app for further calculations.

Product	RE [mm]	P			M			K			N			S			H		
		vc [m/min]	f [mm/rev]	ap [mm]	vc [m/min]	f [mm/rev]	ap [mm]	vc [m/min]	f [mm/rev]	ap [mm]	vc [m/min]	f [mm/rev]	ap [mm]	vc [m/min]	f [mm/rev]	ap [mm]	vc [m/min]	f [mm/rev]	ap [mm]

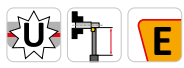
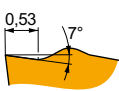

FF2 geometry with positive design for fine-finish to finish machining, and continuous to slightly interrupted cuts.

TCMT 06T102E-FF2	T8330	0.2	175	0.05	0.8	–	–	–	165	0.05	0.8	–	–	–	–	–	–	–	–	–
	T8430	0.2	235	0.05	0.8	–	–	–	190	0.05	0.8	–	–	–	–	–	–	–	–	–
	T9315	0.2	335	0.05	0.8	–	–	–	315	0.05	0.8	–	–	–	–	–	–	–	–	–



Suitability and starting values for cutting speed (vc), feed (f) and depth of cut (ap). Refer to our Machining Calculator app for further calculations.

Product	RE (mm)	P			M			K			N			S			H		
		vc (m/min)	f (mm/rev)	ap (mm)	vc (m/min)	f (mm/rev)	ap (mm)	vc (m/min)	f (mm/rev)	ap (mm)	vc (m/min)	f (mm/rev)	ap (mm)	vc (m/min)	f (mm/rev)	ap (mm)	vc (m/min)	f (mm/rev)	ap (mm)

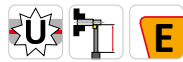
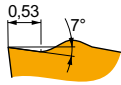

FF2 geometry with positive design for fine-finish to finish machining, and continuous to slightly interrupted cuts.

TCMT 06T104E-FF2	T7325	0.4	170	0.12	0.8	-	-	-	-	-	-	-	-	-	-	-	-	-
	T8330	0.4	145	0.12	0.8	-	-	-	135	0.12	0.8	-	-	-	-	-	-	-
	T8430	0.4	180	0.12	0.8	-	-	-	145	0.12	0.8	-	-	-	-	-	-	-
	T9315	0.4	245	0.12	0.8	-	-	-	230	0.12	0.8	-	-	-	-	-	-	-
	T9325	0.4	220	0.12	0.8	-	-	-	205	0.12	0.8	-	-	-	-	-	-	-
TCMT 090204E-FF2	T5315	0.4	240	0.12	1.0	-	-	-	225	0.12	1.0	-	-	-	-	-	-	-
	T7325	0.4	165	0.12	1.0	-	-	-	-	-	-	-	-	-	-	-	-	-
	T8330	0.4	140	0.12	1.0	-	-	-	130	0.12	1.0	-	-	-	-	-	-	-
	T8430	0.4	175	0.12	1.0	-	-	-	140	0.12	1.0	-	-	-	-	-	-	-
	T9315	0.4	240	0.12	1.0	-	-	-	225	0.12	1.0	-	-	-	-	-	-	-
TCMT 110204E-FF2	T7325	0.4	170	0.12	0.8	-	-	-	-	-	-	-	-	-	-	-	-	-
	T8330	0.4	145	0.12	0.8	-	-	-	135	0.12	0.8	-	-	-	-	-	-	-
	T8430	0.4	180	0.12	0.8	-	-	-	145	0.12	0.8	-	-	-	-	-	-	-
	T9315	0.4	245	0.12	0.8	-	-	-	230	0.12	0.8	-	-	-	-	-	-	-
	T9325	0.4	220	0.12	0.8	-	-	-	205	0.12	0.8	-	-	-	-	-	-	-
TCMT 110208E-FF2	T7325	0.8	180	0.17	0.8	-	-	-	-	-	-	-	-	-	-	-	-	-
	T8330	0.8	155	0.17	0.8	-	-	-	145	0.17	0.8	-	-	-	-	-	-	-
	T8430	0.8	185	0.17	0.8	-	-	-	150	0.17	0.8	-	-	-	-	-	-	-
	T9315	0.8	250	0.17	0.8	-	-	-	235	0.17	0.8	-	-	-	-	-	-	-
	T9325	0.8	225	0.17	0.8	-	-	-	210	0.17	0.8	-	-	-	-	-	-	-
TCMT 16T304E-FF2	T7325	0.4	170	0.12	0.8	-	-	-	-	-	-	-	-	-	-	-	-	-
	T8330	0.4	145	0.12	0.8	-	-	-	135	0.12	0.8	-	-	-	-	-	-	-
	T8430	0.4	180	0.12	0.8	-	-	-	145	0.12	0.8	-	-	-	-	-	-	-
	T9315	0.4	245	0.12	0.8	-	-	-	230	0.12	0.8	-	-	-	-	-	-	-
	T9325	0.4	220	0.12	0.8	-	-	-	205	0.12	0.8	-	-	-	-	-	-	-
	T9335	0.4	185	0.12	0.8	-	-	-	-	-	-	-	-	-	-	-	-	-
TCMT 16T308E-FF2	TT010	0.4	295	0.06	0.5	-	-	-	-	-	-	-	-	-	-	-	-	-
	T7325	0.8	180	0.17	0.8	-	-	-	-	-	-	-	-	-	-	-	-	-
	T8330	0.8	155	0.17	0.8	-	-	-	145	0.17	0.8	-	-	-	-	-	-	-
	T8430	0.8	185	0.17	0.8	-	-	-	150	0.17	0.8	-	-	-	-	-	-	-
	T9315	0.8	250	0.17	0.8	-	-	-	235	0.17	0.8	-	-	-	-	-	-	-
	T9325	0.8	225	0.17	0.8	-	-	-	210	0.17	0.8	-	-	-	-	-	-	-

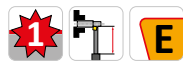

FM geometry for finish to semi-rough machining, and continuous to slightly interrupted cuts.

TCMT 110202E-FM	T7325	0.2	185	0.10	0.8	140	0.09	0.8	-	-	-	-	-	-	-	-	-
	T7335	0.2	185	0.10	0.8	140	0.09	0.8	-	-	-	-	-	-	-	-	-
	T8315	0.2	170	0.10	0.8	100	0.09	0.8	160	0.10	0.8	510	0.12	0.8	-	-	-
	T8330	0.2	160	0.10	0.8	95	0.09	0.8	150	0.10	0.8	480	0.12	0.8	-	-	-
	T8430	0.2	195	0.10	0.8	105	0.09	0.8	160	0.10	0.8	540	0.12	0.8	-	-	-
	T9315	0.2	270	0.10	0.8	-	-	-	255	0.10	0.8	-	-	-	-	-	-
TCMT 110204E-FM	T9325	0.2	245	0.10	0.8	145	0.09	0.8	230	0.10	0.8	-	-	-	-	-	-
	T7325	0.4	160	0.19	0.8	120	0.17	0.8	-	-	-	-	-	-	-	-	-
	T7335	0.4	155	0.19	0.8	120	0.17	0.8	-	-	-	-	-	-	-	-	-
	T8315	0.4	170	0.12	0.8	100	0.11	0.8	160	0.12	0.8	510	0.14	0.8	-	-	-
	T8330	0.4	160	0.12	0.8	95	0.11	0.8	150	0.12	0.8	480	0.14	0.8	-	-	-
	T8430	0.4	195	0.12	0.8	105	0.11	0.8	160	0.12	0.8	540	0.14	0.8	-	-	-
TCMT 110204E-FM	T9315	0.4	270	0.12	0.8	-	-	-	255	0.12	0.8	-	-	-	-	-	-
	T9325	0.4	205	0.18	0.8	120	0.16	0.8	190	0.18	0.8	-	-	-	-	-	-



Suitability and starting values for cutting speed (vc), feed (f) and depth of cut (ap). Refer to our Machining Calculator app for further calculations.

Product	RE (mm)	P			M			K			N			S			H		
		vc [m/min]	f [mm/rev]	ap [mm]	vc [m/min]	f [mm/rev]	ap [mm]	vc [m/min]	f [mm/rev]	ap [mm]	vc [m/min]	f [mm/rev]	ap [mm]	vc [m/min]	f [mm/rev]	ap [mm]	vc [m/min]	f [mm/rev]	ap [mm]

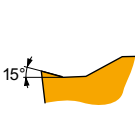

FM geometry for finish to semi-rough machining, and continuous to slightly interrupted cuts.

TCMT 110208E-FM	T7325	0.8	195	0.17	0.8	150	0.15	0.8	-	-	-	-	-	-	-	-	-	-
	T8330	0.8	175	0.17	0.8	105	0.15	0.8	165	0.17	0.8	525	0.20	0.8	-	-	-	-
	T8430	0.8	200	0.17	0.8	110	0.15	0.8	165	0.17	0.8	555	0.20	0.8	-	-	-	-
	T9315	0.8	275	0.17	0.8	-	-	-	260	0.17	0.8	-	-	-	-	-	-	-
	T9325	0.8	250	0.17	0.8	150	0.15	0.8	235	0.17	0.8	-	-	-	-	-	-	-
TCMT 16T304E-FM	T7325	0.4	150	0.19	1.7	115	0.17	1.7	-	-	-	-	-	-	-	-	-	-
	T7335	0.4	145	0.19	1.7	110	0.17	1.7	-	-	-	-	-	-	-	-	-	-
	T8315	0.4	155	0.12	1.7	90	0.11	1.7	145	0.12	1.7	465	0.14	1.7	-	-	-	-
	T8330	0.4	150	0.12	1.7	90	0.11	1.7	140	0.12	1.7	450	0.14	1.7	-	-	-	-
	T8430	0.4	180	0.12	1.7	95	0.11	1.7	145	0.12	1.7	495	0.14	1.7	-	-	-	-
	T9315	0.4	250	0.12	1.7	-	-	-	235	0.12	1.7	-	-	-	-	-	-	-
	T9325	0.4	190	0.18	1.7	110	0.16	1.7	180	0.18	1.7	-	-	-	-	-	-	-
TCMT 16T308E-FM	T7325	0.8	180	0.17	1.7	140	0.15	1.7	-	-	-	-	-	-	-	-	-	-
	T7335	0.8	175	0.17	1.7	135	0.15	1.7	-	-	-	-	-	-	-	-	-	-
	T8315	0.8	170	0.17	1.7	100	0.15	1.7	160	0.17	1.7	510	0.20	1.7	-	-	-	-
	T8330	0.8	160	0.17	1.7	95	0.15	1.7	150	0.17	1.7	480	0.20	1.7	-	-	-	-
	T8430	0.8	185	0.17	1.7	100	0.15	1.7	150	0.17	1.7	510	0.20	1.7	-	-	-	-
	T9315	0.8	255	0.17	1.7	-	-	-	240	0.17	1.7	-	-	-	-	-	-	-
	T9325	0.8	230	0.17	1.7	135	0.15	1.7	215	0.17	1.7	-	-	-	-	-	-	-

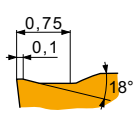

FM2 geometry for finish to medium machining, and continuous to interrupted cuts.

TCMT 110204E-FM2	T8330	0.4	145	0.12	0.8	85	0.11	0.8	135	0.12	0.8	-	-	-	-	-	-
	T8430	0.4	180	0.12	0.8	95	0.11	0.8	145	0.12	0.8	-	-	-	-	-	-
	T9325	0.4	220	0.12	0.8	130	0.11	0.8	205	0.12	0.8	-	-	-	-	-	-
TCMT 110208E-FM2	T8330	0.8	155	0.17	0.8	90	0.15	0.8	145	0.17	0.8	-	-	-	-	-	-
	T8430	0.8	185	0.17	0.8	100	0.15	0.8	150	0.17	0.8	-	-	-	-	-	-
	T9325	0.8	225	0.17	0.8	135	0.15	0.8	210	0.17	0.8	-	-	-	-	-	-
	T9335	0.8	195	0.17	0.8	115	0.15	0.8	-	-	-	-	-	-	-	-	-
TCMT 16T308E-FM2	T7325	0.8	170	0.20	1.0	130	0.18	1.0	-	-	-	-	-	-	-	-	-
	T8330	0.8	145	0.20	1.0	85	0.18	1.0	135	0.20	1.0	-	-	-	-	-	-
	T8430	0.8	170	0.20	1.0	90	0.18	1.0	135	0.20	1.0	-	-	-	-	-	-
	T9325	0.8	205	0.20	1.0	120	0.18	1.0	190	0.20	1.0	-	-	-	-	-	-
	T9335	0.8	175	0.20	1.0	105	0.18	1.0	-	-	-	-	-	-	-	-	-

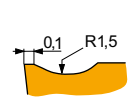

RF geometry for semi-rough to rough machining, and continuous to interrupted cuts.

TCMT 16T308E-RF	T9325	0.8	175	0.20	1.5	105	0.18	1.5	165	0.20	1.5	-	-	-	-	-	-
-----------------	-------	-----	-----	------	-----	-----	------	-----	-----	------	-----	---	---	---	---	---	---

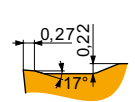

RM geometry for semi-rough to rough machining, and continuous to interrupted cuts.

TCMT 16T308E-RM	T5305	0.8	265	0.27	1.9	-	-	-	250	0.27	1.9	-	-	-	50	0.15	1.0
	T5315	0.8	235	0.27	1.9	-	-	-	220	0.27	1.9	-	-	-	45	0.15	1.0
	T7335	0.8	155	0.27	1.9	120	0.24	1.9	-	-	-	50	0.19	1.5	-	-	-
	T8330	0.8	145	0.27	1.9	85	0.24	1.9	135	0.27	1.9	-	-	-	35	0.19	1.5
	T8430	0.8	165	0.27	1.9	90	0.24	1.9	135	0.27	1.9	-	-	-	35	0.19	1.5
	T9315	0.8	215	0.27	1.9	-	-	-	200	0.27	1.9	-	-	-	40	0.15	1.0
	T9325	0.8	195	0.27	1.9	115	0.24	1.9	185	0.27	1.9	-	-	-	40	0.19	1.5



Suitability and starting values for cutting speed (vc), feed (f) and depth of cut (ap). Refer to our Machining Calculator app for further calculations.

Product	RE [mm]	P			M			K			N			S			H		
		vc [m/min]	f [mm/rev]	ap [mm]	vc [m/min]	f [mm/rev]	ap [mm]	vc [m/min]	f [mm/rev]	ap [mm]	vc [m/min]	f [mm/rev]	ap [mm]	vc [m/min]	f [mm/rev]	ap [mm]	vc [m/min]	f [mm/rev]	ap [mm]

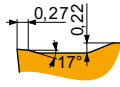

RM geometry for semi-rough to rough machining, and continuous to interrupted cuts.

TCMT 16T312E-RM	T5305	1.2	280	0.27	1.9	-	-	-	265	0.27	1.9	-	-	-	-	-	-	55	0.15	1.0
	T5315	1.2	250	0.27	1.9	-	-	-	235	0.27	1.9	-	-	-	-	-	-	50	0.15	1.0
	T8330	1.2	150	0.27	1.9	90	0.24	1.9	140	0.27	1.9	-	-	-	35	0.19	1.5	30	0.15	1.0
	T8430	1.2	170	0.27	1.9	90	0.24	1.9	135	0.27	1.9	-	-	-	35	0.19	1.5	25	0.15	1.0
	T9315	1.2	225	0.27	1.9	-	-	-	210	0.27	1.9	-	-	-	-	-	-	45	0.15	1.0
	T9325	1.2	205	0.27	1.9	120	0.24	1.9	190	0.27	1.9	-	-	-	45	0.19	1.5	-	-	-

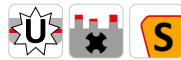
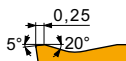

RM3 geometry for semi-rough to rough machining, and continuous to interrupted cuts.

TCMT 16T304E-RM3	T6310	0.4	110	0.25	2.0	75	0.25	2.0	85	0.25	2.0	-	-	-	-	-	-	20	0.15	1.0
	T7325	0.4	125	0.25	2.0	95	0.25	2.0	-	-	-	-	-	-	-	-	-	-	-	
	T8330	0.4	110	0.25	2.0	65	0.25	2.0	100	0.25	2.0	-	-	-	-	-	-	20	0.15	1.0
	T8430	0.4	120	0.25	2.0	65	0.25	2.0	95	0.25	2.0	-	-	-	-	-	-	20	0.15	1.0
	T9315	0.4	165	0.25	2.0	-	-	-	155	0.25	2.0	-	-	-	-	-	-	30	0.15	1.0
	T9325	0.4	145	0.25	2.0	85	0.25	2.0	135	0.25	2.0	-	-	-	-	-	-	-	-	
TCMT 16T308E-RM3	T6310	0.8	125	0.27	2.0	90	0.27	2.0	100	0.27	2.0	-	-	-	-	-	-	25	0.15	1.0
	T7325	0.8	145	0.27	2.0	110	0.27	2.0	-	-	-	-	-	-	-	-	-	-	-	
	T8330	0.8	125	0.27	2.0	75	0.27	2.0	115	0.27	2.0	-	-	-	-	-	-	25	0.15	1.0
	T8430	0.8	135	0.27	2.0	75	0.27	2.0	110	0.27	2.0	-	-	-	-	-	-	20	0.15	1.0
	T9315	0.8	185	0.27	2.0	-	-	-	175	0.27	2.0	-	-	-	-	-	-	35	0.15	1.0
	T9325	0.8	170	0.27	2.0	100	0.27	2.0	160	0.27	2.0	-	-	-	-	-	-	-	-	

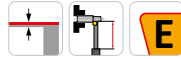
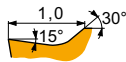

UR geometry for fine to finish machining, and continuous to slightly interrupted cuts.

TCMT 110204E-UR	T7325	0.4	135	0.19	0.8	105	0.17	0.8	-	-	-	-	-	-	-	-	-	-	-
	T8330	0.4	135	0.12	0.8	80	0.11	0.8	125	0.12	0.8	-	-	-	-	-	-	-	-
	T8430	0.4	170	0.12	0.8	90	0.11	0.8	135	0.12	0.8	-	-	-	-	-	-	-	-
	T9315	0.4	235	0.12	0.8	-	-	-	220	0.12	0.8	-	-	-	-	-	-	-	-
	T9325	0.4	175	0.18	0.8	105	0.16	0.8	165	0.18	0.8	-	-	-	-	-	-	-	-
TCMT 16T304E-UR	T7325	0.4	135	0.19	0.8	105	0.17	0.8	-	-	-	-	-	-	-	-	-	-	-
	T8330	0.4	135	0.12	0.8	80	0.11	0.8	125	0.12	0.8	-	-	-	-	-	-	-	-
	T8430	0.4	170	0.12	0.8	90	0.11	0.8	135	0.12	0.8	-	-	-	-	-	-	-	-
	T9315	0.4	235	0.12	0.8	-	-	-	220	0.12	0.8	-	-	-	-	-	-	-	-
	T9325	0.4	175	0.18	0.8	105	0.16	0.8	165	0.18	0.8	-	-	-	-	-	-	-	-
	TT310	0.4	225	0.12	0.8	135	0.11	0.8	-	-	-	-	-	-	-	-	-	-	-
TCMT 16T308E-UR	T5315	0.8	245	0.17	0.8	-	-	-	230	0.17	0.8	-	-	-	-	-	-	-	-
	T7325	0.8	170	0.17	0.8	130	0.15	0.8	-	-	-	-	-	-	-	-	-	-	
	T8330	0.8	150	0.17	0.8	90	0.15	0.8	140	0.17	0.8	-	-	-	-	-	-	-	
	T8430	0.8	175	0.17	0.8	95	0.15	0.8	140	0.17	0.8	-	-	-	-	-	-	-	
	T9315	0.8	240	0.17	0.8	-	-	-	225	0.17	0.8	-	-	-	-	-	-	-	-
	T9325	0.8	215	0.17	0.8	125	0.15	0.8	200	0.17	0.8	-	-	-	-	-	-	-	-



TCMW



	IC	D1	L	S
	[mm]	[mm]	[mm]	[mm]
1102	6.350	2.80	11.00	2.38
16T3	9.525	4.40	16.50	3.97

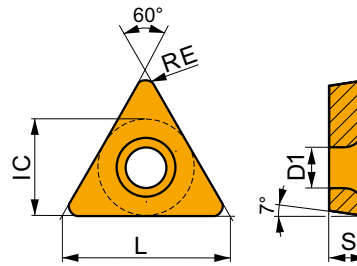

Suitability and starting values for cutting speed (vc), feed (f) and depth of cut (ap). Refer to our Machining Calculator app for further calculations.

Product	RE	P			M			K			N			S			H		
		vc	f	ap	vc	f	ap	vc	f	ap	vc	f	ap	vc	f	ap	vc	f	ap
	[mm]	[m/min]	[mm/rev]	[mm]	[m/min]	[mm/rev]	[mm]	[m/min]	[mm/rev]	[mm]	[m/min]	[mm/rev]	[mm]	[m/min]	[mm/rev]	[mm]	[m/min]	[mm/rev]	[mm]

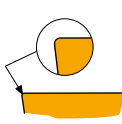

For fine-finish to semi-rough machining, and continuous to slightly interrupted cuts.

TCMW 110204	T5305	0.4	–	–	–	–	–	–	■	200	0.10	1.2	–	–	–	–	–	–	■	40	0.15	1.0
	T5315	0.4	–	–	–	–	–	–	■	180	0.10	1.2	–	–	–	–	–	–	■	35	0.15	1.0
TCMW 16T304	T5305	0.4	–	–	–	–	–	–	■	195	0.10	1.5	–	–	–	–	–	–	■	40	0.15	1.0
	T5315	0.4	–	–	–	–	–	–	■	175	0.10	1.5	–	–	–	–	–	–	■	35	0.15	1.0
	T6310	0.4	–	–	–	–	–	–	■	85	0.10	1.5	–	–	–	–	–	–	■	20	0.15	1.0
TCMW 16T308	T5305	0.8	–	–	–	–	–	–	■	190	0.18	1.5	–	–	–	–	–	–	■	40	0.15	1.0
	T5315	0.8	–	–	–	–	–	–	■	165	0.18	1.5	–	–	–	–	–	–	■	35	0.15	1.0
	T6310	0.8	–	–	–	–	–	–	■	85	0.18	1.5	–	–	–	–	–	–	■	20	0.15	1.0

TCGW CBN



	IC	D1	L	S
	[mm]	[mm]	[mm]	[mm]
1102	6.350	2.90	11.00	2.38

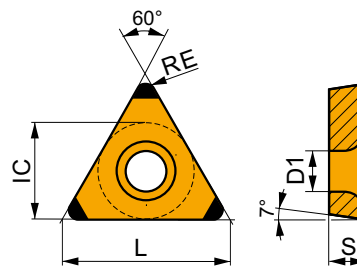

Suitability and starting values for cutting speed (vc), feed (f) and depth of cut (ap). Refer to our Machining Calculator app for further calculations.

Product	RE	P			M			K			N			S			H		
		vc	f	ap	vc	f	ap	vc	f	ap	vc	f	ap	vc	f	ap	vc	f	ap
	[mm]	[m/min]	[mm/rev]	[mm]	[m/min]	[mm/rev]	[mm]	[m/min]	[mm/rev]	[mm]	[m/min]	[mm/rev]	[mm]	[m/min]	[mm/rev]	[mm]	[m/min]	[mm/rev]	[mm]

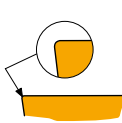

For finish machining, and continuous cuts.

TCGW 110204E-C	TB310	0.4	–	–	–	–	–	–	■	390	0.10	0.4	–	–	–	■	100	0.07	0.3	■	80	0.15	1.0
----------------	-------	-----	---	---	---	---	---	---	---	-----	------	-----	---	---	---	---	-----	------	-----	---	----	------	-----

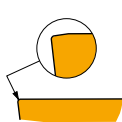

For finish machining, and continuous cuts.

TCGW 110204S01020C	TB310	0.4	–	–	–	–	–	–	■	390	0.10	0.4	–	–	–	■	100	0.07	0.3	■	80	0.15	1.0
TCGW 110208S01020C	TB310	0.8	–	–	–	–	–	–	■	400	0.15	0.6	–	–	–	■	105	0.11	0.5	■	85	0.15	1.0



STFC(RL) EXT



PRAMET

S



Ext. Screw Lock Tool Holder, 91° (Face Turning) Cutting Angle for TC.. Insert

External Right/Left hand tool holder for screw type positive TC.. 11 up to 16 inserts. Suited for external face turning with shoulder and chamfer turning. Available with shank size 16x16 up to 25x25 mm. Body treated for longer tool life.

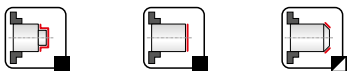
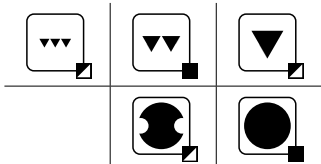
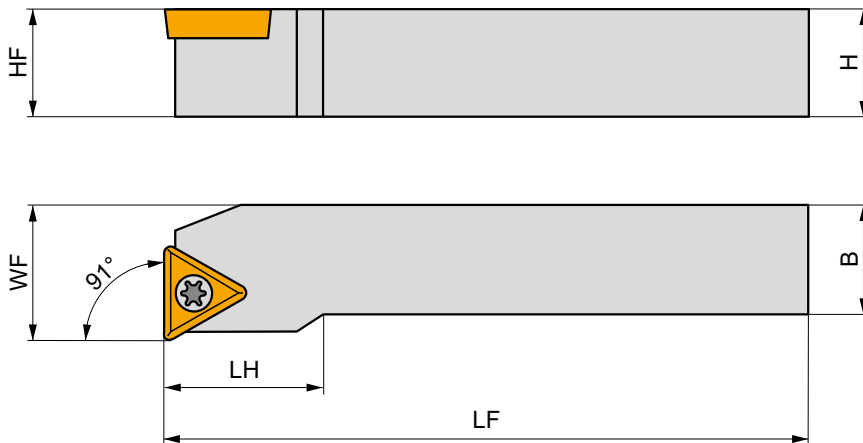
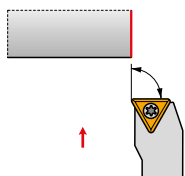

Product	H	B	HF	WF	LF	LH	LAMS	GAMO	kg	GI	ST
	[mm]	[mm]	[mm]	[mm]	[mm]	[mm]	[°]	[°]			
R STFCR 1616 H 11	16	16	16	20	100	18	0	0	0.20	GI056	S01
STFCR 2020 K 16-M-A	20	20	20	25	125	25	0	0	0.40	GI016	ST10
STFCR 2525 M 16-M-A	25	25	25	32	150	25	0	0	0.76	GI016	ST10
L STFCL 1616 H 11	16	16	16	20	100	18	0	0	0.22	GI056	S01
STFCL 2020 K 16-M-A	20	20	20	25	125	25	0	0	0.40	GI016	ST10
STFCL 2525 M 16-M-A	25	25	25	32	150	25	0	0	0.75	GI016	ST10



GI016
GI056

TC.. 16T3..
TC.. 1102..



S01
ST10

US 2506-T07P
US 3510-T15P

0.9
3.0

M 2.5
M 3.5

6.3
10.6

–
STN 160308

–
MS 3510

FLAGT07P
FLAGT15P

–
HXK 3.5



STFC(RL)-A EXT

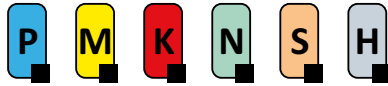

PRAMET

S



Ext. Screw Lock Tool Holder, 90° (Face Turning) Cutting Angle for TC.. Insert

External Right/Left hand tool holder for screw type positive TC.. 11 inserts. Suited for left and right-sided external face turning with shoulder and chamfer turning. Available with shank size 20x20 mm. Body treated for longer tool life.

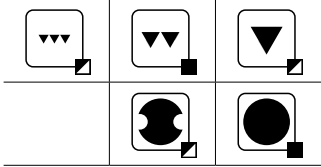
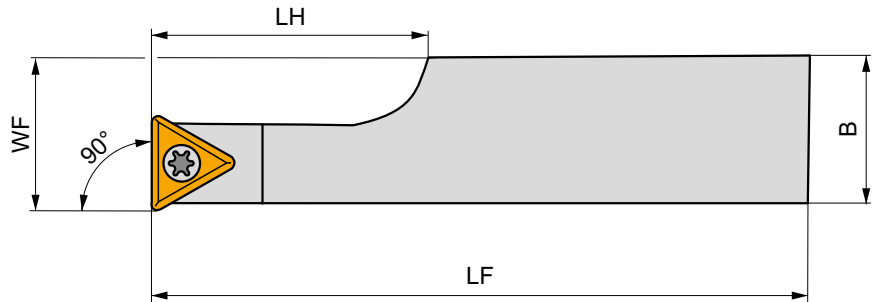
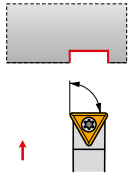

Product	H	B	HF	WF	LF	LH	LAMS	GAMO	kg	GI056	ST21
	[mm]	[mm]	[mm]	[mm]	[mm]	[mm]	[°]	[°]			
R STFCR 2020 K 11-A	20	20	20	25	125	21.3	0	0	0.52	GI056	ST21
L STFCL 2020 K 11-A	20	20	20	25	125	21.3	0	0	0.36	GI056	ST21

GI056	TC.. 1102..
-------	-------------

ST21	5513 020-03	0.8 Nm	M 2.5	6.5	PT-8001
------	-------------	--------	-------	-----	---------



STJC(RL) EXT



External Screw Lock Tool Holder with 93° Cutting Angle for TC.. Insert

External Right/Left hand tool holder for screw type positive TC.. 11 up to 16 inserts. Suited for external longitudinal turning with shoulder, taper and chamfer turning. Available with shank size 16x16 up to 25x25 mm. Body treated for longer tool life.

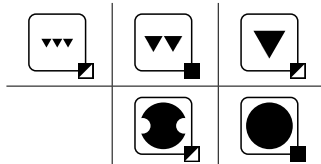
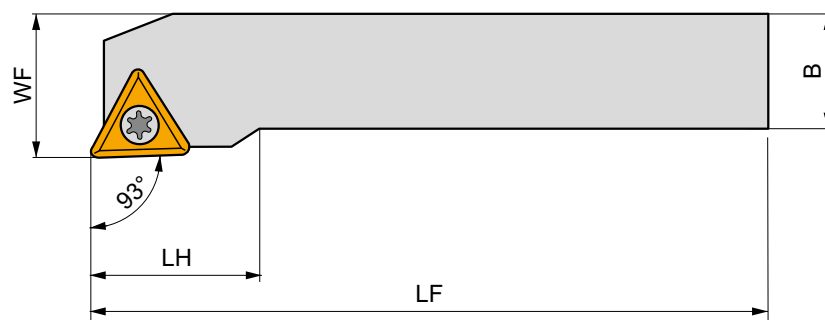
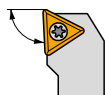

Product	H	B	HF	WF	LF	LH	LAMS	GAMO	kg			
	[mm]	[mm]	[mm]	[mm]	[mm]	[mm]	[°]	[°]				
R	STJCR 1616 H 11	16	16	16	20	100	18	0	0	0.23	GI056	S01
	STJCR 2020 K 16-M-A	20	20	20	25	125	25	0	0	0.44	GI016	ST10
	STJCR 2525 M 16-M-A	25	25	25	32	150	25	0	0	0.76	GI016	ST10
L	STJCL 1616 H 11	16	16	16	20	100	18	0	0	0.22	GI056	S01
	STJCL 2020 K 16-M-A	20	20	20	25	125	25	0	0	0.43	GI016	ST10
	STJCL 2525 M 16-M-A	25	25	25	32	150	25	0	0	0.75	GI016	ST10



GI016

TC.. 16T3..

GI056

TC.. 1102..



S01

US 2506-T07P

0.9

M 2.5

6.3

-

-

FLAGT07P

-

ST10

US 3510-T15P

3.0

M 3.5

10.6

STN 160308

MS 3510

FLAGT15P

HXK 3.5



STFC(RL) INT



PRAMET

S



Internal Screw Lock Boring Bar with 91° Cutting Angle for TC.. Insert

Internal Right/Left hand boring bar, through coolant available, 91° cutting angle for screw type TC.. 06 up to 16 inserts. Minimum internal turning diameter Ø8.5 mm. Suited for internal taper and longitudinal turning with shoulder and chamfer turning. Ø6 to Ø32 mm shanks available. Body treated for longer tool life.

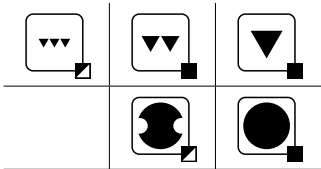
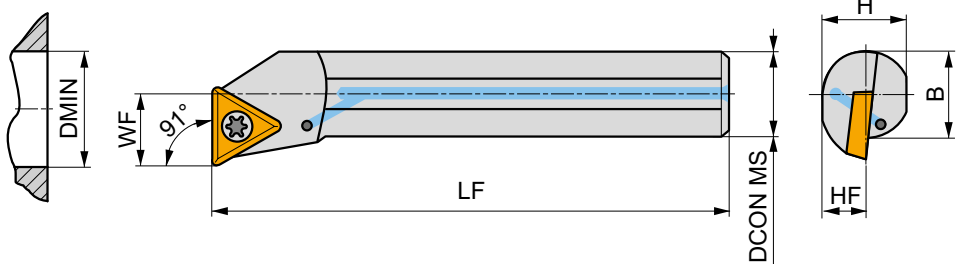
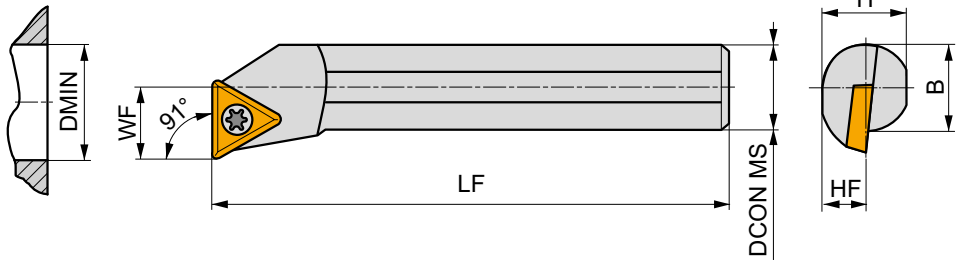
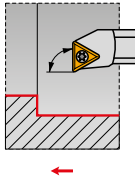

Product	DCON MS	DMIN	WF	H	B	LF	LAMS	GAMO				
	[mm]	[mm]	[mm]	[mm]	[mm]	[mm]	[°]	[°]				
R A06F-STFCR 06	6	8.5	4.5	5	-	80	-12	0	✓	0.03	G1217	ST12
A08H-STFCR 06	8	11	5.9	7	-	100	-10	0	✓	0.04	G1217	ST13
A10K-STFCR 09	10	13	7	9	-	125	-9	0	✓	0.06	G1218	ST14
A12M-STFCR 09	12	16	9	11	-	150	-6.5	0	✓	0.12	G1218	ST14
S10H-STFCR 11	10	13	7	9	9.5	100	-10	0	-	0.08	G1056	S02
A12M-STFCR 11	12	16	9	11	11.5	150	-10	0	✓	0.14	G1056	S01
S12K-STFCR 11	12	16	9	11	11.5	125	-7	0	-	0.13	G1056	S01
A16R-STFCR 11	16	20	11	14.5	15	200	-7	0	✓	0.27	G1056	S01
S16M-STFCR 11	16	20	11	14.5	15	150	-7	0	-	0.24	G1056	S01
A20S-STFCR 11	20	25	13	18	18.5	250	-7	0	✓	0.54	G1056	S01
S20Q-STFCR 11	20	25	13	18	18.5	180	-7	0	-	0.40	G1056	S01
A25R-STFCR 16	25	32	17	23	23	200	-3	0	✓	0.67	G1016	S08
S25T-STFCR 16	25	32	17	23	23	300	-3	0	-	1.15	G1016	S08
A32S-STFCR 16	32	40	22	30	30	250	-10	0	✓	1.36	G1016	ST10
S32U-STFCR 16-A	32	40	22	30	30	350	-10	0	-	2.10	G1016	ST10
L A06F-STFCL 06	6	8.5	4.5	5	-	80	-12	0	✓	0.03	G1217	ST12
A08H-STFCL 06	8	11	5.9	7	-	100	-10	0	✓	0.05	G1217	ST13
A10K-STFCL 09	10	13	7	9	-	125	-9	0	✓	0.06	G1218	ST14
A12M-STFCL 09	12	16	9	11	-	150	-6.5	0	✓	0.03	G1218	ST14
S10H-STFCL 11	10	13	7	9	9.5	100	-10	0	-	0.06	G1056	S02
A12M-STFCL 11	12	16	9	11	11.5	150	-10	0	✓	0.12	G1056	S01
S12K-STFCL 11	12	16	9	11	11.5	125	-7	0	-	0.12	G1056	S01
A16R-STFCL 11	16	20	11	14.5	15	200	-7	0	✓	0.00	G1056	S01
S16M-STFCL 11	16	20	11	14.5	15	150	-7	0	-	0.25	G1056	S01
A20S-STFCL 11	20	25	13	18	18.5	250	-7	0	✓	0.00	G1056	S01
S20Q-STFCL 11	20	25	13	18	18.5	180	-7	0	-	0.42	G1056	S01
A25R-STFCL 16	25	32	17	23	23	200	-3	0	✓	0.00	G1016	S08



Product	DCON MS	DMIN	WF	H	B	LF	LAMS	GAMO				
	[mm]	[mm]	[mm]	[mm]	[mm]	[mm]	[°]	[°]				
L S25T-STFCL 16	25	32	17	23	23	300	-3	0	-	1.15	G1016	S08
A32S-STFCL 16	32	40	22	30	30	250	-10	0	✓	1.36	G1016	ST10
S32U-STFCL 16-A	32	40	22	30	30	350	-10	0	-	2.06	G1016	ST10

G1016	TC.. 16T3..
G1056	TC.. 1102..
G1217	TC.. 06T1..
G1218	TC.. 0902..

S01	US 2506-T07P	0.9	M 2.5	6.3	-	-	FLAG T07P	-	-
S02	US 2505-T07P	0.9	M 2.5	5.2	-	-	FLAG T07P	-	-
S08	US 3510-T15P	3.0	M 3.5	10.6	-	-	FLAG T15P	-	-
ST10	US 3510-T15P	3.0	M 3.5	10.6	STN 160308	MS 3510	FLAG T15P	HXK 3.5	-
ST12	5513 020-28	0.6	M 2	4.2	-	-	-	-	PT-8000
ST13	5513 020-27	0.6	M 2	4.9	-	-	-	-	PT-8000
ST14	5513 020-05	0.8	M 2.2	6.4	-	-	-	-	PT-8001



STFC(RL)-E INT

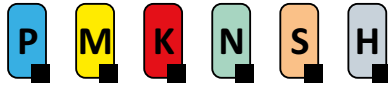

PRAMET

S



Internal Carbide Screw Lock Boring Bar with 91° Cutting Angle for TC.. Insert

Internal Right/Left hand carbide boring bar, through coolant, with 91° cutting angle for screw type TC.. 06 up to 11 inserts. Minimum internal turning diameter Ø8.5 mm. For internal taper and longitudinal turning with shoulder and chamfer turning. Available with shank size Ø6 up to Ø16 mm. For tool overhang >3xD.

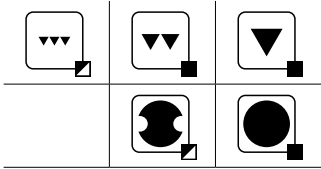
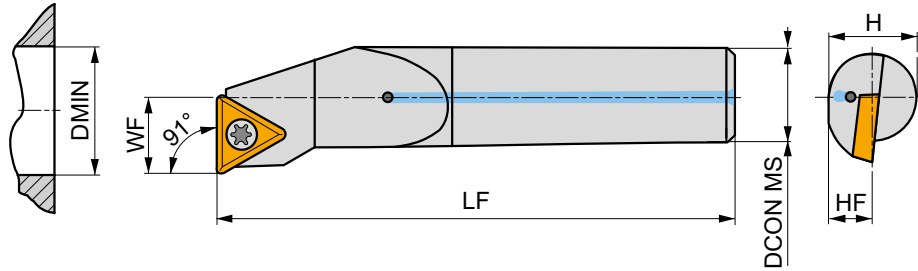
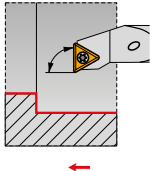

Product	DCON MS	DMIN	WF	H	HF	LF	LAMS	GAMO	✓	kg	GI217	ST22	
	[mm]	[mm]	[mm]	[mm]	[mm]	[mm]	[°]	[°]					
R	E06H-STFCR 06-R	6	8.5	4.5	6	3	100	-10	0	✓	0.05	GI217	ST22
	E08K-STFCR 06-R	8	11	5.9	8	4	125	-10	0	✓	0.09	GI217	ST23
	E10M-STFCR 09-R	10	13	7	10	5	150	-8	0	✓	0.15	GI218	ST24
	E12Q-STFCR 09-R	12	16	9	12	6	180	-6	0	✓	0.26	GI218	ST24
E16R-STFCR 11-R	16	20	11	16	8	200	-5	0	✓	0.48	GI056	ST21	
L	E06H-STFCL 06-R	6	8.5	4.5	6	3	100	-10	0	✓	0.05	GI217	ST22
	E08K-STFCL 06-R	8	11	5.9	8	4	125	-10	0	✓	0.09	GI217	ST23
	E10M-STFCL 09-R	10	13	7	10	5	150	-8	0	✓	0.15	GI218	ST24
	E12Q-STFCL 09-R	12	16	9	12	6	180	-6	0	✓	0.26	GI218	ST24
	E16R-STFCL 11-R	16	20	11	16	8	200	-5	0	✓	0.48	GI056	ST21

GI056	GI217	GI218	TC.. 1102..	TC.. 06T1..	TC.. 0902..

ST21	5513 020-03	0.8	M 2.5	6.5	PT-8001
ST22	5513 020-28	0.6	M 2	4.2	PT-8000
ST23	5513 020-27	0.6	M 2	4.9	PT-8000
ST24	5513 020-05	0.8	M 2.2	6.4	PT-8001



TP

09/ 11/ 16

CARBIDE INSERTS

TPGX



162

TPMR



163

TPUN



164

CER INSERTS

TPGN CER



164



TPGX



	IC	D1	L	S
	[mm]	[mm]	[mm]	[mm]
0902	5.560	2.50	9.60	2.38
1102	6.350	2.80	11.00	2.38
16T3	9.525	4.40	16.50	3.97

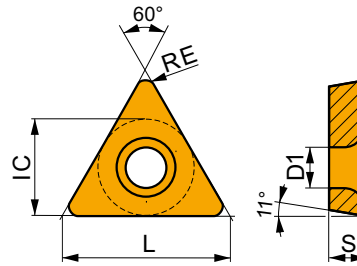

Suitability and starting values for cutting speed (vc), feed (f) and depth of cut (ap). Refer to our Machining Calculator app for further calculations.

Product	RE	P			M			K			N			S			H		
		vc	f	ap	vc	f	ap	vc	f	ap	vc	f	ap	vc	f	ap	vc	f	ap
	[mm]	[m/min]	[mm/rev]	[mm]	[m/min]	[mm/rev]	[mm]	[m/min]	[mm/rev]	[mm]	[m/min]	[mm/rev]	[mm]	[m/min]	[mm/rev]	[mm]	[m/min]	[mm/rev]	[mm]

				FR-JQ geometry with positive right-handed design for fine-finish machining, and continuous cuts.																
TPGX 110204FR-JQ	TT010	0.4	■ 295	0.06	0.5	■ 175	0.05	0.5	■	■	■	■	■	■	■	■	■	■	■	■
				FL-JQ geometry with positive left-handed design for fine-finish machining, continuous cuts.																
TPGX 090204FL-JQ	TT010	0.4	■ 295	0.06	0.5	■ 175	0.05	0.5	■	■	■	■	■	■	■	■	■	■	■	■
TPGX 110204FL-JQ	TT010	0.4	■ 295	0.06	0.5	■ 175	0.05	0.5	■	■	■	■	■	■	■	■	■	■	■	■
				FL-JR geometry with positive left-handed design for fine-finish machining, and continuous cuts.																
TPGX 16T304FL-JR	TT010	0.4	■ 295	0.06	0.5	■ 175	0.05	0.5	■	■	■	■	■	■	■	■	■	■	■	■
				FR-JZ geometry with positive right-handed design for fine-finish machining, and continuous cuts.																
TPGX 090202FR-JZ	TT010	0.2	■ 280	0.06	0.5	■ 165	0.05	0.5	■	■	■	■	■	■	■	■	■	■	■	■
				FL-JZ geometry with positive left-handed design for fine-finish machining, and continuous cuts.																
TPGX 090202FL-JZ	TT010	0.2	■ 280	0.06	0.5	■ 165	0.05	0.5	■	■	■	■	■	■	■	■	■	■	■	■



TPMR



	IC	L	S
	[mm]	[mm]	[mm]
1103	6.350	11.00	3.18
1603	9.525	16.50	3.18

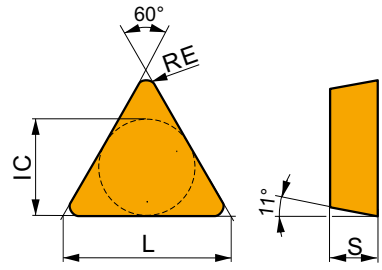

Suitability and starting values for cutting speed (vc), feed (f) and depth of cut (ap). Refer to our Machining Calculator app for further calculations.

Product	RE	P			M			K			N			S			H		
		vc	f	ap	vc	f	ap	vc	f	ap	vc	f	ap	vc	f	ap	vc	f	ap
	[mm]	[m/min]	[mm/rev]	[mm]	[m/min]	[mm/rev]	[mm]	[m/min]	[mm/rev]	[mm]	[m/min]	[mm/rev]	[mm]	[m/min]	[mm/rev]	[mm]	[m/min]	[mm/rev]	[mm]

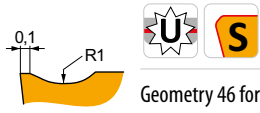

Geometry 46 for fine to finish machining, and continuous to interrupted cuts.

TPMR 110304E-46	6640	0.4	140	0.15	1.0	80	0.14	1.0	130	0.15	1.0	-	-	-	-	-	-	-	-
	T9325	0.4	175	0.15	1.0	105	0.15	1.0	165	0.15	1.0	-	-	-	-	-	-	-	-
	T9335	0.4	150	0.15	1.0	90	0.15	1.0	-	-	-	-	-	-	-	-	-	-	-
TPMR 110308E-46	6640	0.8	170	0.15	1.0	100	0.14	1.0	160	0.15	1.0	-	-	-	-	-	-	-	-
	T9325	0.8	205	0.15	1.0	120	0.15	1.0	190	0.15	1.0	-	-	-	-	-	-	-	-
	T9335	0.8	180	0.15	1.0	105	0.15	1.0	-	-	-	-	-	-	-	-	-	-	-

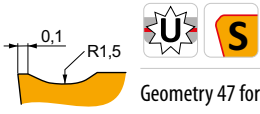

Geometry 47 for finish to semi-rough machining, and continuous to interrupted cuts.

TPMR 160304E-47	6640	0.4	120	0.20	1.5	70	0.18	1.5	110	0.20	1.5	-	-	-	-	-	-	-	-
	T9325	0.4	150	0.20	1.5	90	0.18	1.5	140	0.20	1.5	-	-	-	-	-	-	-	-
	T9335	0.4	125	0.20	1.5	75	0.18	1.5	-	-	-	-	-	-	-	-	-	-	-
TPMR 160308E-47	6640	0.8	140	0.20	1.5	80	0.18	1.5	130	0.20	1.5	-	-	-	-	-	-	-	-
	T9325	0.8	175	0.20	1.5	105	0.18	1.5	165	0.20	1.5	-	-	-	-	-	-	-	-
	T9335	0.8	150	0.20	1.5	90	0.18	1.5	-	-	-	-	-	-	-	-	-	-	-
TPMR 160312E-47	T9325	1.2	185	0.20	1.5	110	0.18	1.5	175	0.20	1.5	-	-	-	-	-	-	-	-
	T9335	1.2	160	0.20	1.5	95	0.18	1.5	-	-	-	-	-	-	-	-	-	-	-

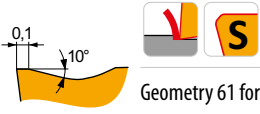

Geometry 61 for finish machining with moderate feeds and depths of cut, and continuous to interrupted cuts.

TPMR 160308E-61	T9325	0.8	135	0.35	1.8	80	0.32	1.8	125	0.35	1.8	-	-	-	-	-	-	-	-
	T9335	0.8	120	0.35	1.8	70	0.32	1.8	-	-	-	-	-	-	-	-	-	-	-

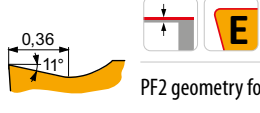

PF2 geometry for fine to finish machining, and continuous cuts.

TPMR 110304-PF2	TT010	0.4	255	0.10	0.5	150	0.10	0.5	-	-	-	-	-	-	-	-	-	-	-
TPMR 160304-PF2	TT010	0.4	255	0.10	0.5	150	0.10	0.5	-	-	-	-	-	-	-	-	-	-	-



TPUN



	IC	L	S
	[mm]	[mm]	[mm]
1103	6.350	11.00	3.18
1603	9.525	16.50	3.18
2204	12.700	22.00	4.76
2706	15.875	27.50	6.35
3306	19.050	33.00	6.35

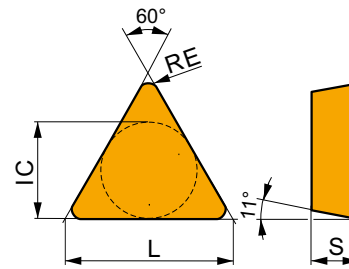

Suitability and starting values for cutting speed (vc), feed (f) and depth of cut (ap). Refer to our Machining Calculator app for further calculations.

Product	RE	P			M			K			N			S			H		
		vc	f	ap	vc	f	ap	vc	f	ap	vc	f	ap	vc	f	ap	vc	f	ap
	[mm]	[m/min]	[mm/rev]	[mm]	[m/min]	[mm/rev]	[mm]	[m/min]	[mm/rev]	[mm]	[m/min]	[mm/rev]	[mm]	[m/min]	[mm/rev]	[mm]	[m/min]	[mm/rev]	[mm]

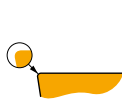

For fine-finish to semi-rough machining, and continuous to slightly interrupted cuts.

TPUN 110304	6640	0.4	✓	135	0.10	1.2	–	–	–	■	125	0.10	1.2	–	–	–	–	–	–	–	–	–
TPUN 110308	6640	0.8	✓	125	0.18	1.2	–	–	–	■	115	0.18	1.2	–	–	–	–	–	–	–	–	–
TPUN 160304	6640	0.4	✓	135	0.10	1.5	–	–	–	■	125	0.10	1.5	–	–	–	–	–	–	–	–	–
TPUN 160308	6640	0.8	✓	125	0.18	1.5	–	–	–	■	115	0.18	1.5	–	–	–	–	–	–	–	–	–
TPUN 160312	6640	1.2	✓	125	0.20	1.5	–	–	–	■	115	0.20	1.5	–	–	–	–	–	–	–	–	–
TPUN 220408	6640	0.8	✓	120	0.18	2.0	–	–	–	■	110	0.18	2.0	–	–	–	–	–	–	–	–	–
TPUN 220412	6640	1.2	✓	120	0.20	2.0	–	–	–	■	110	0.20	2.0	–	–	–	–	–	–	–	–	–

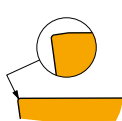

For fine-finish to semi-rough machining, and continuous to slightly interrupted cuts.

TPUN 2706165	6640	1.6	✓	60	0.30	7.0	–	–	–	■	55	0.30	7.0	–	–	–	–	–	–	–	–
TPUN 3306205	6640	2.0	✓	65	0.30	5.0	–	–	–	■	60	0.30	5.0	–	–	–	–	–	–	–	–

TPGN CER



	IC	L	S
	[mm]	[mm]	[mm]
1103	6.350	11.00	3.18
1603	9.525	16.50	3.18

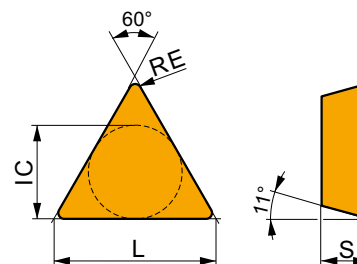

Suitability and starting values for cutting speed (vc), feed (f) and depth of cut (ap). Refer to our Machining Calculator app for further calculations.

Product	RE	P			M			K			N			S			H		
		vc	f	ap	vc	f	ap	vc	f	ap	vc	f	ap	vc	f	ap	vc	f	ap
	[mm]	[m/min]	[mm/rev]	[mm]	[m/min]	[mm/rev]	[mm]	[m/min]	[mm/rev]	[mm]	[m/min]	[mm/rev]	[mm]	[m/min]	[mm/rev]	[mm]	[m/min]	[mm/rev]	[mm]

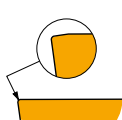

For machining with high speeds and continuous cuts.

TPGN 110304 T01020	TC100	0.4	–	–	–	–	–	–	–	–	✓	460	0.10	1.5	–	–	–	–	–	–	–	–
TPGN 110308 T01020	TC100	0.8	–	–	–	–	–	–	–	–	✓	425	0.20	1.5	–	–	–	–	–	–	–	–



Suitability and starting values for cutting speed (vc), feed (f) and depth of cut (ap). Refer to our Machining Calculator app for further calculations.

Product	RE (mm)	P			M			K			N			S			H		
		vc [m/min]	f [mm/rev]	ap [mm]	vc [m/min]	f [mm/rev]	ap [mm]	vc [m/min]	f [mm/rev]	ap [mm]	vc [m/min]	f [mm/rev]	ap [mm]	vc [m/min]	f [mm/rev]	ap [mm]	vc [m/min]	f [mm/rev]	ap [mm]

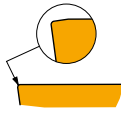

For machining with high speeds and continuous cuts.

TPGN 160304 T01020	TC100	0.4	-	-	-	-	-	-	460	0.10	1.5	-	-	-	-	-	-	-	-	-
TPGN 160308 T01020	TC100	0.8	-	-	-	-	-	-	425	0.20	1.5	-	-	-	-	-	-	-	-	-
TPGN 160312 T01020	TC100	1.2	-	-	-	-	-	-	450	0.20	1.5	-	-	-	-	-	-	-	-	-



VB

CARBIDE INSERTS

VBMT



168

CBN INSERTS

VBGW CBN



171

MATCH THE RIGHT SIZE (example)

Insert

VBMT 160408E-FM

Tool Holder

SVHCR 2020 K 16-M-A

ISO TURNING – EXTERNAL

<p>SVHB(C)(RL) EXT</p> <p>107°30'</p> <p>VB, VC..</p> <p>11 16</p> <p>16x16 25x25</p> <p>172 168 – 171 186 – 192</p>	<p>SVJB(C)(RL) EXT</p> <p>93°</p> <p>VB, VC..</p> <p>11 13 16</p> <p>12x12 32x25</p> <p>173 168 – 171 186 – 192</p>	<p>SVPB(C)(RL) EXT</p> <p>117°30'</p> <p>VB, VC..</p> <p>11 16</p> <p>16x16 32x25</p> <p>174 168 – 171 186 – 192</p>	<p>SVVB(C)N EXT</p> <p>72°30'</p> <p>VB, VC..</p> <p>11 13 16</p> <p>12x12 32x25</p> <p>175 168 – 171 186 – 192</p>
<p>SVXB(C)(RL) EXT</p> <p>98°</p> <p>VB, VC..</p> <p>11 13 16</p> <p>12x12 32x25</p> <p>176 168 – 171 186 – 192</p>	<p>C.-SVHB(RL) EXT</p> <p>107°30'</p> <p>VB, VC..</p> <p>16</p> <p>C4 C6</p> <p>177 168 – 171 186 – 192</p>	<p>C.-SVJB(RL) EXT</p> <p>93°</p> <p>VB, VC..</p> <p>11 16</p> <p>C3 C6</p> <p>178 168 – 171 186 – 192</p>	<p>C.-SVVBN EXT</p> <p>72°30'</p> <p>VB, VC..</p> <p>16</p> <p>C4 C6</p> <p>179 168 – 171 186 – 192</p>



VB

11/ 16

ISO TURNING – INTERNAL

SVJB(RL) INT		SVQB(C)(RL) INT		SVUB(C)(RL) INT		C.-SVQB(C)(RL) INT	
93°	VB, VC..	107°30'	VB, VC..	93°	VB, VC..	108°	VB, VC..
	11		11 13 16		11 13 16		16
	$\frac{25}{32}$		$\frac{20}{50}$		$\frac{20}{50}$		33
	180		181		182		183
	168 – 171 186 – 192		168 – 171 186 – 192		168 – 171 186 – 192		168 – 171 186 – 192



VBMT



	IC	D1	L	S
	[mm]	[mm]	[mm]	[mm]
1102	6.350	2.80	11.10	2.38
1103	6.350	2.80	11.10	3.18
1604	9.525	4.40	16.60	4.76

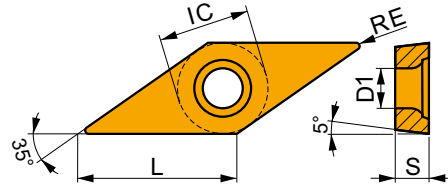

Suitability and starting values for cutting speed (vc), feed (f) and depth of cut (ap). Refer to our Machining Calculator app for further calculations.

Product	RE	P			M			K			N			S			H		
		vc	f	ap	vc	f	ap	vc	f	ap	vc	f	ap	vc	f	ap	vc	f	ap
	[mm]	[m/min]	[mm/rev]	[mm]	[m/min]	[mm/rev]	[mm]	[m/min]	[mm/rev]	[mm]	[m/min]	[mm/rev]	[mm]	[m/min]	[mm/rev]	[mm]	[m/min]	[mm/rev]	[mm]

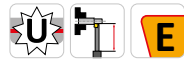
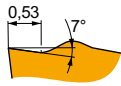

FF2 geometry with positive design for fine-finish to finish machining, and continuous to slightly interrupted cuts.

VBMT 160404E-FF2	T7325	0.4	✓	145	0.12	0.8	–	–	–	–	–	–	–	–	–	–	–	–	–
	T8330	0.4	■	125	0.12	0.8	–	–	–	■	115	0.12	0.8	–	–	–	–	–	–
	T8430	0.4	■	150	0.12	0.8	–	–	–	✓	125	0.12	0.8	–	–	–	–	–	–
	T9315	0.4	■	215	0.12	0.8	–	–	–	✓	200	0.12	0.8	–	–	–	–	–	–
	T9325	0.4	■	190	0.12	0.8	–	–	–	✓	180	0.12	0.8	–	–	–	–	–	–
	T9335	0.4	■	160	0.12	0.8	–	–	–	–	–	–	–	–	–	–	–	–	–

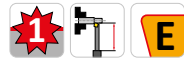

FM geometry for finish to semi-rough machining, and continuous to slightly interrupted cuts.

VBMT 110302E-FM	T7325	0.2	✓	160	0.10	0.8	■	120	0.09	0.8	–	–	–	–	–	–	–	–	–	
	T8315	0.2	✓	145	0.10	0.8	■	85	0.09	0.8	✓	135	0.10	0.8	✓	435	0.12	0.8	–	–
	T8330	0.2	■	135	0.10	0.8	■	80	0.09	0.8	✓	125	0.10	0.8	✓	405	0.12	0.8	–	–
	T8430	0.2	■	170	0.10	0.8	■	90	0.09	0.8	✓	135	0.10	0.8	✓	465	0.12	0.8	–	–
	T9325	0.2	■	210	0.10	0.8	■	125	0.09	0.8	✓	195	0.10	0.8	–	–	–	–	–	–
	T9315	0.2	■	210	0.10	0.8	■	125	0.09	0.8	✓	195	0.10	0.8	–	–	–	–	–	–
VBMT 110304E-FM	T7325	0.4	✓	140	0.19	0.8	■	105	0.17	0.8	–	–	–	–	–	–	–	–	–	
	T7335	0.4	✓	135	0.19	0.8	■	105	0.17	0.8	–	–	–	–	–	–	–	–	–	
	T8315	0.4	✓	145	0.12	0.8	■	85	0.11	0.8	✓	135	0.12	0.8	✓	435	0.14	0.8	–	–
	T8330	0.4	■	140	0.12	0.8	■	80	0.11	0.8	✓	130	0.12	0.8	✓	420	0.14	0.8	–	–
	T8430	0.4	■	170	0.12	0.8	■	90	0.11	0.8	✓	135	0.12	0.8	✓	465	0.14	0.8	–	–
	T9315	0.4	■	235	0.12	0.8	–	–	–	–	–	–	–	–	–	–	–	–	–	–
VBMT 110308E-FM	T7325	0.8	✓	170	0.17	0.8	■	130	0.15	0.8	–	–	–	–	–	–	–	–	–	
	T8330	0.8	■	150	0.17	0.8	■	90	0.15	0.8	✓	140	0.17	0.8	✓	450	0.20	0.8	–	–
	T8430	0.8	■	175	0.17	0.8	■	95	0.15	0.8	✓	140	0.17	0.8	✓	480	0.20	0.8	–	–
	T9315	0.8	■	240	0.17	0.8	–	–	–	–	–	–	–	–	–	–	–	–	–	–
	T9325	0.8	■	215	0.17	0.8	■	125	0.15	0.8	✓	200	0.17	0.8	–	–	–	–	–	–
	T9315	0.8	■	215	0.17	0.8	■	125	0.15	0.8	✓	200	0.17	0.8	–	–	–	–	–	–
VBMT 160402E-FM	T7325	0.2	✓	150	0.10	1.2	■	115	0.09	1.2	–	–	–	–	–	–	–	–	–	
	T8330	0.2	■	130	0.10	1.2	■	75	0.09	1.2	✓	120	0.10	1.2	✓	390	0.12	1.2	–	–
	T8430	0.2	■	165	0.10	1.2	■	90	0.09	1.2	✓	135	0.10	1.2	✓	450	0.12	1.2	–	–
	T9315	0.2	■	230	0.10	1.2	–	–	–	–	–	–	–	–	–	–	–	–	–	–
	T9325	0.2	■	205	0.10	1.2	■	120	0.09	1.2	✓	190	0.10	1.2	–	–	–	–	–	–
	T9315	0.2	■	230	0.10	1.2	–	–	–	–	–	–	–	–	–	–	–	–	–	–
VBMT 160404E-FM	T5315	0.4	✓	225	0.12	1.2	–	–	–	–	–	–	–	–	–	–	–	–	–	
	T7325	0.4	✓	130	0.19	1.2	■	100	0.17	1.2	–	–	–	–	–	–	–	–	–	
	T7335	0.4	✓	130	0.19	1.2	■	100	0.17	1.2	–	–	–	–	–	–	–	–	–	
	T8315	0.4	✓	140	0.12	1.2	■	80	0.11	1.2	✓	130	0.12	1.2	✓	420	0.14	1.2	–	–
	T8330	0.4	■	135	0.12	1.2	■	80	0.11	1.2	✓	125	0.12	1.2	✓	405	0.14	1.2	–	–
	T8430	0.4	■	165	0.12	1.2	■	90	0.11	1.2	✓	135	0.12	1.2	✓	450	0.14	1.2	–	–
	T9315	0.4	■	225	0.12	1.2	–	–	–	–	–	–	–	–	–	–	–	–	–	–
	T9325	0.4	■	165	0.19	1.2	■	95	0.17	1.2	✓	155	0.19	1.2	–	–	–	–	–	–
	T9315	0.4	■	225	0.12	1.2	–	–	–	–	–	–	–	–	–	–	–	–	–	–



Suitability and starting values for cutting speed (vc), feed (f) and depth of cut (ap). Refer to our Machining Calculator app for further calculations.

Product	RE [mm]	P			M			K			N			S			H		
		vc	f	ap	vc	f	ap	vc	f	ap	vc	f	ap	vc	f	ap	vc	f	ap
		[m/min]	[mm/rev]	[mm]	[m/min]	[mm/rev]	[mm]	[m/min]	[mm/rev]	[mm]	[m/min]	[mm/rev]	[mm]	[m/min]	[mm/rev]	[mm]	[m/min]	[mm/rev]	[mm]

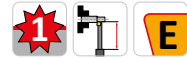
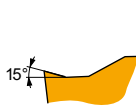

FM geometry for finish to semi-rough machining, and continuous to slightly interrupted cuts.

VBMT 160408E-FM	T5315	0.8	235	0.17	1.2	–	–	–	220	0.17	1.2	–	–	–	–	–	–	–	–
	T7325	0.8	165	0.17	1.2	125	0.15	1.2	–	–	–	–	–	–	–	–	–	–	
	T7335	0.8	160	0.17	1.2	120	0.15	1.2	–	–	–	–	–	–	–	–	–	–	
	T8315	0.8	150	0.17	1.2	90	0.15	1.2	140	0.17	1.2	450	0.20	1.2	–	–	–	–	
	T8330	0.8	145	0.17	1.2	85	0.15	1.2	135	0.17	1.2	435	0.20	1.2	–	–	–	–	
	T8430	0.8	170	0.17	1.2	90	0.15	1.2	135	0.17	1.2	465	0.20	1.2	–	–	–	–	
	T9310	0.8	255	0.17	1.2	–	–	–	240	0.17	1.2	–	–	–	–	–	–	–	
	T9315	0.8	230	0.17	1.2	–	–	–	215	0.17	1.2	–	–	–	–	–	–	–	
	T9325	0.8	205	0.17	1.2	120	0.15	1.2	190	0.17	1.2	–	–	–	–	–	–	–	
	VBMT 160412E-FM	T7325	1.2	160	0.22	1.2	120	0.22	1.2	–	–	–	–	–	–	–	–	–	–
T8330		1.2	140	0.22	1.2	80	0.22	1.2	130	0.22	1.2	420	0.26	1.2	–	–	–	–	
T8430		1.2	155	0.22	1.2	85	0.22	1.2	130	0.22	1.2	435	0.26	1.2	–	–	–	–	
T9315		1.2	215	0.22	1.2	–	–	–	200	0.22	1.2	–	–	–	–	–	–	–	
T9325		1.2	195	0.22	1.2	115	0.22	1.2	185	0.22	1.2	–	–	–	–	–	–	–	

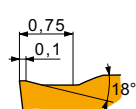

FM2 geometry for finish to medium machining, and continuous to interrupted cuts.

VBMT 160404E-FM2	T6310	0.4	120	0.12	1.2	85	0.11	1.2	95	0.12	1.2	–	–	–	–	–	–	–
	T7325	0.4	140	0.12	1.2	105	0.11	1.2	–	–	–	–	–	–	–	–	–	
	T8330	0.4	125	0.12	1.2	75	0.11	1.2	115	0.12	1.2	–	–	–	–	–	–	
	T8430	0.4	145	0.12	1.2	80	0.11	1.2	120	0.12	1.2	–	–	–	–	–	–	
	T9315	0.4	200	0.12	1.2	–	–	–	190	0.12	1.2	–	–	–	–	–	–	
	T9325	0.4	185	0.12	1.2	110	0.11	1.2	175	0.12	1.2	–	–	–	–	–	–	
VBMT 160408E-FM2	T6310	0.8	125	0.20	1.2	90	0.18	1.2	100	0.20	1.2	–	–	–	–	–	–	
	T7325	0.8	145	0.20	1.2	110	0.18	1.2	–	–	–	–	–	–	–	–		
	T8330	0.8	125	0.20	1.2	75	0.18	1.2	115	0.20	1.2	–	–	–	–	–		
	T8430	0.8	140	0.20	1.2	75	0.18	1.2	115	0.20	1.2	–	–	–	–	–		
	T9315	0.8	195	0.20	1.2	–	–	–	185	0.20	1.2	–	–	–	–	–		
	T9325	0.8	175	0.20	1.2	105	0.18	1.2	165	0.20	1.2	–	–	–	–	–		
VBMT 160412E-FM2	T8430	1.2	145	0.22	1.2	80	0.20	1.2	120	0.22	1.2	–	–	–	–	–		
	T9315	1.2	195	0.22	1.2	–	–	–	185	0.22	1.2	–	–	–	–	–		
	T9325	1.2	175	0.22	1.2	105	0.20	1.2	165	0.22	1.2	–	–	–	–	–		

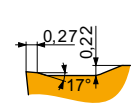

RM geometry for semi-rough to rough machining, and continuous to interrupted cuts.

VBMT 160404E-RM	T5305	0.4	270	0.12	1.2	–	–	–	255	0.12	1.2	–	–	–	–	–	50	0.15	1.0	
	T5315	0.4	235	0.12	1.2	–	–	–	220	0.12	1.2	–	–	–	–	–	45	0.15	1.0	
	T7335	0.4	140	0.18	1.2	105	0.16	1.2	–	–	–	45	0.16	1.0	–	–	–			
	T8330	0.4	140	0.12	1.2	80	0.11	1.2	130	0.12	1.2	–	–	–	35	0.11	1.0	25	0.15	1.0
	T8430	0.4	170	0.12	1.2	90	0.11	1.2	135	0.12	1.2	–	–	–	35	0.11	1.0	25	0.15	1.0
	T9315	0.4	235	0.12	1.2	–	–	–	220	0.12	1.2	–	–	–	–	–	45	0.15	1.0	
VBMT 160408E-RM	T9325	0.4	170	0.20	1.2	100	0.18	1.2	160	0.20	1.2	–	–	–	35	0.18	1.0	–	–	
	T5305	0.8	285	0.17	1.2	–	–	–	270	0.17	1.2	–	–	–	–	–	55	0.15	1.0	
	T5315	0.8	250	0.17	1.2	–	–	–	235	0.17	1.2	–	–	–	–	–	50	0.15	1.0	
	T7335	0.8	155	0.20	1.2	120	0.18	1.2	–	–	–	50	0.18	1.0	–	–	–			
	T8330	0.8	150	0.17	1.2	90	0.15	1.2	140	0.17	1.2	–	–	–	35	0.12	1.0	30	0.15	1.0
	T8430	0.8	175	0.17	1.2	95	0.15	1.2	140	0.17	1.2	–	–	–	35	0.12	1.0	30	0.15	1.0
	T9315	0.8	240	0.17	1.2	–	–	–	225	0.17	1.2	–	–	–	–	–	45	0.15	1.0	
	T9325	0.8	200	0.20	1.2	120	0.18	1.2	190	0.20	1.2	–	–	–	45	0.18	1.0	–	–	



Suitability and starting values for cutting speed (vc), feed (f) and depth of cut (ap). Refer to our Machining Calculator app for further calculations.

Product	RE  (mm)	P			M			K			N			S			H		
		vc (m/min)	f (mm/rev)	ap (mm)	vc (m/min)	f (mm/rev)	ap (mm)	vc (m/min)	f (mm/rev)	ap (mm)	vc (m/min)	f (mm/rev)	ap (mm)	vc (m/min)	f (mm/rev)	ap (mm)	vc (m/min)	f (mm/rev)	ap (mm)

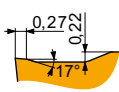

RM geometry for semi-rough to rough machining, and continuous to interrupted cuts.

VBMT 160412E-RM	T7335	1.2	✓	150	0.27	1.2	■	115	0.24	1.2	■	–	–	–	■	45	0.19	1.0	–	–	–				
	T8330	1.2	■	140	0.27	1.2	■	80	0.24	1.2	■	130	0.27	1.2	–	–	–	■	35	0.19	1.0	■	25	0.15	1.0
	T8430	1.2	■	155	0.27	1.2	■	85	0.24	1.2	■	130	0.27	1.2	–	–	–	■	30	0.19	1.0	■	25	0.15	1.0
	T9315	1.2	■	210	0.27	1.2	■	–	–	–	■	195	0.27	1.2	–	–	–	–	–	–	–	■	40	0.15	1.0
	T9325	1.2	■	185	0.27	1.2	■	110	0.24	1.2	■	175	0.27	1.2	–	–	–	■	40	0.19	1.0	–	–	–	

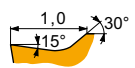

UR geometry for fine to finish machining, and continuous to slightly interrupted cuts.

VBMT 110202E-UR	TT310	0.2	■	195	0.10	0.8	■	115	0.09	0.8	■	–	–	–	–	–	–	–	–	–	–	–	–	–	
	VBMT 110204E-UR	T7325	0.4	■	120	0.19	0.8	■	90	0.17	0.8	■	–	–	–	–	–	–	–	–	–	–	–	–	
VBMT 160402E-UR	T8330	0.4	■	120	0.12	0.8	■	70	0.11	0.8	■	110	0.12	0.8	–	–	–	–	–	–	–	–	–	–	
	T8430	0.4	■	145	0.12	0.8	■	80	0.11	0.8	■	120	0.12	0.8	–	–	–	–	–	–	–	–	–	–	
	T9315	0.4	■	200	0.12	0.8	■	–	–	–	■	190	0.12	0.8	–	–	–	–	–	–	–	–	–	–	
	T9325	0.4	■	150	0.19	0.8	■	90	0.17	0.8	■	140	0.19	0.8	–	–	–	–	–	–	–	–	–	–	–
	TT310	0.4	■	195	0.12	0.8	■	115	0.11	0.8	■	–	–	–	–	–	–	–	–	–	–	–	–	–	–
VBMT 160404E-UR	T8330	0.2	■	115	0.10	1.2	■	65	0.09	1.2	■	105	0.10	1.2	–	–	–	–	–	–	–	–	–	–	
	T8430	0.2	■	140	0.10	1.2	■	75	0.09	1.2	■	115	0.10	1.2	–	–	–	–	–	–	–	–	–	–	
VBMT 160408E-UR	T5315	0.4	■	195	0.12	1.2	■	–	–	–	■	185	0.12	1.2	–	–	–	–	–	–	–	–	–	–	
	T7325	0.4	■	115	0.19	1.2	■	85	0.17	1.2	■	–	–	–	–	–	–	–	–	–	–	–	–	–	
	T8330	0.4	■	115	0.12	1.2	■	65	0.11	1.2	■	105	0.12	1.2	–	–	–	–	–	–	–	–	–	–	
	T8430	0.4	■	140	0.12	1.2	■	75	0.11	1.2	■	115	0.12	1.2	–	–	–	–	–	–	–	–	–	–	–
	T9310	0.4	■	215	0.12	1.2	■	–	–	–	■	200	0.12	1.2	–	–	–	–	–	–	–	–	–	–	–
VBMT 160412E-UR	T9315	0.4	■	190	0.12	1.2	■	–	–	–	■	180	0.12	1.2	–	–	–	–	–	–	–	–	–	–	–
	T9325	0.4	■	145	0.18	1.2	■	85	0.16	1.2	■	135	0.18	1.2	–	–	–	–	–	–	–	–	–	–	–
	TT310	0.4	■	185	0.12	1.2	■	110	0.11	1.2	■	–	–	–	–	–	–	–	–	–	–	–	–	–	–
	T5315	0.8	■	205	0.17	1.2	■	–	–	–	■	190	0.17	1.2	–	–	–	–	–	–	–	–	–	–	–
	T7325	0.8	■	140	0.17	1.2	■	105	0.15	1.2	■	–	–	–	–	–	–	–	–	–	–	–	–	–	–
VBMT 160412E-UR	T8330	0.8	■	125	0.17	1.2	■	75	0.15	1.2	■	115	0.17	1.2	–	–	–	–	–	–	–	–	–	–	–
	T8430	0.8	■	145	0.17	1.2	■	80	0.15	1.2	■	120	0.17	1.2	–	–	–	–	–	–	–	–	–	–	–
	T9310	0.8	■	220	0.17	1.2	■	–	–	–	■	205	0.17	1.2	–	–	–	–	–	–	–	–	–	–	–
	T9315	0.8	■	200	0.17	1.2	■	–	–	–	■	190	0.17	1.2	–	–	–	–	–	–	–	–	–	–	–
	T9325	0.8	■	180	0.17	1.2	■	105	0.15	1.2	■	170	0.17	1.2	–	–	–	–	–	–	–	–	–	–	–
VBMT 160412E-UR	TT310	0.8	■	200	0.17	1.2	■	120	0.15	1.2	■	–	–	–	–	–	–	–	–	–	–	–	–	–	–
	T7325	1.2	■	135	0.22	1.2	■	105	0.20	1.2	■	–	–	–	–	–	–	–	–	–	–	–	–	–	–
	T8330	1.2	■	120	0.22	1.2	■	70	0.20	1.2	■	110	0.22	1.2	–	–	–	–	–	–	–	–	–	–	–
	T8430	1.2	■	135	0.22	1.2	■	75	0.20	1.2	■	110	0.22	1.2	–	–	–	–	–	–	–	–	–	–	–
	T9310	1.2	■	205	0.22	1.2	■	–	–	–	■	190	0.22	1.2	–	–	–	–	–	–	–	–	–	–	–
VBMT 160412E-UR	T9315	1.2	■	185	0.22	1.2	■	–	–	–	■	175	0.22	1.2	–	–	–	–	–	–	–	–	–	–	–
	T9325	1.2	■	170	0.22	1.2	■	100	0.20	1.2	■	160	0.22	1.2	–	–	–	–	–	–	–	–	–	–	–



SVHB(C)(RL) EXT



Ext. Screw Lock Tool Holder with 107.5° Cutting Angle for VB/VC.. Inserts

External Right/Left hand tool holder for screw type positive VB.. 11 or 16 and VC.. 11 or 16 inserts. Suited for external face and longitudinal turning with shoulder, taper, face and longitudinal copy turning up to 35° and chamfer turning. Available with shank size 16x16 up to 25x25 mm. Body treated for longer tool life.

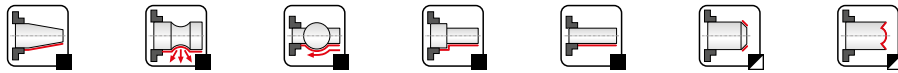
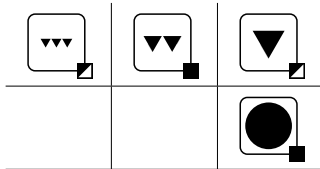
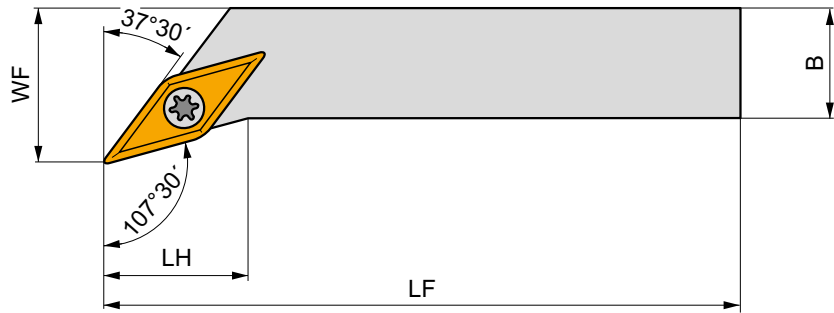
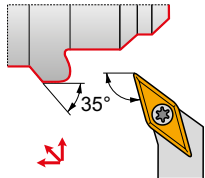

Product	H	B	HF	WF	LF	LH	LAMS	GAMO	kg	GI	SV
	[mm]	[mm]	[mm]	[mm]	[mm]	[mm]	[°]	[°]			
R SVHBR 1616 H 11	16	16	16	20	100	14	0	0	0.21	GI194	S01
SVHCR 2020 K 16-M-A	20	20	20	25	125	20	0	0	0.40	GI017	SV10
SVHCR 2525 M 16-M-A	25	25	25	32	150	20	0	0	0.68	GI017	SV10
L SVHBL 1616 H 11	16	16	16	20	100	14	0	0	0.19	GI194	S01
SVHCL 2020 K 16-M-A	20	20	20	25	125	20	0	0	0.40	GI017	SV10
SVHCL 2525 M 16-M-A	25	25	25	32	150	20	0	0	0.07	GI017	SV10

GI	VB..	VC..
GI017	VB.. 1604..	VC.. 1604..
GI194	VB.. 1103..	VC.. 1103..

SV	US	Nm	M	mm	SVN	MS	FLAG	HXK
S01	US 2506-T07P	0.9	M 2.5	6.3	-	-	FLAG T07P	-
SV10	US 3512-T15P	3.0	M 3.5	12.6	SVN 160304	MS 3510	FLAG T15P	HXK 3.5



SVJB(C)(RL) EXT



External Screw Lock Tool Holder with 93° Cutting Angle for VB/VC.. Inserts

External Right/Left hand tool holder for screw type positive VB.. 11 or 16 and VC.. 11 up to 16 inserts. Suited for external longitudinal turning with shoulder, taper, copy turning up to 50° and chamfer turning. Available with shank size 12x12 up to 32x25 mm. Body treated for longer tool life.

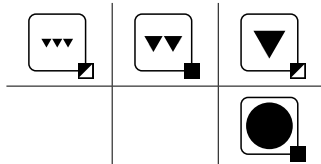
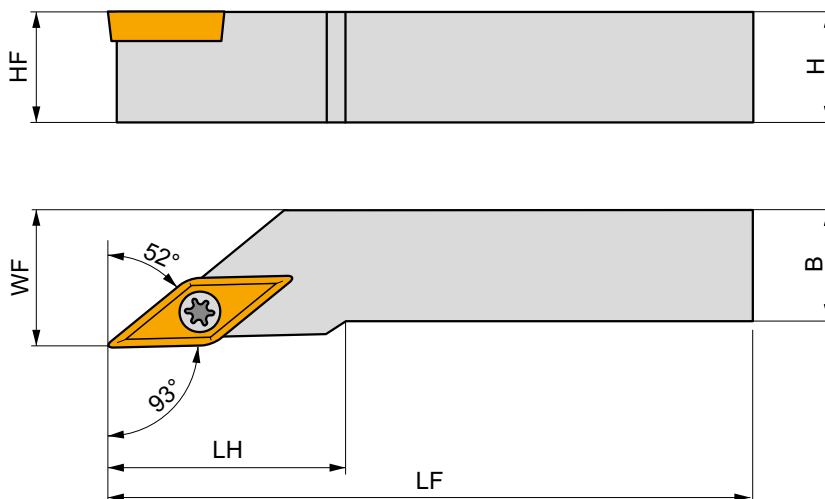
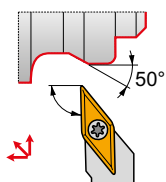

Product	H	B	HF	WF	LF	LH	LAMS	GAMO	kg	G1	S1	
	[mm]	[mm]	[mm]	[mm]	[mm]	[mm]	[°]	[°]				
R	SVJBR 1212 F 11	12	12	12	16	80	20	0	0	0.09	G194	S01
	SVJBR 1616 H 11	16	16	16	20	100	20	0	0	0.20	G194	S01
	SVJCR 1212 N 13	12	12	12	16	160	27	0	0	0.19	G1211	SV21
	SVJCR 1616 H 13	16	16	16	20	100	30	0	0	0.20	G1211	SV21
	SVJCR 2020 K 13	20	20	20	25	125	30	0	0	0.37	G1211	SV22
	SVJCR 2525 M 13	25	25	25	32	150	30	0	0	0.67	G1211	SV22
	SVJCR 2020 K 16-M-A	20	20	20	25	125	28	0	0	0.35	G1017	SV10
	SVJCR 2525 M 16-M-A	25	25	25	32	150	32	0	0	0.68	G1017	SV10
	SVJCR 3225 P 16-M-A	32	25	32	32	170	32	0	0	0.99	G1017	SV10
L	SVJBL 1212 F 11	12	12	12	16	80	20	0	0	0.09	G194	S01
	SVJBL 1616 H 11	16	16	16	20	100	20	0	0	0.19	G194	S01
	SVJCL 1212 N 13	12	12	12	16	160	27	0	0	0.19	G1211	SV21
	SVJCL 1616 H 13	16	16	16	20	100	30	0	0	0.20	G1211	SV21
	SVJCL 2020 K 13	20	20	20	25	125	30	0	0	0.37	G1211	SV22
	SVJCL 2525 M 13	25	25	25	32	150	30	0	0	0.67	G1211	SV22
	SVJCL 2020 K 16-M-A	20	20	20	25	125	28	0	0	0.40	G1017	SV10
	SVJCL 2525 M 16-M-A	25	25	25	32	150	32	0	0	0.70	G1017	SV10
	SVJCL 3225 P 16-M-A	32	25	32	32	170	32	0	0	0.99	G1017	SV10



G1017
G194
G1211

VB.. 1604..
VB.. 1103..
-

VC.. 1604..
VC.. 1103..
VC.. 1303..



S01
SV10
SV21
SV22

US 2506-T07P
US 3512-T15P
5513 020-24
DVF 0573

0.9
3.0
1.5
1.5

M 2.5
M 3.5
M 3
M 3

6.3
12.6
8.5
10.3

-
SVN 160304
-
DAP 0331

-
MS 3510
-
DVT 0332

FLAG T07P
FLAG T15P
PT-8002
PT-8002

-
HXK 3.5
-
174.1-870



SVPB(C)(RL) EXT

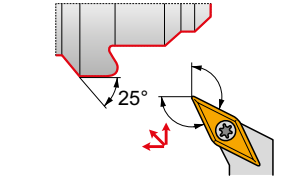
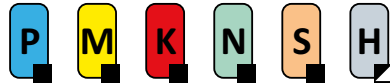

External Screw Lock Tool Holder, 117.5° Cutting Angle for VB/VC.. Inserts

External Right/Left hand tool holder for screw type positive VB.. 11 or 16 and VC.. 11 or 16 inserts. Suited for external face and longitudinal turning with shoulder, taper, face copy turning up to 25° and chamfer turning. Available with shank size 16x16 up to 32x25 mm. Body treated for longer tool life.

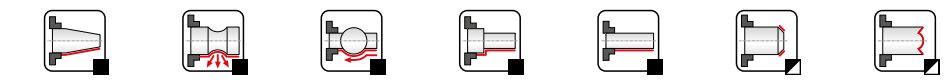
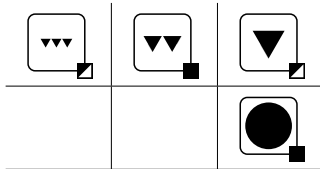
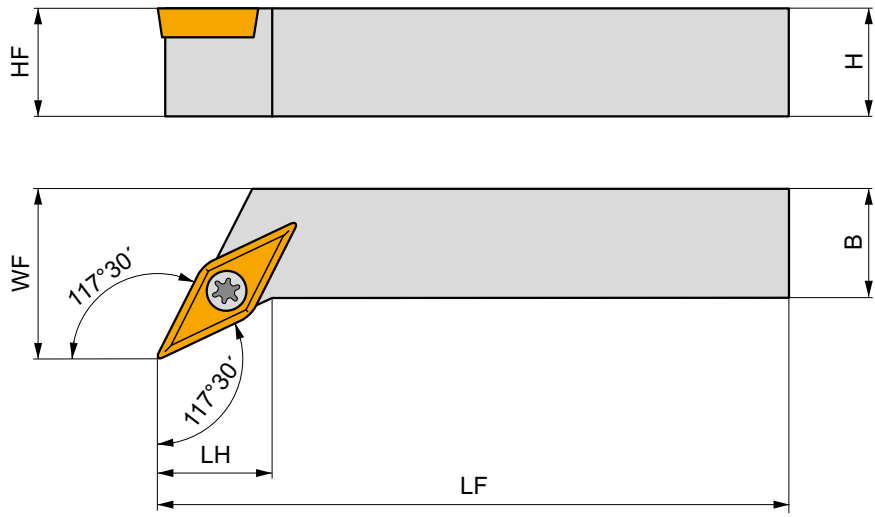

Product	H	B	HF	WF	LF	LH	LAMS	GAMO	kg	GI	SV	
	[mm]	[mm]	[mm]	[mm]	[mm]	[mm]	[°]	[°]				
R	SVPBR 1616 H 11	16	16	16	20	100	12	0	0	0.20	GI194	S01
	SVPBR 2020 K 11	20	20	20	25	125	12	0	0	0.41	GI194	S01
	SVPCR 2020 K 16-M-A	20	20	20	25	125	20	0	0	0.40	GI017	SV10
	SVPCR 2525 M 16-M-A	25	25	25	32	150	25	0	0	0.75	GI017	SV10
L	SVPBL 1616 H 11	16	16	16	20	100	12	0	0	0.20	GI194	S01
	SVPBL 2020 K 11	20	20	20	25	125	12	0	0	0.39	GI194	S01
	SVPCL 2020 K 16-M-A	20	20	20	25	125	20	0	0	0.70	GI017	SV10
	SVPCL 2525 M 16-M-A	25	25	25	32	150	25	0	0	0.70	GI017	SV10
	SVPCL 3225 P 16-M-A	32	25	32	32	170	25	0	0	1.10	GI017	SV10

GI	VB..	VC..
GI017	VB.. 1604..	VC.. 1604..
GI194	VB.. 1103..	VC.. 1103..

SV	US	Nm	M	mm	mm	mm	mm	mm	mm
S01	US 2506-T07P	0.9	M 2.5	6.3	-	-	FLAG T07P	-	-
SV10	US 3512-T15P	3.0	M 3.5	12.6	SVN 160304	MS 3510	FLAG T15P	-	HXK 3.5



SVVB(C)N EXT



External Screw Lock Tool Holder, 72.5° Cutting Angle for VB/VC.. Inserts

External neutral tool holder for screw type positive VB.. 11 or 16 and VC.. 11 up to 16 inserts. Suited for external longitudinal turning without shoulder, taper, copy turning up to 72.5° and chamfer turning. Available with shank size 12x12 up to 32x25 mm. Body treated for longer tool life.

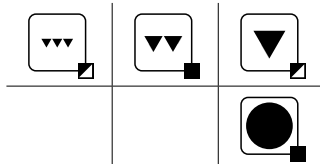
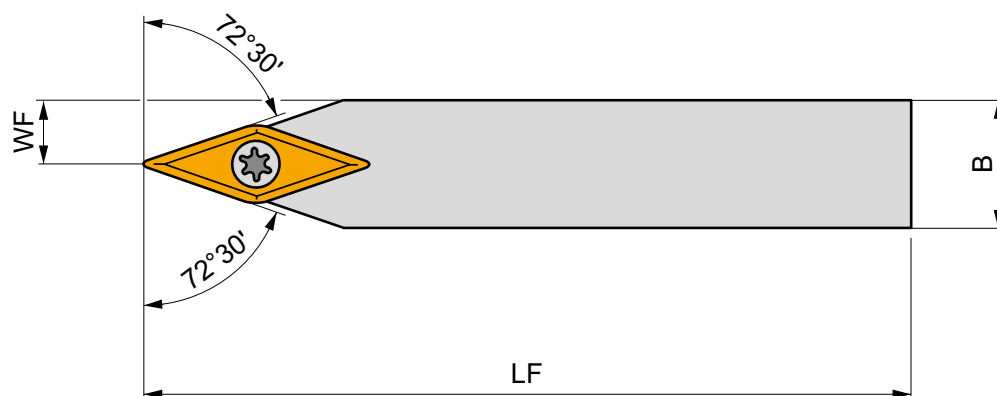
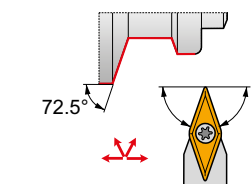

Product	H	B	HF	WF	LF	LH	LAMS	GAMO	kg	G1	S1
	[mm]	[mm]	[mm]	[mm]	[mm]	[mm]	[°]	[°]			
N	SVVBN 1212 F 11	12	12	12	6	80	-	0	0.11	G194	S01
	SVVBN 1616 H 11	16	16	16	8	100	-	0	0.18	G194	S01
	SVVBN 2020 K 11	20	20	20	10	125	-	0	0.38	G194	S01
	SVVCN 1212 N 13	12	12	12	6	160	-	0	0.19	G1211	SV21
	SVVCN 1616 H 13	16	16	16	8	100	-	0	0.20	G1211	SV21
	SVVCN 2020 K 13	20	20	20	10	125	-	0	0.36	G1211	SV22
	SVVCN 2525 M 13	25	25	25	12.5	150	-	0	0.66	G1211	SV22
	SVVCN 2020 K 16-M-A	20	20	20	10	125	-	0	0.34	G1017	SV10
	SVVCN 2525 M 16-M-A	25	25	25	12.5	150	-	0	0.68	G1017	SV10
	SVVCN 3225 P 16-M-A	32	25	32	12.5	170	-	0	0.98	G1017	SV10



G1017

VB.. 1604..

VC.. 1604..

G1194

VB.. 1103..

VC.. 1103..

G1211

-

VC.. 1303..



S01

US 2506-T07P

0.9

M 2.5

6.3

-

-

FLAG T07P

-

SV10

US 3512-T15P

3.0

M 3.5

12.6

SVN 160304

MS 3510

FLAG T15P

HXK 3.5

SV21

5513 020-24

1.5

M 3

8.5

-

-

PT-8002

-

SV22

DVF 0573

1.5

M 3

10.3

DAP 0331

DVT 0332

PT-8002

174.1-870



SVXB(C)(RL) EXT

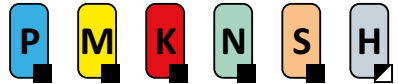

External Screw Lock Tool Holder 98/113° Cutting Angle for VB/VC.. Inserts

External Right/Left hand tool holder for screw type positive VB.. 11 or 16 and VC.. 11 up to 16 inserts. Suited for external longitudinal turning with shoulder, taper, copy turning up to 30° and chamfer turning. Available with shank size 12x12 up to 32x25 mm. Body treated for longer tool life.

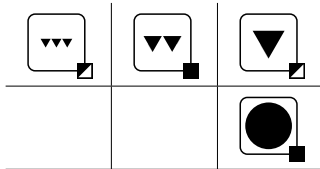
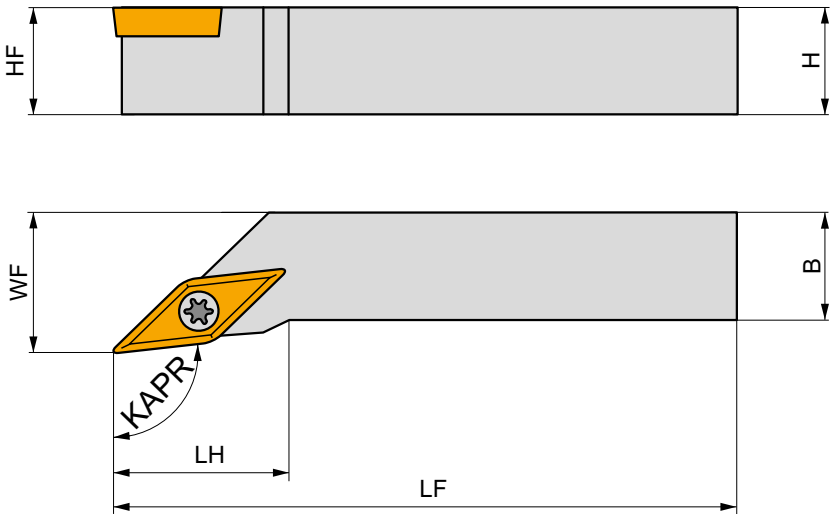
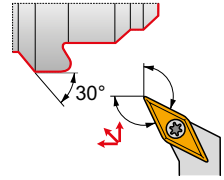

Product	H	B	HF	WF	LF	LH	KAPR	LAMS	GAMO	kg	GI	SV
	[mm]	[mm]	[mm]	[mm]	[mm]	[mm]	[°]	[°]	[°]			
R	SVXBR 1212 F 11	12	12	12	16	80	20	98	0	0	0.09	GI194 S01
	SVXBR 1616 H 11	16	16	16	20	100	14	98	0	0	0.19	GI194 S01
	SVXCR 2020 K 13	20	20	20	25	125	12	113	0	0	0.38	GI211 SV22
	SVXCR 2020 K 16-M-A	20	20	20	25	125	28	98	0	0	0.41	GI017 SV10
	SVXCR 2525 M 16-M-A	25	25	25	32	150	32	98	0	0	0.68	GI017 SV10
	SVXCR 3225 P 16-M-A	32	25	32	32	170	32	98	0	0	1.00	GI017 SV10
L	SVXBL 1212 F 11	12	12	12	16	80	20	98	0	0	0.09	GI194 S01
	SVXBL 1616 H 11	16	16	16	20	100	14	98	0	0	0.19	GI194 S01
	SVXCL 2020 K 13	20	20	20	25	125	12	113	0	0	0.38	GI211 SV22
	SVXCL 2020 K 16-M-A	20	20	20	25	125	28	98	0	0	0.38	GI017 SV10
	SVXCL 2525 M 16-M-A	25	25	25	32	150	32	98	0	0	0.69	GI017 SV10
	SVXCL 3225 P 16-M-A	32	25	32	32	170	32	98	0	0	0.99	GI017 SV10

GI	VB..	VC..
GI017	VB.. 1604..	VC.. 1604..
GI194	VB.. 1103..	VC.. 1103..
GI211	-	VC.. 1303..

SV	US	Nm	M	mm	mm	mm	mm	mm	mm
S01	US 2506-T07P	0.9	M 2.5	6.3	-	-	FLAG T07P	-	-
SV10	US 3512-T15P	3.0	M 3.5	12.6	SVN 160304	MS 3510	FLAG T15P	HXK 3.5	-
SV22	DVF 0573	1.5	M 3	10.3	DAP 0331	DVT 0332	PT-8002	174.1-870	-



C.-SVHB(RL) EXT



Ext. PSC Quick Change Tool, Screw Lock, 107.5° Cutting Angle, VB/VC.. Inserts

External Right/Left hand tool, through coolant, for screw type positive VB.. 16 and VC.. 16 inserts. Suited for external longitudinal turning with shoulder, taper, copy turning up to 35° and chamfer turning. Available with PSC (Polygon Shank Coupling) size C4 up to C6. Body treated for longer tool life.

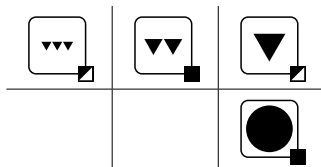
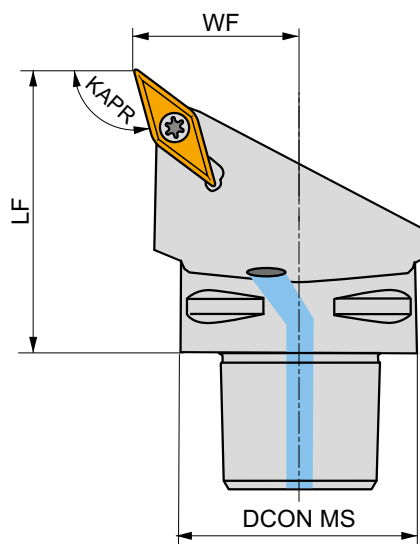
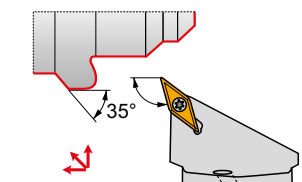

Product	DCON MS	WF	LF	KAPR	LAMS	GAMO				
	[mm]	[mm]	[mm]	[°]	[°]	[°]				
R	C4-SVHBR-27050-16	40	27	50	107.5	0	✓	0.35	GI017	C-SV16S-1
	C5-SVHBR-35060-16	50	35	60	107.5	0	✓	0.64	GI017	C-SV16S-2
	C6-SVHBR-45065-16	63	45	65	107.5	0	✓	1.13	GI017	C-SV16S-2
L	C4-SVHBL-27050-16	40	27	50	107.5	0	✓	0.35	GI017	C-SV16S-1
	C5-SVHBL-35060-16	50	35	60	107.5	0	✓	0.64	GI017	C-SV16S-2
	C6-SVHBL-45065-16	63	45	65	107.5	0	✓	1.12	GI017	C-SV16S-2



GI017



VB.. 1604..



VC.. 1604..



C-SV16S-1

US 2001-T15P

3.0

M 3.5

12.1

SVS 270-01

MS 9001

FLAGT15P/3,5

CN 034-01

C-SV16S-2

US 2001-T15P

3.0

M 3.5

12.1

SVS 270-01

MS 9001

FLAGT15P/3,5

CN 034-02



C.-SVJB(RL) EXT

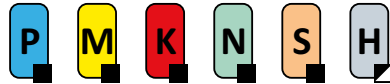

Ext. PSC Quick Change Tool, Screw Lock, 93° Cutting Angle for VB/VC.. Inserts

External Right/Left hand tool, through coolant, for screw type positive VB.. 11 or 16 and VC.. 11 up to 16 inserts. Suited for external longitudinal turning with shoulder, taper, copy turning up to 50° and chamfer turning. Available with PSC (Polygon Shank Coupling) size C3 up to C6. Body treated for longer tool life.

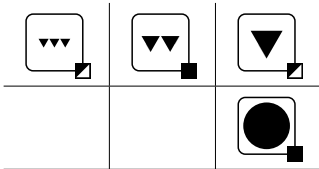
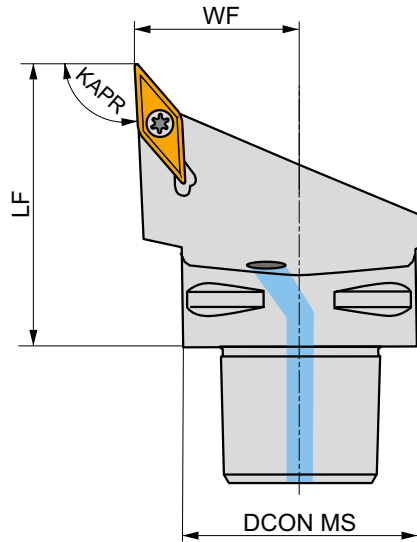
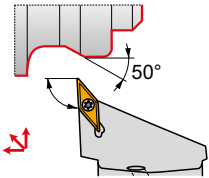

Product	DCON MS	WF	LF	KAPR	LAMS	GAMO		kg		
	[mm]	[mm]	[mm]	[°]	[°]	[°]				
R	C3-SVJBR-22040-11-B1	32	22	40	93	0	✓	0.17	GI194	C-SV11
	C4-SVJBR-27050-11-B1	40	27	50	93	0	✓	0.34	GI194	C-SV11
	C4-SVJBR-27050-16	40	27	50	93	0	✓	0.35	GI017	C-SV16S-1
	C5-SVJBR-35060-16	50	35	60	93	0	✓	0.63	GI017	C-SV16S-2
	C6-SVJBR-45065-16	63	45	65	93	0	✓	1.11	GI017	C-SV16S-2
L	C4-SVJBL-27050-16	40	27	50	93	0	✓	0.35	GI017	C-SV16S-1
	C5-SVJBL-35060-16	50	35	60	93	0	✓	0.64	GI017	C-SV16S-2
	C6-SVJBL-45065-16	63	45	65	93	0	✓	1.11	GI017	C-SV16S-2

GI017	VB.. 1604..	VC.. 1604..
GI194	VB.. 1103..	VC.. 1103..

C-SV11	US 2003-T07P	0.8	M 2.5	6.5	-	-	FLAG T07P	CN 034-01
C-SV16S-1	US 2001-T15P	3.0	M 3.5	12.1	SVS 270-01	MS 9001	FLAG T15P/3,5	CN 034-01
C-SV16S-2	US 2001-T15P	3.0	M 3.5	12.1	SVS 270-01	MS 9001	FLAG T15P/3,5	CN 034-02



C.-SVVBN EXT



Ext. PSC Quick Change Tool, Screw Lock, 72.5° Cutting Angle, VB/VC.. Inserts

External neutral tool, through coolant, for screw type positive VB.. 16 and VC.. 16 inserts. Suited for external longitudinal turning without shoulder, taper, copy turning up to 72.5° and chamfer turning. Available with PSC (Polygon Shank Coupling) size C4 up to C6. Body treated for longer tool life.

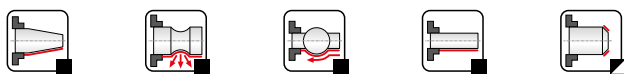
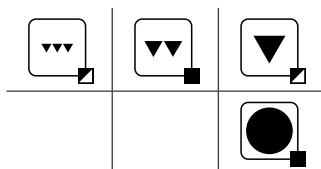
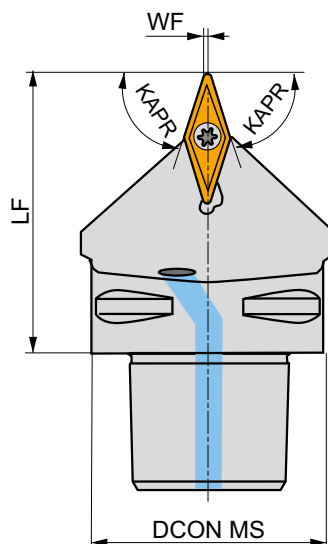
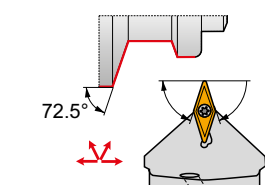

Product	DCON MS	WF	LF	KAPR	LAMS	GAMO		kg		
N C4-SVVBN-00050-16	40	0.6	50	72.5	0	0	✓	0.32	GI017	C-SV16S-1
C5-SVVBN-00060-16	50	0.6	60	72.5	0	0	✓	0.56	GI017	C-SV16S-2
C6-SVVBN-00065-16	63	0.6	65	72.5	0	0	✓	0.99	GI017	C-SV16S-2

GI017	VB.. 1604..	VC.. 1604..

C-SV16S-1	US 2001-T15P	3.0	M 3.5	12.1	SVS 270-01	MS 9001	FLAG T15P/3,5	CN 034-01
C-SV16S-2	US 2001-T15P	3.0	M 3.5	12.1	SVS 270-01	MS 9001	FLAG T15P/3,5	CN 034-02



SVJB(RL) INT

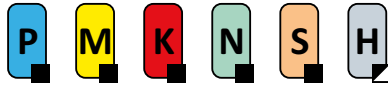

PRAMET

S



Internal Screw Lock Boring Bar with 93° Cutting Angle for VB/VC.. Inserts

Internal Right/Left hand boring bar, through coolant, with 93° cutting angle for screw type VB.. 11 and VC.. 11 inserts. Minimum internal turning diameter Ø25 mm. Suited for face copy turning under 50°. Available with shank size Ø20 and Ø25 mm. Body treated for longer tool life.

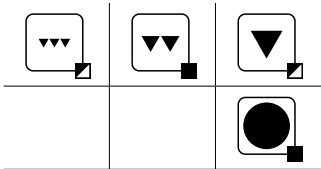
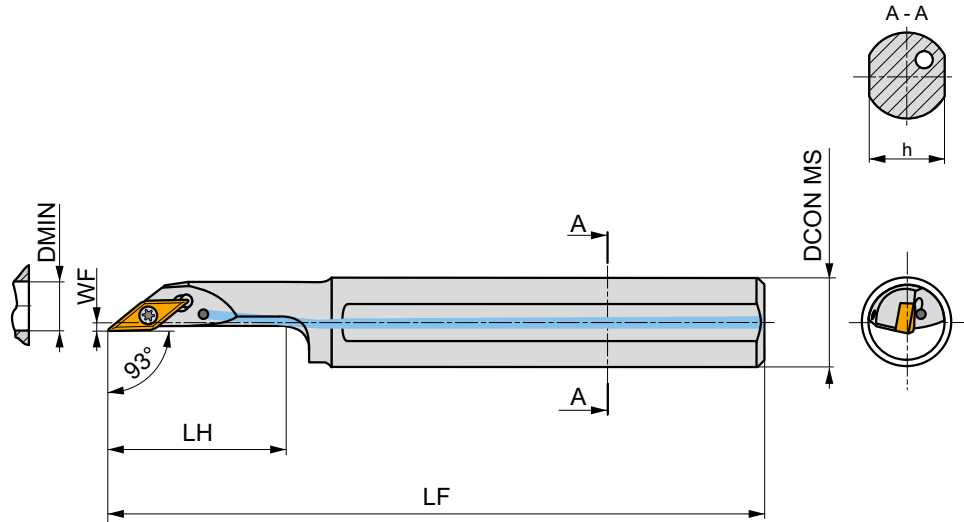
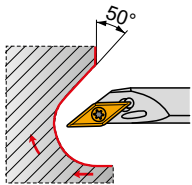

Product	DCON MS	DMIN	WF	H	LF	LH	LAMS	GAMO	✓	kg	G1194	S07
	[mm]	[mm]	[mm]	[mm]	[mm]	[mm]	[°]	[°]				
R A20R-SVJBR 11	20	25	2	18	200	40	-5	-5	✓	0.44	G1194	S07
	A25S-SVJBR 11	25	32	3.5	23	250	50	-5	-5	✓	0.82	G1194
L A20R-SVJBL 11	20	25	2	18	200	40	-5	-5	✓	0.42	G1194	S07
	A25S-SVJBL 11	25	32	3.5	23	250	50	-5	-5	✓	0.82	G1194

G1194	VB.. 1103..	VC.. 1103..

S07	US 2506-T07P	0.9	M 2.5	6.3	FLAG T07P



SVQB(C)(RL) INT



PRAMET

S

Internal Screw Lock Boring Bar with 107.5° Cutting Angle for VB/VC.. Inserts

Internal Right/Left hand boring bar, through coolant available, with 107.5° cutting angle for screw type VB../VC.. 11 and 16 inserts. Minimum internal turning diameter Ø20 mm. Suited for a wide range of internal turning operations. Available with shank size Ø16 up to Ø40 mm.

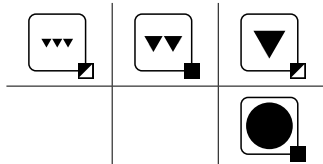
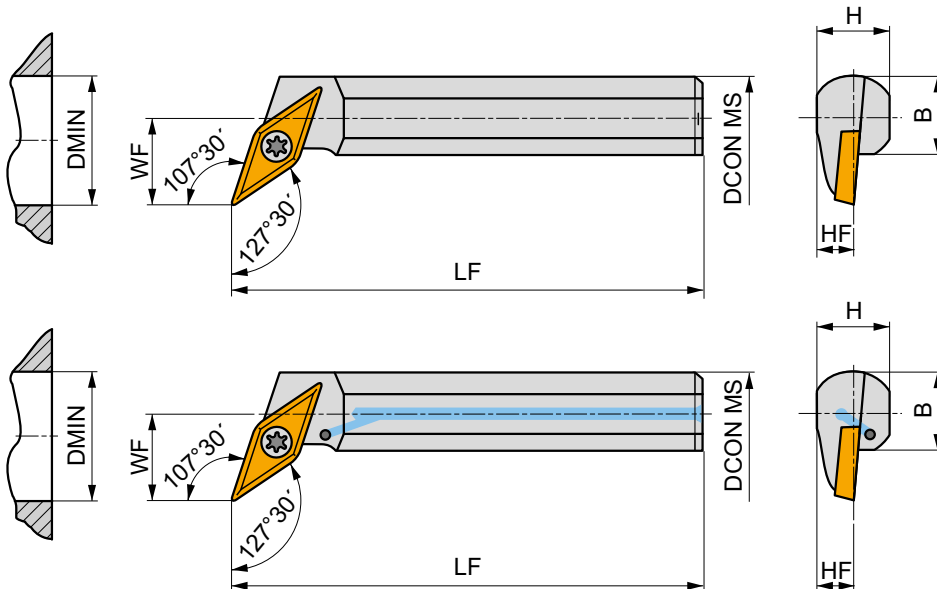
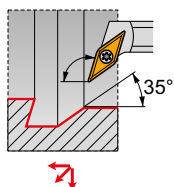

Product	DCON MS	DMIN	WF	H	B	LF	LAMS	GAMO					
	[mm]	[mm]	[mm]	[mm]	[mm]	[mm]	[°]	[°]					
R	A16R-SVQBR 11	16	20	11	14.5	15	200	-5	0	✓	0.33	GI194	S01
	A20S-SVQBR 11	20	25	13	18	18.5	250	-4	0	✓	0.58	GI194	S01
	A16R-SVQCR 13	16	21	11	15	15	200	-6	0	✓	0.30	GI211	SV21
	A20S-SVQCR 13	20	25	13	18	18.5	250	-4	0	✓	0.12	GI211	SV21
	S25T-SVQCR 16	25	32	17	23	23	300	-7	0	-	1.10	GI017	S08
	S32U-SVQCR 16	32	40	22	30	30	350	-5	0	-	2.07	GI017	S08
S40V-SVQCR 16-A	40	50	27	38	38	400	-5	0	-	3.80	GI017	SV10	
L	A16R-SVQBL 11	16	20	11	14.5	15	200	-5	0	✓	0.33	GI194	S01
	A20S-SVQBL 11	20	25	13	18	18.5	250	-4	0	✓	0.58	GI194	S01
	A16R-SVQCL 13	16	21	11	15	15	200	-6	0	✓	0.29	GI211	SV21
	A20S-SVQCL 13	20	25	13	18	18.5	250	-4	0	✓	0.54	GI211	SV21
	S25T-SVQCL 16	25	32	17	23	23	300	-7	0	-	1.09	GI017	S08
	S32U-SVQCL 16	32	40	22	30	30	350	-5	0	-	2.07	GI017	S08
S40V-SVQCL 16-A	40	50	27	38	38	400	-5	0	-	4.10	GI017	SV10	

GI017	VB.. 1604..	VC.. 1604..
GI194	VB.. 1103..	VC.. 1103..
GI211	-	VC.. 1303..

S01	US 2506-T07P	0.9	M 2.5	6.3	-	-	FLAGT07P	-
S08	US 3510-T15P	3.0	M 3.5	10.6	-	-	FLAGT15P	-
SV10	US 3512-T15P	3.0	M 3.5	12.6	SVN 160304	MS 3510	FLAGT15P	HXK 3.5
SV21	5513 020-24	1.5	M 3	8.5	-	-	PT-8002	-



SVUB(C)(RL) INT



PRAMET

S



Internal Screw Lock Boring Bar with 93° Cutting Angle for VB/VC.. Inserts

Internal Right/Left hand boring bar, through coolant available, with 93° cutting angle for screw type VB../VC.. 11 and 16 inserts. Minimum internal turning diameter Ø20 mm. For a wide range of internal turning operations and copying under 50°. Ø16 up to Ø40 mm shanks available. Body treated for longer tool life.

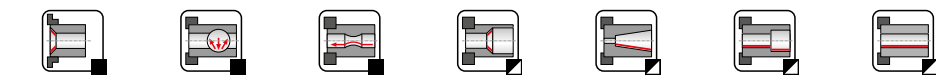
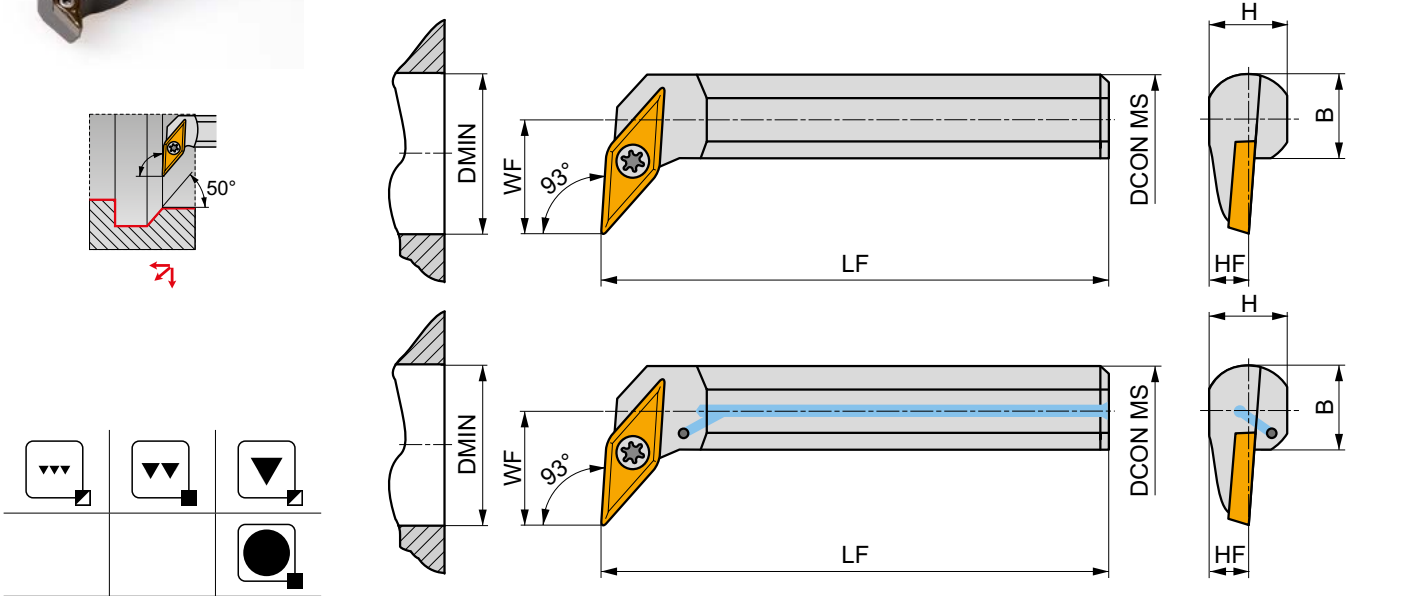

Product	DCON MS	DMIN	WF	H	B	LF	LAMS	GAMO	Hand	kg	G1	S0
	[mm]	[mm]	[mm]	[mm]	[mm]	[mm]	[°]	[°]				
R A16R-SVUBR 11	16	20	11	14.5	15	200	-5	0	✓	0.34	GI194	S01
A20S-SVUBR 11	20	25	13	18	18.8	250	-4	0	✓	0.58	GI194	S01
A20S-SVUCR 13	20	25	13	19	18.5	250	-4	2	✓	0.40	GI211	SV21
A25T-SVUCR 13	25	32	17	24	23	300	-2	2	✓	0.96	GI211	SV22
A32T-SVUCR 13	32	40	22	30	30	300	-1	2	✓	1.70	GI211	SV22
S25T-SVUCR 16	25	32	17	23	23	300	-7	0	-	1.10	GI017	S08
S32U-SVUCR 16	32	40	22	30	30	350	-5	0	-	2.10	GI017	S08
S40V-SVUCR 16-A	40	50	27	38	38	400	-5	0	-	4.10	GI017	SV10
L A16R-SVUBL 11	16	20	11	14.5	15	200	-5	0	✓	0.34	GI194	S01
A20S-SVUBL 11	20	25	13	18	18.5	250	-4	0	✓	0.58	GI194	S01
A20S-SVUCL 13	20	25	13	19	18.5	250	-4	2	✓	0.32	GI211	SV21
A25T-SVUCL 13	25	32	17	24	23	300	-2	2	✓	0.96	GI211	SV22
A32T-SVUCL 13	32	40	22	30	30	300	-1	2	✓	1.70	GI211	SV22
S25T-SVUCL 16	25	32	17	23	23	300	-7	0	-	1.10	GI017	S08
S32U-SVUCL 16	32	40	22	30	30	350	-5	0	-	2.10	GI017	S08
S40V-SVUCL 16-A	40	50	27	38	38	400	-5	0	-	4.10	GI017	SV10

Product	Insert	Material
GI017	VB.. 1604..	VC.. 1604..
GI194	VB.. 1103..	VC.. 1103..
GI211	-	VC.. 1303..

Product	Tool	Torque (Nm)	Thread	Length	Part	Part	Part	Part
S01	US 2506-T07P	0.9	M 2.5	6.3	-	-	FLAG T07P	-
S08	US 3510-T15P	3.0	M 3.5	10.6	-	-	FLAG T15P	-
SV10	US 3512-T15P	3.0	M 3.5	12.6	SVN 160304	MS 3510	FLAG T15P	HXX 3.5
SV21	5513 020-24	1.5	M 3	8.5	-	-	PT-8002	-
SV22	DVF 0573	1.5	M 3	10.3	DAP 0331	DVT 0332	PT-8002	174.1-870



C.-SVQB(RL) INT



Int. PSC Quick Change Tool, Screw Lock, 107.5° Cutting Angle, VB/VC.. Inserts

Internal Right/Left hand tool, through coolant, with 107.5° cutting angle for screw type VB.. 16 or VC.. 16 inserts. Minimum internal turning diameter Ø33 mm. Suited for a wide range of internal turning operations. PSC shank (Polygon Shank Coupling) size C4 and C5 with choice of lengths. Body treated for longer tool life.

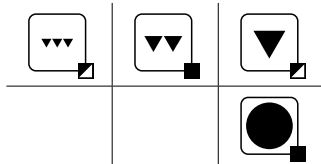
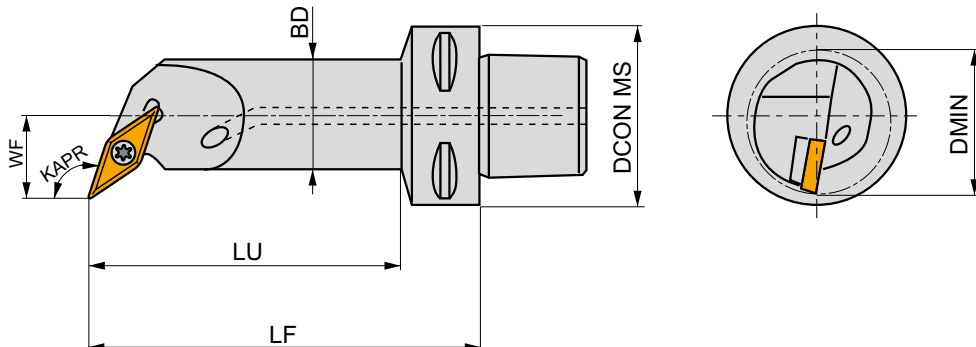
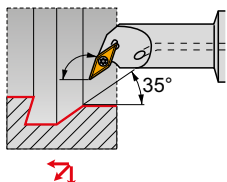

Product	DCON MS	DMIN	WF	LF	LU	BD	KAPR	LAMS	GAMO				
	[mm]	[mm]	[mm]	[mm]	[mm]	[mm]	[°]	[°]	[°]				
R C4-SVQBR-18090-16	40	33	18	90	68	25	107.5	-7.2	0	✓	0.48	GI017	SV16
	C5-SVQBR-18090-16	50	33	18	90	67	25	107.5	-7.2	0	✓	0.67	GI017
L C4-SVQBL-18090-16	40	33	18	90	68	25	107.5	-7.2	0	✓	0.48	GI017	SV16
	C5-SVQBL-18090-16	50	33	18	90	67	25	107.5	-7.2	0	✓	0.68	GI017



GI017



VB.. 1604..



VC.. 1604..



SV16



US 2010-T15P



3.0



M 3.5



10.1



FLAG T15P/3,5



VC

07/ 11/ 13/ 16

CARBIDE INSERTS

VC GT	VC GW	VC GX	VC MT	VC MW
186	189	189	190	191

PCD INSERTS

VCMW PCD
192

MATCH THE RIGHT SIZE (example)

Insert	Tool Holder
VC GT 070204E-FF2	SVGCR 1010 M 07

ISO TURNING – EXTERNAL

SVAC(RL)-DC EXT	SVGC(RL) EXT	SVHB(C)(RL) EXT	SVJB(C)(RL) EXT
<p>90°</p> <p>VC..</p> <p>13</p> <p>10×10 25×25</p> <p> 193</p>	<p>90°</p> <p>VC..</p> <p>07</p> <p>08×08 16×16</p> <p> 194</p>	<p>107°30'</p> <p>VB, VC..</p> <p>11 16</p> <p>16×16 25×25</p> <p> 195</p>	<p>93°</p> <p>VB, VC..</p> <p>11 13 16</p> <p>12×12 32×25</p> <p> 196</p>
SVJC(RL)-DC EXT	SVPB(C)(RL) EXT	SVVB(C)N EXT	SVXB(C)(RL) EXT
<p>93°</p> <p>VC..</p> <p>13</p> <p>10×10 25×25</p> <p> 197</p>	<p>117°30'</p> <p>VB, VC..</p> <p>11 16</p> <p>16×16 32×25</p> <p> 198</p>	<p>72°30'</p> <p>VB, VC..</p> <p>11 13 16</p> <p>12×12 32×25</p> <p> 199</p>	<p>98°</p> <p>VB, VC..</p> <p>11 13 16</p> <p>12×12 32×25</p> <p> 200</p>



VC

07/ 11/ 13/ 16

C.-SVHB(RL) EXT	
107°30'	VB, VC..
	 16
	$\frac{C4}{C6}$
 201	168 – 171 186 – 192

C.-SVJB(RL) EXT	
93°	VB, VC..
	 11 16
	$\frac{C3}{C6}$
 202	168 – 171 186 – 192

C.-SVVBN EXT	
72°30'	VB, VC..
	 16
	$\frac{C4}{C6}$
 203	168 – 171 186 – 192

ISO TURNING – INTERNAL

SVJB(RL) INT	
93°	VB, VC..
	 11
	$\frac{25}{32}$
 204	168 – 171 186 – 192

SVLC(RL) INT	
95°	VC..
	 13
	$\frac{27}{43}$
 205	186 – 192

SVQB(C)(RL) INT	
107°30'	VB, VC..
	 11 13 16
	$\frac{20}{50}$
 206	168 – 171 186 – 192

SVUB(C)(RL) INT	
93°	VB, VC..
	 11 13 16
	$\frac{20}{50}$
 207	168 – 171 186 – 192

SVXC(RL) INT	
113°	VC..
	 07
	$\frac{12,5}{17,5}$
 208	186 – 192

SVXC(RL)-E INT	
113°	VC..
	 07
	$\frac{12,5}{17,5}$
 209	186 – 192

C.-SVQB(C)(RL) INT	
108°	VB, VC..
	 16
	33
 210	168 – 171 186 – 192



VCGT



	IC	D1	L	S
	[mm]	[mm]	[mm]	[mm]
0702	3.970	2.20	6.90	2.38
1102-SF3	6.350	2.80	11.10	2.58
1103	6.350	2.80	11.10	3.18
1103-SF3	6.350	2.80	11.10	3.43
1303	7.940	3.40	13.80	3.18
1303-AL	7.940	3.40	13.80	3.43
1303-SF3	7.940	3.40	13.80	3.43
1604	9.525	4.40	16.60	4.76
1604-SF3	9.525	4.40	16.60	5.01

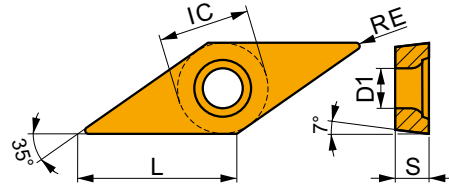

Suitability and starting values for cutting speed (vc), feed (f) and depth of cut (ap). Refer to our Machining Calculator app for further calculations.

Product	RE	P			M			K			N			S			H		
		vc	f	ap	vc	f	ap	vc	f	ap	vc	f	ap	vc	f	ap	vc	f	ap
	[mm]	[m/min]	[mm/rev]	[mm]	[m/min]	[mm/rev]	[mm]	[m/min]	[mm/rev]	[mm]	[m/min]	[mm/rev]	[mm]	[m/min]	[mm/rev]	[mm]	[m/min]	[mm/rev]	[mm]



AL geometry with highly positive design for fine-finish to rough machining, and continuous to slightly interrupted cuts.

VCGT 070202F-AL	HF7	0.2	-	-	-	-	-	-	■	315	0.12	1.0	-	-	-	-	-	-
VCGT 110302F-AL	HF7	0.2	-	-	-	-	-	-	■	300	0.12	1.5	-	-	-	-	-	-
	T0315	0.2	-	-	-	-	-	-	■	465	0.12	0.8	-	-	-	-	-	-
VCGT 110304F-AL	HF7	0.4	-	-	-	-	-	-	■	240	0.24	1.5	-	-	-	-	-	-
	T0315	0.4	-	-	-	-	-	-	■	375	0.24	0.8	-	-	-	-	-	-
VCGT 130302F-AL	HF7	0.2	-	-	-	-	-	-	■	285	0.12	1.7	-	-	-	-	-	-
	T0315	0.2	-	-	-	-	-	-	■	420	0.12	1.7	-	-	-	-	-	-
VCGT 130304F-AL	HF7	0.4	-	-	-	-	-	-	■	240	0.24	1.7	-	-	-	-	-	-
	T0315	0.4	-	-	-	-	-	-	■	345	0.24	1.7	-	-	-	-	-	-
VCGT 130308F-AL	HF7	0.8	-	-	-	-	-	-	■	210	0.48	1.7	-	-	-	-	-	-
	T0315	0.8	-	-	-	-	-	-	■	315	0.48	1.7	-	-	-	-	-	-
VCGT 160402F-AL	HF7	0.2	-	-	-	-	-	-	■	285	0.12	2.4	-	-	-	-	-	-
	T0315	0.2	-	-	-	-	-	-	■	420	0.12	2.4	-	-	-	-	-	-
VCGT 160404F-AL	HF7	0.4	-	-	-	-	-	-	■	225	0.24	2.4	-	-	-	-	-	-
	T0315	0.4	-	-	-	-	-	-	■	330	0.24	2.4	-	-	-	-	-	-
VCGT 160408F-AL	HF7	0.8	-	-	-	-	-	-	■	210	0.48	2.4	-	-	-	-	-	-
	T0315	0.8	-	-	-	-	-	-	■	300	0.48	2.4	-	-	-	-	-	-
VCGT 160412F-AL	HF7	1.2	-	-	-	-	-	-	■	180	0.72	2.4	-	-	-	-	-	-
	T0315	1.2	-	-	-	-	-	-	■	270	0.72	2.4	-	-	-	-	-	-

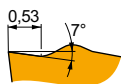

FF2 geometry with positive design for fine-finish to finish machining, and continuous to slightly interrupted cuts.

VCGT 070202E-FF2	T8315	0.2	■	150	0.05	0.8	-	-	-	■	140	0.05	0.8	-	-	-	-	-
	T8330	0.2	■	145	0.05	0.8	-	-	-	■	135	0.05	0.8	-	-	-	-	-
	T8430	0.2	■	190	0.05	0.8	-	-	-	■	155	0.05	0.8	-	-	-	-	-
VCGT 070204E-FF2	T8315	0.4	■	125	0.12	0.8	-	-	-	■	115	0.12	0.8	-	-	-	-	-
	T8330	0.4	■	120	0.12	0.8	-	-	-	■	110	0.12	0.8	-	-	-	-	-
	T8430	0.4	■	145	0.12	0.8	-	-	-	■	120	0.12	0.8	-	-	-	-	-
VCGT 130302E-FF2	T5315	0.2	■	250	0.05	1.0	-	-	-	■	235	0.05	1.0	-	-	-	-	-
	T7325	0.2	■	165	0.05	1.0	-	-	-	-	-	-	-	-	-	-	-	-
	T8330	0.2	■	140	0.05	1.0	-	-	-	■	130	0.05	1.0	-	-	-	-	-
	T8430	0.2	■	185	0.05	1.0	-	-	-	■	150	0.05	1.0	-	-	-	-	-
	T9315	0.2	■	265	0.05	1.0	-	-	-	■	250	0.05	1.0	-	-	-	-	-
	T9325	0.2	■	240	0.05	1.0	-	-	-	■	225	0.05	1.0	-	-	-	-	-
	TT010	0.2	■	240	0.05	0.5	-	-	-	-	-	-	-	-	-	-	-	-



Suitability and starting values for cutting speed (vc), feed (f) and depth of cut (ap). Refer to our Machining Calculator app for further calculations.

Product	RE [mm]	P			M			K			N			S			H		
		vc [m/min]	f [mm/rev]	ap [mm]	vc [m/min]	f [mm/rev]	ap [mm]	vc [m/min]	f [mm/rev]	ap [mm]	vc [m/min]	f [mm/rev]	ap [mm]	vc [m/min]	f [mm/rev]	ap [mm]	vc [m/min]	f [mm/rev]	ap [mm]

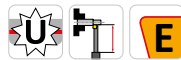
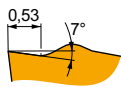

FF2 geometry with positive design for fine-finish to finish machining, and continuous to slightly interrupted cuts.

VCGT 130304E-FF2	T5315	0.4	195	0.12	1.0	-	-	-	185	0.12	1.0	-	-	-	-	-	-	-
	T7325	0.4	135	0.12	1.0	-	-	-	-	-	-	-	-	-	-	-	-	-
	T8330	0.4	115	0.12	1.0	-	-	-	105	0.12	1.0	-	-	-	-	-	-	-
	T8430	0.4	140	0.12	1.0	-	-	-	115	0.12	1.0	-	-	-	-	-	-	-
	T9315	0.4	195	0.12	1.0	-	-	-	185	0.12	1.0	-	-	-	-	-	-	-
	T9325	0.4	175	0.12	1.0	-	-	-	165	0.12	1.0	-	-	-	-	-	-	-
TT010	0.4	245	0.06	0.5	-	-	-	-	-	-	-	-	-	-	-	-	-	-
VCGT 130308E-FF2	T7325	0.8	145	0.17	1.0	-	-	-	-	-	-	-	-	-	-	-	-	-
	T9315	0.8	200	0.17	1.0	-	-	-	190	0.17	1.0	-	-	-	-	-	-	-
	T9325	0.8	180	0.17	1.0	-	-	-	170	0.17	1.0	-	-	-	-	-	-	-
	TT010	0.8	245	0.10	0.8	-	-	-	-	-	-	-	-	-	-	-	-	-

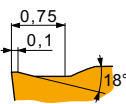

FM2 geometry for finish to medium machining, and continuous to interrupted cuts.

VCGT 130308E-FM2	T8330	0.8	125	0.17	1.0	75	0.15	1.0	115	0.17	1.0	-	-	-	-	-	-
	T8430	0.8	145	0.17	1.0	80	0.15	1.0	120	0.17	1.0	-	-	-	-	-	-
	T9325	0.8	180	0.17	1.0	105	0.15	1.0	170	0.17	1.0	-	-	-	-	-	-



NF2 geometry with positive design for fine-finish to semi-rough machining, and continuous cuts.

VCGT 130302E-NF2	H07	0.2	-	-	-	60	0.09	1.0	95	0.10	1.0	310	0.12	1.0	30	0.07	0.8	-	-	-	
	T6310	0.2	125	0.07	1.0	90	0.06	1.0	100	0.07	1.0	375	0.08	1.0	35	0.06	0.8	-	-	-	
	T7325	0.2	150	0.07	1.0	115	0.06	1.0	-	-	-	-	-	-	45	0.06	0.8	-	-	-	
	T7335	0.2	150	0.07	1.0	115	0.06	1.0	-	-	-	-	-	-	45	0.06	0.8	-	-	-	
	T9315	0.2	200	0.10	1.0	-	-	-	190	0.10	1.0	-	-	-	-	-	-	-	-	-	
	T9325	0.2	210	0.07	1.0	125	0.06	1.0	195	0.07	1.0	-	-	-	45	0.06	0.8	-	-	-	
	T9335	0.2	155	0.10	1.0	90	0.09	1.0	-	-	-	-	-	-	30	0.07	0.8	-	-	-	
	TT010	0.2	240	0.05	0.5	140	0.05	0.5	-	-	-	-	-	-	-	-	-	-	-	-	
	VCGT 130304E-NF2	H07	0.4	-	-	-	60	0.11	1.0	95	0.12	1.0	310	0.14	1.0	30	0.11	0.8	-	-	-
		T5315	0.4	195	0.12	1.0	-	-	-	185	0.12	1.0	-	-	-	-	-	-	-	-	-
T6310		0.4	115	0.12	1.0	80	0.11	1.0	90	0.12	1.0	345	0.14	1.0	30	0.11	0.8	-	-	-	
T7325		0.4	135	0.12	1.0	105	0.11	1.0	-	-	-	-	-	-	40	0.08	0.8	-	-	-	
T7335		0.4	135	0.12	1.0	105	0.11	1.0	-	-	-	-	-	-	40	0.08	0.8	-	-	-	
T9315		0.4	210	0.10	1.0	-	-	-	195	0.10	1.0	-	-	-	-	-	-	-	-	-	
T9325		0.4	175	0.12	1.0	105	0.11	1.0	165	0.12	1.0	-	-	-	35	0.08	0.8	-	-	-	
T9335		0.4	150	0.12	1.0	90	0.11	1.0	-	-	-	-	-	-	30	0.11	0.8	-	-	-	
TT010		0.4	245	0.06	0.5	145	0.06	0.5	-	-	-	-	-	-	-	-	-	-	-	-	
VCGT 130308E-NF2		T5315	0.8	205	0.17	1.0	-	-	-	190	0.17	1.0	-	-	-	-	-	-	-	-	-
	T6310	0.8	125	0.17	1.0	90	0.15	1.0	100	0.17	1.0	375	0.20	1.0	35	0.12	0.8	-	-	-	
	T7325	0.8	145	0.17	1.0	110	0.15	1.0	-	-	-	-	-	-	45	0.12	0.8	-	-	-	
	T7335	0.8	140	0.17	1.0	105	0.15	1.0	-	-	-	-	-	-	45	0.12	0.8	-	-	-	
	T9315	0.8	200	0.17	1.0	-	-	-	190	0.17	1.0	-	-	-	-	-	-	-	-	-	
	T9325	0.8	180	0.17	1.0	105	0.15	1.0	170	0.17	1.0	-	-	-	40	0.12	0.8	-	-	-	
	T9335	0.8	155	0.18	1.0	90	0.16	1.0	-	-	-	-	-	-	30	0.16	0.8	-	-	-	
	TT010	0.8	245	0.10	0.8	145	0.09	0.8	-	-	-	-	-	-	-	-	-	-	-	-	

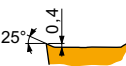

SF2 geometry with highly positive design for fine to finish machining, and continuous cuts.

VCGT 130301E-SF2	H07	0.1	-	-	-	80	0.05	1.0	-	-	-	405	0.06	1.0	40	0.04	0.8	-	-	-
	T6310	0.1	140	0.05	1.0	100	0.05	1.0	-	-	-	420	0.06	1.0	40	0.04	0.8	-	-	-



Suitability and starting values for cutting speed (vc), feed (f) and depth of cut (ap). Refer to our Machining Calculator app for further calculations.

Product	RE (mm)	P			M			K			N			S			H		
		vc [m/min]	f [mm/rev]	ap [mm]	vc [m/min]	f [mm/rev]	ap [mm]	vc [m/min]	f [mm/rev]	ap [mm]	vc [m/min]	f [mm/rev]	ap [mm]	vc [m/min]	f [mm/rev]	ap [mm]	vc [m/min]	f [mm/rev]	ap [mm]

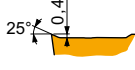

SF2 geometry with highly positive design for fine to finish machining, and continuous cuts.

VCGT 130302E-SF2	H07	0.2	-	-	-	80	0.05	1.0	-	-	-	405	0.06	1.0	40	0.04	0.8	-	-	-
	HF7	0.2	-	-	-	90	0.05	1.0	-	-	-	450	0.06	1.0	-	-	-	-	-	-
	T6310	0.2	140	0.05	1.0	100	0.05	1.0	-	-	-	420	0.06	1.0	40	0.04	0.8	-	-	-
VCGT 130304E-SF2	H07	0.4	-	-	-	65	0.09	1.0	-	-	-	335	0.12	1.0	30	0.07	0.8	-	-	-
	HF7	0.4	-	-	-	75	0.09	1.0	-	-	-	375	0.12	1.0	-	-	-	-	-	-
	T6310	0.4	125	0.10	1.0	90	0.09	1.0	-	-	-	375	0.12	1.0	35	0.07	0.8	-	-	-
VCGT 130308E-SF2	H07	0.8	-	-	-	75	0.09	1.0	-	-	-	390	0.12	1.0	35	0.08	0.8	-	-	-
	HF7	0.8	-	-	-	85	0.09	1.0	-	-	-	435	0.12	1.0	-	-	-	-	-	-
	T6310	0.8	145	0.10	1.0	100	0.09	1.0	-	-	-	435	0.12	1.0	40	0.08	0.8	-	-	-

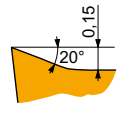

SF3 geometry with highly positive design for fine to finish machining, and continuous cuts.

VCGT 070202E-SF3	H07	0.2	-	-	-	80	0.05	0.8	130	0.05	0.8	415	0.06	0.8	40	0.04	0.6	-	-	-
	T6310	0.2	145	0.05	0.8	100	0.05	0.8	115	0.05	0.8	435	0.06	0.8	40	0.04	0.6	25	0.15	1.0
VCGT 070204E-SF3	T6310	0.4	125	0.10	0.8	90	0.09	0.8	100	0.10	0.8	375	0.12	0.8	35	0.07	0.6	25	0.15	1.0
VCGT 110201E-SF3	T6310	0.1	140	0.05	0.5	100	0.05	0.5	110	0.05	0.5	420	0.06	0.5	40	0.04	0.4	25	0.15	1.0
VCGT 110202E-SF3	H07	0.2	-	-	-	80	0.05	0.8	130	0.05	0.8	415	0.06	0.8	40	0.04	0.6	-	-	-
	T6310	0.2	145	0.05	0.8	100	0.05	0.8	115	0.05	0.8	435	0.06	0.8	40	0.04	0.6	25	0.15	1.0
	T8315	0.2	150	0.05	0.8	90	0.05	0.8	140	0.05	0.8	450	0.06	0.8	35	0.04	0.6	25	0.15	1.0
VCGT 110204E-SF3	H07	0.4	-	-	-	65	0.09	0.8	105	0.10	0.8	335	0.12	0.8	30	0.07	0.6	-	-	-
	T6310	0.4	125	0.10	0.8	90	0.09	0.8	100	0.10	0.8	375	0.12	0.8	35	0.07	0.6	25	0.15	1.0
	T8315	0.4	135	0.10	0.8	80	0.09	0.8	125	0.10	0.8	405	0.12	0.8	30	0.07	0.6	25	0.15	1.0
VCGT 110301E-SF3	T6310	0.1	140	0.05	0.5	100	0.05	0.5	110	0.05	0.5	420	0.06	0.5	40	0.04	0.4	25	0.15	1.0
VCGT 110302E-SF3	T6310	0.2	145	0.05	0.8	100	0.05	0.8	115	0.05	0.8	435	0.06	0.8	40	0.04	0.6	25	0.15	1.0
VCGT 110304E-SF3	T6310	0.4	125	0.10	0.8	90	0.09	0.8	100	0.10	0.8	375	0.12	0.8	35	0.07	0.6	25	0.15	1.0
VCGT 130302E-SF3	H07	0.2	-	-	-	80	0.05	0.8	130	0.05	0.8	415	0.06	0.8	40	0.04	0.6	-	-	-
	T6310	0.2	145	0.05	0.8	100	0.05	0.8	115	0.05	0.8	435	0.06	0.8	40	0.04	0.6	25	0.15	1.0
	T8315	0.2	150	0.05	0.8	90	0.05	0.8	140	0.05	0.8	450	0.06	0.8	35	0.04	0.6	25	0.15	1.0
VCGT 130304E-SF3	H07	0.4	-	-	-	65	0.09	1.0	105	0.10	1.0	335	0.12	1.0	30	0.07	0.8	-	-	-
	T6310	0.4	125	0.10	1.0	90	0.09	1.0	100	0.10	1.0	375	0.12	1.0	35	0.07	0.8	25	0.15	1.0
	T8315	0.4	130	0.10	1.0	75	0.09	1.0	120	0.10	1.0	390	0.12	1.0	30	0.07	0.8	25	0.15	1.0
VCGT 130308E-SF3	H07	0.8	-	-	-	75	0.09	1.0	120	0.10	1.0	390	0.12	1.0	35	0.08	0.8	-	-	-
	T6310	0.8	145	0.10	1.0	100	0.09	1.0	115	0.10	1.0	435	0.12	1.0	40	0.08	0.8	25	0.15	1.0
	T8315	0.8	155	0.10	1.0	90	0.09	1.0	145	0.10	1.0	465	0.12	1.0	35	0.08	0.8	30	0.15	1.0
VCGT 160402E-SF3	T6310	0.2	145	0.05	0.8	100	0.05	0.8	115	0.05	0.8	435	0.06	0.8	40	0.04	0.6	25	0.15	1.0
VCGT 160404E-SF3	H07	0.4	-	-	-	65	0.09	1.0	105	0.10	1.0	335	0.12	1.0	30	0.07	0.8	-	-	-
	T6310	0.4	125	0.10	1.0	90	0.09	1.0	100	0.10	1.0	375	0.12	1.0	35	0.07	0.8	25	0.15	1.0
	T8315	0.4	130	0.10	1.0	75	0.09	1.0	120	0.10	1.0	390	0.12	1.0	30	0.07	0.8	25	0.15	1.0
VCGT 160408E-SF3	H07	0.8	-	-	-	75	0.09	1.2	120	0.10	1.2	390	0.12	1.2	35	0.08	1.0	-	-	-
	T6310	0.8	145	0.10	1.2	100	0.09	1.2	115	0.10	1.2	435	0.12	1.2	40	0.08	1.0	25	0.15	1.0
	T8315	0.8	155	0.10	1.2	90	0.09	1.2	145	0.10	1.2	465	0.12	1.2	35	0.08	1.0	30	0.15	1.0
VCGT 160412E-SF3	H07	1.2	-	-	-	60	0.18	1.2	95	0.20	1.2	310	0.24	1.2	30	0.14	1.0	-	-	-
	T6310	1.2	125	0.20	1.2	90	0.18	1.2	100	0.20	1.2	375	0.24	1.2	35	0.14	1.0	25	0.15	1.0



Suitability and starting values for cutting speed (vc), feed (f) and depth of cut (ap). Refer to our Machining Calculator app for further calculations.

Product	RE [mm]	P			M			K			N			S			H		
		vc [m/min]	f [mm/rev]	ap [mm]	vc [m/min]	f [mm/rev]	ap [mm]	vc [m/min]	f [mm/rev]	ap [mm]	vc [m/min]	f [mm/rev]	ap [mm]	vc [m/min]	f [mm/rev]	ap [mm]	vc [m/min]	f [mm/rev]	ap [mm]

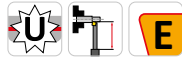
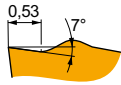

FL-FF2 geometry with positive left-handed design for fine-finish to finish machining, and continuous cuts.

VCGX 130300FL-FF2	T6310	0.0	140	0.05	1.0	—	—	—	110	0.05	1.0	—	—	—	—	—	—	—
	T8315	0.0	150	0.05	1.0	—	—	—	140	0.05	1.0	—	—	—	—	—	—	—
	TT010	0.0	240	0.05	0.5	—	—	—	—	—	—	—	—	—	—	—	—	—
VCGX 130301FL-FF2	T6310	0.1	140	0.05	1.0	—	—	—	110	0.05	1.0	—	—	—	—	—	—	—
	T8315	0.1	150	0.05	1.0	—	—	—	140	0.05	1.0	—	—	—	—	—	—	—

VCMT



	IC [mm]	D1 [mm]	L [mm]	S [mm]
1103	6.350	2.80	11.10	3.18
1604	9.525	4.40	16.60	4.76

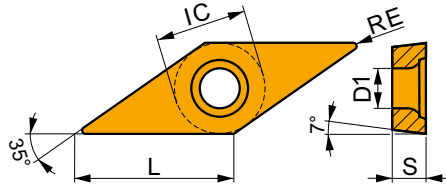

Suitability and starting values for cutting speed (vc), feed (f) and depth of cut (ap). Refer to our Machining Calculator app for further calculations.

Product	RE [mm]	P			M			K			N			S			H		
		vc [m/min]	f [mm/rev]	ap [mm]	vc [m/min]	f [mm/rev]	ap [mm]	vc [m/min]	f [mm/rev]	ap [mm]	vc [m/min]	f [mm/rev]	ap [mm]	vc [m/min]	f [mm/rev]	ap [mm]	vc [m/min]	f [mm/rev]	ap [mm]

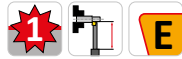
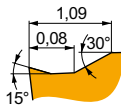

FM geometry for finish to semi-rough machining, and continuous to slightly interrupted cuts.

VCMT 160404E-FM	T7325	0.4	125	0.19	1.2	95	0.17	1.2	—	—	—	—	—	—	—	—	—	—
	T8330	0.4	130	0.12	1.2	75	0.11	1.2	120	0.12	1.2	390	0.14	1.2	—	—	—	—
	T8430	0.4	150	0.12	1.2	80	0.11	1.2	125	0.12	1.2	420	0.14	1.2	—	—	—	—
	T9315	0.4	210	0.12	1.2	—	—	—	195	0.12	1.2	—	—	—	—	—	—	—
VCMT 160408E-FM	T9325	0.4	155	0.19	1.2	90	0.17	1.2	145	0.19	1.2	—	—	—	—	—	—	—
	T7325	0.8	155	0.17	1.2	120	0.15	1.2	—	—	—	—	—	—	—	—	—	—
	T8330	0.8	135	0.17	1.2	80	0.15	1.2	125	0.17	1.2	405	0.20	1.2	—	—	—	—
	T8430	0.8	155	0.17	1.2	85	0.15	1.2	130	0.17	1.2	435	0.20	1.2	—	—	—	—
	T9315	0.8	220	0.17	1.2	—	—	—	205	0.17	1.2	—	—	—	—	—	—	—
T9325	0.8	195	0.17	1.2	115	0.15	1.2	185	0.17	1.2	—	—	—	—	—	—	—	

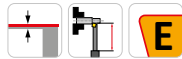
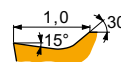

UR geometry for fine to finish machining, and continuous to slightly interrupted cuts.

VCMT 110304E-UR	T7325	0.4	110	0.19	0.8	85	0.17	0.8	—	—	—	—	—	—	—	—	—	—
	T8330	0.4	110	0.12	0.8	65	0.11	0.8	100	0.12	0.8	—	—	—	—	—	—	—
	T8430	0.4	135	0.12	0.8	75	0.11	0.8	110	0.12	0.8	—	—	—	—	—	—	—
	T9315	0.4	190	0.12	0.8	—	—	—	180	0.12	0.8	—	—	—	—	—	—	—
	T9325	0.4	140	0.19	0.8	80	0.17	0.8	130	0.19	0.8	—	—	—	—	—	—	—
VCMT 110308E-UR	T7325	0.8	140	0.17	0.8	105	0.15	0.8	—	—	—	—	—	—	—	—	—	—
	T8330	0.8	125	0.17	0.8	75	0.15	0.8	115	0.17	0.8	—	—	—	—	—	—	—
	T8430	0.8	140	0.17	0.8	75	0.15	0.8	115	0.17	0.8	—	—	—	—	—	—	—
	T9315	0.8	195	0.17	0.8	—	—	—	185	0.17	0.8	—	—	—	—	—	—	—
	T9325	0.8	175	0.17	0.8	105	0.15	0.8	165	0.17	0.8	—	—	—	—	—	—	—



Suitability and starting values for cutting speed (vc), feed (f) and depth of cut (ap). Refer to our Machining Calculator app for further calculations.

Product	RE (mm)	P			M			K			N			S			H			
		vc (m/min)	f (mm/rev)	ap (mm)	vc (m/min)	f (mm/rev)	ap (mm)	vc (m/min)	f (mm/rev)	ap (mm)	vc (m/min)	f (mm/rev)	ap (mm)	vc (m/min)	f (mm/rev)	ap (mm)	vc (m/min)	f (mm/rev)	ap (mm)	
	0.4	T7325	110	0.19	1.2	85	0.17	1.2	-	-	-	-	-	-	-	-	-	-	-	
		T8330	110	0.12	1.2	65	0.11	1.2	100	0.12	1.2	-	-	-	-	-	-	-	-	
		T8430	130	0.12	1.2	70	0.11	1.2	105	0.12	1.2	-	-	-	-	-	-	-	-	
		T9315	180	0.12	1.2	-	-	-	170	0.12	1.2	-	-	-	-	-	-	-	-	-
		T9325	135	0.19	1.2	80	0.17	1.2	125	0.19	1.2	-	-	-	-	-	-	-	-	-
VCMT 160408E-UR	0.8	T7325	135	0.17	1.2	105	0.15	1.2	-	-	-	-	-	-	-	-	-	-	-	
		T8330	115	0.17	1.2	65	0.15	1.2	105	0.17	1.2	-	-	-	-	-	-	-	-	
		T8430	135	0.17	1.2	75	0.15	1.2	110	0.17	1.2	-	-	-	-	-	-	-	-	
		T9315	190	0.17	1.2	-	-	-	180	0.17	1.2	-	-	-	-	-	-	-	-	-
		T9325	170	0.17	1.2	100	0.15	1.2	160	0.17	1.2	-	-	-	-	-	-	-	-	-

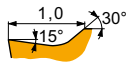

UR geometry for fine to finish machining, and continuous to slightly interrupted cuts.

VCMW



	IC (mm)	D1 (mm)	L (mm)	S (mm)
1103	6.350	2.80	11.10	3.18
1604	9.525	4.40	16.60	4.76

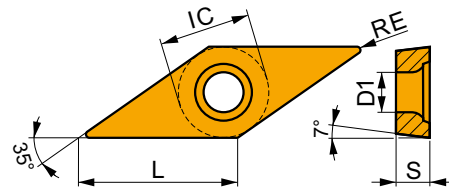

Suitability and starting values for cutting speed (vc), feed (f) and depth of cut (ap). Refer to our Machining Calculator app for further calculations.

Product	RE (mm)	P			M			K			N			S			H		
		vc (m/min)	f (mm/rev)	ap (mm)	vc (m/min)	f (mm/rev)	ap (mm)	vc (m/min)	f (mm/rev)	ap (mm)	vc (m/min)	f (mm/rev)	ap (mm)	vc (m/min)	f (mm/rev)	ap (mm)	vc (m/min)	f (mm/rev)	ap (mm)
VCMW 110302	0.2	T5305	-	-	-	-	-	-	170	0.08	1.2	-	-	-	-	-	35	0.15	1.0
		T5315	-	-	-	-	-	-	145	0.08	1.2	-	-	-	-	-	30	0.15	1.0
		T6310	-	-	-	-	-	-	70	0.08	1.2	-	-	-	-	-	15	0.15	1.0
VCMW 110304	0.4	T5305	-	-	-	-	-	-	165	0.10	1.2	-	-	-	-	-	35	0.15	1.0
		T5315	-	-	-	-	-	-	145	0.10	1.2	-	-	-	-	-	30	0.15	1.0
		T6310	-	-	-	-	-	-	70	0.10	1.2	-	-	-	-	-	15	0.15	1.0
VCMW 160404	0.4	T5305	-	-	-	-	-	-	165	0.10	1.5	-	-	-	-	-	35	0.15	1.0
		T5315	-	-	-	-	-	-	140	0.10	1.5	-	-	-	-	-	30	0.15	1.0
		T6310	-	-	-	-	-	-	70	0.10	1.5	-	-	-	-	-	15	0.15	1.0
VCMW 160408	0.8	T5305	-	-	-	-	-	-	155	0.18	1.5	-	-	-	-	-	30	0.15	1.0
		T5315	-	-	-	-	-	-	135	0.18	1.5	-	-	-	-	-	25	0.15	1.0
		T6310	-	-	-	-	-	-	70	0.18	1.5	-	-	-	-	-	15	0.15	1.0

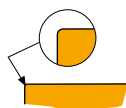

For fine-finish to semi-rough machining, and continuous to slightly interrupted cuts.



VCMW PCD



	IC	D1	L	S
	[mm]	[mm]	[mm]	[mm]
1604	9.525	4.40	16.60	4.76

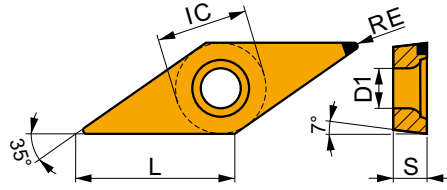

Suitability and starting values for cutting speed (vc), feed (f) and depth of cut (ap). Refer to our Machining Calculator app for further calculations.

Product	RE [mm]	P			M			K			N			S			H		
		vc [m/min]	f [mm/rev]	ap [mm]	vc [m/min]	f [mm/rev]	ap [mm]	vc [m/min]	f [mm/rev]	ap [mm]	vc [m/min]	f [mm/rev]	ap [mm]	vc [m/min]	f [mm/rev]	ap [mm]	vc [m/min]	f [mm/rev]	ap [mm]

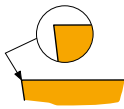

PCD tipped for finish to semi-rough machining, high speeds and stable cutting conditions.

VCMW 160404FN	PD1	0.4	-	-	-	-	-	-	-	■	900	0.12	0.5	-	-	-	-	-	-
VCMW 160408FN	PD1	0.8	-	-	-	-	-	-	-	■	1050	0.12	1.0	-	-	-	-	-	-



SVAC(RL)-DC EXT



Ext. Screw Lock Swiss Style Tool Holder, 90° Cutting Angle for VCGX 13 Insert

External Right/Left hand tool holder for screw type positive VCGX 13 Swiss style inserts. Suited for external face and longitudinal turning with shoulder, taper, copy turning up to 53° and chamfer turning. Available with shank size 10x10 up to 25x25mm. Body treated for longer tool life.

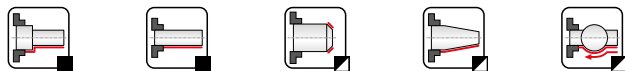
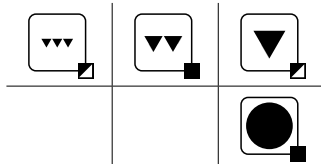
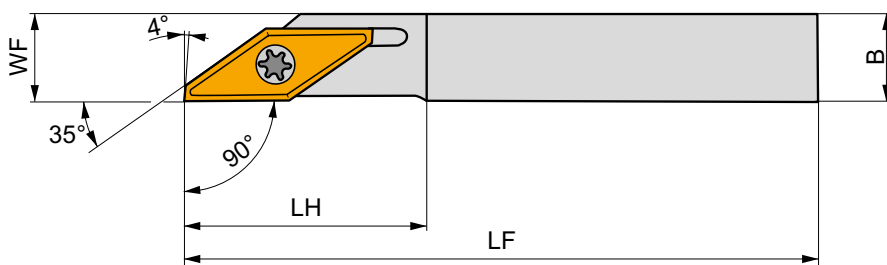
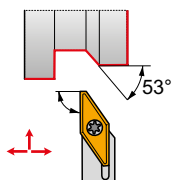

Product	H	B	HF	WF	LF	LH	LAMS	GAMO	kg			
	[mm]	[mm]	[mm]	[mm]	[mm]	[mm]	[°]	[°]				
R	SVACR 1010 L 13-DC	10	10	10	10	140	25	0	0	0.12	GI222	SV20
	SVACR 1212 L 13-DC	12	12	12	12	140	25	0	0	0.17	GI222	SV20
	SVACR 1616 M 13-DC	16	16	16	16	150	25	0	0	0.29	GI222	SV20
	SVACR 2020 M 13-DC	20	20	20	20	150	25	0	0	0.46	GI222	SV20
	SVACR 2525 M 13-DC	25	25	25	25	150	25	0	0	0.67	GI222	SV20
L	SVACL 1010 L 13-DC	10	10	10	10	140	25	0	0	0.10	GI222	SV20
	SVACL 1212 L 13-DC	12	12	12	12	140	25	0	0	0.19	GI222	SV20
	SVACL 1616 M 13-DC	16	16	16	16	150	25	0	0	0.29	GI222	SV20
	SVACL 2020 M 13-DC	20	20	20	20	150	25	0	0	0.43	GI222	SV20
	SVACL 2525 M 13-DC	25	25	25	25	150	25	0	0	0.67	GI222	SV20



GI222



VCGX 1303..



SV20



5513 020-24



1.5



M 3



8.5



PT-8002



SVGCL(RL) EXT



PRAMET

S



External Screw Lock Tool Holder with 90° Cutting Angle for VC.. Insert

External Right/Left hand tool holder for screw type positive VC.. 07 inserts. Suited for external longitudinal turning with shoulder, taper, copy turning up to 53° and chamfer turning. Available with shank size 08x08 up to 16x16 mm. Body treated for longer tool life.

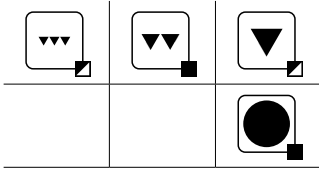
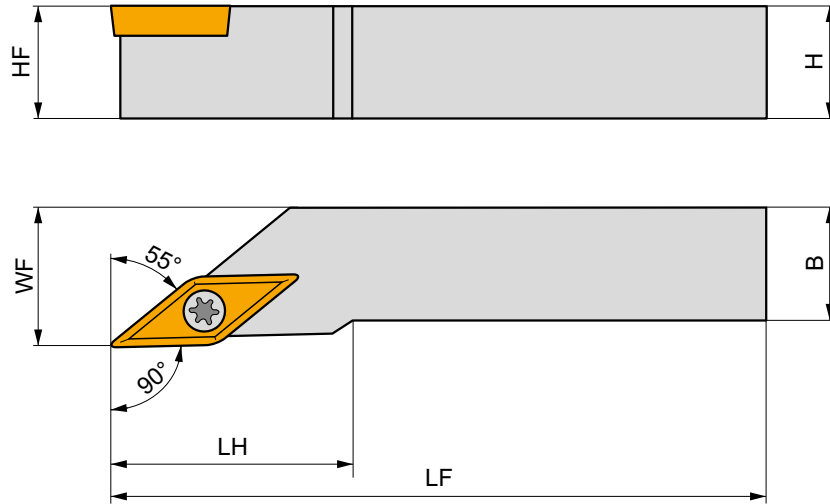
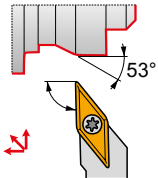

Product	H	B	HF	WF	LF	LH	LAMS	GAMO	kg	GI234	SV23
	[mm]	[mm]	[mm]	[mm]	[mm]	[mm]	[°]	[°]			
R SVGCR 0808 K 07	8	8	8	8.5	125	15	0	0	0.07	GI234	SV23
SVGCR 1010 M 07	10	10	10	10.5	150	15	0	0	0.13	GI234	SV23
SVGCR 1212 M 07	12	12	12	12.5	150	18	0	0	0.17	GI234	SV23
SVGCR 1616 P 07	16	16	16	16.3	170	23	0	0	0.33	GI234	SV23
L SVGCL 0808 K 07	8	8	8	8.5	125	15	0	0	0.07	GI234	SV23
SVGCL 1010 M 07	10	10	10	10.5	150	15	0	0	0.13	GI234	SV23
SVGCL 1212 M 07	12	12	12	12.5	150	18	0	0	0.17	GI234	SV23
SVGCL 1616 P 07	16	16	16	16.3	170	23	0	0	0.33	GI234	SV23



GI234



VC.. 0702..



SV23



DVF 3584



0.6



M 2



5.5



DMD 1650



SVHB(C)(RL) EXT



Ext. Screw Lock Tool Holder with 107.5° Cutting Angle for VB/VC.. Inserts

External Right/Left hand tool holder for screw type positive VB.. 11 or 16 and VC.. 11 or 16 inserts. Suited for external face and longitudinal turning with shoulder, taper, face and longitudinal copy turning up to 35° and chamfer turning. Available with shank size 16x16 up to 25x25 mm. Body treated for longer tool life.

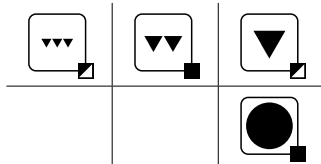
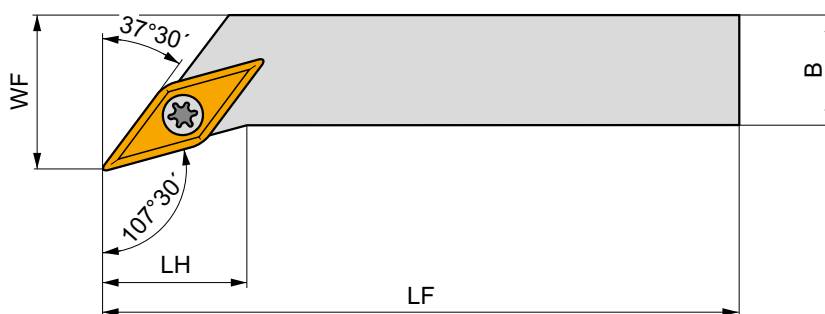
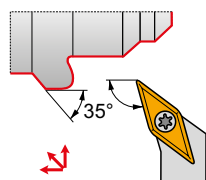

Product	H	B	HF	WF	LF	LH	LAMS	GAMO	kg			
	[mm]	[mm]	[mm]	[mm]	[mm]	[mm]	[°]	[°]				
R	SVHBR 1616 H 11	16	16	16	20	100	14	0	0	0.21	GI194	S01
	SVHCR 2020 K 16-M-A	20	20	20	25	125	20	0	0	0.40	GI017	SV10
	SVHCR 2525 M 16-M-A	25	25	25	32	150	20	0	0	0.68	GI017	SV10
L	SVHBL 1616 H 11	16	16	16	20	100	14	0	0	0.19	GI194	S01
	SVHCL 2020 K 16-M-A	20	20	20	25	125	20	0	0	0.40	GI017	SV10
	SVHCL 2525 M 16-M-A	25	25	25	32	150	20	0	0	0.07	GI017	SV10

GI017	VB.. 1604..	VC.. 1604..
GI194	VB.. 1103..	VC.. 1103..

S01	US 2506-T07P	0.9	M 2.5	6.3	–	–	FLAGT07P	–
SV10	US 3512-T15P	3.0	M 3.5	12.6	SVN 160304	MS 3510	FLAGT15P	HXK 3.5



SVJB(C)(RL) EXT



External Screw Lock Tool Holder with 93° Cutting Angle for VB/VC.. Inserts

External Right/Left hand tool holder for screw type positive VB.. 11 or 16 and VC.. 11 up to 16 inserts. Suited for external longitudinal turning with shoulder, taper, copy turning up to 50° and chamfer turning. Available with shank size 12x12 up to 32x25 mm. Body treated for longer tool life.

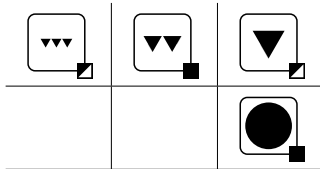
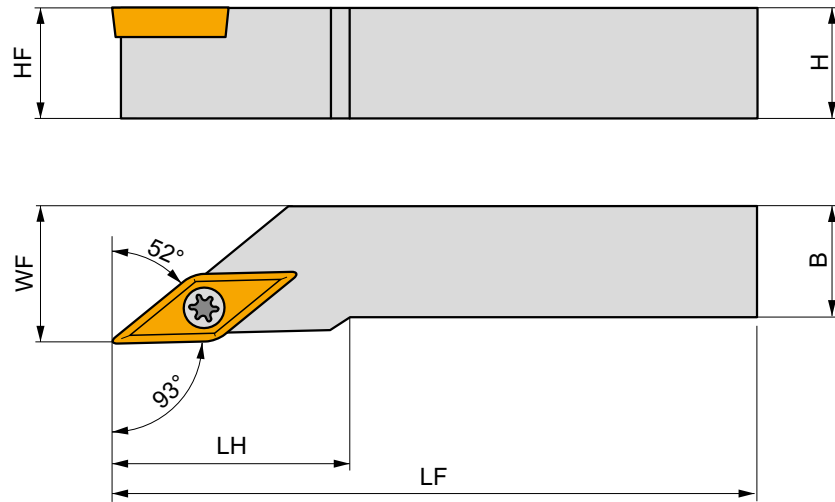
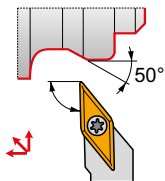

Product	H	B	HF	WF	LF	LH	LAMS	GAMO	kg	GI	SV	
	[mm]	[mm]	[mm]	[mm]	[mm]	[mm]	[°]	[°]				
R	SVJBR 1212 F 11	12	12	12	16	80	20	0	0	0.09	GI194	S01
	SVJBR 1616 H 11	16	16	16	20	100	20	0	0	0.20	GI194	S01
	SVJCR 1212 N 13	12	12	12	16	160	27	0	0	0.19	GI211	SV21
	SVJCR 1616 H 13	16	16	16	20	100	30	0	0	0.20	GI211	SV21
	SVJCR 2020 K 13	20	20	20	25	125	30	0	0	0.37	GI211	SV22
	SVJCR 2525 M 13	25	25	25	32	150	30	0	0	0.67	GI211	SV22
	SVJCR 2020 K 16-M-A	20	20	20	25	125	28	0	0	0.35	GI017	SV10
	SVJCR 2525 M 16-M-A	25	25	25	32	150	32	0	0	0.68	GI017	SV10
	SVJCR 3225 P 16-M-A	32	25	32	32	170	32	0	0	0.99	GI017	SV10
L	SVJBL 1212 F 11	12	12	12	16	80	20	0	0	0.09	GI194	S01
	SVJBL 1616 H 11	16	16	16	20	100	20	0	0	0.19	GI194	S01
	SVJCL 1212 N 13	12	12	12	16	160	27	0	0	0.19	GI211	SV21
	SVJCL 1616 H 13	16	16	16	20	100	30	0	0	0.20	GI211	SV21
	SVJCL 2020 K 13	20	20	20	25	125	30	0	0	0.37	GI211	SV22
	SVJCL 2525 M 13	25	25	25	32	150	30	0	0	0.67	GI211	SV22
	SVJCL 2020 K 16-M-A	20	20	20	25	125	28	0	0	0.40	GI017	SV10
	SVJCL 2525 M 16-M-A	25	25	25	32	150	32	0	0	0.70	GI017	SV10
	SVJCL 3225 P 16-M-A	32	25	32	32	170	32	0	0	0.99	GI017	SV10

GI	VB..	VC..
GI017	VB.. 1604..	VC.. 1604..
GI194	VB.. 1103..	VC.. 1103..
GI211	-	VC.. 1303..

SV	US	Nm	M	mm	SVN	MS	PT	mm
S01	US 2506-T07P	0.9	M 2.5	6.3	-	-	FLAG T07P	-
SV10	US 3512-T15P	3.0	M 3.5	12.6	SVN 160304	MS 3510	FLAG T15P	HXK 3.5
SV21	5513 020-24	1.5	M 3	8.5	-	-	PT-8002	-
SV22	DVF 0573	1.5	M 3	10.3	DAP 0331	DVT 0332	PT-8002	174.1-870



SVJC(RL)-DC EXT



Ext. Screw Lock Swiss Style Tool Holder, 93° Cutting Angle for VCGX 13 Insert

External Right/Left hand tool holder for screw type positive VCGX 13 Swiss style inserts. Suited for external face and longitudinal turning with shoulder, taper, copy turning up to 50° and chamfer turning. Available with shank size 10x10 up to 25x25 mm. Body treated for longer tool life.

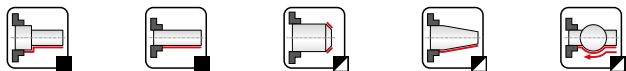
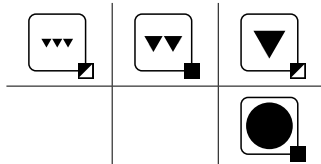
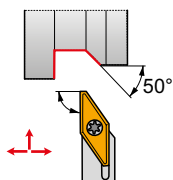
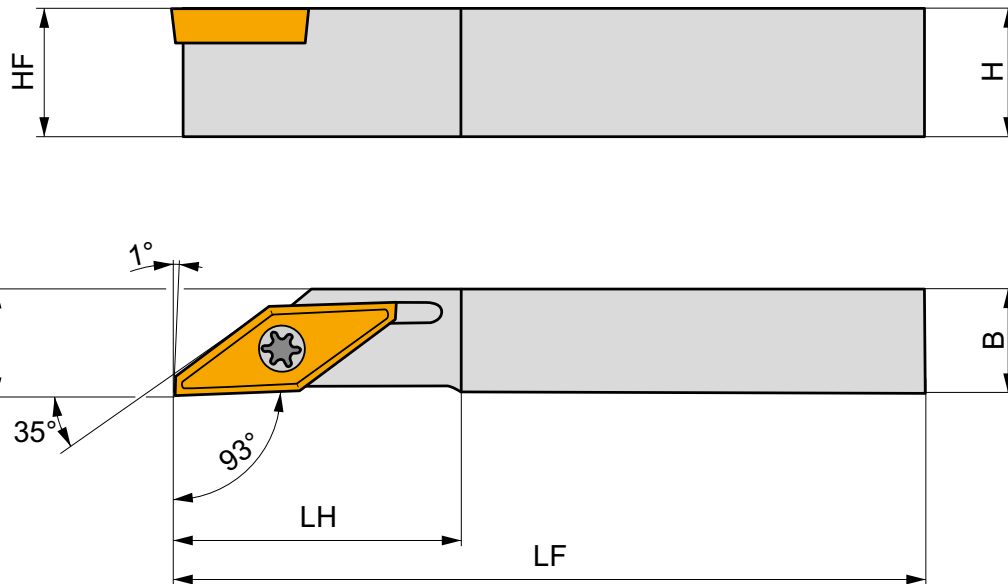

Product	H	B	HF	WF	LF	LH	LAMS	GAMO	kg	G122	SV20	
	[mm]	[mm]	[mm]	[mm]	[mm]	[mm]	[°]	[°]				
R	SVJCR 1010 L 13-DC	10	10	10	0	140	25	0	0	0.12	G122	SV20
	SVJCR 1212 L 13-DC	12	12	12	0	140	25	0	0	0.17	G122	SV20
	SVJCR 1616 M 13-DC	16	16	16	0	150	25	0	0	0.29	G122	SV20
	SVJCR 2020 M 13-DC	20	20	20	0	150	25	0	0	0.45	G122	SV20
	SVJCR 2525 M 13-DC	25	25	25	0	150	25	0	0	0.68	G122	SV20
L	SVJCL 1010 L 13-DC	10	10	10	0	140	25	0	0	0.12	G122	SV20
	SVJCL 1212 L 13-DC	12	12	12	0	140	25	0	0	0.17	G122	SV20
	SVJCL 1616 M 13-DC	16	16	16	0	150	25	0	0	0.30	G122	SV20
	SVJCL 2020 M 13-DC	20	20	20	0	150	25	0	0	0.47	G122	SV20
	SVJCL 2525 M 13-DC	25	25	25	0	150	25	0	0	0.69	G122	SV20



G122



VCGX 1303..



SV20



5513 020-24



1.5



M 3



8.5



PT-8002



SVPB(C)(RL) EXT

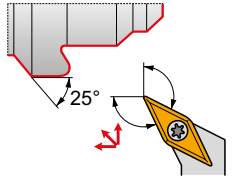
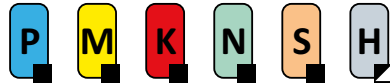

External Screw Lock Tool Holder, 117.5° Cutting Angle for VB/VC.. Inserts

External Right/Left hand tool holder for screw type positive VB.. 11 or 16 and VC.. 11 or 16 inserts. Suited for external face and longitudinal turning with shoulder, taper, face copy turning up to 25° and chamfer turning. Available with shank size 16x16 up to 32x25 mm. Body treated for longer tool life.

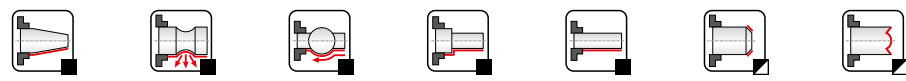
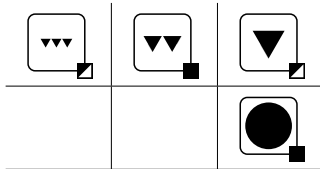
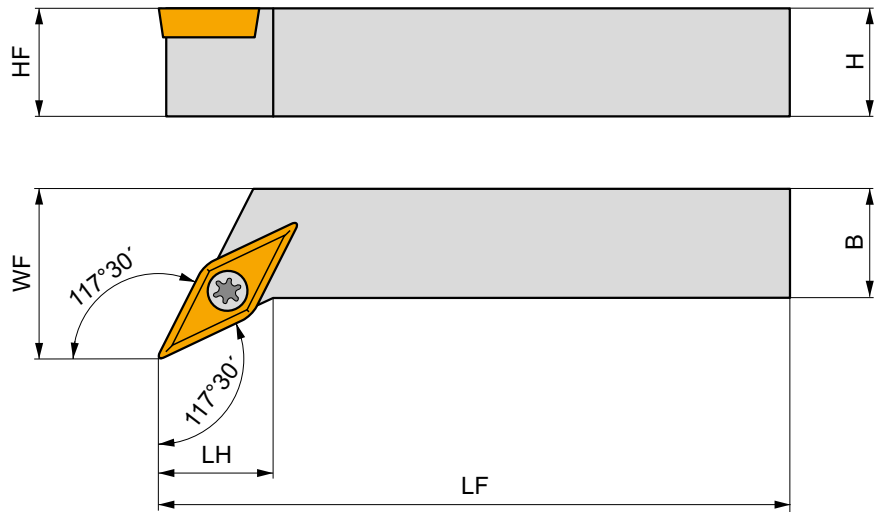

Product	H	B	HF	WF	LF	LH	LAMS	GAMO	kg	GI	SV	
	[mm]	[mm]	[mm]	[mm]	[mm]	[mm]	[°]	[°]				
R	SVPBR 1616 H 11	16	16	16	20	100	12	0	0	0.20	GI194	S01
	SVPBR 2020 K 11	20	20	20	25	125	12	0	0	0.41	GI194	S01
	SVPCR 2020 K 16-M-A	20	20	20	25	125	20	0	0	0.40	GI017	SV10
	SVPCR 2525 M 16-M-A	25	25	25	32	150	25	0	0	0.75	GI017	SV10
L	SVPCR 3225 P 16-M-A	32	25	32	32	170	25	0	0	1.10	GI017	SV10
	SVPBL 1616 H 11	16	16	16	20	100	12	0	0	0.20	GI194	S01
	SVPBL 2020 K 11	20	20	20	25	125	12	0	0	0.39	GI194	S01
	SVPCL 2020 K 16-M-A	20	20	20	25	125	20	0	0	0.70	GI017	SV10
	SVPCL 2525 M 16-M-A	25	25	25	32	150	25	0	0	0.70	GI017	SV10
SVPCL 3225 P 16-M-A	32	25	32	32	170	25	0	0	1.10	GI017	SV10	

GI	VB..	VC..
GI017	VB.. 1604..	VC.. 1604..
GI194	VB.. 1103..	VC.. 1103..

SV	US	Nm	M	mm	mm	mm	mm	mm
S01	US 2506-T07P	0.9	M 2.5	6.3	-	-	FLAG T07P	-
SV10	US 3512-T15P	3.0	M 3.5	12.6	SVN 160304	MS 3510	FLAG T15P	HXK 3.5



SVVB(C)N EXT



External Screw Lock Tool Holder, 72.5° Cutting Angle for VB/VC.. Inserts

External neutral tool holder for screw type positive VB.. 11 or 16 and VC.. 11 up to 16 inserts. Suited for external longitudinal turning without shoulder, taper, copy turning up to 72.5° and chamfer turning. Available with shank size 12x12 up to 32x25 mm. Body treated for longer tool life.

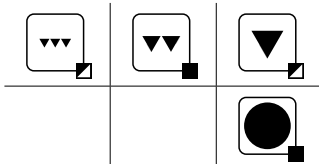
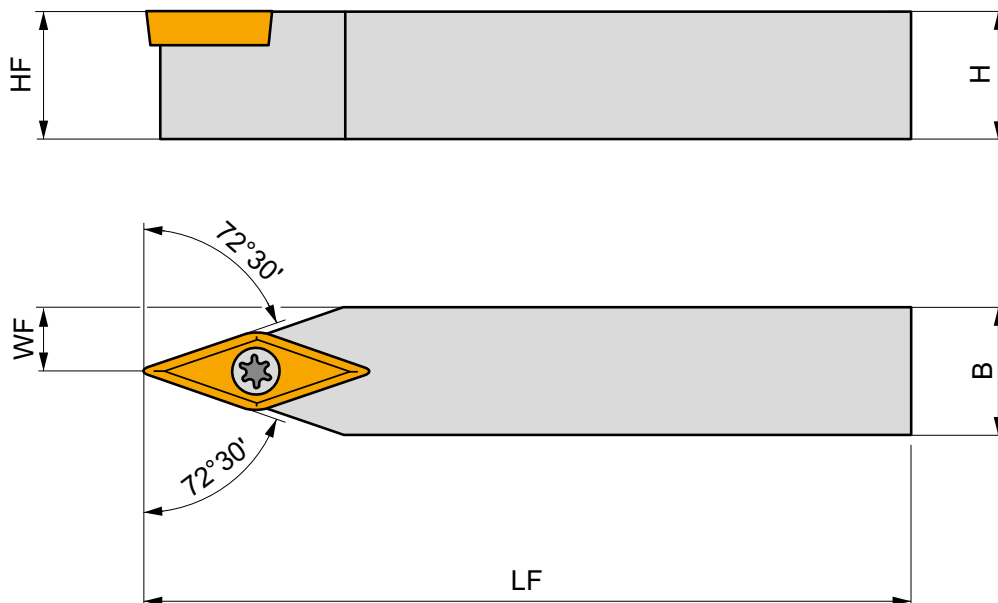
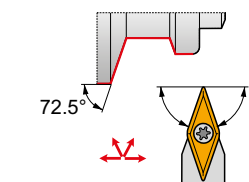

Product	H	B	HF	WF	LF	LH	LAMS	GAMO	kg	G1	S1
	[mm]	[mm]	[mm]	[mm]	[mm]	[mm]	[°]	[°]			
N	SVVBN 1212 F 11	12	12	12	6	80	-	0	0.11	G194	S01
	SVVBN 1616 H 11	16	16	16	8	100	-	0	0.18	G194	S01
	SVVBN 2020 K 11	20	20	20	10	125	-	0	0.38	G194	S01
	SVVCN 1212 N 13	12	12	12	6	160	-	0	0.19	G1211	SV21
	SVVCN 1616 H 13	16	16	16	8	100	-	0	0.20	G1211	SV21
	SVVCN 2020 K 13	20	20	20	10	125	-	0	0.36	G1211	SV22
	SVVCN 2525 M 13	25	25	25	12.5	150	-	0	0.66	G1211	SV22
	SVVCN 2020 K 16-M-A	20	20	20	10	125	-	0	0.34	G1017	SV10
	SVVCN 2525 M 16-M-A	25	25	25	12.5	150	-	0	0.68	G1017	SV10
	SVVCN 3225 P 16-M-A	32	25	32	12.5	170	-	0	0.98	G1017	SV10

G1017	VB.. 1604..	VC.. 1604..
G1194	VB.. 1103..	VC.. 1103..
G1211	-	VC.. 1303..

		Nm						
S01	US 2506-T07P	0.9	M 2.5	6.3	-	-	FLAG T07P	-
SV10	US 3512-T15P	3.0	M 3.5	12.6	SVN 160304	MS 3510	FLAG T15P	HXX 3.5
SV21	5513 020-24	1.5	M 3	8.5	-	-	PT-8002	-
SV22	DVF 0573	1.5	M 3	10.3	DAP 0331	DVT 0332	PT-8002	174.1-870



SVXB(C)(RL) EXT

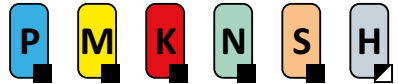

External Screw Lock Tool Holder 98/113° Cutting Angle for VB/VC.. Inserts

External Right/Left hand tool holder for screw type positive VB.. 11 or 16 and VC.. 11 up to 16 inserts. Suited for external longitudinal turning with shoulder, taper, copy turning up to 30° and chamfer turning. Available with shank size 12x12 up to 32x25 mm. Body treated for longer tool life.

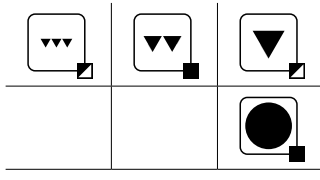
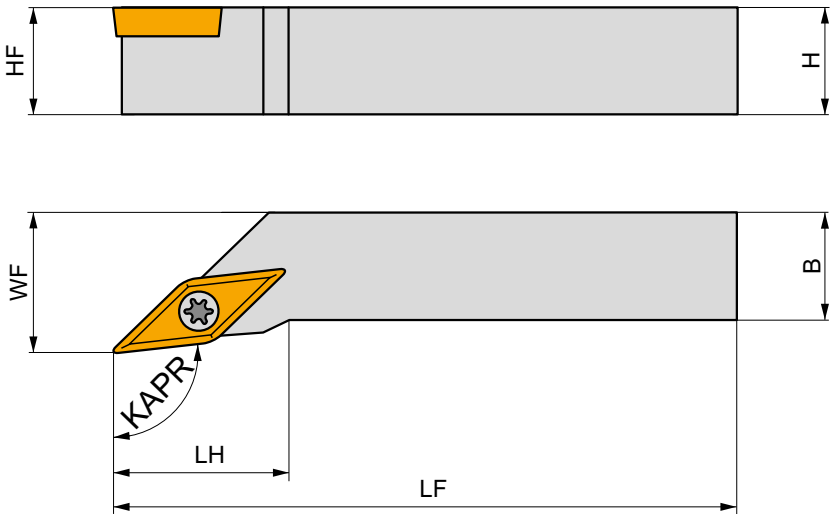
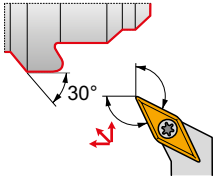

Product	H	B	HF	WF	LF	LH	KAPR	LAMS	GAMO	kg	GI	SV
	[mm]	[mm]	[mm]	[mm]	[mm]	[mm]	[°]	[°]	[°]			
R	SVXBR 1212 F 11	12	12	12	16	80	20	98	0	0	0.09	GI194 S01
	SVXBR 1616 H 11	16	16	16	20	100	14	98	0	0	0.19	GI194 S01
	SVXCR 2020 K 13	20	20	20	25	125	12	113	0	0	0.38	GI211 SV22
	SVXCR 2020 K 16-M-A	20	20	20	25	125	28	98	0	0	0.41	GI017 SV10
	SVXCR 2525 M 16-M-A	25	25	25	32	150	32	98	0	0	0.68	GI017 SV10
	SVXCR 3225 P 16-M-A	32	25	32	32	170	32	98	0	0	1.00	GI017 SV10
L	SVXBL 1212 F 11	12	12	12	16	80	20	98	0	0	0.09	GI194 S01
	SVXBL 1616 H 11	16	16	16	20	100	14	98	0	0	0.19	GI194 S01
	SVXCL 2020 K 13	20	20	20	25	125	12	113	0	0	0.38	GI211 SV22
	SVXCL 2020 K 16-M-A	20	20	20	25	125	28	98	0	0	0.38	GI017 SV10
	SVXCL 2525 M 16-M-A	25	25	25	32	150	32	98	0	0	0.69	GI017 SV10
	SVXCL 3225 P 16-M-A	32	25	32	32	170	32	98	0	0	0.99	GI017 SV10

GI	VB..	VC..
GI017	VB.. 1604..	VC.. 1604..
GI194	VB.. 1103..	VC.. 1103..
GI211	-	VC.. 1303..

SV	US	Nm	M	mm	mm	mm	mm	mm	mm
S01	US 2506-T07P	0.9	M 2.5	6.3	-	-	FLAG T07P	-	-
SV10	US 3512-T15P	3.0	M 3.5	12.6	SVN 160304	MS 3510	FLAG T15P	HXK 3.5	-
SV22	DVF 0573	1.5	M 3	10.3	DAP 0331	DVT 0332	PT-8002	174.1-870	-



C.-SVHB(RL) EXT



Ext. PSC Quick Change Tool, Screw Lock, 107.5° Cutting Angle, VB/VC.. Inserts

External Right/Left hand tool, through coolant, for screw type positive VB.. 16 and VC.. 16 inserts. Suited for external longitudinal turning with shoulder, taper, copy turning up to 35° and chamfer turning. Available with PSC (Polygon Shank Coupling) size C4 up to C6. Body treated for longer tool life.

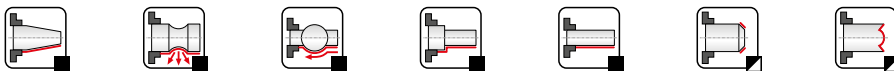
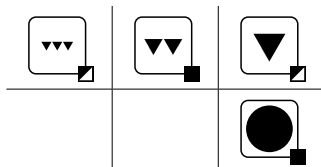
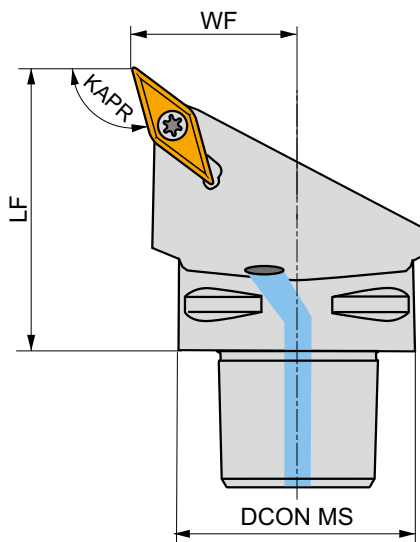
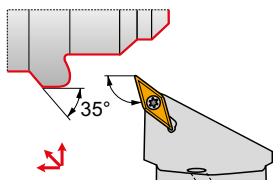

Product	DCON MS	WF	LF	KAPR	LAMS	GAMO				
	[mm]	[mm]	[mm]	[°]	[°]	[°]				
R	C4-SVHBR-27050-16	40	27	50	107.5	0	✓	0.35	GI017	C-SV16S-1
	C5-SVHBR-35060-16	50	35	60	107.5	0	✓	0.64	GI017	C-SV16S-2
	C6-SVHBR-45065-16	63	45	65	107.5	0	✓	1.13	GI017	C-SV16S-2
L	C4-SVHBL-27050-16	40	27	50	107.5	0	✓	0.35	GI017	C-SV16S-1
	C5-SVHBL-35060-16	50	35	60	107.5	0	✓	0.64	GI017	C-SV16S-2
	C6-SVHBL-45065-16	63	45	65	107.5	0	✓	1.12	GI017	C-SV16S-2

GI017	VB.. 1604..	VC.. 1604..

C-SV16S-1	US 2001-T15P	3.0	M 3.5	12.1	SVS 270-01	MS 9001	FLAGT15P/3,5	CN 034-01
C-SV16S-2	US 2001-T15P	3.0	M 3.5	12.1	SVS 270-01	MS 9001	FLAGT15P/3,5	CN 034-02



C.-SVJB(RL) EXT

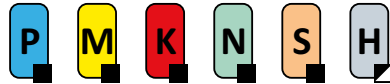

PRAMET



Ext. PSC Quick Change Tool, Screw Lock, 93° Cutting Angle for VB/VC.. Inserts

External Right/Left hand tool, through coolant, for screw type positive VB.. 11 or 16 and VC.. 11 up to 16 inserts. Suited for external longitudinal turning with shoulder, taper, copy turning up to 50° and chamfer turning. Available with PSC (Polygon Shank Coupling) size C3 up to C6. Body treated for longer tool life.

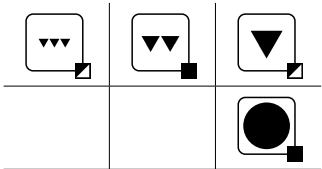
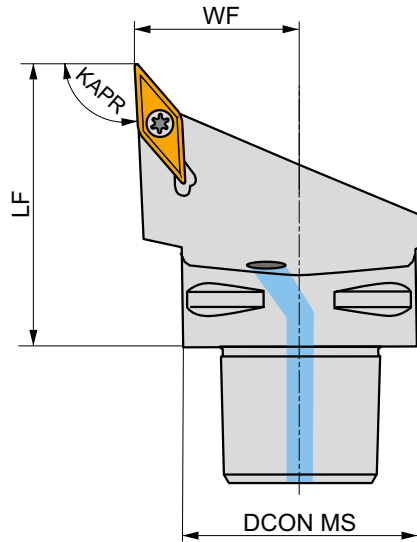
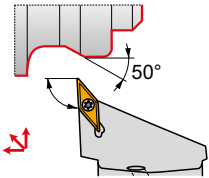

Product	DCON MS	WF	LF	KAPR	LAMS	GAMO		kg		
	[mm]	[mm]	[mm]	[°]	[°]	[°]				
R	C3-SVJBR-22040-11-B1	32	22	40	93	0	✓	0.17	GI194	C-SV11
	C4-SVJBR-27050-11-B1	40	27	50	93	0	✓	0.34	GI194	C-SV11
	C4-SVJBR-27050-16	40	27	50	93	0	✓	0.35	GI017	C-SV16S-1
	C5-SVJBR-35060-16	50	35	60	93	0	✓	0.63	GI017	C-SV16S-2
	C6-SVJBR-45065-16	63	45	65	93	0	✓	1.11	GI017	C-SV16S-2
L	C4-SVJBL-27050-16	40	27	50	93	0	✓	0.35	GI017	C-SV16S-1
	C5-SVJBL-35060-16	50	35	60	93	0	✓	0.64	GI017	C-SV16S-2
	C6-SVJBL-45065-16	63	45	65	93	0	✓	1.11	GI017	C-SV16S-2

GI017	VB.. 1604..	VC.. 1604..
GI194	VB.. 1103..	VC.. 1103..

C-SV11	US 2003-T07P	0.8	M 2.5	6.5	-	-	FLAG T07P	CN 034-01
C-SV16S-1	US 2001-T15P	3.0	M 3.5	12.1	SVS 270-01	MS 9001	FLAG T15P/3,5	CN 034-01
C-SV16S-2	US 2001-T15P	3.0	M 3.5	12.1	SVS 270-01	MS 9001	FLAG T15P/3,5	CN 034-02



C.-SVVBN EXT



Ext. PSC Quick Change Tool, Screw Lock, 72.5° Cutting Angle, VB/VC.. Inserts

External neutral tool, through coolant, for screw type positive VB.. 16 and VC.. 16 inserts. Suited for external longitudinal turning without shoulder, taper, copy turning up to 72.5° and chamfer turning. Available with PSC (Polygon Shank Coupling) size C4 up to C6. Body treated for longer tool life.

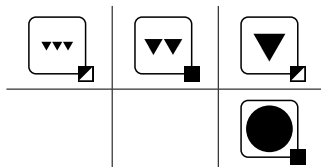
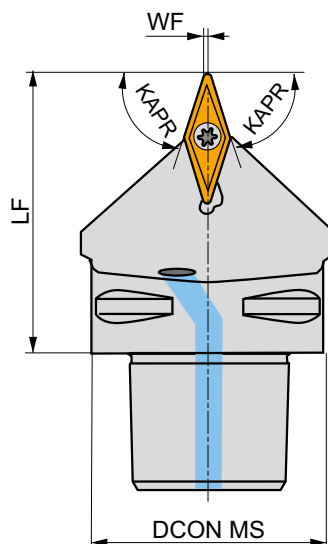
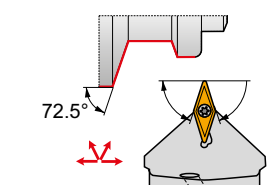

Product	DCON MS [mm]	WF [mm]	LF [mm]	KAPR [°]	LAMS [°]	GAMO [°]		kg		
N C4-SVVBN-00050-16	40	0.6	50	72.5	0	0	✓	0.32	GI017	C-SV16S-1
C5-SVVBN-00060-16	50	0.6	60	72.5	0	0	✓	0.56	GI017	C-SV16S-2
C6-SVVBN-00065-16	63	0.6	65	72.5	0	0	✓	0.99	GI017	C-SV16S-2

GI017	VB.. 1604..	VC.. 1604..

C-SV16S-1	US 2001-T15P	3.0	M 3.5	12.1	SVS 270-01	MS 9001	FLAG T15P/3,5	CN 034-01
C-SV16S-2	US 2001-T15P	3.0	M 3.5	12.1	SVS 270-01	MS 9001	FLAG T15P/3,5	CN 034-02



SVJB(RL) INT

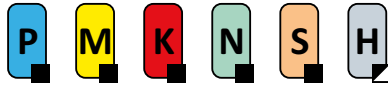

PRAMET

S



Internal Screw Lock Boring Bar with 93° Cutting Angle for VB/VC.. Inserts

Internal Right/Left hand boring bar, through coolant, with 93° cutting angle for screw type VB.. 11 and VC.. 11 inserts. Minimum internal turning diameter Ø25 mm. Suited for face copy turning under 50°. Available with shank size Ø20 and Ø25 mm. Body treated for longer tool life.

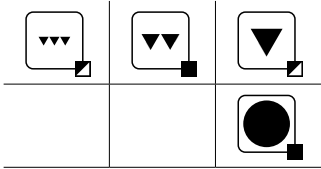
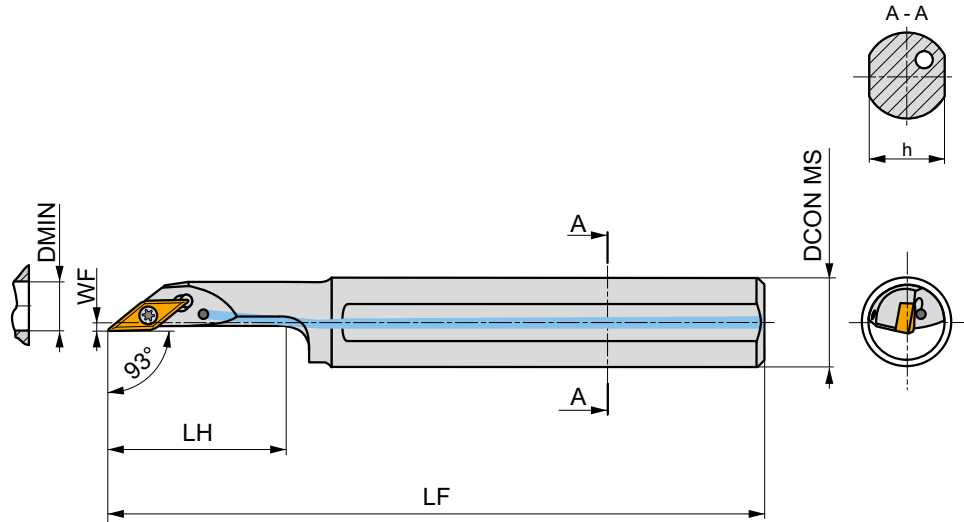
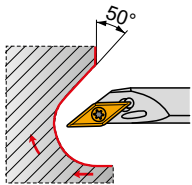

Product	DCON MS	DMIN	WF	H	LF	LH	LAMS	GAMO	✓	kg	G1194	S07
	[mm]	[mm]	[mm]	[mm]	[mm]	[mm]	[°]	[°]				
R A20R-SVJBR 11	20	25	2	18	200	40	-5	-5	✓	0.44	G1194	S07
	A25S-SVJBR 11	25	32	3.5	23	250	50	-5	-5	✓	0.82	G1194
L A20R-SVJBL 11	20	25	2	18	200	40	-5	-5	✓	0.42	G1194	S07
	A25S-SVJBL 11	25	32	3.5	23	250	50	-5	-5	✓	0.82	G1194

G1194	VB.. 1103..	VC.. 1103..

S07	US 2506-T07P	0.9	M 2.5	6.3	FLAG T07P



SVLC(RL) INT



Internal Screw Lock Boring Bar with 50° Cutting Angle for VC.. Insert

Internal Right/Left hand boring bar, through coolant, with 50° cutting angle for screw type VC.. 13 inserts. Minimum internal turning diameter Ø27 mm. Suited for a wide range of internal pulling turning operations and copying under 48°. Available with shank size Ø20 up to Ø32 mm. Body treated for longer tool life.

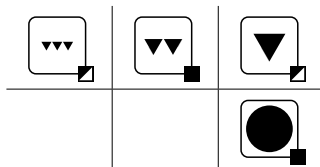
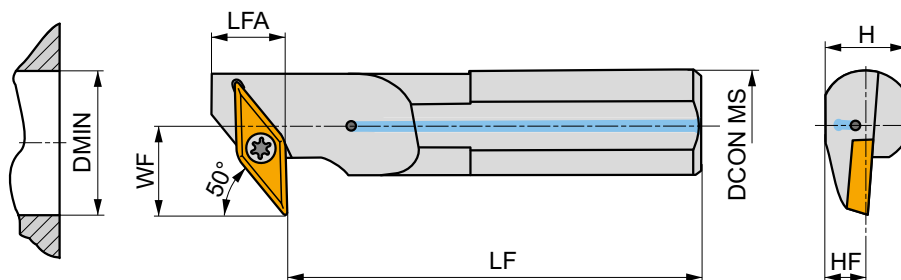
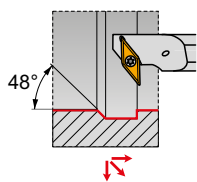

Product	DCON MS	DMIN	WF	H	LF	HF	LFA	LAMS	GAMO					
	[mm]	[mm]	[mm]	[mm]	[mm]	[mm]	[mm]	[°]	[°]					
R	A20S-SVLCR 13-X	20	27	15	18	250	9	15	-4	-2	✓	0.57	GI211	SV21
	A25T-SVLCR 13-X	25	35	20	24	300	12	18	-2	-2	✓	1.01	GI211	SV22
	A32T-SVLCR 13-X	32	43	25	30	300	15	18	-1	-2	✓	1.75	GI211	SV22
L	A20S-SVLCL 13-X	20	27	15	18	250	9	15	-4	-2	✓	0.57	GI211	SV21
	A25T-SVLCL 13-X	25	35	20	24	300	12	18	-2	-2	✓	0.05	GI211	SV22
	A32T-SVLCL 13-X	32	43	25	30	300	15	18	-1	-2	✓	1.75	GI211	SV22



GI211



VC.. 1303..



SV21



5513 020-24



1.5



M3



8.5



-



-



PT-8002



-

SV22

DVF 0573

1.5

M3

10.3

DAP 0331

DVT 0332

PT-8002

174.1-870



SVQB(C)(RL) INT



PRAMET



Internal Screw Lock Boring Bar with 107.5° Cutting Angle for VB/VC.. Inserts

Internal Right/Left hand boring bar, through coolant available, with 107.5° cutting angle for screw type VB../VC.. 11 and 16 inserts. Minimum internal turning diameter Ø20 mm. Suited for a wide range of internal turning operations. Available with shank size Ø16 up to Ø40 mm.

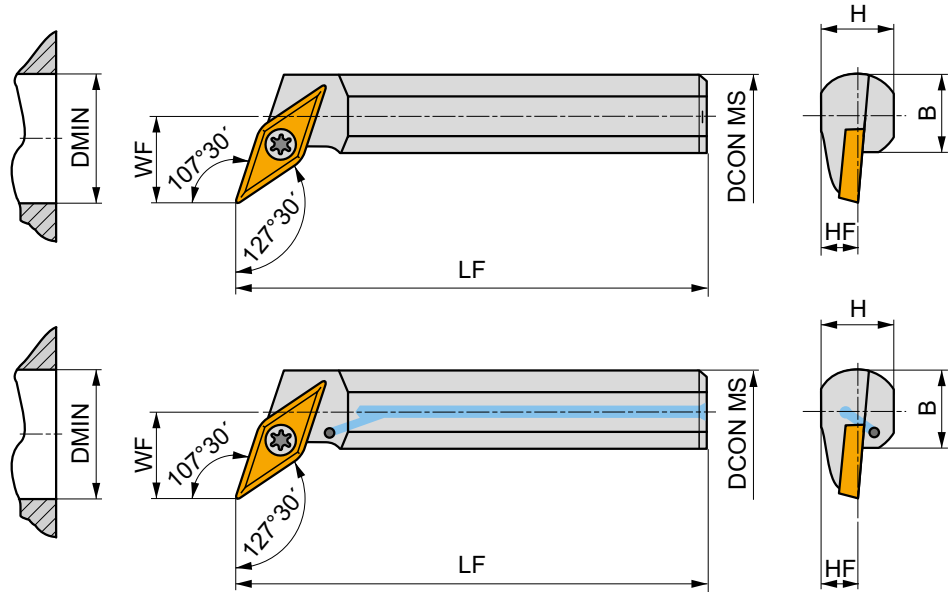
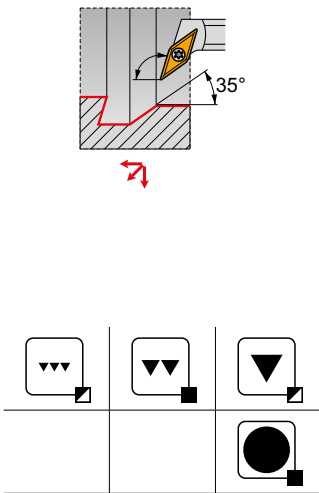

Product	DCON MS	DMIN	WF	H	B	LF	LAMS	GAMO					
	[mm]	[mm]	[mm]	[mm]	[mm]	[mm]	[°]	[°]					
R	A16R-SVQBR 11	16	20	11	14.5	15	200	-5	0	✓	0.33	GI194	S01
	A20S-SVQBR 11	20	25	13	18	18.5	250	-4	0	✓	0.58	GI194	S01
	A16R-SVQCR 13	16	21	11	15	15	200	-6	0	✓	0.30	GI211	SV21
	A20S-SVQCR 13	20	25	13	18	18.5	250	-4	0	✓	0.12	GI211	SV21
	S25T-SVQCR 16	25	32	17	23	23	300	-7	0	-	1.10	GI017	S08
	S32U-SVQCR 16	32	40	22	30	30	350	-5	0	-	2.07	GI017	S08
	S40V-SVQCR 16-A	40	50	27	38	38	400	-5	0	-	3.80	GI017	SV10
L	A16R-SVQBL 11	16	20	11	14.5	15	200	-5	0	✓	0.33	GI194	S01
	A20S-SVQBL 11	20	25	13	18	18.5	250	-4	0	✓	0.58	GI194	S01
	A16R-SVQCL 13	16	21	11	15	15	200	-6	0	✓	0.29	GI211	SV21
	A20S-SVQCL 13	20	25	13	18	18.5	250	-4	0	✓	0.54	GI211	SV21
	S25T-SVQCL 16	25	32	17	23	23	300	-7	0	-	1.09	GI017	S08
	S32U-SVQCL 16	32	40	22	30	30	350	-5	0	-	2.07	GI017	S08
	S40V-SVQCL 16-A	40	50	27	38	38	400	-5	0	-	4.10	GI017	SV10

GI017	VB.. 1604..	VC.. 1604..
GI194	VB.. 1103..	VC.. 1103..
GI211	-	VC.. 1303..

S01	US 2506-T07P	0.9	M 2.5	6.3	-	-	FLAG T07P	-
S08	US 3510-T15P	3.0	M 3.5	10.6	-	-	FLAG T15P	-
SV10	US 3512-T15P	3.0	M 3.5	12.6	SVN 160304	MS 3510	FLAG T15P	HXK 3.5
SV21	5513 020-24	1.5	M 3	8.5	-	-	PT-8002	-



SVUB(C)(RL) INT



PRAMET

S

Internal Screw Lock Boring Bar with 93° Cutting Angle for VB/VC.. Inserts

Internal Right/Left hand boring bar, through coolant available, with 93° cutting angle for screw type VB../VC.. 11 and 16 inserts. Minimum internal turning diameter Ø20 mm. For a wide range of internal turning operations and copying under 50°. Ø16 up to Ø40 mm shanks available. Body treated for longer tool life.

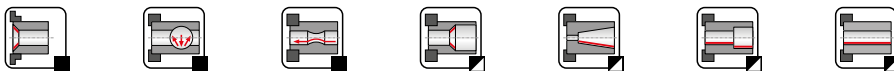
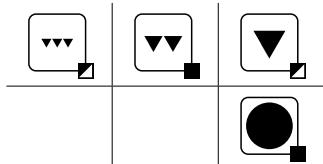
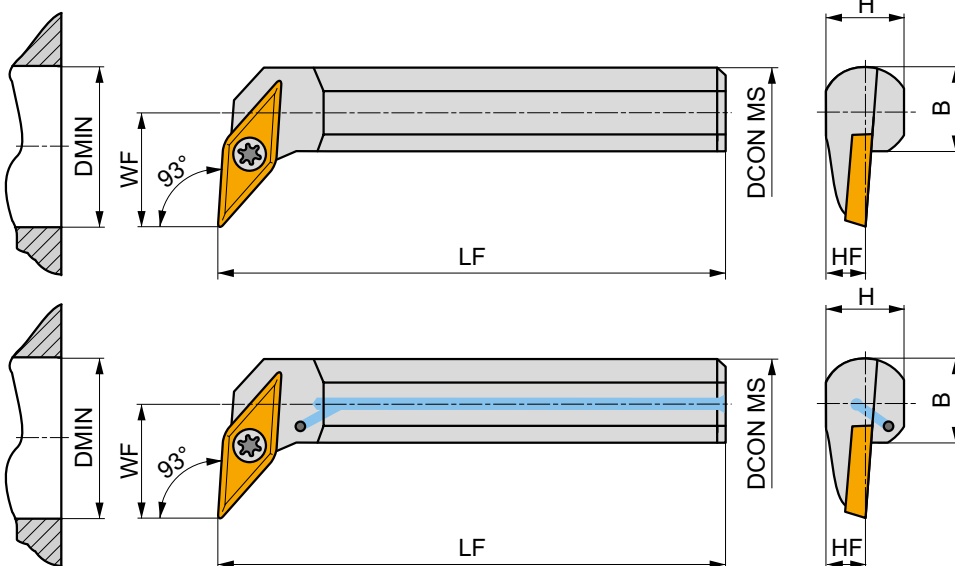
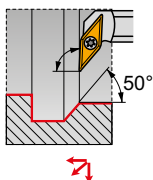

Product	DCON MS	DMIN	WF	H	B	LF	LAMS	GAMO	✓	kg	G	S	
	[mm]	[mm]	[mm]	[mm]	[mm]	[mm]	[°]	[°]					
R	A16R-SVUBR 11	16	20	11	14.5	15	200	-5	0	✓	0.34	GI194	S01
	A20S-SVUBR 11	20	25	13	18	18.8	250	-4	0	✓	0.58	GI194	S01
	A20S-SVUCR 13	20	25	13	19	18.5	250	-4	2	✓	0.40	GI211	SV21
	A25T-SVUCR 13	25	32	17	24	23	300	-2	2	✓	0.96	GI211	SV22
	A32T-SVUCR 13	32	40	22	30	30	300	-1	2	✓	1.70	GI211	SV22
	S25T-SVUCR 16	25	32	17	23	23	300	-7	0	-	1.10	GI017	S08
	S32U-SVUCR 16	32	40	22	30	30	350	-5	0	-	2.10	GI017	S08
S40V-SVUCR 16-A	40	50	27	38	38	400	-5	0	-	4.10	GI017	SV10	
L	A16R-SVUBL 11	16	20	11	14.5	15	200	-5	0	✓	0.34	GI194	S01
	A20S-SVUBL 11	20	25	13	18	18.5	250	-4	0	✓	0.58	GI194	S01
	A20S-SVUCL 13	20	25	13	19	18.5	250	-4	2	✓	0.32	GI211	SV21
	A25T-SVUCL 13	25	32	17	24	23	300	-2	2	✓	0.96	GI211	SV22
	A32T-SVUCL 13	32	40	22	30	30	300	-1	2	✓	1.70	GI211	SV22
	S25T-SVUCL 16	25	32	17	23	23	300	-7	0	-	1.10	GI017	S08
	S32U-SVUCL 16	32	40	22	30	30	350	-5	0	-	2.10	GI017	S08
S40V-SVUCL 16-A	40	50	27	38	38	400	-5	0	-	4.10	GI017	SV10	

GI017	VB.. 1604..	VC.. 1604..
GI194	VB.. 1103..	VC.. 1103..
GI211	-	VC.. 1303..

S01	US 2506-T07P	0.9	M 2.5	6.3	-	-	FLAG T07P	-
S08	US 3510-T15P	3.0	M 3.5	10.6	-	-	FLAG T15P	-
SV10	US 3512-T15P	3.0	M 3.5	12.6	SVN 160304	MS 3510	FLAG T15P	HXX 3.5
SV21	5513 020-24	1.5	M 3	8.5	-	-	PT-8002	-
SV22	DVF 0573	1.5	M 3	10.3	DAP 0331	DVT 0332	PT-8002	174.1-870



SVXC(RL) INT

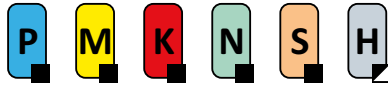

PRAMET

S



Internal Screw Lock Boring Bar with 113° Cutting Angle for VC.. Insert

Internal Right/Left hand boring bar, through coolant, with 113° cutting angle for screw type VC..07 inserts. Minimum internal turning diameter Ø12.5 mm. Suited for a wide range of internal turning operations and copying under 32°. Available with shank size Ø10 up to Ø16 mm. Body treated for longer tool life.

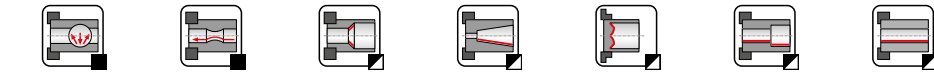
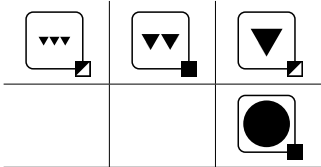
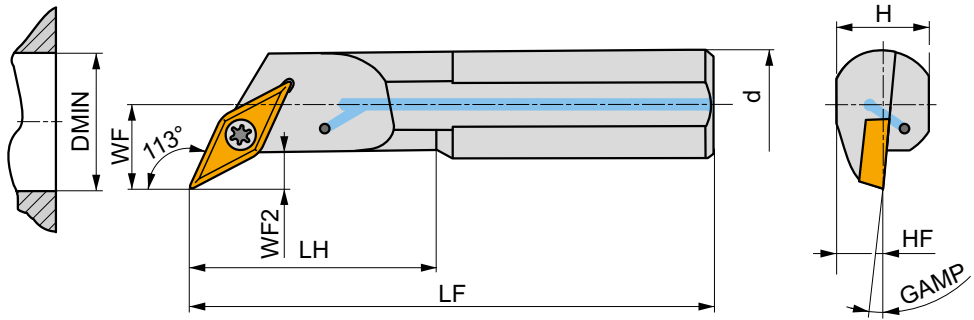
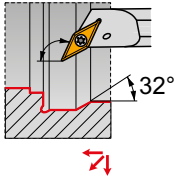

Product	D CON MS	D MIN	WF	H	LF	HF	LH	WF2	GAMP	Handedness	kg	Material	Grade
	[mm]	[mm]	[mm]	[mm]	[mm]	[mm]	[mm]	[mm]	[°]				
R	A10H-SVXCR 07	10	12.5	7	9	100	4.5	22	3	-10	✓	0.06	GI234 SV23
	A12K-SVXCR 07	12	15.5	9	11	125	5.5	28	3	-8	✓	0.11	GI234 SV23
	A16M-SVXCR 07	16	17.5	11	15	150	7.5	36	3	-6	✓	0.19	GI234 SV23
L	A10H-SVXCL 07	10	12.5	7	9	100	4.5	22	3	-10	✓	0.06	GI234 SV23
	A12K-SVXCL 07	12	15.5	9	11	125	5.5	28	3	-8	✓	0.11	GI234 SV23
	A16M-SVXCL 07	16	17.5	11	15	150	7.5	36	3	-6	✓	0.20	GI234 SV23

GI234 VC.. 0702..

SV23 DVF 3584 0.6 Nm M 2 5.5 DMD 1650



SVXC(RL)-E INT



Internal Carbide Screw Lock Boring Bar, 113° Cutting Angle for VC.. Insert

Internal Right/Left hand carbide boring bar, through coolant, with 113° cutting angle for screw type VC.. 07 inserts. Minimum internal turning diameter $\varnothing 12.5$ mm. Suited for a wide range of internal turning operations and copying under 32°. Available with shank size $\varnothing 10$ up to $\varnothing 16$ mm. For tool overhang $>3xD$.

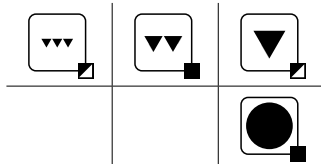
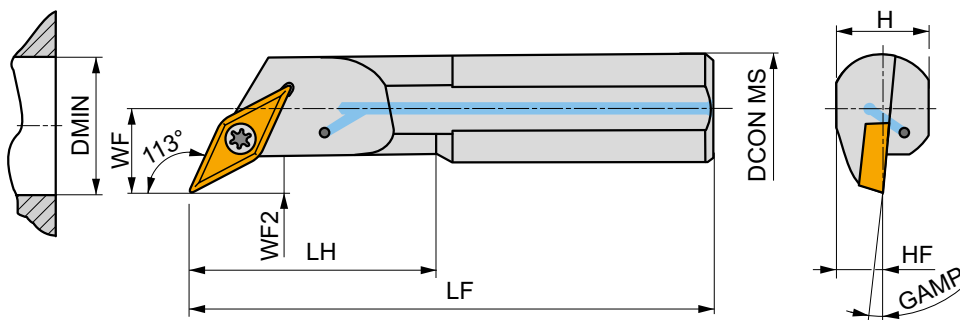
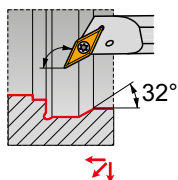

Product	DCON MS	DMIN	WF	H	HF	LF	LH	WF2	GAMP				
	[mm]	[mm]	[mm]	[mm]	[mm]	[mm]	[mm]	[mm]	[°]				
R	E10H-SVXCR 07	10	12.5	7	9	4.5	100	22	3	-10	✓	0.10	GI234 SV23
	E12K-SVXCR 07	12	15.5	9	11	5.5	125	28	3	-8	✓	0.19	GI234 SV23
	E16M-SVXCR 07	16	17.5	11	15	7.5	150	36	3	-6	✓	0.33	GI234 SV23
L	E10H-SVXCL 07	10	12.5	7	9	4.5	100	22	3	-10	✓	0.10	GI234 SV23
	E12K-SVXCL 07	12	15.5	9	11	5.5	125	28	3	-8	✓	0.19	GI234 SV23
	E16M-SVXCL 07	16	17.5	11	15	7.5	150	36	3	-6	✓	0.33	GI234 SV23



GI234



VC.. 0702..



SV23



DVF 3584



Nm

0.6



M 2



5.5



DMD 1650



C.-SVQB(RL) INT



PRAMET

S



Int. PSC Quick Change Tool, Screw Lock, 107.5° Cutting Angle, VB/VC.. Inserts

Internal Right/Left hand tool, through coolant, with 107.5° cutting angle for screw type VB.. 16 or VC.. 16 inserts. Minimum internal turning diameter Ø33 mm. Suited for a wide range of internal turning operations. PSC shank (Polygon Shank Coupling) size C4 and C5 with choice of lengths. Body treated for longer tool life.

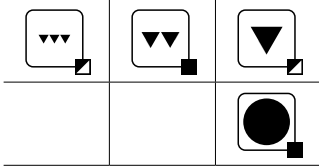
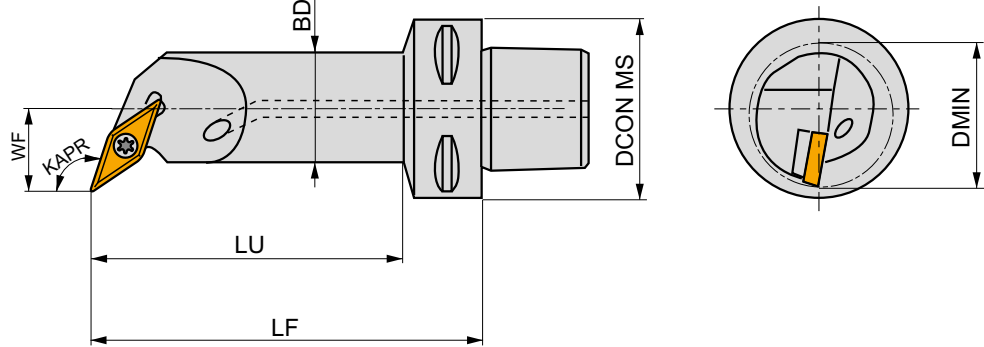
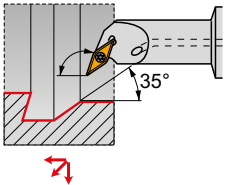

Product	DCON MS	DMIN	WF	LF	LU	BD	KAPR	LAMS	GAMO	✓	kg	GI017	SV16
	[mm]	[mm]	[mm]	[mm]	[mm]	[mm]	[°]	[°]	[°]				
R C4-SVQBR-18090-16	40	33	18	90	68	25	107.5	-7.2	0	✓	0.48	GI017	SV16
	C5-SVQBR-18090-16	50	33	18	90	67	25	107.5	-7.2	0	✓	0.67	GI017
L C4-SVQBL-18090-16	40	33	18	90	68	25	107.5	-7.2	0	✓	0.48	GI017	SV16
	C5-SVQBL-18090-16	50	33	18	90	67	25	107.5	-7.2	0	✓	0.68	GI017

GI017	VB.. 1604..	VC.. 1604..
-------	-------------	-------------

SV16	US 2010-T15P	3.0	M 3.5	10.1	FLAG T15P/3,5
------	--------------	-----	-------	------	---------------



WC

02/ 06/ 08/ 16

CARBIDE INSERTS

WCGT



212

WCGX



213

WCMT



213

MATCH THE RIGHT SIZE (example)

Insert

WCGT 020102E-FF2

Tool Holder

A0508H-SWUCR 02

ISO TURNING – EXTERNAL

SWLC(RL) EXT

95°

WC..

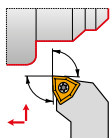
06
0816×16
25×25

215

212 – 214

ISO TURNING – INTERNAL

SWLC(RL) INT

95°

WC..

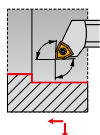
06
0825
40

216

212 – 214

SWUC(RL) INT

93°

WC..

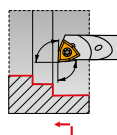

02

5,8
7,8

217

212 – 214

SWUC(RL)-E INT

93°

WC..

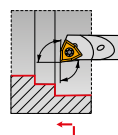

02

5,8
7,8

218

212 – 214



WCGT



	IC	D1	L	S
	[mm]	[mm]	[mm]	[mm]
0201	3.970	2.20	2.70	1.59
06T3	9.525	4.40	6.50	3.97
0804	12.700	5.50	8.70	4.76

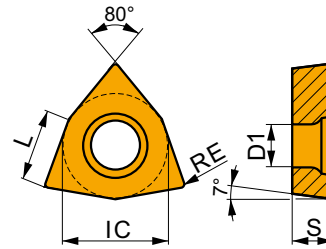

Suitability and starting values for cutting speed (vc), feed (f) and depth of cut (ap). Refer to our Machining Calculator app for further calculations.

Product	RE	P			M			K			N			S			H		
		vc	f	ap	vc	f	ap	vc	f	ap	vc	f	ap	vc	f	ap	vc	f	ap
	[mm]	[m/min]	[mm/rev]	[mm]	[m/min]	[mm/rev]	[mm]	[m/min]	[mm/rev]	[mm]	[m/min]	[mm/rev]	[mm]	[m/min]	[mm/rev]	[mm]	[m/min]	[mm/rev]	[mm]

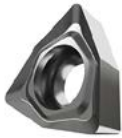

AL geometry with highly positive design for fine-finish to rough machining, and continuous to slightly interrupted cuts.

WCGT 06T302F-AL	HF7	0.2	-	-	-	-	-	-	-	■	450	0.12	1.0	-	-	-	-	-	-
WCGT 06T304F-AL	HF7	0.4	-	-	-	-	-	-	-	■	360	0.24	1.0	-	-	-	-	-	-
	T0315	0.4	-	-	-	-	-	-	-	■	525	0.24	1.0	-	-	-	-	-	-
WCGT 06T308F-AL	HF7	0.8	-	-	-	-	-	-	-	■	315	0.48	1.5	-	-	-	-	-	-
WCGT 080412F-AL	HF7	1.2	-	-	-	-	-	-	-	■	255	0.72	2.4	-	-	-	-	-	-
	T0315	1.2	-	-	-	-	-	-	-	■	375	0.72	2.4	-	-	-	-	-	-

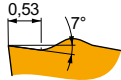

FF2 geometry with positive design for fine-finish to finish machining, and continuous to slightly interrupted cuts.

WCGT 020102E-FF2	HF7	0.2	-	-	-	-	-	-	-	■	210	0.05	0.8	-	-	-	-	-	-
	T8330	0.2	■	205	0.05	0.8	-	-	-	■	190	0.05	0.8	-	-	-	-	-	-
	T8430	0.2	■	280	0.05	0.8	-	-	-	▣	230	0.05	0.8	-	-	-	-	-	-
	TT010	0.2	■	345	0.05	0.5	-	-	-	-	-	-	-	-	-	-	-	-	-
WCGT 020104E-FF2	HF7	0.4	-	-	-	-	-	-	-	■	155	0.12	0.8	-	-	-	-	-	-
	T8330	0.4	■	170	0.12	0.8	-	-	-	■	160	0.12	0.8	-	-	-	-	-	-
	T8430	0.4	■	205	0.12	0.8	-	-	-	▣	170	0.12	0.8	-	-	-	-	-	-
	TT010	0.4	■	350	0.06	0.5	-	-	-	-	-	-	-	-	-	-	-	-	-



WCGX

	IC	D1	L	S
	[mm]	[mm]	[mm]	[mm]
0201	3.970	2.20	2.70	1.59

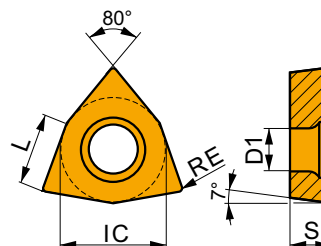

Suitability and starting values for cutting speed (vc), feed (f) and depth of cut (ap). Refer to our Machining Calculator app for further calculations.

Product	RE	P			M			K			N			S			H		
		vc	f	ap	vc	f	ap	vc	f	ap	vc	f	ap	vc	f	ap	vc	f	ap
	[mm]	[m/min]	[mm/rev]	[mm]	[m/min]	[mm/rev]	[mm]	[m/min]	[mm/rev]	[mm]	[m/min]	[mm/rev]	[mm]	[m/min]	[mm/rev]	[mm]	[m/min]	[mm/rev]	[mm]

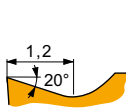

JZ geometry with left-handed design for fine-finish machining, and continuous cuts.

WCGX 020102FL-JZ	TT010	0.2	■	330	0.06	0.5	■	195	0.05	0.5	■	-	-	-	■	-	-	-	■	-	-	-
------------------	-------	-----	---	-----	------	-----	---	-----	------	-----	---	---	---	---	---	---	---	---	---	---	---	---

WCMT

	IC	D1	L	S
	[mm]	[mm]	[mm]	[mm]
06T3	9.525	4.40	6.50	3.97
0804	12.700	5.50	8.70	4.76

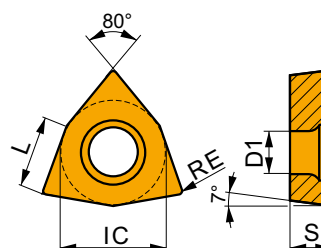

Suitability and starting values for cutting speed (vc), feed (f) and depth of cut (ap). Refer to our Machining Calculator app for further calculations.

Product	RE	P			M			K			N			S			H		
		vc	f	ap	vc	f	ap	vc	f	ap	vc	f	ap	vc	f	ap	vc	f	ap
	[mm]	[m/min]	[mm/rev]	[mm]	[m/min]	[mm/rev]	[mm]	[m/min]	[mm/rev]	[mm]	[m/min]	[mm/rev]	[mm]	[m/min]	[mm/rev]	[mm]	[m/min]	[mm/rev]	[mm]

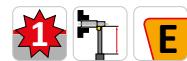
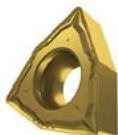

FM geometry for finish to semi-rough machining, and continuous to slightly interrupted cuts.

WCMT 06T304E-FM	T7325	0.4	■	195	0.15	1.2	■	150	0.15	1.2	■	-	-	-	■	-	-	-	■	-	-	-
	T7335	0.4	■	190	0.15	1.2	■	145	0.15	1.2	■	-	-	-	■	-	-	-	■	-	-	-
	T8315	0.4	■	180	0.15	1.2	■	105	0.14	1.2	■	170	0.15	1.2	■	540	0.18	1.2	■	-	-	-
	T8330	0.4	■	170	0.15	1.2	■	100	0.14	1.2	■	160	0.15	1.2	■	510	0.18	1.2	■	-	-	-
	T8430	0.4	■	200	0.15	1.2	■	110	0.14	1.2	■	165	0.15	1.2	■	555	0.18	1.2	■	-	-	-
	T9315	0.4	■	275	0.15	1.2	■	-	-	-	■	260	0.15	1.2	■	-	-	-	■	-	-	-
WCMT 06T308E-FM	T9325	0.4	■	245	0.15	1.2	■	145	0.15	1.2	■	230	0.15	1.2	■	-	-	-	■	-	-	-
	T7325	0.8	■	215	0.20	1.2	■	165	0.18	1.2	■	-	-	-	■	-	-	-	■	-	-	-
	T7335	0.8	■	205	0.20	1.2	■	155	0.18	1.2	■	-	-	-	■	-	-	-	■	-	-	-
	T8315	0.8	■	195	0.20	1.2	■	115	0.18	1.2	■	185	0.20	1.2	■	585	0.24	1.2	■	-	-	-
	T8330	0.8	■	185	0.20	1.2	■	110	0.18	1.2	■	175	0.20	1.2	■	555	0.24	1.2	■	-	-	-
	T8430	0.8	■	210	0.20	1.2	■	115	0.18	1.2	■	175	0.20	1.2	■	585	0.24	1.2	■	-	-	-
	T9315	0.8	■	290	0.20	1.2	■	-	-	-	■	275	0.20	1.2	■	-	-	-	■	-	-	-
T9325	0.8	■	260	0.20	1.2	■	155	0.18	1.2	■	245	0.20	1.2	■	-	-	-	■	-	-	-	



Suitability and starting values for cutting speed (vc), feed (f) and depth of cut (ap). Refer to our Machining Calculator app for further calculations.

Product	RE (mm)	P			M			K			N			S			H		
		vc [m/min]	f [mm/rev]	ap [mm]	vc [m/min]	f [mm/rev]	ap [mm]	vc [m/min]	f [mm/rev]	ap [mm]	vc [m/min]	f [mm/rev]	ap [mm]	vc [m/min]	f [mm/rev]	ap [mm]	vc [m/min]	f [mm/rev]	ap [mm]

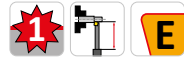
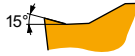
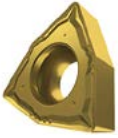

FM geometry for finish to semi-rough machining, and continuous to slightly interrupted cuts.

WCMT 080404E-FM	T7325	0.4	190	0.15	1.7	145	0.15	1.7	-	-	-	-	-	-	-	-	-	-
	T8315	0.4	170	0.15	1.7	100	0.14	1.7	160	0.15	1.7	510	0.18	1.7	-	-	-	-
	T8330	0.4	165	0.15	1.7	95	0.14	1.7	155	0.15	1.7	495	0.18	1.7	-	-	-	-
	T8430	0.4	195	0.15	1.7	105	0.14	1.7	160	0.15	1.7	540	0.18	1.7	-	-	-	-
	T9315	0.4	265	0.15	1.7	-	-	-	250	0.15	1.7	-	-	-	-	-	-	-
	T9325	0.4	240	0.15	1.7	140	0.15	1.7	225	0.15	1.7	-	-	-	-	-	-	-
WCMT 080408E-FM	T7325	0.8	205	0.20	1.7	155	0.18	1.7	-	-	-	-	-	-	-	-	-	-
	T7335	0.8	200	0.20	1.7	155	0.18	1.7	-	-	-	-	-	-	-	-	-	-
	T8315	0.8	190	0.20	1.7	110	0.18	1.7	180	0.20	1.7	570	0.24	1.7	-	-	-	-
	T8330	0.8	180	0.20	1.7	105	0.18	1.7	170	0.20	1.7	540	0.24	1.7	-	-	-	-
	T8430	0.8	205	0.20	1.7	110	0.18	1.7	170	0.20	1.7	570	0.24	1.7	-	-	-	-
	T9315	0.8	280	0.20	1.7	-	-	-	265	0.20	1.7	-	-	-	-	-	-	-
WCMT 080412E-FM	T9325	0.8	250	0.20	1.7	150	0.18	1.7	235	0.20	1.7	-	-	-	-	-	-	-
	T8330	1.2	175	0.27	1.7	105	0.24	1.7	165	0.27	1.7	525	0.32	1.7	-	-	-	-
	T8430	1.2	190	0.27	1.7	105	0.24	1.7	155	0.27	1.7	525	0.32	1.7	-	-	-	-
T9325	1.2	235	0.27	1.7	140	0.24	1.7	220	0.27	1.7	-	-	-	-	-	-	-	

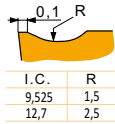

RF geometry for semi-rough to rough machining, and continuous to interrupted cuts.

WCMT 06T308E-RF	T7335	0.8	165	0.20	1.5	125	0.18	1.5	-	-	-	-	-	-	-	-	-
WCMT 080412E-RF	T7335	1.2	160	0.22	2.2	120	0.22	2.2	-	-	-	-	-	-	-	-	-

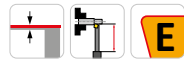
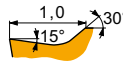

UR geometry for fine to finish machining, and continuous to slightly interrupted cuts.

WCMT 06T308E-UR	T7325	0.8	185	0.20	1.2	140	0.18	1.2	-	-	-	-	-	-	-	-	-
	T9315	0.8	250	0.20	1.2	-	-	-	235	0.20	1.2	-	-	-	-	-	-
	T9325	0.8	225	0.20	1.2	135	0.18	1.2	210	0.20	1.2	-	-	-	-	-	-

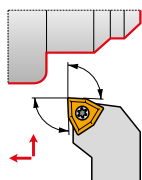

SWLC(RL) EXT

External Screw Lock Tool Holder with 95° Cutting Angle for WC.. Insert

External Right/Left hand tool holder for screw type positive screw type WC.. 06 or 08 inserts. Suited for face and longitudinal turning with shoulder, taper and chamfer turning. Available with shank size 16x16 up to 25x25 mm. Body treated for longer tool life.

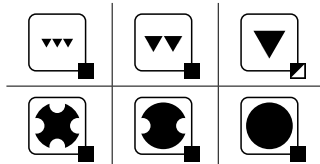
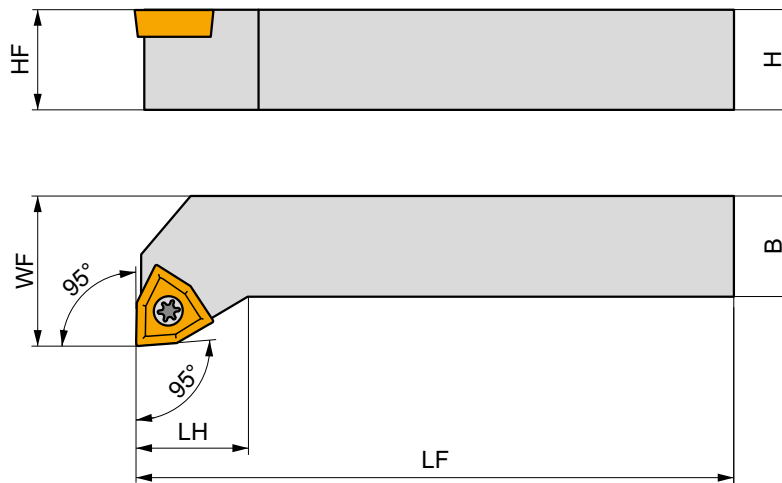

Product	H	B	HF	WF	LF	LH	LAMS	GAMO	kg			
	[mm]	[mm]	[mm]	[mm]	[mm]	[mm]	[°]	[°]				
R	SWLCR 1616 H 06	16	16	16	20	100	15	0	0	0.24	G1055	S04
	SWLCR 2020 K 06	20	20	20	25	125	15	0	0	0.40	G1055	S04
	SWLCR 2525 M 08	25	25	25	32	150	20	0	0	0.77	G1049	S09
L	SWLCL 1616 H 06	16	16	16	20	100	15	0	0	0.23	G1055	S04
	SWLCL 2020 K 06	20	20	20	25	125	15	0	0	0.40	G1055	S04
	SWLCL 2525 M 08	25	25	25	32	150	20	0	0	0.75	G1049	S09



G1049
G1055



WC.. 0804..
WC.. 06T3..



S04
S09



US 3510-T15P
US 4512-T15P



Nm

3.0
5.0



M 3.5
M 4.5



10.6
12.2



FLAGT15P
FLAGT15P



SWLC(RL) INT

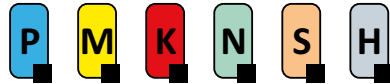

PRAMET

S



Internal Screw Lock Boring Bar with 95° Cutting Angle for WC.. Insert

Internal Right/Left hand boring bar, through coolant available, 95° cutting angle for screw type WC..06 and 08 inserts. Minimum internal turning diameter Ø25 mm. For internal taper and longitudinal turning with shoulder and chamfer turning. Available with shank size Ø20 to Ø32mm. Body treated for longer tool life.

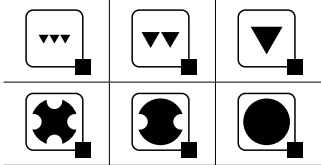
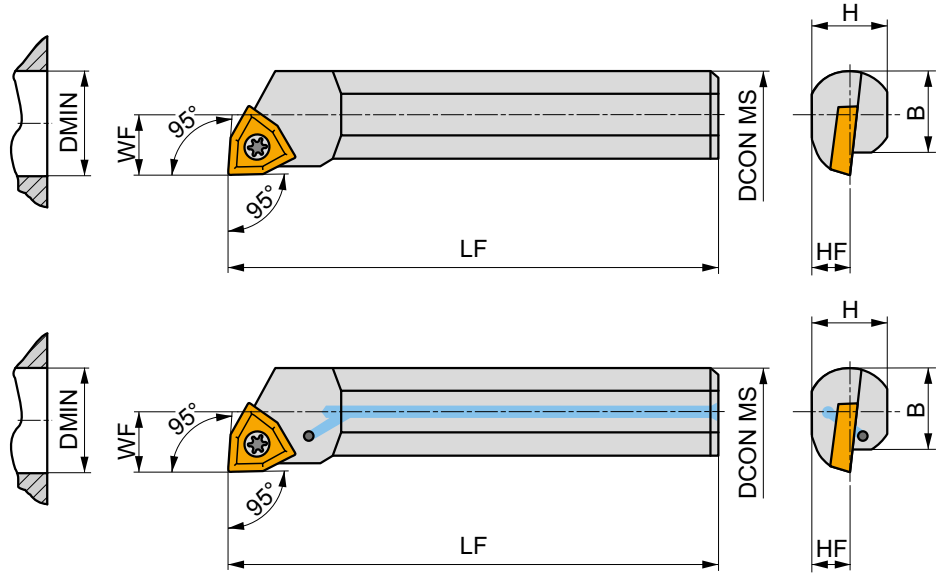
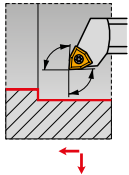

Product	DCON MS	DMIN	WF	H	B	LF	LAMS	GAMO					
	[mm]	[mm]	[mm]	[mm]	[mm]	[mm]	[°]	[°]					
R	A20Q-SWLCR 06	20	25	13	18	18.5	180	-7	0	✓	0.37	GI055	S04
	S20S-SWLCR 06	20	25	13	18	18.5	250	-7	0	-	0.62	GI055	S04
	A25R-SWLCR 06	25	32	17	23	23	200	-7	0	✓	0.70	GI055	S04
	S25T-SWLCR 06	25	32	17	23	23	300	-7	0	-	1.15	GI055	S04
	A25R-SWLCR 08	25	32	17	23	23	200	-7	0	✓	0.70	GI049	S04
	A32S-SWLCR 08	32	40	22	30	30	250	-5	0	✓	1.32	GI049	S09
L	S32U-SWLCR 08	32	40	22	30	30	350	-5	0	-	2.05	GI049	S09
	A20Q-SWLC L 06	20	25	13	18	18.5	180	-7	0	✓	0.00	GI055	S04
	S20S-SWLC L 06	20	25	13	18	18.5	250	-7	0	-	0.60	GI055	S04
	A25R-SWLC L 06	25	32	17	23	23	200	-7	0	✓	0.70	GI055	S04
	S25T-SWLC L 06	25	32	17	23	23	300	-7	0	-	1.15	GI055	S04
	A25R-SWLC L 08	25	32	17	23	23	200	-7	0	✓	0.70	GI049	S04
A32S-SWLC L 08	32	40	22	30	30	250	-5	0	✓	1.32	GI049	S09	
S32U-SWLC L 08	32	40	22	30	30	350	-5	0	-	4.10	GI049	S09	

GI049	WC..0804..
GI055	WC..06T3..

S04	US 3510-T15P	3.0	M 3.5	10.6	FLAGT15P
S09	US 4512-T15P	5.0	M 4.5	12.2	FLAGT15P

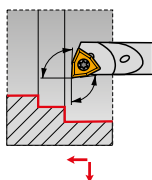

SWUC(RL) INT

Internal Screw Lock Boring Bar with 93° Cutting Angle for WC.. Insert

Internal Right/Left hand boring bar, through coolant available, 93° cutting angle for screw type WC.. 0201 inserts. Minimum internal turning diameter Ø5.8 mm. Suited for internal taper and longitudinal turning with shoulder and chamfer turning. Available with shank size Ø8 mm only. Body treated for longer tool life.

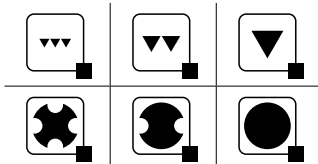
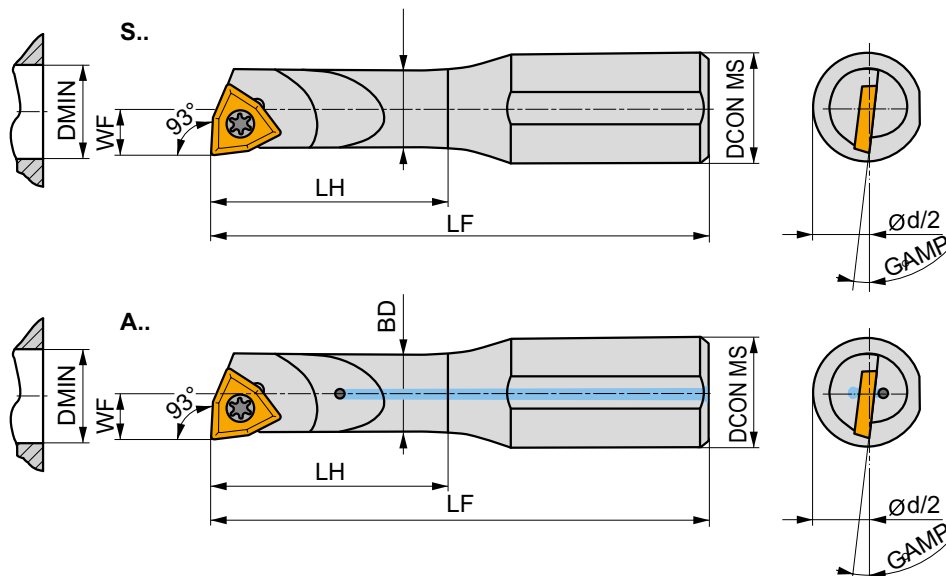

Product	DCON MS	DMIN	BD	WF	LF	LH	GAMP					
	[mm]	[mm]	[mm]	[mm]	[mm]	[mm]	[°]					
R	A0508H-SWUCR 02	8	5.8	5	2.9	100	18	-17	✓	0.09	GI221	SW21
	S0508H-SWUCR 02	8	5.8	5	2.9	100	18	-17	–	0.04	GI221	SW21
	A0608H-SWUCR 02	8	7.8	6	3.9	100	24	-12	✓	0.04	GI221	SW21
	S0608H-SWUCR 02	8	7.8	6	3.9	100	24	-12	–	0.04	GI221	SW21
L	A0508H-SWUCL 02	8	5.8	5	2.9	100	18	-17	✓	0.04	GI221	SW21
	S0508H-SWUCL 02	8	5.8	5	2.9	100	18	-17	–	0.04	GI221	SW21
	A0608H-SWUCL 02	8	7.8	6	3.9	100	24	-12	✓	0.04	GI221	SW21
	S0608H-SWUCL 02	8	7.8	6	3.9	100	24	-12	–	0.04	GI221	SW21



GI221



WC.. 0201..



SW21



T20.037



0.6



M 2



3.7



DMD 1650



SWUC(RL)-E INT

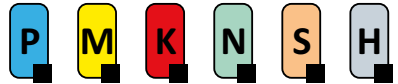

PRAMET

S



Internal carbide Screw Lock Boring Bar with 93° Cutting Angle for WC.. Insert

Internal Right/Left hand carbide boring bar, through coolant, with 93° cutting angle for screw type WC.. 0201 inserts. Minimum internal turning diameter Ø5.8 mm. Suited for internal taper and longitudinal turning with shoulder and chamfer turning. Available with shank size Ø5 up to Ø8 mm. For tool overhang >3xD.

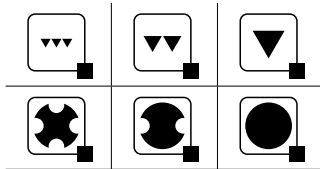
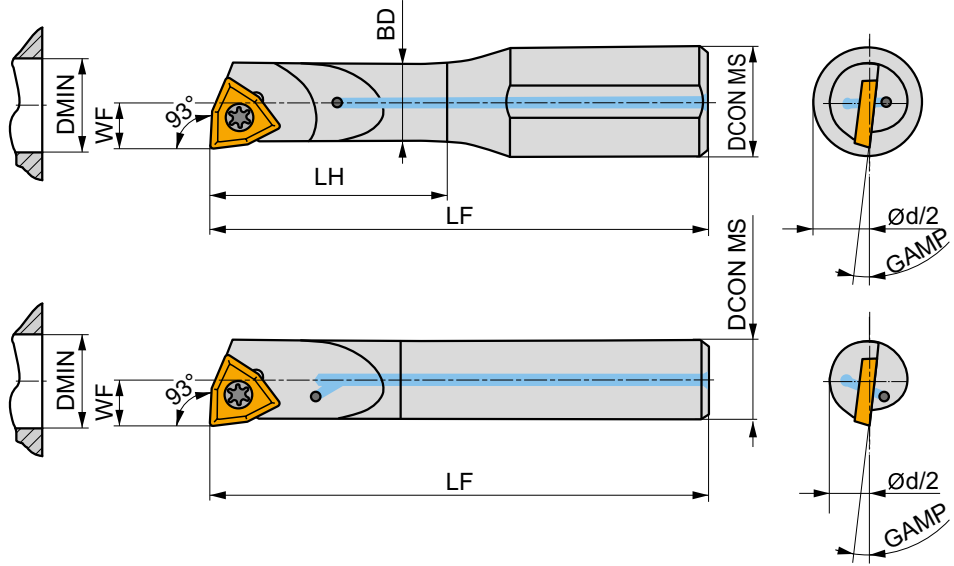
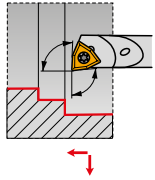

	Product	DCON MS	DMIN	BD	WF	LF	LH	GAMP				
		[mm]	[mm]	[mm]	[mm]	[mm]	[mm]	[°]				
R	E0508H-SWUCR 02	8	5.8	5	2.9	100	24	-17	✓	0.06	G1221	SW21
	E05F-SWUCR 02	5	5.8	-	2.9	85	-	-17	✓	0.03	G1221	SW21
	E0608H-SWUCR 02	8	7.8	6	3.9	100	32	-12	✓	0.06	G1221	SW21
L	E066G-SWUCR 02	6	7.8	-	3.9	95	-	-12	✓	0.04	G1221	SW21
	E0508H-SWUCL 02	8	5.8	5	2.9	100	24	-17	✓	0.07	G1221	SW21
	E05F-SWUCL 02	5	5.8	-	2.9	85	-	-17	✓	0.03	G1221	SW21
	E0608H-SWUCL 02	8	7.8	6	3.9	100	32	-12	✓	0.06	G1221	SW21
	E066G-SWUCL 02	6	7.8	-	3.9	95	-	-12	✓	0.04	G1221	SW21



NEGATIVE INSERTS



CN

09/ 12/ 16/ 19/ 25

CARBIDE INSERTS

CNGG	CNMA	CNMG	CNMM
222	222	223	234

CER AND CBN INSERTS

CNGA CER	CNGN CER	CNGA CBN
238	238	239

MATCH THE RIGHT SIZE (example)

Insert	Tool Holder
CNMM 120412E-OR	DCBNR 2525 M 12

ISO TURNING – EXTERNAL

DCBN(RL) EXT		DCKN(RL) EXT		DCLN(RL) EXT		PCBN(RL) EXT	
75°	CN..	75°	CN..	95°	CN..	75°	CN..
12 16 19		12 16		09 12 16 19		12 16 19 25	
20×20 40×40		20×20 32×32		16×16 40×40		20×20 50×50	
240	222 – 239	242	222 – 239	243	222 – 239	245	222 – 239
PCLN(RL) EXT		PCKN(RL) EXT		C.-DCLN(RL) EXT			
95°	CN..	75°	CN..	95°	CN..		
12 16 19 25		12 16 19		12 16 19			
20×20 50×50		20×20 40×40		C3 C8			
247	222 – 239	246	222 – 239	249	222 – 239		



CN

09/ 12/ 16/ 19/ 25

ISO TURNING – HEAVY ROUGHING – EXTERNAL

KHP-CBNR + DKH(RL)

75°

CN..



25

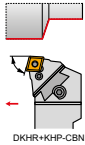

DKHR-KHP-CBNR



40×50
60×80

251, 253

222 – 239

KHP-CBNL + DKH(RL)

75°

CN..



25

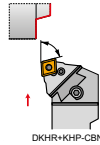

DKHR-KHP-CBNL



40×50
60×80

251, 253

222 – 239

KHP-CLNR/L + DKH(RL)

95°

CN..



19
25

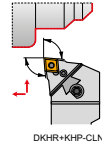

DKHR-KHP-CLNR



40×50
60×80

252, 253

222 – 239

ISO TURNING – INTERNAL

DCLN(RL) INT

95°

CN..



09
12

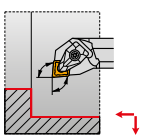

32
50

254

222 – 239

PCLN(RL) INT

95°

CN..



09
12
16
19

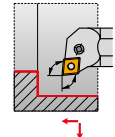

20
80

255

222 – 239

C.-DCLN(RL) INT

95°

CN..



09
12
16

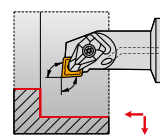

25
50

257

222 – 239



CNGG

	IC	D1	L	S
	[mm]	[mm]	[mm]	[mm]
1204	12.700	5.16	12.90	4.76

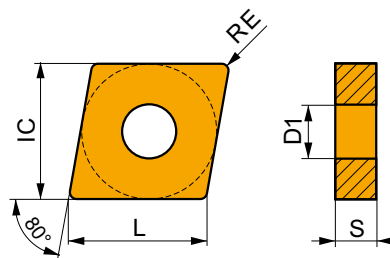

Suitability and starting values for cutting speed (vc), feed (f) and depth of cut (ap). Refer to our Machining Calculator app for further calculations.

Product	RE	P			M			K			N			S			H		
		vc	f	ap	vc	f	ap	vc	f	ap	vc	f	ap	vc	f	ap	vc	f	ap
	[mm]	[m/min]	[mm/rev]	[mm]	[m/min]	[mm/rev]	[mm]	[m/min]	[mm/rev]	[mm]	[m/min]	[mm/rev]	[mm]	[m/min]	[mm/rev]	[mm]	[m/min]	[mm/rev]	[mm]

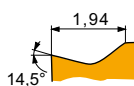

SF geometry with positive design for fine-finish machining of thin walls in continuous cuts.

CNGG 120402E-SF	H07	0.2	–	–	–	105	0.09	1.0	165	0.10	1.0	525	0.12	1.0	50	0.08	0.8	–	–	–
	T6310	0.2	195	0.10	1.0	140	0.09	1.0	155	0.10	1.0	585	0.12	1.0	55	0.08	0.8	35	0.15	1.0
	T8315	0.2	205	0.10	1.0	120	0.09	1.0	190	0.10	1.0	615	0.12	1.0	50	0.08	0.8	40	0.15	1.0
	T8330	0.2	195	0.10	1.0	115	0.09	1.0	185	0.10	1.0	585	0.12	1.0	45	0.08	0.8	35	0.15	1.0
	T8430	0.2	240	0.10	1.0	130	0.09	1.0	195	0.10	1.0	660	0.12	1.0	50	0.08	0.8	40	0.15	1.0

CNMA

	IC	D1	L	S
	[mm]	[mm]	[mm]	[mm]
1204	12.700	5.16	12.90	4.76
1606	15.875	6.35	16.10	6.35
1906	19.050	7.94	19.30	6.35

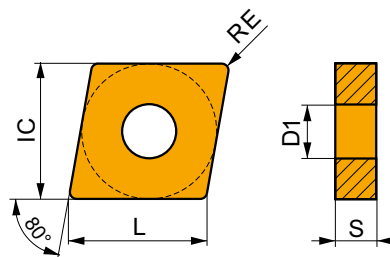

Suitability and starting values for cutting speed (vc), feed (f) and depth of cut (ap). Refer to our Machining Calculator app for further calculations.

Product	RE	P			M			K			N			S			H		
		vc	f	ap	vc	f	ap	vc	f	ap	vc	f	ap	vc	f	ap	vc	f	ap
	[mm]	[m/min]	[mm/rev]	[mm]	[m/min]	[mm/rev]	[mm]	[m/min]	[mm/rev]	[mm]	[m/min]	[mm/rev]	[mm]	[m/min]	[mm/rev]	[mm]	[m/min]	[mm/rev]	[mm]

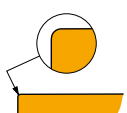
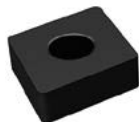

For fine-finish to semi-rough machining, and continuous to slightly interrupted cuts.

CNMA 120404	T5305	0.4	–	–	–	–	–	–	235	0.10	4.0	–	–	–	–	–	–	50	0.15	1.0
	T5315	0.4	–	–	–	–	–	–	200	0.10	4.0	–	–	–	–	–	–	40	0.15	1.0
CNMA 120408	T5305	0.8	–	–	–	–	–	–	220	0.20	4.0	–	–	–	–	–	–	45	0.15	1.0
	T5315	0.8	–	–	–	–	–	–	190	0.20	4.0	–	–	–	–	–	–	40	0.15	1.0
CNMA 120412	T6310	0.8	–	–	–	–	–	–	100	0.20	4.0	–	–	–	–	–	–	25	0.15	1.0
	T5305	1.2	–	–	–	–	–	–	195	0.30	4.0	–	–	–	–	–	–	40	0.15	1.0
CNMA 120416	T5315	1.2	–	–	–	–	–	–	180	0.30	4.0	–	–	–	–	–	–	35	0.15	1.0
	T6310	1.2	–	–	–	–	–	–	95	0.30	4.0	–	–	–	–	–	–	20	0.15	1.0
CNMA 120416	T5305	1.6	–	–	–	–	–	–	190	0.40	4.0	–	–	–	–	–	–	40	0.15	1.0
	T5315	1.6	–	–	–	–	–	–	170	0.40	4.0	–	–	–	–	–	–	35	0.15	1.0



Suitability and starting values for cutting speed (vc), feed (f) and depth of cut (ap). Refer to our Machining Calculator app for further calculations.

Product	RE [mm]	P			M			K			N			S			H		
		vc	f	ap	vc	f	ap	vc	f	ap	vc	f	ap	vc	f	ap	vc	f	ap
		[m/min]	[mm/rev]	[mm]	[m/min]	[mm/rev]	[mm]	[m/min]	[mm/rev]	[mm]	[m/min]	[mm/rev]	[mm]	[m/min]	[mm/rev]	[mm]	[m/min]	[mm/rev]	[mm]

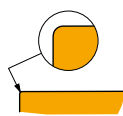

For fine-finish to semi-rough machining, and continuous to slightly interrupted cuts.

CNMA 160612	T5305	1.2	–	–	–	–	–	–	■	190	0.30	5.0	–	–	–	–	–	–	☑	40	0.15	1.0
	T5315	1.2	–	–	–	–	–	–	■	175	0.30	5.0	–	–	–	–	–	–	☑	35	0.15	1.0
	T6310	1.2	–	–	–	–	–	–	■	90	0.30	5.0	–	–	–	–	–	–	☑	20	0.15	1.0
CNMA 160616	T5305	1.6	–	–	–	–	–	–	■	185	0.40	5.0	–	–	–	–	–	–	☑	35	0.15	1.0
	T5315	1.6	–	–	–	–	–	–	■	165	0.40	5.0	–	–	–	–	–	–	☑	35	0.15	1.0
CNMA 190612	T5305	1.2	–	–	–	–	–	–	■	190	0.30	6.0	–	–	–	–	–	–	☑	40	0.15	1.0
	T5315	1.2	–	–	–	–	–	–	■	170	0.30	6.0	–	–	–	–	–	–	☑	35	0.15	1.0
	T6310	1.2	–	–	–	–	–	–	■	85	0.30	6.0	–	–	–	–	–	–	☑	20	0.15	1.0
CNMA 190616	T5305	1.6	–	–	–	–	–	–	■	180	0.40	6.0	–	–	–	–	–	–	☑	35	0.15	1.0
	T5315	1.6	–	–	–	–	–	–	■	160	0.40	6.0	–	–	–	–	–	–	☑	30	0.15	1.0

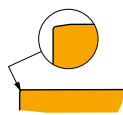
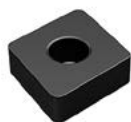

For fine-finish to semi-rough machining, and continuous to slightly interrupted cuts.

CNMA 120408S	T5305	0.8	–	–	–	–	–	–	■	220	0.20	4.0	–	–	–	–	–	–	☑	45	0.15	1.0
CNMA 120412S	T5305	1.2	–	–	–	–	–	–	■	190	0.40	4.0	–	–	–	–	–	–	☑	40	0.15	1.0
CNMA 160612S	T5305	1.2	–	–	–	–	–	–	■	190	0.30	5.0	–	–	–	–	–	–	☑	40	0.15	1.0
CNMA 190616S	T5305	1.6	–	–	–	–	–	–	■	180	0.40	6.0	–	–	–	–	–	–	☑	35	0.15	1.0

CNMG



	IC [mm]	D1 [mm]	L [mm]	S [mm]
0903	9.525	3.81	9.70	3.18
1204	12.700	5.16	12.90	4.76
1606	15.880	6.35	16.10	6.35
1906	19.050	7.94	19.30	6.35
2509	25.400	9.12	25.80	9.53

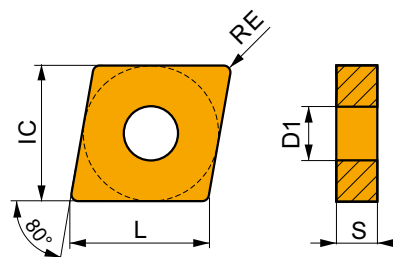

Suitability and starting values for cutting speed (vc), feed (f) and depth of cut (ap). Refer to our Machining Calculator app for further calculations.

Product	RE [mm]	P			M			K			N			S			H		
		vc	f	ap	vc	f	ap	vc	f	ap	vc	f	ap	vc	f	ap	vc	f	ap
		[m/min]	[mm/rev]	[mm]	[m/min]	[mm/rev]	[mm]	[m/min]	[mm/rev]	[mm]	[m/min]	[mm/rev]	[mm]	[m/min]	[mm/rev]	[mm]	[m/min]	[mm/rev]	[mm]

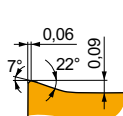
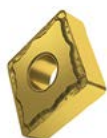

FF geometry with highly positive design for fine-finish machining, and continuous to slightly interrupted cuts.

CNMG 120404E-FF	T7325	0.4	☑	235	0.12	1.0	■	180	0.11	1.0	■	–	–	–	–	–	–	–	–	–	–
	T8315	0.4	☑	220	0.12	1.0	■	130	0.11	1.0	☑	205	0.12	1.0	–	–	–	–	–	–	–
CNMG 120408E-FF	T7325	0.8	☑	265	0.15	1.0	■	205	0.14	1.0	■	–	–	–	–	–	–	–	–	–	–
	T8315	0.8	☑	245	0.15	1.0	■	145	0.14	1.0	☑	230	0.15	1.0	–	–	–	–	–	–	–



Suitability and starting values for cutting speed (vc), feed (f) and depth of cut (ap). Refer to our Machining Calculator app for further calculations.

Product	RE (mm)	P			M			K			N			S			H		
		vc [m/min]	f [mm/rev]	ap [mm]	vc [m/min]	f [mm/rev]	ap [mm]	vc [m/min]	f [mm/rev]	ap [mm]	vc [m/min]	f [mm/rev]	ap [mm]	vc [m/min]	f [mm/rev]	ap [mm]	vc [m/min]	f [mm/rev]	ap [mm]

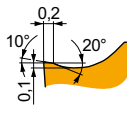

FM geometry with positive design for finish to semi-rough machining, and continuous to slightly interrupted cuts.

CNMG 090304E-FM	T7325	0.4	195	0.20	1.4	150	0.18	1.4	-	-	-	60	0.16	1.1	-	-	-
	T8330	0.4	175	0.20	1.4	105	0.18	1.4	165	0.20	1.4	40	0.14	1.1	-	-	-
	T8430	0.4	195	0.20	1.4	105	0.18	1.4	160	0.20	1.4	40	0.14	1.1	-	-	-
	T9315	0.4	265	0.20	1.4	-	-	-	250	0.20	1.4	-	-	-	-	-	-
	T9325	0.4	240	0.20	1.4	140	0.18	1.4	225	0.20	1.4	50	0.16	1.1	-	-	-
CNMG 090308E-FM	T7325	0.8	235	0.20	1.4	180	0.18	1.4	-	-	-	75	0.16	1.1	-	-	-
	T8330	0.8	205	0.20	1.4	120	0.18	1.4	190	0.20	1.4	50	0.14	1.1	-	-	-
	T8430	0.8	235	0.20	1.4	125	0.18	1.4	190	0.20	1.4	50	0.14	1.1	-	-	-
	T9315	0.8	315	0.20	1.4	-	-	-	295	0.20	1.4	-	-	-	-	-	-
	T9325	0.8	285	0.20	1.4	170	0.18	1.4	270	0.20	1.4	60	0.16	1.1	-	-	-
CNMG 120404E-FM	T7325	0.4	185	0.20	2.1	140	0.18	2.1	-	-	-	60	0.16	1.7	-	-	-
	T7335	0.4	180	0.20	2.1	140	0.18	2.1	-	-	-	55	0.16	1.7	-	-	-
	T8315	0.4	175	0.20	2.1	105	0.18	2.1	165	0.20	2.1	40	0.14	1.7	-	-	-
	T8330	0.4	165	0.20	2.1	95	0.18	2.1	155	0.20	2.1	40	0.14	1.7	-	-	-
	T8430	0.4	190	0.20	2.1	105	0.18	2.1	155	0.20	2.1	40	0.14	1.7	-	-	-
	T9310	0.4	285	0.20	2.1	-	-	-	270	0.20	2.1	-	-	-	-	-	-
	T9315	0.4	255	0.20	2.1	-	-	-	240	0.20	2.1	-	-	-	-	-	-
	T9325	0.4	230	0.20	2.1	135	0.18	2.1	215	0.20	2.1	50	0.16	1.7	-	-	-
CNMG 120408E-FM	TT310	0.4	260	0.20	2.1	155	0.18	2.1	-	-	-	-	-	-	-	-	-
	T7325	0.8	220	0.20	2.1	170	0.18	2.1	-	-	-	70	0.16	1.7	-	-	-
	T7335	0.8	215	0.20	2.1	165	0.18	2.1	-	-	-	65	0.16	1.7	-	-	-
	T8315	0.8	205	0.20	2.1	120	0.18	2.1	190	0.20	2.1	50	0.16	1.7	-	-	-
	T8330	0.8	195	0.20	2.1	115	0.18	2.1	185	0.20	2.1	45	0.16	1.7	-	-	-
	T8430	0.8	225	0.20	2.1	120	0.18	2.1	185	0.20	2.1	45	0.16	1.7	-	-	-
	T9310	0.8	335	0.20	2.1	-	-	-	315	0.20	2.1	-	-	-	-	-	-
	T9315	0.8	305	0.20	2.1	-	-	-	285	0.20	2.1	-	-	-	-	-	-
CNMG 120412E-FM	T9325	0.8	275	0.20	2.1	165	0.18	2.1	260	0.20	2.1	60	0.16	1.7	-	-	-
	TT310	0.8	310	0.20	2.1	185	0.18	2.1	-	-	-	-	-	-	-	-	
	T7325	1.2	210	0.27	2.1	160	0.24	2.1	-	-	-	65	0.19	1.7	-	-	-
	T9315	1.2	285	0.27	2.1	-	-	-	270	0.27	2.1	-	-	-	-	-	-
	T9325	1.2	255	0.27	2.1	150	0.24	2.1	240	0.27	2.1	55	0.19	1.7	-	-	-

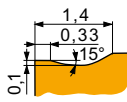

KR geometry for semi-rough to rough machining, and continuous to interrupted cuts.

CNMG 120408E-KR	T5305	0.8	255	0.35	4.0	-	-	-	240	0.35	4.0	50	0.15	1.0	-	-	-
	T5315	0.8	225	0.35	4.0	-	-	-	210	0.35	4.0	45	0.15	1.0	-	-	-
CNMG 120412E-KR	T5305	1.2	255	0.40	4.0	-	-	-	240	0.40	4.0	50	0.15	1.0	-	-	-
	T5315	1.2	230	0.40	4.0	-	-	-	215	0.40	4.0	45	0.15	1.0	-	-	-

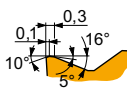

M geometry for finish to semi-rough machining, and continuous to interrupted cuts.

CNMG 090308E-M	T9315	0.8	230	0.32	1.8	-	-	-	215	0.32	1.8	45	0.15	1.0	-	-	-
	T9325	0.8	205	0.32	1.8	-	-	-	190	0.32	1.8	-	-	-	-	-	-
	T9335	0.8	180	0.32	1.8	-	-	-	-	-	-	-	-	-	-	-	-
CNMG 120404E-M	T5315	0.4	245	0.20	2.1	-	-	-	230	0.20	2.1	45	0.15	1.0	-	-	-
	T9310	0.4	260	0.20	2.1	-	-	-	245	0.20	2.1	50	0.15	1.0	-	-	-
	T9315	0.4	235	0.20	2.1	-	-	-	220	0.20	2.1	45	0.15	1.0	-	-	-
	T9325	0.4	210	0.20	2.1	-	-	-	195	0.20	2.1	-	-	-	-	-	-
	T9335	0.4	180	0.20	2.1	-	-	-	-	-	-	-	-	-	-	-	-



Suitability and starting values for cutting speed (vc), feed (f) and depth of cut (ap). Refer to our Machining Calculator app for further calculations.

Product	RE (mm)	P			M			K			N			S			H		
		vc (m/min)	f (mm/rev)	ap (mm)	vc (m/min)	f (mm/rev)	ap (mm)	vc (m/min)	f (mm/rev)	ap (mm)	vc (m/min)	f (mm/rev)	ap (mm)	vc (m/min)	f (mm/rev)	ap (mm)	vc (m/min)	f (mm/rev)	ap (mm)

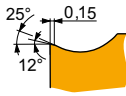

NF geometry with highly positive design for fine-finish to medium machining, and continuous cuts.

CNMG 120404E-NF	HF7	0.4	–	–	–	95	0.15	1.7	155	0.17	1.7	495	0.20	1.7	–	–	–	–	–	–
	T6310	0.4	180	0.17	1.7	125	0.15	1.7	145	0.17	1.7	540	0.20	1.7	50	0.14	1.4	–	–	–
	T7325	0.4	200	0.18	1.7	155	0.16	1.7	–	–	–	–	–	–	65	0.16	1.4	–	–	–
	T7335	0.4	195	0.18	1.7	150	0.16	1.7	–	–	–	–	–	–	60	0.16	1.4	–	–	–
	T8315	0.4	185	0.17	1.7	110	0.15	1.7	175	0.17	1.7	555	0.20	1.7	45	0.14	1.4	–	–	–
	T8330	0.4	180	0.17	1.7	105	0.15	1.7	170	0.17	1.7	540	0.20	1.7	45	0.14	1.4	–	–	–
	T8430	0.4	200	0.17	1.7	110	0.15	1.7	165	0.17	1.7	555	0.20	1.7	40	0.14	1.4	–	–	–
	T9315	0.4	285	0.17	1.7	–	–	–	270	0.17	1.7	–	–	–	–	–	–	–	–	–
	T9325	0.4	250	0.18	1.7	150	0.16	1.7	235	0.18	1.7	–	–	–	55	0.16	1.4	–	–	–
CNMG 120408E-NF	HF7	0.8	–	–	–	110	0.17	1.7	180	0.19	1.7	570	0.23	1.7	–	–	–	–	–	–
	T6310	0.8	200	0.19	1.7	140	0.17	1.7	160	0.19	1.7	600	0.23	1.7	60	0.15	1.4	–	–	–
	T7325	0.8	235	0.19	1.7	180	0.17	1.7	–	–	–	–	–	75	0.15	1.4	–	–	–	
	T7335	0.8	225	0.19	1.7	175	0.17	1.7	–	–	–	–	–	70	0.15	1.4	–	–	–	
	T8315	0.8	215	0.19	1.7	125	0.17	1.7	200	0.19	1.7	645	0.23	1.7	50	0.15	1.4	–	–	–
	T8330	0.8	200	0.19	1.7	120	0.17	1.7	190	0.19	1.7	600	0.23	1.7	50	0.15	1.4	–	–	–
	T8430	0.8	235	0.19	1.7	125	0.17	1.7	190	0.19	1.7	645	0.23	1.7	50	0.15	1.4	–	–	–
	T9315	0.8	320	0.19	1.7	–	–	–	300	0.19	1.7	–	–	–	–	–	–	–	–	–
	T9325	0.8	285	0.19	1.7	170	0.17	1.7	270	0.19	1.7	–	–	–	60	0.15	1.4	–	–	–
CNMG 120412E-NF	T6310	1.2	185	0.30	2.1	130	0.27	2.1	145	0.30	2.1	555	0.36	2.1	55	0.21	1.7	–	–	–
	T7325	1.2	205	0.30	2.1	155	0.27	2.1	–	–	–	–	–	65	0.21	1.7	–	–	–	
	T7335	1.2	200	0.30	2.1	155	0.27	2.1	–	–	–	–	–	65	0.21	1.7	–	–	–	
	T8330	1.2	185	0.30	2.1	110	0.27	2.1	175	0.30	2.1	555	0.36	2.1	45	0.21	1.7	–	–	–
	T8430	1.2	200	0.30	2.1	110	0.27	2.1	165	0.30	2.1	555	0.36	2.1	40	0.21	1.7	–	–	–
	T9315	1.2	275	0.30	2.1	–	–	–	260	0.30	2.1	–	–	–	–	–	–	–	–	–
	T9325	1.2	245	0.30	2.1	145	0.27	2.1	230	0.30	2.1	–	–	–	55	0.21	1.7	–	–	–

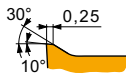

NM geometry with highly positive design for fine-finish, medium and rough machining, with continuous cuts.

CNMG 120404E-NM	T7325	0.4	195	0.20	2.1	150	0.18	2.1	–	–	–	–	–	60	0.16	1.7	–	–	–	
	T7335	0.4	190	0.20	2.1	145	0.18	2.1	–	–	–	–	–	60	0.16	1.7	–	–	–	
	T8315	0.4	180	0.20	2.1	105	0.18	2.1	–	–	–	540	0.24	2.1	45	0.16	1.7	–	–	–
	T8330	0.4	170	0.20	2.1	100	0.18	2.1	–	–	–	510	0.24	2.1	40	0.16	1.7	–	–	–
	T8430	0.4	195	0.20	2.1	105	0.18	2.1	–	–	–	540	0.24	2.1	40	0.16	1.7	–	–	–
	T9315	0.4	270	0.20	2.1	–	–	–	–	–	–	–	–	–	–	–	–	–	–	–
	T9325	0.4	240	0.20	2.1	140	0.18	2.1	–	–	–	–	–	–	50	0.16	1.7	–	–	–
CNMG 120408E-NM	T7325	0.8	215	0.25	2.1	165	0.23	2.1	–	–	–	–	–	65	0.20	1.7	–	–	–	
	T7335	0.8	210	0.25	2.1	160	0.23	2.1	–	–	–	–	–	65	0.20	1.7	–	–	–	
	T8315	0.8	205	0.25	2.1	120	0.23	2.1	–	–	–	615	0.30	2.1	50	0.20	1.7	–	–	–
	T8330	0.8	195	0.25	2.1	115	0.23	2.1	–	–	–	585	0.30	2.1	45	0.20	1.7	–	–	–
	T8430	0.8	210	0.25	2.1	115	0.23	2.1	–	–	–	585	0.30	2.1	45	0.20	1.7	–	–	–
	T9315	0.8	290	0.25	2.1	–	–	–	–	–	–	–	–	–	–	–	–	–	–	–
	T9325	0.8	260	0.25	2.1	155	0.23	2.1	–	–	–	–	–	–	55	0.20	1.7	–	–	–
CNMG 120412E-NM	T7325	1.2	215	0.30	2.1	165	0.27	2.1	–	–	–	–	–	65	0.24	1.7	–	–	–	
	T7335	1.2	210	0.30	2.1	160	0.27	2.1	–	–	–	–	–	65	0.24	1.7	–	–	–	
	T8315	1.2	205	0.30	2.1	120	0.27	2.1	–	–	–	615	0.36	2.1	50	0.24	1.7	–	–	–
	T8330	1.2	195	0.30	2.1	115	0.27	2.1	–	–	–	585	0.36	2.1	45	0.24	1.7	–	–	–
	T8430	1.2	210	0.30	2.1	115	0.27	2.1	–	–	–	585	0.36	2.1	45	0.24	1.7	–	–	–
	T9315	1.2	285	0.30	2.1	–	–	–	–	–	–	–	–	–	–	–	–	–	–	–
	T9325	1.2	255	0.30	2.1	150	0.27	2.1	–	–	–	–	–	–	55	0.24	1.7	–	–	–
CNMG 160608E-NM	T7325	0.8	195	0.30	3.6	150	0.27	3.6	–	–	–	–	–	60	0.27	2.9	–	–	–	
	T7335	0.8	190	0.30	3.6	145	0.27	3.6	–	–	–	–	–	60	0.27	2.9	–	–	–	
	T8315	0.8	185	0.30	3.6	110	0.27	3.6	–	–	–	555	0.36	3.6	45	0.27	2.9	–	–	–
	T8330	0.8	170	0.30	3.6	100	0.27	3.6	–	–	–	510	0.36	3.6	40	0.27	2.9	–	–	–
	T8430	0.8	185	0.30	3.6	100	0.27	3.6	–	–	–	510	0.36	3.6	40	0.27	2.9	–	–	–
	T9325	0.8	225	0.30	3.6	135	0.27	3.6	–	–	–	–	–	–	50	0.27	2.9	–	–	–



Suitability and starting values for cutting speed (vc), feed (f) and depth of cut (ap). Refer to our Machining Calculator app for further calculations.

Product	RE [mm]	P			M			K			N			S			H		
		vc	f	ap	vc	f	ap	vc	f	ap	vc	f	ap	vc	f	ap	vc	f	ap
		[m/min]	[mm/rev]	[mm]	[m/min]	[mm/rev]	[mm]	[m/min]	[mm/rev]	[mm]	[m/min]	[mm/rev]	[mm]	[m/min]	[mm/rev]	[mm]	[m/min]	[mm/rev]	[mm]

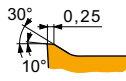

NM geometry with highly positive design for fine-finish, medium and rough machining, with continuous cuts.

CNMG 160612E-NM	T7325	1.2	205	0.30	3.6	155	0.27	3.6	-	-	-	-	-	-	65	0.27	2.9	-	-	-
	T7335	1.2	200	0.30	3.6	155	0.27	3.6	-	-	-	-	-	-	65	0.27	2.9	-	-	-
	T8315	1.2	195	0.30	3.6	115	0.27	3.6	-	-	-	585	0.36	3.6	45	0.27	2.9	-	-	-
CNMG 190612E-NM	T9325	1.2	240	0.30	3.6	140	0.27	3.6	-	-	-	-	-	-	50	0.27	2.9	-	-	-
	T7325	1.2	195	0.35	4.2	150	0.32	4.2	-	-	-	-	-	-	60	0.32	3.4	-	-	-
	T7335	1.2	180	0.35	4.2	140	0.32	4.2	-	-	-	-	-	-	55	0.32	3.4	-	-	-
	T8315	1.2	180	0.35	4.2	105	0.32	4.2	-	-	-	540	0.42	4.2	45	0.32	3.4	-	-	-
	T8330	1.2	170	0.35	4.2	100	0.32	4.2	-	-	-	510	0.42	4.2	40	0.32	3.4	-	-	-
T8430	1.2	180	0.35	4.2	95	0.32	4.2	-	-	-	495	0.42	4.2	35	0.32	3.4	-	-	-	
T9325	1.2	220	0.35	4.2	130	0.32	4.2	-	-	-	-	-	-	45	0.32	3.4	-	-	-	

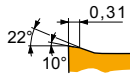

NMR geometry with positive design for medium to rough machining, and continuous cuts.

CNMG 090308E-NMR	T7325	0.8	175	0.35	1.6	135	0.32	1.6	-	-	-	-	-	-	55	0.25	1.3	-	-	-
	T7335	0.8	170	0.35	1.6	130	0.32	1.6	-	-	-	-	-	-	55	0.25	1.3	-	-	-
	T9325	0.8	200	0.35	1.6	120	0.32	1.6	-	-	-	-	-	-	45	0.25	1.3	-	-	-
CNMG 120404E-NMR	T6310	0.4	140	0.25	2.7	100	0.23	2.7	-	-	-	-	-	-	40	0.20	2.2	-	-	-
	T7325	0.4	155	0.25	2.7	120	0.23	2.7	-	-	-	-	-	-	50	0.20	2.2	-	-	-
	T7335	0.4	155	0.25	2.0	120	0.23	2.0	-	-	-	-	-	-	50	0.20	1.6	-	-	-
	T8330	0.4	140	0.25	2.0	80	0.23	2.0	-	-	-	-	-	-	35	0.20	1.6	-	-	-
	T8430	0.4	150	0.25	2.7	80	0.23	2.7	-	-	-	-	-	-	30	0.20	2.2	-	-	-
	T9315	0.4	215	0.25	2.0	-	-	-	-	-	-	-	-	-	-	-	-	-	-	-
T9325	0.4	190	0.25	2.0	110	0.23	2.0	-	-	-	-	-	-	40	0.20	1.6	-	-	-	
CNMG 120408E-NMR	T6310	0.8	150	0.35	2.7	105	0.32	2.7	-	-	-	-	-	-	45	0.25	2.2	-	-	-
	T7325	0.8	170	0.35	2.7	130	0.32	2.7	-	-	-	-	-	-	55	0.25	2.2	-	-	-
	T7335	0.8	160	0.35	2.7	120	0.32	2.7	-	-	-	-	-	-	50	0.25	2.2	-	-	-
	T8330	0.8	150	0.35	2.7	90	0.32	2.7	-	-	-	-	-	-	35	0.25	2.2	-	-	-
	T8430	0.8	155	0.35	2.7	85	0.32	2.7	-	-	-	-	-	-	30	0.25	2.2	-	-	-
	T9315	0.8	210	0.35	2.7	-	-	-	-	-	-	-	-	-	-	-	-	-	-	-
T9325	0.8	190	0.35	2.7	110	0.32	2.7	-	-	-	-	-	-	40	0.25	2.2	-	-	-	
CNMG 120412E-NMR	T6310	1.2	150	0.40	2.7	105	0.36	2.7	-	-	-	-	-	-	45	0.28	2.2	-	-	-
	T7325	1.2	170	0.40	2.7	130	0.36	2.7	-	-	-	-	-	-	55	0.28	2.2	-	-	-
	T7335	1.2	160	0.40	2.7	120	0.36	2.7	-	-	-	-	-	-	50	0.28	2.2	-	-	-
	T8330	1.2	150	0.40	2.7	90	0.36	2.7	-	-	-	-	-	-	35	0.28	2.2	-	-	-
	T8430	1.2	155	0.40	2.7	85	0.36	2.7	-	-	-	-	-	-	30	0.28	2.2	-	-	-
T9315	1.2	215	0.40	2.7	-	-	-	-	-	-	-	-	-	-	-	-	-	-	-	
T9325	1.2	190	0.40	2.7	110	0.36	2.7	-	-	-	-	-	-	40	0.28	2.2	-	-	-	
CNMG 120416E-NMR	T7325	1.6	170	0.45	2.7	130	0.41	2.7	-	-	-	-	-	-	55	0.32	2.2	-	-	-
	T7335	1.6	160	0.45	2.7	120	0.41	2.7	-	-	-	-	-	-	50	0.32	2.2	-	-	-
	T9325	1.6	190	0.45	2.7	110	0.41	2.7	-	-	-	-	-	-	40	0.32	2.2	-	-	-
CNMG 160608E-NMR	T7325	0.8	160	0.35	4.0	120	0.32	4.0	-	-	-	-	-	-	50	0.25	3.2	-	-	-
	T7335	0.8	150	0.35	4.0	115	0.32	4.0	-	-	-	-	-	-	45	0.25	3.2	-	-	-
	T9315	0.8	205	0.35	4.0	-	-	-	-	-	-	-	-	-	-	-	-	-	-	-
	T9325	0.8	185	0.35	4.0	110	0.32	4.0	-	-	-	-	-	-	40	0.25	3.2	-	-	-
CNMG 160612E-NMR	T7325	1.2	165	0.40	4.0	125	0.36	4.0	-	-	-	-	-	-	50	0.28	3.2	-	-	-
	T7335	1.2	155	0.40	4.0	120	0.36	4.0	-	-	-	-	-	-	50	0.28	3.2	-	-	-
	T8330	1.2	145	0.40	4.0	85	0.36	4.0	-	-	-	-	-	-	35	0.28	3.2	-	-	-
	T8430	1.2	150	0.40	4.0	80	0.36	4.0	-	-	-	-	-	-	30	0.28	3.2	-	-	-
	T9315	1.2	205	0.40	4.0	-	-	-	-	-	-	-	-	-	-	-	-	-	-	-
	T9325	1.2	185	0.40	4.0	110	0.36	4.0	-	-	-	-	-	-	40	0.28	3.2	-	-	-



Suitability and starting values for cutting speed (vc), feed (f) and depth of cut (ap). Refer to our Machining Calculator app for further calculations.

Product	RE (mm)	P			M			K			N			S			H		
		vc (m/min)	f (mm/rev)	ap (mm)	vc (m/min)	f (mm/rev)	ap (mm)	vc (m/min)	f (mm/rev)	ap (mm)	vc (m/min)	f (mm/rev)	ap (mm)	vc (m/min)	f (mm/rev)	ap (mm)	vc (m/min)	f (mm/rev)	ap (mm)

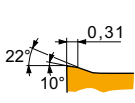

NMR geometry with positive design for medium to rough machining, and continuous cuts.

CNMG 160616E-NMR	T7325	1.6	165	0.45	4.0	125	0.41	4.0	-	-	-	-	-	-	50	0.32	3.2	-	-	-	
	T7335	1.6	155	0.45	4.0	120	0.41	4.0	-	-	-	-	-	-	50	0.32	3.2	-	-	-	
	T8330	1.6	145	0.45	4.0	85	0.41	4.0	-	-	-	-	-	-	35	0.32	3.2	-	-	-	
	T8430	1.6	150	0.45	4.0	80	0.41	4.0	-	-	-	-	-	-	30	0.32	3.2	-	-	-	
	T9315	1.6	200	0.45	4.0	-	-	-	-	-	-	-	-	-	-	-	-	-	-	-	-
CNMG 190608E-NMR	T9325	1.6	180	0.45	4.0	105	0.41	4.0	-	-	-	-	-	-	40	0.32	3.2	-	-	-	
	T6310	0.8	140	0.35	5.2	100	0.32	5.2	-	-	-	-	-	-	40	0.25	4.2	-	-	-	
	T7325	0.8	155	0.35	5.2	120	0.32	5.2	-	-	-	-	-	-	50	0.25	4.2	-	-	-	
	T7335	0.8	150	0.35	5.2	115	0.32	5.2	-	-	-	-	-	-	45	0.25	4.2	-	-	-	
	T9315	0.8	195	0.35	5.2	-	-	-	-	-	-	-	-	-	-	-	-	-	-	-	-
CNMG 190612E-NMR	T9325	0.8	180	0.35	5.2	105	0.32	5.2	-	-	-	-	-	-	40	0.25	4.2	-	-	-	
	T6310	1.2	140	0.40	5.2	100	0.36	5.2	-	-	-	-	-	-	40	0.28	4.2	-	-	-	
	T7325	1.2	160	0.40	5.2	120	0.36	5.2	-	-	-	-	-	-	50	0.28	4.2	-	-	-	
	T7335	1.2	150	0.40	5.2	115	0.36	5.2	-	-	-	-	-	-	45	0.28	4.2	-	-	-	
	T8330	1.2	140	0.40	5.2	80	0.36	5.2	-	-	-	-	-	-	35	0.28	4.2	-	-	-	
	T8430	1.2	145	0.40	5.2	80	0.36	5.2	-	-	-	-	-	-	30	0.28	4.2	-	-	-	
	T9315	1.2	200	0.40	5.2	-	-	-	-	-	-	-	-	-	-	-	-	-	-	-	-
CNMG 190616E-NMR	T9325	1.2	180	0.40	5.2	105	0.36	5.2	-	-	-	-	-	-	40	0.28	4.2	-	-	-	
	T7325	1.6	160	0.45	5.2	120	0.41	5.2	-	-	-	-	-	-	50	0.32	4.2	-	-	-	
	T7335	1.6	150	0.45	5.2	115	0.41	5.2	-	-	-	-	-	-	45	0.32	4.2	-	-	-	
	T9315	1.6	195	0.45	5.2	-	-	-	-	-	-	-	-	-	-	-	-	-	-	-	-
	T9325	1.6	175	0.45	5.2	105	0.41	5.2	-	-	-	-	-	-	35	0.32	4.2	-	-	-	

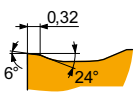

NRM geometry with positive design for semi-rough to rough machining, and continuous to moderate interrupted cuts.

CNMG 120408-NRM	T7325	0.8	160	0.35	4.0	120	0.32	4.0	-	-	-	-	-	-	50	0.28	3.2	-	-	-
	T7335	0.8	150	0.35	4.0	115	0.32	4.0	-	-	-	-	-	-	45	0.28	3.2	-	-	-
	T9315	0.8	205	0.35	4.0	-	-	-	-	-	-	-	-	-	-	-	-	-	-	-
CNMG 120412-NRM	T7325	1.2	165	0.40	4.0	125	0.36	4.0	-	-	-	-	-	-	50	0.28	3.2	-	-	-
	T7335	1.2	155	0.40	4.0	120	0.36	4.0	-	-	-	-	-	-	50	0.28	3.2	-	-	-
	T9315	1.2	205	0.40	4.0	-	-	-	-	-	-	-	-	-	-	-	-	-	-	-
CNMG 120416-NRM	T7325	1.6	165	0.45	4.0	125	0.41	4.0	-	-	-	-	-	-	50	0.36	3.2	-	-	-
	T7335	1.6	155	0.45	4.0	120	0.41	4.0	-	-	-	-	-	-	50	0.36	3.2	-	-	-
	T9315	1.6	200	0.45	4.0	-	-	-	-	-	-	-	-	-	-	-	-	-	-	-
CNMG 160608-NRM	T7325	0.8	155	0.35	6.0	120	0.32	6.0	-	-	-	-	-	-	50	0.28	4.8	-	-	-
	T7335	0.8	145	0.35	6.0	110	0.32	6.0	-	-	-	-	-	-	45	0.28	4.8	-	-	-
	T9315	0.8	195	0.35	6.0	-	-	-	-	-	-	-	-	-	-	-	-	-	-	-
CNMG 160612-NRM	T7325	1.2	155	0.40	6.0	120	0.36	6.0	-	-	-	-	-	-	50	0.32	4.8	-	-	-
	T7335	1.2	150	0.40	6.0	115	0.36	6.0	-	-	-	-	-	-	45	0.32	4.8	-	-	-
	T9315	1.2	200	0.40	6.0	-	-	-	-	-	-	-	-	-	-	-	-	-	-	-
CNMG 160616-NRM	T7325	1.6	155	0.45	6.0	120	0.41	6.0	-	-	-	-	-	-	50	0.36	4.8	-	-	-
	T7335	1.6	150	0.45	6.0	115	0.41	6.0	-	-	-	-	-	-	45	0.36	4.8	-	-	-
	T9315	1.6	195	0.45	6.0	-	-	-	-	-	-	-	-	-	-	-	-	-	-	-
CNMG 190608-NRM	T7325	0.8	150	0.35	8.0	115	0.32	8.0	-	-	-	-	-	-	45	0.28	6.4	-	-	-
	T7335	0.8	140	0.35	8.0	105	0.32	8.0	-	-	-	-	-	-	45	0.28	6.4	-	-	-
	T9315	0.8	190	0.35	8.0	-	-	-	-	-	-	-	-	-	-	-	-	-	-	-
CNMG 190612-NRM	T7325	1.2	155	0.40	8.0	120	0.36	8.0	-	-	-	-	-	-	50	0.32	6.4	-	-	-
	T7335	1.2	145	0.40	8.0	110	0.36	8.0	-	-	-	-	-	-	45	0.32	6.4	-	-	-
	T9315	1.2	190	0.40	8.0	-	-	-	-	-	-	-	-	-	-	-	-	-	-	-
CNMG 190616-NRM	T7325	1.6	150	0.45	8.0	115	0.41	8.0	-	-	-	-	-	-	45	0.36	6.4	-	-	-
	T7335	1.6	145	0.45	8.0	110	0.41	8.0	-	-	-	-	-	-	45	0.36	6.4	-	-	-
	T9315	1.6	190	0.45	8.0	-	-	-	-	-	-	-	-	-	-	-	-	-	-	-
CNMG 250924-NRM	T7325	2.4	95	0.70	10.0	70	0.63	10.0	-	-	-	-	-	-	30	0.49	8.0	-	-	-
	T7335	2.4	90	0.70	10.0	70	0.63	10.0	-	-	-	-	-	-	25	0.49	8.0	-	-	-
	T9315	2.4	115	0.70	10.0	-	-	-	105	0.70	10.0	-	-	-	-	-	-	-	-	-



Suitability and starting values for cutting speed (vc), feed (f) and depth of cut (ap). Refer to our Machining Calculator app for further calculations.

Product	RE [mm]	P			M			K			N			S			H		
		vc [m/min]	f [mm/rev]	ap [mm]	vc [m/min]	f [mm/rev]	ap [mm]	vc [m/min]	f [mm/rev]	ap [mm]	vc [m/min]	f [mm/rev]	ap [mm]	vc [m/min]	f [mm/rev]	ap [mm]	vc [m/min]	f [mm/rev]	ap [mm]

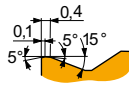

R geometry for semi-rough to rough machining, and continuous to interrupted cuts.

CNMG 120408E-R	6640	0.8	█	140	0.40	4.0	–	–	–	█	130	0.40	4.0	–	–	–	–	–	–	
	T5305	0.8	█	240	0.40	4.0	–	–	–	█	225	0.40	4.0	–	–	–	█	45	0.15	1.0
	T5315	0.8	█	215	0.40	4.0	–	–	–	█	200	0.40	4.0	–	–	–	█	40	0.15	1.0
	T9310	0.8	█	205	0.40	4.0	–	–	–	█	190	0.40	4.0	–	–	–	█	40	0.15	1.0
	T9315	0.8	█	190	0.40	4.0	–	–	–	█	180	0.40	4.0	–	–	–	█	35	0.15	1.0
	T9325	0.8	█	175	0.40	4.0	–	–	–	█	165	0.40	4.0	–	–	–	–	–	–	–
	T9335	0.8	█	150	0.40	4.0	–	–	–	–	–	–	–	–	–	–	–	–	–	–
CNMG 120412E-R	T5305	1.2	█	245	0.45	4.0	–	–	–	█	230	0.45	4.0	–	–	–	█	45	0.15	1.0
	T5315	1.2	█	220	0.45	4.0	–	–	–	█	205	0.45	4.0	–	–	–	█	40	0.15	1.0
	T9315	1.2	█	195	0.45	4.0	–	–	–	█	185	0.45	4.0	–	–	–	█	35	0.15	1.0
	T9325	1.2	█	175	0.45	4.0	–	–	–	█	165	0.45	4.0	–	–	–	–	–	–	
	T9335	1.2	█	155	0.45	4.0	–	–	–	–	–	–	–	–	–	–	–	–	–	
CNMG 120416E-R	T5315	1.6	█	225	0.50	4.0	–	–	–	█	210	0.50	4.0	–	–	–	█	45	0.15	1.0
	T9335	1.6	█	150	0.50	4.0	–	–	–	–	–	–	–	–	–	–	–	–	–	
CNMG 160608E-R	T5315	0.8	█	210	0.40	5.5	–	–	–	█	195	0.40	5.5	–	–	–	█	40	0.15	1.0
CNMG 160612E-R	T5305	1.2	█	235	0.45	5.5	–	–	–	█	220	0.45	5.5	–	–	–	█	45	0.15	1.0
	T5315	1.2	█	215	0.45	5.5	–	–	–	█	200	0.45	5.5	–	–	–	█	40	0.15	1.0
	T7335	1.2	█	145	0.45	5.5	–	–	–	–	–	–	–	–	–	–	–	–	–	
	T9310	1.2	█	205	0.45	5.5	–	–	–	█	190	0.45	5.5	–	–	–	█	40	0.15	1.0
	T9315	1.2	█	190	0.45	5.5	–	–	–	█	180	0.45	5.5	–	–	–	█	35	0.15	1.0
	T9325	1.2	█	170	0.45	5.5	–	–	–	█	160	0.45	5.5	–	–	–	–	–	–	–
	T9335	1.2	█	150	0.45	5.5	–	–	–	–	–	–	–	–	–	–	–	–	–	
CNMG 160616E-R	T5305	1.6	█	240	0.50	5.5	–	–	–	█	225	0.50	5.5	–	–	–	█	45	0.15	1.0
CNMG 190608E-R	T5315	0.8	█	205	0.40	7.0	–	–	–	█	190	0.40	7.0	–	–	–	█	40	0.15	1.0
CNMG 190612E-R	6640	1.2	█	135	0.45	7.0	–	–	–	█	125	0.45	7.0	–	–	–	–	–	–	
	T5305	1.2	█	230	0.45	7.0	–	–	–	█	215	0.45	7.0	–	–	–	█	45	0.15	1.0
	T5315	1.2	█	210	0.45	7.0	–	–	–	█	195	0.45	7.0	–	–	–	█	40	0.15	1.0
	T9315	1.2	█	185	0.45	7.0	–	–	–	█	175	0.45	7.0	–	–	–	█	35	0.15	1.0
	T9325	1.2	█	165	0.45	7.0	–	–	–	█	155	0.45	7.0	–	–	–	–	–	–	
	T9335	1.2	█	145	0.45	7.0	–	–	–	–	–	–	–	–	–	–	–	–	–	
CNMG 190616E-R	6640	1.6	█	130	0.50	7.0	–	–	–	█	120	0.50	7.0	–	–	–	–	–	–	
	T5305	1.6	█	235	0.50	7.0	–	–	–	█	220	0.50	7.0	–	–	–	█	45	0.15	1.0
	T5315	1.6	█	210	0.50	7.0	–	–	–	█	195	0.50	7.0	–	–	–	█	40	0.15	1.0
	T9310	1.6	█	195	0.50	7.0	–	–	–	█	185	0.50	7.0	–	–	–	█	35	0.15	1.0
	T9315	1.6	█	180	0.50	7.0	–	–	–	█	170	0.50	7.0	–	–	–	█	35	0.15	1.0
	T9325	1.6	█	165	0.50	7.0	–	–	–	█	155	0.50	7.0	–	–	–	–	–	–	
	T9335	1.6	█	145	0.50	7.0	–	–	–	–	–	–	–	–	–	–	–	–	–	

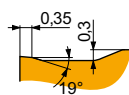

RM geometry for semi-rough to rough machining, and continuous to interrupted cuts.

CNMG 120408E-RM	T5305	0.8	█	275	0.40	4.0	–	–	–	█	260	0.40	4.0	–	–	–	–	–	–	
	T5315	0.8	█	250	0.40	4.0	–	–	–	█	235	0.40	4.0	–	–	–	–	–	–	
	T6310	0.8	█	155	0.40	4.0	█	110	0.36	4.0	█	125	0.40	4.0	–	–	–	–	–	
	T7325	0.8	█	180	0.40	4.0	█	140	0.36	4.0	–	–	–	–	–	–	–	–	–	
	T7335	0.8	█	165	0.40	4.0	█	125	0.36	4.0	–	–	–	–	–	–	–	–	–	
	T8315	0.8	█	165	0.40	4.0	█	95	0.36	4.0	█	155	0.40	4.0	–	–	–	–	–	–
	T8330	0.8	█	155	0.40	4.0	█	90	0.36	4.0	█	145	0.40	4.0	–	–	–	–	–	–
	T8430	0.8	█	165	0.40	4.0	█	90	0.36	4.0	█	135	0.40	4.0	–	–	–	–	–	–
	T9310	0.8	█	240	0.40	4.0	–	–	–	█	225	0.40	4.0	–	–	–	–	–	–	–
	T9315	0.8	█	220	0.40	4.0	–	–	–	█	205	0.40	4.0	–	–	–	–	–	–	–
	T9325	0.8	█	200	0.40	4.0	█	120	0.36	4.0	█	190	0.40	4.0	–	–	–	–	–	–
	T9335	0.8	█	170	0.40	4.0	█	100	0.36	4.0	–	–	–	–	–	–	–	–	–	–



Suitability and starting values for cutting speed (vc), feed (f) and depth of cut (ap). Refer to our Machining Calculator app for further calculations.

Product	RE  [mm]	P			M			K			N			S			H		
		vc	f	ap	vc	f	ap	vc	f	ap	vc	f	ap	vc	f	ap	vc	f	ap
		[m/min]	[mm/rev]	[mm]	[m/min]	[mm/rev]	[mm]	[m/min]	[mm/rev]	[mm]	[m/min]	[mm/rev]	[mm]	[m/min]	[mm/rev]	[mm]	[m/min]	[mm/rev]	[mm]

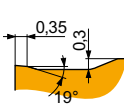

RM geometry for semi-rough to rough machining, and continuous to interrupted cuts.

CNMG 120412E-RM	T5305	1.2	280	0.45	4.0	-	-	-	265	0.45	4.0	-	-	-	-	-	-	-	-
	T5315	1.2	250	0.45	4.0	-	-	-	235	0.45	4.0	-	-	-	-	-	-	-	-
	T6310	1.2	160	0.45	4.0	115	0.41	4.0	125	0.45	4.0	-	-	-	-	-	-	-	-
	T7325	1.2	180	0.45	4.0	140	0.41	4.0	-	-	-	-	-	-	-	-	-	-	-
	T7335	1.2	170	0.45	4.0	130	0.41	4.0	-	-	-	-	-	-	-	-	-	-	-
	T8315	1.2	170	0.45	4.0	100	0.41	4.0	160	0.45	4.0	-	-	-	-	-	-	-	-
	T8330	1.2	160	0.45	4.0	95	0.41	4.0	150	0.45	4.0	-	-	-	-	-	-	-	-
	T8430	1.2	170	0.45	4.0	90	0.41	4.0	135	0.45	4.0	-	-	-	-	-	-	-	-
	T9310	1.2	240	0.45	4.0	-	-	-	225	0.45	4.0	-	-	-	-	-	-	-	-
	T9315	1.2	220	0.45	4.0	-	-	-	205	0.45	4.0	-	-	-	-	-	-	-	-
	T9325	1.2	200	0.45	4.0	120	0.41	4.0	190	0.45	4.0	-	-	-	-	-	-	-	-
	T9335	1.2	175	0.45	4.0	105	0.41	4.0	-	-	-	-	-	-	-	-	-	-	-
	CNMG 120416E-RM	T5305	1.6	280	0.50	4.0	-	-	-	265	0.50	4.0	-	-	-	-	-	-	-
T5315		1.6	255	0.50	4.0	-	-	-	240	0.50	4.0	-	-	-	-	-	-	-	-
T7325		1.6	185	0.50	4.0	140	0.45	4.0	-	-	-	-	-	-	-	-	-	-	
T7335		1.6	175	0.50	4.0	135	0.45	4.0	-	-	-	-	-	-	-	-	-	-	-
T8330		1.6	160	0.50	4.0	95	0.45	4.0	150	0.50	4.0	-	-	-	-	-	-	-	-
T8430		1.6	170	0.50	4.0	90	0.45	4.0	135	0.50	4.0	-	-	-	-	-	-	-	-
T9310		1.6	240	0.50	4.0	-	-	-	225	0.50	4.0	-	-	-	-	-	-	-	-
T9315		1.6	220	0.50	4.0	-	-	-	205	0.50	4.0	-	-	-	-	-	-	-	-
T9325		1.6	205	0.50	4.0	120	0.45	4.0	190	0.50	4.0	-	-	-	-	-	-	-	-
T9335	1.6	175	0.50	4.0	105	0.45	4.0	-	-	-	-	-	-	-	-	-	-	-	
CNMG 160608E-RM	T5305	0.8	265	0.40	6.0	-	-	-	250	0.40	6.0	-	-	-	-	-	-	-	-
	T5315	0.8	240	0.40	6.0	-	-	-	225	0.40	6.0	-	-	-	-	-	-	-	-
	T8330	0.8	150	0.40	6.0	90	0.36	6.0	140	0.40	6.0	-	-	-	-	-	-	-	-
	T8430	0.8	155	0.40	6.0	85	0.36	6.0	130	0.40	6.0	-	-	-	-	-	-	-	-
	T9315	0.8	215	0.40	6.0	-	-	-	200	0.40	6.0	-	-	-	-	-	-	-	-
	T9325	0.8	190	0.40	6.0	110	0.36	6.0	180	0.40	6.0	-	-	-	-	-	-	-	-
	T9335	0.8	165	0.40	6.0	95	0.36	6.0	-	-	-	-	-	-	-	-	-	-	-
CNMG 160612E-RM	T5305	1.2	270	0.45	6.0	-	-	-	255	0.45	6.0	-	-	-	-	-	-	-	-
	T5315	1.2	245	0.45	6.0	-	-	-	230	0.45	6.0	-	-	-	-	-	-	-	-
	T6310	1.2	155	0.45	6.0	110	0.41	6.0	125	0.45	6.0	-	-	-	-	-	-	-	-
	T7325	1.2	170	0.45	6.0	130	0.41	6.0	-	-	-	-	-	-	-	-	-	-	-
	T7335	1.2	165	0.45	6.0	125	0.41	6.0	-	-	-	-	-	-	-	-	-	-	-
	T8330	1.2	155	0.45	6.0	90	0.41	6.0	145	0.45	6.0	-	-	-	-	-	-	-	-
	T8430	1.2	155	0.45	6.0	85	0.41	6.0	130	0.45	6.0	-	-	-	-	-	-	-	-
	T9310	1.2	230	0.45	6.0	-	-	-	215	0.45	6.0	-	-	-	-	-	-	-	-
	T9315	1.2	215	0.45	6.0	-	-	-	200	0.45	6.0	-	-	-	-	-	-	-	-
	T9325	1.2	195	0.45	6.0	115	0.41	6.0	185	0.45	6.0	-	-	-	-	-	-	-	-
	T9335	1.2	165	0.45	6.0	95	0.41	6.0	-	-	-	-	-	-	-	-	-	-	-
CNMG 160616E-RM	T5305	1.6	270	0.50	6.0	-	-	-	255	0.50	6.0	-	-	-	-	-	-	-	-
	T5315	1.6	245	0.50	6.0	-	-	-	230	0.50	6.0	-	-	-	-	-	-	-	-
	T7325	1.6	175	0.50	6.0	135	0.45	6.0	-	-	-	-	-	-	-	-	-	-	
	T7335	1.6	165	0.50	6.0	125	0.45	6.0	-	-	-	-	-	-	-	-	-	-	-
	T9310	1.6	225	0.50	6.0	-	-	-	210	0.50	6.0	-	-	-	-	-	-	-	-
	T9315	1.6	215	0.50	6.0	-	-	-	200	0.50	6.0	-	-	-	-	-	-	-	-
	T9325	1.6	190	0.50	6.0	110	0.45	6.0	180	0.50	6.0	-	-	-	-	-	-	-	-
	T9335	1.6	165	0.50	6.0	95	0.45	6.0	-	-	-	-	-	-	-	-	-	-	-
CNMG 190608E-RM	T5305	0.8	260	0.40	7.5	-	-	-	245	0.40	7.5	-	-	-	-	-	-	-	-
	T5315	0.8	230	0.40	7.5	-	-	-	215	0.40	7.5	-	-	-	-	-	-	-	-
	T7335	0.8	155	0.40	7.5	120	0.36	7.5	-	-	-	-	-	-	-	-	-	-	-
	T9315	0.8	210	0.40	7.5	-	-	-	195	0.40	7.5	-	-	-	-	-	-	-	-
	T9325	0.8	190	0.40	7.5	110	0.36	7.5	180	0.40	7.5	-	-	-	-	-	-	-	-
	T9335	0.8	160	0.40	7.5	95	0.36	7.5	-	-	-	-	-	-	-	-	-	-	-



Suitability and starting values for cutting speed (vc), feed (f) and depth of cut (ap). Refer to our Machining Calculator app for further calculations.

Product	RE [mm]	P			M			K			N			S			H			
		vc	f	ap	vc	f	ap	vc	f	ap	vc	f	ap	vc	f	ap	vc	f	ap	
		[m/min]	[mm/rev]	[mm]	[m/min]	[mm/rev]	[mm]	[m/min]	[mm/rev]	[mm]	[m/min]	[mm/rev]	[mm]	[m/min]	[mm/rev]	[mm]	[m/min]	[mm/rev]	[mm]	
CNMG 190612E-RM	T5305	1.2	260	0.45	7.5	–	–	–	245	0.45	7.5	–	–	–	–	–	–	–	–	–
	T5315	1.2	240	0.45	7.5	–	–	–	225	0.45	7.5	–	–	–	–	–	–	–	–	–
	T6310	1.2	155	0.45	7.5	110	0.41	7.5	125	0.45	7.5	–	–	–	–	–	–	–	–	–
	T7325	1.2	170	0.45	7.5	130	0.41	7.5	–	–	–	–	–	–	–	–	–	–	–	–
	T7335	1.2	160	0.45	7.5	120	0.41	7.5	–	–	–	–	–	–	–	–	–	–	–	–
	T8330	1.2	155	0.45	7.5	90	0.41	7.5	145	0.45	7.5	–	–	–	–	–	–	–	–	–
	T8430	1.2	150	0.45	7.5	80	0.41	7.5	125	0.45	7.5	–	–	–	–	–	–	–	–	–
	T9310	1.2	220	0.45	7.5	–	–	–	205	0.45	7.5	–	–	–	–	–	–	–	–	–
	T9315	1.2	210	0.45	7.5	–	–	–	195	0.45	7.5	–	–	–	–	–	–	–	–	–
	T9325	1.2	185	0.45	7.5	110	0.41	7.5	175	0.45	7.5	–	–	–	–	–	–	–	–	–
T9335	1.2	165	0.45	7.5	95	0.41	7.5	–	–	–	–	–	–	–	–	–	–	–	–	
CNMG 190616E-RM	T5305	1.6	265	0.50	7.5	–	–	–	250	0.50	7.5	–	–	–	–	–	–	–	–	–
	T5315	1.6	240	0.50	7.5	–	–	–	225	0.50	7.5	–	–	–	–	–	–	–	–	–
	T6310	1.6	155	0.50	7.5	110	0.45	7.5	125	0.50	7.5	–	–	–	–	–	–	–	–	–
	T7325	1.6	175	0.50	7.5	135	0.45	7.5	–	–	–	–	–	–	–	–	–	–	–	–
	T7335	1.6	160	0.50	7.5	120	0.45	7.5	–	–	–	–	–	–	–	–	–	–	–	–
	T9310	1.6	225	0.50	7.5	–	–	–	210	0.50	7.5	–	–	–	–	–	–	–	–	–
	T9315	1.6	210	0.50	7.5	–	–	–	195	0.50	7.5	–	–	–	–	–	–	–	–	–
	T9325	1.6	190	0.50	7.5	110	0.45	7.5	180	0.50	7.5	–	–	–	–	–	–	–	–	–
T9335	1.6	160	0.50	7.5	95	0.45	7.5	–	–	–	–	–	–	–	–	–	–	–	–	
CNMG 250924E-RM	T7325	2.4	105	0.80	12.0	80	0.72	12.0	–	–	–	–	–	–	–	–	–	–	–	
	T7335	2.4	100	0.80	12.0	75	0.72	12.0	–	–	–	–	–	–	–	–	–	–	–	
	T9226	2.4	90	0.80	12.0	50	0.72	12.0	85	0.80	12.0	–	–	–	–	–	–	–	–	
	T9315	2.4	120	0.80	12.0	–	–	–	110	0.80	12.0	–	–	–	–	–	–	–	–	
	T9325	2.4	105	0.80	12.0	60	0.72	12.0	95	0.80	12.0	–	–	–	–	–	–	–	–	
	T9335	2.4	85	0.80	12.0	50	0.72	12.0	–	–	–	–	–	–	–	–	–	–	–	

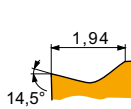

SF geometry with positive design for fine-finish machining of thin walls and continuous cuts.

CNMG 120404E-SF	H07	0.4	–	–	–	90	0.14	1.0	145	0.15	1.0	470	0.18	1.0	45	0.12	0.8	–	–	–
	T6310	0.4	180	0.15	1.0	125	0.14	1.0	145	0.15	1.0	540	0.18	1.0	50	0.12	0.8	35	0.15	1.0
	T7325	0.4	205	0.17	1.0	155	0.15	1.0	–	–	–	–	–	–	65	0.15	0.8	–	–	–
	T7335	0.4	200	0.17	1.0	155	0.15	1.0	–	–	–	–	–	–	65	0.15	0.8	–	–	–
	T8315	0.4	195	0.15	1.0	115	0.14	1.0	185	0.15	1.0	585	0.18	1.0	45	0.12	0.8	35	0.15	1.0
	T8330	0.4	180	0.15	1.0	105	0.14	1.0	170	0.15	1.0	540	0.18	1.0	45	0.12	0.8	35	0.15	1.0
	T8430	0.4	220	0.15	1.0	120	0.14	1.0	180	0.15	1.0	600	0.18	1.0	45	0.12	0.8	35	0.15	1.0
	T9315	0.4	300	0.15	1.0	–	–	–	285	0.15	1.0	–	–	–	–	–	–	60	0.15	1.0
	T9325	0.4	255	0.17	1.0	150	0.15	1.0	240	0.17	1.0	–	–	–	55	0.15	0.8	–	–	–
CNMG 120408E-SF	H07	0.8	–	–	–	95	0.18	1.0	155	0.20	1.0	495	0.24	1.0	50	0.14	0.8	–	–	–
	T6310	0.8	200	0.20	1.0	140	0.18	1.0	160	0.20	1.0	600	0.24	1.0	60	0.14	0.8	40	0.15	1.0
	T7325	0.8	230	0.20	1.0	175	0.18	1.0	–	–	–	–	–	–	70	0.16	0.8	–	–	–
	T7335	0.8	220	0.20	1.0	170	0.18	1.0	–	–	–	–	–	–	70	0.16	0.8	–	–	–
	T8315	0.8	210	0.20	1.0	125	0.18	1.0	195	0.20	1.0	630	0.24	1.0	50	0.14	0.8	40	0.15	1.0
	T8330	0.8	200	0.20	1.0	120	0.18	1.0	190	0.20	1.0	600	0.24	1.0	50	0.14	0.8	40	0.15	1.0
	T8430	0.8	230	0.20	1.0	125	0.18	1.0	185	0.20	1.0	630	0.24	1.0	45	0.14	0.8	35	0.15	1.0
	T9315	0.8	315	0.20	1.0	–	–	–	295	0.20	1.0	–	–	–	–	–	–	60	0.15	1.0
T9325	0.8	280	0.20	1.0	165	0.18	1.0	265	0.20	1.0	–	–	–	60	0.16	0.8	–	–	–	
CNMG 120412E-SF	T6310	1.2	190	0.25	1.5	135	0.23	1.5	150	0.25	1.5	570	0.30	1.5	55	0.18	1.2	35	0.15	1.0
	T7325	1.2	220	0.25	1.5	170	0.23	1.5	–	–	–	–	–	–	70	0.18	1.2	–	–	–
	T8315	1.2	200	0.25	1.5	120	0.23	1.5	190	0.25	1.5	600	0.30	1.5	50	0.18	1.2	40	0.15	1.0
	T8430	1.2	210	0.25	1.5	115	0.23	1.5	175	0.25	1.5	585	0.30	1.5	45	0.18	1.2	35	0.15	1.0



Suitability and starting values for cutting speed (vc), feed (f) and depth of cut (ap). Refer to our Machining Calculator app for further calculations.

Product	RE (mm)	P			M			K			N			S			H		
		vc (m/min)	f (mm/rev)	ap (mm)	vc (m/min)	f (mm/rev)	ap (mm)	vc (m/min)	f (mm/rev)	ap (mm)	vc (m/min)	f (mm/rev)	ap (mm)	vc (m/min)	f (mm/rev)	ap (mm)	vc (m/min)	f (mm/rev)	ap (mm)

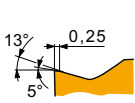

SM geometry with positive design for medium machining, and continuous to interrupted cuts.

CNMG 120404E-SM	T6310	0.4	155	0.22	2.0	110	0.20	2.0	125	0.22	2.0	465	0.26	2.0	45	0.20	1.6	30	0.15	1.0
	T7325	0.4	175	0.22	2.0	135	0.20	2.0	-	-	-	-	-	-	55	0.20	1.6	-	-	-
	T7335	0.4	170	0.22	2.0	130	0.20	2.0	-	-	-	-	-	-	55	0.20	1.6	-	-	-
	T8330	0.4	155	0.22	2.0	90	0.20	2.0	145	0.22	2.0	465	0.26	2.0	35	0.20	1.6	30	0.15	1.0
	T8430	0.4	170	0.22	2.0	90	0.20	2.0	135	0.22	2.0	465	0.26	2.0	35	0.20	1.6	25	0.15	1.0
	T9315	0.4	245	0.20	2.0	-	-	-	230	0.20	2.0	-	-	-	-	-	-	45	0.15	1.0
	T9325	0.4	210	0.22	2.0	125	0.20	2.0	195	0.22	2.0	-	-	-	45	0.20	1.6	-	-	-
CNMG 120408E-SM	T6310	0.8	175	0.25	2.0	125	0.23	2.0	140	0.25	2.0	525	0.30	2.0	50	0.20	1.6	35	0.15	1.0
	T7325	0.8	200	0.25	2.0	155	0.23	2.0	-	-	-	-	-	65	0.20	1.6	-	-	-	
	T7335	0.8	190	0.25	2.0	145	0.23	2.0	-	-	-	-	-	60	0.20	1.6	-	-	-	
	T8330	0.8	175	0.25	2.0	105	0.23	2.0	165	0.25	2.0	525	0.30	2.0	40	0.20	1.6	35	0.15	1.0
	T8430	0.8	195	0.25	2.0	105	0.23	2.0	160	0.25	2.0	540	0.30	2.0	40	0.20	1.6	30	0.15	1.0
	T9315	0.8	265	0.25	2.0	-	-	-	250	0.25	2.0	-	-	-	-	-	50	0.15	1.0	
	T9325	0.8	235	0.25	2.0	140	0.23	2.0	220	0.25	2.0	-	-	-	50	0.20	1.6	-	-	-
CNMG 120412E-SM	T6310	1.2	175	0.30	2.0	125	0.27	2.0	140	0.30	2.0	525	0.36	2.0	50	0.24	1.6	35	0.15	1.0
	T7325	1.2	195	0.30	2.0	150	0.27	2.0	-	-	-	-	-	60	0.24	1.6	-	-	-	
	T7335	1.2	190	0.30	2.0	145	0.27	2.0	-	-	-	-	-	60	0.24	1.6	-	-	-	
	T8330	1.2	175	0.30	2.0	105	0.27	2.0	165	0.30	2.0	525	0.36	2.0	40	0.24	1.6	35	0.15	1.0
	T8430	1.2	190	0.30	2.0	105	0.27	2.0	155	0.30	2.0	525	0.36	2.0	40	0.24	1.6	30	0.15	1.0
	T9315	1.2	260	0.30	2.0	-	-	-	245	0.30	2.0	-	-	-	-	-	50	0.15	1.0	
	T9325	1.2	235	0.30	2.0	140	0.27	2.0	220	0.30	2.0	-	-	-	50	0.24	1.6	-	-	-
CNMG 160608E-SM	T7325	0.8	185	0.26	3.0	140	0.23	3.0	-	-	-	-	-	60	0.23	2.4	-	-	-	
	T7335	0.8	180	0.26	3.0	140	0.23	3.0	-	-	-	-	-	55	0.23	2.4	-	-	-	
	T8330	0.8	165	0.26	3.0	95	0.23	3.0	155	0.26	3.0	495	0.31	3.0	40	0.23	2.4	30	0.15	1.0
	T8430	0.8	180	0.26	3.0	95	0.23	3.0	145	0.26	3.0	495	0.31	3.0	35	0.23	2.4	30	0.15	1.0
	T9325	0.8	225	0.26	3.0	135	0.23	3.0	210	0.26	3.0	-	-	-	50	0.23	2.4	-	-	-
CNMG 160612E-SM	T6310	1.2	170	0.30	3.0	120	0.27	3.0	135	0.30	3.0	510	0.36	3.0	50	0.27	2.4	30	0.15	1.0
	T7325	1.2	190	0.30	3.0	145	0.27	3.0	-	-	-	-	-	60	0.27	2.4	-	-	-	
	T7335	1.2	180	0.30	3.0	140	0.27	3.0	-	-	-	-	-	55	0.27	2.4	-	-	-	
	T9315	1.2	250	0.30	3.0	-	-	-	235	0.30	3.0	-	-	-	-	-	50	0.15	1.0	
	T9325	1.2	225	0.30	3.0	135	0.27	3.0	210	0.30	3.0	-	-	-	50	0.27	2.4	-	-	-
CNMG 190612E-SM	T6310	1.2	165	0.30	4.0	115	0.27	4.0	130	0.30	4.0	495	0.36	4.0	45	0.27	3.2	30	0.15	1.0
	T7325	1.2	185	0.30	4.0	140	0.27	4.0	-	-	-	-	-	60	0.27	3.2	-	-	-	
	T7335	1.2	175	0.30	4.0	135	0.27	4.0	-	-	-	-	-	55	0.27	3.2	-	-	-	
	T9315	1.2	245	0.30	4.0	-	-	-	230	0.30	4.0	-	-	-	-	-	45	0.15	1.0	
	T9325	1.2	220	0.30	4.0	130	0.27	4.0	205	0.30	4.0	-	-	-	45	0.27	3.2	-	-	-

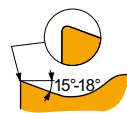

ER-SI geometry with positive right-handed design for fine-finish to semi-rough machining, and continuous cuts.

CNMG 120404ER-SI	T7325	0.4	220	0.20	1.7	170	0.18	1.7	-	-	-	-	-	70	0.18	1.4	-	-	-	
	T7335	0.4	215	0.20	1.7	165	0.18	1.7	-	-	-	-	-	65	0.18	1.4	-	-	-	
	T8330	0.4	195	0.20	1.7	115	0.18	1.7	-	-	-	585	0.24	1.7	45	0.18	1.4	-	-	-
	T8430	0.4	225	0.20	1.7	120	0.18	1.7	-	-	-	615	0.24	1.7	45	0.18	1.4	-	-	-
	T9325	0.4	270	0.20	1.7	160	0.18	1.7	-	-	-	-	-	60	0.18	1.4	-	-	-	
CNMG 120408ER-SI	T7325	0.8	215	0.35	1.7	165	0.32	1.7	-	-	-	-	-	65	0.25	1.4	-	-	-	
	T7335	0.8	205	0.35	1.7	155	0.32	1.7	-	-	-	-	-	65	0.25	1.4	-	-	-	
	T8315	0.8	205	0.35	1.7	120	0.32	1.7	-	-	-	615	0.42	1.7	50	0.25	1.4	-	-	-
	T8330	0.8	195	0.35	1.7	115	0.32	1.7	-	-	-	585	0.42	1.7	45	0.25	1.4	-	-	-
	T8430	0.8	210	0.35	1.7	115	0.32	1.7	-	-	-	585	0.42	1.7	45	0.25	1.4	-	-	-
CNMG 120412ER-SI	T9325	0.8	255	0.35	1.7	150	0.32	1.7	-	-	-	-	-	55	0.25	1.4	-	-	-	
	T8430	1.2	225	0.35	1.7	120	0.32	1.7	-	-	-	615	0.42	1.7	45	0.25	1.4	-	-	-



Suitability and starting values for cutting speed (vc), feed (f) and depth of cut (ap). Refer to our Machining Calculator app for further calculations.

Product	RE [mm]	P			M			K			N			S			H		
		vc	f	ap	vc	f	ap	vc	f	ap	vc	f	ap	vc	f	ap	vc	f	ap
		[m/min]	[mm/rev]	[mm]	[m/min]	[mm/rev]	[mm]	[m/min]	[mm/rev]	[mm]	[m/min]	[mm/rev]	[mm]	[m/min]	[mm/rev]	[mm]	[m/min]	[mm/rev]	[mm]

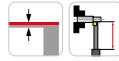
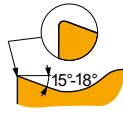

EL-SI geometry with positive left-handed design for fine-finish to semi-rough machining, and continuous cuts.

CNMG 120404EL-SI	T7325	0.4	220	0.20	1.7	170	0.18	1.7	-	-	-	-	-	-	70	0.18	1.4	-	-	-
	T7335	0.4	215	0.20	1.7	165	0.18	1.7	-	-	-	-	-	-	65	0.18	1.4	-	-	-
	T8330	0.4	195	0.20	1.7	115	0.18	1.7	-	-	-	585	0.24	1.7	45	0.18	1.4	-	-	-
	T8430	0.4	225	0.20	1.7	120	0.18	1.7	-	-	-	615	0.24	1.7	45	0.18	1.4	-	-	-
	T9325	0.4	270	0.20	1.7	160	0.18	1.7	-	-	-	-	-	-	60	0.18	1.4	-	-	-
CNMG 120408EL-SI	T7325	0.8	215	0.35	1.7	165	0.32	1.7	-	-	-	-	-	-	65	0.25	1.4	-	-	-
	T7335	0.8	205	0.35	1.7	155	0.32	1.7	-	-	-	-	-	-	65	0.25	1.4	-	-	-
	T8315	0.8	205	0.35	1.7	120	0.32	1.7	-	-	-	615	0.42	1.7	50	0.25	1.4	-	-	-
	T8330	0.8	195	0.35	1.7	115	0.32	1.7	-	-	-	585	0.42	1.7	45	0.25	1.4	-	-	-
	T8430	0.8	210	0.35	1.7	115	0.32	1.7	-	-	-	585	0.42	1.7	45	0.25	1.4	-	-	-
CNMG 120412EL-SI	T8430	1.2	225	0.35	1.7	120	0.32	1.7	-	-	-	615	0.42	1.7	45	0.25	1.4	-	-	-

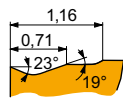

W-F wiper geometry for fine to finish machining with increased feed rates and improved surface finish.

CNMG 120408W-F	T9315	0.8	215	0.45	0.8	-	-	-	200	0.45	0.8	-	-	-	-	-	-	-	-	-
	T9325	0.8	190	0.45	0.8	-	-	-	180	0.45	0.8	-	-	-	-	-	-	-	-	-

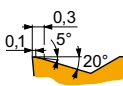

W-M wiper geometry for semi-rough to rough machining with increased feed rates and improved surface finish.

CNMG 120408W-M	T5315	0.8	230	0.45	1.5	-	-	-	215	0.45	1.5	-	-	-	-	-	-	-	-	-
	T9315	0.8	200	0.45	1.5	-	-	-	190	0.45	1.5	-	-	-	-	-	-	-	-	-
	T9325	0.8	185	0.45	1.5	-	-	-	175	0.45	1.5	-	-	-	-	-	-	-	-	-
CNMG 120412W-M	T5315	1.2	230	0.55	1.5	-	-	-	215	0.55	1.5	-	-	-	-	-	-	-	-	-
	T9315	1.2	200	0.55	1.5	-	-	-	190	0.55	1.5	-	-	-	-	-	-	-	-	-
	T9325	1.2	180	0.55	1.5	-	-	-	170	0.55	1.5	-	-	-	-	-	-	-	-	-

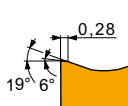

W-MR wiper geometry for finish to rough machining with increased feed rates and improved surface finish.

CNMG 120404W-MR	T9315	0.4	200	0.30	1.5	-	-	-	190	0.30	1.5	-	-	-	-	-	-	-	-	-
	T9325	0.4	180	0.30	1.5	105	0.27	1.5	170	0.30	1.5	-	-	-	-	-	-	-	-	-
CNMG 120408W-MR	T5315	0.8	230	0.45	1.5	-	-	-	215	0.45	1.5	-	-	-	-	-	-	-	-	-
	T9310	0.8	215	0.45	1.5	-	-	-	200	0.45	1.5	-	-	-	-	-	-	-	-	-
	T9315	0.8	200	0.45	1.5	-	-	-	190	0.45	1.5	-	-	-	-	-	-	-	-	-
CNMG 120412W-MR	T9325	0.8	185	0.45	1.5	110	0.41	1.5	175	0.45	1.5	-	-	-	-	-	-	-	-	-
	T5315	1.2	230	0.55	1.5	-	-	-	215	0.55	1.5	-	-	-	-	-	-	-	-	-
	T9310	1.2	210	0.55	1.5	-	-	-	195	0.55	1.5	-	-	-	-	-	-	-	-	-
	T9315	1.2	200	0.55	1.5	-	-	-	190	0.55	1.5	-	-	-	-	-	-	-	-	-
CNMG 120412W-MR	T9325	1.2	180	0.55	1.5	105	0.50	1.5	170	0.55	1.5	-	-	-	-	-	-	-	-	-

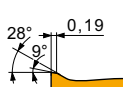

W-NM wiper geometry for finish to rough machining with increased feed rates and improved surface finish.

CNMG 120404W-NM	T7325	0.4	195	0.20	2.1	150	0.18	2.1	-	-	-	-	-	-	60	0.16	1.7	-	-	-
	T7335	0.4	190	0.20	2.1	145	0.18	2.1	-	-	-	-	-	-	60	0.16	1.7	-	-	-
	T9315	0.4	270	0.20	2.1	-	-	-	255	0.20	2.1	-	-	-	-	-	-	-	-	-
	T9325	0.4	240	0.20	2.1	140	0.18	2.1	225	0.20	2.1	-	-	-	50	0.16	1.7	-	-	-



Suitability and starting values for cutting speed (vc), feed (f) and depth of cut (ap). Refer to our Machining Calculator app for further calculations.

Product	RE [mm]	P			M			K			N			S			H		
		vc [m/min]	f [mm/rev]	ap [mm]	vc [m/min]	f [mm/rev]	ap [mm]	vc [m/min]	f [mm/rev]	ap [mm]	vc [m/min]	f [mm/rev]	ap [mm]	vc [m/min]	f [mm/rev]	ap [mm]	vc [m/min]	f [mm/rev]	ap [mm]

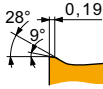

W-NM wiper geometry for finish to rough machining with increased feed rates and improved surface finish.

CNMG 120408W-NM	T7325	0.8	215	0.25	2.1	165	0.23	2.1	—	—	—	—	—	—	65	0.20	1.7	—	—	—	
	T7335	0.8	210	0.25	2.1	160	0.23	2.1	—	—	—	—	—	—	65	0.20	1.7	—	—	—	
	T9315	0.8	290	0.25	2.1	—	—	—	275	0.25	2.1	—	—	—	—	—	—	—	—	—	—
	T9325	0.8	260	0.25	2.1	155	0.23	2.1	245	0.25	2.1	—	—	—	55	0.20	1.7	—	—	—	
CNMG 120412W-NM	T7325	1.2	215	0.30	2.1	165	0.27	2.1	—	—	—	—	—	—	65	0.24	1.7	—	—	—	
	T7335	1.2	210	0.30	2.1	160	0.27	2.1	—	—	—	—	—	—	65	0.24	1.7	—	—	—	
	T9315	1.2	285	0.30	2.1	—	—	—	270	0.30	2.1	—	—	—	—	—	—	—	—	—	
	T9325	1.2	255	0.30	2.1	150	0.27	2.1	240	0.30	2.1	—	—	—	55	0.24	1.7	—	—	—	

CNMM



	IC [mm]	D1 [mm]	L [mm]	S [mm]
1204	12.700	5.16	12.90	4.76
1606	15.875	6.35	16.10	6.35
1906	19.050	7.94	19.30	6.35
2509	25.400	9.12	25.80	9.53

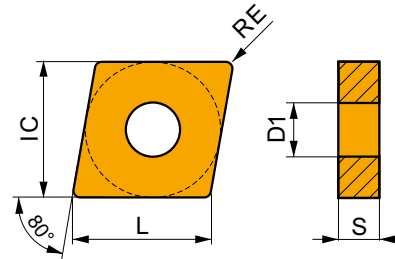

Suitability and starting values for cutting speed (vc), feed (f) and depth of cut (ap). Refer to our Machining Calculator app for further calculations.

Product	RE [mm]	P			M			K			N			S			H		
		vc [m/min]	f [mm/rev]	ap [mm]	vc [m/min]	f [mm/rev]	ap [mm]	vc [m/min]	f [mm/rev]	ap [mm]	vc [m/min]	f [mm/rev]	ap [mm]	vc [m/min]	f [mm/rev]	ap [mm]	vc [m/min]	f [mm/rev]	ap [mm]

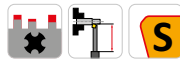
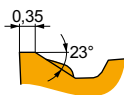

DR geometry for semi-rough to rough machining, and continuous to interrupted cuts.

CNMM 160612E-DR	T9315	1.2	225	0.45	6.0	—	—	—	210	0.45	6.0	—	—	—	—	—	—	—	—	—
	T9325	1.2	200	0.45	6.0	120	0.41	6.0	190	0.45	6.0	—	—	—	—	—	—	—	—	—
	T9335	1.2	170	0.45	6.0	100	0.41	6.0	—	—	—	—	—	—	—	—	—	—	—	—
CNMM 190608E-DR	T9315	0.8	215	0.40	8.0	—	—	—	200	0.40	8.0	—	—	—	—	—	—	—	—	—
	T9325	0.8	190	0.40	8.0	110	0.36	8.0	180	0.40	8.0	—	—	—	—	—	—	—	—	—
CNMM 190612E-DR	T9315	1.2	220	0.45	8.0	—	—	—	205	0.45	8.0	—	—	—	—	—	—	—	—	—
	T9325	1.2	195	0.45	8.0	115	0.41	8.0	185	0.45	8.0	—	—	—	—	—	—	—	—	—
	T9335	1.2	170	0.45	8.0	100	0.41	8.0	—	—	—	—	—	—	—	—	—	—	—	—
CNMM 190616E-DR	T9325	1.6	195	0.50	9.0	115	0.45	9.0	185	0.50	9.0	—	—	—	—	—	—	—	—	—
	T9335	1.6	170	0.50	9.0	100	0.45	9.0	—	—	—	—	—	—	—	—	—	—	—	—

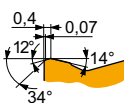

HR geometry for rough to heavy-rough machining, and continuous to interrupted cuts.

CNMM 190616E-HR	6640	1.6	75	0.60	10.0	45	0.54	10.0	70	0.60	10.0	—	—	—	—	—	—	—	—	—
	T8345	1.6	55	0.60	10.0	30	0.54	10.0	50	0.60	10.0	—	—	—	—	—	—	—	—	—
	T9325	1.6	105	0.60	10.0	60	0.54	10.0	95	0.60	10.0	—	—	—	—	—	—	—	—	—
	T9335	1.6	80	0.60	10.0	45	0.54	10.0	—	—	—	—	—	—	—	—	—	—	—	—
CNMM 190624E-HR	T8345	2.4	60	0.65	10.0	35	0.59	10.0	55	0.65	10.0	—	—	—	—	—	—	—	—	—
	T9315	2.4	115	0.65	10.0	—	—	—	105	0.65	10.0	—	—	—	—	—	—	—	—	—
	T9325	2.4	100	0.65	10.0	60	0.59	10.0	95	0.65	10.0	—	—	—	—	—	—	—	—	—
	T9335	2.4	85	0.65	10.0	50	0.59	10.0	—	—	—	—	—	—	—	—	—	—	—	—



Suitability and starting values for cutting speed (vc), feed (f) and depth of cut (ap). Refer to our Machining Calculator app for further calculations.

Product	RE [mm]	P			M			K			N			S			H		
		vc	f	ap	vc	f	ap	vc	f	ap	vc	f	ap	vc	f	ap	vc	f	ap
		[m/min]	[mm/rev]	[mm]	[m/min]	[mm/rev]	[mm]	[m/min]	[mm/rev]	[mm]	[m/min]	[mm/rev]	[mm]	[m/min]	[mm/rev]	[mm]	[m/min]	[mm/rev]	[mm]

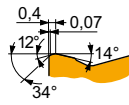

HR geometry for rough to heavy-rough machining, and continuous to interrupted cuts.

CNMM 250924E-HR	6640	2.4	■	75	0.65	14.0	▣	45	0.59	14.0	■	70	0.65	14.0	—	—	—	—	—	—
	T8345	2.4	■	55	0.65	14.0	▣	30	0.59	14.0	■	50	0.65	14.0	—	—	—	—	—	—
	T9315	2.4	■	110	0.65	14.0	—	—	—	■	100	0.65	14.0	—	—	—	—	—	—	—
	T9325	2.4	■	100	0.65	14.0	▣	60	0.59	14.0	■	95	0.65	14.0	—	—	—	—	—	—
	T9335	2.4	■	80	0.65	14.0	▣	45	0.59	14.0	—	—	—	—	—	—	—	—	—	—

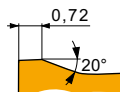

HR2 geometry for rough to heavy-rough machining, and continuous to interrupted cuts.

CNMM 190616-HR2	T9226	1.6	■	85	0.65	10.0	▣	50	0.59	10.0	■	80	0.65	10.0	—	—	—	—	—	—
	T9315	1.6	■	110	0.65	10.0	—	—	—	■	100	0.65	10.0	—	—	—	—	—	—	—
	T9335	1.6	■	80	0.65	10.0	▣	45	0.59	10.0	—	—	—	—	—	—	—	—	—	—
CNMM 190624-HR2	T9226	2.4	■	80	0.85	10.0	▣	45	0.77	10.0	■	75	0.85	10.0	—	—	—	—	—	—
	T9315	2.4	■	100	0.85	10.0	—	—	—	■	95	0.85	10.0	—	—	—	—	—	—	—
	T9335	2.4	■	75	0.85	10.0	▣	45	0.77	10.0	—	—	—	—	—	—	—	—	—	—
CNMM 250924-HR2	T9315	2.4	■	100	0.85	12.0	—	—	—	■	95	0.85	12.0	—	—	—	—	—	—	—
	T9335	2.4	■	75	0.85	12.0	▣	45	0.77	12.0	—	—	—	—	—	—	—	—	—	—

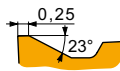

NR geometry for semi-rough to rough machining, and continuous to interrupted cuts.

CNMM 120408E-NR	6640	0.8	■	155	0.40	3.0	▣	90	0.36	3.0	■	145	0.40	3.0	—	—	—	—	—	—	
	T7325	0.8	▣	175	0.40	3.0	■	135	0.36	3.0	—	—	—	▣	55	0.28	2.4	—	—	—	
	T7335	0.8	▣	165	0.40	3.0	■	125	0.36	3.0	—	—	—	▣	50	0.28	2.4	—	—	—	
	T8330	0.8	■	155	0.40	3.0	■	90	0.36	3.0	■	145	0.40	3.0	—	—	—	▣	35	0.28	2.4
	T8430	0.8	■	165	0.40	3.0	■	90	0.36	3.0	■	135	0.40	3.0	—	—	—	▣	35	0.28	2.4
	T9315	0.8	■	215	0.40	3.0	—	—	—	■	200	0.40	3.0	—	—	—	—	—	—	—	—
	T9325	0.8	■	195	0.40	3.0	■	115	0.36	3.0	■	185	0.40	3.0	—	—	—	▣	40	0.28	2.4
CNMM 120412E-NR	T7325	1.2	▣	185	0.40	3.0	■	140	0.36	3.0	—	—	—	—	—	—	—	▣	60	0.28	2.4
	T7335	1.2	▣	175	0.40	3.0	■	135	0.36	3.0	—	—	—	—	—	—	—	▣	55	0.28	2.4
	T8330	1.2	■	165	0.40	3.0	■	95	0.36	3.0	■	155	0.40	3.0	—	—	—	▣	40	0.28	2.4
	T8430	1.2	■	170	0.40	3.0	■	90	0.36	3.0	■	135	0.40	3.0	—	—	—	▣	35	0.28	2.4
	T9325	1.2	■	205	0.40	3.0	■	120	0.36	3.0	■	190	0.40	3.0	—	—	—	▣	45	0.28	2.4

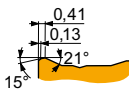

NR2 geometry for semi-rough to rough machining, and continuous to interrupted cuts.

CNMM 120408E-NR2	T7325	0.8	▣	165	0.40	5.0	■	125	0.36	5.0	—	—	—	—	—	—	—	▣	50	0.28	4.0
	T7335	0.8	▣	155	0.40	5.0	■	120	0.36	5.0	—	—	—	—	—	—	—	▣	50	0.28	4.0
	T8330	0.8	■	150	0.40	5.0	■	90	0.36	5.0	■	140	0.40	5.0	—	—	—	▣	35	0.28	4.0
	T8430	0.8	■	150	0.40	5.0	■	80	0.36	5.0	■	125	0.40	5.0	—	—	—	▣	30	0.28	4.0
	T9315	0.8	■	205	0.40	5.0	—	—	—	■	190	0.40	5.0	—	—	—	—	—	—	—	—
CNMM 120412E-NR2	T9325	0.8	■	185	0.40	5.0	■	110	0.36	5.0	■	175	0.40	5.0	—	—	—	▣	40	0.28	4.0
	T7335	1.2	▣	155	0.45	5.0	■	120	0.41	5.0	—	—	—	—	—	—	—	▣	50	0.32	4.0
	T8330	1.2	■	150	0.45	5.0	■	90	0.41	5.0	■	140	0.45	5.0	—	—	—	▣	35	0.32	4.0
	T8430	1.2	■	150	0.45	5.0	■	80	0.41	5.0	■	125	0.45	5.0	—	—	—	▣	30	0.32	4.0
	T9315	1.2	■	205	0.45	5.0	—	—	—	■	190	0.45	5.0	—	—	—	—	—	—	—	—
CNMM 160608E-NR2	T9325	1.2	■	185	0.45	5.0	■	110	0.41	5.0	■	175	0.45	5.0	—	—	—	▣	40	0.32	4.0
	T8330	0.8	■	145	0.40	6.0	■	85	0.36	6.0	■	135	0.40	6.0	—	—	—	▣	35	0.32	4.8
	T8430	0.8	■	150	0.40	6.0	■	80	0.36	6.0	■	125	0.40	6.0	—	—	—	▣	30	0.32	4.8
T9325	0.8	■	180	0.40	6.0	■	105	0.36	6.0	■	170	0.40	6.0	—	—	—	▣	40	0.32	4.8	



Suitability and starting values for cutting speed (vc), feed (f) and depth of cut (ap). Refer to our Machining Calculator app for further calculations.

Product	RE (mm)	P			M			K			N			S			H		
		vc [m/min]	f [mm/rev]	ap [mm]	vc [m/min]	f [mm/rev]	ap [mm]	vc [m/min]	f [mm/rev]	ap [mm]	vc [m/min]	f [mm/rev]	ap [mm]	vc [m/min]	f [mm/rev]	ap [mm]	vc [m/min]	f [mm/rev]	ap [mm]

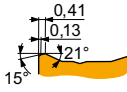
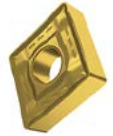

NR2 geometry for semi-rough to rough machining, and continuous to interrupted cuts.

CNMM 160612E-NR2	T7325	1.2	165	0.45	6.0	125	0.41	6.0	-	-	-	-	-	-	50	0.36	4.8	-	-	-	
	T7335	1.2	155	0.45	6.0	120	0.41	6.0	-	-	-	-	-	-	50	0.36	4.8	-	-	-	
	T8330	1.2	145	0.45	6.0	85	0.41	6.0	135	0.45	6.0	-	-	-	35	0.36	4.8	-	-	-	
	T8430	1.2	150	0.45	6.0	80	0.41	6.0	125	0.45	6.0	-	-	-	30	0.36	4.8	-	-	-	
	T9315	1.2	205	0.45	6.0	-	-	-	190	0.45	6.0	-	-	-	-	-	-	-	-	-	-
	T9325	1.2	185	0.45	6.0	110	0.41	6.0	175	0.45	6.0	-	-	-	40	0.36	4.8	-	-	-	-
CNMM 160616E-NR2	T7325	1.6	165	0.50	6.0	125	0.45	6.0	-	-	-	-	-	-	50	0.40	4.8	-	-	-	
	T7335	1.6	160	0.50	6.0	120	0.45	6.0	-	-	-	-	-	-	50	0.40	4.8	-	-	-	
	T9325	1.6	180	0.50	6.0	105	0.45	6.0	170	0.50	6.0	-	-	-	40	0.40	4.8	-	-	-	
CNMM 190612E-NR2	T7325	1.2	155	0.45	9.0	120	0.41	9.0	-	-	-	-	-	-	50	0.36	7.2	-	-	-	
	T7335	1.2	145	0.45	9.0	110	0.41	9.0	-	-	-	-	-	-	45	0.36	7.2	-	-	-	
	T8330	1.2	140	0.45	9.0	80	0.41	9.0	130	0.45	9.0	-	-	-	35	0.36	7.2	-	-	-	
	T8430	1.2	140	0.45	9.0	75	0.41	9.0	115	0.45	9.0	-	-	-	30	0.36	7.2	-	-	-	
	T9325	1.2	175	0.45	9.0	105	0.41	9.0	165	0.45	9.0	-	-	-	35	0.36	7.2	-	-	-	
CNMM 190616E-NR2	T7325	1.6	160	0.50	9.0	120	0.45	9.0	-	-	-	-	-	-	50	0.40	7.2	-	-	-	
	T7335	1.6	150	0.50	9.0	115	0.45	9.0	-	-	-	-	-	-	45	0.40	7.2	-	-	-	
	T8330	1.6	140	0.50	9.0	80	0.45	9.0	130	0.50	9.0	-	-	-	35	0.40	7.2	-	-	-	
	T8430	1.6	140	0.50	9.0	75	0.45	9.0	115	0.50	9.0	-	-	-	30	0.40	7.2	-	-	-	
	T9315	1.6	195	0.50	9.0	-	-	-	185	0.50	9.0	-	-	-	-	-	-	-	-	-	-
	T9325	1.6	175	0.50	9.0	105	0.45	9.0	165	0.50	9.0	-	-	-	35	0.40	7.2	-	-	-	-
CNMM 190624E-NR2	T7335	2.4	130	0.80	9.0	100	0.72	9.0	-	-	-	-	-	-	40	0.56	7.2	-	-	-	
	T9325	2.4	150	0.80	9.0	90	0.72	9.0	140	0.80	9.0	-	-	-	30	0.56	7.2	-	-	-	
CNMM 250924E-NR2	T7325	2.4	100	0.80	12.0	75	0.72	12.0	-	-	-	-	-	-	30	0.56	9.6	-	-	-	
	T7335	2.4	95	0.80	12.0	70	0.72	12.0	-	-	-	-	-	-	30	0.56	9.6	-	-	-	
	T8430	2.4	80	0.80	12.0	45	0.72	12.0	65	0.80	12.0	-	-	-	15	0.56	9.6	-	-	-	
	T9315	2.4	110	0.80	12.0	-	-	-	100	0.80	12.0	-	-	-	-	-	-	-	-	-	-
	T9325	2.4	100	0.80	12.0	60	0.72	12.0	95	0.80	12.0	-	-	-	20	0.56	9.6	-	-	-	-

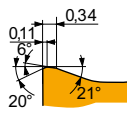

NRM geometry with positive design for semi-rough to rough machining, and continuous to interrupted cuts.

CNMM 250924-NRM	T7325	2.4	95	0.70	10.0	70	0.63	10.0	-	-	-	-	-	-	30	0.49	8.0	-	-	-
	T7335	2.4	90	0.70	10.0	70	0.63	10.0	-	-	-	-	-	-	25	0.49	8.0	-	-	-
	T9315	2.4	115	0.70	10.0	-	-	-	105	0.70	10.0	-	-	-	-	-	-	-	-	-

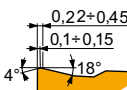

OR geometry for semi-rough to rough machining, and continuous to interrupted cuts.

CNMM 120408E-OR	T8330	0.8	150	0.40	5.0	90	0.36	5.0	140	0.40	5.0	-	-	-	35	0.28	4.0	-	-	-	
	T8430	0.8	150	0.40	5.0	80	0.36	5.0	125	0.40	5.0	-	-	-	30	0.28	4.0	-	-	-	
	T9315	0.8	205	0.40	5.0	-	-	-	190	0.40	5.0	-	-	-	-	-	-	-	-	-	-
	T9325	0.8	185	0.40	5.0	110	0.36	5.0	175	0.40	5.0	-	-	-	40	0.28	4.0	-	-	-	-
	T9335	0.8	160	0.40	5.0	95	0.36	5.0	-	-	-	-	-	-	35	0.28	4.0	-	-	-	-
CNMM 120412E-OR	T9315	1.2	205	0.45	5.0	-	-	-	190	0.45	5.0	-	-	-	-	-	-	-	-	-	-
	T9325	1.2	185	0.45	5.0	110	0.41	5.0	175	0.45	5.0	-	-	-	40	0.36	4.0	-	-	-	-
	T9335	1.2	165	0.45	5.0	95	0.41	5.0	-	-	-	-	-	-	35	0.36	4.0	-	-	-	-
CNMM 120416E-OR	T9325	1.6	190	0.50	5.0	110	0.45	5.0	180	0.50	5.0	-	-	-	40	0.40	4.0	-	-	-	-
	T9335	1.6	165	0.50	5.0	95	0.45	5.0	-	-	-	-	-	-	35	0.40	4.0	-	-	-	-
CNMM 160608E-OR	T9315	0.8	205	0.40	6.0	-	-	-	190	0.40	6.0	-	-	-	-	-	-	-	-	-	-
	T9325	0.8	180	0.40	6.0	105	0.36	6.0	170	0.40	6.0	-	-	-	40	0.32	4.8	-	-	-	-
	T9335	0.8	160	0.40	6.0	95	0.36	6.0	-	-	-	-	-	-	35	0.32	4.8	-	-	-	-
CNMM 160612E-OR	T8430	1.2	150	0.45	6.0	80	0.41	6.0	125	0.45	6.0	-	-	-	30	0.36	4.8	-	-	-	-
	T9315	1.2	205	0.45	6.0	-	-	-	190	0.45	6.0	-	-	-	-	-	-	-	-	-	-
	T9325	1.2	185	0.45	6.0	110	0.41	6.0	175	0.45	6.0	-	-	-	40	0.36	4.8	-	-	-	-



Suitability and starting values for cutting speed (vc), feed (f) and depth of cut (ap). Refer to our Machining Calculator app for further calculations.

Product	RE [mm]	P			M			K			N			S			H		
		vc	f	ap	vc	f	ap	vc	f	ap	vc	f	ap	vc	f	ap	vc	f	ap
		[m/min]	[mm/rev]	[mm]	[m/min]	[mm/rev]	[mm]	[m/min]	[mm/rev]	[mm]	[m/min]	[mm/rev]	[mm]	[m/min]	[mm/rev]	[mm]	[m/min]	[mm/rev]	[mm]

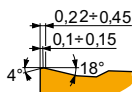

OR geometry for semi-rough to rough machining, and continuous to interrupted cuts.

CNMM 160616E-OR	T9315	1.6	■	205	0.50	6.0	■	–	–	–	■	190	0.50	6.0	■	–	–	–	■	–	–	–				
	T9325	1.6	■	180	0.50	6.0	■	105	0.45	6.0	■	170	0.50	6.0	■	–	–	–	■	40	0.40	4.8	■	–	–	–
CNMM 190612E-OR	T8330	1.2	■	140	0.45	9.0	■	80	0.41	9.0	■	130	0.45	9.0	■	–	–	–	■	35	0.36	7.2	■	–	–	–
	T8430	1.2	■	140	0.45	9.0	■	75	0.41	9.0	■	115	0.45	9.0	■	–	–	–	■	30	0.36	7.2	■	–	–	–
CNMM 190616E-OR	T9315	1.2	■	195	0.45	9.0	■	–	–	–	■	185	0.45	9.0	■	–	–	–	■	–	–	–	■	–	–	–
	T9325	1.2	■	175	0.45	9.0	■	105	0.41	9.0	■	165	0.45	9.0	■	–	–	–	■	35	0.36	7.2	■	–	–	–
	T9335	1.2	■	150	0.45	9.0	■	90	0.41	9.0	■	–	–	–	■	–	–	–	■	30	0.36	7.2	■	–	–	–
	T8330	1.6	■	140	0.50	9.0	■	80	0.45	9.0	■	130	0.50	9.0	■	–	–	–	■	35	0.40	7.2	■	–	–	–
	T8345	1.6	■	120	0.50	9.0	■	70	0.45	9.0	■	110	0.50	9.0	■	–	–	–	■	30	0.40	7.2	■	–	–	–
CNMM 190624E-OR	T8430	1.6	■	140	0.50	9.0	■	75	0.45	9.0	■	115	0.50	9.0	■	–	–	–	■	30	0.40	7.2	■	–	–	–
	T9315	1.6	■	195	0.50	9.0	■	–	–	–	■	185	0.50	9.0	■	–	–	–	■	–	–	–	■	–	–	–
	T9325	1.6	■	175	0.50	9.0	■	105	0.45	9.0	■	165	0.50	9.0	■	–	–	–	■	35	0.40	7.2	■	–	–	–
	T9335	1.6	■	155	0.50	9.0	■	90	0.45	9.0	■	–	–	–	■	–	–	–	■	30	0.40	7.2	■	–	–	–
	T9315	2.4	■	165	0.80	9.0	■	–	–	–	■	155	0.80	9.0	■	–	–	–	■	–	–	–	■	–	–	–
CNMM 250924E-OR	T9325	2.4	■	150	0.80	9.0	■	90	0.72	9.0	■	140	0.80	9.0	■	–	–	–	■	30	0.56	7.2	■	–	–	–
	T8330	2.4	■	75	1.00	12.0	■	45	0.90	12.0	■	70	1.00	12.0	■	–	–	–	■	15	0.70	9.6	■	–	–	–
	T8430	2.4	■	75	1.00	12.0	■	40	0.90	12.0	■	60	1.00	12.0	■	–	–	–	■	15	0.70	9.6	■	–	–	–
	T9315	2.4	■	100	1.00	12.0	■	–	–	–	■	95	1.00	12.0	■	–	–	–	■	–	–	–	■	–	–	–
	T9325	2.4	■	95	1.00	12.0	■	55	0.90	12.0	■	90	1.00	12.0	■	–	–	–	■	20	0.70	9.6	■	–	–	–
T9335	2.4	■	75	1.00	12.0	■	45	0.90	12.0	■	–	–	–	■	–	–	–	■	15	0.70	9.6	■	–	–	–	

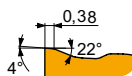
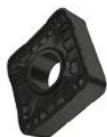

OR1 geometry for semi-rough to heavy-rough machining, and continuous to interrupted cuts.

CNMM 190616E-OR1	T9325	1.6	■	175	0.50	9.0	■	105	0.45	9.0	■	165	0.50	9.0	■	–	–	–	■	35	0.35	7.2	■	–	–	–
	T9335	1.6	■	155	0.50	9.0	■	90	0.45	9.0	■	–	–	–	■	–	–	–	■	30	0.35	7.2	■	–	–	–

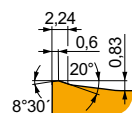

Geometry 923 for semi-rough to heavy-rough machining, and continuous to heavy interrupted cuts.

CNMM 250924S-923	T8330	2.4	■	75	0.85	12.0	■	45	0.77	12.0	■	70	0.85	12.0	■	–	–	–	■	15	0.60	9.6	■	–	–	–
	T8430	2.4	■	75	0.85	12.0	■	40	0.77	12.0	■	60	0.85	12.0	■	–	–	–	■	15	0.60	9.6	■	–	–	–
	T9335	2.4	■	75	0.85	12.0	■	45	0.77	12.0	■	–	–	–	■	–	–	–	■	15	0.60	9.6	■	–	–	–



CNGA CER

	IC	D1	L	S
	[mm]	[mm]	[mm]	[mm]
1204	12.700	5.16	12.90	4.76

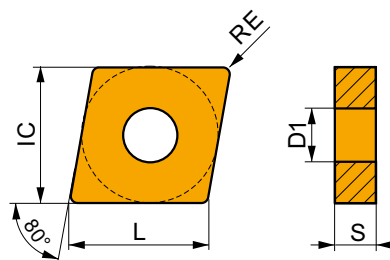

Suitability and starting values for cutting speed (vc), feed (f) and depth of cut (ap). Refer to our Machining Calculator app for further calculations.

Product	RE	P			M			K			N			S			H		
		vc	f	ap	vc	f	ap	vc	f	ap	vc	f	ap	vc	f	ap	vc	f	ap
	[mm]	[m/min]	[mm/rev]	[mm]	[m/min]	[mm/rev]	[mm]	[m/min]	[mm/rev]	[mm]	[m/min]	[mm/rev]	[mm]	[m/min]	[mm/rev]	[mm]	[m/min]	[mm/rev]	[mm]

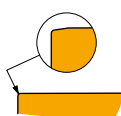
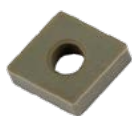

For machining with high speeds and continuous cuts.

CNGA 120404 T02020	TC100	0.4	-	-	-	-	-	-	590	0.10	2.0	-	-	-	-	-	-	-	-	-
CNGA 120408 T01020	TC100	0.8	-	-	-	-	-	-	550	0.20	2.0	-	-	-	-	-	-	-	-	-
CNGA 120412 T01020	TC100	1.2	-	-	-	-	-	-	540	0.25	2.0	-	-	-	-	-	-	-	-	-

CNGN CER

	IC	L	S
	[mm]	[mm]	[mm]
1204	12.700	12.90	4.76
1207	12.700	12.90	7.94

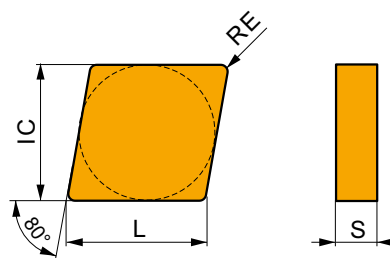

Suitability and starting values for cutting speed (vc), feed (f) and depth of cut (ap). Refer to our Machining Calculator app for further calculations.

Product	RE	P			M			K			N			S			H		
		vc	f	ap	vc	f	ap	vc	f	ap	vc	f	ap	vc	f	ap	vc	f	ap
	[mm]	[m/min]	[mm/rev]	[mm]	[m/min]	[mm/rev]	[mm]	[m/min]	[mm/rev]	[mm]	[m/min]	[mm/rev]	[mm]	[m/min]	[mm/rev]	[mm]	[m/min]	[mm/rev]	[mm]

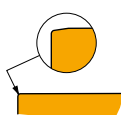
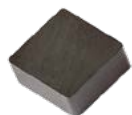

For machining with high speeds and continuous cuts.

CNGN 120408 T01020	TC100	0.8	-	-	-	-	-	-	550	0.20	2.0	-	-	-	-	-	-	-	-	-
CNGN 120708 T01020	TC100	0.8	-	-	-	-	-	-	550	0.20	2.0	-	-	-	-	-	-	-	-	-
CNGN 120712 T01020	TC100	1.2	-	-	-	-	-	-	540	0.25	2.0	-	-	-	-	-	-	-	-	-



DCBN(RL) EXT



PRAMET

D



External Double Clamp Turning Holder with 75° Cutting Angle for CN.. Insert

External Right/Left hand double clamp 75° tool holder. Suited for longitudinal and face turning without shoulder and chamfering with negative CN.. 12 up to 19 size inserts. Available with shanks 20x20 up to 40x40 mm. Body treated for longer tool life.

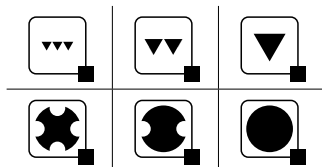
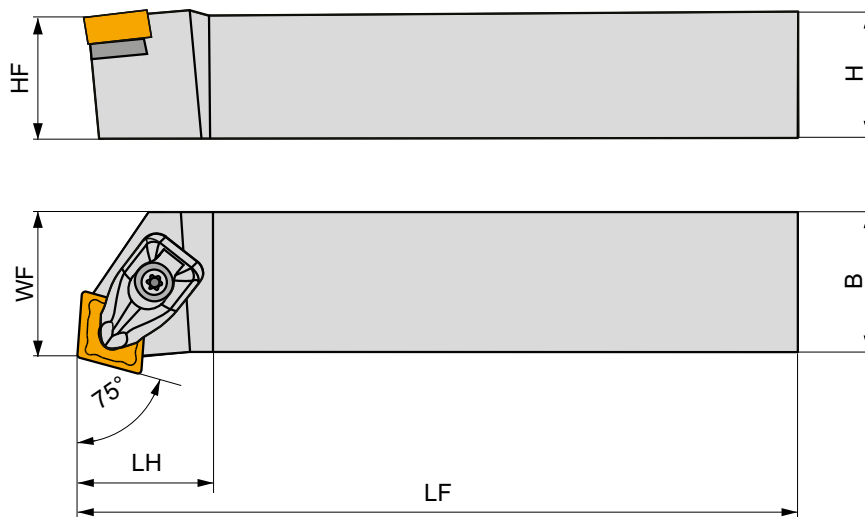

Product	H	B	H ₁	WF	LF	LH	LAMS	GAMO	kg				
	[mm]	[mm]	[mm]	[mm]	[mm]	[mm]	[°]	[°]					
R	DCBNR 2020 K 12	20	20	20	17	125	34.2	-6	-6	0.43	GI043	DC12	AT001
	DCBNR 2525 M 12	25	25	25	22	150	34.6	-6	-6	0.76	GI043	DC12	AT001
	DCBNR 3225 P 12	32	25	32	22	170	34.6	-6	-6	1.09	GI043	DC12	AT001
	DCBNR 2525 M 16	25	25	25	22	150	41.5	-6	-6	0.80	GI050	DC16	AT005
	DCBNR 3225 P 16	32	25	32	22	170	32	-6	-6	1.11	GI050	DC16	AT005
	DCBNR 3232 P 19	32	32	32	27	170	46.1	-6	-6	1.39	GI042	DC19	-
	DCBNR 4040 S 19	40	40	40	35	250	46.7	-6	-6	3.16	GI042	DC19	-
L	DCBNL 2020 K 12	20	20	20	17	125	34.2	-6	-6	0.43	GI043	DC12	AT001
	DCBNL 2525 M 12	25	25	25	22	150	34.6	-6	-6	0.76	GI043	DC12	AT001
	DCBNL 3225 P 12	32	25	32	22	170	34.6	-6	-6	1.09	GI043	DC12	AT001
	DCBNL 2525 M 16	25	25	25	22	150	41.5	-6	-6	0.79	GI050	DC16	AT005
	DCBNL 3225 P 16	32	25	32	22	170	32	-6	-6	1.11	GI050	DC16	AT005
	DCBNL 3232 P 19	32	32	32	27	170	46.1	-6	-6	1.39	GI042	DC19	-







GI042
GI043
GI050

CN.. 1906..
CN.. 1204..
CN.. 1606..



DC12	DCS 12	3.9	DCS 234-01	US 2002-T15P	FLAG T15P/3,5	-
DC16	DCS 16	6.4	DCS 234-03	US 2007-T20P	-	LK T20P
DC19	DCS 19	6.4	DCS 236-01	US 2007-T20P	-	LK T20P



			
AT001a	CN.. 1207..	–	DCS 234-02
AT005a	CN.. 1607..	–	DCS 234-04
AT001b	CER CN.N 1204..	DCS 12C4	–
AT001c	CER CN.A 1204..	DCS 12C2	–
AT005b	CER CN.N 1606..	DCS 16C4	–
AT005c	CER CN.A 1606..	DCS 16C2	–



DCKN(RL) EXT



External Double Clamp Holder, 75° (Face) Cutting Angle for CN.. Insert

External Right/Left hand double clamp 75° tool holder. Suited for face turning and occasionally chamfering with negative CN.. 12 or 16 size inserts. Available with shanks 20x20 up to 32x32 mm. Body treated for longer tool life.

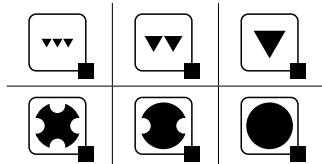
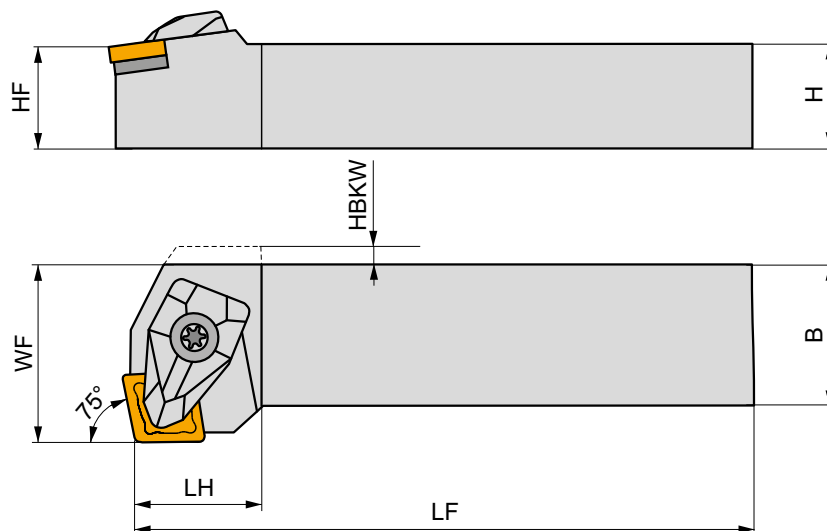
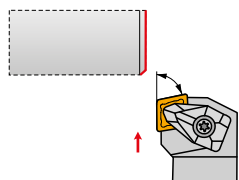

Product	H	B	HF	WF	LF	LH	HBKW	LAMS	GAMO	kg			
	[mm]	[mm]	[mm]	[mm]	[mm]	[mm]	[mm]	[°]	[°]				
R DCKNR 2020 K 12	20	20	20	25	125	21.2	4.5	-6	-6	0.46	G1043	DC12	AT001
DCKNR 2525 M 12	25	25	25	32	150	21.1	-	-6	-6	0.80	G1043	DC12	AT001
DCKNR 3225 P 12	32	25	32	32	170	21.1	-	-6	-6	1.14	G1043	DC12	AT001
DCKNR 3232 P 16	32	32	32	40	170	26	-	-6	-6	1.46	G1050	DC16	AT005
L DCKNL 2020 K 12	20	20	20	25	125	21.2	4.5	-6	-6	0.46	G1043	DC12	AT001
DCKNL 2525 M 12	25	25	25	32	150	21.1	-	-6	-6	0.80	G1043	DC12	AT001
DCKNL 3225 P 12	32	25	32	32	170	21.1	-	-6	-6	1.13	G1043	DC12	AT001
DCKNL 3232 P 16	32	32	32	40	170	26	-	-6	-6	1.46	G1050	DC16	AT005

G1043		CN.. 1204..	
G1050		CN.. 1606..	

DC12	DCS 12	3.9	DCS 234-01	US 2002-T15P	FLAG T15P/3,5	-
DC16	DCS 16	6.4	DCS 234-03	US 2007-T20P	-	LK T20P

AT001a	CN.. 1207..	DCS 234-02
AT005a	CN.. 1607..	DCS 234-04
AT001b	CER CN.N 1204..	DCS 12C4
AT001c	CER CN.A 1204..	DCS 12C2
AT005b	CER CN.N 1606..	DCS 16C4
AT005c	CER CN.A 1606..	DCS 16C2

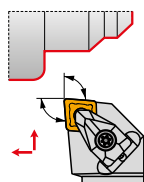

DCLN(RL) EXT

External Double Clamp Turning Holder with 95° Cutting Angle for CN.. Insert

External Right/Left hand double clamp 95° tool holder. Suited for longitudinal turning, chamfering and facing with shoulder, using negative CN.. 09 up to 19 size inserts and available in 16x16 up to 40x40 mm shanks. Body treated for longer tool life.

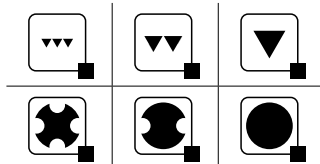
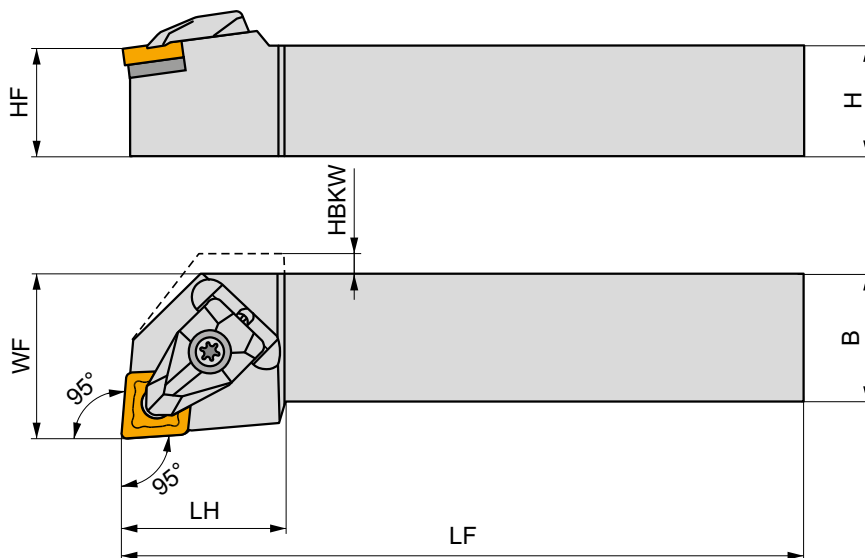

Product	H	B	HF	WF	LF	LH	HBKW	LAMS	GAMO	kg			
	[mm]	[mm]	[mm]	[mm]	[mm]	[mm]	[mm]	[°]	[°]				
R	DCLNR 1616 H 09	16	16	16	20	100	25	-	-6	0.27	G1133	DC09	-
	DCLNR 2020 K 09	20	20	20	25	125	25	-	-6	0.44	G1133	DC09	-
	DCLNR 2525 M 09	25	25	25	32	150	25	-	-6	0.78	G1133	DC09	-
	DCLNR 1616 H 12	16	16	16	20	100	32.3	4.5	-6	0.26	G1043	DC12	AT001
	DCLNR 2020 K 12	20	20	20	25	125	30	-	-6	0.44	G1043	DC12	AT001
	DCLNR 2525 M 12	25	25	25	32	150	30	-	-6	0.78	G1043	DC12	AT001
	DCLNR 3225 P 12	32	25	32	32	170	30	-	-6	1.10	G1043	DC12	AT001
	DCLNR 2525 M 16	25	25	25	32	150	39	-	-6	0.81	G1050	DC16	AT005
	DCLNR 3225 P 16	32	25	32	32	170	35	-	-6	1.20	G1050	DC16	AT005
	DCLNR 3232 P 19	32	32	32	40	170	40	-	-6	1.55	G1042	DC19	-
DCLNR 4040 S 19	40	40	40	50	250	43.4	-	-6	3.26	G1042	DC19	-	
L	DCLNL 1616 H 09	16	16	16	20	100	24.8	-	-6	0.22	G1133	DC09	-
	DCLNL 2020 K 09	20	20	20	25	125	24.8	-	-6	0.42	G1133	DC09	-
	DCLNL 2525 M 09	25	25	25	32	150	24.8	-	-6	0.76	G1133	DC09	-
	DCLNL 1616 H 12	16	16	16	20	100	32.2	4.5	-6	0.26	G1043	DC12	AT001
	DCLNL 2020 K 12	20	20	20	25	125	32	-	-6	0.44	G1043	DC12	AT001
	DCLNL 2525 M 12	25	25	25	32	150	32	-	-6	0.78	G1043	DC12	AT001
	DCLNL 3225 P 12	32	25	32	32	170	32	-	-6	1.10	G1043	DC12	AT001
	DCLNL 2525 M 16	25	25	25	32	150	39	-	-6	0.81	G1050	DC16	AT005
	DCLNL 3225 P 16	32	25	32	32	170	39	-	-6	1.20	G1050	DC16	AT005
	DCLNL 3232 P 19	32	32	32	40	170	43.2	-	-6	1.51	G1042	DC19	-
DCLNL 4040 S 19	40	40	40	50	250	43.4	-	-6	3.26	G1042	DC19	-	



G1042
G1043



CN.. 1906..
CN.. 1204..



GI050
GI133

CN.. 1606..
CN.. 0903..



DC09
DC12
DC16
DC19
DCI12

DCS 09
DCS 12
DCS 16
DCS 19
DCS 12

1.7
3.9
6.4
6.4
3.9

DCS 236-04
DCS 234-01
DCS 234-03
DCS 236-01
DCS 236-03

US 2004-T09P
US 2002-T15P
US 2007-T20P
US 2007-T20P
US 2002-T15P

FLAG T09P
FLAG T15P/3,5
-
-
FLAG T15P/3,5

-
-
LK T20P
LK T20P
-



AT001a
AT005a
AT001b
AT001c
AT005b
AT005c

CN.. 1207..
CN.. 1607..
CER CN.N 1204..
CER CN.A 1204..
CER CN.N 1606..
CER CN.A 1606..

-
-
DCS 12C4
DCS 12C2
DCS 16C4
DCS 16C2

DCS 234-02
DCS 234-04
-
-
-
-



PCBN(RL) EXT

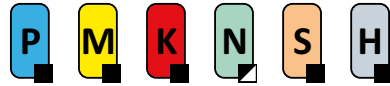

External Lever Lock Turning Holder with 75° Cutting Angle for CN.. Insert

External Right/Left hand lever lock 75° tool holder. Suited for external chamfering, taper and longitudinal turning without shoulder, using negative CN.. 12, 16, 19 or 25 size inserts. Available in 20x20 up to 50x50 mm shanks. Body treated for longer tool life.

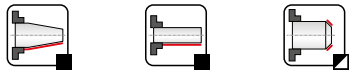
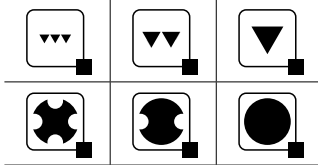
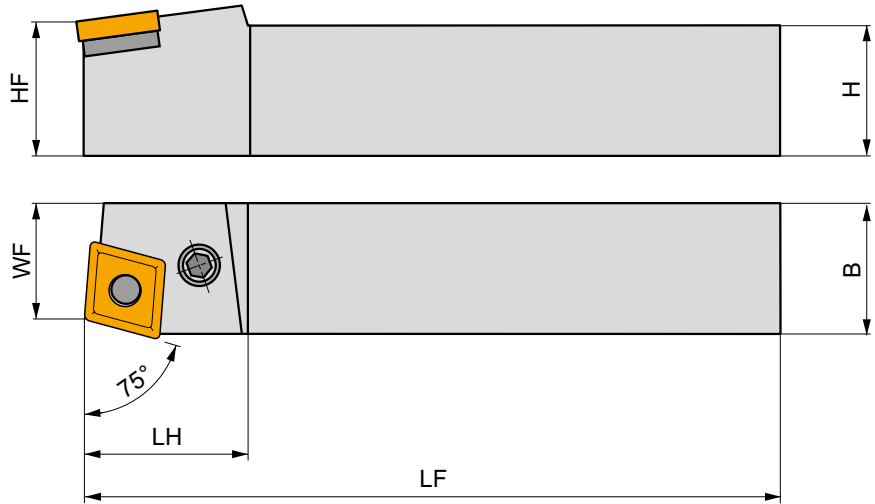
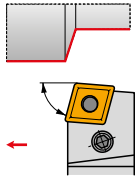

Product	H	B	HF	WF	LF	LH	LAMS	GAMO	kg			
	[mm]	[mm]	[mm]	[mm]	[mm]	[mm]	[°]	[°]				
R	PCBNR 2020 K 12	20	20	20	17	125	36	-6	-6	0.43	GI043	PC22
	PCBNR 2525 M 12	25	25	25	22	150	36	-6	-6	0.63	GI043	PC20
	PCBNR 3225 P 12	32	25	32	22	170	36	-6	-6	0.70	GI043	PC20
	PCBNR 3232 P 16	32	32	32	27	170	40	-6	-6	1.36	GI050	PC40
	PCBNR 3232 P 19	32	32	32	27	170	45	-6	-6	1.10	GI042	PC50
	PCBNR 4040 S 19	40	40	40	35	250	45	-6	-6	3.15	GI042	PC50
	PCBNR 4040 S 25	40	40	40	35	250	45	-6	-6	3.10	GI062	PC60
PCBNR 5050 T 25	50	50	50	43	300	50	-6	-6	5.80	GI062	PC60	
L	PCBNL 2020 K 12	20	20	20	17	125	36	-6	-6	0.38	GI043	PC22
	PCBNL 2525 M 12	25	25	25	22	150	36	-6	-6	0.73	GI043	PC20
	PCBNL 3225 P 12	32	25	32	22	170	36	-6	-6	0.70	GI043	PC20
	PCBNL 3232 P 16	32	32	32	27	170	40	-6	-6	1.25	GI050	PC40
	PCBNL 3232 P 19	32	32	32	27	170	45	-6	-6	1.10	GI042	PC50
	PCBNL 4040 S 19	40	40	40	35	250	45	-6	-6	3.15	GI042	PC50
	PCBNL 4040 S 25	40	40	40	35	250	45	-6	-6	3.15	GI062	PC60
PCBNL 5050 T 25	50	50	50	43	300	50	-6	-6	5.80	GI062	PC60	



GI042

CN.. 1906..

GI043

CN.. 1204..

GI050

CN.. 1606..

GI062

CN.. 2509..



PC20

CNU 120312

PU 02

US 35

6.0

M 8x1

22.5

NT 05

MT 05

HXK 4

PC22

CNU 120312

PU 02

US 42

6.0

M 8x1

21

NT 05

MT 05

HXK 4

PC40

CNU 150312

PU 04

US 36

6.0

M 8x1

26

NT 07

MT 07

HXK 4

PC50

CNU 190416

PU 05

US 38

8.0

M 10x1

29

NT 06

MT 06

HXK 5

PC60

CNU 250620

PU 06

US 39

8.0

M 10x1

33

NT 08

MT 08

HXK 5



PCKN(RL) EXT



PRAMET

P



External Lever Lock Holder, 75° (Face Turning) Cutting Angle for CN.. Insert

External Right/Left hand lever lock 75° tool holder. Suited for external chamfering and face turning with shoulder using negative CN.. 12, 16 or 19 size inserts. Available in 20x20 up to 40x40 mm shanks. Body treated for longer tool life.

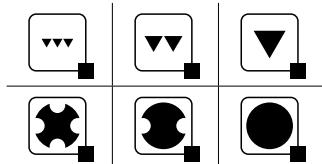
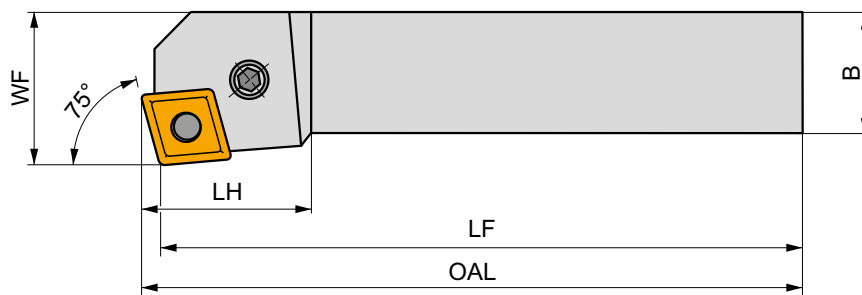
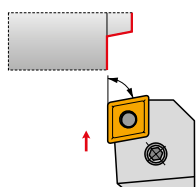

Product	H	B	HF	WF	LF	LH	LAMS	GAMO	kg			
	[mm]	[mm]	[mm]	[mm]	[mm]	[mm]	[°]	[°]				
R	PCKNR 2020 K 12	20	20	20	25	125	36	-6	-6	0.42	G1043	PC22
	PCKNR 2525 M 12	25	25	25	32	150	36	-6	-6	0.79	G1043	PC20
	PCKNR 3225 P 12	32	25	32	32	170	36	-6	-6	0.85	G1043	PC20
	PCKNR 3232 P 16	32	32	32	40	170	40	-6	-6	1.43	G1050	PC40
	PCKNR 3232 P 19	32	32	32	40	170	45	-6	-6	1.40	G1042	PC50
L	PCKNR 4040 S 19	40	40	40	50	250	45	-6	-6	3.25	G1042	PC50
	PCKNL 2020 K 12	20	20	20	25	125	36	-6	-6	0.42	G1043	PC22
	PCKNL 2525 M 12	25	25	25	32	150	36	-6	-6	0.78	G1043	PC20
	PCKNL 3225 P 12	32	25	32	32	170	36	-6	-6	1.15	G1043	PC20
	PCKNL 3232 P 16	32	32	32	40	170	40	-6	-6	1.40	G1050	PC40
PCKNL 3232 P 19	32	32	32	40	170	45	-6	-6	1.40	G1042	PC50	
PCKNL 4040 S 19	40	40	40	50	250	45	-6	-6	3.27	G1042	PC50	



G1042

G1043

G1050



CN.. 1906..

CN.. 1204..

CN.. 1606..



PC20

CNU 120312

PU 02

US 35

6.0

M 8x1

22.5

NT 05

MT 05

HXK 4

PC22

CNU 120312

PU 02

US 42

6.0

M 8x1

21

NT 05

MT 05

HXK 4

PC40

CNU 150312

PU 04

US 36

6.0

M 8x1

26

NT 07

MT 07

HXK 4

PC50

CNU 190416

PU 05

US 38

8.0

M 10x1

29

NT 06

MT 06

HXK 5



PCLN(RL) EXT



External Lever Lock Turning Holder with 95° Cutting Angle for CN.. Insert

External Right/Left hand lever lock 95° tool holder. Suited for external taper, face, longitudinal with shoulder turning and chamfering with negative CN.. 12, 16, 19 or 25 size inserts. Available in 20x20 up to 50x50 mm shanks. Body treated for longer tool life.

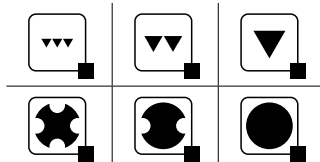
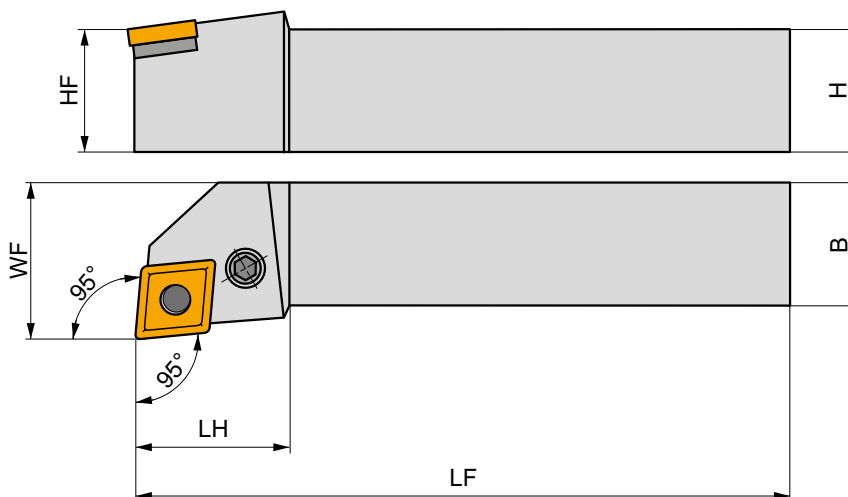
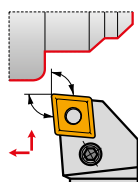

Product	H	B	HF	WF	LF	LH	LAMS	GAMO	kg			
	[mm]	[mm]	[mm]	[mm]	[mm]	[mm]	[°]	[°]				
R	PCLNR 2020 K 12	20	20	20	25	125	36	-6	-6	0.44	GI043	PC22
	PCLNR 2525 M 12	25	25	25	32	150	36	-6	-6	0.68	GI043	PC20
	PCLNR 3225 P 12	32	25	32	32	170	36	-6	-6	0.98	GI043	PC20
	PCLNR 3225 P 16	32	25	32	32	170	40	-6	-6	1.10	GI050	PC40
	PCLNR 3232 P 19	32	32	32	40	170	45	-6	-6	1.40	GI042	PC50
	PCLNR 4040 R 19	40	40	40	50	200	45	-6	-6	2.50	GI042	PC50
	PCLNR 4040 S 19	40	40	40	50	250	45	-6	-6	3.19	GI042	PC50
	PCLNR 4040 S 25	40	40	40	50	250	45	-6	-6	3.15	GI062	PC60
	PCLNR 5050 T 25	50	50	50	60	300	50	-6	-6	5.90	GI062	PC60
	L	PCLNL 2020 K 12	20	20	20	25	125	36	-6	-6	0.42	GI043
PCLNL 2525 M 12		25	25	25	32	150	36	-6	-6	0.75	GI043	PC20
PCLNL 3225 P 12		32	25	32	32	170	36	-6	-6	1.10	GI043	PC20
PCLNL 3225 P 16		32	25	32	32	170	40	-6	-6	1.10	GI050	PC40
PCLNL 3232 P 19		32	32	32	40	170	45	-6	-6	1.42	GI042	PC50
PCLNL 4040 R 19		40	40	40	50	200	45	-6	-6	2.60	GI042	PC50
PCLNL 4040 S 19		40	40	40	50	250	45	-6	-6	3.19	GI042	PC50
PCLNL 4040 S 25		40	40	40	50	250	45	-6	-6	2.45	GI062	PC60
PCLNL 5050 T 25		50	50	50	60	300	50	-6	-6	5.90	GI062	PC60



GI042

CN.. 1906..

GI043

CN.. 1204..











GI050

CN.. 1606..

GI062

CN.. 2509..



									
PC20	CNU 120312	PU 02	US 35	6.0	M 8x1	22.5	NT 05	MT 05	HXX 4
PC22	CNU 120312	PU 02	US 42	6.0	M 8x1	21	NT 05	MT 05	HXX 4
PC40	CNU 150312	PU 04	US 36	6.0	M 8x1	26	NT 07	MT 07	HXX 4
PC50	CNU 190416	PU 05	US 38	8.0	M 10x1	29	NT 06	MT 06	HXX 5
PC60	CNU 250620	PU 06	US 39	8.0	M 10x1	33	NT 08	MT 08	HXX 5



C.-DCLN(RL) EXT

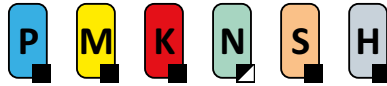

Ext. PSC Quick Change Tool, Double Clamp, 95° Cutting Angle for CN.. Insert

External Right/Left hand double clamp tool, through coolant, with 95° cutting angle for longitudinal turning, chamfering and face turning with shoulder, using negative CN.. 12 up to 19 size inserts. Available with PSC (Polygon Shank Coupling) C3 up to C8. Body treated for longer tool life.

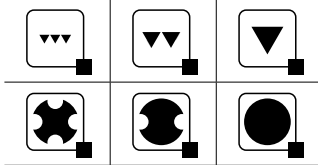
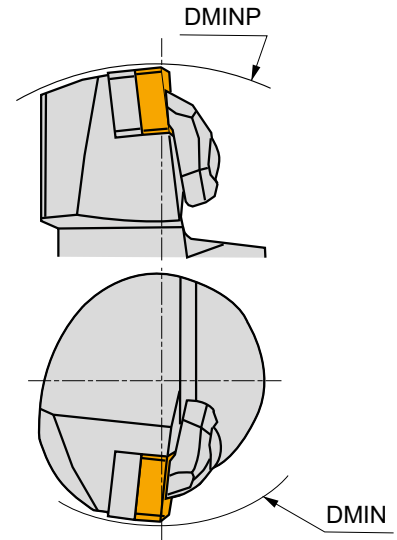
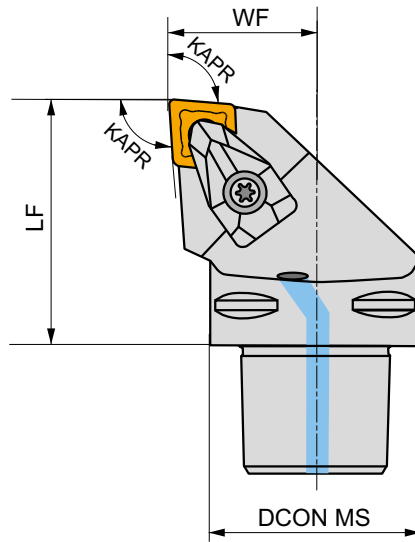
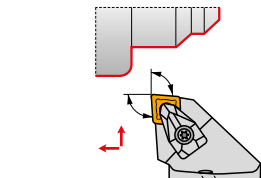

Product	DCON MS	DMIN	DMINP	WF	LF	KAPR	LAMS	GAMO						
	[mm]	[mm]	[mm]	[mm]	[mm]	[°]	[°]	[°]						
R	C3-DCLNR-22045-12	32	60	121	22	45	95	-6	-6	✓	0.25	GI043	C-DC12	AT001
	C4-DCLNR-27050-12	40	110	140	27	50	95	-6	-6	✓	0.44	GI043	C-DC12	AT001
	C4-DCLNR-27055-16	40	125	145	27	55	95	-6	-6	✓	0.47	GI050	C-DC16	AT005
	C5-DCLNR-35060-12	50	110	165	35	60	95	-6	-6	✓	0.79	GI043	C-DC12	AT001
	C5-DCLNR-35060-16	50	125	165	35	60	95	-6	-6	✓	0.80	GI050	C-DC16	AT005
	C6-DCLNR-45065-12	63	110	190	45	65	95	-6	-6	✓	1.32	GI043	C-DC12	AT001
	C6-DCLNR-45065-16	63	125	190	45	65	95	-6	-6	✓	1.34	GI050	C-DC16	AT005
	C6-DCLNR-45065-19	63	81	190	45	65	95	-6	-6	✓	1.34	GI042	C-DC19	-
C8-DCLNR-55080-19	80	100	250	55	80	95	-6	-6	✓	2.58	GI042	C-DC19	-	
L	C4-DCLNL-27050-12	40	110	140	27	50	95	-6	-6	✓	0.44	GI043	C-DC12	AT001
	C4-DCLNL-27055-16	40	125	145	27	55	95	-6	-6	✓	0.48	GI050	C-DC16	AT005
	C5-DCLNL-35060-12	50	110	165	35	60	95	-6	-6	✓	0.79	GI043	C-DC12	AT001
	C5-DCLNL-35060-16	50	125	165	35	60	95	-6	-6	✓	0.80	GI050	C-DC16	AT005
	C6-DCLNL-45065-12	63	110	190	45	65	95	-6	-6	✓	1.32	GI043	C-DC12	AT001
	C6-DCLNL-45065-16	63	125	190	45	65	95	-6	-6	✓	1.34	GI050	C-DC16	AT005
	C6-DCLNL-45065-19	63	81	190	45	65	95	-6	-6	✓	1.34	GI042	C-DC19	-
	C8-DCLNL-55080-16	80	125	250	55	80	95	-6	-6	✓	2.58	GI050	C-DC16	AT005
C8-DCLNL-55080-19	80	100	250	55	80	95	-6	-6	✓	2.58	GI042	C-DC19	-	



GI042

CN.. 1906..









GI043





CN.. 1204..

GI050

CN.. 1606..



		 Nm					
C-DC12	DCS 12	3.9	DCS 234-01	US 2002-T15P	FLAG T15P/3,5	–	CN 045-01
C-DC16	DCS 16	6.4	DCS 234-03	US 2007-T20P	–	LK T20P	CN 045-01
C-DC19	DCS 19	6.4	DCS 236-01	US 2007-T20P	–	LK T20P	CN 045-01

			
AT001a	CN.. 1207..	–	DCS 234-02
AT005a	CN.. 1607..	–	DCS 234-04
AT001b	CER CN.N 1204..	DCS 12C4	–
AT001c	CER CN.A 1204..	DCS 12C2	–
AT005b	CER CN.N 1606..	DCS 16C4	–
AT005c	CER CN.A 1606..	DCS 16C2	–



KHP-CBN(RL)



Modular KHP Lever Lock Turning Cartridge, 75° Cutting Angle for CN.. Inserts

Dovetailed Right/Left hand lever lock turning cartridge, 75° Cutting Angle, for mounting on DKH tool holder shank. Suited for heavy longitudinal turning without shoulder, face turning, taper and chamfer turning with negative CN.. 25 inserts. Tool holder treated for longer tool life.

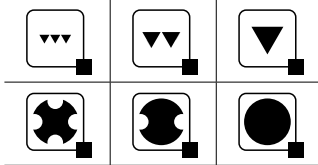
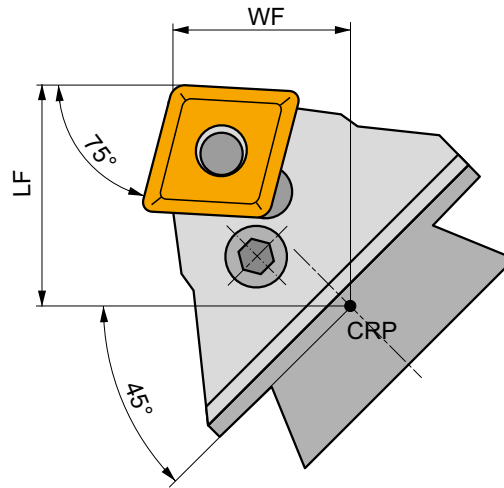
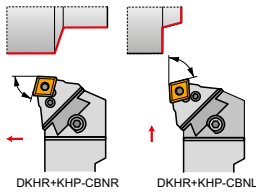

Product	WF (mm)	LF (mm)	LAMS (°)	GAMO (°)	kg		
R KHP-CBNR 25	32	47	-6	-6	1.54	GI062	PC60
L KHP-CBNL 25	32	47	-6	-6	1.56	GI062	PC60



GI062



CN.. 2509..



PC60



CNU 250620



PU 06



US 39



8.0



M 10x1



33



NT 08



MT 08



HXK 5



KHP-CLN(RL)



PRAMET

P



Modular KHP Lever Lock Turning Cartridge, 95° Cutting Angle for CN.. Inserts

Dovetailed Right/Left hand lever lock turning cartridge, 95° Cutting Angle, for mounting on DKH tool holder shank. Suited for heavy longitudinal turning with shoulder, face turning with shoulder, taper and chamfer turning with negative CN.. 19 or 25 insert. Tool holder treated for longer tool life.

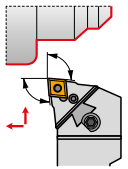

DKHR+KHP-CLNR

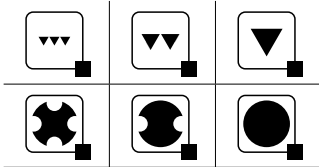
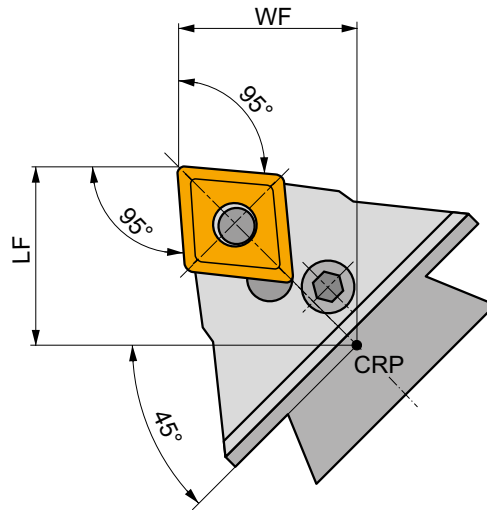

Product	WF	LF	LAMS	GAMO	kg		
	[mm]	[mm]	[°]	[°]			
R KHP-CLNR 19	35	45	-6	-6	1.30	GI042	PC50
	KHP-CLNR 25	35	45	-6	-6	1.25	GI062
L KHP-CLNL 19	35	45	-6	-6	1.30	GI042	PC50
	KHP-CLNL 25	35	45	-6	-6	1.25	GI062

GI042	CN.. 1906..
GI062	CN.. 2509..

PC50	CNU 190416	PU 05	US 38	8.0	M 10x1	29	NT 06	MT 06	HXK 5
PC60	CNU 250620	PU 06	US 39	8.0	M 10x1	33	NT 08	MT 08	HXK 5



DKH(RL)



External Tool Holder Shank for KHP/KHS Heavy Turning Cartridges

Dovetailed Right/Left hand modular tool shank for KHP/KHS cartridges. Suited for heavy turning applications. Available with shank size 40x50 up to 60x80 mm. Body treated for longer tool life.

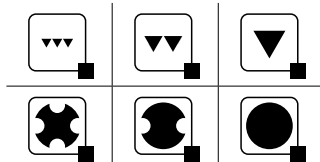
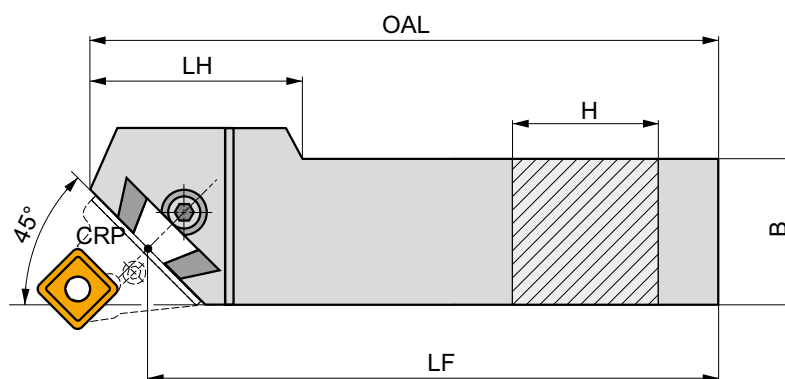
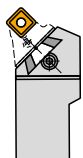

	Product	H	B	LF	OAL	LH	kg		
		[mm]	[mm]	[mm]	[mm]	[mm]			
R	DKHR 4050 V	40	50	400	425	100	7.10	GI098	DKH10
	DKHR 5060 W	50	60	450	475	110	11.30	GI098	DKH10
	DKHR 6080 W-A	60	80	450	485	90	19.65	GI098	DKH10
L	DKHL 4050 V	40	50	400	425	100	7.10	GI098	DKH10
	DKHL 5060 W	50	60	450	475	110	11.30	GI098	DKH10
	DKHL 6080 W-A	60	80	450	485	90	19.28	GI098	DKH10



GI098



KHP



KHS



DKH10



SR 14



HXK 10



DCLN(RL) INT



PRAMET

D



Internal Double Clamp Boring Bar with 95° Cutting Angle for CN.. Insert

Internal Right/Left hand double clamp boring bar, through coolant, 95° cutting angle for CN.. 09 and 12 inserts. Minimum internal turning diameter Ø32 mm. For internal taper and longitudinal turning with shoulder and chamfer turning. Available with shank size Ø25 up to Ø40 mm. Body treated for longer tool life.

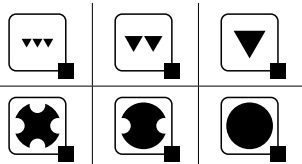
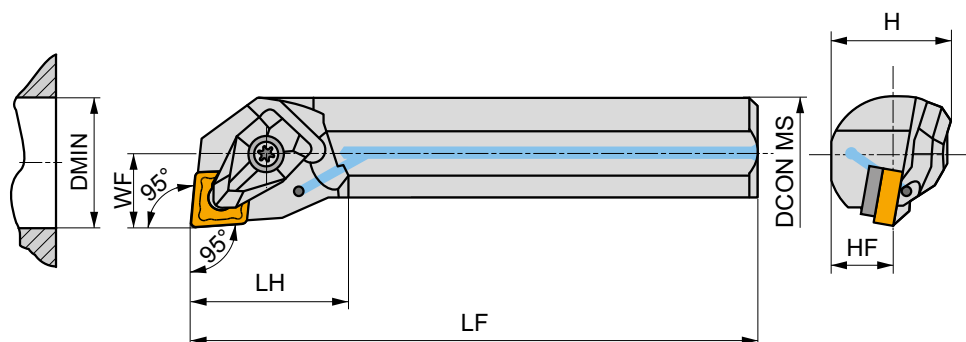
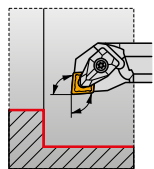

Product	DCON MS	DMIN	WF	H	HF	LF	LH	LAMS	GAMO				
	[mm]	[mm]	[mm]	[mm]	[mm]	[mm]	[mm]	[°]	[°]				
R	A25T-DCLNR 09	25	32	17	23	11.5	300	31	-11	-6	✓	1.13	G1133 DC09
	A25T-DCLNR 12	25	32	17	23	11.5	300	31	-12	-6	✓	1.12	G1043 DC12
	A32T-DCLNR 12	32	40	22	30	15	300	30	-10	-6	✓	1.68	G1043 DC12
	A40T-DCLNR 12	40	50	27	37	18.5	300	32	-15	-6	✓	2.56	G1043 DC12
L	A25T-DCLNL 09	25	32	17	23	11.5	300	31	-11	-6	✓	1.12	G1133 DC09
	A25T-DCLNL 12	25	32	17	23	11.5	300	31	-12	-6	✓	1.11	G1043 DC12
	A32T-DCLNL 12	32	40	22	30	15	300	30	-10	-6	✓	1.68	G1043 DC12
	A40T-DCLNL 12	40	50	27	37	18.5	300	32	-15	-6	✓	2.56	G1043 DC12



G1043

CN.. 1204..

G1133

CN.. 0903..



DC09

DCS 09

1.7

DCS 236-04

US 2004-T09P

FLAG T09P

DC12

DCS 12

3.9

DCS 234-01

US 2002-T15P

FLAG T15P/3,5

DC112

DCS 12

3.9

DCS 236-03

US 2002-T15P

FLAG T15P/3,5



PCLN(RL) INT

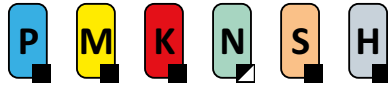

Internal Lever Lock Boring Bar with 95° Cutting Angle for CN.. Insert

Internal Right/Left hand lever lock boring bar, through coolant available, 95° cutting angle for CN.. 09, 12, 16 and 19 inserts. Minimum internal turning diameter $\varnothing 20$ mm. For internal taper and longitudinal turning with shoulder and chamfer turning. $\varnothing 16$ to $\varnothing 60$ mm shanks available. Body treated for longer tool life.

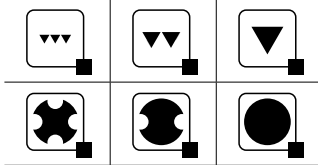
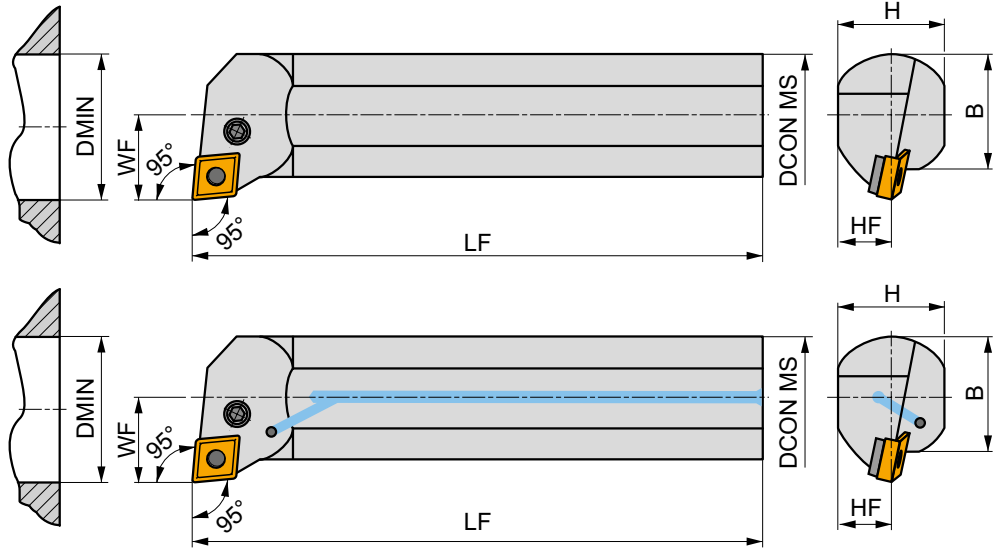
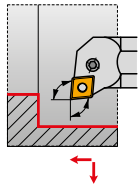

Product	DCON MS	DMIN	WF	H	B	LF	LAMS	GAMO				
	[mm]	[mm]	[mm]	[mm]	[mm]	[mm]	[°]	[°]				
R	A16M-PCLNR 09	16	20	11	15	15	-13.5	-5	✓	0.22	GI133	PC09
	A20Q-PCLNR 09	20	25	13	18	18	-13.5	-5	✓	0.36	GI133	PC09
	A25R-PCLNR 12	25	32	17	23	23	-13	-7	✓	0.65	GI043	PC25
	S25T-PCLNR 12	25	32	17	23	23	-13	-7	–	1.10	GI043	PC25
	A32S-PCLNR 12	32	40	22	30	30	-12	-6	✓	1.48	GI043	PC21
	A40T-PCLNR 12	40	50	27	38	38	-12	-6	✓	2.40	GI043	PC20
	A40T-PCLNR 16	40	50	27	38	38	-12	-6	✓	2.90	GI050	PC41
	A50U-PCLNR 16	50	63	35	47	48.5	-12	-6	✓	5.20	GI050	PC40
	A60V-PCLNR 16	60	80	43	57	58.5	-12	-6	✓	8.70	GI050	PC40
	A50U-PCLNR 19	50	63	35	47	48.5	-12	-6	✓	5.20	GI042	PC50
A60V-PCLNR 19	60	80	43	57	58.5	-12	-6	✓	8.22	GI042	PC50	
L	A16M-PCLNL 09	16	20	11	15	15	-13.5	-5	✓	0.20	GI133	PC09
	A20Q-PCLNL 09	20	25	13	18	18	-13.5	-5	✓	0.34	GI133	PC09
	A25R-PCLNL 12	25	32	17	23	23	-13	-7	✓	0.65	GI043	PC25
	S25T-PCLNL 12	25	32	17	23	23	-13	-7	–	1.15	GI043	PC25
	A32S-PCLNL 12	32	40	22	30	30	-12	-6	✓	1.48	GI043	PC21
	A40T-PCLNL 12	40	50	27	38	38	-12	-6	✓	2.58	GI043	PC20
	A40T-PCLNL 16	40	50	27	38	38	-12	-6	✓	2.58	GI050	PC41
	A50U-PCLNL 16	50	63	35	47	48.5	-12	-6	✓	4.95	GI050	PC40
	A60V-PCLNL 16	60	80	43	57	58.5	-12	-6	✓	8.70	GI050	PC40
	A50U-PCLNL 19	50	63	35	47	48.5	-12	-6	✓	5.20	GI042	PC50
A60V-PCLNL 19	60	80	43	57	58.5	-12	-6	✓	8.40	GI042	PC50	



GI042
GI043



CN.. 1906..
CN.. 1204..



GI050

CN.. 1606..

GI133

CN.. 0903..



PC09	–	PU 8451	PS 8290	2.0	M 5	12	–	–	HXX 2
PC20	CNU 120312	PU 02	US 35	6.0	M 8x1	22.5	NT 05	MT 05	HXX 4
PC21	CNU 120312	PU 02	US 41	6.0	M 8x1	17	NT 05	MT 05	HXX 4
PC25	–	PU 32	US 46	5.0	M 6x0.75	13.2	–	–	HXX 3
PC40	CNU 150312	PU 04	US 36	6.0	M 8x1	26	NT 07	MT 07	HXX 4
PC41	CNU 150312	PU 04	US 40	6.0	M 8x1	20.5	NT 07	MT 07	HXX 4
PC50	CNU 190416	PU 05	US 38	8.0	M 10x1	29	NT 06	MT 06	HXX 5



C.-DCLN(RL) INT



Int. PSC Quick Change Tool, Double Clamp, 95° Cutting Angle for CN.. Insert

Internal Right/Left hand double clamp tool, through coolant, with 95° cutting angle for negative CN.. 09 up to 16 inserts, Suited for a wide range of internal turning applications, minimum diameter Ø25mm. PSC shank (Polygon Shank Coupling) size C4 up to C6 with choice of lengths. Body treated for longer tool life.

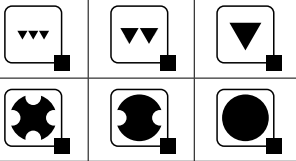
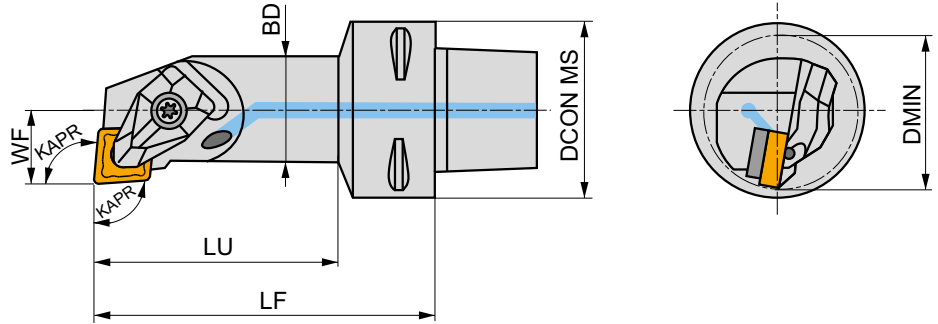
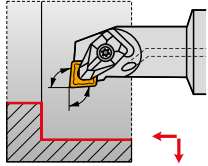

Product	DCON MS	DMIN	WF	LF	LU	BD	KAPR	LAMS	GAMO					
	[mm]	[mm]	[mm]	[mm]	[mm]	[mm]	[°]	[°]	[°]					
R	C4-DCLNR-13080-09	40	25	13	80	57	20	95	-14	-6	✓	0.43	GI133	DC09
	C4-DCLNR-17090-12	40	32	17	90	68	25	95	-12	-6	✓	0.53	GI043	DC12
	C5-DCLNR-17090-12	50	32	17	90	66	25	95	-12	-6	✓	0.72	GI043	DC12
	C6-DCLNR-17100-12	63	32	17	100	72	25	95	-12	-6	✓	1.15	GI043	DC12
C6-DCLNR-27140-16	63	50	27	140	114	40	95	-16	-6	✓	1.81	GI050	DC16	
L	C4-DCLNL-17090-12	40	32	17	90	68	25	95	-12	-6	✓	0.53	GI043	DC12
	C5-DCLNL-17090-12	50	32	17	90	66	25	95	-12	-6	✓	0.72	GI043	DC12



GI043	CN.. 1204..
GI050	CN.. 1606..
GI133	CN.. 0903..



DC09	DCS 09	1.7	DCS 236-04	US 2004-T09P	FLAGT09P	-
DC16	DCS 16	6.4	DCS 234-03	US 2007-T20P	-	LKT20P
DC12	DCS 12	3.9	DCS 236-03	US 2002-T15P	FLAG T15P/3,5	-



DN

11/ 15

CARBIDE INSERTS

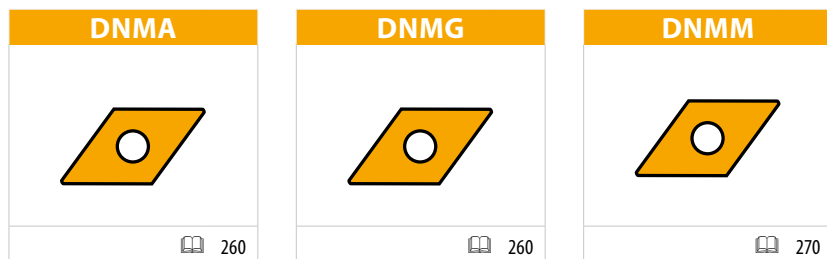

CER AND CBN INSERTS

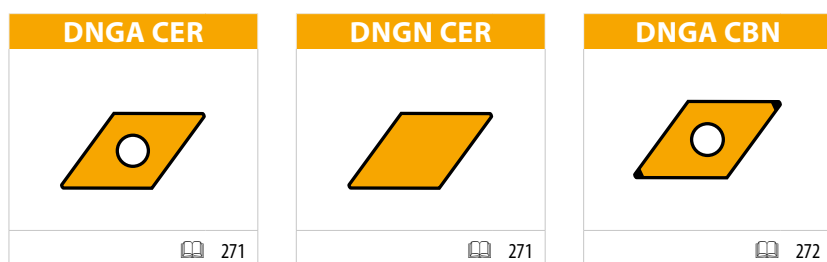

MATCH THE RIGHT SIZE (example)

Insert	Tool Holder
DNMG 150404E-SF	DDJNL 2020 K 15

ISO TURNING – EXTERNAL

DDJN(RL) EXT		PDJN(RL) EXT		PDNN(RL) EXT		PDXN(RL) EXT	
93°	DN..	93°	DN..	62°30'	DN..	98°	DN..
11 15		11 15		11 15		15	
20×20 32×32		20×20 32×32		20×20 32×25		20×20 32×25	
273	260 – 272	274	260 – 272	275	260 – 272	276	260 – 272
C.-DDJN(RL) EXT		C.-DDNNN EXT		C.-DDUN(RL) EXT			
93°	DN..	62,5°	DN..	93°	DN..		
11 15		15		15			
C4 C6		C5 C6		C5 C6			
277	260 – 272	278	260 – 272	279	260 – 272		



DN

11/ 15

ISO TURNING – INTERNAL

DDUN(RL) INT

93°

DN..

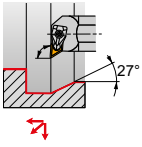
 11
15

 $\frac{25}{50}$

280

260 – 272

PDUN(RL) INT

93°

DN..

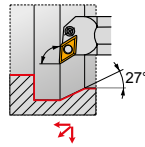
 11
15

 $\frac{25}{60}$

281

260 – 272

C.-DDUN(RL) INT

93°

DN..



11

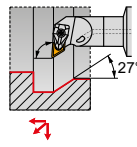

12

282

260 – 272



Suitability and starting values for cutting speed (vc), feed (f) and depth of cut (ap). Refer to our Machining Calculator app for further calculations.

Product	RE [mm]	P			M			K			N			S			H		
		vc	f	ap	vc	f	ap	vc	f	ap	vc	f	ap	vc	f	ap	vc	f	ap
		[m/min]	[mm/rev]	[mm]	[m/min]	[mm/rev]	[mm]	[m/min]	[mm/rev]	[mm]	[m/min]	[mm/rev]	[mm]	[m/min]	[mm/rev]	[mm]	[m/min]	[mm/rev]	[mm]

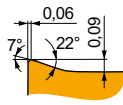

FF geometry with highly positive design for fine-finish machining and continuous to slightly interrupted cuts.

DNMG 150404E-FF	T8315	0.4	✓	175	0.12	1.0	■	105	0.11	1.0	■	165	0.12	1.0	–	–	–	–	–	–
DNMG 150604E-FF	T7325	0.4	✓	190	0.12	1.0	■	145	0.11	1.0	–	–	–	–	–	–	–	–	–	–
	T8315	0.4	✓	175	0.12	1.0	■	105	0.11	1.0	■	165	0.12	1.0	–	–	–	–	–	–
DNMG 150608E-FF	T7325	0.8	✓	210	0.15	1.0	■	160	0.14	1.0	–	–	–	–	–	–	–	–	–	–
	T8315	0.8	✓	195	0.15	1.0	■	115	0.14	1.0	■	185	0.15	1.0	–	–	–	–	–	–

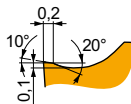

FM geometry with positive design for finish to semi-rough machining, and continuous to slightly interrupted cuts.

DNMG 110404E-FM	T7325	0.4	✓	165	0.20	0.8	■	125	0.18	0.8	–	–	–	–	–	–	✓	50	0.20	0.6	–	–	–	
	T8315	0.4	✓	150	0.20	0.8	■	90	0.18	0.8	■	140	0.20	0.8	–	–	–	✓	35	0.14	0.6	–	–	–
	T8330	0.4	■	145	0.20	0.8	■	85	0.18	0.8	■	135	0.20	0.8	–	–	–	✓	35	0.14	0.6	–	–	–
	T8430	0.4	■	165	0.20	0.8	■	90	0.18	0.8	■	135	0.20	0.8	–	–	–	✓	35	0.14	0.6	–	–	–
	T9310	0.4	■	245	0.20	0.8	–	–	–	–	■	230	0.20	0.8	–	–	–	–	–	–	–	–	–	–
	T9315	0.4	■	225	0.20	0.8	–	–	–	–	■	210	0.20	0.8	–	–	–	–	–	–	–	–	–	–
	T9325	0.4	■	200	0.20	0.8	■	120	0.18	0.8	■	190	0.20	0.8	–	–	–	✓	45	0.20	0.6	–	–	–
DNMG 110408E-FM	T7325	0.8	✓	200	0.20	0.8	■	155	0.18	0.8	–	–	–	–	–	–	–	✓	65	0.16	0.6	–	–	–
	T8315	0.8	✓	180	0.20	0.8	■	105	0.18	0.8	■	170	0.20	0.8	–	–	–	✓	45	0.14	0.6	–	–	–
	T8330	0.8	■	175	0.20	0.8	■	105	0.18	0.8	■	165	0.20	0.8	–	–	–	✓	40	0.14	0.6	–	–	–
	T8430	0.8	■	195	0.20	0.8	■	105	0.18	0.8	■	160	0.20	0.8	–	–	–	✓	40	0.14	0.6	–	–	–
	T9310	0.8	■	295	0.20	0.8	–	–	–	–	■	280	0.20	0.8	–	–	–	–	–	–	–	–	–	–
	T9315	0.8	■	270	0.20	0.8	–	–	–	–	■	255	0.20	0.8	–	–	–	–	–	–	–	–	–	–
	T9325	0.8	■	240	0.20	0.8	■	140	0.18	0.8	■	225	0.20	0.8	–	–	–	✓	50	0.16	0.6	–	–	–
DNMG 150404E-FM	T7325	0.4	✓	150	0.20	1.7	■	115	0.18	1.7	–	–	–	–	–	–	–	✓	45	0.20	1.4	–	–	–
	T8330	0.4	■	135	0.20	1.7	■	80	0.18	1.7	■	125	0.20	1.7	–	–	–	✓	30	0.14	1.4	–	–	–
	T8430	0.4	■	150	0.20	1.7	■	80	0.18	1.7	■	125	0.20	1.7	–	–	–	✓	30	0.14	1.4	–	–	–
	T9315	0.4	■	210	0.20	1.7	–	–	–	–	■	195	0.20	1.7	–	–	–	–	–	–	–	–	–	–
	T9325	0.4	■	190	0.20	1.7	■	110	0.18	1.7	■	180	0.20	1.7	–	–	–	✓	40	0.20	1.4	–	–	–
DNMG 150408E-FM	T7325	0.8	✓	180	0.20	1.7	■	140	0.18	1.7	–	–	–	–	–	–	–	✓	55	0.16	1.4	–	–	–
	T8330	0.8	■	160	0.20	1.7	■	95	0.18	1.7	■	150	0.20	1.7	–	–	–	✓	40	0.16	1.4	–	–	–
	T8430	0.8	■	185	0.20	1.7	■	100	0.18	1.7	■	150	0.20	1.7	–	–	–	✓	40	0.16	1.4	–	–	–
	T9315	0.8	■	250	0.20	1.7	–	–	–	–	■	235	0.20	1.7	–	–	–	–	–	–	–	–	–	–
	T9325	0.8	■	225	0.20	1.7	■	135	0.18	1.7	■	210	0.20	1.7	–	–	–	✓	50	0.16	1.4	–	–	–
DNMG 150604E-FM	T7325	0.4	✓	150	0.20	1.7	■	115	0.18	1.7	–	–	–	–	–	–	–	✓	45	0.20	1.4	–	–	–
	T7335	0.4	✓	150	0.20	1.7	■	115	0.18	1.7	–	–	–	–	–	–	–	✓	45	0.20	1.4	–	–	–
	T8315	0.4	✓	140	0.20	1.7	■	80	0.18	1.7	■	130	0.20	1.7	–	–	–	✓	35	0.14	1.4	–	–	–
	T8330	0.4	■	135	0.20	1.7	■	80	0.18	1.7	■	125	0.20	1.7	–	–	–	✓	30	0.14	1.4	–	–	–
	T8430	0.4	■	150	0.20	1.7	■	80	0.18	1.7	■	125	0.20	1.7	–	–	–	✓	30	0.14	1.4	–	–	–
	T9310	0.4	■	230	0.20	1.7	–	–	–	–	■	215	0.20	1.7	–	–	–	–	–	–	–	–	–	–
	T9315	0.4	■	210	0.20	1.7	–	–	–	–	■	195	0.20	1.7	–	–	–	–	–	–	–	–	–	–
	T9325	0.4	■	190	0.20	1.7	■	110	0.18	1.7	■	180	0.20	1.7	–	–	–	✓	40	0.20	1.4	–	–	–
	TT310	0.4	■	210	0.20	1.7	■	125	0.18	1.7	–	–	–	–	–	–	–	–	–	–	–	–	–	–
DNMG 150608E-FM	T7325	0.8	✓	180	0.20	1.7	■	140	0.18	1.7	–	–	–	–	–	–	–	✓	55	0.16	1.4	–	–	–
	T7335	0.8	✓	175	0.20	1.7	■	135	0.18	1.7	–	–	–	–	–	–	–	✓	55	0.16	1.4	–	–	–
	T8315	0.8	✓	170	0.20	1.7	■	100	0.18	1.7	■	160	0.20	1.7	–	–	–	✓	40	0.16	1.4	–	–	–
	T8330	0.8	■	160	0.20	1.7	■	95	0.18	1.7	■	150	0.20	1.7	–	–	–	✓	40	0.16	1.4	–	–	–
	T8430	0.8	■	185	0.20	1.7	■	100	0.18	1.7	■	150	0.20	1.7	–	–	–	✓	40	0.16	1.4	–	–	–
	T9310	0.8	■	275	0.20	1.7	–	–	–	–	■	260	0.20	1.7	–	–	–	–	–	–	–	–	–	–
	T9315	0.8	■	250	0.20	1.7	–	–	–	–	■	235	0.20	1.7	–	–	–	–	–	–	–	–	–	–
	T9325	0.8	■	225	0.20	1.7	■	135	0.18	1.7	■	210	0.20	1.7	–	–	–	✓	50	0.16	1.4	–	–	–
	TT310	0.8	■	250	0.20	1.7	■	150	0.18	1.7	–	–	–	–	–	–	–	–	–	–	–	–	–	–
DNMG 150612E-FM	T7325	1.2	✓	180	0.25	1.7	■	140	0.23	1.7	–	–	–	–	–	–	–	✓	55	0.18	1.4	–	–	–
	T8430	1.2	■	175	0.25	1.7	■	95	0.23	1.7	■	140	0.25	1.7	–	–	–	✓	35	0.18	1.4	–	–	–
	T9310	1.2	■	260	0.25	1.7	–	–	–	–	■	245	0.25	1.7	–	–	–	–	–	–	–	–	–	–
	T9315	1.2	■	240	0.25	1.7	–	–	–	–	■	225	0.25	1.7	–	–	–	–	–	–	–	–	–	–
	T9325	1.2	■	215	0.25	1.7	■	125	0.23	1.7	■	200	0.25	1.7	–	–	–	✓	45	0.18	1.4	–	–	–



Suitability and starting values for cutting speed (vc), feed (f) and depth of cut (ap). Refer to our Machining Calculator app for further calculations.

Product	RE (mm)	P			M			K			N			S			H		
		vc [m/min]	f [mm/rev]	ap [mm]	vc [m/min]	f [mm/rev]	ap [mm]	vc [m/min]	f [mm/rev]	ap [mm]	vc [m/min]	f [mm/rev]	ap [mm]	vc [m/min]	f [mm/rev]	ap [mm]	vc [m/min]	f [mm/rev]	ap [mm]

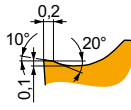

FM geometry with positive design for finish to semi-rough machining, and continuous to slightly interrupted cuts.

DNMG 150616E-FM	T9315	1.6	235	0.30	1.7	—	—	—	220	0.30	1.7	—	—	—	—	—	—	—	—
	T9325	1.6	210	0.30	1.7	125	0.27	1.7	195	0.30	1.7	—	—	—	45	0.21	1.4	—	—

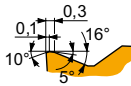

M geometry for finish to semi-rough machining, and continuous to interrupted cuts.

DNMG 110404E-M	T5315	0.4	210	0.20	1.2	—	—	—	195	0.20	1.2	—	—	—	—	—	—	40	0.15	1.0
	T9315	0.4	195	0.20	1.2	—	—	—	185	0.20	1.2	—	—	—	—	—	—	35	0.15	1.0
	T9325	0.4	175	0.20	1.2	—	—	—	165	0.20	1.2	—	—	—	—	—	—	—	—	—
	T9335	0.4	150	0.20	1.2	—	—	—	—	—	—	—	—	—	—	—	—	—	—	—
DNMG 110408E-M	T5315	0.8	215	0.30	1.2	—	—	—	200	0.30	1.2	—	—	—	—	—	—	40	0.15	1.0
	T9315	0.8	200	0.30	1.2	—	—	—	190	0.30	1.2	—	—	—	—	—	—	40	0.15	1.0
	T9325	0.8	175	0.30	1.2	—	—	—	165	0.30	1.2	—	—	—	—	—	—	—	—	—
	T9335	0.8	155	0.30	1.2	—	—	—	—	—	—	—	—	—	—	—	—	—	—	—
DNMG 110412E-M	T9315	1.2	185	0.40	1.2	—	—	—	175	0.40	1.2	—	—	—	—	—	—	35	0.15	1.0
	T9325	1.2	165	0.40	1.2	—	—	—	155	0.40	1.2	—	—	—	—	—	—	—	—	—
	T9335	1.2	140	0.40	1.2	—	—	—	—	—	—	—	—	—	—	—	—	—	—	—
DNMG 150404E-M	T5315	0.4	200	0.20	1.9	—	—	—	190	0.20	1.9	—	—	—	—	—	—	40	0.15	1.0
	T9315	0.4	190	0.20	1.9	—	—	—	180	0.20	1.9	—	—	—	—	—	—	35	0.15	1.0
	T9325	0.4	170	0.20	1.9	—	—	—	160	0.20	1.9	—	—	—	—	—	—	—	—	—
	T9335	0.4	145	0.20	1.9	—	—	—	—	—	—	—	—	—	—	—	—	—	—	—
DNMG 150408E-M	T5315	0.8	205	0.30	1.9	—	—	—	190	0.30	1.9	—	—	—	—	—	—	40	0.15	1.0
	T9315	0.8	190	0.30	1.9	—	—	—	180	0.30	1.9	—	—	—	—	—	—	35	0.15	1.0
	T9325	0.8	170	0.30	1.9	—	—	—	160	0.30	1.9	—	—	—	—	—	—	—	—	—
	T9335	0.8	145	0.30	1.9	—	—	—	—	—	—	—	—	—	—	—	—	—	—	—
DNMG 150412E-M	T5315	1.2	200	0.40	1.9	—	—	—	190	0.40	1.9	—	—	—	—	—	—	40	0.15	1.0
	T9315	1.2	175	0.40	1.9	—	—	—	165	0.40	1.9	—	—	—	—	—	—	35	0.15	1.0
	T9325	1.2	160	0.40	1.9	—	—	—	150	0.40	1.9	—	—	—	—	—	—	—	—	—
DNMG 150604E-M	T5315	0.4	200	0.20	1.9	—	—	—	190	0.20	1.9	—	—	—	—	—	—	40	0.15	1.0
	T9315	0.4	190	0.20	1.9	—	—	—	180	0.20	1.9	—	—	—	—	—	—	35	0.15	1.0
	T9325	0.4	170	0.20	1.9	—	—	—	160	0.20	1.9	—	—	—	—	—	—	—	—	—
	T9335	0.4	145	0.20	1.9	—	—	—	—	—	—	—	—	—	—	—	—	—	—	—
DNMG 150608E-M	T5315	0.8	205	0.30	1.9	—	—	—	190	0.30	1.9	—	—	—	—	—	—	40	0.15	1.0
	T9310	0.8	205	0.30	1.9	—	—	—	190	0.30	1.9	—	—	—	—	—	—	40	0.15	1.0
	T9315	0.8	190	0.30	1.9	—	—	—	180	0.30	1.9	—	—	—	—	—	—	35	0.15	1.0
	T9325	0.8	170	0.30	1.9	—	—	—	160	0.30	1.9	—	—	—	—	—	—	—	—	—
	T9335	0.8	145	0.30	1.9	—	—	—	—	—	—	—	—	—	—	—	—	—	—	—
DNMG 150612E-M	T5315	1.2	200	0.40	1.9	—	—	—	190	0.40	1.9	—	—	—	—	—	—	40	0.15	1.0
	T9310	1.2	190	0.40	1.9	—	—	—	180	0.40	1.9	—	—	—	—	—	—	35	0.15	1.0
	T9315	1.2	175	0.40	1.9	—	—	—	165	0.40	1.9	—	—	—	—	—	—	35	0.15	1.0
	T9325	1.2	160	0.40	1.9	—	—	—	150	0.40	1.9	—	—	—	—	—	—	—	—	—
	T9335	1.2	140	0.40	1.9	—	—	—	—	—	—	—	—	—	—	—	—	—	—	—

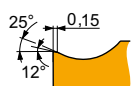

NF geometry with highly positive design for fine-finish to medium machining, and continuous cuts.

DNMG 110404E-NF	T6310	0.4	155	0.15	0.8	110	0.14	0.8	125	0.15	0.8	465	0.18	0.8	45	0.12	0.6	—	—	—
	T7325	0.4	170	0.18	0.8	130	0.16	0.8	—	—	—	—	—	—	55	0.16	0.6	—	—	—
	T7335	0.4	165	0.18	0.8	125	0.16	0.8	—	—	—	—	—	—	50	0.16	0.6	—	—	—
	T8330	0.4	160	0.15	0.8	95	0.14	0.8	150	0.15	0.8	480	0.18	0.8	40	0.12	0.6	—	—	—
	T8430	0.4	190	0.15	0.8	105	0.14	0.8	155	0.15	0.8	525	0.18	0.8	40	0.12	0.6	—	—	—
	T9315	0.4	255	0.15	0.8	—	—	—	240	0.15	0.8	—	—	—	—	—	—	—	—	—
	T9325	0.4	210	0.18	0.8	125	0.16	0.8	195	0.18	0.8	—	—	—	45	0.16	0.6	—	—	—
	T9335	0.4	140	0.15	0.8	—	—	—	—	—	—	—	—	—	—	—	—	—	—	—



Suitability and starting values for cutting speed (vc), feed (f) and depth of cut (ap). Refer to our Machining Calculator app for further calculations.

Product	RE [mm]	P			M			K			N			S			H		
		vc	f	ap	vc	f	ap	vc	f	ap	vc	f	ap	vc	f	ap	vc	f	ap
		[m/min]	[mm/rev]	[mm]	[m/min]	[mm/rev]	[mm]	[m/min]	[mm/rev]	[mm]	[m/min]	[mm/rev]	[mm]	[m/min]	[mm/rev]	[mm]	[m/min]	[mm/rev]	[mm]

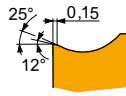

NF geometry with highly positive design for fine-finish to medium machining, and continuous cuts.

DNMG 110408E-NF	T6310	0.8	■	175	0.17	1.0	■	125	0.15	1.0	▲	140	0.17	1.0	■	525	0.20	1.0	▲	50	0.14	0.8	-	-	-	
	T7325	0.8	▲	200	0.18	1.0	■	155	0.16	1.0	-	-	-	-	-	-	-	-	■	65	0.16	0.8	-	-	-	
	T7335	0.8	▲	195	0.18	1.0	■	150	0.16	1.0	-	-	-	-	-	-	-	-	■	60	0.16	0.8	-	-	-	
	T8330	0.8	■	175	0.17	1.0	■	105	0.15	1.0	▲	165	0.17	1.0	■	525	0.20	1.0	▲	40	0.14	0.8	-	-	-	
	T8430	0.8	■	205	0.17	1.0	■	110	0.15	1.0	▲	170	0.17	1.0	■	570	0.20	1.0	▲	45	0.14	0.8	-	-	-	
	T9315	0.8	■	280	0.17	1.0	■	-	-	-	▲	265	0.17	1.0	-	-	-	-	-	-	-	-	-	-	-	
	T9325	0.8	■	250	0.18	1.0	■	150	0.16	1.0	▲	235	0.18	1.0	-	-	-	-	-	■	55	0.16	0.8	-	-	-
	DNMG 150404E-NF	T6310	0.4	■	140	0.17	1.7	■	100	0.15	1.7	▲	110	0.17	1.7	■	420	0.20	1.7	▲	40	0.15	1.4	-	-	-
		T7325	0.4	▲	160	0.18	1.7	■	120	0.16	1.7	-	-	-	-	-	-	-	-	■	50	0.16	1.4	-	-	-
T7335		0.4	▲	155	0.18	1.7	■	120	0.16	1.7	-	-	-	-	-	-	-	-	■	50	0.16	1.4	-	-	-	
T8330		0.4	■	140	0.17	1.7	■	80	0.15	1.7	▲	130	0.17	1.7	■	420	0.20	1.7	▲	35	0.15	1.4	-	-	-	
T8430		0.4	■	165	0.17	1.7	■	90	0.15	1.7	▲	135	0.17	1.7	■	450	0.20	1.7	▲	35	0.15	1.4	-	-	-	
T9315		0.4	■	235	0.15	1.7	■	-	-	-	▲	220	0.15	1.7	-	-	-	-	-	-	-	-	-	-	-	
T9325		0.4	■	200	0.18	1.7	■	120	0.16	1.7	▲	190	0.18	1.7	-	-	-	-	-	■	45	0.16	1.4	-	-	-
DNMG 150408E-NF		T6310	0.8	■	165	0.18	1.7	■	115	0.16	1.7	▲	130	0.18	1.7	■	495	0.22	1.7	▲	45	0.16	1.4	-	-	-
		T7325	0.8	▲	190	0.18	1.7	■	145	0.16	1.7	-	-	-	-	-	-	-	-	■	60	0.16	1.4	-	-	-
	T7335	0.8	▲	185	0.18	1.7	■	140	0.16	1.7	-	-	-	-	-	-	-	-	■	60	0.16	1.4	-	-	-	
	T8330	0.8	■	165	0.18	1.7	■	95	0.16	1.7	▲	155	0.18	1.7	■	495	0.22	1.7	▲	40	0.16	1.4	-	-	-	
	T8430	0.8	■	190	0.18	1.7	■	105	0.16	1.7	▲	155	0.18	1.7	■	525	0.22	1.7	▲	40	0.16	1.4	-	-	-	
	T9315	0.8	■	270	0.17	1.7	■	-	-	-	▲	255	0.17	1.7	-	-	-	-	-	-	-	-	-	-	-	
	T9325	0.8	■	235	0.18	1.7	■	140	0.16	1.7	▲	220	0.18	1.7	-	-	-	-	-	■	50	0.16	1.4	-	-	-
	DNMG 150604E-NF	HF7	0.4	-	-	-	-	▲	80	0.14	1.9	▲	130	0.15	1.9	■	420	0.18	1.9	-	-	-	-	-	-	-
		T6310	0.4	■	140	0.17	1.9	■	100	0.15	1.9	▲	110	0.17	1.9	■	420	0.20	1.9	▲	40	0.15	1.5	-	-	-
T7325		0.4	▲	155	0.18	1.9	■	120	0.16	1.9	-	-	-	-	-	-	-	-	■	50	0.16	1.5	-	-	-	
T7335		0.4	▲	150	0.18	1.9	■	115	0.16	1.9	-	-	-	-	-	-	-	-	■	45	0.16	1.5	-	-	-	
T8315		0.4	▲	145	0.17	1.9	■	85	0.15	1.9	▲	135	0.17	1.9	■	435	0.20	1.9	▲	35	0.15	1.5	-	-	-	
T8330		0.4	■	140	0.17	1.9	■	80	0.15	1.9	▲	130	0.17	1.9	■	420	0.20	1.9	▲	35	0.15	1.5	-	-	-	
T8430		0.4	■	165	0.17	1.9	■	90	0.15	1.9	▲	135	0.17	1.9	■	450	0.20	1.9	▲	35	0.15	1.5	-	-	-	
T9315		0.4	■	235	0.15	1.9	■	-	-	-	▲	220	0.15	1.9	-	-	-	-	-	-	-	-	-	-	-	
T9325		0.4	■	195	0.18	1.9	■	115	0.16	1.9	▲	185	0.18	1.9	-	-	-	-	-	■	40	0.16	1.5	-	-	-
DNMG 150608E-NF	HF7	0.8	-	-	-	-	▲	90	0.15	1.9	▲	145	0.17	1.9	■	465	0.20	1.9	-	-	-	-	-	-	-	
	T6310	0.8	■	165	0.18	1.9	■	115	0.16	1.9	▲	130	0.18	1.9	■	495	0.22	1.9	▲	45	0.16	1.5	-	-	-	
	T7325	0.8	▲	185	0.18	1.9	■	140	0.16	1.9	-	-	-	-	-	-	-	-	■	60	0.16	1.5	-	-	-	
	T7335	0.8	▲	180	0.18	1.9	■	140	0.16	1.9	-	-	-	-	-	-	-	-	■	55	0.16	1.5	-	-	-	
	T8315	0.8	▲	175	0.18	1.9	■	105	0.16	1.9	▲	165	0.18	1.9	■	525	0.22	1.9	▲	40	0.16	1.5	-	-	-	
	T8330	0.8	■	165	0.18	1.9	■	95	0.16	1.9	▲	155	0.18	1.9	■	495	0.22	1.9	▲	40	0.16	1.5	-	-	-	
	T8430	0.8	■	190	0.18	1.9	■	105	0.16	1.9	▲	155	0.18	1.9	■	525	0.22	1.9	▲	40	0.16	1.5	-	-	-	
	T9315	0.8	■	265	0.17	1.9	■	-	-	-	▲	250	0.17	1.9	-	-	-	-	-	-	-	-	-	-	-	
	T9325	0.8	■	230	0.18	1.9	■	135	0.16	1.9	▲	215	0.18	1.9	-	-	-	-	-	■	50	0.16	1.5	-	-	-
DNMG 150612E-NF	T6310	1.2	■	150	0.30	1.5	■	105	0.27	1.5	▲	120	0.30	1.5	■	450	0.36	1.5	▲	45	0.21	1.2	-	-	-	
	T8430	1.2	■	165	0.30	1.5	■	90	0.27	1.5	▲	135	0.30	1.5	■	450	0.36	1.5	▲	35	0.21	1.2	-	-	-	
	T9325	1.2	■	200	0.30	1.5	■	120	0.27	1.5	▲	190	0.30	1.5	-	-	-	-	■	45	0.21	1.2	-	-	-	

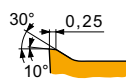

NM geometry with highly positive design for fine-finish, medium to rough machining, and continuous cuts.

DNMG 110404E-NM	T7325	0.4	▲	175	0.20	0.8	■	135	0.18	0.8	-	-	-	-	-	-	-	-	■	55	0.20	0.6	-	-	-
	T7335	0.4	▲	165	0.20	0.8	■	125	0.18	0.8	-	-	-	-	-	-	-	-	■	50	0.20	0.6	-	-	-
	T8315	0.4	▲	160	0.20	0.8	■	95	0.18	0.8	-	-	-	▲	480	0.24	0.8	▲	40	0.20	0.6	-	-	-	
	T8330	0.4	■	150	0.20	0.8	■	90	0.18	0.8	-	-	-	▲	450	0.24	0.8	▲	35	0.20	0.6	-	-	-	
	T8430	0.4	■	175	0.20	0.8	■	95	0.18	0.8	-	-	-	▲	480	0.24	0.8	▲	35	0.20	0.6	-	-	-	
	T9325	0.4	■	210	0.20	0.8	■	125	0.18	0.8	-	-	-	-	-	-	-	-	■	45	0.20	0.6	-	-	-



Suitability and starting values for cutting speed (vc), feed (f) and depth of cut (ap). Refer to our Machining Calculator app for further calculations.

Product	RE [mm]	P			M			K			N			S			H		
		vc [m/min]	f [mm/rev]	ap [mm]	vc [m/min]	f [mm/rev]	ap [mm]	vc [m/min]	f [mm/rev]	ap [mm]	vc [m/min]	f [mm/rev]	ap [mm]	vc [m/min]	f [mm/rev]	ap [mm]	vc [m/min]	f [mm/rev]	ap [mm]

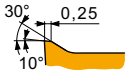

NM geometry with highly positive design for fine-finish, medium to rough machining, and continuous cuts.

DNMG 110408E-NM	T7325	0.8	✓	190	0.25	0.8	■	145	0.23	0.8	—	—	—	■	60	0.20	0.6	—	—	—	
	T7335	0.8	✓	185	0.25	0.8	■	140	0.23	0.8	—	—	—	■	60	0.20	0.6	—	—	—	
	T8315	0.8	✓	180	0.25	0.8	■	105	0.23	0.8	—	—	—	✓	540	0.30	0.8	✓	45	0.20	0.6
	T8330	0.8	■	170	0.25	0.8	■	100	0.23	0.8	—	—	—	✓	510	0.30	0.8	✓	40	0.20	0.6
	T8430	0.8	■	190	0.25	0.8	■	105	0.23	0.8	—	—	—	✓	525	0.30	0.8	✓	40	0.20	0.6
DNMG 150408E-NM	T9325	0.8	■	230	0.25	0.8	■	135	0.23	0.8	—	—	—	—	—	—	—	✓	50	0.20	0.6
	T7335	0.8	✓	170	0.25	1.9	■	130	0.23	1.9	—	—	—	■	55	0.20	1.5	—	—	—	
	T8330	0.8	■	155	0.25	1.9	■	90	0.23	1.9	—	—	—	✓	465	0.30	1.9	✓	35	0.20	1.5
	T8430	0.8	■	175	0.25	1.9	■	95	0.23	1.9	—	—	—	✓	480	0.30	1.9	✓	35	0.20	1.5
DNMG 150604E-NM	T9325	0.8	■	210	0.25	1.9	■	125	0.23	1.9	—	—	—	—	—	—	—	✓	45	0.20	1.5
	T7325	0.4	✓	160	0.20	1.9	■	120	0.18	1.9	—	—	—	■	50	0.20	1.5	—	—	—	
	T7335	0.4	✓	150	0.20	1.9	■	115	0.18	1.9	—	—	—	■	45	0.20	1.5	—	—	—	
	T8315	0.4	✓	150	0.20	1.9	■	90	0.18	1.9	—	—	—	✓	450	0.24	1.9	✓	35	0.20	1.5
	T8330	0.4	■	135	0.20	1.9	■	80	0.18	1.9	—	—	—	✓	405	0.24	1.9	✓	30	0.20	1.5
	T8430	0.4	■	155	0.20	1.9	■	85	0.18	1.9	—	—	—	✓	435	0.24	1.9	✓	30	0.20	1.5
DNMG 150608E-NM	T9315	0.4	■	220	0.20	1.9	■	—	—	—	—	—	—	—	—	—	—	—	—	—	
	T9325	0.4	■	195	0.20	1.9	■	115	0.18	1.9	—	—	—	—	—	—	—	✓	40	0.20	1.5
	T7325	0.8	✓	175	0.25	1.9	■	135	0.23	1.9	—	—	—	■	55	0.20	1.5	—	—	—	
	T7335	0.8	✓	170	0.25	1.9	■	130	0.23	1.9	—	—	—	■	55	0.20	1.5	—	—	—	
	T8315	0.8	✓	165	0.25	1.9	■	95	0.23	1.9	—	—	—	✓	495	0.30	1.9	✓	40	0.20	1.5
	T8330	0.8	■	155	0.25	1.9	■	90	0.23	1.9	—	—	—	✓	465	0.30	1.9	✓	35	0.20	1.5
DNMG 150612E-NM	T8430	0.8	■	175	0.25	1.9	■	95	0.23	1.9	—	—	—	✓	480	0.30	1.9	✓	35	0.20	1.5
	T9315	0.8	■	235	0.25	1.9	■	—	—	—	—	—	—	—	—	—	—	—	—	—	
	T9325	0.8	■	210	0.25	1.9	■	125	0.23	1.9	—	—	—	—	—	—	—	✓	45	0.20	1.5
	T7325	1.2	✓	175	0.30	1.9	■	135	0.27	1.9	—	—	—	■	55	0.24	1.5	—	—	—	
DNMG 150612E-NM	T7335	1.2	✓	170	0.30	1.9	■	130	0.27	1.9	—	—	—	■	55	0.24	1.5	—	—	—	
	T8315	1.2	✓	165	0.30	1.9	■	95	0.27	1.9	—	—	—	✓	495	0.36	1.9	✓	40	0.24	1.5
	T9325	1.2	■	205	0.30	1.9	■	120	0.27	1.9	—	—	—	✓	45	0.24	1.5	—	—	—	

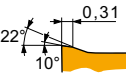

NMR geometry with positive design for medium to rough machining, and continuous cuts.

DNMG 110404E-NMR	T7325	0.4	✓	150	0.20	0.8	■	115	0.18	0.8	—	—	—	■	45	0.18	0.6	—	—	—
	T9315	0.4	■	205	0.20	0.8	■	—	—	—	—	—	—	—	—	—	—	—	—	—
	T9325	0.4	■	185	0.20	0.8	■	110	0.18	0.8	—	—	—	✓	40	0.18	0.6	—	—	—
DNMG 110408E-NMR	T7325	0.8	✓	155	0.30	0.8	■	120	0.27	0.8	—	—	—	■	50	0.24	0.6	—	—	—
	T9315	0.8	■	205	0.30	0.8	■	—	—	—	—	—	—	—	—	—	—	—	—	—
	T9325	0.8	■	185	0.30	0.8	■	110	0.27	0.8	—	—	—	✓	40	0.24	0.6	—	—	—
DNMG 110412E-NMR	T7325	1.2	✓	155	0.30	1.6	■	120	0.27	1.6	—	—	—	■	50	0.24	1.3	—	—	—
	T9315	1.2	■	200	0.30	1.6	■	—	—	—	—	—	—	—	—	—	—	—	—	—
	T9325	1.2	■	180	0.30	1.6	■	105	0.27	1.6	—	—	—	✓	40	0.24	1.3	—	—	—
DNMG 150404E-NMR	T7325	0.4	✓	140	0.20	1.9	■	105	0.18	1.9	—	—	—	■	45	0.18	1.5	—	—	—
	T7335	0.4	✓	130	0.20	1.9	■	100	0.18	1.9	—	—	—	■	40	0.18	1.5	—	—	—
	T9325	0.4	■	170	0.20	1.9	■	100	0.18	1.9	—	—	—	✓	35	0.18	1.5	—	—	—
DNMG 150408E-NMR	T7325	0.8	✓	145	0.30	1.9	■	110	0.27	1.9	—	—	—	■	45	0.24	1.5	—	—	—
	T7335	0.8	✓	140	0.30	1.9	■	105	0.27	1.9	—	—	—	■	45	0.24	1.5	—	—	—
	T8330	0.8	■	125	0.30	1.9	■	75	0.27	1.9	—	—	—	✓	30	0.24	1.5	—	—	—
	T8430	0.8	■	135	0.30	1.9	■	75	0.27	1.9	—	—	—	✓	25	0.24	1.5	—	—	—
	T9315	0.8	■	190	0.30	1.9	■	—	—	—	—	—	—	—	—	—	—	—	—	—
	T9325	0.8	■	170	0.30	1.9	■	100	0.27	1.9	—	—	—	✓	35	0.24	1.5	—	—	—
DNMG 150604E-NMR	T7325	0.4	✓	140	0.20	1.9	■	105	0.18	1.9	—	—	—	■	45	0.18	1.5	—	—	—
	T7335	0.4	✓	130	0.20	1.9	■	100	0.18	1.9	—	—	—	■	40	0.18	1.5	—	—	—
	T8330	0.4	■	120	0.20	1.9	■	70	0.18	1.9	—	—	—	✓	30	0.18	1.5	—	—	—
	T8430	0.4	■	135	0.20	1.9	■	75	0.18	1.9	—	—	—	✓	25	0.18	1.5	—	—	—
	T9315	0.4	■	190	0.20	1.9	■	—	—	—	—	—	—	—	—	—	—	—	—	—
	T9325	0.4	■	170	0.20	1.9	■	100	0.18	1.9	—	—	—	✓	35	0.18	1.5	—	—	—



Suitability and starting values for cutting speed (vc), feed (f) and depth of cut (ap). Refer to our Machining Calculator app for further calculations.

Product	RE [mm]	P			M			K			N			S			H		
		vc [m/min]	f [mm/rev]	ap [mm]	vc [m/min]	f [mm/rev]	ap [mm]	vc [m/min]	f [mm/rev]	ap [mm]	vc [m/min]	f [mm/rev]	ap [mm]	vc [m/min]	f [mm/rev]	ap [mm]	vc [m/min]	f [mm/rev]	ap [mm]

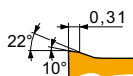

NMR geometry with positive design for medium to rough machining, and continuous cuts.

DNMG 150608E-NMR	T6310	0.8	█	125	0.30	1.9	█	90	0.27	1.9	█	-	-	-	█	35	0.24	1.5	-	-	-
	T7325	0.8	█	145	0.30	1.9	█	110	0.27	1.9	█	-	-	-	█	45	0.24	1.5	-	-	-
	T7335	0.8	█	140	0.30	1.9	█	105	0.27	1.9	█	-	-	-	█	45	0.24	1.5	-	-	-
	T8330	0.8	█	125	0.30	1.9	█	75	0.27	1.9	█	-	-	-	█	30	0.24	1.5	-	-	-
	T8430	0.8	█	135	0.30	1.9	█	75	0.27	1.9	█	-	-	-	█	25	0.24	1.5	-	-	-
	T9315	0.8	█	190	0.30	1.9	█	-	-	-	█	-	-	-	-	-	-	-	-	-	-
DNMG 150612E-NMR	T9325	0.8	█	170	0.30	1.9	█	100	0.27	1.9	█	-	-	-	█	35	0.24	1.5	-	-	-
	T7325	1.2	█	155	0.30	1.9	█	120	0.27	1.9	█	-	-	-	█	50	0.24	1.5	-	-	-
	T7335	1.2	█	145	0.30	1.9	█	110	0.27	1.9	█	-	-	-	█	45	0.24	1.5	-	-	-
	T8330	1.2	█	135	0.30	1.9	█	80	0.27	1.9	█	-	-	-	█	30	0.24	1.5	-	-	-
	T8430	1.2	█	145	0.30	1.9	█	80	0.27	1.9	█	-	-	-	█	30	0.24	1.5	-	-	-
	T9315	1.2	█	200	0.30	1.9	█	-	-	-	█	-	-	-	-	-	-	-	-	-	-
T9325	1.2	█	180	0.30	1.9	█	105	0.27	1.9	█	-	-	-	█	40	0.24	1.5	-	-	-	

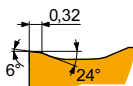

NRM geometry with positive design for semi-rough to rough machining, and continuous to moderate interrupted cuts.

DNMG 150408-NRM	T7325	0.8	█	140	0.30	3.0	█	105	0.27	3.0	█	-	-	-	█	45	0.24	2.4	-	-	-
	T7335	0.8	█	130	0.30	3.0	█	100	0.27	3.0	█	-	-	-	█	40	0.24	2.4	-	-	-
	T9315	0.8	█	180	0.30	3.0	█	-	-	-	█	-	-	-	-	-	-	-	-	-	-
DNMG 150604-NRM	T7325	0.4	█	130	0.20	3.0	█	100	0.18	3.0	█	-	-	-	█	40	0.20	2.4	-	-	-
	T7335	0.4	█	130	0.20	3.0	█	100	0.18	3.0	█	-	-	-	█	40	0.20	2.4	-	-	-
	T9315	0.4	█	180	0.20	3.0	█	-	-	-	█	-	-	-	-	-	-	-	-	-	-
DNMG 150608-NRM	T7325	0.8	█	140	0.30	3.0	█	105	0.27	3.0	█	-	-	-	█	45	0.24	2.4	-	-	-
	T7335	0.8	█	130	0.30	3.0	█	100	0.27	3.0	█	-	-	-	█	40	0.24	2.4	-	-	-
	T9315	0.8	█	180	0.30	3.0	█	-	-	-	█	-	-	-	-	-	-	-	-	-	-
DNMG 150612-NRM	T7325	1.2	█	145	0.30	3.0	█	110	0.27	3.0	█	-	-	-	█	45	0.27	2.4	-	-	-
	T7335	1.2	█	140	0.30	3.0	█	105	0.27	3.0	█	-	-	-	█	45	0.27	2.4	-	-	-
	T9315	1.2	█	190	0.30	3.0	█	-	-	-	█	-	-	-	-	-	-	-	-	-	-

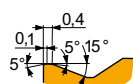

R geometry for semi-rough to rough machining, and continuous to interrupted cuts.

DNMG 150408E-R	T5315	0.8	█	175	0.40	3.0	█	-	-	-	█	165	0.40	3.0	█	-	-	-	█	35	0.15	1.0
DNMG 150608E-R	T5305	0.8	█	200	0.40	3.0	█	-	-	-	█	190	0.40	3.0	█	-	-	-	█	40	0.15	1.0
	T5315	0.8	█	175	0.40	3.0	█	-	-	-	█	165	0.40	3.0	█	-	-	-	█	35	0.15	1.0
	T9310	0.8	█	170	0.40	3.0	█	-	-	-	█	160	0.40	3.0	█	-	-	-	█	30	0.15	1.0
	T9315	0.8	█	155	0.40	3.0	█	-	-	-	█	145	0.40	3.0	█	-	-	-	█	30	0.15	1.0
	T9325	0.8	█	140	0.40	3.0	█	-	-	-	█	130	0.40	3.0	█	-	-	-	█	-	-	-
DNMG 150612E-R	T5305	1.2	█	210	0.40	3.0	█	-	-	-	█	195	0.40	3.0	█	-	-	-	█	40	0.15	1.0
	T5315	1.2	█	185	0.40	3.0	█	-	-	-	█	175	0.40	3.0	█	-	-	-	█	35	0.15	1.0
	T9310	1.2	█	180	0.40	3.0	█	-	-	-	█	170	0.40	3.0	█	-	-	-	█	35	0.15	1.0
	T9315	1.2	█	165	0.40	3.0	█	-	-	-	█	155	0.40	3.0	█	-	-	-	█	30	0.15	1.0
	T9325	1.2	█	150	0.40	3.0	█	-	-	-	█	140	0.40	3.0	█	-	-	-	█	-	-	-
DNMG 150616E-R	T9325	1.6	█	155	0.40	3.0	█	-	-	-	█	145	0.40	3.0	█	-	-	-	█	-	-	-

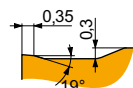

RM geometry for semi-rough to rough machining, and continuous to interrupted cuts.

DNMG 110408E-RM	T9315	0.8	█	190	0.40	2.0	█	-	-	-	█	180	0.40	2.0	█	-	-	-	█	-	-	-
	T9325	0.8	█	170	0.40	2.0	█	100	0.36	2.0	█	160	0.40	2.0	█	-	-	-	█	-	-	-
	T9335	0.8	█	145	0.40	2.0	█	85	0.36	2.0	█	-	-	-	█	-	-	-	█	-	-	-
DNMG 110412E-RM	T9315	1.2	█	230	0.30	2.0	█	-	-	-	█	215	0.30	2.0	█	-	-	-	█	-	-	-
	T9325	1.2	█	205	0.30	2.0	█	120	0.27	2.0	█	190	0.30	2.0	█	-	-	-	█	-	-	-



Suitability and starting values for cutting speed (vc), feed (f) and depth of cut (ap). Refer to our Machining Calculator app for further calculations.

Product	RE [mm]	P			M			K			N			S			H		
		vc [m/min]	f [mm/rev]	ap [mm]	vc [m/min]	f [mm/rev]	ap [mm]	vc [m/min]	f [mm/rev]	ap [mm]	vc [m/min]	f [mm/rev]	ap [mm]	vc [m/min]	f [mm/rev]	ap [mm]	vc [m/min]	f [mm/rev]	ap [mm]

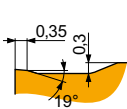

RM geometry for semi-rough to rough machining, and continuous to interrupted cuts.

DNMG 150408E-RM	T9315	0.8	180	0.40	3.0	—	—	—	170	0.40	3.0	—	—	—	—	—	—	—	
	T9325	0.8	165	0.40	3.0	95	0.36	3.0	155	0.40	3.0	—	—	—	—	—	—	—	
	T9335	0.8	140	0.40	3.0	80	0.36	3.0	—	—	—	—	—	—	—	—	—	—	
DNMG 150412E-RM	T7325	1.2	155	0.40	3.0	120	0.36	3.0	—	—	—	—	—	—	—	—	—	—	
	T9315	1.2	190	0.40	3.0	—	—	—	180	0.40	3.0	—	—	—	—	—	—	—	
	T9325	1.2	170	0.40	3.0	100	0.36	3.0	160	0.40	3.0	—	—	—	—	—	—	—	
DNMG 150608E-RM	T5305	0.8	230	0.40	3.0	—	—	—	215	0.40	3.0	—	—	—	—	—	—	—	
	T5315	0.8	205	0.40	3.0	—	—	—	190	0.40	3.0	—	—	—	—	—	—	—	
	T7325	0.8	145	0.40	3.0	110	0.36	3.0	—	—	—	—	—	—	—	—	—	—	
DNMG 150612E-RM	T7335	0.8	135	0.40	3.0	105	0.36	3.0	—	—	—	—	—	—	—	—	—	—	
	T8315	0.8	135	0.40	3.0	80	0.36	3.0	125	0.40	3.0	—	—	—	—	—	—	—	
	T8330	0.8	130	0.40	3.0	75	0.36	3.0	120	0.40	3.0	—	—	—	—	—	—	—	
	T8430	0.8	135	0.40	3.0	75	0.36	3.0	110	0.40	3.0	—	—	—	—	—	—	—	
	T9310	0.8	200	0.40	3.0	—	—	—	190	0.40	3.0	—	—	—	—	—	—	—	
	T9315	0.8	180	0.40	3.0	—	—	—	170	0.40	3.0	—	—	—	—	—	—	—	
	T9325	0.8	165	0.40	3.0	95	0.36	3.0	155	0.40	3.0	—	—	—	—	—	—	—	
	T9335	0.8	140	0.40	3.0	80	0.36	3.0	—	—	—	—	—	—	—	—	—	—	
	T5305	1.2	240	0.40	3.0	—	—	—	225	0.40	3.0	—	—	—	—	—	—	—	—
	T5315	1.2	215	0.40	3.0	—	—	—	200	0.40	3.0	—	—	—	—	—	—	—	—
	T7325	1.2	155	0.40	3.0	120	0.36	3.0	—	—	—	—	—	—	—	—	—	—	
	T7335	1.2	145	0.40	3.0	110	0.36	3.0	—	—	—	—	—	—	—	—	—	—	
	T8330	1.2	135	0.40	3.0	80	0.36	3.0	125	0.40	3.0	—	—	—	—	—	—	—	
	T8430	1.2	140	0.40	3.0	75	0.36	3.0	115	0.40	3.0	—	—	—	—	—	—	—	
	T9310	1.2	210	0.40	3.0	—	—	—	195	0.40	3.0	—	—	—	—	—	—	—	
T9315	1.2	190	0.40	3.0	—	—	—	180	0.40	3.0	—	—	—	—	—	—	—		
T9325	1.2	170	0.40	3.0	100	0.36	3.0	160	0.40	3.0	—	—	—	—	—	—	—		
T9335	1.2	150	0.40	3.0	90	0.36	3.0	—	—	—	—	—	—	—	—	—	—		
DNMG 150616E-RM	T5315	1.6	225	0.40	3.0	—	—	—	210	0.40	3.0	—	—	—	—	—	—	—	
	T9315	1.6	200	0.40	3.0	—	—	—	190	0.40	3.0	—	—	—	—	—	—	—	
	T9325	1.6	180	0.40	3.0	105	0.36	3.0	170	0.40	3.0	—	—	—	—	—	—	—	
	T9335	1.6	155	0.40	3.0	90	0.36	3.0	—	—	—	—	—	—	—	—	—	—	

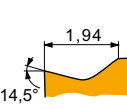

SF geometry with positive design for fine-finish machining of thin walls and continuous cuts.

DNMG 110404E-SF	T6310	0.4	150	0.15	0.8	105	0.14	0.8	120	0.15	0.8	450	0.18	0.8	45	0.12	0.6	30	0.15	1.0
	T7325	0.4	165	0.17	0.8	125	0.15	0.8	—	—	—	—	—	—	50	0.15	0.6	—	—	—
	T8315	0.4	160	0.15	0.8	95	0.14	0.8	150	0.15	0.8	480	0.18	0.8	40	0.12	0.6	30	0.15	1.0
	T8430	0.4	180	0.15	0.8	95	0.14	0.8	145	0.15	0.8	495	0.18	0.8	35	0.12	0.6	30	0.15	1.0
	T9315	0.4	245	0.15	0.8	—	—	—	230	0.15	0.8	—	—	—	—	—	—	45	0.15	1.0
DNMG 110408E-SF	T9325	0.4	210	0.17	0.8	125	0.15	0.8	195	0.17	0.8	—	—	—	45	0.15	0.6	—	—	—
	T6310	0.8	175	0.17	0.8	125	0.15	0.8	140	0.17	0.8	525	0.20	0.8	50	0.14	0.6	35	0.15	1.0
	T7325	0.8	195	0.17	0.8	150	0.15	0.8	—	—	—	—	—	—	60	0.15	0.6	—	—	—
	T7335	0.8	195	0.17	0.8	150	0.15	0.8	—	—	—	—	—	—	60	0.15	0.6	—	—	—
	T8315	0.8	180	0.17	0.8	105	0.15	0.8	170	0.17	0.8	540	0.20	0.8	45	0.14	0.6	35	0.15	1.0
	T8430	0.8	200	0.17	0.8	110	0.15	0.8	165	0.17	0.8	555	0.20	0.8	40	0.14	0.6	35	0.15	1.0
	T9325	0.8	250	0.17	0.8	150	0.15	0.8	235	0.17	0.8	—	—	—	55	0.15	0.6	—	—	—
DNMG 150404E-SF	T6310	0.4	140	0.15	1.5	100	0.14	1.5	110	0.15	1.5	420	0.18	1.5	40	0.12	1.2	25	0.15	1.0
	T8315	0.4	150	0.15	1.5	90	0.14	1.5	140	0.15	1.5	450	0.18	1.5	35	0.12	1.2	30	0.15	1.0
	T8430	0.4	165	0.15	1.5	90	0.14	1.5	135	0.15	1.5	450	0.18	1.5	35	0.12	1.2	25	0.15	1.0
	T9325	0.4	195	0.17	1.5	115	0.15	1.5	185	0.17	1.5	—	—	—	40	0.15	1.2	—	—	—



Suitability and starting values for cutting speed (vc), feed (f) and depth of cut (ap). Refer to our Machining Calculator app for further calculations.

Product	RE [mm]	P			M			K			N			S			H		
		vc [m/min]	f [mm/rev]	ap [mm]	vc [m/min]	f [mm/rev]	ap [mm]	vc [m/min]	f [mm/rev]	ap [mm]	vc [m/min]	f [mm/rev]	ap [mm]	vc [m/min]	f [mm/rev]	ap [mm]	vc [m/min]	f [mm/rev]	ap [mm]

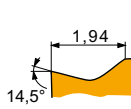

SF geometry with positive design for fine-finish machining of thin walls and continuous cuts.

DNMG 150408E-SF	T6310	0.8	█	160	0.17	1.5	█	115	0.15	1.5	█	125	0.17	1.5	█	480	0.20	1.5	█	45	0.14	1.2	█	30	0.15	1.0
	T8315	0.8	█	170	0.17	1.5	█	100	0.15	1.5	█	160	0.17	1.5	█	510	0.20	1.5	█	40	0.14	1.2	█	30	0.15	1.0
	T8330	0.8	█	160	0.17	1.5	█	95	0.15	1.5	█	150	0.17	1.5	█	480	0.20	1.5	█	40	0.14	1.2	█	30	0.15	1.0
	T8430	0.8	█	190	0.17	1.5	█	105	0.15	1.5	█	155	0.17	1.5	█	525	0.20	1.5	█	40	0.14	1.2	█	30	0.15	1.0
	T9325	0.8	█	235	0.17	1.5	█	140	0.15	1.5	█	220	0.17	1.5	█	–	–	–	█	50	0.15	1.2	█	–	–	–
DNMG 150604E-SF	H07	0.4	█	–	–	–	█	70	0.14	1.5	█	115	0.15	1.5	█	360	0.18	1.5	█	35	0.12	1.2	█	–	–	–
	T6310	0.4	█	140	0.15	1.5	█	100	0.14	1.5	█	110	0.15	1.5	█	420	0.18	1.5	█	40	0.12	1.2	█	25	0.15	1.0
	T7325	0.4	█	155	0.17	1.5	█	120	0.15	1.5	█	–	–	–	█	–	–	–	█	50	0.15	1.2	█	–	–	–
	T7335	0.4	█	150	0.17	1.5	█	115	0.15	1.5	█	–	–	–	█	–	–	–	█	45	0.15	1.2	█	–	–	–
	T8315	0.4	█	150	0.15	1.5	█	90	0.14	1.5	█	140	0.15	1.5	█	450	0.18	1.5	█	35	0.12	1.2	█	30	0.15	1.0
	T8330	0.4	█	140	0.15	1.5	█	80	0.14	1.5	█	130	0.15	1.5	█	420	0.18	1.5	█	35	0.12	1.2	█	25	0.15	1.0
	T8430	0.4	█	165	0.15	1.5	█	90	0.14	1.5	█	135	0.15	1.5	█	450	0.18	1.5	█	35	0.12	1.2	█	25	0.15	1.0
	T9315	0.4	█	230	0.15	1.5	█	–	–	–	█	215	0.15	1.5	█	–	–	–	█	–	–	–	█	45	0.15	1.0
	T9325	0.4	█	195	0.17	1.5	█	115	0.15	1.5	█	185	0.17	1.5	█	–	–	–	█	40	0.15	1.2	█	–	–	–
DNMG 150608E-SF	H07	0.8	█	–	–	–	█	80	0.15	1.5	█	130	0.17	1.5	█	415	0.20	1.5	█	40	0.14	1.2	█	–	–	–
	T6310	0.8	█	160	0.17	1.5	█	115	0.15	1.5	█	125	0.17	1.5	█	480	0.20	1.5	█	45	0.14	1.2	█	30	0.15	1.0
	T7325	0.8	█	185	0.17	1.5	█	140	0.15	1.5	█	–	–	–	█	–	–	–	█	60	0.15	1.2	█	–	–	–
	T7335	0.8	█	180	0.17	1.5	█	140	0.15	1.5	█	–	–	–	█	–	–	–	█	55	0.15	1.2	█	–	–	–
	T8315	0.8	█	170	0.17	1.5	█	100	0.15	1.5	█	160	0.17	1.5	█	510	0.20	1.5	█	40	0.14	1.2	█	30	0.15	1.0
	T8330	0.8	█	160	0.17	1.5	█	95	0.15	1.5	█	150	0.17	1.5	█	480	0.20	1.5	█	40	0.14	1.2	█	30	0.15	1.0
	T8430	0.8	█	190	0.17	1.5	█	105	0.15	1.5	█	155	0.17	1.5	█	525	0.20	1.5	█	40	0.14	1.2	█	30	0.15	1.0
	T9315	0.8	█	255	0.17	1.5	█	–	–	–	█	240	0.17	1.5	█	–	–	–	█	–	–	–	█	50	0.15	1.0
	T9325	0.8	█	235	0.17	1.5	█	140	0.15	1.5	█	220	0.17	1.5	█	–	–	–	█	50	0.15	1.2	█	–	–	–
DNMG 150612E-SF	T6310	1.2	█	145	0.30	1.5	█	100	0.27	1.5	█	115	0.30	1.5	█	435	0.36	1.5	█	40	0.21	1.2	█	25	0.15	1.0
	T7325	1.2	█	165	0.30	1.5	█	125	0.27	1.5	█	–	–	–	█	–	–	–	█	50	0.21	1.2	█	–	–	–
	T9315	1.2	█	210	0.30	1.5	█	–	–	–	█	195	0.30	1.5	█	–	–	–	█	–	–	–	█	40	0.15	1.0

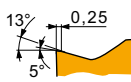

SM geometry with positive design for medium machining, and continuous to interrupted cuts.

DNMG 110404E-SM	T6310	0.4	█	140	0.20	0.8	█	100	0.18	0.8	█	110	0.20	0.8	█	420	0.24	0.8	█	40	0.20	0.6	█	25	0.15	1.0
	T7325	0.4	█	160	0.20	0.8	█	120	0.18	0.8	█	–	–	–	█	–	–	–	█	50	0.20	0.6	█	–	–	–
	T7335	0.4	█	150	0.20	0.8	█	115	0.18	0.8	█	–	–	–	█	–	–	–	█	45	0.20	0.6	█	–	–	–
	T8430	0.4	█	155	0.20	0.8	█	85	0.18	0.8	█	130	0.20	0.8	█	435	0.24	0.8	█	30	0.20	0.6	█	25	0.15	1.0
	T9325	0.4	█	190	0.20	0.8	█	110	0.18	0.8	█	180	0.20	0.8	█	–	–	–	█	40	0.20	0.6	█	–	–	–
DNMG 110408E-SM	T6310	0.8	█	150	0.25	1.2	█	105	0.23	1.2	█	120	0.25	1.2	█	450	0.30	1.2	█	45	0.20	1.0	█	30	0.15	1.0
	T7325	0.8	█	170	0.25	1.2	█	130	0.23	1.2	█	–	–	–	█	–	–	–	█	55	0.20	1.0	█	–	–	–
	T7335	0.8	█	160	0.25	1.2	█	120	0.23	1.2	█	–	–	–	█	–	–	–	█	50	0.20	1.0	█	–	–	–
	T8330	0.8	█	150	0.25	1.2	█	90	0.23	1.2	█	140	0.25	1.2	█	450	0.30	1.2	█	35	0.20	1.0	█	30	0.15	1.0
	T8430	0.8	█	170	0.25	1.2	█	90	0.23	1.2	█	135	0.25	1.2	█	465	0.30	1.2	█	35	0.20	1.0	█	25	0.15	1.0
DNMG 150404E-SM	T6310	0.4	█	125	0.22	1.7	█	90	0.20	1.7	█	100	0.22	1.7	█	375	0.26	1.7	█	35	0.20	1.4	█	25	0.15	1.0
	T6310	0.8	█	140	0.25	2.1	█	100	0.23	2.1	█	110	0.25	2.1	█	420	0.30	2.1	█	40	0.20	1.7	█	25	0.15	1.0
	T6310	0.4	█	125	0.22	1.7	█	90	0.20	1.7	█	100	0.22	1.7	█	375	0.26	1.7	█	35	0.20	1.4	█	25	0.15	1.0
	T7325	0.4	█	140	0.22	1.7	█	105	0.20	1.7	█	–	–	–	█	–	–	–	█	45	0.20	1.4	█	–	–	–
	T7335	0.4	█	140	0.22	1.7	█	105	0.20	1.7	█	–	–	–	█	–	–	–	█	45	0.20	1.4	█	–	–	–
DNMG 150408E-SM	T6310	0.8	█	140	0.25	2.1	█	100	0.23	2.1	█	110	0.25	2.1	█	420	0.30	2.1	█	40	0.20	1.7	█	25	0.15	1.0
	T6310	0.4	█	125	0.22	1.7	█	90	0.20	1.7	█	100	0.22	1.7	█	375	0.26	1.7	█	35	0.20	1.4	█	25	0.15	1.0
	T7325	0.4	█	140	0.22	1.7	█	105	0.20	1.7	█	–	–	–	█	–	–	–	█	45	0.20	1.4	█	–	–	–
	T7335	0.4	█	140	0.22	1.7	█	105	0.20	1.7	█	–	–	–	█	–	–	–	█	45	0.20	1.4	█	–	–	–
	T8330	0.4	█	125	0.22	1.7	█	75	0.20	1.7	█	115	0.22	1.7	█	375	0.26	1.7	█	30	0.20	1.4	█	25	0.15	1.0
DNMG 150604E-SM	T6310	0.4	█	140	0.22	1.7	█	75	0.20	1.7	█	115	0.22	1.7	█	390	0.26	1.7	█	30	0.20	1.4	█	20	0.15	1.0
	T9315	0.4	█	200	0.20	1.7	█	–	–	–	█	190	0.20	1.7	█	–	–	–	█	–	–	–	█	40	0.15	1.0
	T9325	0.4	█	170	0.22	1.7	█	100	0.20	1.7	█	160	0.22	1.7	█	–	–	–								



Suitability and starting values for cutting speed (vc), feed (f) and depth of cut (ap). Refer to our Machining Calculator app for further calculations.

Product	RE <small>(mm)</small>	P			M			K			N			S			H		
		vc <small>[m/min]</small>	f <small>[mm/rev]</small>	ap <small>[mm]</small>	vc <small>[m/min]</small>	f <small>[mm/rev]</small>	ap <small>[mm]</small>	vc <small>[m/min]</small>	f <small>[mm/rev]</small>	ap <small>[mm]</small>	vc <small>[m/min]</small>	f <small>[mm/rev]</small>	ap <small>[mm]</small>	vc <small>[m/min]</small>	f <small>[mm/rev]</small>	ap <small>[mm]</small>	vc <small>[m/min]</small>	f <small>[mm/rev]</small>	ap <small>[mm]</small>

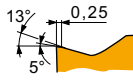

SM geometry with positive design for medium machining, and continuous to interrupted cuts.

DNMG 150608E-SM	T6310	0.8	140	0.25	1.7	100	0.23	1.7	110	0.25	1.7	420	0.30	1.7	40	0.20	1.4	25	0.15	1.0
	T7325	0.8	160	0.25	1.7	120	0.23	1.7	-	-	-	-	-	-	50	0.20	1.4	-	-	-
	T7335	0.8	155	0.25	1.7	120	0.23	1.7	-	-	-	-	-	-	50	0.20	1.4	-	-	-
	T8330	0.8	140	0.25	1.7	80	0.23	1.7	130	0.25	1.7	420	0.30	1.7	35	0.20	1.4	25	0.15	1.0
	T8430	0.8	155	0.25	1.7	85	0.23	1.7	130	0.25	1.7	435	0.30	1.7	30	0.20	1.4	25	0.15	1.0
	T9315	0.8	215	0.25	1.7	-	-	-	200	0.25	1.7	-	-	-	-	-	-	40	0.15	1.0
DNMG 150612E-SM	T6310	1.2	145	0.30	1.7	100	0.27	1.7	115	0.30	1.7	435	0.36	1.7	40	0.24	1.4	25	0.15	1.0
	T7325	1.2	160	0.30	1.7	120	0.27	1.7	-	-	-	-	-	-	50	0.24	1.4	-	-	-
	T7335	1.2	155	0.30	1.7	120	0.27	1.7	-	-	-	-	-	-	50	0.24	1.4	-	-	-
	T8330	1.2	145	0.30	1.7	85	0.27	1.7	135	0.30	1.7	435	0.36	1.7	35	0.24	1.4	25	0.15	1.0
	T8430	1.2	155	0.30	1.7	85	0.27	1.7	130	0.30	1.7	435	0.36	1.7	30	0.24	1.4	25	0.15	1.0
	T9315	1.2	210	0.30	1.7	-	-	-	195	0.30	1.7	-	-	-	-	-	-	40	0.15	1.0
T9325	1.2	190	0.30	1.7	110	0.27	1.7	180	0.30	1.7	-	-	-	40	0.24	1.4	-	-	-	

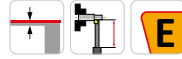
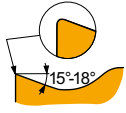

ER-SI geometry with positive right-handed design for fine-finish to semi-rough machining, and continuous cuts.

DNMG 110404ER-SI	T7325	0.4	185	0.20	1.0	140	0.18	1.0	-	-	-	-	-	60	0.18	0.8	-	-	-
	T7335	0.4	180	0.20	1.0	140	0.18	1.0	-	-	-	-	-	55	0.18	0.8	-	-	-
	T8330	0.4	160	0.20	1.0	95	0.18	1.0	-	-	-	480	0.24	1.0	40	0.18	0.8	-	-
	T8430	0.4	185	0.20	1.0	100	0.18	1.0	-	-	-	510	0.24	1.0	40	0.18	0.8	-	-
	T9325	0.4	225	0.20	1.0	135	0.18	1.0	-	-	-	-	-	-	50	0.18	0.8	-	-
DNMG 110408ER-SI	T7335	0.8	175	0.35	1.0	135	0.32	1.0	-	-	-	-	-	55	0.25	0.8	-	-	-
	T8330	0.8	165	0.35	1.0	95	0.32	1.0	-	-	-	495	0.42	1.0	40	0.25	0.8	-	-
	T8430	0.8	180	0.35	1.0	95	0.32	1.0	-	-	-	495	0.42	1.0	35	0.25	0.8	-	-
	T9325	0.8	210	0.35	1.0	125	0.32	1.0	-	-	-	-	-	45	0.25	0.8	-	-	
DNMG 150404ER-SI	T8330	0.4	155	0.20	1.5	90	0.18	1.5	-	-	-	465	0.24	1.5	35	0.18	1.2	-	-
	T8430	0.4	175	0.20	1.5	95	0.18	1.5	-	-	-	480	0.24	1.5	35	0.18	1.2	-	-
	T9325	0.4	220	0.20	1.5	130	0.18	1.5	-	-	-	-	-	45	0.18	1.2	-	-	
DNMG 150408ER-SI	T8330	0.8	160	0.35	1.5	95	0.32	1.5	-	-	-	480	0.42	1.5	40	0.25	1.2	-	-
	T8430	0.8	170	0.35	1.5	90	0.32	1.5	-	-	-	465	0.42	1.5	35	0.25	1.2	-	-
	T9325	0.8	200	0.35	1.5	120	0.32	1.5	-	-	-	-	-	45	0.25	1.2	-	-	
DNMG 150604ER-SI	T7325	0.4	180	0.20	1.5	140	0.18	1.5	-	-	-	-	-	55	0.18	1.2	-	-	-
	T7335	0.4	170	0.20	1.5	130	0.18	1.5	-	-	-	-	-	55	0.18	1.2	-	-	-
	T8315	0.4	165	0.20	1.5	95	0.18	1.5	-	-	-	495	0.24	1.5	40	0.18	1.2	-	-
	T8330	0.4	155	0.20	1.5	90	0.18	1.5	-	-	-	465	0.24	1.5	35	0.18	1.2	-	-
	T8430	0.4	175	0.20	1.5	95	0.18	1.5	-	-	-	480	0.24	1.5	35	0.18	1.2	-	-
	T9325	0.4	220	0.20	1.5	130	0.18	1.5	-	-	-	-	-	45	0.18	1.2	-	-	
DNMG 150608ER-SI	T7325	0.8	180	0.35	1.5	140	0.32	1.5	-	-	-	-	-	55	0.25	1.2	-	-	-
	T7335	0.8	170	0.35	1.5	130	0.32	1.5	-	-	-	-	-	55	0.25	1.2	-	-	-
	T8315	0.8	165	0.35	1.5	95	0.32	1.5	-	-	-	495	0.42	1.5	40	0.25	1.2	-	-
	T8330	0.8	160	0.35	1.5	95	0.32	1.5	-	-	-	480	0.42	1.5	40	0.25	1.2	-	-
	T8430	0.8	170	0.35	1.5	90	0.32	1.5	-	-	-	465	0.42	1.5	35	0.25	1.2	-	-
	T9325	0.8	200	0.35	1.5	120	0.32	1.5	-	-	-	-	-	45	0.25	1.2	-	-	
T9335	0.8	180	0.35	1.5	105	0.32	1.5	-	-	-	-	-	40	0.25	1.2	-	-		

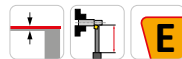
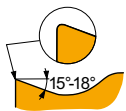

EL-SI geometry with positive left-handed design, for fine-finish to semi-rough machining, and continuous cuts.

DNMG 110404EL-SI	T7335	0.4	180	0.20	1.0	140	0.18	1.0	-	-	-	-	-	55	0.18	0.8	-	-	-
	T8330	0.4	160	0.20	1.0	95	0.18	1.0	-	-	-	480	0.24	1.0	40	0.18	0.8	-	-
	T8430	0.4	185	0.20	1.0	100	0.18	1.0	-	-	-	510	0.24	1.0	40	0.18	0.8	-	-
	T9325	0.4	225	0.20	1.0	135	0.18	1.0	-	-	-	-	-	50	0.18	0.8	-	-	



Suitability and starting values for cutting speed (vc), feed (f) and depth of cut (ap). Refer to our Machining Calculator app for further calculations.

Product	RE (mm)	P			M			K			N			S			H		
		vc (m/min)	f (mm/rev)	ap (mm)	vc (m/min)	f (mm/rev)	ap (mm)	vc (m/min)	f (mm/rev)	ap (mm)	vc (m/min)	f (mm/rev)	ap (mm)	vc (m/min)	f (mm/rev)	ap (mm)	vc (m/min)	f (mm/rev)	ap (mm)

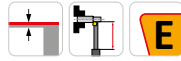
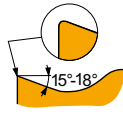

EL-SI geometry with positive left-handed design, for fine-finish to semi-rough machining, and continuous cuts.

DNMG 110408EL-SI	T7325	0.8	185	0.35	1.0	140	0.32	1.0	-	-	-	-	-	-	60	0.25	0.8	-	-	-
	T8330	0.8	165	0.35	1.0	95	0.32	1.0	-	-	-	495	0.42	1.0	40	0.25	0.8	-	-	-
	T8430	0.8	180	0.35	1.0	95	0.32	1.0	-	-	-	495	0.42	1.0	35	0.25	0.8	-	-	-
	T9325	0.8	210	0.35	1.0	125	0.32	1.0	-	-	-	-	-	-	45	0.25	0.8	-	-	-
DNMG 150404EL-SI	T8330	0.4	155	0.20	1.5	90	0.18	1.5	-	-	-	465	0.24	1.5	35	0.18	1.2	-	-	-
	T8430	0.4	175	0.20	1.5	95	0.18	1.5	-	-	-	480	0.24	1.5	35	0.18	1.2	-	-	-
	T9325	0.4	220	0.20	1.5	130	0.18	1.5	-	-	-	-	-	-	45	0.18	1.2	-	-	-
DNMG 150408EL-SI	T7335	0.8	170	0.35	1.5	130	0.32	1.5	-	-	-	-	-	-	55	0.25	1.2	-	-	-
	T8330	0.8	160	0.35	1.5	95	0.32	1.5	-	-	-	480	0.42	1.5	40	0.25	1.2	-	-	-
	T8430	0.8	170	0.35	1.5	90	0.32	1.5	-	-	-	465	0.42	1.5	35	0.25	1.2	-	-	-
	T9325	0.8	200	0.35	1.5	120	0.32	1.5	-	-	-	-	-	-	45	0.25	1.2	-	-	-
DNMG 150604EL-SI	T7325	0.4	180	0.20	1.5	140	0.18	1.5	-	-	-	-	-	-	55	0.18	1.2	-	-	-
	T7335	0.4	170	0.20	1.5	130	0.18	1.5	-	-	-	-	-	-	55	0.18	1.2	-	-	-
	T8315	0.4	165	0.20	1.5	95	0.18	1.5	-	-	-	495	0.24	1.5	40	0.18	1.2	-	-	-
	T8330	0.4	155	0.20	1.5	90	0.18	1.5	-	-	-	465	0.24	1.5	35	0.18	1.2	-	-	-
	T8430	0.4	175	0.20	1.5	95	0.18	1.5	-	-	-	480	0.24	1.5	35	0.18	1.2	-	-	-
	T9325	0.4	220	0.20	1.5	130	0.18	1.5	-	-	-	-	-	-	45	0.18	1.2	-	-	-
	T9335	0.4	185	0.20	1.5	110	0.18	1.5	-	-	-	-	-	-	40	0.18	1.2	-	-	-
DNMG 150608EL-SI	T7325	0.8	180	0.35	1.5	140	0.32	1.5	-	-	-	-	-	-	55	0.25	1.2	-	-	-
	T7335	0.8	170	0.35	1.5	130	0.32	1.5	-	-	-	-	-	-	55	0.25	1.2	-	-	-
	T8315	0.8	165	0.35	1.5	95	0.32	1.5	-	-	-	495	0.42	1.5	40	0.25	1.2	-	-	-
	T8330	0.8	160	0.35	1.5	95	0.32	1.5	-	-	-	480	0.42	1.5	40	0.25	1.2	-	-	-
	T8430	0.8	170	0.35	1.5	90	0.32	1.5	-	-	-	465	0.42	1.5	35	0.25	1.2	-	-	-
	T9325	0.8	200	0.35	1.5	120	0.32	1.5	-	-	-	-	-	-	45	0.25	1.2	-	-	-

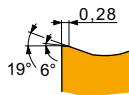

W-MR wiper geometry for finish to rough machining with increased feed rates and improved surface finish.

DNMG 150608W-MR	T5315	0.8	190	0.40	1.5	-	-	-	180	0.40	1.5	-	-	-	-	-	-	-	-	-
	T9315	0.8	170	0.40	1.5	-	-	-	160	0.40	1.5	-	-	-	-	-	-	-	-	-
	T9325	0.8	155	0.40	1.5	90	0.36	1.5	145	0.40	1.5	-	-	-	-	-	-	-	-	-
DNMG 150612W-MR	T9310	1.2	175	0.50	1.5	-	-	-	165	0.50	1.5	-	-	-	-	-	-	-	-	-
	T9315	1.2	160	0.50	1.5	-	-	-	150	0.50	1.5	-	-	-	-	-	-	-	-	-
	T9325	1.2	145	0.50	1.5	85	0.45	1.5	135	0.50	1.5	-	-	-	-	-	-	-	-	-

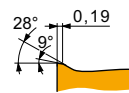

W-NM wiper geometry for finish to rough machining with increased feed rates and improved surface finish.

DNMX 150604W-NM	T7325	0.4	145	0.30	1.5	110	0.27	1.5	-	-	-	-	-	-	45	0.21	1.2	-	-	-
	T7335	0.4	135	0.30	1.5	105	0.27	1.5	-	-	-	-	-	-	40	0.21	1.2	-	-	-
	T9315	0.4	185	0.30	1.5	-	-	-	175	0.30	1.5	-	-	-	-	-	-	-	-	-
DNMX 150608W-NM	T7325	0.8	155	0.40	1.5	120	0.36	1.5	-	-	-	-	-	-	50	0.28	1.2	-	-	-
	T7335	0.8	145	0.40	1.5	110	0.36	1.5	-	-	-	-	-	-	45	0.28	1.2	-	-	-
	T9315	0.8	195	0.40	1.5	-	-	-	185	0.40	1.5	-	-	-	-	-	-	-	-	-
	T9325	0.8	175	0.40	1.5	105	0.36	1.5	165	0.40	1.5	-	-	-	35	0.28	1.2	-	-	-



DNMM

	IC	D1	L	S
	[mm]	[mm]	[mm]	[mm]
1504	12.700	5.16	15.50	4.76
1506	12.700	5.16	15.50	6.35

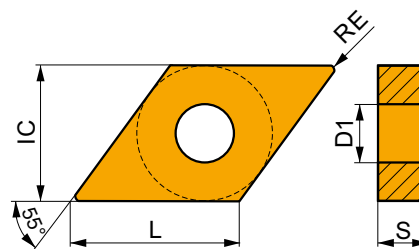

Suitability and starting values for cutting speed (vc), feed (f) and depth of cut (ap). Refer to our Machining Calculator app for further calculations.

Product	RE	P			M			K			N			S			H		
		vc	f	ap	vc	f	ap	vc	f	ap	vc	f	ap	vc	f	ap	vc	f	ap
	[mm]	[m/min]	[mm/rev]	[mm]	[m/min]	[mm/rev]	[mm]	[m/min]	[mm/rev]	[mm]	[m/min]	[mm/rev]	[mm]	[m/min]	[mm/rev]	[mm]	[m/min]	[mm/rev]	[mm]

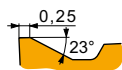

NR geometry for semi-rough to rough machining, and continuous to interrupted cuts.

DNMM 150408E-NR	T9325	0.8	█	155	0.40	3.0	█	90	0.36	3.0	█	145	0.40	3.0	–	–	–	█	30	0.28	2.4	–	–	–
DNMM 150608E-NR	T7325	0.8	█	140	0.40	3.0	█	105	0.36	3.0	–	–	–	–	–	–	–	█	45	0.28	2.4	–	–	–
	T8330	0.8	█	125	0.40	3.0	█	75	0.36	3.0	█	115	0.40	3.0	–	–	–	█	30	0.28	2.4	–	–	–
	T8430	0.8	█	130	0.40	3.0	█	70	0.36	3.0	█	105	0.40	3.0	–	–	–	█	25	0.28	2.4	–	–	–
	T9325	0.8	█	155	0.40	3.0	█	90	0.36	3.0	█	145	0.40	3.0	–	–	–	█	30	0.28	2.4	–	–	–

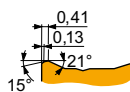

NR2 geometry for semi-rough to rough machining, and continuous to interrupted cuts.

DNMM 150608E-NR2	T9325	0.8	█	155	0.40	3.0	█	90	0.36	3.0	█	145	0.40	3.0	–	–	–	█	30	0.32	2.4	–	–	–
------------------	-------	-----	---	-----	------	-----	---	----	------	-----	---	-----	------	-----	---	---	---	---	----	------	-----	---	---	---

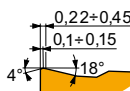

OR geometry for semi-rough to rough machining, and continuous to interrupted cuts.

DNMM 150608E-OR	T9325	0.8	█	155	0.40	3.0	█	90	0.36	3.0	█	145	0.40	3.0	–	–	–	█	30	0.28	2.4	–	–	–
DNMM 150612E-OR	T9315	1.2	█	180	0.40	3.0	–	–	–	–	█	170	0.40	3.0	–	–	–	–	–	–	–	–	–	–
	T9325	1.2	█	165	0.40	3.0	█	95	0.36	3.0	█	155	0.40	3.0	–	–	–	█	35	0.32	2.4	–	–	–
	T9335	1.2	█	145	0.40	3.0	█	85	0.36	3.0	–	–	–	–	–	–	–	█	30	0.32	2.4	–	–	–
DNMM 150616E-OR	T9325	1.6	█	165	0.45	3.0	█	95	0.41	3.0	█	155	0.45	3.0	–	–	–	█	35	0.41	2.4	–	–	–



DNGA CER

	IC	D1	L	S
	[mm]	[mm]	[mm]	[mm]
1504	12.700	5.16	15.50	4.76

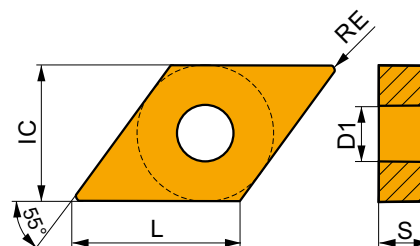

Suitability and starting values for cutting speed (vc), feed (f) and depth of cut (ap). Refer to our Machining Calculator app for further calculations.

Product	RE	P			M			K			N			S			H		
		vc	f	ap	vc	f	ap	vc	f	ap	vc	f	ap	vc	f	ap	vc	f	ap
	[mm]	[m/min]	[mm/rev]	[mm]	[m/min]	[mm/rev]	[mm]	[m/min]	[mm/rev]	[mm]	[m/min]	[mm/rev]	[mm]	[m/min]	[mm/rev]	[mm]	[m/min]	[mm/rev]	[mm]

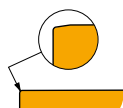

For machining with high speeds and continuous cuts.

DNGA 150408 S02020	TC100	0.8	-	-	-	-	-	-	450	0.20	1.5	-	-	-	-	-	-	-	-	-
--------------------	-------	-----	---	---	---	---	---	---	-----	------	-----	---	---	---	---	---	---	---	---	---

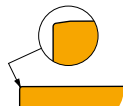

For machining with high speeds and continuous cuts.

DNGA 150404 T01020	TC100	0.4	-	-	-	-	-	-	475	0.10	1.5	-	-	-	-	-	-	-	-	-
DNGA 150408 T00520	TC100	0.8	-	-	-	-	-	-	450	0.20	1.5	-	-	-	-	-	-	-	-	-

DNGN CER

	IC	L	S
	[mm]	[mm]	[mm]
1504	12.700	15.50	4.76

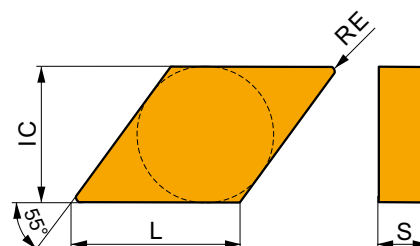

Suitability and starting values for cutting speed (vc), feed (f) and depth of cut (ap). Refer to our Machining Calculator app for further calculations.

Product	RE	P			M			K			N			S			H		
		vc	f	ap	vc	f	ap	vc	f	ap	vc	f	ap	vc	f	ap	vc	f	ap
	[mm]	[m/min]	[mm/rev]	[mm]	[m/min]	[mm/rev]	[mm]	[m/min]	[mm/rev]	[mm]	[m/min]	[mm/rev]	[mm]	[m/min]	[mm/rev]	[mm]	[m/min]	[mm/rev]	[mm]

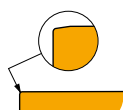
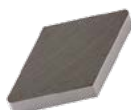

For machining with high speeds and continuous cuts.

DNGN 150408 T01020	TC100	0.8	-	-	-	-	-	-	450	0.20	1.5	-	-	-	-	-	-	-	-	-
--------------------	-------	-----	---	---	---	---	---	---	-----	------	-----	---	---	---	---	---	---	---	---	---



DNGA CBN

	IC	D1	L	S
	[mm]	[mm]	[mm]	[mm]
1506	12.700	5.16	15.50	6.35

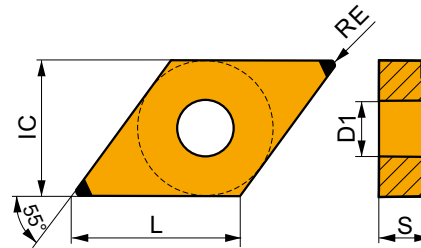

Suitability and starting values for cutting speed (vc), feed (f) and depth of cut (ap). Refer to our Machining Calculator app for further calculations.

Product	RE [mm]	P			M			K			N			S			H		
		vc [m/min]	f [mm/rev]	ap [mm]	vc [m/min]	f [mm/rev]	ap [mm]	vc [m/min]	f [mm/rev]	ap [mm]	vc [m/min]	f [mm/rev]	ap [mm]	vc [m/min]	f [mm/rev]	ap [mm]	vc [m/min]	f [mm/rev]	ap [mm]

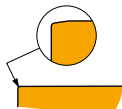

For finish machining and continuous cuts.

DNGA 150608S01020B	TB310	0.8	-	-	-	-	-	420	0.15	0.6	-	-	-	110	0.11	0.5	85	0.15	1.0
--------------------	-------	-----	---	---	---	---	---	-----	------	-----	---	---	---	-----	------	-----	----	------	-----



DDJN(RL) EXT



PRAMET

D



External Double Clamp Turning Holder with 93° Cutting Angle for DN.. Insert

External Right/Left hand double clamp tool holder with 93° cutting angle. Suited for longitudinal turning with shoulder, copying, chamfering and facing with negative DN.. 11 or 15 size inserts. Available with shank size 20x20 up to 32x32 mm. Body treated for longer tool life.

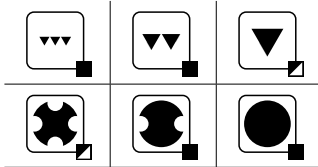
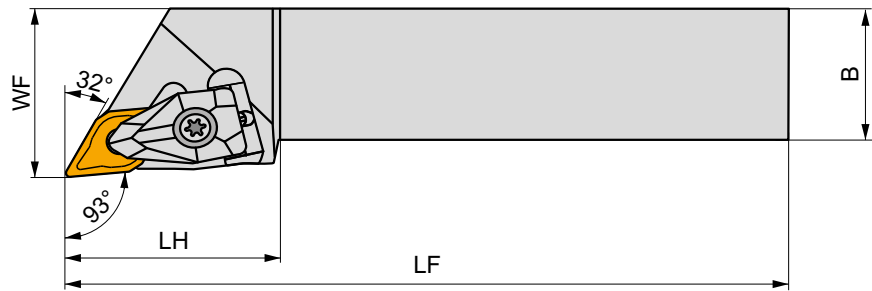
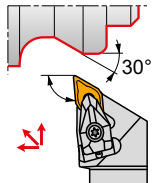

Product	H	B	HF	WF	LF	LH	LAMS	GAMO	kg				
	[mm]	[mm]	[mm]	[mm]	[mm]	[mm]	[°]	[°]					
R	DDJNR 2020 K 11	20	20	20	25	125	30.2	-7	-6	0.45	GI046	DD11	-
	DDJNR 2525 M 11	25	25	25	32	150	30.2	-7	-6	0.77	GI046	DD11	-
	DDJNR 2020 K 15	20	20	20	25	125	39.4	-7	-6	0.42	GI044	DD154	AT002
	DDJNR 2525 M 15	25	25	25	32	150	39.4	-7	-6	0.74	GI044	DD154	AT002
	DDJNR 3225 P 15	32	25	32	32	170	39.4	-7	-6	1.12	GI044	DD154	AT002
	DDJNR 3232 P 15	32	32	32	40	170	39.4	-7	-6	1.33	GI044	DD154	AT002
L	DDJNL 2020 K 11	20	20	20	25	125	30.2	-7	-6	0.45	GI046	DD11	-
	DDJNL 2525 M 11	25	25	25	32	150	30.2	-7	-6	0.77	GI046	DD11	-
	DDJNL 2020 K 15	20	20	20	25	125	39.4	-7	-6	0.42	GI044	DD154	AT002
	DDJNL 2525 M 15	25	25	25	32	150	39.4	-7	-6	0.74	GI044	DD154	AT002
	DDJNL 3225 P 15	32	25	32	32	170	39.4	-7	-6	1.01	GI044	DD154	AT002
	DDJNL 3232 P 15	32	32	32	40	170	39.4	-7	-6	1.34	GI044	DD154	AT002



GI044

DN.. 1506..

GI046

DN.. 1104..



DD11

DCS 09

1.7

DDS 267-01

US 2004-T09P

FLAG T09P

DD154

DCS 12

3.9

DDS 266-02

US 2002-T15P

FLAG T15P/3,5



AT002a

DN.. 1504..

-

DDS 266-01

AT002b

CER DN.N 1506..

DCS 12C4

-

AT002c

CER DN.A 1506..

DCS 12C2

-



PDJN(RL) EXT



PRAMET

P



External Lever Lock Turning Holder with 93° Cutting Angle for DN.. Insert

External Right/Left hand lever lock tool holder with 93° cutting angle. Suited for longitudinal turning with shoulder, copy turning up to 30°, and chamfering with negative DN.. 11 and 15 size inserts. Available with shank size 20x20 up to 32x32 mm. Body treated for longer tool life.

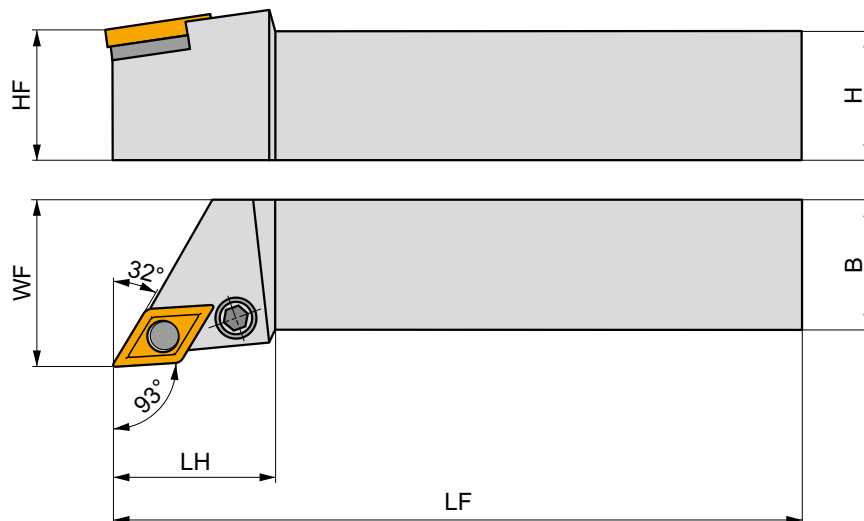
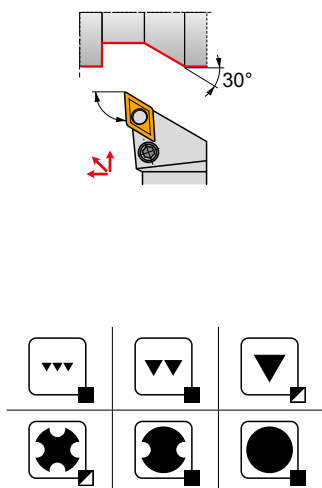

Product	⌀	B	HF	WF	LF	LH	LAMS	GAMO	kg			
	[mm]	[mm]	[mm]	[mm]	[mm]	[mm]	[°]	[°]				
R	PDJNR 2020 K 11	20	20	20	25	125	30	-6	-6	0.43	GI046	PD60
	PDJNR 2525 M 11	25	25	25	32	150	30	-6	-6	0.73	GI046	PD60
	PDJNR 3225 P 11	32	25	32	32	170	30	-6	-6	1.10	GI046	PD60
	PDJNR 2020 K 15	20	20	20	25	125	40	-6	-6	0.44	GI044	PD31
	PDJNR 2525 M 15	25	25	25	32	150	40	-6	-6	0.73	GI044	PD30
	PDJNR 3225 P 15	32	25	32	32	170	40	-6	-6	1.05	GI044	PD30
L	PDJNL 2020 K 11	20	20	20	25	125	30	-6	-6	0.41	GI046	PD60
	PDJNL 2525 M 11	25	25	25	32	150	30	-6	-6	0.73	GI046	PD60
	PDJNL 3225 P 11	32	25	32	32	170	30	-6	-6	1.10	GI046	PD60
	PDJNL 2020 K 15	20	20	20	25	125	40	-6	-6	0.42	GI044	PD31
	PDJNL 2525 M 15	25	25	25	32	150	40	-6	-6	0.73	GI044	PD30
	PDJNL 3225 P 15	32	25	32	32	170	40	-6	-6	0.98	GI044	PD30
PDJNL 3232 P 15	32	32	32	40	170	40	-6	-6	1.30	GI044	PD30	

GI044		DN.. 1506..	
GI046		DN.. 1104..	

PD30	DNU 150308	PU 03	US 36	6.0	M 8x1	26	NT 05	MT 05	HXK 4
PD31	DNU 150308	PU 03	US 40	6.0	M 8x1	20.5	NT 05	MT 05	HXK 4
PD60	PDN 110308	PU 3512	PS 0616	3.0	M 6	16	NT 5153	MT 0912	HXK 2.5



PDNN(RL) EXT



External Lever Lock Turning Holder with 63° Cutting Angle for DN.. Insert

External Right/Left hand lever lock 63° (neutral) tool holder. Suited for longitudinal turning without shoulder, taper, copy, and chamfer turning with negative DN.. 15 size inserts. Available with shank size 20x20 up to 32x25 mm. Body treated for longer tool life.

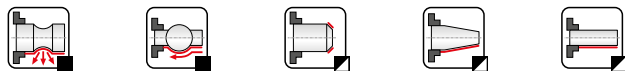
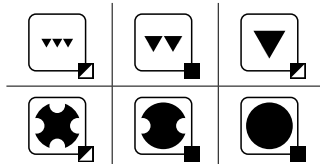
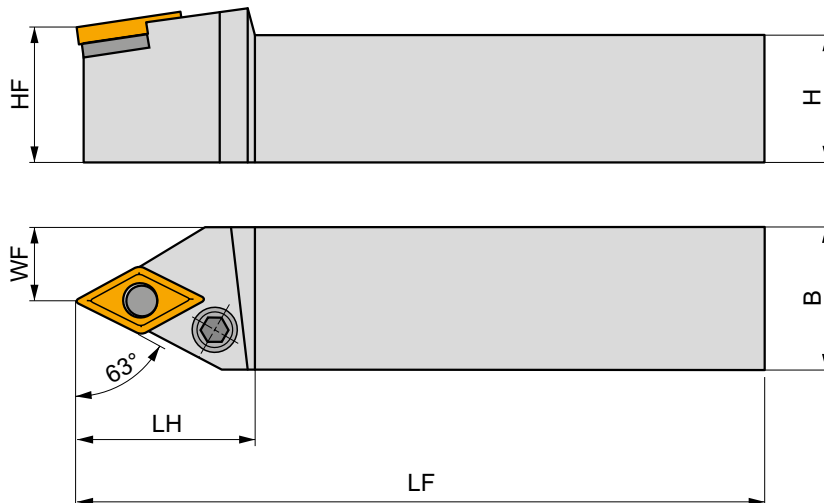
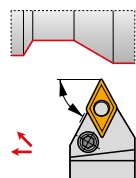

Product	H	B	HF	WF	LF	LH	LAMS	GAMO	kg		
	[mm]	[mm]	[mm]	[mm]	[mm]	[mm]	[°]	[°]			
R PDNNR 2020 K 11	20	20	20	10	125	24	-6	-6	0.39	GI046	PD60
PDNNR 2525 M 11	25	25	25	12.5	150	30	-6	-6	0.60	GI046	PD60
PDNNR 2525 M 15	25	25	25	12.5	150	40	-6	-6	0.64	GI044	PD30
PDNNR 3225 P 15	32	25	32	12.5	170	40	-6	-6	1.05	GI044	PD30
L PDNNL 2020 K 11	20	20	20	10	125	24	-6	-6	0.40	GI046	PD60
PDNNL 2525 M 11	25	25	25	12.5	150	30	-6	-6	0.60	GI046	PD60
PDNNL 2525 M 15	25	25	25	12.5	150	40	-6	-6	0.07	GI044	PD30
PDNNL 3225 P 15	32	25	32	12.5	170	40	-6	-6	1.05	GI044	PD30



GI044

GI046



DN.. 1506..

DN.. 1104..



PD30

DNU 150308

PU 03

US 36

6.0

M 8x1

26

NT 05

MT 05

HXK 4

PD60

PDN 110308

PU 3512

PS 0616

3.0

M 6

16

NT 5153

MT 0912

HXK 2.5



PDXN(RL) EXT



PRAMET

P



External Lever Lock Turning Holder with 98° Cutting Angle for DN.. Insert

External Right/Left hand lever lock tool holder with 98° cutting angle. Suited for taper, longitudinal turning with shoulder, copy turning up to 22° and chamfering with negative DN.. 15 size inserts. Available in 20x20 up to 32x25 mm shanks. Body treated for longer tool life.

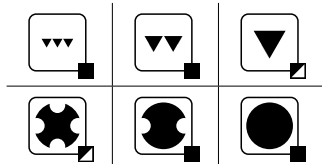
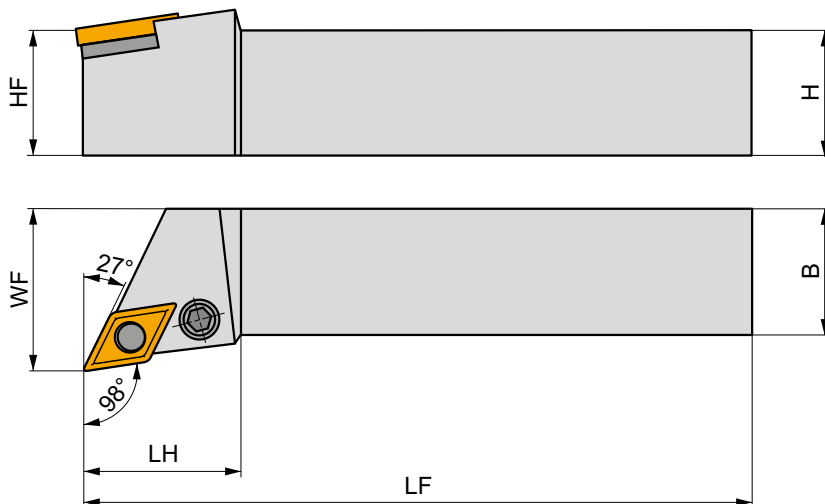
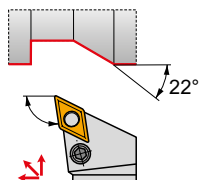

Product	H	B	HF	WF	LF	LH	LAMS	GAMO	kg		
	[mm]	[mm]	[mm]	[mm]	[mm]	[mm]	[°]	[°]			
R PDXNR 2020 K 15	20	20	20	25	125	40	-6	-6	0.43	G1044	PD31
PDXNR 2525 M 15	25	25	25	32	150	40	-6	-6	0.73	G1044	PD30
PDXNR 3225 P 15	32	25	32	32	170	40	-6	-6	0.80	G1044	PD30
L PDXNL 2020 K 15	20	20	20	25	125	40	-6	-6	0.42	G1044	PD31
PDXNL 2525 M 15	25	25	25	32	150	40	-6	-6	0.71	G1044	PD30
PDXNL 3225 P 15	32	25	32	32	170	40	-6	-6	0.95	G1044	PD30



G1044



DN.. 1506..



PD30



DNU 150308



PU 03



US 36



6.0



M 8x1



26



NT 05



MT 05



HXK 4

PD31

DNU 150308

PU 03

US 40

6.0

M 8x1

20.5

NT 05

MT 05

HXK 4



C.-DDJN(RL) EXT



Ext. PSC Quick Change Tool, Double Clamp, 93° Cutting Angle for DN.. Insert

External Right/Left hand double clamp tool, through coolant, with 93° cutting angle for taper and longitudinal turning with shoulder, copying and chamfering with negative DN.. 11 or 15 size inserts. Available with PSC (Polygon Shank Coupling) C4 up to C6 coupling. Body treated for longer tool life.

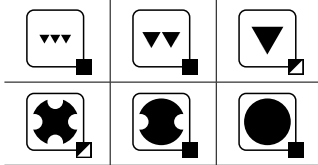
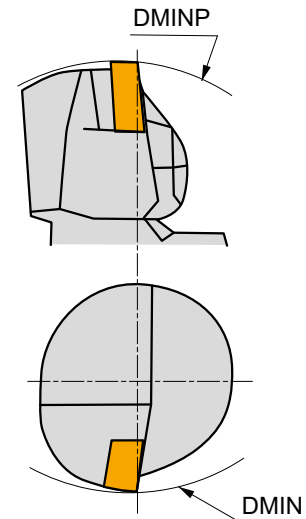
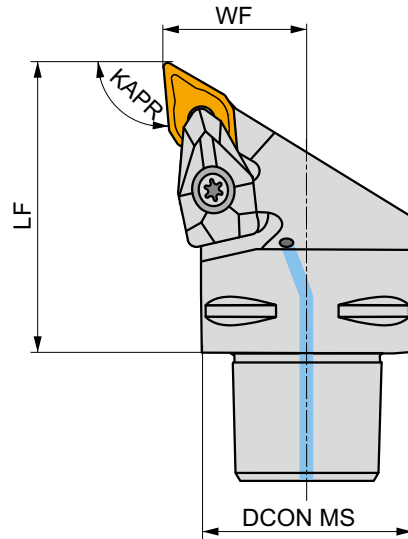
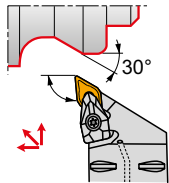

Product	DCON MS	DMIN	DMINP	WF	LF	KAPR	LAMS	GAMO						
	[mm]	[mm]	[mm]	[mm]	[mm]	[°]	[°]	[°]						
R	C4-DDJNR-27050-11	40	60	140	27	50	93	-7	-6	✓	0.38	GI046	C-DD11	-
	C4-DDJNR-27055-15	40	110	145	27	55	93	-7	-6	✓	0.43	GI044	C-DD154-1	AT002
	C5-DDJNR-35060-15	50	110	165	35	60	93	-7	-6	✓	0.72	GI044	C-DD154-2	AT002
	C6-DDJNR-45065-15	63	110	190	45	65	93	-7	-6	✓	1.18	GI044	C-DD154-3	AT002
L	C4-DDJNL-27050-11	40	60	140	27	50	93	-7	-6	✓	0.39	GI046	C-DD11	-
	C4-DDJNL-27055-15	40	110	145	27	55	93	-7	-6	✓	0.43	GI044	C-DD154-1	AT002
	C5-DDJNL-35060-15	50	110	165	35	60	93	-7	-6	✓	0.72	GI044	C-DD154-2	AT002
C6-DDJNL-45065-15	63	110	190	45	65	93	-7	-6	✓	1.18	GI044	C-DD154-3	AT002	



GI044
GI046



DN.. 1506..
DN.. 1104..



C-DD11	DCS 09	1.7	DDS 267-01	US 2004-T09P	FLAG T09P	CN 034-01
C-DD154-1	DCS 12	3.9	DDS 266-02	US 2002-T15P	FLAG T15P/3,5	CN 034-01
C-DD154-2	DCS 12	3.9	DDS 266-02	US 2002-T15P	FLAG T15P/3,5	CN 045-01
C-DD154-3	DCS 12	3.9	DDS 266-02	US 2002-T15P	FLAG T15P/3,5	CN 034-02



AT002a	DN.. 1504..	-	DDS 266-01
AT002b	CER DN.N 1506..	DCS 12C4	-
AT002c	CER DN.A 1506..	DCS 12C2	-
AT002d	CER DN.N 1504..	DCS 12C4	DDS 266-01
AT002e	CER DN.A 1504..	DCS 12C2	DDS 266-01



C.-DDNNN EXT



Ext. PSC Quick Change Tool, Double Clamp, 62.5° Cutting Angle for DN.. Insert

External Right/Left hand double clamp tool, through coolant, with 62.5° cutting angle for taper and longitudinal turning without shoulder, copying and chamfering with negative DN.. 15 size inserts. Available with PSC (Polygon Shank Coupling) C5 and C6 coupling. Body treated for longer tool life.

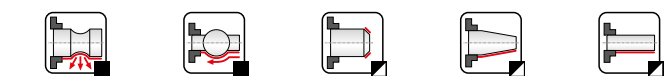
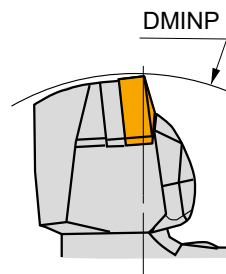
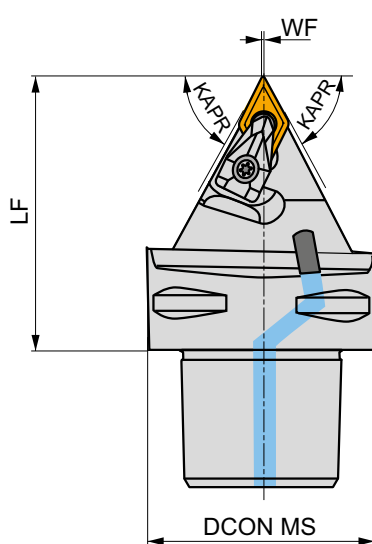
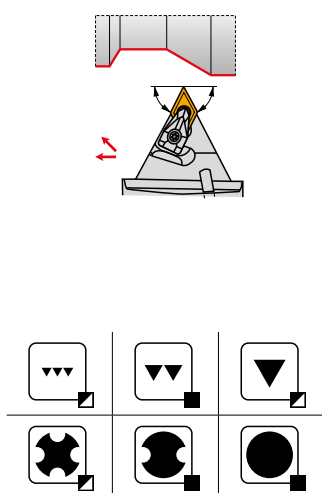

Product	DCON MS	DMINP	WF	LF	KAPR	LAMS	GAMO					
	[mm]	[mm]	[mm]	[mm]	[°]	[°]	[°]					
N C5-DDNNN-00060-15	50	165	0.5	60	62.5	-9	-5	✓	0.62	GI044	C-DD154-2	AT002
	C6-DDNNN-00065-15	63	190	0.5	65	62.5	-9	✓	1.06	GI044	C-DD154-2	AT002

GI044	DN.. 1506..

C-DD154-2	DCS 12	3.9	DDS 266-02	US 2002-T15P	FLAG T15P/3,5	CN 045-01

AT002a	DN.. 1504..	-	DDS 266-01
AT002b	CER DN.N 1506..	DCS 12C4	-
AT002c	CER DN.A 1506..	DCS 12C2	-
AT002d	CER DN.N 1504..	DCS 12C4	DDS 266-01
AT002e	CER DN.A 1504..	DCS 12C2	DDS 266-01



C.-DDUN(RL) EXT

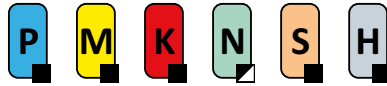

Ext. PSC Quick Change Tool, Double Clamp, 93° (Face) Cutting Angle, DN.. Ins

External Right/Left hand double clamp tool, through coolant, with 93° cutting angle for face turning with shoulder, face copy turning, taper turning, longitudinal turning and chamfering with negative DN.. 15 size inserts. Available with PSC (Polygon Shank Coupling) C5 and C6 coupling. Body treated for longer tool life.

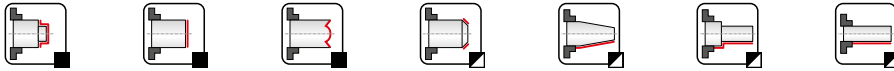
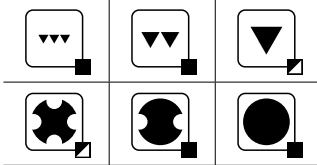
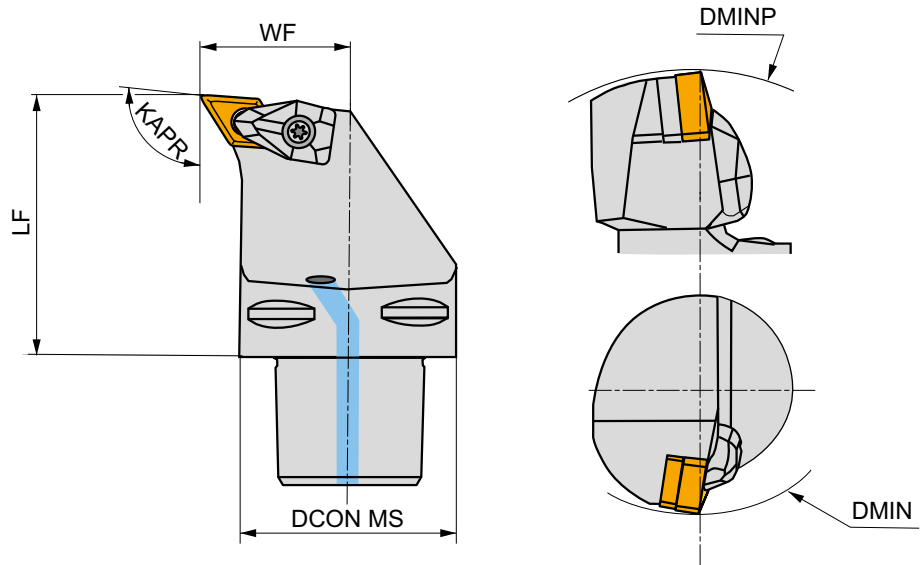
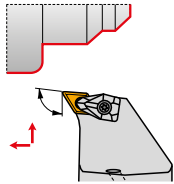

Product	DCON MS	DMIN	DMINP	WF	LF	KAPR	LAMS	GAMO					
	[mm]	[mm]	[mm]	[mm]	[mm]	[°]	[°]	[°]					
R C5-DDUNR-35060-15	50	110	165	35	60	93	-7	-6	✓	0.82	GI044	C-DD154-3	AT002
C6-DDUNR-45065-15	63	110	190	45	65	93	-7	-6	✓	1.39	GI044	C-DD154-3	AT002
L C5-DDUNL-35060-15	50	110	165	35	60	93	-7	-6	✓	0.82	GI044	C-DD154-3	AT002



GI044



DN.. 1506..



C-DD154-3



DCS 12



3.9



DDS 266-02



US 2002-T15P



FLAG T15P/3,5



CN 034-02



AT002a



DN.. 1504..



DCS 12C4



DDS 266-01

AT002b

CER DN.N 1506..

DCS 12C2

AT002c

CER DN.A 1506..

DCS 12C2

AT002d

CER DN.N 1504..

DCS 12C4

DDS 266-01

AT002e

CER DN.A 1504..

DCS 12C2

DDS 266-01



DDUN(RL) INT



PRAMET

D



Internal Double Clamp Boring Bar with 93° Cutting Angle for DN.. Insert

Internal Right/Left hand double clamp boring bar, through coolant, 93° cutting angle for DN.. 11 and 15 inserts. Minimum internal turning diameter Ø32 mm. Suited for wide range of internal turning applications, copy turning up to 27°. Available with shank size Ø25 up to Ø50 mm. Body treated for longer tool life.

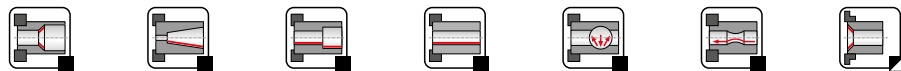
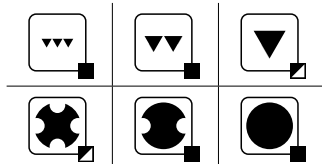
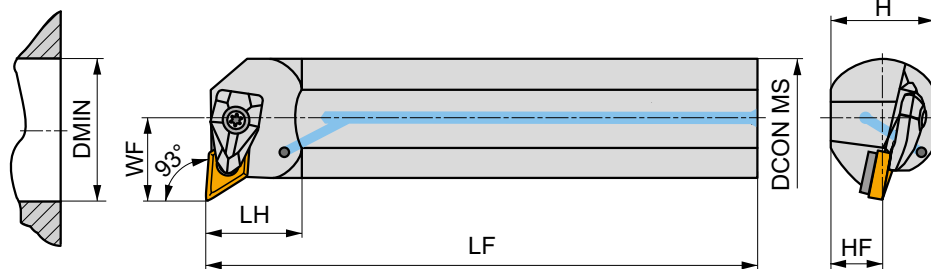
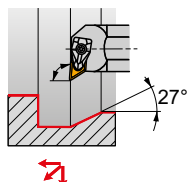

Product	DCON MS	DMIN	WF	H	HF	LF	LH	LAMS	GAMO	✓	kg	GI046	DD11	AT002	
	[mm]	[mm]	[mm]	[mm]	[mm]	[mm]	[mm]	[°]	[°]						
R	A25T-DDUNR 11	25	32	17	23	11.5	300	28	-12	-6	✓	0.96	GI046	DD11	-
	A32T-DDUNR 11	32	40	22	30	15	300	30	-10	-6	✓	1.68	GI046	DD11	-
	A40T-DDUNR 15	40	50	27	37	18.5	300	36	-11	-6	✓	2.59	GI044	DD154	AT002
L	A50U-DDUNR 15	50	63	35	47	23.5	350	39	-8	-6	✓	5.23	GI044	DD154	AT002
	A25T-DDUNL 11	25	32	17	23	11.5	300	28	-12	-6	✓	0.96	GI046	DD11	-
	A32T-DDUNL 11	32	40	22	30	15	300	30	-10	-6	✓	1.69	GI046	DD11	-
	A40T-DDUNL 15	40	50	27	37	18.5	300	36	-11	-6	✓	2.59	GI044	DD154	AT002
	A50U-DDUNL 15	50	63	35	47	23.5	350	39	-8	-6	✓	5.25	GI044	DD154	AT002



GI044

DN.. 1506..

GI046

DN.. 1104..



DD11

DCS 09

1.7

DDS 267-01

US 2004-T09P

FLAG T09P

DD154

DCS 12

3.9

DDS 266-02

US 2002-T15P

FLAG T15P/3,5



AT002a

DN.. 1504..

-

DDS 266-01

AT002b

CER DN.N 1506..

DCS 12C4

AT002c

CER DN.A 1506..

DCS 12C2



PDUN(RL) INT



Internal Lever Lock Boring Bar with 93° Cutting Angle for DN.. Insert

Internal Right/Left hand lever lock boring bar, through coolant available, 93° cutting angle for DN.. 11 and 15 inserts. Minimum internal turning diameter Ø32 mm. For a wide range of internal turning applications, copy turning up to 27°. Available with shank size Ø25 up to Ø60 mm. Body treated for longer tool life.

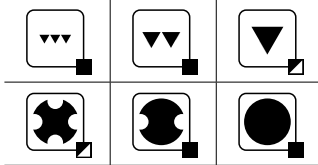
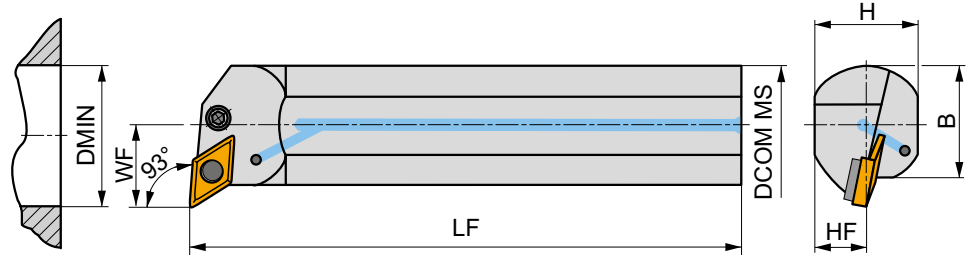
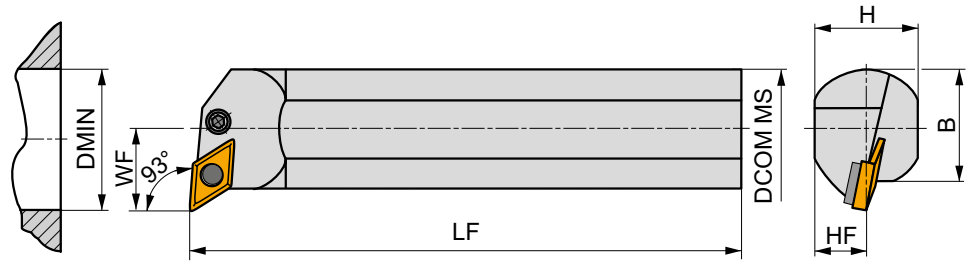
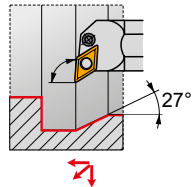

Product	DCOM MS	DMIN	WF	H	B	LF	LAMS	GAMO					
	[mm]	[mm]	[mm]	[mm]	[mm]	[mm]	[°]	[°]					
R	S25T-PDUNR 11-A	25	32	17	23	23	300	-12	-6	-	1.10	GI046	PD61
	S32U-PDUNR 11	32	40	22	30	30	350	-12	-6	-	2.10	GI046	PD60
	A32S-PDUNR 15	32	40	32	30	30	250	-12	-6	✓	1.47	GI097	PD33
	A40T-PDUNR 15	40	50	27	38	38	300	-12	-6	✓	2.40	GI097	PD30
	A50U-PDUNR 15	50	63	35	47	48.5	350	-12	-6	✓	4.95	GI097	PD30
	A60V-PDUNR 15	60	80	43	57	58.5	400	-12	-6	✓	8.22	GI097	PD30
L	S25T-PDUNL 11-A	25	32	17	23	23	300	-12	-6	-	1.11	GI046	PD61
	S32U-PDUNL 11	32	40	22	30	30	350	-12	-6	-	2.09	GI046	PD60
	A32S-PDUNL 15	32	40	32	30	30	250	-12	-6	✓	1.47	GI097	PD33
	A40T-PDUNL 15	40	50	27	38	38	300	-12	-6	✓	2.56	GI097	PD30
	A50U-PDUNL 15	50	63	35	47	48.5	350	-12	-6	✓	5.20	GI097	PD30
	A60V-PDUNL 15	60	80	43	57	58.5	400	-12	-6	✓	8.16	GI097	PD30



GI046
GI097

DN.. 1104..
DN.. 1504..



PD30	DNU 150308	PU 03	US 36	6.0	M 8x1	26	NT 05	MT 05	HXX 4
PD33	-	PU 03-A	US 41	6.0	M 8x1	17	NT 15	MT 05	HXX 4
PD60	PDN 110308	PU 3512	PS 0616	3.0	M 6	16	NT 5153	MT 0912	HXX 2.5
PD61	-	PU 3611-A	PS 0512-A	2.0	M 5	12	-	-	HXX 2



C-DDUN(RL) INT



PRAMET

D



Int. PSC Quick Change Tool, Double Clamp, 93° Cutting Angle for DN.. Insert

Internal Right/Left hand double clamp tool, through coolant, with 93° cutting angle for internal turning applications including copy turning up to 27° with DN.. 11 inserts, minimum internal diameter Ø32mm. PSC shank (Polygon Shank Coupling) size C4 with turning length of 68 mm. Body treated for longer tool life.

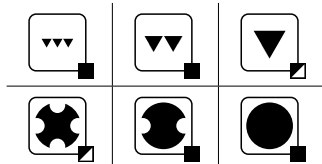
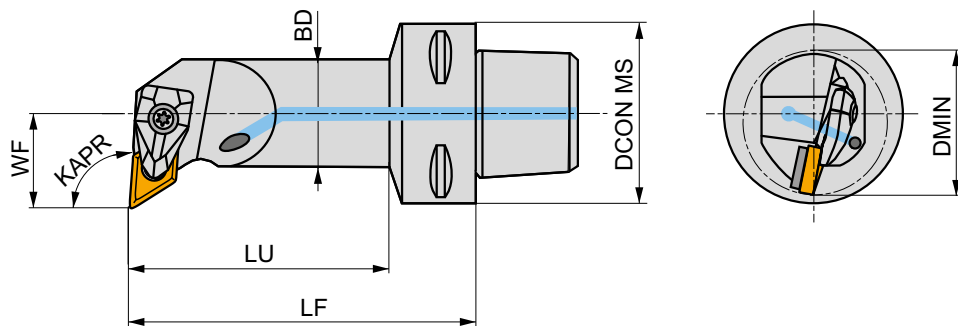
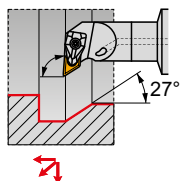

Product	DCON MS [mm]	DMIN [mm]	WF [mm]	LF [mm]	LU [mm]	BD [mm]	KAPR [°]	LAMS [°]	GAMO [°]				
R C4-DDUNR-17090-11	40	32	17	90	68	25	93	-12	-6	✓	0.51	GI046	DD11
L C4-DDUNL-17090-11	40	32	17	90	68	25	93	-12	-6	✓	0.51	GI046	DD11



GI046



DN.. 1104..



DD11



DCS 09



1.7



DDS 267-01



US 2004-T09P



FLAG T09P



KN

16

CARBIDE INSERTS

KNUX



284

MATCH THE RIGHT SIZE (example)

Insert

KNUX 160405L-22

Tool Holder

CKJNR 2020 K 16

ISO TURNING – EXTERNAL

CKJN(RL) EXT

93°

KN..

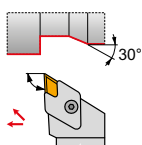

16

20×20
32×25

287

284 – 286



KNUX



	W1	L	S
	[mm]	[mm]	[mm]
1604	9.525	19.50	4.76

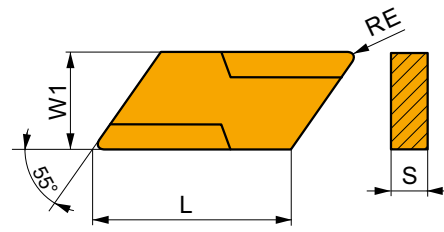

Suitability and starting values for cutting speed (vc), feed (f) and depth of cut (ap). Refer to our Machining Calculator app for further calculations.

Product	RE	P			M			K			N			S			H		
		vc	f	ap	vc	f	ap	vc	f	ap	vc	f	ap	vc	f	ap	vc	f	ap
	[mm]	[m/min]	[mm/rev]	[mm]	[m/min]	[mm/rev]	[mm]	[m/min]	[mm/rev]	[mm]	[m/min]	[mm/rev]	[mm]	[m/min]	[mm/rev]	[mm]	[m/min]	[mm/rev]	[mm]

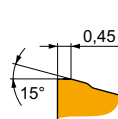

L-22 geometry with left-handed design for finish to semi-rough machining, and continuous cuts.

KNUX 160405L-22	T5315	0.5	✓	190	0.25	2.7	–	–	–	✓	180	0.25	2.7	–	–	–	–	–	–	–	
	T7325	0.5	✓	130	0.25	2.7	✓	100	0.25	2.7	–	–	–	–	–	–	–	–	–	–	
	T7335	0.5	✓	125	0.25	2.7	✓	95	0.25	2.7	–	–	–	–	–	–	–	–	–	–	
	T9325	0.5	■	155	0.25	2.7	✓	90	0.25	2.7	✓	145	0.25	2.7	–	–	–	–	–	–	–
	T9335	0.5	■	135	0.25	2.7	✓	80	0.25	2.7	–	–	–	–	–	–	–	–	–	–	–

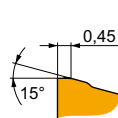

R-22 geometry with right-handed design for finish to semi-rough machining, and continuous cuts.

KNUX 160405R-22	T5315	0.5	✓	190	0.25	2.7	–	–	–	✓	180	0.25	2.7	–	–	–	–	–	–	–	
	T7325	0.5	✓	130	0.25	2.7	✓	100	0.25	2.7	–	–	–	–	–	–	–	–	–	–	
	T7335	0.5	✓	125	0.25	2.7	✓	95	0.25	2.7	–	–	–	–	–	–	–	–	–	–	
	T9325	0.5	■	155	0.25	2.7	✓	90	0.25	2.7	✓	145	0.25	2.7	–	–	–	–	–	–	–
	T9335	0.5	■	135	0.25	2.7	✓	80	0.25	2.7	–	–	–	–	–	–	–	–	–	–	–

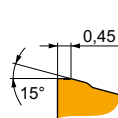

L-22 geometry with left-handed design for finish to semi-rough machining, and continuous cuts.

KNUX 160410L-22	T9335	1.0	■	155	0.32	2.7	✓	90	0.29	2.7	–	–	–	–	–	–	–	–	–	–
-----------------	-------	-----	---	-----	------	-----	---	----	------	-----	---	---	---	---	---	---	---	---	---	---

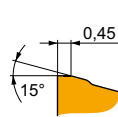

R-22 geometry with right-handed design for finish to semi-rough machining, and continuous cuts.

KNUX 160410R-22	T9335	1.0	■	155	0.32	2.7	✓	90	0.29	2.7	–	–	–	–	–	–	–	–	–	–
-----------------	-------	-----	---	-----	------	-----	---	----	------	-----	---	---	---	---	---	---	---	---	---	---

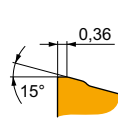









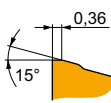



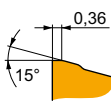



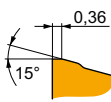



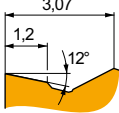



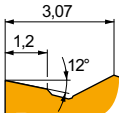



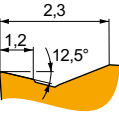

L-32 geometry with left-handed design for finish to semi-rough machining, and continuous cuts.

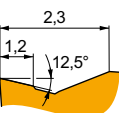
KNUX 160405L-32	T5315	0.5	✓	190	0.25	2.7	–	–	–	✓	180	0.25	2.7	–	–	–	–	–	–	–	
	T7325	0.5	✓	130	0.25	2.7	✓	100	0.25	2.7	–	–	–	–	–	–	–	–	–	–	
	T7335	0.5	✓	125	0.25	2.7	✓	95	0.25	2.7	–	–	–	–	–	–	–	–	–	–	
	T9325	0.5	■	155	0.25	2.7	✓	90	0.25	2.7	✓	145	0.25	2.7	–	–	–	–	–	–	–
	T9335	0.5	■	135	0.25	2.7	✓	80	0.25	2.7	–	–	–	–	–	–	–	–	–	–	–

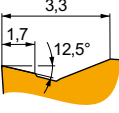

Suitability and starting values for cutting speed (vc), feed (f) and depth of cut (ap). Refer to our Machining Calculator app for further calculations.

Product	RE (mm)	P			M			K			N			S			H				
		vc	f	ap	vc	f	ap	vc	f	ap	vc	f	ap	vc	f	ap	vc	f	ap		
		[m/min]	[mm/rev]	[mm]	[m/min]	[mm/rev]	[mm]	[m/min]	[mm/rev]	[mm]	[m/min]	[mm/rev]	[mm]	[m/min]	[mm/rev]	[mm]	[m/min]	[mm/rev]	[mm]		
				R-32 geometry with right-handed design for finish to semi-rough machining, and continuous cuts.																	
KNUX 160405R-32	T5315	0.5	190	0.25	2.7	–	–	–	180	0.25	2.7	–	–	–	–	–	–	–	–		
	T7325	0.5	130	0.25	2.7	100	0.25	2.7	–	–	–	–	–	–	–	–	–	–	–		
	T7335	0.5	125	0.25	2.7	95	0.25	2.7	–	–	–	–	–	–	–	–	–	–	–		
	T9325	0.5	155	0.25	2.7	90	0.25	2.7	145	0.25	2.7	–	–	–	–	–	–	–	–		
	T9335	0.5	135	0.25	2.7	80	0.25	2.7	–	–	–	–	–	–	–	–	–	–	–		
				L-32 geometry with left-handed design for finish to semi-rough machining, and continuous cuts.																	
KNUX 160410L-32	T9325	1.0	175	0.32	2.7	105	0.29	2.7	165	0.32	2.7	–	–	–	–	–	–	–	–		
	T9335	1.0	155	0.32	2.7	90	0.29	2.7	–	–	–	–	–	–	–	–	–	–	–		
				R-32 geometry with right-handed design for finish to semi-rough machining, and continuous cuts.																	
KNUX 160410R-32	T9325	1.0	175	0.32	2.7	105	0.29	2.7	165	0.32	2.7	–	–	–	–	–	–	–	–		
	T9335	1.0	155	0.32	2.7	90	0.29	2.7	–	–	–	–	–	–	–	–	–	–	–		
				ER-72 geometry with right-handed design for fine to finish machining, and continuous cuts.																	
KNUX 160405ER-72	T5315	0.5	250	0.20	2.0	–	–	–	235	0.20	2.0	–	–	–	–	–	–	–	–		
	T9325	0.5	215	0.20	2.0	125	0.18	2.0	200	0.20	2.0	–	–	–	45	0.16	1.6	–	–		
	T9335	0.5	185	0.20	2.0	110	0.18	2.0	–	–	–	–	–	–	40	0.16	1.6	–	–		
				EL-72 geometry with left-handed design for fine to finish machining, and continuous cuts.																	
KNUX 160405EL-72	T5315	0.5	250	0.20	2.0	–	–	–	235	0.20	2.0	–	–	–	–	–	–	–	–		
	T9325	0.5	215	0.20	2.0	125	0.18	2.0	200	0.20	2.0	–	–	–	45	0.16	1.6	–	–		
	T9335	0.5	185	0.20	2.0	110	0.18	2.0	–	–	–	–	–	–	40	0.16	1.6	–	–		
				ER-73 geometry with right-handed design for finish to semi-rough machining, and continuous cuts.																	
KNUX 160405SR-73	6640	0.5	150	0.25	3.0	90	0.23	3.0	140	0.25	3.0	–	–	–	–	–	–	–	–		
KNUX 160410SR-73	6640	1.0	150	0.40	3.0	90	0.36	3.0	140	0.40	3.0	–	–	–	–	–	–	–	–		
	T5315	1.0	235	0.40	3.0	–	–	–	220	0.40	3.0	–	–	–	–	–	–	–	–		
				EL-73 geometry with left-handed design for finish to semi-rough machining, and continuous cuts.																	
KNUX 160405SL-73	6640	0.5	150	0.25	3.0	90	0.23	3.0	140	0.25	3.0	–	–	–	–	–	–	–	–		
KNUX 160410SL-73	6640	1.0	150	0.40	3.0	90	0.36	3.0	140	0.40	3.0	–	–	–	–	–	–	–	–		
				ER-74 geometry with right-handed design for finish to rough machining, and continuous cuts.																	
KNUX 160415SR-74	6640	1.5	155	0.45	3.0	90	0.41	3.0	145	0.45	3.0	–	–	–	–	–	–	–	–		



Suitability and starting values for cutting speed (vc), feed (f) and depth of cut (ap). Refer to our Machining Calculator app for further calculations.

Product	RE (mm)	P			M			K			N			S			H		
		vc [m/min]	f [mm/rev]	ap [mm]	vc [m/min]	f [mm/rev]	ap [mm]	vc [m/min]	f [mm/rev]	ap [mm]	vc [m/min]	f [mm/rev]	ap [mm]	vc [m/min]	f [mm/rev]	ap [mm]	vc [m/min]	f [mm/rev]	ap [mm]

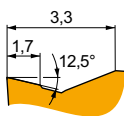

EL-74 geometry with left-handed design for finish to rough machining, and continuous cuts.

KNUX 160415SL-74	6640	1.5	■	155	0.45	3.0	☑	90	0.41	3.0	■	145	0.45	3.0	—	—	—	—	—	—
-------------------------	-------------	-----	---	-----	------	-----	---	----	------	-----	---	-----	------	-----	---	---	---	---	---	---



CKJN(RL) EXT

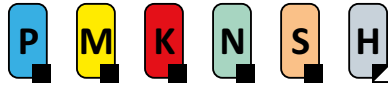

External Top Clamp Turning Holder with 93° Cutting Angle for KN.. 16 Insert

External Right/Left hand top clamp tool holder with 93° cutting angle. Suited for taper, longitudinal turning with shoulder, copy turning up to 30° and chamfering with negative KN.. 16 size inserts. Available in 20x20 up to 32x25 mm shanks. Body treated for longer tool life.

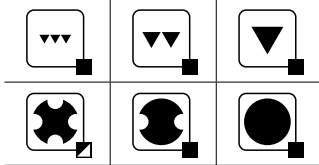
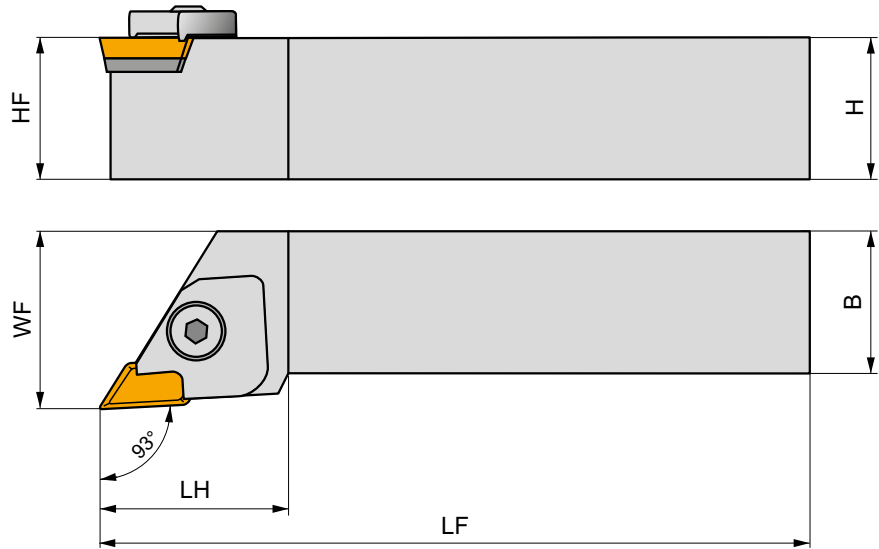
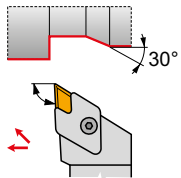

Product	H	B	HF	WF	LF	LH	LAMS	GAMO	kg	G1066	G1067	R1
	[mm]	[mm]	[mm]	[mm]	[mm]	[mm]	[°]	[°]				
R	CKJNR 2020 K 16	20	20	20	30	125	34	1	-5	0.43	G1066	R1
	CKJNR 2525 M 16	25	25	25	32	150	34	1	-5	0.70	G1066	R
	CKJNR 3225 P 16	32	25	32	32	170	34	1	-5	1.05	G1066	R
L	CKJNL 2020 K 16	20	20	20	30	125	34	1	-5	0.43	G1067	L1
	CKJNL 2525 M 16	25	25	25	32	150	34	1	-5	0.74	G1067	L
	CKJNL 3225 P 16	32	25	32	32	170	34	1	-5	1.06	G1067	L



G1066
G1067



KN.X 1604...R
KN.X 1604...L



L

KNN 190412L

NT 03

–

UP 26

US 83

6.0

PR 07

K 23

HXK 4

L1

KNN 190412L

NT 03

–

UP 26

US 83

6.0

PR 07

K 22

HXK 4

R

KNN 190412R

NT 03

UP 25

–

US 83

6.0

PR 07

K 23

HXK 4

R1

KNN 190412R

NT 03

UP 25

–

US 83

6.0

PR 07

K 22

HXK 4



LN

19/ 30/ 40/ 50

CARBIDE INSERTS

LNUX 40, LN.X 50

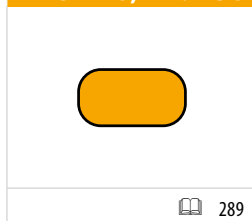

MATCH THE RIGHT SIZE (example)

Insert	Tool Holder
LNUX 40-1129003	KHP-LBNR 40-A

ISO TURNING – EXTERNAL

PLBN(RL) EXT

75°	LN..
	 40 50
60x60	
290	289

ISO TURNING – HEAVY ROUGHING – EXTERNAL

KHP-LBNR + DKH(RL)

75°	LN..
	 40
40x50 60x80	
291, 292	289

KHP-LBNL + DKH(RL)

75°	LN..
	 40
40x50 60x80	
291, 292	289







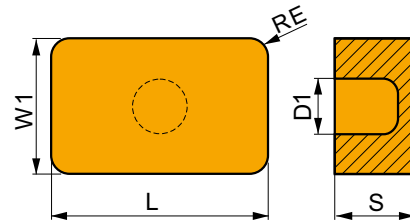

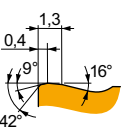

LNUX 40, LN.X 50

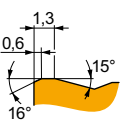
	W1 [mm]	D1 [mm]	L [mm]	S [mm]
40-1	25.200	9.30	40.00	14.00
50-1	25.400	9.30	50.80	14.00
50-2	25.400	6.45	50.80	14.00
5014	25.400	6.35	50.80	14.00

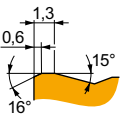

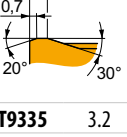
Suitability and starting values for cutting speed (vc), feed (f) and depth of cut (ap). Refer to our Machining Calculator app for further calculations.

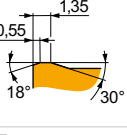
Product	RE [mm]	P			M			K			N			S			H		
		vc [m/min]	f [mm/rev]	ap [mm]	vc [m/min]	f [mm/rev]	ap [mm]	vc [m/min]	f [mm/rev]	ap [mm]	vc [m/min]	f [mm/rev]	ap [mm]	vc [m/min]	f [mm/rev]	ap [mm]	vc [m/min]	f [mm/rev]	ap [mm]
 LNUX 40-1129002 	3.2	45	1.35	25.0	–	–	–	40	1.35	25.0	–	–	–	–	–	–	–	–	–
	3.2	55	1.35	25.0	–	–	–	50	1.35	25.0	–	–	–	–	–	–	–	–	–
	3.2	40	1.35	25.0	–	–	–	–	–	–	–	–	–	–	–	–	–	–	–
 LNUX 40-1129003 	3.2	45	1.35	25.0	–	–	–	40	1.35	25.0	–	–	–	–	–	–	–	–	–
	3.2	55	1.35	25.0	–	–	–	50	1.35	25.0	–	–	–	–	–	–	–	–	–
	3.2	40	1.35	25.0	–	–	–	–	–	–	–	–	–	–	–	–	–	–	–
 LNUX 50-1275000 	3.2	45	1.35	25.0	–	–	–	40	1.35	25.0	–	–	–	–	–	–	–	–	–
	3.2	55	1.35	25.0	–	–	–	50	1.35	25.0	–	–	–	–	–	–	–	–	–
	3.2	40	1.35	25.0	–	–	–	–	–	–	–	–	–	–	–	–	–	–	–
 LNMX 501432E 	3.2	45	1.50	25.0	–	–	–	–	–	–	–	–	–	–	–	–	–	–	–
	3.2	55	1.50	25.0	–	–	–	–	–	–	–	–	–	–	–	–	–	–	–
 LNMX 50-2284000 	3.2	60	1.50	25.0	–	–	–	55	1.50	25.0	–	–	–	–	–	–	–	–	–
	3.2	55	1.50	25.0	–	–	–	–	–	–	–	–	–	–	–	–	–	–	–



PLBN(RL) EXT



PRAMET

P



External Lever Lock Heavy Turning Holder, 75° Cutting Angle for LNUX Insert

External Right/Left hand lever lock tool holder with 75° cutting angle for heavy turning. Suited for longitudinal turning without shoulder, taper and chamfer turning with negative LN.. 40 and 50 size inserts. Available in 60x60 mm shank. Body treated for longer tool life.

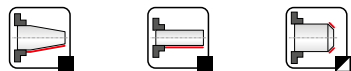
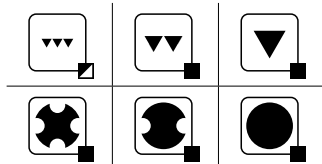
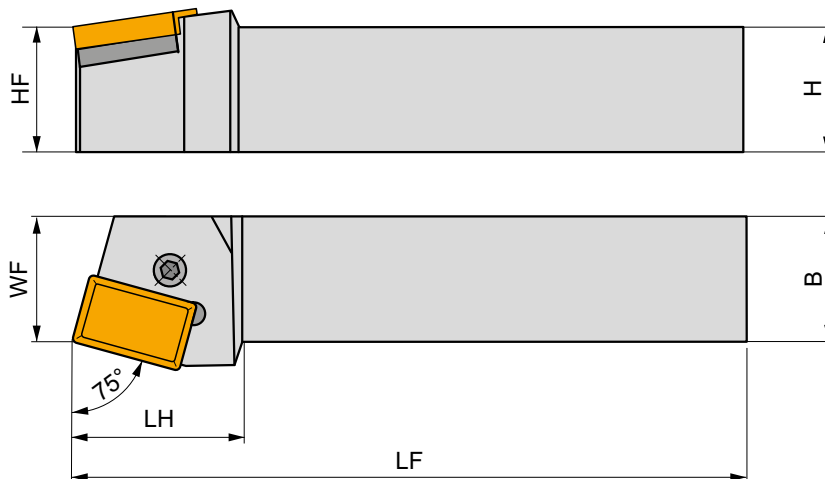
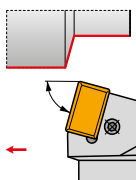

Product	H	B	HF	WF	LF	LH	LAMS	GAMO	kg		
	[mm]	[mm]	[mm]	[mm]	[mm]	[mm]	[°]	[°]			
R PLBNR 6060 V 40-A	60	60	60	60	400	64	-6	-6	13.00	GI102	PL71
PLBNR 6060 V 50	60	60	60	60	400	70	-6	-6	12.75	GI145	PL72
PLBNR 6060 V 50-2	60	60	60	60	400	70	-6	-6	11.60	GI291	PL73
L PLBNL 6060 V 40-A	60	60	60	60	400	64	-6	-6	11.14	GI102	PL71
PLBNL 6060 V 50	60	60	60	60	400	70	-6	-6	13.09	GI145	PL72

GI102		LNUX 40....
GI145		LNUX 50....
GI291		LNMX 50....

PL71	LNX 400632	PU 06	PS 12040	8.0	M 12x1	40	NT 08	MT 08	HXK 5	-	-
PL72	LNX 500632	PU 06	PS 12040	8.0	M 12x1	40	NT 08	MT 08	HXK 5	-	-
PL73	LNX 500432P	-	-	-	-	-	-	-	-	UP 1515A-T15P	SDRT15P



KHP-LBN(RL)



Modular KHP Lever Lock Turning Cartridge, 75° Cutting Angle for LNUX Inserts

Dovetailed Right/Left hand lever lock turning cartridge, 75° Cutting Angle, for mounting on DKH tool holder shank. Suited for heavy longitudinal turning without shoulder, taper and chamfer turning with negative LNUX 40 inserts. Tool holder treated for longer tool life.

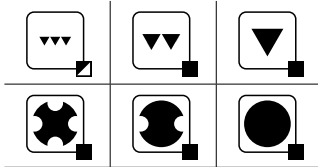
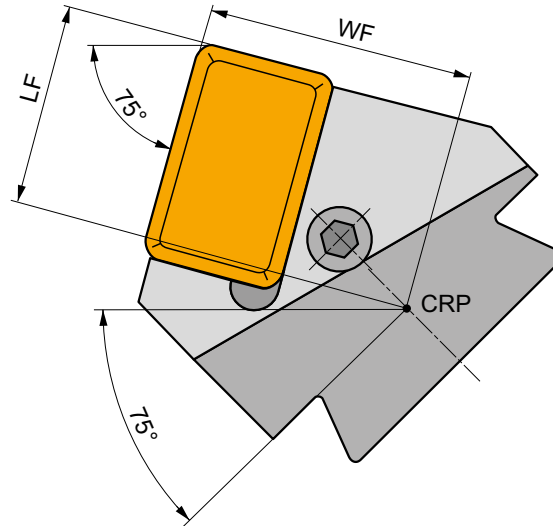
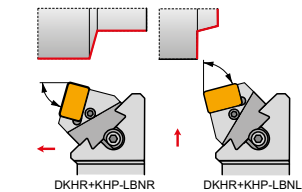

Product	WF	LF	LAMS	GAMO	kg		
	[mm]	[mm]	[°]	[°]			
L KHP-LBNR 40-A	48	36	-6	-6	1.50	GI102	PL71
KHP-LBNL 40-A	48	36	-6	-6	1.47	GI102	PL71

GI102	LNUX 40....

PL71	LNK 400632	PU 06	PS 12040	8.0	M 12x1	40	NT 08	MT 08	HXK 5



DKH(RL)



External Tool Holder Shank for KHP/KHS Heavy Turning Cartridges

Dovetailed Right/Left hand modular tool shank for KHP/KHS cartridges. Suited for heavy turning applications. Available with shank size 40x50 up to 60x80 mm. Body treated for longer tool life.

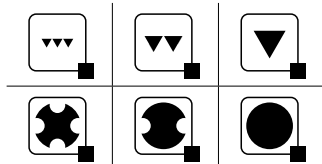
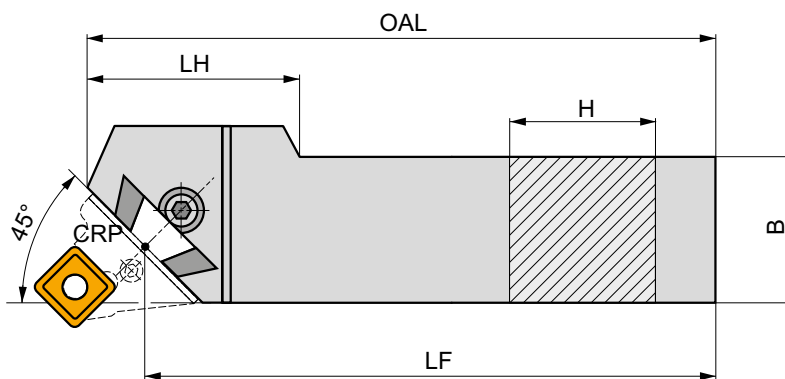
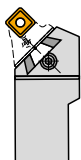

	Product	H	B	LF	OAL	LH	kg		
		[mm]	[mm]	[mm]	[mm]	[mm]			
R	DKHR 4050 V	40	50	400	425	100	7.10	GI098	DKH10
	DKHR 5060 W	50	60	450	475	110	11.30	GI098	DKH10
	DKHR 6080 W-A	60	80	450	485	90	19.65	GI098	DKH10
L	DKHL 4050 V	40	50	400	425	100	7.10	GI098	DKH10
	DKHL 5060 W	50	60	450	475	110	11.30	GI098	DKH10
	DKHL 6080 W-A	60	80	450	485	90	19.28	GI098	DKH10

GI098	KHP	KHS

DKH10	SR 14	HXK 10



RN

09/ 12/ 15/ 19/ 25

CARBIDE INSERTS

RNMG



294

CER INSERTS

RNGN CER



294

MATCH THE RIGHT SIZE (example)

Insert

RNMG 120400E-08

Tool Holder

DRSNR 2525 M 12

ISO TURNING – EXTERNAL

DRSN(RL) EXT

RN..



12

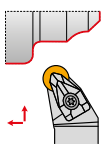

25×25



295



294

PRSN(RL) EXT

RN..



12

15

19

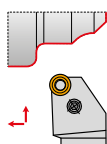

25×25
40×40



296



294

C.-DRSN(RL) EXT

RN..



12

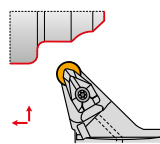

C6



297



294



RNMG

	INSD	D1	S
	[mm]	[mm]	[mm]
1204	12.700	5.16	4.76
1506	15.875	6.35	6.35
1906	19.050	7.94	6.35
2509	25.400	9.12	9.53

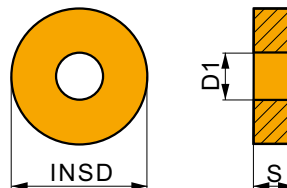

Suitability and starting values for cutting speed (vc), feed (f) and depth of cut (ap). Refer to our Machining Calculator app for further calculations.

Product	RE	P			M			K			N			S			H		
		vc	f	ap	vc	f	ap	vc	f	ap	vc	f	ap	vc	f	ap	vc	f	ap
	[mm]	[m/min]	[mm/rev]	[mm]	[m/min]	[mm/rev]	[mm]	[m/min]	[mm/rev]	[mm]	[m/min]	[mm/rev]	[mm]	[m/min]	[mm/rev]	[mm]	[m/min]	[mm/rev]	[mm]

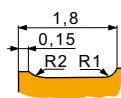

Geometry 08 for semi-rough to heavy-rough machining, and continuous to interrupted cuts.

RNMG 120400E-08	T5305	–	✓	195	0.70	3.0	–	–	–	✓	185	0.70	3.0	–	–	–	–	–	–	✓	35	0.15	1.0	
	T9315	–	✓	150	0.70	3.0	–	–	–	✓	140	0.70	3.0	–	–	–	–	–	–	✓	30	0.15	1.0	
	T9325	–	✓	135	0.70	3.0	–	–	–	✓	125	0.70	3.0	–	–	–	–	–	–	–	–	–	–	
RNMG 150600E-08	T5305	–	✓	295	0.70	3.0	–	–	–	✓	280	0.70	3.0	–	–	–	–	–	–	–	✓	55	0.15	1.0
	T9315	–	✓	225	0.70	3.0	–	–	–	✓	210	0.70	3.0	–	–	–	–	–	–	–	✓	45	0.15	1.0
	T9325	–	✓	205	0.70	3.0	–	–	–	✓	190	0.70	3.0	–	–	–	–	–	–	–	–	–	–	
RNMG 190600E-08	T9315	–	✓	150	0.70	3.0	–	–	–	✓	140	0.70	3.0	–	–	–	–	–	–	–	✓	30	0.15	1.0
	T9325	–	✓	135	0.70	3.0	–	–	–	✓	125	0.70	3.0	–	–	–	–	–	–	–	–	–	–	

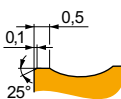

Geometry 081 for rough to heavy-rough machining, and continuous to interrupted cuts.

RNMG 250900E-081	T9315	–	✓	145	0.90	5.0	–	–	–	✓	135	0.90	5.0	–	–	–	–	–	–	–	✓	25	0.15	1.0
	T9325	–	✓	130	0.90	5.0	–	–	–	✓	120	0.90	5.0	–	–	–	–	–	–	–	–	–	–	

RNGN CER

	INSD	S
	[mm]	[mm]
0903	9.525	3.18
1204	12.700	4.76
1207	12.700	7.94

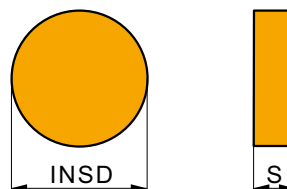

Suitability and starting values for cutting speed (vc), feed (f) and depth of cut (ap). Refer to our Machining Calculator app for further calculations.

Product	RE	P			M			K			N			S			H		
		vc	f	ap	vc	f	ap	vc	f	ap	vc	f	ap	vc	f	ap	vc	f	ap
	[mm]	[m/min]	[mm/rev]	[mm]	[m/min]	[mm/rev]	[mm]	[m/min]	[mm/rev]	[mm]	[m/min]	[mm/rev]	[mm]	[m/min]	[mm/rev]	[mm]	[m/min]	[mm/rev]	[mm]

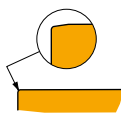
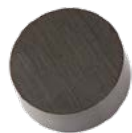

For machining with high speeds and continuous cuts.

RNGN 090300 T01020	TC100	–	–	–	–	–	–	–	–	–	–	–	–	–	–	–	–	–	–	–	–	–	–
RNGN 120400 T01020	TC100	–	–	–	–	–	–	–	–	–	–	–	–	–	–	–	–	–	–	–	–	–	–
RNGN 120700 T01020	TC100	–	–	–	–	–	–	–	–	–	–	–	–	–	–	–	–	–	–	–	–	–	–
RNGN 120700 T15015	TC100	–	–	–	–	–	–	–	–	–	–	–	–	–	–	–	–	–	–	–	–	–	–

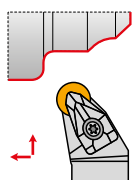

DRSN(RL) EXT

External Double Clamp Holder for RN.. Insert

External Right/Left hand double clamp tool holder. Suited for longitudinal turning without shoulder, copy turning, taper and chamfer turning with negative round RN.. 12 size inserts. Available in 25x25 mm shank. Body treated for longer tool life.

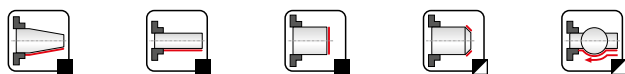
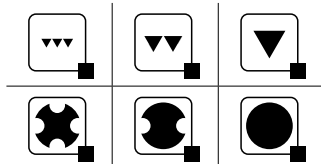
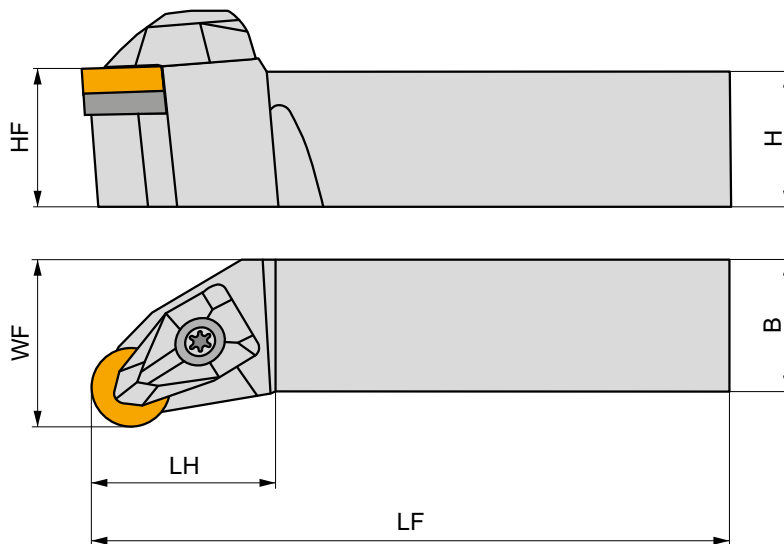

Product	H	B	HF	WF	LF	LH	LAMS	GAMO	kg		
	[mm]	[mm]	[mm]	[mm]	[mm]	[mm]	[°]	[°]			
R DRSNR 2525 M 12	25	25	25	32	150	31.6	-6	-6	0.74	G1083	DR12
L DRSNL 2525 M 12	25	25	25	32	150	31.6	-6	-6	0.75	G1083	DR12



G1083



RN.. 120400



DR12



DCS 12



3.9



DRS 155-02



US 2002-T15P



FLAG T15P/3,5



PRSN(RL) EXT



External Lever Lock Holder for RN.. Insert

External Right/Left hand lever lock tool holder. Suited for longitudinal turning, copy turning up to 90°, taper and chamfer turning with negative round RN.. 12, 15 and 19 size inserts. Available in 25x25 up to 40x40 mm shank. Body treated for longer tool life.

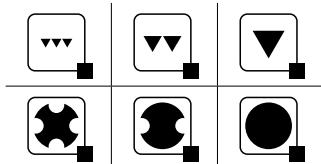
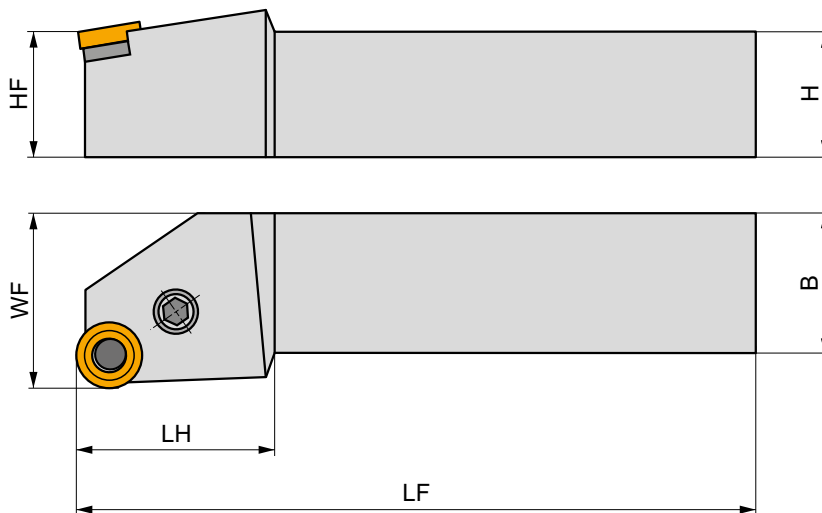
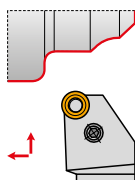

Product	H	B	HF	WF	LF	LH	LAMS	GAMO	kg		
	[mm]	[mm]	[mm]	[mm]	[mm]	[mm]	[°]	[°]			
R PRSNR 2525 M 12	25	25	25	32	150	32	-6	-6	0.68	G1083	PR20
PRSNR 3232 P 15	32	32	32	40	170	38	-6	-6	1.40	G1105	PR40
PRSNR 4040 R 19	40	40	40	50	200	40	-6	-6	2.49	G1106	PR50
L PRSNL 2525 M 12	25	25	25	32	150	32	-6	-6	0.74	G1083	PR20
PRSNL 3232 P 15	32	32	32	40	170	38	-6	-6	1.40	G1105	PR40
PRSNL 4040 R 19	40	40	40	50	200	40	-6	-6	2.48	G1106	PR50

G1083	RN.. 120400
G1105	RN.. 150600
G1106	RN.. 190600

PR20	RNU 120300	PU 02	US 35	6.0	M 8x1	22.5	NT 05	MT 05	HXK 4
PR40	RNU 150300	PU 04	US 36	6.0	M 8x1	26	NT 07	MT 07	HXK 4
PR50	RNU 190400	PU 05	US 38	8.0	M 10x1	29	NT 06	MT 06	HXK 5



C.-DRSN(RL) EXT



External PSC Quick Change Tool, Double Clamp for RN.. Insert

External Right/Left hand double clamp tool, through coolant, for longitudinal turning without shoulder, copy turning, taper and chamfer turning with negative round RN.. 12 size inserts. Available with PSC (Polygon Shank Coupling) C6 shank. Body treated for longer tool life.

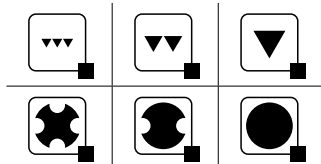
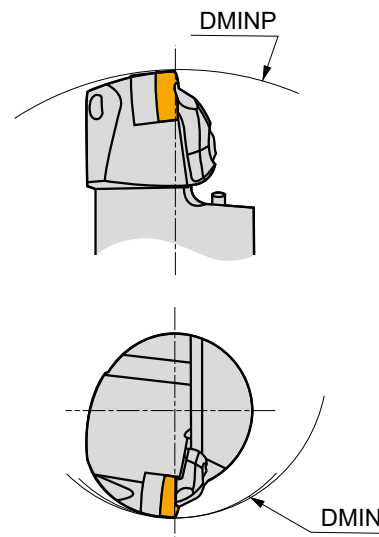
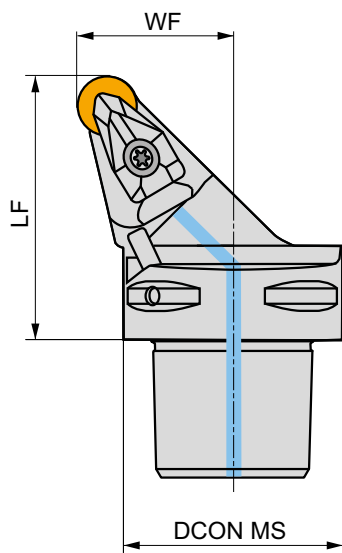
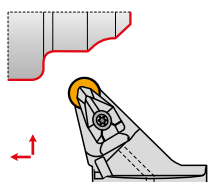

Product	DCON MS [mm]	DMIN [mm]	DMINP [mm]	WF [mm]	LF [mm]	LAMS [°]	GAMO [°]					
R C6-DRSNR-45065-12	63	110	190	45	65	-6	-6	✓	1.11	G1083	C-DR12	-
L C6-DRSNL-45065-12	63	110	190	45	65	-6	-6	✓	1.10	G1083	C-DR12	-



G1083



RN.. 120400



C-DR12



DCS 12



3.9



DRS 155-02



US 2002-T15P



FLAG T15P/3,5



CN 045-01



SN

09/ 12/ 15/ 19/ 25

CARBIDE INSERTS

SNMA	SNMG	SNMM	SNMX
300	301	307	311

CER INSERTS

SNGA CER	SNGN CER
311	312

MATCH THE RIGHT SIZE (example)

Insert	Tool Holder
SNMG 190616E-RM	DSDNN 3232 P 19

ISO TURNING – EXTERNAL

<p>DSBN(RL) EXT</p> <p>75°</p> <p>SN..</p> <p>12 15 19</p> <p>20×20 40×40</p> <p> 313 300 – 312</p>	<p>DSDNN EXT</p> <p>45°</p> <p>SN..</p> <p>12 15 19 25</p> <p>20×20 40×40</p> <p> 315 300 – 312</p>	<p>DSKN(RL) EXT</p> <p>75°</p> <p>SN..</p> <p>12 19</p> <p>25×25 32×32</p> <p> 316 300 – 312</p>	<p>DSSN(RL) EXT</p> <p>45°</p> <p>SN..</p> <p>12 15 19</p> <p>20×20 40×40</p> <p> 317 300 – 312</p>
<p>PSBN(RL) EXT</p> <p>75°</p> <p>SN..</p> <p>12 15 19 25</p> <p>20×20 50×50</p> <p> 318 300 – 312</p>	<p>PSDNN EXT</p> <p>45°</p> <p>SN..</p> <p>12 15 19 25</p> <p>20×20 50×50</p> <p> 320 300 – 312</p>	<p>PSKN(RL) EXT</p> <p>75°</p> <p>SN..</p> <p>12 15 19 25</p> <p>20×20 50×50</p> <p> 321 300 – 312</p>	<p>PSSN(RL) EXT</p> <p>45°</p> <p>SN..</p> <p>19 25</p> <p>40×40 50×50</p> <p> 323 300 – 312</p>



SN

09/ 12/ 15/ 19/ 25

C.-DSDNN EXT

45°

SN..

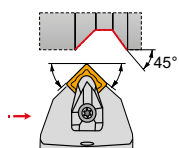
12
19C4
C6

324



300 – 312

C.-DSKN(RL) EXT

75°

SN..



12

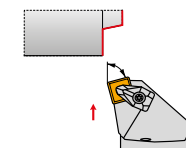

C4



325



300 – 312

C.-DSRN(RL) EXT

75°

SN..

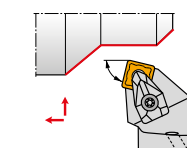
12
19C4
C6

326



300 – 312

C.-DSSN(RL) EXT

45°

SN..

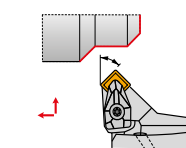

12

C4
C5

327



300 – 312

ISO TURNING – HEAVY ROUGHING – EXTERNAL

KHP-SBNR + DKH(RL)

75°

SN..



25

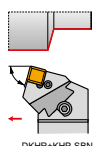

DKHR+KHP-SBNF

40×50
60×80

328, 330



300 – 312

KHP-SBNL + DKH(RL)

75°

SN..



25

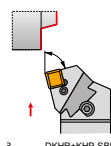

DKHR+KHP-SBNL

40×50
60×80

328, 330



300 – 312

KHP-SSNR/L + DKH(RL)

45°

SN..

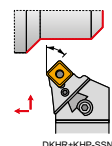
19
25

DKHR+KHP-SSNR

40×50
60×80

329, 330



300 – 312

ISO TURNING – INTERNAL

PSKN(RL) INT

93°

SN..

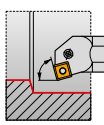
11
1532
80

331



300 – 312



SNMA

	IC	D1	L	S
	[mm]	[mm]	[mm]	[mm]
1204	12.700	5.16	12.70	4.76
1506	15.875	6.35	15.875	6.35
1906	19.050	7.94	19.05	6.35
2507	25.400	9.12	25.40	7.94
2509	25.400	9.12	25.40	9.525

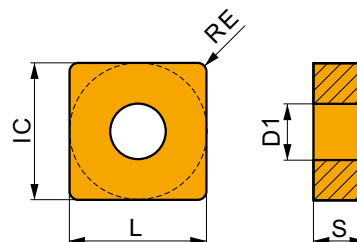

Suitability and starting values for cutting speed (vc), feed (f) and depth of cut (ap). Refer to our Machining Calculator app for further calculations.

Product	RE	P			M			K			N			S			H		
		vc	f	ap	vc	f	ap	vc	f	ap	vc	f	ap	vc	f	ap	vc	f	ap
	[mm]	[m/min]	[mm/rev]	[mm]	[m/min]	[mm/rev]	[mm]	[m/min]	[mm/rev]	[mm]	[m/min]	[mm/rev]	[mm]	[m/min]	[mm/rev]	[mm]	[m/min]	[mm/rev]	[mm]

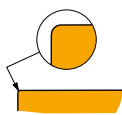

For fine-finish to semi-rough machining, and continuous to slightly interrupted cuts.

SNMA 120408	T5305	0.8	–	–	–	–	–	–	–	230	0.20	4.0	–	–	–	–	–	–	–	45	0.15	1.0
	T5315	0.8	–	–	–	–	–	–	–	200	0.20	4.0	–	–	–	–	–	–	–	40	0.15	1.0
	T6310	0.8	–	–	–	–	–	–	–	100	0.20	4.0	–	–	–	–	–	–	–	25	0.15	1.0
SNMA 120412	T5305	1.2	–	–	–	–	–	–	–	205	0.30	4.0	–	–	–	–	–	–	–	40	0.15	1.0
	T5315	1.2	–	–	–	–	–	–	–	190	0.30	4.0	–	–	–	–	–	–	–	40	0.15	1.0
SNMA 150612	T5305	1.2	–	–	–	–	–	–	–	200	0.30	5.0	–	–	–	–	–	–	–	40	0.15	1.0
	T5315	1.2	–	–	–	–	–	–	–	185	0.30	5.0	–	–	–	–	–	–	–	35	0.15	1.0
SNMA 190612	T5305	1.2	–	–	–	–	–	–	–	195	0.30	6.0	–	–	–	–	–	–	–	40	0.15	1.0
	T5315	1.2	–	–	–	–	–	–	–	180	0.30	6.0	–	–	–	–	–	–	–	35	0.15	1.0
SNMA 190616	T5305	1.6	–	–	–	–	–	–	–	190	0.40	6.0	–	–	–	–	–	–	–	40	0.15	1.0
	T5315	1.6	–	–	–	–	–	–	–	170	0.40	6.0	–	–	–	–	–	–	–	35	0.15	1.0
SNMA 250724	T5305	2.4	–	–	–	–	–	–	–	95	0.60	8.0	–	–	–	–	–	–	–	20	0.15	1.0
	T5315	2.4	–	–	–	–	–	–	–	90	0.60	8.0	–	–	–	–	–	–	–	15	0.15	1.0
SNMA 250924	T5305	2.4	–	–	–	–	–	–	–	95	0.60	8.0	–	–	–	–	–	–	–	20	0.15	1.0
	T5315	2.4	–	–	–	–	–	–	–	90	0.60	8.0	–	–	–	–	–	–	–	15	0.15	1.0

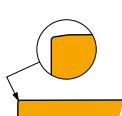

For fine-finish to semi-rough machining, and continuous to slightly interrupted cuts.

SNMA 120412S	T5305	1.2	–	–	–	–	–	–	–	205	0.30	4.0	–	–	–	–	–	–	–	40	0.15	1.0
SNMA 190616S	T5305	1.6	–	–	–	–	–	–	–	195	0.30	6.0	–	–	–	–	–	–	–	40	0.15	1.0
SNMA 250724S	T5305	2.4	–	–	–	–	–	–	–	95	0.60	8.0	–	–	–	–	–	–	–	20	0.15	1.0
SNMA 250924S	T5305	2.4	–	–	–	–	–	–	–	95	0.60	8.0	–	–	–	–	–	–	–	20	0.15	1.0



SNMG

	IC	D1	L	S
	[mm]	[mm]	[mm]	[mm]
1204	12.700	5.16	12.70	4.76
1506	15.875	6.35	15.875	6.35
1906	19.050	7.94	19.05	6.35
2507	25.400	9.12	25.40	7.94
2509	25.400	9.12	25.40	9.525

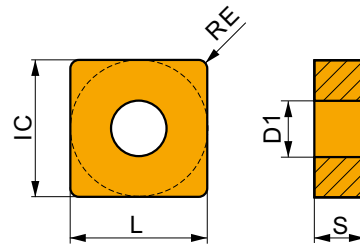

Suitability and starting values for cutting speed (vc), feed (f) and depth of cut (ap). Refer to our Machining Calculator app for further calculations.

Product	RE	P			M			K			N			S			H		
		vc	f	ap	vc	f	ap	vc	f	ap	vc	f	ap	vc	f	ap	vc	f	ap
	[mm]	[m/min]	[mm/rev]	[mm]	[m/min]	[mm/rev]	[mm]	[m/min]	[mm/rev]	[mm]	[m/min]	[mm/rev]	[mm]	[m/min]	[mm/rev]	[mm]	[m/min]	[mm/rev]	[mm]

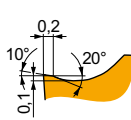

FM geometry with positive design for finish to semi-rough machining, and continuous to slightly interrupted cuts.

SNMG 120404E-FM	T6310	0.4	175	0.20	2.1	125	0.18	2.1	140	0.20	2.1	-	-	-	50	0.14	1.7	-	-	-	
	T7325	0.4	195	0.20	2.1	150	0.18	2.1	-	-	-	-	-	-	60	0.16	1.7	-	-	-	
	T8315	0.4	180	0.20	2.1	105	0.18	2.1	170	0.20	2.1	-	-	-	45	0.14	1.7	-	-	-	
	T8330	0.4	175	0.20	2.1	105	0.18	2.1	165	0.20	2.1	-	-	-	40	0.14	1.7	-	-	-	
	T8430	0.4	195	0.20	2.1	105	0.18	2.1	160	0.20	2.1	-	-	-	40	0.14	1.7	-	-	-	
	T9315	0.4	270	0.20	2.1	-	-	-	255	0.20	2.1	-	-	-	-	-	-	-	-	-	-
SNMG 120408E-FM	T9325	0.4	240	0.20	2.1	140	0.18	2.1	225	0.20	2.1	-	-	-	50	0.16	1.7	-	-	-	
	T7325	0.8	235	0.20	2.1	180	0.18	2.1	-	-	-	-	-	-	75	0.16	1.7	-	-	-	
	T8315	0.8	215	0.20	2.1	125	0.18	2.1	200	0.20	2.1	-	-	-	50	0.16	1.7	-	-	-	
	T8330	0.8	205	0.20	2.1	120	0.18	2.1	190	0.20	2.1	-	-	-	50	0.16	1.7	-	-	-	
	T8430	0.8	235	0.20	2.1	125	0.18	2.1	190	0.20	2.1	-	-	-	50	0.16	1.7	-	-	-	
	T9310	0.8	355	0.20	2.1	-	-	-	335	0.20	2.1	-	-	-	-	-	-	-	-	-	-
SNMG 120412E-FM	T9315	0.8	320	0.20	2.1	-	-	-	300	0.20	2.1	-	-	-	-	-	-	-	-	-	-
	T9325	0.8	290	0.20	2.1	170	0.18	2.1	275	0.20	2.1	-	-	-	65	0.16	1.7	-	-	-	
	T8330	1.2	200	0.27	2.1	120	0.24	2.1	190	0.27	2.1	-	-	-	50	0.19	1.7	-	-	-	
	T8430	1.2	220	0.27	2.1	120	0.24	2.1	180	0.27	2.1	-	-	-	45	0.19	1.7	-	-	-	
SNMG 120416E-FM	T9315	1.2	300	0.27	2.1	-	-	-	285	0.27	2.1	-	-	-	-	-	-	-	-	-	
	T9325	1.2	270	0.27	2.1	160	0.24	2.1	255	0.27	2.1	-	-	-	60	0.19	1.7	-	-	-	
	T8330	1.6	200	0.32	2.1	120	0.29	2.1	190	0.32	2.1	-	-	-	50	0.22	1.7	-	-	-	
SNMG 120416E-FM	T8430	1.6	220	0.32	2.1	120	0.29	2.1	180	0.32	2.1	-	-	-	45	0.22	1.7	-	-	-	
	T9325	1.6	260	0.32	2.1	155	0.29	2.1	245	0.32	2.1	-	-	-	55	0.22	1.7	-	-	-	

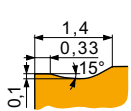

KR geometry for semi-rough to rough machining, and continuous to interrupted cuts.

SNMG 120408E-KR	T5305	0.8	265	0.35	3.8	-	-	-	250	0.35	3.8	-	-	-	50	0.15	1.0	-	-	-
	T5315	0.8	235	0.35	3.8	-	-	-	220	0.35	3.8	-	-	-	45	0.15	1.0	-	-	-
SNMG 120412E-KR	T5305	1.2	265	0.40	3.8	-	-	-	250	0.40	3.8	-	-	-	50	0.15	1.0	-	-	-
	T5315	1.2	240	0.40	3.8	-	-	-	225	0.40	3.8	-	-	-	45	0.15	1.0	-	-	-

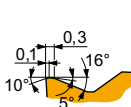

M geometry for finish to semi-rough machining, and continuous to interrupted cuts.

SNMG 120408E-M	T5305	0.8	290	0.32	2.1	-	-	-	275	0.32	2.1	-	-	-	55	0.15	1.0	-	-	-
	T5315	0.8	260	0.32	2.1	-	-	-	245	0.32	2.1	-	-	-	50	0.15	1.0	-	-	-
	T9310	0.8	255	0.32	2.1	-	-	-	240	0.32	2.1	-	-	-	50	0.15	1.0	-	-	-
	T9315	0.8	235	0.32	2.1	-	-	-	220	0.32	2.1	-	-	-	45	0.15	1.0	-	-	-
	T9325	0.8	210	0.32	2.1	-	-	-	195	0.32	2.1	-	-	-	-	-	-	-	-	-
	T9335	0.8	185	0.32	2.1	-	-	-	-	-	-	-	-	-	-	-	-	-	-	-



Suitability and starting values for cutting speed (vc), feed (f) and depth of cut (ap). Refer to our Machining Calculator app for further calculations.

Product	RE (mm)	P			M			K			N			S			H		
		vc [m/min]	f [mm/rev]	ap [mm]	vc [m/min]	f [mm/rev]	ap [mm]	vc [m/min]	f [mm/rev]	ap [mm]	vc [m/min]	f [mm/rev]	ap [mm]	vc [m/min]	f [mm/rev]	ap [mm]	vc [m/min]	f [mm/rev]	ap [mm]

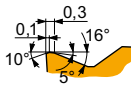

M geometry for finish to semi-rough machining, and continuous to interrupted cuts.

SNMG 120412E-M	T9315	1.2	230	0.40	2.1	—	—	—	215	0.40	2.1	—	—	—	—	—	—	45	0.15	1.0
	T9325	1.2	200	0.40	2.1	—	—	—	190	0.40	2.1	—	—	—	—	—	—	—	—	—
	T9335	1.2	175	0.40	2.1	—	—	—	—	—	—	—	—	—	—	—	—	—	—	—
SNMG 120416E-M	T9325	1.6	210	0.40	2.1	—	—	—	195	0.40	2.1	—	—	—	—	—	—	—	—	—
SNMG 150612E-M	T9315	1.2	220	0.40	3.4	—	—	—	205	0.40	3.4	—	—	—	—	—	—	40	0.15	1.0
	T9325	1.2	195	0.40	3.4	—	—	—	185	0.40	3.4	—	—	—	—	—	—	—	—	—
	T9335	1.2	170	0.40	3.4	—	—	—	—	—	—	—	—	—	—	—	—	—	—	—
SNMG 190612E-M	T9315	1.2	215	0.40	4.0	—	—	—	200	0.40	4.0	—	—	—	—	—	—	40	0.15	1.0
	T9325	1.2	190	0.40	4.0	—	—	—	180	0.40	4.0	—	—	—	—	—	—	—	—	—
	T9335	1.2	165	0.40	4.0	—	—	—	—	—	—	—	—	—	—	—	—	—	—	—
SNMG 190616E-M	T9315	1.6	225	0.40	4.0	—	—	—	210	0.40	4.0	—	—	—	—	—	—	45	0.15	1.0
	T9325	1.6	200	0.40	4.0	—	—	—	190	0.40	4.0	—	—	—	—	—	—	—	—	—
	T9335	1.6	175	0.40	4.0	—	—	—	—	—	—	—	—	—	—	—	—	—	—	—

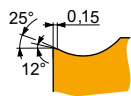

NF geometry with highly positive design for fine-finish to medium machining, and continuous cuts.

SNMG 120404E-NF	T6310	0.4	185	0.17	1.7	130	0.15	1.7	145	0.17	1.7	555	0.20	1.7	55	0.14	1.4	—	—	—
	T7325	0.4	210	0.18	1.7	160	0.16	1.7	—	—	—	—	—	—	65	0.16	1.4	—	—	—
	T7335	0.4	205	0.18	1.7	155	0.16	1.7	—	—	—	—	—	—	65	0.16	1.4	—	—	—
	T8330	0.4	185	0.17	1.7	110	0.15	1.7	175	0.17	1.7	555	0.20	1.7	45	0.14	1.4	—	—	—
	T8430	0.4	210	0.17	1.7	115	0.15	1.7	175	0.17	1.7	585	0.20	1.7	45	0.14	1.4	—	—	—
	T9315	0.4	300	0.17	1.7	—	—	—	285	0.17	1.7	—	—	—	—	—	—	—	—	—
	T9325	0.4	260	0.18	1.7	155	0.16	1.7	245	0.18	1.7	—	—	—	55	0.16	1.4	—	—	—
	T9335	0.4	240	0.18	1.7	145	0.16	1.7	235	0.18	1.7	—	—	—	55	0.16	1.4	—	—	—
SNMG 120408E-NF	HF7	0.8	—	—	—	120	0.17	1.7	190	0.19	1.7	600	0.23	1.7	—	—	—	—	—	—
	T6310	0.8	210	0.19	1.7	150	0.17	1.7	165	0.19	1.7	630	0.23	1.7	60	0.15	1.4	—	—	—
	T7325	0.8	245	0.19	1.7	190	0.17	1.7	—	—	—	—	—	—	75	0.15	1.4	—	—	—
	T7335	0.8	240	0.19	1.7	185	0.17	1.7	—	—	—	—	—	—	75	0.15	1.4	—	—	—
	T8315	0.8	230	0.19	1.7	135	0.17	1.7	215	0.19	1.7	690	0.23	1.7	55	0.15	1.4	—	—	—
	T8330	0.8	210	0.19	1.7	125	0.17	1.7	195	0.19	1.7	630	0.23	1.7	50	0.15	1.4	—	—	—
	T8430	0.8	250	0.19	1.7	135	0.17	1.7	205	0.19	1.7	690	0.23	1.7	50	0.15	1.4	—	—	—
	T9315	0.8	340	0.19	1.7	—	—	—	320	0.19	1.7	—	—	—	—	—	—	—	—	—
	T9325	0.8	300	0.19	1.7	180	0.17	1.7	285	0.19	1.7	—	—	—	65	0.15	1.4	—	—	—

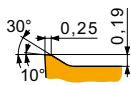

NM geometry with highly positive design for fine-finish, medium and rough machining, in continuous cuts.

SNMG 120408E-NM	T7325	0.8	225	0.25	2.1	175	0.23	2.1	—	—	—	—	—	70	0.20	1.7	—	—	—	
	T7335	0.8	220	0.25	2.1	170	0.23	2.1	—	—	—	—	—	70	0.20	1.7	—	—	—	
	T8315	0.8	215	0.25	2.1	125	0.23	2.1	—	—	—	645	0.30	2.1	50	0.20	1.7	—	—	—
	T8330	0.8	205	0.25	2.1	120	0.23	2.1	—	—	—	615	0.30	2.1	50	0.20	1.7	—	—	—
	T8430	0.8	225	0.25	2.1	120	0.23	2.1	—	—	—	615	0.30	2.1	45	0.20	1.7	—	—	—
	T9325	0.8	275	0.25	2.1	165	0.23	2.1	—	—	—	—	—	60	0.20	1.7	—	—	—	
SNMG 120412E-NM	T7325	1.2	225	0.30	2.1	175	0.27	2.1	—	—	—	—	—	70	0.24	1.7	—	—	—	
	T7335	1.2	220	0.30	2.1	170	0.27	2.1	—	—	—	—	—	70	0.24	1.7	—	—	—	
	T8315	1.2	215	0.30	2.1	125	0.27	2.1	—	—	—	645	0.36	2.1	50	0.24	1.7	—	—	—
	T9325	1.2	270	0.30	2.1	160	0.27	2.1	—	—	—	—	—	60	0.24	1.7	—	—	—	



Suitability and starting values for cutting speed (vc), feed (f) and depth of cut (ap). Refer to our Machining Calculator app for further calculations.

Product	RE [mm]	P			M			K			N			S			H		
		vc [m/min]	f [mm/rev]	ap [mm]	vc [m/min]	f [mm/rev]	ap [mm]	vc [m/min]	f [mm/rev]	ap [mm]	vc [m/min]	f [mm/rev]	ap [mm]	vc [m/min]	f [mm/rev]	ap [mm]	vc [m/min]	f [mm/rev]	ap [mm]

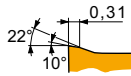

NMR geometry with positive design for medium to rough machining, and continuous cuts.

SNMG 120408E-NMR	T6310	0.8	■	155	0.35	2.6	■	110	0.32	2.6	■	-	-	-	■	45	0.25	2.1	-	-	-
	T7325	0.8	▣	175	0.35	2.6	■	135	0.32	2.6	■	-	-	-	■	55	0.25	2.1	-	-	-
	T7335	0.8	▣	165	0.35	2.6	■	125	0.32	2.6	■	-	-	-	■	50	0.25	2.1	-	-	-
	T8330	0.8	■	155	0.35	2.6	■	90	0.32	2.6	■	-	-	-	▣	35	0.25	2.1	-	-	-
	T8430	0.8	■	165	0.35	2.6	■	90	0.32	2.6	■	-	-	-	▣	35	0.25	2.1	-	-	-
	T9315	0.8	■	225	0.35	2.6	■	-	-	-	■	-	-	-	-	-	-	-	-	-	-
T9325	0.8	■	200	0.35	2.6	■	120	0.32	2.6	■	-	-	-	▣	45	0.25	2.1	-	-	-	
SNMG 120412E-NMR	T6310	1.2	■	160	0.40	2.6	■	115	0.36	2.6	■	-	-	-	■	45	0.28	2.1	-	-	-
	T7325	1.2	▣	175	0.40	2.6	■	135	0.36	2.6	■	-	-	-	■	55	0.28	2.1	-	-	-
	T7335	1.2	▣	165	0.40	2.6	■	125	0.36	2.6	■	-	-	-	■	50	0.28	2.1	-	-	-
	T9315	1.2	■	225	0.40	2.6	■	-	-	-	■	-	-	-	-	-	-	-	-	-	-
	T9325	1.2	■	200	0.40	2.6	■	120	0.36	2.6	■	-	-	-	▣	45	0.28	2.1	-	-	-
SNMG 120416E-NMR	T7325	1.6	▣	180	0.45	2.6	■	140	0.41	2.6	■	-	-	-	■	55	0.32	2.1	-	-	-
	T7335	1.6	▣	170	0.45	2.6	■	130	0.41	2.6	■	-	-	-	■	55	0.32	2.1	-	-	-
	T9325	1.6	■	200	0.45	2.6	■	120	0.41	2.6	■	-	-	-	▣	45	0.32	2.1	-	-	-
SNMG 150612E-NMR	T6310	1.2	■	150	0.40	3.8	■	105	0.36	3.8	■	-	-	-	■	45	0.28	3.0	-	-	-
	T7325	1.2	▣	170	0.40	3.8	■	130	0.36	3.8	■	-	-	-	■	55	0.28	3.0	-	-	-
	T9315	1.2	■	215	0.40	3.8	■	-	-	-	■	-	-	-	-	-	-	-	-	-	-
	T9325	1.2	■	190	0.40	3.8	■	110	0.36	3.8	■	-	-	-	▣	40	0.28	3.0	-	-	-
SNMG 190612E-NMR	T6310	1.2	■	145	0.40	5.2	■	100	0.36	5.2	■	-	-	-	■	40	0.28	4.2	-	-	-
	T7325	1.2	▣	165	0.40	5.2	■	125	0.36	5.2	■	-	-	-	■	50	0.28	4.2	-	-	-
	T7335	1.2	▣	155	0.40	5.2	■	120	0.36	5.2	■	-	-	-	■	50	0.28	4.2	-	-	-
	T9315	1.2	■	210	0.40	5.2	■	-	-	-	■	-	-	-	-	-	-	-	-	-	-
	T9325	1.2	■	185	0.40	5.2	■	110	0.36	5.2	■	-	-	-	▣	40	0.28	4.2	-	-	-
SNMG 190616E-NMR	T6310	1.6	■	150	0.45	5.2	■	105	0.41	5.2	■	-	-	-	■	45	0.32	4.2	-	-	-
	T7325	1.6	▣	170	0.45	5.2	■	130	0.41	5.2	■	-	-	-	■	55	0.32	4.2	-	-	-
	T7335	1.6	▣	155	0.45	5.2	■	120	0.41	5.2	■	-	-	-	■	50	0.32	4.2	-	-	-
	T9315	1.6	■	205	0.45	5.2	■	-	-	-	■	-	-	-	-	-	-	-	-	-	-
	T9325	1.6	■	185	0.45	5.2	■	110	0.41	5.2	■	-	-	-	▣	40	0.32	4.2	-	-	-

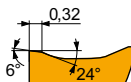

NRM geometry with positive design for semi-rough to rough machining, and continuous to moderate interrupted cuts.

SNMG 120408-NRM	T7325	0.8	▣	175	0.35	2.6	■	135	0.32	2.6	■	-	-	-	■	55	0.28	2.1	-	-	-
	T7335	0.8	▣	165	0.35	2.6	■	125	0.32	2.6	■	-	-	-	■	50	0.28	2.1	-	-	-
	T9315	0.8	■	225	0.35	2.6	■	-	-	-	■	-	-	-	-	-	-	-	-	-	-
SNMG 120412-NRM	T7325	1.2	▣	175	0.40	3.0	■	135	0.36	3.0	■	-	-	-	■	55	0.28	2.4	-	-	-
	T7335	1.2	▣	165	0.40	3.0	■	125	0.36	3.0	■	-	-	-	■	50	0.28	2.4	-	-	-
	T9315	1.2	■	220	0.40	3.0	■	-	-	-	■	-	-	-	-	-	-	-	-	-	-
SNMG 150612-NRM	T7325	1.2	▣	170	0.40	4.0	■	130	0.36	4.0	■	-	-	-	■	55	0.32	3.2	-	-	-
	T7335	1.2	▣	160	0.40	4.0	■	120	0.36	4.0	■	-	-	-	■	50	0.32	3.2	-	-	-
	T9315	1.2	■	215	0.40	4.0	■	-	-	-	■	-	-	-	-	-	-	-	-	-	-
SNMG 150616-NRM	T7325	1.6	▣	170	0.45	5.0	■	130	0.41	5.0	■	-	-	-	■	55	0.36	4.0	-	-	-
	T7335	1.6	▣	155	0.45	5.0	■	120	0.41	5.0	■	-	-	-	■	50	0.36	4.0	-	-	-
	T9315	1.6	■	205	0.45	5.0	■	-	-	-	■	-	-	-	-	-	-	-	-	-	-
SNMG 190612-NRM	T7325	1.2	▣	165	0.40	5.2	■	125	0.36	5.2	■	-	-	-	■	50	0.32	4.2	-	-	-
	T7335	1.2	▣	155	0.40	5.2	■	120	0.36	5.2	■	-	-	-	■	50	0.32	4.2	-	-	-
	T9315	1.2	■	210	0.40	5.2	■	-	-	-	■	-	-	-	-	-	-	-	-	-	-
SNMG 190616-NRM	T7325	1.6	▣	170	0.45	5.2	■	130	0.41	5.2	■	-	-	-	■	55	0.36	4.2	-	-	-
	T7335	1.6	▣	155	0.45	5.2	■	120	0.41	5.2	■	-	-	-	■	50	0.36	4.2	-	-	-
	T9315	1.6	■	205	0.45	5.2	■	-	-	-	■	-	-	-	-	-	-	-	-	-	-
SNMG 250724-NRM	T7325	2.4	▣	105	0.65	9.0	■	80	0.59	9.0	■	-	-	-	■	30	0.46	7.2	-	-	-
	T7335	2.4	▣	100	0.65	9.0	■	75	0.59	9.0	■	-	-	-	■	30	0.46	7.2	-	-	-
	T9315	2.4	■	120	0.65	9.0	■	-	-	-	▣	110	0.65	9.0	■	-	-	-	-	-	-



Suitability and starting values for cutting speed (vc), feed (f) and depth of cut (ap). Refer to our Machining Calculator app for further calculations.

Product	RE  (mm)	P			M			K			N			S			H		
		vc [m/min]	f [mm/rev]	ap [mm]	vc [m/min]	f [mm/rev]	ap [mm]	vc [m/min]	f [mm/rev]	ap [mm]	vc [m/min]	f [mm/rev]	ap [mm]	vc [m/min]	f [mm/rev]	ap [mm]	vc [m/min]	f [mm/rev]	ap [mm]

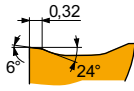

NRM geometry with positive design for semi-rough to rough machining, and continuous to moderate interrupted cuts.

SNMG 250924-NRM	T7325	2.4	105	0.70	9.0	80	0.63	9.0	–	–	–	–	–	–	–	30	0.49	7.2	–	–	–
	T7335	2.4	95	0.70	9.0	70	0.63	9.0	–	–	–	–	–	–	–	30	0.49	7.2	–	–	–
	T9315	2.4	120	0.70	9.0	–	–	–	110	0.70	9.0	–	–	–	–	–	–	–	–	–	–

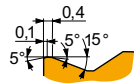

R geometry for semi-rough to rough machining, and continuous to interrupted cuts.

SNMG 120408E-R	6640	0.8	145	0.40	3.8	–	–	–	135	0.40	3.8	–	–	–	–	–	–	–	–	–	–	–
	T5305	0.8	250	0.40	3.8	–	–	–	235	0.40	3.8	–	–	–	–	–	–	–	50	0.15	1.0	
	T9315	0.8	200	0.40	3.8	–	–	–	190	0.40	3.8	–	–	–	–	–	–	–	40	0.15	1.0	
	T9325	0.8	180	0.40	3.8	–	–	–	170	0.40	3.8	–	–	–	–	–	–	–	–	–	–	–
	T9335	0.8	155	0.40	3.8	–	–	–	–	–	–	–	–	–	–	–	–	–	–	–	–	–
SNMG 120412E-R	T5305	1.2	255	0.45	3.8	–	–	–	240	0.45	3.8	–	–	–	–	–	–	–	50	0.15	1.0	
	T9310	1.2	220	0.45	3.8	–	–	–	205	0.45	3.8	–	–	–	–	–	–	–	40	0.15	1.0	
	T9325	1.2	180	0.45	3.8	–	–	–	170	0.45	3.8	–	–	–	–	–	–	–	–	–	–	–
	T9335	1.2	160	0.45	3.8	–	–	–	–	–	–	–	–	–	–	–	–	–	–	–	–	–
SNMG 120416E-R	T9315	1.6	205	0.50	3.8	–	–	–	190	0.50	3.8	–	–	–	–	–	–	–	40	0.15	1.0	
	T9325	1.6	185	0.50	3.8	–	–	–	175	0.50	3.8	–	–	–	–	–	–	–	–	–	–	–
SNMG 150612E-R	T5305	1.2	250	0.45	4.5	–	–	–	235	0.45	4.5	–	–	–	–	–	–	–	50	0.15	1.0	
	T5315	1.2	230	0.45	4.5	–	–	–	215	0.45	4.5	–	–	–	–	–	–	–	45	0.15	1.0	
	T9315	1.2	200	0.45	4.5	–	–	–	190	0.45	4.5	–	–	–	–	–	–	–	40	0.15	1.0	
	T9325	1.2	180	0.45	4.5	–	–	–	170	0.45	4.5	–	–	–	–	–	–	–	–	–	–	–
SNMG 150616E-R	T5315	1.6	230	0.50	4.5	–	–	–	215	0.50	4.5	–	–	–	–	–	–	–	45	0.15	1.0	
	T9325	1.6	180	0.50	4.5	–	–	–	170	0.50	4.5	–	–	–	–	–	–	–	–	–	–	–
SNMG 190612E-R	6640	1.2	140	0.45	6.0	–	–	–	130	0.45	6.0	–	–	–	–	–	–	–	–	–	–	–
	T9310	1.2	210	0.45	6.0	–	–	–	195	0.45	6.0	–	–	–	–	–	–	–	40	0.15	1.0	
	T9315	1.2	195	0.45	6.0	–	–	–	185	0.45	6.0	–	–	–	–	–	–	–	35	0.15	1.0	
	T9325	1.2	175	0.45	6.0	–	–	–	165	0.45	6.0	–	–	–	–	–	–	–	–	–	–	–
SNMG 190616E-R	T9310	1.6	205	0.50	6.0	–	–	–	190	0.50	6.0	–	–	–	–	–	–	–	40	0.15	1.0	
	T9315	1.6	195	0.50	6.0	–	–	–	185	0.50	6.0	–	–	–	–	–	–	–	35	0.15	1.0	
	T9325	1.6	175	0.50	6.0	–	–	–	165	0.50	6.0	–	–	–	–	–	–	–	–	–	–	–
	T9335	1.6	150	0.50	6.0	–	–	–	–	–	–	–	–	–	–	–	–	–	–	–	–	–

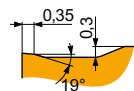

RM geometry for semi-rough to rough machining, and continuous to interrupted cuts.

SNMG 120408E-RM	T5305	0.8	290	0.40	4.0	–	–	–	275	0.40	4.0	–	–	–	–	–	–	–	–	–	–
	T5315	0.8	260	0.40	4.0	–	–	–	245	0.40	4.0	–	–	–	–	–	–	–	–	–	–
	T6310	0.8	165	0.40	4.0	115	0.36	4.0	130	0.40	4.0	–	–	–	–	–	–	–	–	–	–
	T7325	0.8	185	0.40	4.0	140	0.36	4.0	–	–	–	–	–	–	–	–	–	–	–	–	–
	T7335	0.8	175	0.40	4.0	135	0.36	4.0	–	–	–	–	–	–	–	–	–	–	–	–	–
	T8315	0.8	175	0.40	4.0	105	0.36	4.0	165	0.40	4.0	–	–	–	–	–	–	–	–	–	–
	T8330	0.8	165	0.40	4.0	95	0.36	4.0	155	0.40	4.0	–	–	–	–	–	–	–	–	–	–
	T8430	0.8	175	0.40	4.0	95	0.36	4.0	140	0.40	4.0	–	–	–	–	–	–	–	–	–	–
	T9310	0.8	250	0.40	4.0	–	–	–	235	0.40	4.0	–	–	–	–	–	–	–	–	–	–
	T9315	0.8	235	0.40	4.0	–	–	–	220	0.40	4.0	–	–	–	–	–	–	–	–	–	–
	T9325	0.8	210	0.40	4.0	125	0.36	4.0	195	0.40	4.0	–	–	–	–	–	–	–	–	–	–
	T9335	0.8	180	0.40	4.0	105	0.36	4.0	–	–	–	–	–	–	–	–	–	–	–	–	–



Suitability and starting values for cutting speed (vc), feed (f) and depth of cut (ap). Refer to our Machining Calculator app for further calculations.

Product	RE [mm]	P			M			K			N			S			H		
		vc	f	ap	vc	f	ap	vc	f	ap	vc	f	ap	vc	f	ap	vc	f	ap
		[m/min]	[mm/rev]	[mm]	[m/min]	[mm/rev]	[mm]	[m/min]	[mm/rev]	[mm]	[m/min]	[mm/rev]	[mm]	[m/min]	[mm/rev]	[mm]	[m/min]	[mm/rev]	[mm]

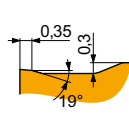

RM geometry for semi-rough to rough machining, and continuous to interrupted cuts.

SNMG 120412E-RM	T5305	1.2	295	0.45	4.0	-	-	-	280	0.45	4.0	-	-	-	-	-	-	-	
	T5315	1.2	265	0.45	4.0	-	-	-	250	0.45	4.0	-	-	-	-	-	-	-	
	T6310	1.2	165	0.45	4.0	115	0.41	4.0	130	0.45	4.0	-	-	-	-	-	-	-	
	T7325	1.2	190	0.45	4.0	145	0.41	4.0	-	-	-	-	-	-	-	-	-	-	
	T7335	1.2	180	0.45	4.0	140	0.41	4.0	-	-	-	-	-	-	-	-	-	-	
	T9310	1.2	250	0.45	4.0	-	-	-	235	0.45	4.0	-	-	-	-	-	-	-	-
	T9315	1.2	235	0.45	4.0	-	-	-	220	0.45	4.0	-	-	-	-	-	-	-	-
	T9325	1.2	210	0.45	4.0	125	0.41	4.0	195	0.45	4.0	-	-	-	-	-	-	-	-
	T9335	1.2	185	0.45	4.0	110	0.41	4.0	-	-	-	-	-	-	-	-	-	-	-
SNMG 120416E-RM	T5315	1.6	270	0.50	4.0	-	-	-	255	0.50	4.0	-	-	-	-	-	-	-	
	T7335	1.6	180	0.50	4.0	140	0.45	4.0	-	-	-	-	-	-	-	-	-	-	
	T8330	1.6	170	0.50	4.0	100	0.45	4.0	160	0.50	4.0	-	-	-	-	-	-	-	
	T8430	1.6	175	0.50	4.0	95	0.45	4.0	140	0.50	4.0	-	-	-	-	-	-	-	
	T9315	1.6	230	0.50	4.0	-	-	-	215	0.50	4.0	-	-	-	-	-	-	-	-
	T9325	1.6	215	0.50	4.0	125	0.45	4.0	200	0.50	4.0	-	-	-	-	-	-	-	-
SNMG 150612E-RM	T9335	1.6	180	0.50	4.0	105	0.45	4.0	-	-	-	-	-	-	-	-	-	-	
	T5315	1.2	255	0.45	5.0	-	-	-	240	0.45	5.0	-	-	-	-	-	-	-	
	T6310	1.2	165	0.45	5.0	115	0.41	5.0	130	0.45	5.0	-	-	-	-	-	-	-	
	T7325	1.2	185	0.45	5.0	140	0.41	5.0	-	-	-	-	-	-	-	-	-	-	
	T7335	1.2	175	0.45	5.0	135	0.41	5.0	-	-	-	-	-	-	-	-	-	-	
	T9310	1.2	245	0.45	5.0	-	-	-	230	0.45	5.0	-	-	-	-	-	-	-	-
	T9315	1.2	225	0.45	5.0	-	-	-	210	0.45	5.0	-	-	-	-	-	-	-	-
SNMG 150616E-RM	T9325	1.2	205	0.45	5.0	120	0.41	5.0	190	0.45	5.0	-	-	-	-	-	-	-	
	T9335	1.2	180	0.45	5.0	105	0.41	5.0	-	-	-	-	-	-	-	-	-	-	
	T7335	1.6	175	0.50	5.0	135	0.45	5.0	-	-	-	-	-	-	-	-	-	-	
	T9315	1.6	230	0.50	5.0	-	-	-	215	0.50	5.0	-	-	-	-	-	-	-	
SNMG 190612E-RM	T9325	1.6	205	0.50	5.0	120	0.45	5.0	190	0.50	5.0	-	-	-	-	-	-	-	
	T9335	1.6	180	0.50	5.0	105	0.45	5.0	-	-	-	-	-	-	-	-	-	-	
	T5305	1.2	275	0.45	7.0	-	-	-	260	0.45	7.0	-	-	-	-	-	-	-	
	T5315	1.2	250	0.45	7.0	-	-	-	235	0.45	7.0	-	-	-	-	-	-	-	
SNMG 190616E-RM	T7325	1.2	180	0.45	7.0	140	0.41	7.0	-	-	-	-	-	-	-	-	-	-	
	T7335	1.2	165	0.45	7.0	125	0.41	7.0	-	-	-	-	-	-	-	-	-	-	
	T9310	1.2	240	0.45	7.0	-	-	-	225	0.45	7.0	-	-	-	-	-	-	-	
	T9315	1.2	220	0.45	7.0	-	-	-	205	0.45	7.0	-	-	-	-	-	-	-	-
	T9325	1.2	195	0.45	7.0	115	0.41	7.0	185	0.45	7.0	-	-	-	-	-	-	-	
	T9335	1.2	175	0.45	7.0	105	0.41	7.0	-	-	-	-	-	-	-	-	-	-	
	T5305	1.6	285	0.50	7.0	-	-	-	270	0.50	7.0	-	-	-	-	-	-	-	
	T5315	1.6	250	0.50	7.0	-	-	-	235	0.50	7.0	-	-	-	-	-	-	-	
	T6310	1.6	160	0.50	7.0	115	0.45	7.0	125	0.50	7.0	-	-	-	-	-	-	-	
SNMG 250924E-RM	T7335	1.6	170	0.50	7.0	130	0.45	7.0	-	-	-	-	-	-	-	-	-	-	
	T9310	1.6	240	0.50	7.0	-	-	-	225	0.50	7.0	-	-	-	-	-	-	-	
	T9315	1.6	220	0.50	7.0	-	-	-	205	0.50	7.0	-	-	-	-	-	-	-	
	T9325	1.6	200	0.50	7.0	120	0.45	7.0	190	0.50	7.0	-	-	-	-	-	-	-	
	T9335	1.6	175	0.50	7.0	105	0.45	7.0	-	-	-	-	-	-	-	-	-	-	
	T7325	2.4	110	0.80	12.0	85	0.72	12.0	-	-	-	-	-	-	-	-	-	-	
	T7335	2.4	105	0.80	12.0	80	0.72	12.0	-	-	-	-	-	-	-	-	-	-	
SNMG 120404E-SF	T9226	2.4	95	0.80	12.0	55	0.72	12.0	90	0.80	12.0	-	-	-	-	-	-	-	
	T9315	2.4	125	0.80	12.0	-	-	-	115	0.80	12.0	-	-	-	-	-	-	-	
	T9325	2.4	110	0.80	12.0	65	0.72	12.0	100	0.80	12.0	-	-	-	-	-	-	-	
	T9335	2.4	90	0.80	12.0	50	0.72	12.0	-	-	-	-	-	-	-	-	-	-	
	T7325	0.4	215	0.17	1.0	165	0.15	1.0	-	-	-	65	0.15	0.8	-	-	-	-	
T9325	0.4	265	0.17	1.0	155	0.15	1.0	250	0.17	1.0	55	0.15	0.8	-	-	-	-		

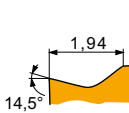

SF geometry with positive design for fine-finish machining of thin walls and continuous cuts.



Suitability and starting values for cutting speed (vc), feed (f) and depth of cut (ap). Refer to our Machining Calculator app for further calculations.

Product	RE  [mm]	P			M			K			N			S			H		
		vc [m/min]	f [mm/rev]	ap [mm]	vc [m/min]	f [mm/rev]	ap [mm]	vc [m/min]	f [mm/rev]	ap [mm]	vc [m/min]	f [mm/rev]	ap [mm]	vc [m/min]	f [mm/rev]	ap [mm]	vc [m/min]	f [mm/rev]	ap [mm]

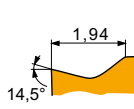

SF geometry with positive design for fine-finish machining of thin walls and continuous cuts.

SNMG 120408E-SF	H07	0.8	–	–	–	105	0.18	1.0	165	0.20	1.0	525	0.24	1.0	50	0.14	0.8	–	–	–
	T6310	0.8	210	0.20	1.0	150	0.18	1.0	165	0.20	1.0	630	0.24	1.0	60	0.14	0.8	40	0.15	1.0
	T7325	0.8	245	0.20	1.0	190	0.18	1.0	–	–	–	–	–	–	75	0.16	0.8	–	–	–
	T7335	0.8	235	0.20	1.0	180	0.18	1.0	–	–	–	–	–	–	75	0.16	0.8	–	–	–
	T8315	0.8	225	0.20	1.0	135	0.18	1.0	210	0.20	1.0	675	0.24	1.0	55	0.14	0.8	45	0.15	1.0
	T8330	0.8	210	0.20	1.0	125	0.18	1.0	195	0.20	1.0	630	0.24	1.0	50	0.14	0.8	40	0.15	1.0
	T8430	0.8	245	0.20	1.0	135	0.18	1.0	200	0.20	1.0	675	0.24	1.0	50	0.14	0.8	40	0.15	1.0
	T9325	0.8	295	0.20	1.0	175	0.18	1.0	280	0.20	1.0	–	–	–	65	0.16	0.8	–	–	–
SNMG 120412E-SF	T6310	1.2	200	0.25	1.5	140	0.23	1.5	160	0.25	1.5	600	0.30	1.5	60	0.18	1.2	40	0.15	1.0
	T7325	1.2	230	0.25	1.5	175	0.23	1.5	–	–	–	–	–	70	0.18	1.2	–	–	–	
	T8330	1.2	200	0.25	1.5	120	0.23	1.5	190	0.25	1.5	600	0.30	1.5	50	0.18	1.2	40	0.15	1.0
	T8430	1.2	225	0.25	1.5	120	0.23	1.5	185	0.25	1.5	615	0.30	1.5	45	0.18	1.2	35	0.15	1.0

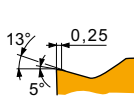

SM geometry with positive design for medium machining and continuous to interrupted cuts.

SNMG 120408E-SM	T6310	0.8	185	0.25	1.8	130	0.23	1.8	145	0.25	1.8	555	0.30	1.8	55	0.20	1.4	35	0.15	1.0
	T7325	0.8	210	0.25	1.8	160	0.23	1.8	–	–	–	–	–	65	0.20	1.4	–	–	–	
	T7335	0.8	205	0.25	1.8	155	0.23	1.8	–	–	–	–	–	65	0.20	1.4	–	–	–	
	T8330	0.8	185	0.25	1.8	110	0.23	1.8	175	0.25	1.8	555	0.30	1.8	45	0.20	1.4	35	0.15	1.0
	T8430	0.8	205	0.25	1.8	110	0.23	1.8	170	0.25	1.8	570	0.30	1.8	45	0.20	1.4	35	0.15	1.0
	T9315	0.8	280	0.25	1.8	–	–	–	265	0.25	1.8	–	–	–	–	–	–	55	0.15	1.0
T9325	0.8	255	0.25	1.8	150	0.23	1.8	240	0.25	1.8	–	–	–	55	0.20	1.4	–	–	–	
SNMG 120412E-SM	T7325	1.2	210	0.30	1.8	160	0.27	1.8	–	–	–	–	–	65	0.24	1.4	–	–	–	
	T7335	1.2	200	0.30	1.8	155	0.27	1.8	–	–	–	–	–	65	0.24	1.4	–	–	–	
	T9315	1.2	275	0.30	1.8	–	–	–	260	0.30	1.8	–	–	–	–	–	55	0.15	1.0	
	T9325	1.2	245	0.30	1.8	145	0.27	1.8	230	0.30	1.8	–	–	–	55	0.24	1.4	–	–	–
SNMG 190612E-SM	T6310	1.2	175	0.30	4.0	125	0.27	4.0	140	0.30	4.0	525	0.36	4.0	50	0.27	3.2	35	0.15	1.0
	T7325	1.2	195	0.30	4.0	150	0.27	4.0	–	–	–	–	–	60	0.27	3.2	–	–	–	
	T7335	1.2	185	0.30	4.0	140	0.27	4.0	–	–	–	–	–	60	0.27	3.2	–	–	–	
	T9325	1.2	230	0.30	4.0	135	0.27	4.0	215	0.30	4.0	–	–	–	50	0.27	3.2	–	–	–
SNMG 190616E-SM	T7325	1.6	190	0.40	4.0	145	0.36	4.0	–	–	–	–	–	60	0.32	3.2	–	–	–	
	T7335	1.6	175	0.40	4.0	135	0.36	4.0	–	–	–	–	–	55	0.32	3.2	–	–	–	
	T9325	1.6	210	0.40	4.0	125	0.36	4.0	195	0.40	4.0	–	–	–	45	0.32	3.2	–	–	–



SNMM

	IC	D1	L	S
	[mm]	[mm]	[mm]	[mm]
1204	12.700	5.16	12.70	4.76
1506	15.875	6.35	15.875	6.35
1906	19.050	7.94	19.05	6.35
2507	25.400	9.12	25.40	7.94
2509	25.400	9.12	25.40	9.525

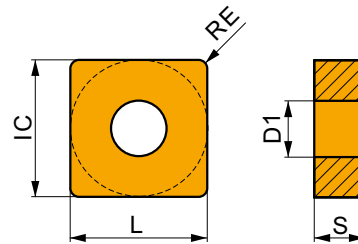

Suitability and starting values for cutting speed (vc), feed (f) and depth of cut (ap). Refer to our Machining Calculator app for further calculations.

Product	RE	P			M			K			N			S			H		
		vc	f	ap	vc	f	ap	vc	f	ap	vc	f	ap	vc	f	ap	vc	f	ap
	[mm]	[m/min]	[mm/rev]	[mm]	[m/min]	[mm/rev]	[mm]	[m/min]	[mm/rev]	[mm]	[m/min]	[mm/rev]	[mm]	[m/min]	[mm/rev]	[mm]	[m/min]	[mm/rev]	[mm]

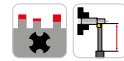
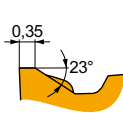

DR geometry for semi-rough to rough machining, and continuous to interrupted cuts.

SNMM 120412E-DR	T9315	1.2	245	0.45	4.7	—	—	—	230	0.45	4.7	—	—	—	—	—	—	—	—
	T9325	1.2	220	0.45	4.7	130	0.41	4.7	205	0.45	4.7	—	—	—	—	—	—	—	—
	T9335	1.2	185	0.45	4.7	110	0.41	4.7	—	—	—	—	—	—	—	—	—	—	—
SNMM 150612E-DR	T9325	1.2	210	0.45	6.0	125	0.41	6.0	195	0.45	6.0	—	—	—	—	—	—	—	—
	T9335	1.2	180	0.45	6.0	105	0.41	6.0	—	—	—	—	—	—	—	—	—	—	—
SNMM 190612E-DR	6640	1.2	170	0.45	6.0	100	0.41	6.0	160	0.45	6.0	—	—	—	—	—	—	—	—
	T9325	1.2	210	0.45	6.0	125	0.41	6.0	195	0.45	6.0	—	—	—	—	—	—	—	—
	T9335	1.2	180	0.45	6.0	105	0.41	6.0	—	—	—	—	—	—	—	—	—	—	—
SNMM 190616E-DR	T9325	1.6	210	0.50	6.0	125	0.45	6.0	195	0.50	6.0	—	—	—	—	—	—	—	—
	T9335	1.6	185	0.50	6.0	110	0.45	6.0	—	—	—	—	—	—	—	—	—	—	—

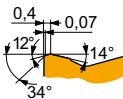

HR geometry for rough to heavy-rough machining, and continuous to interrupted cuts.

SNMM 190616E-HR	T8345	1.6	60	0.60	9.0	35	0.54	9.0	55	0.60	9.0	—	—	—	—	—	—	—	—
	T9325	1.6	110	0.60	9.0	65	0.54	9.0	100	0.60	9.0	—	—	—	—	—	—	—	—
	T9335	1.6	85	0.60	9.0	50	0.54	9.0	—	—	—	—	—	—	—	—	—	—	—
SNMM 190624E-HR	T8345	2.4	60	0.65	9.0	35	0.59	9.0	55	0.65	9.0	—	—	—	—	—	—	—	—
	T9315	2.4	120	0.65	9.0	—	—	—	110	0.65	9.0	—	—	—	—	—	—	—	—
	T9325	2.4	115	0.65	9.0	65	0.59	9.0	105	0.65	9.0	—	—	—	—	—	—	—	—
SNMM 250716E-HR	T8345	1.6	60	0.60	13.0	35	0.54	13.0	55	0.60	13.0	—	—	—	—	—	—	—	—
	T9325	1.6	100	0.60	13.0	60	0.54	13.0	95	0.60	13.0	—	—	—	—	—	—	—	—
	T9335	1.6	85	0.60	13.0	50	0.54	13.0	—	—	—	—	—	—	—	—	—	—	—
SNMM 250724E-HR	6640	2.4	80	0.65	13.0	45	0.59	13.0	75	0.65	13.0	—	—	—	—	—	—	—	—
	T8345	2.4	55	0.65	13.0	30	0.59	13.0	50	0.65	13.0	—	—	—	—	—	—	—	—
	T9315	2.4	120	0.65	13.0	—	—	—	110	0.65	13.0	—	—	—	—	—	—	—	—
	T9325	2.4	105	0.65	13.0	60	0.59	13.0	95	0.65	13.0	—	—	—	—	—	—	—	—
	T9335	2.4	85	0.65	13.0	50	0.59	13.0	—	—	—	—	—	—	—	—	—	—	—
SNMM 250732E-HR	T9325	3.2	95	0.80	13.0	55	0.72	13.0	90	0.80	13.0	—	—	—	—	—	—	—	—
SNMM 250924E-HR	T8345	2.4	55	0.65	13.0	30	0.59	13.0	50	0.65	13.0	—	—	—	—	—	—	—	—
	T9315	2.4	120	0.65	13.0	—	—	—	110	0.65	13.0	—	—	—	—	—	—	—	—
	T9325	2.4	105	0.65	13.0	60	0.59	13.0	95	0.65	13.0	—	—	—	—	—	—	—	—
	T9335	2.4	85	0.65	13.0	50	0.59	13.0	—	—	—	—	—	—	—	—	—	—	—
SNMM 250932E-HR	T9325	3.2	95	0.80	13.0	55	0.72	13.0	90	0.80	13.0	—	—	—	—	—	—	—	—



Suitability and starting values for cutting speed (vc), feed (f) and depth of cut (ap). Refer to our Machining Calculator app for further calculations.

Product	RE <small>(mm)</small>	P			M			K			N			S			H		
		vc <small>(m/min)</small>	f <small>(mm/rev)</small>	ap <small>(mm)</small>	vc <small>(m/min)</small>	f <small>(mm/rev)</small>	ap <small>(mm)</small>	vc <small>(m/min)</small>	f <small>(mm/rev)</small>	ap <small>(mm)</small>	vc <small>(m/min)</small>	f <small>(mm/rev)</small>	ap <small>(mm)</small>	vc <small>(m/min)</small>	f <small>(mm/rev)</small>	ap <small>(mm)</small>	vc <small>(m/min)</small>	f <small>(mm/rev)</small>	ap <small>(mm)</small>

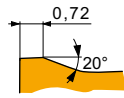

HR2 geometry for rough to heavy-rough machining, and continuous to interrupted cuts.

SNMM 190616-HR2	T9315	1.6	█	115	0.65	8.9	█	105	0.65	8.9	█	–	–	–	–	–	–	–
	T9335	1.6	█	85	0.65	8.9	█	50	0.59	8.9	█	–	–	–	–	–	–	–
SNMM 190624-HR2	T9315	2.4	█	105	0.85	8.9	█	95	0.85	8.9	█	–	–	–	–	–	–	–
	T9335	2.4	█	80	0.85	8.9	█	45	0.77	8.9	█	–	–	–	–	–	–	–
SNMM 250724-HR2	T9226	2.4	█	85	0.85	11.0	█	80	0.85	11.0	█	–	–	–	–	–	–	–
	T9315	2.4	█	105	0.85	11.0	█	95	0.85	11.0	█	–	–	–	–	–	–	–
	T9335	2.4	█	80	0.85	11.0	█	45	0.77	11.0	█	–	–	–	–	–	–	–
SNMM 250732-HR2	T9315	3.2	█	95	1.00	11.0	█	90	1.00	11.0	█	–	–	–	–	–	–	–
SNMM 250924-HR2	T9226	2.4	█	85	0.85	11.0	█	80	0.85	11.0	█	–	–	–	–	–	–	–
	T9315	2.4	█	105	0.85	11.0	█	95	0.85	11.0	█	–	–	–	–	–	–	–
	T9335	2.4	█	80	0.85	11.0	█	45	0.77	11.0	█	–	–	–	–	–	–	–
SNMM 250932-HR2	T9315	3.2	█	95	1.00	11.0	█	90	1.00	11.0	█	–	–	–	–	–	–	–
	T9335	3.2	█	75	1.00	11.0	█	45	0.90	11.0	█	–	–	–	–	–	–	–

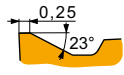

NR geometry for semi-rough to rough machining, and continuous to interrupted cuts.

SNMM 120408E-NR	T7325	0.8	█	185	0.40	3.0	█	140	0.36	3.0	█	–	–	–	█	60	0.28	2.4	–	–	–
	T7335	0.8	█	175	0.40	3.0	█	135	0.36	3.0	█	–	–	–	█	55	0.28	2.4	–	–	–
	T8330	0.8	█	160	0.40	3.0	█	95	0.36	3.0	█	–	–	–	█	40	0.28	2.4	–	–	–
	T8430	0.8	█	170	0.40	3.0	█	90	0.36	3.0	█	–	–	–	█	35	0.28	2.4	–	–	–
	T9325	0.8	█	205	0.40	3.0	█	120	0.36	3.0	█	–	–	–	█	45	0.28	2.4	–	–	–

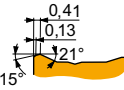

NR2 geometry for semi-rough to rough machining, and continuous to interrupted cuts.

SNMM 120408E-NR2	T7325	0.8	█	175	0.40	4.7	█	135	0.36	4.7	█	–	–	–	█	55	0.32	3.8	–	–	–
	T7335	0.8	█	170	0.40	4.7	█	130	0.36	4.7	█	–	–	–	█	55	0.32	3.8	–	–	–
	T8330	0.8	█	155	0.40	4.7	█	90	0.36	4.7	█	–	–	–	█	35	0.32	3.8	–	–	–
	T8430	0.8	█	165	0.40	4.7	█	90	0.36	4.7	█	–	–	–	█	35	0.32	3.8	–	–	–
	T9325	0.8	█	195	0.40	4.7	█	115	0.36	4.7	█	–	–	–	█	40	0.32	3.8	–	–	–
SNMM 120412E-NR2	T7335	1.2	█	165	0.45	4.7	█	125	0.41	4.7	█	–	–	–	█	50	0.36	3.8	–	–	–
	T8330	1.2	█	160	0.45	4.7	█	95	0.41	4.7	█	–	–	–	█	40	0.36	3.8	–	–	–
	T8430	1.2	█	165	0.45	4.7	█	90	0.41	4.7	█	–	–	–	█	35	0.36	3.8	–	–	–
	T9325	1.2	█	200	0.45	4.7	█	120	0.41	4.7	█	–	–	–	█	45	0.36	3.8	–	–	–
SNMM 150612E-NR2	T7325	1.2	█	170	0.45	6.0	█	130	0.41	6.0	█	–	–	–	█	55	0.36	4.8	–	–	–
	T7335	1.2	█	165	0.45	6.0	█	125	0.41	6.0	█	–	–	–	█	50	0.36	4.8	–	–	–
	T8330	1.2	█	155	0.45	6.0	█	90	0.41	6.0	█	–	–	–	█	35	0.36	4.8	–	–	–
	T8430	1.2	█	165	0.45	6.0	█	90	0.41	6.0	█	–	–	–	█	35	0.36	4.8	–	–	–
SNMM 150616E-NR2	T7335	1.6	█	165	0.50	6.0	█	125	0.45	6.0	█	–	–	–	█	50	0.40	4.8	–	–	–
	T9325	1.6	█	190	0.50	6.0	█	110	0.45	6.0	█	–	–	–	█	40	0.40	4.8	–	–	–
SNMM 190612E-NR2	T7335	1.2	█	160	0.45	8.0	█	120	0.41	8.0	█	–	–	–	█	50	0.36	6.4	–	–	–
	T9325	1.2	█	190	0.45	8.0	█	110	0.41	8.0	█	–	–	–	█	40	0.36	6.4	–	–	–
SNMM 190616E-NR2	T7325	1.6	█	175	0.50	8.0	█	135	0.45	8.0	█	–	–	–	█	55	0.40	6.4	–	–	–
	T7335	1.6	█	160	0.50	8.0	█	120	0.45	8.0	█	–	–	–	█	50	0.40	6.4	–	–	–
	T8330	1.6	█	155	0.50	8.0	█	90	0.45	8.0	█	–	–	–	█	35	0.40	6.4	–	–	–
	T8430	1.6	█	155	0.50	8.0	█	85	0.45	8.0	█	–	–	–	█	30	0.40	6.4	–	–	–
	T9315	1.6	█	210	0.50	8.0	█	–	–	–	█	–	–	–	–	–	–	–	–	–	–
SNMM 190624E-NR2	T9325	1.6	█	185	0.50	8.0	█	110	0.45	8.0	█	–	–	–	█	40	0.40	6.4	–	–	–
	T7325	2.4	█	155	0.80	8.0	█	120	0.72	8.0	█	–	–	–	█	50	0.56	6.4	–	–	–
	T7335	2.4	█	145	0.80	8.0	█	110	0.72	8.0	█	–	–	–	█	45	0.56	6.4	–	–	–
	T9325	2.4	█	165	0.80	8.0	█	95	0.72	8.0	█	–	–	–	█	35	0.56	6.4	–	–	–



Suitability and starting values for cutting speed (vc), feed (f) and depth of cut (ap). Refer to our Machining Calculator app for further calculations.

Product	RE [mm]	P			M			K			N			S			H		
		vc [m/min]	f [mm/rev]	ap [mm]	vc [m/min]	f [mm/rev]	ap [mm]	vc [m/min]	f [mm/rev]	ap [mm]	vc [m/min]	f [mm/rev]	ap [mm]	vc [m/min]	f [mm/rev]	ap [mm]	vc [m/min]	f [mm/rev]	ap [mm]

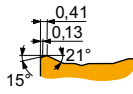

NR2 geometry for semi-rough to rough machining, and continuous to interrupted cuts.

SNMM 250724E-NR2	T7335	2.4	100	0.80	12.0	75	0.72	12.0	-	-	-	-	-	-	30	0.56	9.6	-	-	-
	T8330	2.4	85	0.80	12.0	50	0.72	12.0	80	0.80	12.0	-	-	-	20	0.56	9.6	-	-	-
	T8430	2.4	85	0.80	12.0	45	0.72	12.0	70	0.80	12.0	-	-	-	15	0.56	9.6	-	-	-
	T9226	2.4	95	0.80	12.0	55	0.72	12.0	90	0.80	12.0	-	-	-	20	0.56	9.6	-	-	-
	T9315	2.4	120	0.80	12.0	-	-	-	110	0.80	12.0	-	-	-	-	-	-	-	-	-
SNMM 250924E-NR2	T9325	2.4	105	0.80	12.0	60	0.72	12.0	95	0.80	12.0	-	-	-	20	0.56	9.6	-	-	-
	T7325	2.4	105	0.80	12.0	80	0.72	12.0	-	-	-	-	-	-	30	0.56	9.6	-	-	-
	T7335	2.4	100	0.80	12.0	75	0.72	12.0	-	-	-	-	-	-	30	0.56	9.6	-	-	-
	T9226	2.4	95	0.80	12.0	55	0.72	12.0	90	0.80	12.0	-	-	-	20	0.56	9.6	-	-	-
	T9315	2.4	120	0.80	12.0	-	-	-	110	0.80	12.0	-	-	-	-	-	-	-	-	-
T9325	2.4	105	0.80	12.0	60	0.72	12.0	95	0.80	12.0	-	-	-	20	0.56	9.6	-	-	-	-

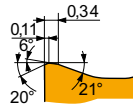

NRM geometry with positive design for semi-rough to rough machining, and continuous to moderate interrupted cuts.

SNMM 250716-NRM	T7325	1.6	115	0.45	9.0	85	0.41	9.0	-	-	-	-	-	-	35	0.36	7.2	-	-	-
	T7335	1.6	110	0.45	9.0	85	0.41	9.0	-	-	-	-	-	-	35	0.36	7.2	-	-	-
	T9315	1.6	135	0.45	9.0	-	-	-	125	0.45	9.0	-	-	-	-	-	-	-	-	-
SNMM 250724-NRM	T7325	2.4	105	0.65	9.0	80	0.59	9.0	-	-	-	-	-	-	30	0.46	7.2	-	-	-
	T7335	2.4	100	0.65	9.0	75	0.59	9.0	-	-	-	-	-	-	30	0.46	7.2	-	-	-
	T9315	2.4	120	0.65	9.0	-	-	-	110	0.65	9.0	-	-	-	-	-	-	-	-	-
SNMM 250924-NRM	T7325	2.4	105	0.70	9.0	80	0.63	9.0	-	-	-	-	-	-	30	0.49	7.2	-	-	-
	T7335	2.4	95	0.70	9.0	70	0.63	9.0	-	-	-	-	-	-	30	0.49	7.2	-	-	-
	T9315	2.4	120	0.70	9.0	-	-	-	110	0.70	9.0	-	-	-	-	-	-	-	-	-

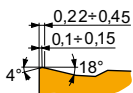

OR geometry for semi-rough to rough machining, and continuous to interrupted cuts.

SNMM 120408E-OR	T9315	0.8	220	0.40	4.7	-	-	-	205	0.40	4.7	-	-	-	-	-	-	-	-	-
	T9325	0.8	195	0.40	4.7	115	0.36	4.7	185	0.40	4.7	-	-	-	40	0.32	3.8	-	-	-
	T9335	0.8	175	0.40	4.7	105	0.36	4.7	-	-	-	-	-	-	35	0.32	3.8	-	-	-
SNMM 120412E-OR	T9315	1.2	225	0.45	4.7	-	-	-	210	0.45	4.7	-	-	-	-	-	-	-	-	-
	T9325	1.2	200	0.45	4.7	120	0.41	4.7	190	0.45	4.7	-	-	-	45	0.36	3.8	-	-	-
SNMM 120416E-OR	T9325	1.6	200	0.50	4.7	120	0.45	4.7	190	0.50	4.7	-	-	-	45	0.40	3.8	-	-	-
SNMM 150608E-OR	T9325	0.8	185	0.45	6.0	110	0.41	6.0	175	0.45	6.0	-	-	-	40	0.41	4.8	-	-	-
	T9335	0.8	170	0.40	6.0	100	0.36	6.0	-	-	-	-	-	-	35	0.36	4.8	-	-	-
SNMM 150612E-OR	T9325	1.2	195	0.45	6.0	115	0.41	6.0	185	0.45	6.0	-	-	-	40	0.36	4.8	-	-	-
	T9335	1.2	165	0.45	6.0	95	0.41	6.0	-	-	-	-	-	-	35	0.36	4.8	-	-	-
SNMM 150616E-OR	T9315	1.6	215	0.50	6.0	-	-	-	200	0.50	6.0	-	-	-	-	-	-	-	-	-
	T9325	1.6	190	0.50	6.0	110	0.45	6.0	180	0.50	6.0	-	-	-	40	0.40	4.8	-	-	-
SNMM 190612E-OR	T8330	1.2	150	0.45	8.0	90	0.41	8.0	140	0.45	8.0	-	-	-	35	0.36	6.4	-	-	-
	T8430	1.2	150	0.45	8.0	80	0.41	8.0	125	0.45	8.0	-	-	-	30	0.36	6.4	-	-	-
	T9315	1.2	210	0.45	8.0	-	-	-	195	0.45	8.0	-	-	-	-	-	-	-	-	-
	T9325	1.2	190	0.45	8.0	110	0.41	8.0	180	0.45	8.0	-	-	-	40	0.36	6.4	-	-	-
	T9335	1.2	165	0.45	8.0	95	0.41	8.0	-	-	-	-	-	-	35	0.36	6.4	-	-	-
SNMM 190616E-OR	T8330	1.6	155	0.50	8.0	90	0.45	8.0	145	0.50	8.0	-	-	-	35	0.40	6.4	-	-	-
	T8345	1.6	125	0.50	8.0	75	0.45	8.0	115	0.50	8.0	-	-	-	30	0.40	6.4	-	-	-
	T8430	1.6	155	0.50	8.0	85	0.45	8.0	130	0.50	8.0	-	-	-	30	0.40	6.4	-	-	-
	T9315	1.6	210	0.50	8.0	-	-	-	195	0.50	8.0	-	-	-	-	-	-	-	-	-
	T9325	1.6	185	0.50	8.0	110	0.45	8.0	175	0.50	8.0	-	-	-	40	0.40	6.4	-	-	-
SNMM 190624E-OR	T9335	1.6	160	0.50	8.0	95	0.45	8.0	-	-	-	-	-	-	35	0.40	6.4	-	-	-
	T9315	2.4	180	0.80	8.0	-	-	-	170	0.80	8.0	-	-	-	-	-	-	-	-	-
	T9325	2.4	165	0.80	8.0	95	0.72	8.0	155	0.80	8.0	-	-	-	35	0.56	6.4	-	-	-
SNMM 250716E-OR	T9226	1.6	115	0.50	12.0	65	0.45	12.0	105	0.50	12.0	-	-	-	20	0.45	9.6	-	-	-
	T9325	1.6	120	0.55	12.0	70	0.50	12.0	110	0.55	12.0	-	-	-	25	0.50	9.6	-	-	-



Suitability and starting values for cutting speed (vc), feed (f) and depth of cut (ap). Refer to our Machining Calculator app for further calculations.

Product	RE (mm)	P			M			K			N			S			H		
		vc [m/min]	f [mm/rev]	ap [mm]	vc [m/min]	f [mm/rev]	ap [mm]	vc [m/min]	f [mm/rev]	ap [mm]	vc [m/min]	f [mm/rev]	ap [mm]	vc [m/min]	f [mm/rev]	ap [mm]	vc [m/min]	f [mm/rev]	ap [mm]

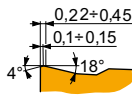

OR geometry for semi-rough to rough machining, and continuous to interrupted cuts.

SNMM 250724E-OR	T8330	2.4	80	1.00	12.0	45	0.90	12.0	75	1.00	12.0	—	—	—	20	0.70	9.6	—	—	—	
	T8345	2.4	55	1.00	12.0	30	0.90	12.0	50	1.00	12.0	—	—	—	10	0.70	9.6	—	—	—	
	T8430	2.4	80	1.00	12.0	45	0.90	12.0	65	1.00	12.0	—	—	—	15	0.70	9.6	—	—	—	
	T9315	2.4	105	1.00	12.0	—	—	—	95	1.00	12.0	—	—	—	—	—	—	—	—	—	—
	T9325	2.4	100	1.00	12.0	60	0.90	12.0	95	1.00	12.0	—	—	—	20	0.70	9.6	—	—	—	
SNMM 250924E-OR	T9335	2.4	80	1.00	12.0	45	0.90	12.0	—	—	—	—	—	—	15	0.70	9.6	—	—	—	
	T8430	2.4	80	1.00	12.0	45	0.90	12.0	65	1.00	12.0	—	—	—	15	0.70	9.6	—	—	—	
	T9226	2.4	85	1.00	12.0	50	0.90	12.0	80	1.00	12.0	—	—	—	15	0.70	9.6	—	—	—	
	T9315	2.4	105	1.00	12.0	—	—	—	95	1.00	12.0	—	—	—	—	—	—	—	—	—	
	T9325	2.4	100	1.00	12.0	60	0.90	12.0	95	1.00	12.0	—	—	—	20	0.70	9.6	—	—	—	
T9335	2.4	80	1.00	12.0	45	0.90	12.0	—	—	—	—	—	—	15	0.70	9.6	—	—	—		

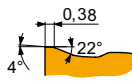

OR1 geometry for semi-rough to heavy-rough machining, and continuous to interrupted cuts.

SNMM 190616E-OR1	T9325	1.6	185	0.50	8.0	110	0.45	8.0	175	0.50	8.0	—	—	—	40	0.35	6.4	—	—	—
	T9335	1.6	160	0.50	8.0	95	0.45	8.0	—	—	—	—	—	—	35	0.35	6.4	—	—	—

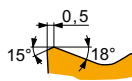

SR geometry for rough to heavy-rough machining, and continuous to interrupted cuts.

SNMM 250724S-SR	6640	2.4	60	1.00	12.0	35	0.90	12.0	55	1.00	12.0	—	—	—	—	—	—	—	—	—
	T9226	2.4	70	1.00	12.0	40	0.90	12.0	65	1.00	12.0	—	—	—	—	—	—	—	—	—
	T9325	2.4	80	1.00	12.0	45	0.90	12.0	75	1.00	12.0	—	—	—	—	—	—	—	—	—
SNMM 250924S-SR	T9335	2.4	65	1.00	14.0	35	0.90	14.0	—	—	—	—	—	—	—	—	—	—	—	—

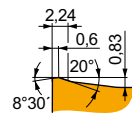

Geometry 923 for semi-rough to heavy-rough machining, and continuous to heavy interrupted cuts.

SNMM 190616S-923	T8330	1.6	125	0.65	8.9	75	0.59	8.9	115	0.65	8.9	—	—	—	30	0.52	7.1	—	—	—
	T8345	1.6	100	0.65	8.9	60	0.59	8.9	95	0.65	8.9	—	—	—	25	0.52	7.1	—	—	—
	T8430	1.6	125	0.65	8.9	65	0.59	8.9	100	0.65	8.9	—	—	—	25	0.52	7.1	—	—	—
	T9335	1.6	130	0.65	8.9	75	0.59	8.9	—	—	—	—	—	—	25	0.52	7.1	—	—	—
SNMM 250724S-923	T8330	2.4	80	0.85	11.0	45	0.77	11.0	75	0.85	11.0	—	—	—	20	0.60	8.8	—	—	—
	T8430	2.4	80	0.85	11.0	45	0.77	11.0	65	0.85	11.0	—	—	—	15	0.60	8.8	—	—	—
	T9335	2.4	80	0.85	11.0	45	0.77	11.0	—	—	—	—	—	—	15	0.60	8.8	—	—	—
SNMM 250924S-923	T8345	2.4	55	0.85	11.0	30	0.77	11.0	50	0.85	11.0	—	—	—	10	0.60	8.8	—	—	—
	T8430	2.4	80	0.85	11.0	45	0.77	11.0	65	0.85	11.0	—	—	—	15	0.60	8.8	—	—	—
	T9226	2.4	85	0.85	11.0	50	0.77	11.0	80	0.85	11.0	—	—	—	15	0.60	8.8	—	—	—
	T9315	2.4	105	0.85	11.0	—	—	—	95	0.85	11.0	—	—	—	—	—	—	—	—	—
T9335	2.4	80	0.85	11.0	45	0.77	11.0	—	—	—	—	—	—	15	0.60	8.8	—	—	—	
SNMM 250932S-923	T9226	3.2	80	1.00	11.0	45	0.90	11.0	75	1.00	11.0	—	—	—	15	0.70	8.8	—	—	—



SNMX

	IC	D1	L	S
	[mm]	[mm]	[mm]	[mm]
2512	25.400	9.17	25.40	12.00

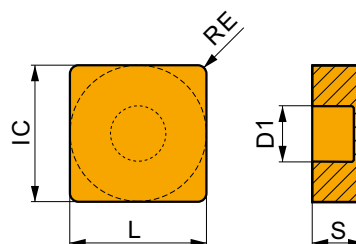

Suitability and starting values for cutting speed (vc), feed (f) and depth of cut (ap). Refer to our Machining Calculator app for further calculations.

Product	RE	P			M			K			N			S			H		
		vc	f	ap	vc	f	ap	vc	f	ap	vc	f	ap	vc	f	ap	vc	f	ap
	[mm]	[m/min]	[mm/rev]	[mm]	[m/min]	[mm/rev]	[mm]	[m/min]	[mm/rev]	[mm]	[m/min]	[mm/rev]	[mm]	[m/min]	[mm/rev]	[mm]	[m/min]	[mm/rev]	[mm]

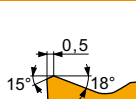

SR geometry for rough to heavy-rough machining, and continuous to interrupted cuts.

SNMX 2512245-SR	T8345	2.4	45	1.00	14.0	25	0.90	14.0	40	1.00	14.0	-	-	-	-	-	-	-	-
	T9325	2.4	80	1.00	14.0	45	0.90	14.0	75	1.00	14.0	-	-	-	-	-	-	-	-
	T9335	2.4	65	1.00	14.0	35	0.90	14.0	-	-	-	-	-	-	-	-	-	-	-

SNGA CER

	IC	D1	L	S
	[mm]	[mm]	[mm]	[mm]
1204	12.700	5.16	12.70	4.76

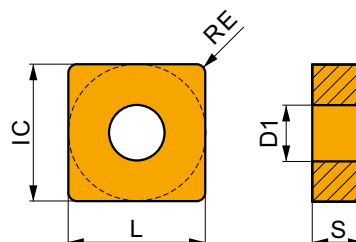

Suitability and starting values for cutting speed (vc), feed (f) and depth of cut (ap). Refer to our Machining Calculator app for further calculations.

Product	RE	P			M			K			N			S			H		
		vc	f	ap	vc	f	ap	vc	f	ap	vc	f	ap	vc	f	ap	vc	f	ap
	[mm]	[m/min]	[mm/rev]	[mm]	[m/min]	[mm/rev]	[mm]	[m/min]	[mm/rev]	[mm]	[m/min]	[mm/rev]	[mm]	[m/min]	[mm/rev]	[mm]	[m/min]	[mm/rev]	[mm]

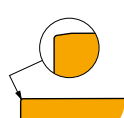

For machining with high speeds and continuous cuts.

SNGA 120408 T01025	TC100	0.8	-	-	-	-	-	-	575	0.20	2.0	-	-	-	-	-	-	-	-
SNGA 120412 T01020	TC100	1.2	-	-	-	-	-	-	565	0.25	2.0	-	-	-	-	-	-	-	-



SNGN CER



	IC [mm]	L [mm]	S [mm]
0903	9.525	9.525	3.18
1204	12.700	12.70	4.76
1207	12.700	12.70	7.94

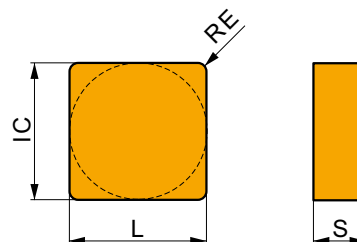

Suitability and starting values for cutting speed (vc), feed (f) and depth of cut (ap). Refer to our Machining Calculator app for further calculations.

Product	RE [mm]	P			M			K			N			S			H		
		vc [m/min]	f [mm/rev]	ap [mm]	vc [m/min]	f [mm/rev]	ap [mm]	vc [m/min]	f [mm/rev]	ap [mm]	vc [m/min]	f [mm/rev]	ap [mm]	vc [m/min]	f [mm/rev]	ap [mm]	vc [m/min]	f [mm/rev]	ap [mm]

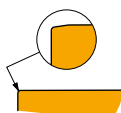

For machining with high speeds and continuous cuts.

SNGN 090308 T01020	TC100	0.8	–	–	–	–	–	–	☑	580	0.20	1.8	–	–	–	–	–	–	–
SNGN 090312 T01020	TC100	1.2	–	–	–	–	–	–	☑	565	0.25	1.8	–	–	–	–	–	–	–
SNGN 120404 T01020	TC100	0.4	–	–	–	–	–	–	☑	620	0.10	2.0	–	–	–	–	–	–	–
SNGN 120408 T01020	TC100	0.8	–	–	–	–	–	–	☑	575	0.20	2.0	–	–	–	–	–	–	–
SNGN 120708 T01020	TC100	0.8	–	–	–	–	–	–	☑	575	0.20	2.0	–	–	–	–	–	–	–
SNGN 120712 T01020	TC100	1.2	–	–	–	–	–	–	☑	565	0.25	2.0	–	–	–	–	–	–	–



DSBN(RL) EXT



PRAMET

D



External Double Clamp Holder with 75° Cutting Angle for SN.. Insert

External Right/Left hand double clamp tool holder with 75° cutting angle. Suited for longitudinal turning without shoulder, taper and chamfer turning with negative SN.. 12, 15 or 19 size inserts. Available in 20x20 up to 40x40 mm shanks. Body treated for longer tool life.

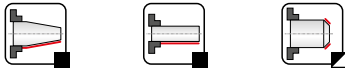
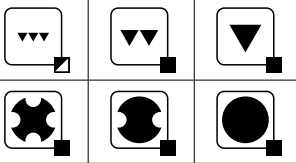
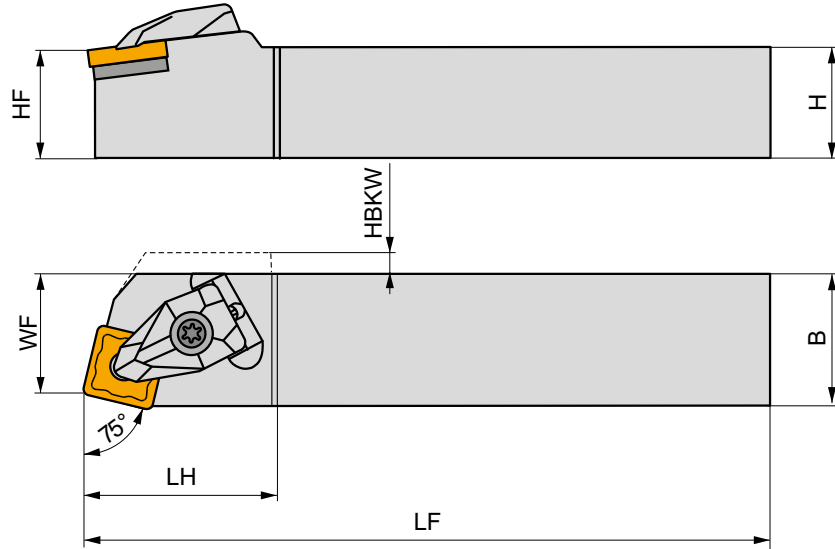
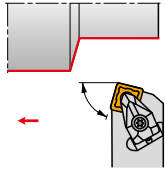

Product	H	B	HF	WF	LF	LH	HBKW	LAMS	GAMO	kg				
	[mm]	[mm]	[mm]	[mm]	[mm]	[mm]	[mm]	[°]	[°]					
R	DSBNR 2020 K 12	20	20	20	17	125	34.2	2.5	-6	-6	0.43	GI029	DS12	AT003
	DSBNR 2525 M 12	25	25	25	22	150	34.3	-	-6	-6	0.74	GI029	DS12	AT003
	DSBNR 2525 M 15	25	25	25	22	150	41.6	2	-6	-6	0.80	GI082	DS15	AT006
	DSBNR 3225 P 15	32	25	32	22	170	41.7	2	-6	-6	1.07	GI082	DS15	AT006
	DSBNR 3232 P 19	32	32	32	27	170	46.4	-	-6	-6	1.38	GI026	DS19	-
DSBNR 4040 S 19	40	40	40	35	250	46.5	-	-6	-6	3.18	GI026	DS19	-	
L	DSBNL 2525 M 12	25	25	25	22	150	34.3	-	-6	-6	0.74	GI029	DS12	AT003
	DSBNL 2525 M 15	25	25	25	22	150	41.6	2	-6	-6	0.80	GI082	DS15	AT006
	DSBNL 3225 P 15	32	25	32	22	170	41.7	2	-6	-6	1.16	GI082	DS15	AT006
	DSBNL 3232 P 19	32	32	32	27	170	46.4	-	-6	-6	1.38	GI026	DS19	-
	DSBNL 4040 S 19	40	40	40	35	250	46.5	-	-6	-6	3.18	GI026	DS19	-



GI026
GI029
GI082

SN.. 1906..
SN.. 1204..
SN.. 1506..



DS12
DS15
DS19

DCS 12
DCS 16
DCS 19

3.9
6.4
6.4





DSS 425-01
DSS 425-03
DSS 425-04

US 2002-T15P
US 2007-T20P
US 2007-T20P

FLAG T15P/3,5
-
-

-
LKT20P
LKT20P



			
AT003a	SN.. 1207..	-	DSS 425-02
AT006a	SN.. 1507..	-	DSS 425-05
AT003b	CER SN.N 1204..	DCS 12C4	-
AT003c	CER SN.A 1204..	DCS 12C2	-
AT006b	CER CN.N 1606..	DCS 16C4	-
AT006c	CER CN.A 1606..	DCS 16C2	-



DSDNN EXT

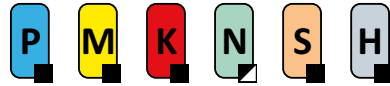

PRAMET

D



External Double Clamp Holder with 45° Cutting Angle for SN.. Insert

External neutral double clamp tool holder with 45° cutting angle. Suited for longitudinal turning without shoulder, copy, taper and chamfer turning with negative SN.. 12, 15, 19 or 25 size inserts. Available in 25x25 up to 40x40 mm shanks. Body treated for longer tool life.

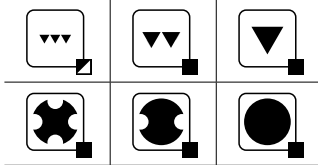
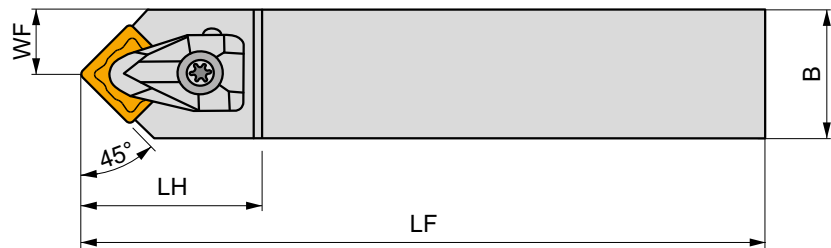
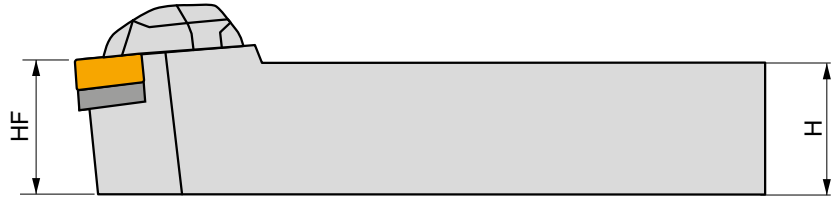
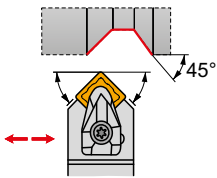

Product	H	B	HF	WF	LF	LH	LAMS	GAMO	kg				
	[mm]	[mm]	[mm]	[mm]	[mm]	[mm]	[°]	[°]					
N DSDNN 2525 M 12	25	25	25	12.8	150	36.5	-6	-6	0.74	GI029	DS12	AT003	
DSDNN 2525 M 15	25	25	25	12.8	150	44.8	-6	-6	0.76	GI082	DS15	AT006	
DSDNN 3232 P 19	32	32	32	16.5	170	49.5	-6	-6	1.36	GI026	DS19	-	
DSDNN 4040 S 25	40	40	40	21	250	57.2	-6	-6	3.13	GI027	DS25	-	

GI026		SN.. 1906..
GI027		SN.. 2507..
GI029		SN.. 1204..
GI082		SN.. 1506..

DS12	DCS 12	3.9	DSS 425-01	US 2002-T15P	FLAG T15P/3,5	-
DS15	DCS 16	6.4	DSS 425-03	US 2007-T20P	-	LKT20P
DS19	DCS 19	6.4	DSS 425-04	US 2007-T20P	-	LKT20P
DS25	DCS 25	9.5	DSS 425-07	US 2008-T25P	-	LKT25P

AT003a	SN.. 1207..	-	DSS 425-02
AT006a	SN.. 1507..	-	DSS 425-05
AT003b	CER SN.N 1204..	DCS 12C4	-
AT003c	CER SN.A 1204..	DCS 12C2	-
AT006b	CER CN.N 1606..	DCS 16C4	-
AT006c	CER CN.A 1606..	DCS 16C2	-



DSKN(RL) EXT



External Double Clamp Holder with 75° (Face) Cutting Angle for SN.. Insert

External Right/Left hand double clamp tool holder with 75° cutting angle. Suited for facing without shoulder and chamfering with SN.. 12.. or 19.. size inserts. Available in 25x25 up to 32x32 mm shank. Body treated for longer tool life.

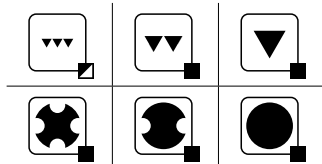
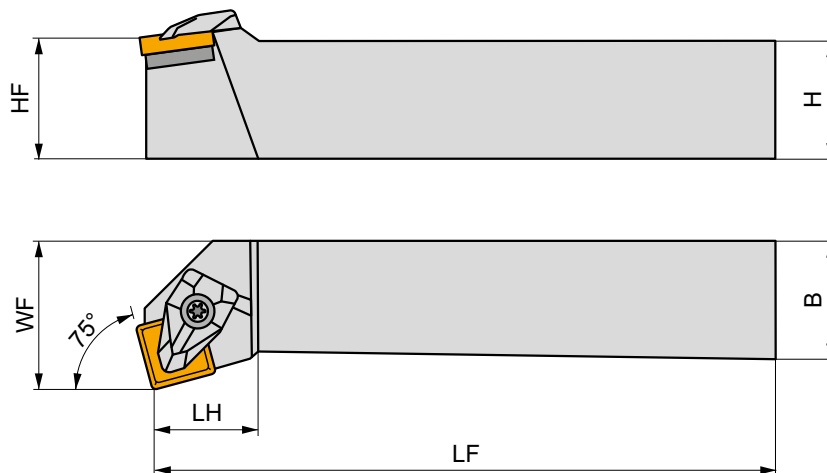
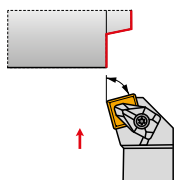

Product	H	B	HF	WF	LF	LH	LAMS	GAMO	kg			
	[mm]	[mm]	[mm]	[mm]	[mm]	[mm]	[°]	[°]				
R DSKNR 2525 M 12	25	25	25	32	150	23.6	-6	-6	0.79	G1029	DS12	AT003
DSKNR 3232 P 19	32	32	32	40	170	32.1	-6	-6	1.46	G1026	DS19	-
L DSKNL 2525 M 12	25	25	25	32	150	23.6	-6	-6	0.79	G1029	DS12	AT003
DSKNL 3232 P 19	32	32	32	40	170	32.1	-6	-6	1.46	G1026	DS19	-



G1026

SN.. 1906..

G1029

SN.. 1204..



DS12

DCS 12

3.9

DSS 425-01

US 2002-T15P

FLAG T15P/3,5

-

DS19

DCS 19

6.4

DSS 425-04

US 2007-T20P

-

LK T20P



AT003a

SN.. 1207..

-

DSS 425-02

AT003b

CER SN.N 1204..

DCS 12C4

-

AT003c

CER SN.A 1204..

DCS 12C2

-



DSSN(RL) EXT

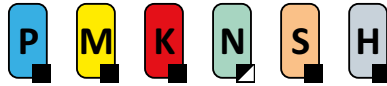

External Double Clamp Holder with 45° Cutting Angle for SN.. Insert

External Right/Left hand double clamp tool holder with 45° cutting angle. Suited for longitudinal and facing without shoulder, taper, copy turning and chamfering with negative SN.. 12, 15 or 19 size inserts. Available in 20x20 up to 40x40 mm shank. Body treated for longer tool life.

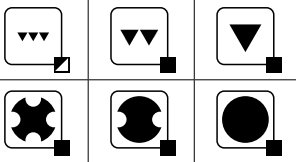
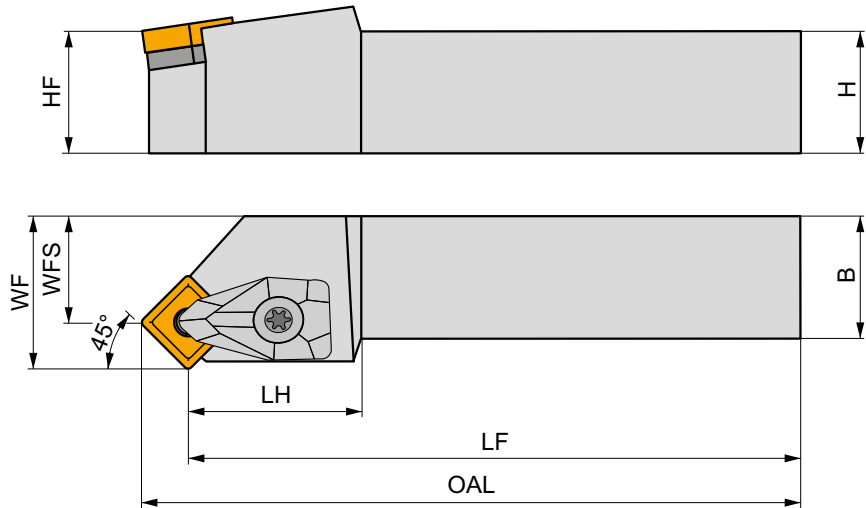
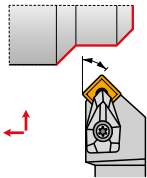

Product	H	B	HF	WF	WFS	LF	OAL	LH	LAMS	GAMO	kg				
	[mm]	[mm]	[mm]	[mm]	[mm]	[mm]	[mm]	[mm]	[°]	[°]					
R	DSSNR 2020 K 12	20	20	20	25	16.7	125	133.3	27.5	0	-8	0.45	GI029	DS12	AT003
	DSSNR 2525 M 12	25	25	25	32	23.7	150	158.3	27.5	0	-8	0.80	GI029	DS12	AT003
	DSSNR 2525 M 15	25	25	25	32	21.8	150	160.2	32	0	-8	0.83	GI082	DS15	AT006
	DSSNR 3225 P 15	32	25	32	32	21.8	170	180.2	34.9	0	-8	1.16	GI082	DS15	AT006
	DSSNR 3232 P 19	32	32	32	40	27.5	170	182.5	37	0	-8	1.48	GI026	DS19	-
	DSSNR 4040 S 19	40	40	40	50	37.5	250	262.5	37.7	0	-8	3.27	GI026	DS19	-
L	DSSNL 2020 K 12	20	20	20	25	16.7	125	133.3	27.5	0	-8	0.45	GI029	DS12	AT003
	DSSNL 2525 M 12	25	25	25	32	23.7	150	158.3	27.5	0	-8	0.19	GI029	DS12	AT003
	DSSNL 2525 M 15	25	25	25	32	21.8	150	160.2	32	0	-8	0.83	GI082	DS15	AT006
	DSSNL 3225 P 15	32	25	32	32	21.8	170	180.2	34.9	0	-8	1.16	GI082	DS15	AT006
	DSSNL 3232 P 19	32	32	32	40	27.5	170	182.5	37	0	-8	1.48	GI026	DS19	-
	DSSNL 4040 S 19	40	40	40	50	37.5	250	262.5	37.7	0	-8	3.27	GI026	DS19	-



GI026
GI029
GI082

SN.. 1906..
SN.. 1204..
SN.. 1506..



DS12
DS15
DS19

DCS 12
DCS 16
DCS 19

3.9
6.4
6.4

DSS 425-01
DSS 425-03
DSS 425-04

US 2002-T15P
US 2007-T20P
US 2007-T20P

FLAG T15P/3,5
-
-

-
LKT20P
LKT20P



AT003a
AT006a
AT003b
AT003c
AT006b
AT006c

SN.. 1207..
SN.. 1507..
CER SN.N 1204..
CER SN.A 1204..
CER CN.N 1606..
CER CN.A 1606..

-
-
DCS 12C4
DCS 12C2
DCS 16C4
DCS 16C2

DSS 425-02
DSS 425-05
-
-
-
-



PSBN(RL) EXT



PRAMET

P



External Lever Lock Holder with 75° Cutting Angle for SN.. Insert

External Right/Left hand lever lock tool holder with 75° cutting angle. Suited for longitudinal turning without shoulder, taper turning and chamfering with negative SN.. 12, 15, 19 or 25 size inserts. Available in 20x20 up to 50x50 mm shank. Body treated for longer tool life.

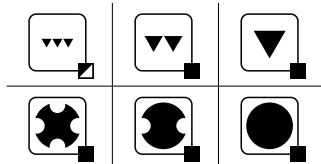
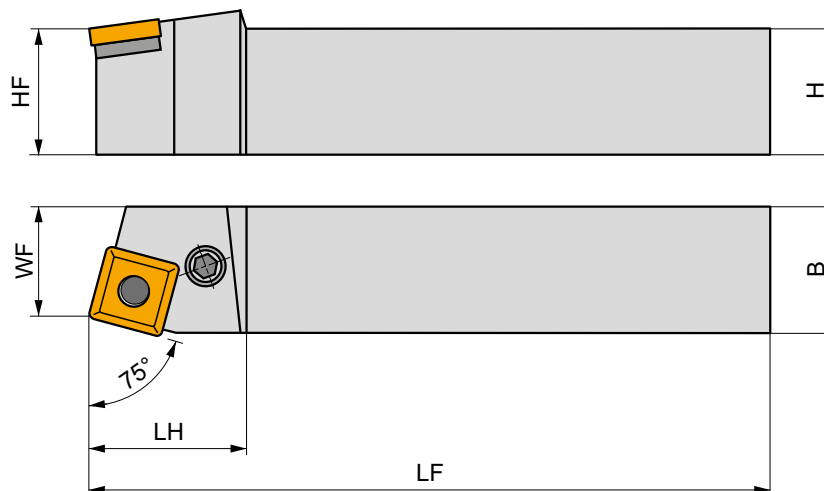
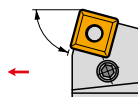

Product	⌀	B	HF	WF	LF	LH	LAMS	GAMO	kg			
	[mm]	[mm]	[mm]	[mm]	[mm]	[mm]	[°]	[°]				
R	PSBNR 2020 K 12	20	20	20	17	125	36	-6	-6	0.43	G1029	PS22
	PSBNR 2525 M 12	25	25	25	22	150	36	-6	-6	0.75	G1029	PS20
	PSBNR 3225 P 15	32	25	32	22	170	40	-6	-6	1.05	G1082	PS40
	PSBNR 3232 P 19	32	32	32	27	170	45	-6	-6	1.30	G1026	PS50
	PSBNR 4040 R 19	40	40	40	35	200	45	-6	-6	2.40	G1026	PS50
	PSBNR 4040 S 19	40	40	40	35	250	45	-6	-6	3.12	G1026	PS50
	PSBNR 4040 R 25	40	40	40	35	200	45	-6	-6	2.45	G1027	PS60
	PSBNR 4040 S 25	40	40	40	35	250	50	-6	-6	2.85	G1027	PS60
	PSBNR 4040 S 2509	40	40	40	35	250	50	-6	-6	2.50	G1040	PS70
	PSBNR 4040 S 2512-A	40	40	40	35	250	50	-6	-6	3.08	G1162	PS72
	PSBNR 5050 S 25	50	50	50	43	250	50	-6	-6	4.70	G1027	PS60
	PSBNR 5050 T 25	50	50	50	43	300	50	-6	-6	5.83	G1027	PS60
	PSBNR 5050 T 2509	50	50	50	43	300	50	-6	-6	5.50	G1040	PS70
	PSBNR 5050 T 2512-A	50	50	50	43	300	50	-6	-6	5.83	G1162	PS72
	L	PSBNL 2020 K 12	20	20	20	17	125	36	-6	-6	0.42	G1029
PSBNL 2525 M 12		25	25	25	22	150	36	-6	-6	0.75	G1029	PS20
PSBNL 3225 P 15		32	25	32	22	170	40	-6	-6	1.05	G1082	PS40
PSBNL 3232 P 19		32	32	32	27	170	45	-6	-6	1.36	G1026	PS50
PSBNL 4040 R 19		40	40	40	35	200	45	-6	-6	2.50	G1026	PS50
PSBNL 4040 S 19		40	40	40	35	250	45	-6	-6	3.13	G1026	PS50
PSBNL 4040 R 25		40	40	40	35	200	45	-6	-6	2.45	G1027	PS60
PSBNL 4040 S 25		40	40	40	35	250	50	-6	-6	3.10	G1027	PS60
PSBNL 4040 S 2509		40	40	40	35	250	50	-6	-6	2.50	G1040	PS70
PSBNL 4040 S 2512-A		40	40	40	35	250	50	-6	-6	3.11	G1162	PS72
PSBNL 5050 S 25		50	50	50	43	250	50	-6	-6	4.70	G1027	PS60
PSBNL 5050 T 25		50	50	50	43	300	50	-6	-6	5.84	G1027	PS60
PSBNL 5050 T 2509		50	50	50	43	300	50	-6	-6	5.80	G1040	PS70



Product	H	B	HF	WF	LF	LH	LAMS	GAMO			
	[mm]	[mm]	[mm]	[mm]	[mm]	[mm]	[°]	[°]			
L PSBNL 5050 T 2512-A	50	50	50	43	300	50	-6	-6	5.82	G162	PS72

GI026	SN.. 1906..
GI027	SN.. 2507..
GI029	SN.. 1204..
GI040	SN.. 2509..
GI082	SN.. 1506..
GI162	SN.. 2512..

PS20	SNU 120312	PU 02	US 35	6.0	M 8x1	22.5	NT 05	MT 05	HXK 4
PS22	SNU 120312	PU 02	US 42	6.0	M 8x1	21	NT 05	MT 05	HXK 4
PS40	SNU 150312	PU 04	US 36	6.0	M 8x1	26	NT 07	MT 07	HXK 4
PS50	SNU 190416	PU 05	US 38	8.0	M 10x1	29	NT 06	MT 06	HXK 5
PS60	SNU 250624	PU 06	US 39	8.0	M 10x1	33	NT 08	MT 08	HXK 5
PS70	SNU 250624	PU 06	US 47	8.0	M 12x1	36	NT 08	MT 08	HXK 5
PS72	SNU 250624	PU 10-N	PS 12040	8.0	M 12x1	40	NT 08	MT 08	HXK 5



PSDNN EXT



PRAMET

P



External Lever Lock Holder with 45° Cutting Angle for SN.. Insert

External neutral lever lock tool holder with 45° cutting angle. Suited for longitudinal turning without shoulder, copy and taper turning and chamfering with negative SN.. 12, 15, 19 or 25 size inserts. Available in 20x20 up to 50x50 mm shank. Body treated for longer tool life.

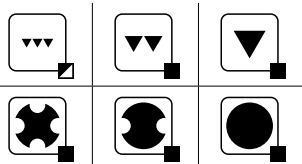
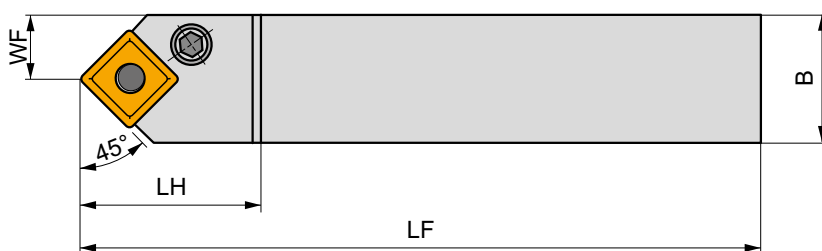
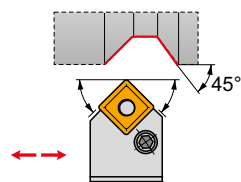

Product	H	B	HF	WF	LF	LH	LAMS	GAMO	kg		
	[mm]	[mm]	[mm]	[mm]	[mm]	[mm]	[°]	[°]			
PSDNN 2020 K 12	20	20	20	10	125	36	-6	-6	0.42	GI029	PS22
PSDNN 2525 M 12	25	25	25	12.5	150	36	-6	-6	0.68	GI029	PS20
PSDNN 3232 P 15	32	32	32	16	170	40	-6	-6	1.32	GI082	PS40
PSDNN 3232 P 19	32	32	32	16	170	45	-6	-6	1.25	GI026	PS50
PSDNN 4040 S 19	40	40	40	20	250	45	-6	-6	3.05	GI026	PS50
PSDNN 4040 S 25	40	40	40	20	250	50	-6	-6	3.02	GI027	PS60
PSDNN 5050 T 25	50	50	50	25	300	50	-6	-6	5.65	GI027	PS60



GI026
GI027
GI029
GI082

SN.. 1906..
SN.. 2507..
SN.. 1204..
SN.. 1506..



PS20	SNU 120312	PU 02	US 35	6.0	M 8x1	22.5	NT 05	MT 05	HXK 4
PS22	SNU 120312	PU 02	US 42	6.0	M 8x1	21	NT 05	MT 05	HXK 4
PS40	SNU 150312	PU 04	US 36	6.0	M 8x1	26	NT 07	MT 07	HXK 4
PS50	SNU 190416	PU 05	US 38	8.0	M 10x1	29	NT 06	MT 06	HXK 5
PS60	SNU 250624	PU 06	US 39	8.0	M 10x1	33	NT 08	MT 08	HXK 5



PSKN(RL) EXT



External Lever Lock Holder, 75° (Face Turning) Cutting Angle for SN.. Insert

External Right/Left hand lever lock tool holder with 75° cutting angle. Suited for face turning without shoulder and chamfering with negative SN.. 12, 15, 19 or 25 size inserts. Available in 20x20 up to 50x50 mm shank. Body treated for longer tool life.

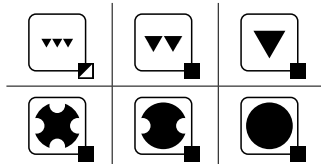
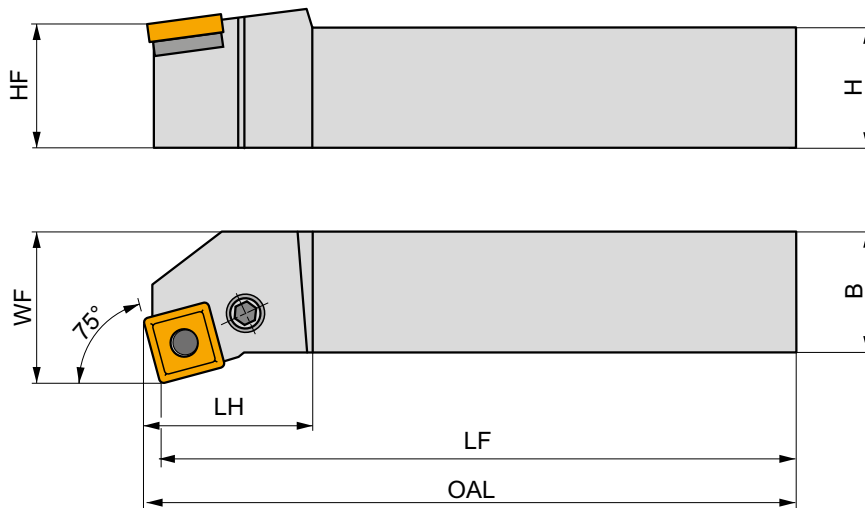
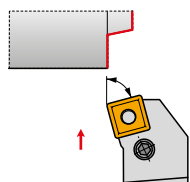

	Product	H	B	HF	WF	LF	OAL	LH	LAMS	GAMO	kg		
		[mm]	[mm]	[mm]	[mm]	[mm]	[mm]	[mm]	[mm]	[°]			
R	PSKNR 2020 K 12	20	20	20	25	125	128.1	36	-6	-6	0.43	GI029	PS22
	PSKNR 2525 M 12	25	25	25	32	150	153.1	36	-6	-6	0.79	GI029	PS20
	PSKNR 3225 P 15	32	25	32	32	170	173.9	40	-6	-6	0.40	GI082	PS40
	PSKNR 3232 P 19	32	32	32	40	170	174.6	45	-6	-6	1.40	GI026	PS50
	PSKNR 4040 S 19	40	40	40	50	250	254.6	45	-6	-6	3.25	GI026	PS50
	PSKNR 4040 S 25	40	40	40	50	250	256.5	50	-6	-6	3.40	GI027	PS60
	PSKNR 5050 T 25	50	50	50	60	300	306.5	50	-6	-6	6.05	GI027	PS60
	PSKNR 5050 T 2509	50	50	50	60	300	306.5	50	-6	-6	6.20	GI040	PS70
L	PSKNL 2020 K 12	20	20	20	25	125	128.1	36	-6	-6	0.43	GI029	PS22
	PSKNL 2525 M 12	25	25	25	32	150	153.1	36	-6	-6	0.79	GI029	PS20
	PSKNL 3225 P 15	32	25	32	32	170	173.9	40	-6	-6	1.05	GI082	PS40
	PSKNL 3232 P 19	32	32	32	40	170	174.6	45	-6	-6	1.40	GI026	PS50
	PSKNL 4040 S 19	40	40	40	50	250	254.6	45	-6	-6	3.26	GI026	PS50
	PSKNL 4040 S 25	40	40	40	50	250	256.5	50	-6	-6	3.40	GI027	PS60
	PSKNL 5050 T 25	50	50	50	60	300	306.5	50	-6	-6	6.00	GI027	PS60
	PSKNL 5050 T 2509	50	50	50	60	300	306.5	50	-6	-6	6.20	GI040	PS70



GI026

SN.. 1906..

GI027

SN.. 2507..

GI029

SN.. 1204..











GI040

SN.. 2509..

GI082

SN.. 1506..



				 Nm					
PS20	SNU 120312	PU 02	US 35	6.0	M 8x1	22.5	NT 05	MT 05	HXX 4
PS22	SNU 120312	PU 02	US 42	6.0	M 8x1	21	NT 05	MT 05	HXX 4
PS40	SNU 150312	PU 04	US 36	6.0	M 8x1	26	NT 07	MT 07	HXX 4
PS50	SNU 190416	PU 05	US 38	8.0	M 10x1	29	NT 06	MT 06	HXX 5
PS60	SNU 250624	PU 06	US 39	8.0	M 10x1	33	NT 08	MT 08	HXX 5
PS70	SNU 250624	PU 06	US 47	8.0	M 12x1	36	NT 08	MT 08	HXX 5



PSSN(RL) EXT



External Lever Lock Holder with 45° Cutting Angle for SN.. Insert

External Right/Left hand lever lock tool holder with 45° cutting angle. Suited for longitudinal and face turning without shoulder, copy and taper turning and chamfering with negative SN.. 12, 15, 19 or 25 size inserts. Available in 20x20 up to 50x50 mm shank. Body treated for longer tool life.

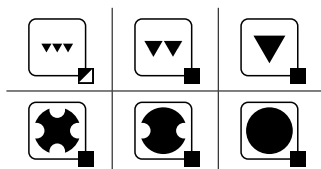
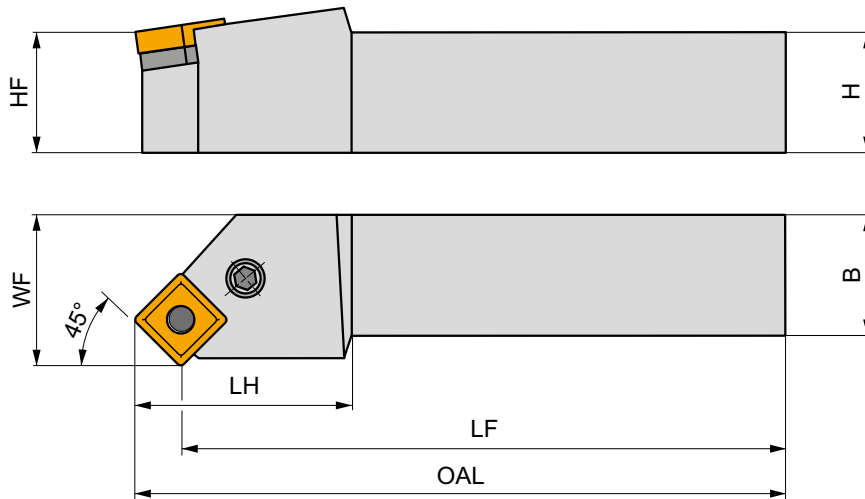
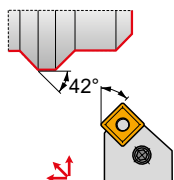

Product		H	B	HF	WF	LF	OAL	LH	LAMS	GAMO	kg		
		[mm]	[mm]	[mm]	[mm]	[mm]	[mm]	[mm]	[°]	[°]			
R	PSSNR 2020 K 12	20	20	20	25	125	133.3	36	0	-8	0.41	GI029	PS22
	PSSNR 2525 M 12	25	25	25	32	150	158.3	36	0	-8	0.75	GI029	PS20
	PSSNR 3225 P 15	32	25	32	32	170	180.2	40	0	-8	1.13	GI082	PS40
	PSSNR 3232 P 19	32	32	32	40	170	182.5	45	0	-8	1.34	GI026	PS50
	PSSNR 4040 R 19	40	40	40	50	200	212.5	45	0	-8	2.50	GI026	PS50
	PSSNR 5050 T 25	50	50	50	60	300	316	50	0	-8	6.00	GI027	PS60
	PSSNR 5050 T 2509	50	50	50	60	300	316	50	0	-8	6.05	GI040	PS70
L	PSSNL 2020 K 12	20	20	20	25	125	133.3	36	0	-8	0.41	GI029	PS22
	PSSNL 2525 M 12	25	25	25	32	150	158.3	36	0	-8	0.67	GI029	PS20
	PSSNL 3225 P 15	32	25	32	32	170	180.2	40	0	-8	1.15	GI082	PS40
	PSSNL 3232 P 19	32	32	32	40	170	182.5	45	0	-8	1.44	GI026	PS50
	PSSNL 4040 R 19	40	40	40	50	200	212.5	45	0	-8	2.58	GI026	PS50
	PSSNL 5050 T 25	50	50	50	60	300	316	50	0	-8	6.00	GI027	PS60
	PSSNL 5050 T 2509	50	50	50	60	300	316	50	0	-8	6.08	GI040	PS70



GI026	SN.. 1906..
GI027	SN.. 2507..
GI029	SN.. 1204..
GI040	SN.. 2509..
GI082	SN.. 1506..



PS20	SNU 120312	PU 02	US 35	6.0	M 8x1	22.5	NT 05	MT 05	HXK 4
PS22	SNU 120312	PU 02	US 42	6.0	M 8x1	21	NT 05	MT 05	HXK 4
PS40	SNU 150312	PU 04	US 36	6.0	M 8x1	26	NT 07	MT 07	HXK 4
PS50	SNU 190416	PU 05	US 38	8.0	M 10x1	29	NT 06	MT 06	HXK 5
PS60	SNU 250624	PU 06	US 39	8.0	M 10x1	33	NT 08	MT 08	HXK 5
PS70	SNU 250624	PU 06	US 47	8.0	M 12x1	36	NT 08	MT 08	HXK 5



C.-DSDNN EXT



External PSC Quick Change Tool, Double Clamp, 45° Cutting Angle, SN.. Insert

External neutral double clamp tool, through coolant, with 45° cutting angle for longitudinal turning without shoulder, copy turning, taper turning and chamfer turning with negative SN.. 12 or 19 size inserts. Available with PSC (Polygon Shank Coupling) C4 up to C6 shank. Body treated for longer tool life.

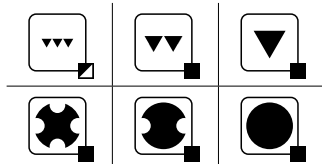
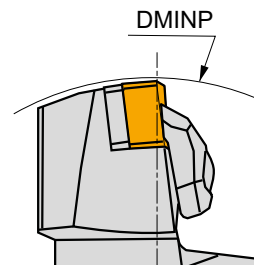
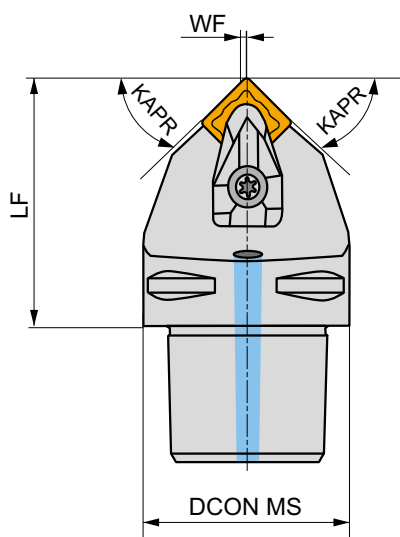
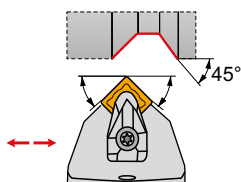

Product	DCON MS	DMINP	WF	LF	KAPR	LAMS	GAMO					
	[mm]	[mm]	[mm]	[mm]	[°]	[°]	[°]					
N C4-DSDNN-00050-12	40	140	0.3	50	45	-6	-6	✓	0.39	GI029	C-DS12-2	AT003
C5-DSDNN-00060-12	50	165	0.3	60	45	-6	-6	✓	0.69	GI029	C-DS12-2	AT003
C6-DSDNN-00070-19	63	195	0.5	70	45	-6	-6	✓	1.28	GI026	C-DS19	-

GI026			SN.. 1906..
GI029			SN.. 1204..

C-DS12-2	DCS 12	3.9	DSS 425-01	US 2002-T15P	FLAG T15P/3,5	-	CN 045-01
C-DS19	DCS 19	6.4	DSS 425-04	US 2007-T20P	-	LKT20P	CN 045-01

AT003a	SN.. 1207..	-	DSS 425-02
AT003b	CER SN.N 1204..	DCS 12C4	-
AT003c	CER SN.A 1204..	DCS 12C2	-



C.-DSKN(RL) EXT

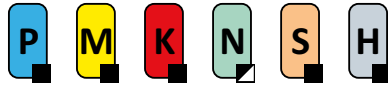

PRAMET

D



Ext. PSC Quick Change Tool, Double Clamp, 75° (Face) Cutting Angle, SN.. Ins

External Right/Left hand double clamp tool, through coolant, with 75° cutting angle for face turning without shoulder and chamfering with negative SN.. 12.. size inserts. Available with PSC (Polygon Shank Coupling) C4. Body treated for longer tool life.

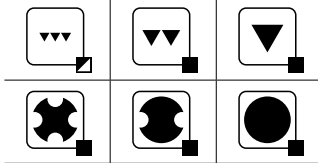
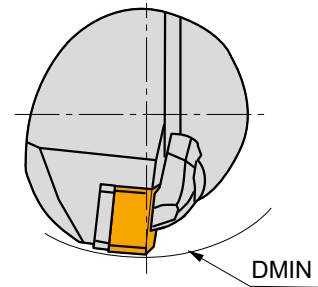
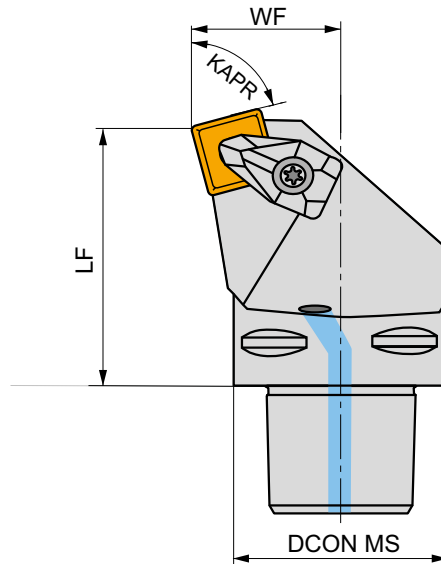
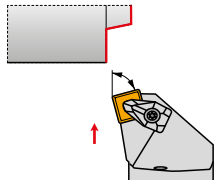

Product	DCON MS [mm]	DMIN [mm]	WF [mm]	LF [mm]	KAPR [°]	LAMS [°]	GAMO [°]		kg			
R C4-DSKNR-27050-12	40	110	27	50	75	-6	-6	✓	0.46	GI029	C-DS12-1	AT003
L C4-DSKNL-27050-12	40	110	27	50	75	-6	-6	✓	0.46	GI029	C-DS12-1	AT003



GI029



SN.. 1204..



C-DS12-1



DCS 12



3.9



DSS 425-01



US 2002-T15P



FLAG T15P/3,5



CN 034-01



AT003a



SN.. 1207..



-



DSS 425-02

AT003b

CER SN.N 1204..

DCS 12C4

AT003c

CER SN.A 1204..

DCS 12C2

-



C.-DSRN(RL) EXT



External PSC Quick Change Tool, Double Clamp, 75° Cutting Angle, SN.. Insert

External Right/Left hand double clamp tool, through coolant, with 75° cutting angle for longitudinal turning without shoulder, taper turning and chamfering with negative SN.. 12 or 19 size inserts. Available with PSC (Polygon Shank Coupling) C4 up to C6 shank. Body treated for longer tool life.

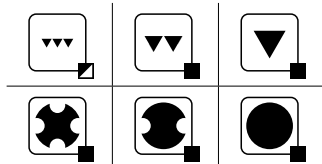
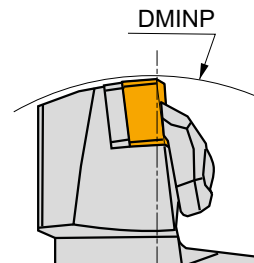
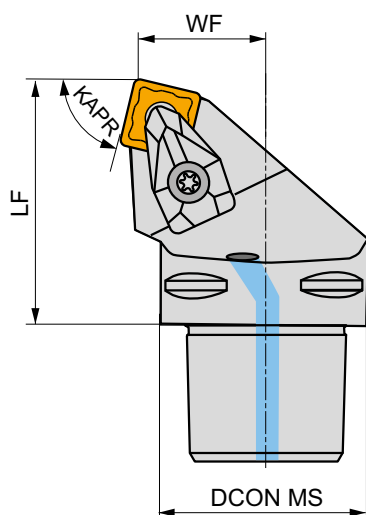
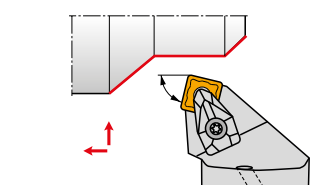

Product	DCON MS	DMINP	WF	LF	KAPR	LAMS	GAMO						
	[mm]	[mm]	[mm]	[mm]	[°]	[°]	[°]						
R	C4-DSRNR-22050-12	40	140	22	50	75	-6	-6	✓	0.40	G1029	C-DS12-1	AT003
	C6-DSRNR-35065-19	63	190	35	65	75	-6	-6	✓	1.30	G1026	C-DS19	-
L	C4-DSRNL-22050-12	40	140	22	50	75	-6	-6	✓	0.42	G1029	C-DS12-1	AT003
	C6-DSRNL-35065-19	63	190	35	65	75	-6	-6	✓	1.30	G1026	C-DS19	-

G1026		SN.. 1906..	
G1029		SN.. 1204..	

C-DS12-1	DCS 12	3.9	DSS 425-01	US 2002-T15P	FLAG T15P/3,5	-	CN 034-01
C-DS19	DCS 19	6.4	DSS 425-04	US 2007-T20P	-	LK T20P	CN 045-01

AT003a	SN.. 1207..	-	DSS 425-02
AT003b	CER SN.N 1204..	DCS 12C4	-
AT003c	CER SN.A 1204..	DCS 12C2	-



C.-DSSN(RL) EXT

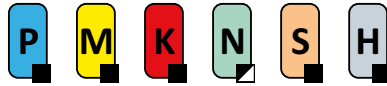

External PSC Quick Change Tool, Double Clamp, 45° Cutting Angle, SN.. Insert

External Right/Left hand double clamp tool, through coolant, with 45° cutting angle for longitudinal and face turning without shoulder, taper turning, copy turning and chamfering with negative SN.. 12, 15 or 19 size insert. Available with PSC (Polygon Shank Coupling) C4 and C5 shank. Body treated for longer tool life.

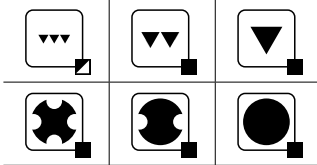
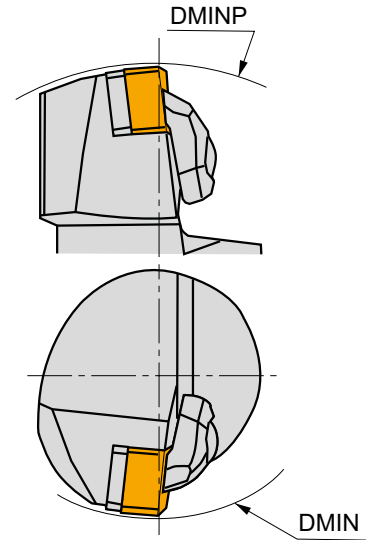
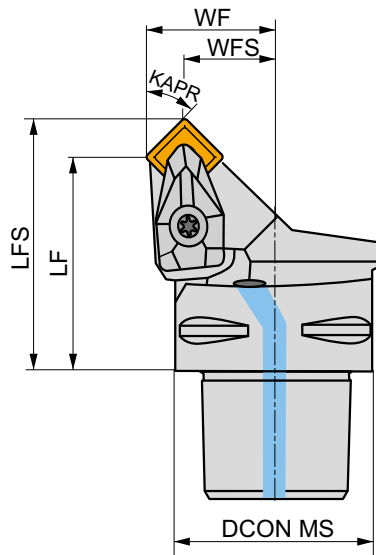
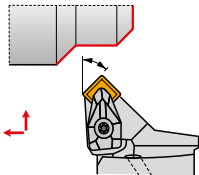

Product	DCON MS	DMIN	DMINP	WF	WFS	LF	LFS	KAPR	LAMS	GAMO					
R C4-DSSNR-27042-12	40	110	140	27	18.7	42	50.3	45	0	-8	✓	0.38	GI029	C-DS12-1	AT003
	C5-DSSNR-35052-12	50	110	165	35	26.7	52	60.3	45	0	-8	✓	0.68	GI029	C-DS12-3
L C4-DSSNL-27042-12	40	110	140	27	18.7	42	50.3	45	0	-8	✓	0.36	GI029	C-DS12-1	AT003
	C5-DSSNL-35052-12	50	110	165	35	26.7	52	60.3	45	0	-8	✓	0.69	GI029	C-DS12-3



GI029



SN.. 1204..



C-DS12-1



DCS 12



Nm

3.9



DSS 425-01



US 2002-T15P



FLAG T15P/3,5



CN 034-01

C-DS12-3

DCS 12

3.9

DSS 425-01

US 2002-T15P

FLAG T15P/3,5

CN 034-02



AT003a



SN.. 1207..



DCS 12C4



DSS 425-02

AT003b

CER SN.N 1204..

DCS 12C2

AT003c

CER SN.A 1204..

-

-



KHP-SBN(RL)



PRAMET

P



Modular KHP Lever Lock Turning Cartridge, 75° Cutting Angle for SN.. Inserts

Dovetailed Right/Left hand lever lock turning cartridge, 75° Cutting Angle, for mounting on DKH tool holder shank. Suited for heavy longitudinal turning without shoulder, face turning, taper and chamfer turning with negative SN.. 19 or 25 inserts. Tool holder treated for longer tool life.

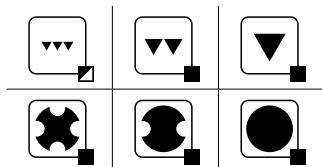
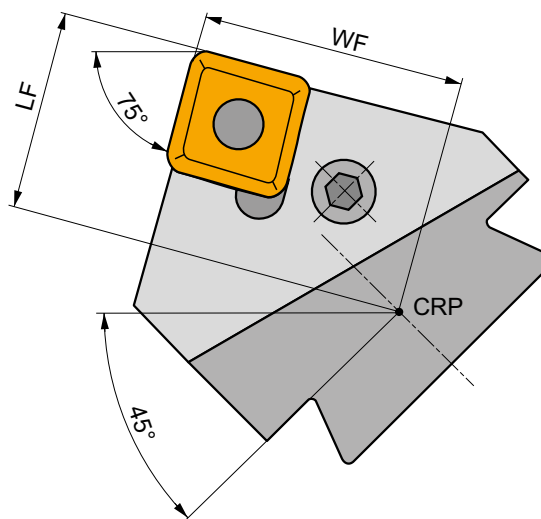
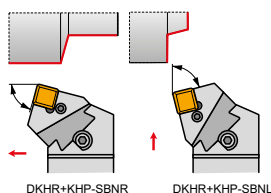

Product	WF	LF	LAMS	GAMO	kg	GI	PS	
	[mm]	[mm]	[°]	[°]				
R	KHP-SBNR 19	47	36	-6	-6	1.51	GI026	PS50
	KHP-SBNR 25	47	36	-6	-6	1.47	GI027	PS60
	KHP-SBNR 2509	47	36	-6	-6	1.45	GI040	PS70
	KHP-SBNR 2512-A	47	36	-6	-6	1.71	GI162	PS72
L	KHP-SBNL 19	47	36	-6	-6	1.96	GI026	PS50
	KHP-SBNL 25	47	36	-6	-6	1.48	GI027	PS60
	KHP-SBNL 2509	47	36	-6	-6	1.46	GI040	PS70
	KHP-SBNL 2512-A	47	36	-6	-6	1.45	GI162	PS72

GI	SN..
GI026	SN.. 1906..
GI027	SN.. 2507..
GI040	SN.. 2509..
GI162	SN.. 2512..

PS	SNU	PU	US	Nm	M	mm	NT	MT	HXX
PS50	SNU 190416	PU 05	US 38	8.0	M 10x1	29	NT 06	MT 06	HXX 5
PS60	SNU 250624	PU 06	US 39	8.0	M 10x1	33	NT 08	MT 08	HXX 5
PS70	SNU 250624	PU 06	US 47	8.0	M 12x1	36	NT 08	MT 08	HXX 5
PS72	SNU 250624	PU 10-N	PS 12040	8.0	M 12x1	40	NT 08	MT 08	HXX 5



KHP-SSN(RL)



PRAMET

P



Modular KHP Lever Lock Turning Cartridge, 45° Cutting Angle for SN.. Inserts

Dovetailed Right/Left hand lever lock turning cartridge, 45° Cutting Angle, for mounting on DKH tool holder shank. Suited for heavy longitudinal turning without shoulder, face turning, copy, taper and chamfer turning with negative SN.. 19 or 25 inserts. Tool holder treated for longer tool life.

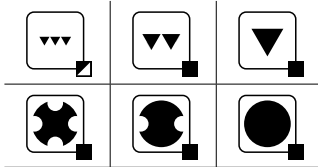
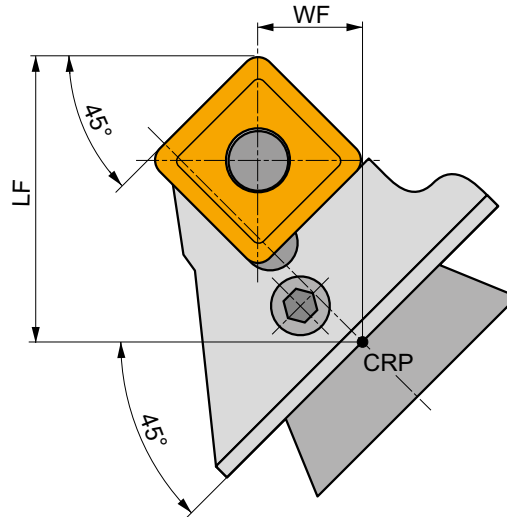
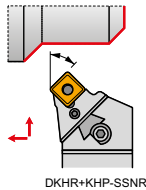

Product	WF	LF	LAMS	GAMO	kg		
	[mm]	[mm]	[°]	[°]			
R KHP-SSNR 19	15	45	-6	-6	1.28	GI026	PS50
	KHP-SSNR 25	15	45	-6	-6	0.98	GI027
L KHP-SSNL 19	15	45	-6	-6	1.03	GI026	PS50
	KHP-SSNL 25	15	45	-6	-6	1.30	GI027

GI026		SN.. 1906..
GI027		SN.. 2507..

PS50	SNU 190416	PU 05	US 38	8.0	M 10x1	29	NT 06	MT 06	HXX 5
PS60	SNU 250624	PU 06	US 39	8.0	M 10x1	33	NT 08	MT 08	HXX 5



DKH(RL)



External Tool Holder Shank for KHP/KHS Heavy Turning Cartridges

Dovetailed Right/Left hand modular tool shank for KHP/KHS cartridges. Suited for heavy turning applications. Available with shank size 40x50 up to 60x80 mm. Body treated for longer tool life.

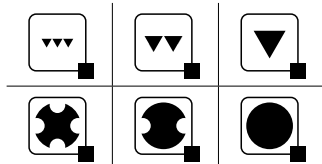
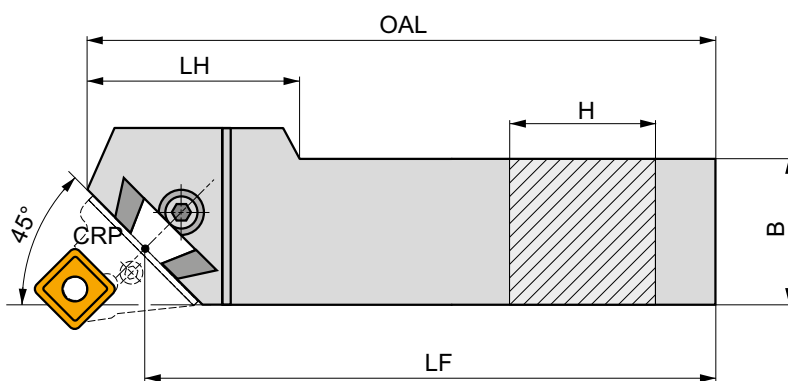
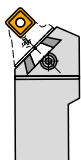

	Product	H	B	LF	OAL	LH	kg		
		[mm]	[mm]	[mm]	[mm]	[mm]			
R	DKHR 4050 V	40	50	400	425	100	7.10	GI098	DKH10
	DKHR 5060 W	50	60	450	475	110	11.30	GI098	DKH10
	DKHR 6080 W-A	60	80	450	485	90	19.65	GI098	DKH10
L	DKHL 4050 V	40	50	400	425	100	7.10	GI098	DKH10
	DKHL 5060 W	50	60	450	475	110	11.30	GI098	DKH10
	DKHL 6080 W-A	60	80	450	485	90	19.28	GI098	DKH10

GI098	KHP	KHS

DKH10	SR 14	HXK 10



PSKN(RL) INT



Internal Lever Lock Boring Bar with 75° Cutting Angle for SN.. Insert

Internal Right/Left hand lever lock boring bar, through coolant, 75° cutting angle for SN.. 12, 15 and 19 inserts. Minimum internal turning diameter Ø40 mm. For internal taper and longitudinal turning without shoulder and chamfer turning. Available with shank size Ø32 up to Ø60 mm. Body treated for longer tool life.

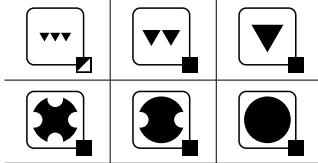
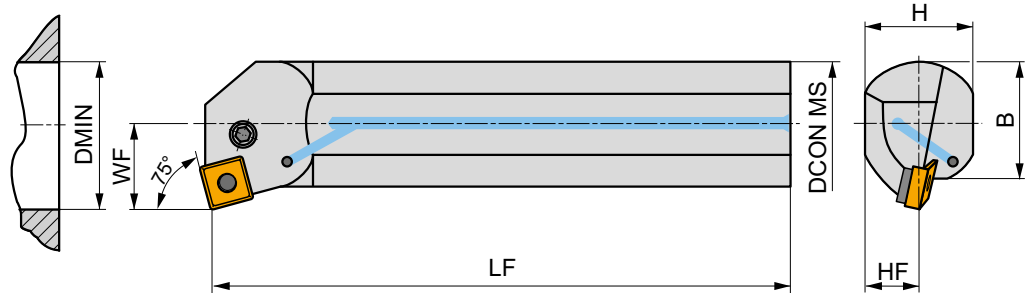
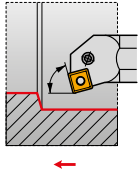

Product	DCON MS [mm]	DMIN [mm]	WF [mm]	H [mm]	B [mm]	LF [mm]	LAMS [°]	GAMO [°]					
R	A32S-PSKNR 12	32	40	22	30	30	250	-12	-6	✓	1.50	GI029	PS21
	A40T-PSKNR 15	40	50	27	38	38	300	-12	-6	✓	2.90	GI082	PS41
	A50U-PSKNR 15	50	63	35	47	48.5	350	-12	-6	✓	5.20	GI082	PS40
	A50U-PSKNR 19	50	63	35	47	48.5	350	-12	-6	✓	5.20	GI026	PS50
	A60V-PSKNR 19	60	80	43	57	58.5	400	-12	-6	✓	8.70	GI026	PS50
L	A32S-PSKNL 12	32	40	22	30	30	250	-12	-6	✓	1.40	GI029	PS21
	A40T-PSKNL 15	40	50	27	38	38	300	-12	-6	✓	2.90	GI082	PS41
	A50U-PSKNL 15	50	63	35	47	48.5	350	-12	-6	✓	5.20	GI082	PS40
	A50U-PSKNL 19	50	63	35	47	48.5	350	-12	-6	✓	5.20	GI026	PS50



GI026

SN.. 1906..

GI029

SN.. 1204..

GI082

SN.. 1506..



PS21

SNU 120312

PU 02

US 41

6.0

M 8x1

17

NT 05

MT 05

HXK 4

PS40

SNU 150312

PU 04

US 36

6.0

M 8x1

26

NT 07

MT 07

HXK 4

PS41

SNU 150312

PU 04

US 40

6.0

M 8x1

20.5

NT 07

MT 07

HXK 4

PS50

SNU 190416

PU 05

US 38

8.0

M 10x1

29

NT 06

MT 06

HXK 5



TN

16/ 22/ 27/ 33

CARBIDE INSERTS

TNMA	TNMG	TNMM
334	335	342

CER AND CBN INSERTS

TNGA CER	TNGN CER	TNGA CBN
343	344	344

MATCH THE RIGHT SIZE (example)

Insert	Tool Holder
TNMM 160412E-OR	DTFNR 2525 M 16

ISO TURNING – EXTERNAL

<p>DTFN(RL) EXT</p> <p>90°</p> <p>TN..</p> <p>16 22</p> <p>20×20 25×25</p> <p> 345</p> <p> 334 – 344</p>	<p>DTGN(RL) EXT</p> <p>90°</p> <p>TN..</p> <p>16 22</p> <p>20×20 32×25</p> <p> 346</p> <p> 334 – 344</p>	<p>MTJN(RL) EXT</p> <p>93°</p> <p>TN..</p> <p>16 22</p> <p>16×16 32×32</p> <p> 347</p> <p> 334 – 344</p>	<p>PTFN(RL) EXT</p> <p>90°</p> <p>TN..</p> <p>16 22 27</p> <p>16×16 40×40</p> <p> 348</p> <p> 334 – 344</p>
<p>PTGN(RL) EXT</p> <p>90°</p> <p>TN..</p> <p>16 22 27</p> <p>16×16 40×40</p> <p> 349</p> <p> 334 – 344</p>	<p>PPTN(RL) EXT</p> <p>60°</p> <p>TN..</p> <p>16 22</p> <p>20×20 32×25</p> <p> 350</p> <p> 334 – 344</p>	<p>C.-DTJN(RL) EXT</p> <p>93°</p> <p>TN..</p> <p>16</p> <p>C4 C5</p> <p> 351</p> <p> 334 – 344</p>	



TN

16/ 22/ 27/ 33

ISO TURNING – INTERNAL

DTFN(RL) INT		PTFN(RL) INT		C.-DTFN(RL) INT	
90°	TN..	90°	TN..	91°	TN..
	16 22		16 22		16
352	334 – 344	353	334 – 344	354	334 – 344



TNMA

	IC	D1	L	S
	[mm]	[mm]	[mm]	[mm]
1604	9.525	3.81	16.50	4.76
2204	12.700	5.16	22.00	4.76

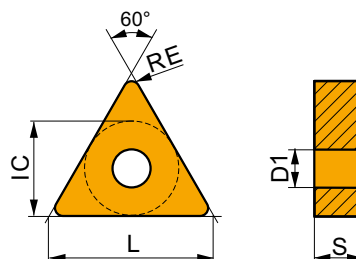

Suitability and starting values for cutting speed (vc), feed (f) and depth of cut (ap). Refer to our Machining Calculator app for further calculations.

Product	RE	P			M			K			N			S			H		
		vc	f	ap	vc	f	ap	vc	f	ap	vc	f	ap	vc	f	ap	vc	f	ap
	[mm]	[m/min]	[mm/rev]	[mm]	[m/min]	[mm/rev]	[mm]	[m/min]	[mm/rev]	[mm]	[m/min]	[mm/rev]	[mm]	[m/min]	[mm/rev]	[mm]	[m/min]	[mm/rev]	[mm]

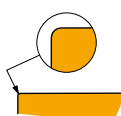

For fine-finish to semi-rough machining, and continuous to slightly interrupted cuts.

TNMA 160404	T5305	0.4	-	-	-	-	-	-	220	0.10	1.5	-	-	-	-	-	-	45	0.15	1.0
	T5315	0.4	-	-	-	-	-	-	190	0.10	1.5	-	-	-	-	-	-	40	0.15	1.0
TNMA 160408	T5305	0.8	-	-	-	-	-	-	205	0.20	1.5	-	-	-	-	-	-	40	0.15	1.0
	T5315	0.8	-	-	-	-	-	-	180	0.20	1.5	-	-	-	-	-	-	35	0.15	1.0
	T6310	0.8	-	-	-	-	-	-	90	0.20	1.5	-	-	-	-	-	-	20	0.15	1.0
TNMA 160412	T5305	1.2	-	-	-	-	-	-	215	0.20	1.5	-	-	-	-	-	-	45	0.15	1.0
	T5315	1.2	-	-	-	-	-	-	190	0.20	1.5	-	-	-	-	-	-	40	0.15	1.0
TNMA 220408	T5305	0.8	-	-	-	-	-	-	195	0.20	2.0	-	-	-	-	-	-	40	0.15	1.0
	T5315	0.8	-	-	-	-	-	-	175	0.20	2.0	-	-	-	-	-	-	35	0.15	1.0
	T6310	0.8	-	-	-	-	-	-	90	0.20	2.0	-	-	-	-	-	-	20	0.15	1.0
TNMA 220412	T5305	1.2	-	-	-	-	-	-	205	0.20	2.0	-	-	-	-	-	-	40	0.15	1.0
	T5315	1.2	-	-	-	-	-	-	185	0.20	2.0	-	-	-	-	-	-	35	0.15	1.0

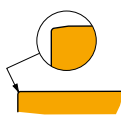

For fine-finish to semi-rough machining, and continuous to slightly interrupted cuts.

TNMA 160408S	T5305	0.8	-	-	-	-	-	-	205	0.20	1.5	-	-	-	-	-	-	40	0.15	1.0
--------------	-------	-----	---	---	---	---	---	---	-----	------	-----	---	---	---	---	---	---	----	------	-----



TNMG

	IC	D1	L	S
	[mm]	[mm]	[mm]	[mm]
1604	9.525	3.81	16.50	4.76
2204	12.700	5.16	22.00	4.76
2706	15.875	6.35	27.50	6.35
3309	19.050	7.94	33.00	9.525

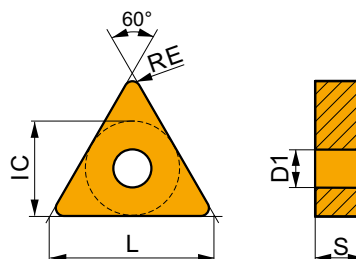

Suitability and starting values for cutting speed (vc), feed (f) and depth of cut (ap). Refer to our Machining Calculator app for further calculations.

Product	RE	P			M			K			N			S			H		
		vc	f	ap	vc	f	ap	vc	f	ap	vc	f	ap	vc	f	ap	vc	f	ap
	[mm]	[m/min]	[mm/rev]	[mm]	[m/min]	[mm/rev]	[mm]	[m/min]	[mm/rev]	[mm]	[m/min]	[mm/rev]	[mm]	[m/min]	[mm/rev]	[mm]	[m/min]	[mm/rev]	[mm]

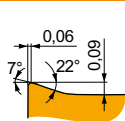

FF geometry with highly positive design for fine-finish machining, and continuous to slightly interrupted cuts.

TNMG 160404E-FF	T7325	0.4	200	0.12	1.0	155	0.11	1.0	-	-	-	-	-	-	-	-	-	-	-
	T8315	0.4	185	0.12	1.0	110	0.11	1.0	175	0.12	1.0	-	-	-	-	-	-	-	-
	T8330	0.4	175	0.12	1.0	105	0.11	1.0	165	0.12	1.0	-	-	-	-	-	-	-	-
	T8430	0.4	210	0.12	1.0	115	0.11	1.0	175	0.12	1.0	-	-	-	-	-	-	-	-
TNMG 160408E-FF	T7325	0.8	225	0.15	1.0	175	0.14	1.0	-	-	-	-	-	-	-	-	-	-	-
	T8315	0.8	205	0.15	1.0	120	0.14	1.0	190	0.15	1.0	-	-	-	-	-	-	-	-

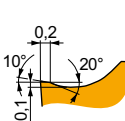

FM geometry with positive design for finish to semi-rough machining, and continuous to slightly interrupted cuts.

TNMG 160404E-FM	T7325	0.4	160	0.20	1.7	120	0.18	1.7	-	-	-	50	0.20	1.4	-	-	-	-	-	
	T7335	0.4	160	0.20	1.7	120	0.18	1.7	-	-	-	50	0.20	1.4	-	-	-	-	-	
	T8315	0.4	150	0.20	1.7	90	0.18	1.7	140	0.20	1.7	-	-	-	35	0.14	1.4	-	-	
	T8330	0.4	145	0.20	1.7	85	0.18	1.7	135	0.20	1.7	-	-	-	35	0.14	1.4	-	-	
	T8430	0.4	165	0.20	1.7	90	0.18	1.7	135	0.20	1.7	-	-	-	35	0.14	1.4	-	-	
	T9310	0.4	245	0.20	1.7	-	-	-	230	0.20	1.7	-	-	-	-	-	-	-	-	-
	T9315	0.4	220	0.20	1.7	-	-	-	205	0.20	1.7	-	-	-	-	-	-	-	-	-
	T9325	0.4	200	0.20	1.7	120	0.18	1.7	190	0.20	1.7	-	-	-	45	0.20	1.4	-	-	-
	TT310	0.4	225	0.20	1.7	135	0.18	1.7	-	-	-	-	-	-	-	-	-	-	-	-
	TNMG 160408E-FM	T7325	0.8	195	0.20	1.7	150	0.18	1.7	-	-	-	60	0.16	1.4	-	-	-	-	-
T7335		0.8	190	0.20	1.7	145	0.18	1.7	-	-	-	60	0.16	1.4	-	-	-	-	-	
T8315		0.8	180	0.20	1.7	105	0.18	1.7	170	0.20	1.7	-	-	-	45	0.16	1.4	-	-	
T8330		0.8	170	0.20	1.7	100	0.18	1.7	160	0.20	1.7	-	-	-	40	0.16	1.4	-	-	
T8430		0.8	195	0.20	1.7	105	0.18	1.7	160	0.20	1.7	-	-	-	40	0.16	1.4	-	-	
T9310		0.8	290	0.20	1.7	-	-	-	275	0.20	1.7	-	-	-	-	-	-	-	-	
T9315		0.8	265	0.20	1.7	-	-	-	250	0.20	1.7	-	-	-	-	-	-	-	-	
T9325		0.8	235	0.20	1.7	140	0.18	1.7	220	0.20	1.7	-	-	-	50	0.16	1.4	-	-	
TT310		0.8	270	0.20	1.7	160	0.18	1.7	-	-	-	-	-	-	-	-	-	-	-	
TNMG 160412E-FM		T7325	1.2	190	0.25	1.7	145	0.23	1.7	-	-	-	60	0.18	1.4	-	-	-	-	-
	T8330	1.2	165	0.25	1.7	95	0.23	1.7	155	0.25	1.7	-	-	-	40	0.18	1.4	-	-	
	T8430	1.2	185	0.25	1.7	100	0.23	1.7	150	0.25	1.7	-	-	-	40	0.18	1.4	-	-	
	T9310	1.2	280	0.25	1.7	-	-	-	265	0.25	1.7	-	-	-	-	-	-	-	-	
	T9315	1.2	255	0.25	1.7	-	-	-	240	0.25	1.7	-	-	-	-	-	-	-	-	
	T9325	1.2	225	0.25	1.7	135	0.23	1.7	210	0.25	1.7	-	-	-	50	0.18	1.4	-	-	
TNMG 220404E-FM	T8330	0.4	145	0.20	1.7	85	0.18	1.7	135	0.20	1.7	-	-	-	35	0.20	1.4	-	-	
	T8430	0.4	150	0.24	1.7	80	0.22	1.7	125	0.24	1.7	-	-	-	30	0.22	1.4	-	-	
	T9315	0.4	220	0.20	1.7	-	-	-	205	0.20	1.7	-	-	-	-	-	-	-	-	
	T9325	0.4	200	0.20	1.7	120	0.18	1.7	190	0.20	1.7	-	-	-	45	0.20	1.4	-	-	



Suitability and starting values for cutting speed (vc), feed (f) and depth of cut (ap). Refer to our Machining Calculator app for further calculations.

Product	RE (mm)	P			M			K			N			S			H		
		vc [m/min]	f [mm/rev]	ap [mm]	vc [m/min]	f [mm/rev]	ap [mm]	vc [m/min]	f [mm/rev]	ap [mm]	vc [m/min]	f [mm/rev]	ap [mm]	vc [m/min]	f [mm/rev]	ap [mm]	vc [m/min]	f [mm/rev]	ap [mm]

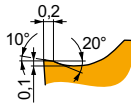

FM geometry with positive design for finish to semi-rough machining, and continuous to slightly interrupted cuts.

TNMG 220408E-FM	T8330	0.8	170	0.20	1.7	100	0.18	1.7	160	0.20	1.7	—	—	—	40	0.16	1.4	—	—	—
	T8430	0.8	195	0.20	1.7	105	0.18	1.7	160	0.20	1.7	—	—	—	40	0.16	1.4	—	—	—
	T9315	0.8	265	0.20	1.7	—	—	—	250	0.20	1.7	—	—	—	—	—	—	—	—	—
	T9325	0.8	235	0.20	1.7	140	0.18	1.7	220	0.20	1.7	—	—	—	50	0.16	1.4	—	—	—

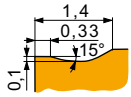

KR geometry for semi-rough to rough machining, and continuous to interrupted cuts.

TNMG 160408E-KR	T5305	0.8	220	0.35	3.0	—	—	—	205	0.35	3.0	—	—	—	—	—	—	40	0.15	1.0
	T5315	0.8	200	0.35	3.0	—	—	—	190	0.35	3.0	—	—	—	—	—	—	40	0.15	1.0

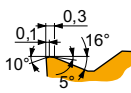

M geometry for finish to semi-rough machining, and continuous to interrupted cuts.

TNMG 160404E-M	T5315	0.4	215	0.20	1.6	—	—	—	200	0.20	1.6	—	—	—	—	—	—	40	0.15	1.0
	T9315	0.4	205	0.20	1.6	—	—	—	190	0.20	1.6	—	—	—	—	—	—	40	0.15	1.0
	T9325	0.4	180	0.20	1.6	—	—	—	170	0.20	1.6	—	—	—	—	—	—	—	—	—
	T9335	0.4	155	0.20	1.6	—	—	—	—	—	—	—	—	—	—	—	—	—	—	—
TNMG 160408E-M	T5305	0.8	250	0.30	1.6	—	—	—	235	0.30	1.6	—	—	—	—	—	—	50	0.15	1.0
	T5315	0.8	225	0.30	1.6	—	—	—	210	0.30	1.6	—	—	—	—	—	—	45	0.15	1.0
	T9310	0.8	220	0.30	1.6	—	—	—	205	0.30	1.6	—	—	—	—	—	—	40	0.15	1.0
	T9315	0.8	205	0.30	1.6	—	—	—	190	0.30	1.6	—	—	—	—	—	—	40	0.15	1.0
	T9325	0.8	185	0.30	1.6	—	—	—	175	0.30	1.6	—	—	—	—	—	—	—	—	—
TNMG 160412E-M	T5315	1.2	215	0.40	1.6	—	—	—	200	0.40	1.6	—	—	—	—	—	—	40	0.15	1.0
	T9315	1.2	190	0.40	1.6	—	—	—	180	0.40	1.6	—	—	—	—	—	—	35	0.15	1.0
	T9325	1.2	170	0.40	1.6	—	—	—	160	0.40	1.6	—	—	—	—	—	—	—	—	—
	T9335	1.2	145	0.40	1.6	—	—	—	—	—	—	—	—	—	—	—	—	—	—	—
TNMG 220408E-M	T5305	0.8	245	0.30	2.1	—	—	—	230	0.30	2.1	—	—	—	—	—	—	45	0.15	1.0
	T5315	0.8	215	0.30	2.1	—	—	—	200	0.30	2.1	—	—	—	—	—	—	40	0.15	1.0
	T9310	0.8	215	0.30	2.1	—	—	—	200	0.30	2.1	—	—	—	—	—	—	40	0.15	1.0
	T9315	0.8	200	0.30	2.1	—	—	—	190	0.30	2.1	—	—	—	—	—	—	40	0.15	1.0
	T9325	0.8	180	0.30	2.1	—	—	—	170	0.30	2.1	—	—	—	—	—	—	—	—	—
TNMG 220412E-M	T5315	1.2	205	0.40	2.1	—	—	—	190	0.40	2.1	—	—	—	—	—	—	40	0.15	1.0
	T9315	1.2	185	0.40	2.1	—	—	—	175	0.40	2.1	—	—	—	—	—	—	35	0.15	1.0
	T9325	1.2	165	0.40	2.1	—	—	—	155	0.40	2.1	—	—	—	—	—	—	—	—	—
	T9335	1.2	140	0.40	2.1	—	—	—	—	—	—	—	—	—	—	—	—	—	—	—

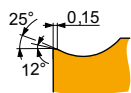

NF geometry with highly positive design for fine-finish to medium machining, and continuous cuts.

TNMG 160404E-NF	HF7	0.4	—	—	—	90	0.14	1.4	140	0.15	1.4	450	0.18	1.4	—	—	—	—	—	—
	T6310	0.4	150	0.17	1.4	105	0.15	1.4	120	0.17	1.4	450	0.20	1.4	45	0.15	1.1	—	—	—
	T7325	0.4	170	0.18	1.4	130	0.16	1.4	—	—	—	—	—	—	55	0.16	1.1	—	—	—
	T7335	0.4	165	0.18	1.4	125	0.16	1.4	—	—	—	—	—	—	50	0.16	1.1	—	—	—
	T8315	0.4	160	0.17	1.4	95	0.15	1.4	150	0.17	1.4	480	0.20	1.4	40	0.15	1.1	—	—	—
	T8330	0.4	155	0.17	1.4	90	0.15	1.4	145	0.17	1.4	465	0.20	1.4	35	0.15	1.1	—	—	—
	T8430	0.4	175	0.17	1.4	95	0.15	1.4	140	0.17	1.4	480	0.20	1.4	35	0.15	1.1	—	—	—
	T9315	0.4	255	0.15	1.4	—	—	—	240	0.15	1.4	—	—	—	—	—	—	—	—	—
	T9325	0.4	215	0.18	1.4	125	0.16	1.4	200	0.18	1.4	—	—	—	45	0.16	1.1	—	—	—



Suitability and starting values for cutting speed (vc), feed (f) and depth of cut (ap). Refer to our Machining Calculator app for further calculations.

Product	RE (mm)	P			M			K			N			S			H		
		vc (m/min)	f (mm/rev)	ap (mm)	vc (m/min)	f (mm/rev)	ap (mm)	vc (m/min)	f (mm/rev)	ap (mm)	vc (m/min)	f (mm/rev)	ap (mm)	vc (m/min)	f (mm/rev)	ap (mm)	vc (m/min)	f (mm/rev)	ap (mm)

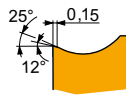

NF geometry with highly positive design for fine-finish to medium machining, and continuous cuts.

TNMG 160408E-NF	HF7	0.8	–	–	–	█	100	0.15	1.4	█	160	0.17	1.4	█	510	0.20	1.4	–	–	–	–	–	–		
	T6310	0.8	█	180	0.18	1.4	█	125	0.16	1.4	█	145	0.18	1.4	█	540	0.22	1.4	█	50	0.16	1.1	–	–	–
	T7325	0.8	█	200	0.18	1.4	█	155	0.16	1.4	–	–	–	–	–	–	–	–	█	65	0.16	1.1	–	–	–
	T7335	0.8	█	195	0.18	1.4	█	150	0.16	1.4	–	–	–	–	–	–	–	–	█	60	0.16	1.1	–	–	–
	T8315	0.8	█	190	0.18	1.4	█	110	0.16	1.4	█	180	0.18	1.4	█	570	0.22	1.4	█	45	0.16	1.1	–	–	–
	T8330	0.8	█	180	0.18	1.4	█	105	0.16	1.4	█	170	0.18	1.4	█	540	0.22	1.4	█	45	0.16	1.1	–	–	–
	T8430	0.8	█	205	0.18	1.4	█	110	0.16	1.4	█	170	0.18	1.4	█	570	0.22	1.4	█	45	0.16	1.1	–	–	–
	T9315	0.8	█	290	0.17	1.4	█	–	–	–	█	275	0.17	1.4	–	–	–	–	–	–	–	–	–	–	–
	T9325	0.8	█	255	0.18	1.4	█	150	0.16	1.4	█	240	0.18	1.4	–	–	–	–	–	█	55	0.16	1.1	–	–

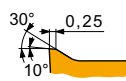

NM geometry with highly positive design for fine-finish, medium and rough machining, in continuous cuts.

TNMG 160404E-NM	T7325	0.4	█	170	0.20	1.9	█	130	0.18	1.9	–	–	–	–	–	–	–	–	█	55	0.20	1.5	–	–	–
	T7335	0.4	█	160	0.20	1.9	█	120	0.18	1.9	–	–	–	–	–	–	–	–	█	50	0.20	1.5	–	–	–
	T8315	0.4	█	160	0.20	1.9	█	95	0.18	1.9	–	–	–	█	480	0.24	1.9	█	40	0.20	1.5	–	–	–	
	T8330	0.4	█	145	0.20	1.9	█	85	0.18	1.9	–	–	–	█	435	0.24	1.9	█	35	0.20	1.5	–	–	–	
	T8430	0.4	█	170	0.20	1.9	█	90	0.18	1.9	–	–	–	█	465	0.24	1.9	█	35	0.20	1.5	–	–	–	
	T9325	0.4	█	210	0.20	1.9	█	125	0.18	1.9	–	–	–	–	–	–	–	–	█	45	0.20	1.5	–	–	–
TNMG 160408E-NM	T7325	0.8	█	190	0.25	1.9	█	145	0.23	1.9	–	–	–	–	–	–	–	–	█	60	0.20	1.5	–	–	–
	T7335	0.8	█	180	0.25	1.9	█	140	0.23	1.9	–	–	–	–	–	–	–	–	█	55	0.20	1.5	–	–	–
	T8315	0.8	█	175	0.25	1.9	█	105	0.23	1.9	–	–	–	█	525	0.30	1.9	█	40	0.20	1.5	–	–	–	
	T8330	0.8	█	165	0.25	1.9	█	95	0.23	1.9	–	–	–	█	495	0.30	1.9	█	40	0.20	1.5	–	–	–	
	T8430	0.8	█	185	0.25	1.9	█	100	0.23	1.9	–	–	–	█	510	0.30	1.9	█	40	0.20	1.5	–	–	–	
	T9315	0.8	█	250	0.25	1.9	█	–	–	–	–	–	–	–	–	–	–	–	–	–	–	–	–	–	
T9325	0.8	█	225	0.25	1.9	█	135	0.23	1.9	–	–	–	–	–	–	–	–	█	50	0.20	1.5	–	–	–	
TNMG 220408E-NM	T7325	0.8	█	190	0.25	1.7	█	145	0.23	1.7	–	–	–	–	–	–	–	–	█	60	0.20	1.4	–	–	–
	T7335	0.8	█	185	0.25	1.7	█	140	0.23	1.7	–	–	–	–	–	–	–	–	█	60	0.20	1.4	–	–	–
	T8315	0.8	█	175	0.25	1.7	█	105	0.23	1.7	–	–	–	█	525	0.30	1.7	█	40	0.20	1.4	–	–	–	
	T8330	0.8	█	165	0.25	1.7	█	95	0.23	1.7	–	–	–	█	495	0.30	1.7	█	40	0.20	1.4	–	–	–	
	T8430	0.8	█	185	0.25	1.7	█	100	0.23	1.7	–	–	–	█	510	0.30	1.7	█	40	0.20	1.4	–	–	–	
	T9315	0.8	█	255	0.25	1.7	█	–	–	–	–	–	–	–	–	–	–	–	–	–	–	–	–	–	
T9325	0.8	█	225	0.25	1.7	█	135	0.23	1.7	–	–	–	–	–	–	–	–	█	50	0.20	1.4	–	–	–	
TNMG 220412E-NM	T7325	1.2	█	190	0.30	1.7	█	145	0.27	1.7	–	–	–	–	–	–	–	–	█	60	0.24	1.4	–	–	–
	T7335	1.2	█	180	0.30	2.1	█	140	0.27	2.1	–	–	–	–	–	–	–	–	█	55	0.24	1.7	–	–	–
	T9325	1.2	█	215	0.30	2.1	█	125	0.27	2.1	–	–	–	–	–	–	–	–	█	45	0.24	1.7	–	–	–

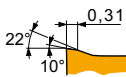

NMR geometry with positive design for medium to rough machining, and continuous cuts.

TNMG 160404E-NMR	T6310	0.4	█	130	0.20	1.7	█	90	0.18	1.7	–	–	–	–	–	–	–	–	█	35	0.18	1.4	–	–	–
	T7325	0.4	█	145	0.20	1.7	█	110	0.18	1.7	–	–	–	–	–	–	–	–	█	45	0.18	1.4	–	–	–
	T7335	0.4	█	145	0.20	1.7	█	110	0.18	1.7	–	–	–	–	–	–	–	–	█	45	0.18	1.4	–	–	–
	T8330	0.4	█	130	0.20	1.7	█	75	0.18	1.7	–	–	–	–	–	–	–	–	█	30	0.18	1.4	–	–	–
	T8430	0.4	█	145	0.20	1.7	█	80	0.18	1.7	–	–	–	–	–	–	–	–	█	30	0.18	1.4	–	–	–
	T9315	0.4	█	200	0.20	1.7	█	–	–	–	–	–	–	–	–	–	–	–	–	–	–	–	–	–	–
T9325	0.4	█	180	0.20	1.7	█	105	0.18	1.7	–	–	–	–	–	–	–	–	█	40	0.18	1.4	–	–	–	
TNMG 160408E-NMR	T6310	0.8	█	140	0.30	1.7	█	100	0.27	1.7	–	–	–	–	–	–	–	–	█	40	0.24	1.4	–	–	–
	T7325	0.8	█	155	0.30	1.7	█	120	0.27	1.7	–	–	–	–	–	–	–	–	█	50	0.24	1.4	–	–	–
	T7335	0.8	█	145	0.30	1.7	█	110	0.27	1.7	–	–	–	–	–	–	–	–	█	45	0.24	1.4	–	–	–
	T8330	0.8	█	140	0.30	1.7	█	80	0.27	1.7	–	–	–	–	–	–	–	–	█	35	0.24	1.4	–	–	–
	T8430	0.8	█	150	0.30	1.7	█	80	0.27	1.7	–	–	–	–	–	–	–	–	█	30	0.24	1.4	–	–	–
	T9315	0.8	█	205	0.30	1.7	█	–	–	–	–	–	–	–	–	–	–	–	–	–	–	–	–	–	
T9325	0.8	█	185	0.30	1.7	█	110	0.27	1.7	–	–	–	–	–	–	–	–	█	40	0.24	1.4	–	–	–	



Suitability and starting values for cutting speed (vc), feed (f) and depth of cut (ap). Refer to our Machining Calculator app for further calculations.

Product	RE  (mm)	P			M			K			N			S			H		
		vc [m/min]	f [mm/rev]	ap [mm]	vc [m/min]	f [mm/rev]	ap [mm]	vc [m/min]	f [mm/rev]	ap [mm]	vc [m/min]	f [mm/rev]	ap [mm]	vc [m/min]	f [mm/rev]	ap [mm]	vc [m/min]	f [mm/rev]	ap [mm]

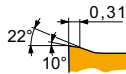

NMR geometry with positive design for medium to rough machining, and continuous cuts.

TNMG 160412E-NMR	T7325	1.2	165	0.30	1.7	125	0.27	1.7	–	–	–	–	–	–	50	0.24	1.4	–	–	–	
	T9315	1.2	215	0.30	1.7	–	–	–	–	–	–	–	–	–	–	–	–	–	–	–	
	T9325	1.2	195	0.30	1.7	115	0.27	1.7	–	–	–	–	–	–	40	0.24	1.4	–	–	–	
TNMG 220408E-NMR	T6310	0.8	135	0.30	2.1	95	0.27	2.1	–	–	–	–	–	–	40	0.24	1.7	–	–	–	
	T7325	0.8	150	0.30	2.1	115	0.27	2.1	–	–	–	–	–	–	45	0.24	1.7	–	–	–	
	T7335	0.8	145	0.30	2.1	110	0.27	2.1	–	–	–	–	–	–	45	0.24	1.7	–	–	–	
	T8330	0.8	135	0.30	2.1	80	0.27	2.1	–	–	–	–	–	–	30	0.24	1.7	–	–	–	
	T8430	0.8	145	0.30	2.1	80	0.27	2.1	–	–	–	–	–	–	30	0.24	1.7	–	–	–	
	T9315	0.8	200	0.30	2.1	–	–	–	–	–	–	–	–	–	–	–	–	–	–	–	–
	T9325	0.8	180	0.30	2.1	105	0.27	2.1	–	–	–	–	–	–	40	0.24	1.7	–	–	–	
TNMG 220412E-NMR	T6310	1.2	140	0.30	2.1	100	0.27	2.1	–	–	–	–	–	–	40	0.24	1.7	–	–	–	
	T7325	1.2	160	0.30	2.1	120	0.27	2.1	–	–	–	–	–	–	50	0.24	1.7	–	–	–	
	T9315	1.2	210	0.30	2.1	–	–	–	–	–	–	–	–	–	–	–	–	–	–	–	
	T9325	1.2	190	0.30	2.1	110	0.27	2.1	–	–	–	–	–	–	40	0.24	1.7	–	–	–	

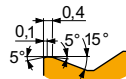

R geometry for semi-rough to rough machining, and continuous to interrupted cuts.

TNMG 160408E-R	T5305	0.8	210	0.40	3.0	–	–	–	195	0.40	3.0	–	–	–	–	–	–	40	0.15	1.0
	T5315	0.8	185	0.40	3.0	–	–	–	175	0.40	3.0	–	–	–	–	–	–	35	0.15	1.0
	T9310	0.8	185	0.40	3.0	–	–	–	175	0.40	3.0	–	–	–	–	–	–	35	0.15	1.0
	T9315	0.8	165	0.40	3.0	–	–	–	155	0.40	3.0	–	–	–	–	–	–	30	0.15	1.0
	T9325	0.8	150	0.40	3.0	–	–	–	140	0.40	3.0	–	–	–	–	–	–	–	–	–
	T9335	0.8	130	0.40	3.0	–	–	–	–	–	–	–	–	–	–	–	–	–	–	–
TNMG 160412E-R	T5315	1.2	195	0.40	3.0	–	–	–	185	0.40	3.0	–	–	–	–	–	–	35	0.15	1.0
	T9310	1.2	195	0.40	3.0	–	–	–	185	0.40	3.0	–	–	–	–	–	–	35	0.15	1.0
	T9325	1.2	160	0.40	3.0	–	–	–	150	0.40	3.0	–	–	–	–	–	–	–	–	–
	T9335	1.2	140	0.40	3.0	–	–	–	–	–	–	–	–	–	–	–	–	–	–	–
TNMG 220408E-R	T9315	0.8	165	0.40	4.0	–	–	–	155	0.40	4.0	–	–	–	–	–	–	30	0.15	1.0
	T9325	0.8	145	0.40	4.0	–	–	–	135	0.40	4.0	–	–	–	–	–	–	–	–	–
	T9335	0.8	125	0.40	4.0	–	–	–	–	–	–	–	–	–	–	–	–	–	–	–
TNMG 220412E-R	T9310	1.2	185	0.40	4.0	–	–	–	175	0.40	4.0	–	–	–	–	–	–	35	0.15	1.0
	T9315	1.2	170	0.40	4.0	–	–	–	160	0.40	4.0	–	–	–	–	–	–	30	0.15	1.0
	T9325	1.2	155	0.40	4.0	–	–	–	145	0.40	4.0	–	–	–	–	–	–	–	–	–
TNMG 220416E-R	T9315	1.6	180	0.40	4.0	–	–	–	170	0.40	4.0	–	–	–	–	–	–	35	0.15	1.0
	T9325	1.6	165	0.40	4.0	–	–	–	155	0.40	4.0	–	–	–	–	–	–	–	–	–

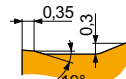

RM geometry for semi-rough to rough machining, and continuous to interrupted cuts.

TNMG 160408E-RM	T5305	0.8	245	0.40	3.0	–	–	–	230	0.40	3.0	–	–	–	–	–	–	–	–	–	
	T5315	0.8	215	0.40	3.0	–	–	–	200	0.40	3.0	–	–	–	–	–	–	–	–	–	
	T7325	0.8	155	0.40	3.0	120	0.36	3.0	–	–	–	–	–	–	–	–	–	–	–	–	
	T7335	0.8	145	0.40	3.0	110	0.36	3.0	–	–	–	–	–	–	–	–	–	–	–	–	
	T9310	0.8	210	0.40	3.0	–	–	–	195	0.40	3.0	–	–	–	–	–	–	–	–	–	
	T9315	0.8	195	0.40	3.0	–	–	–	185	0.40	3.0	–	–	–	–	–	–	–	–	–	–
	T9325	0.8	175	0.40	3.0	105	0.36	3.0	165	0.40	3.0	–	–	–	–	–	–	–	–	–	
	T9335	0.8	150	0.40	3.0	90	0.36	3.0	–	–	–	–	–	–	–	–	–	–	–	–	



Suitability and starting values for cutting speed (vc), feed (f) and depth of cut (ap). Refer to our Machining Calculator app for further calculations.

Product	RE (mm)	P			M			K			N			S			H		
		vc (m/min)	f (mm/rev)	ap (mm)	vc (m/min)	f (mm/rev)	ap (mm)	vc (m/min)	f (mm/rev)	ap (mm)	vc (m/min)	f (mm/rev)	ap (mm)	vc (m/min)	f (mm/rev)	ap (mm)	vc (m/min)	f (mm/rev)	ap (mm)

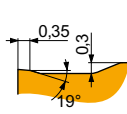

RM geometry for semi-rough to rough machining, and continuous to interrupted cuts.

TNMG 160412E-RM	T5305	1.2	255	0.40	3.0	-	-	-	240	0.40	3.0	-	-	-	-	-	-	-
	T5315	1.2	225	0.40	3.0	-	-	-	210	0.40	3.0	-	-	-	-	-	-	-
	T7325	1.2	165	0.40	3.0	125	0.36	3.0	-	-	-	-	-	-	-	-	-	-
	T7335	1.2	155	0.40	3.0	120	0.36	3.0	-	-	-	-	-	-	-	-	-	-
	T8330	1.2	145	0.40	3.0	85	0.36	3.0	135	0.40	3.0	-	-	-	-	-	-	-
	T8430	1.2	150	0.40	3.0	80	0.36	3.0	125	0.40	3.0	-	-	-	-	-	-	-
	T9315	1.2	205	0.40	3.0	-	-	-	190	0.40	3.0	-	-	-	-	-	-	-
	T9325	1.2	185	0.40	3.0	110	0.36	3.0	175	0.40	3.0	-	-	-	-	-	-	-
	T9335	1.2	160	0.40	3.0	95	0.36	3.0	-	-	-	-	-	-	-	-	-	-
TNMG 220408E-RM	T5305	0.8	235	0.40	4.0	-	-	-	220	0.40	4.0	-	-	-	-	-	-	-
	T5315	0.8	210	0.40	4.0	-	-	-	195	0.40	4.0	-	-	-	-	-	-	-
	T7325	0.8	150	0.40	4.0	115	0.36	4.0	-	-	-	-	-	-	-	-	-	
	T7335	0.8	140	0.40	4.0	105	0.36	4.0	-	-	-	-	-	-	-	-	-	
	T9310	0.8	200	0.40	4.0	-	-	-	190	0.40	4.0	-	-	-	-	-	-	-
	T9315	0.8	190	0.40	4.0	-	-	-	180	0.40	4.0	-	-	-	-	-	-	-
	T9325	0.8	170	0.40	4.0	100	0.36	4.0	160	0.40	4.0	-	-	-	-	-	-	
	T9335	0.8	145	0.40	4.0	85	0.36	4.0	-	-	-	-	-	-	-	-	-	
	TNMG 220412E-RM	T5305	1.2	245	0.40	4.0	-	-	-	230	0.40	4.0	-	-	-	-	-	-
T5315		1.2	220	0.40	4.0	-	-	-	205	0.40	4.0	-	-	-	-	-	-	-
T7325		1.2	160	0.40	4.0	120	0.36	4.0	-	-	-	-	-	-	-	-	-	
T7335		1.2	150	0.40	4.0	115	0.36	4.0	-	-	-	-	-	-	-	-	-	
T9315		1.2	200	0.40	4.0	-	-	-	190	0.40	4.0	-	-	-	-	-	-	-
T9325		1.2	180	0.40	4.0	105	0.36	4.0	170	0.40	4.0	-	-	-	-	-	-	
T9335		1.2	155	0.40	4.0	90	0.36	4.0	-	-	-	-	-	-	-	-	-	
TNMG 220416E-RM		T7325	1.6	165	0.40	4.0	125	0.36	4.0	-	-	-	-	-	-	-	-	-
		T9315	1.6	210	0.40	4.0	-	-	-	195	0.40	4.0	-	-	-	-	-	-
	T9325	1.6	185	0.40	4.0	110	0.36	4.0	175	0.40	4.0	-	-	-	-	-		
	T9335	1.6	160	0.40	4.0	95	0.36	4.0	-	-	-	-	-	-	-	-		
TNMG 270612E-RM	T7325	1.2	110	0.40	6.0	85	0.36	6.0	-	-	-	-	-	-	-	-	-	
	T9325	1.2	120	0.40	6.0	70	0.36	6.0	110	0.40	6.0	-	-	-	-	-		
TNMG 270616E-RM	T7325	1.6	115	0.40	6.0	85	0.36	6.0	-	-	-	-	-	-	-	-	-	
	T9226	1.6	115	0.40	6.0	65	0.36	6.0	105	0.40	6.0	-	-	-	-	-		
	T9315	1.6	135	0.40	6.0	-	-	-	125	0.40	6.0	-	-	-	-	-		
	T9325	1.6	125	0.40	6.0	75	0.36	6.0	115	0.40	6.0	-	-	-	-	-		
	T9335	1.6	100	0.40	6.0	60	0.36	6.0	-	-	-	-	-	-	-	-		
TNMG 270624E-RM	T7325	2.4	115	0.50	6.0	85	0.45	6.0	-	-	-	-	-	-	-	-		
	T9325	2.4	120	0.50	6.0	70	0.45	6.0	110	0.50	6.0	-	-	-	-	-		
	T9335	2.4	95	0.50	6.0	55	0.45	6.0	-	-	-	-	-	-	-			
TNMG 270632E-RM	T9335	3.2	90	0.60	6.0	50	0.54	6.0	-	-	-	-	-	-	-			
TNMG 330924E-RM	T9226	2.4	100	0.50	10.0	60	0.45	10.0	95	0.50	10.0	-	-	-	-	-		
	T9335	2.4	90	0.50	10.0	50	0.45	10.0	-	-	-	-	-	-	-			

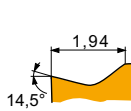

SF geometry with positive design for fine-finish machining of thin walls and continuous cuts.

TNMG 160404E-SF	H07	0.4	-	-	-	75	0.14	1.3	120	0.15	1.3	390	0.18	1.3	35	0.12	1.0	-
	T6310	0.4	150	0.15	1.3	105	0.14	1.3	120	0.15	1.3	450	0.18	1.3	45	0.12	1.0	30
	T7325	0.4	170	0.17	1.3	130	0.15	1.3	-	-	-	-	-	55	0.15	1.0	-	
	T7335	0.4	165	0.17	1.3	125	0.15	1.3	-	-	-	-	-	50	0.15	1.0	-	
	T8315	0.4	160	0.15	1.3	95	0.14	1.3	150	0.15	1.3	480	0.18	1.3	40	0.12	1.0	30
	T8330	0.4	150	0.15	1.3	90	0.14	1.3	140	0.15	1.3	450	0.18	1.3	35	0.12	1.0	30
	T8430	0.4	180	0.15	1.3	95	0.14	1.3	145	0.15	1.3	495	0.18	1.3	35	0.12	1.0	30
	T9315	0.4	245	0.15	1.3	-	-	-	230	0.15	1.3	-	-	-	-	-	45	0.15
	T9325	0.4	210	0.17	1.3	125	0.15	1.3	195	0.17	1.3	-	-	-	45	0.15	1.0	-



Suitability and starting values for cutting speed (vc), feed (f) and depth of cut (ap). Refer to our Machining Calculator app for further calculations.

Product	RE  [mm]	P			M			K			N			S			H		
		vc [m/min]	f [mm/rev]	ap [mm]	vc [m/min]	f [mm/rev]	ap [mm]	vc [m/min]	f [mm/rev]	ap [mm]	vc [m/min]	f [mm/rev]	ap [mm]	vc [m/min]	f [mm/rev]	ap [mm]	vc [m/min]	f [mm/rev]	ap [mm]

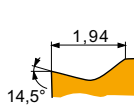

SF geometry with positive design for fine-finish machining of thin walls and continuous cuts.

TNMG 160408E-SF	H07	0.8	–	–	–	85	0.15	1.3	140	0.17	1.3	445	0.20	1.3	45	0.14	1.0	–	–	–
	T6310	0.8	175	0.17	1.3	125	0.15	1.3	140	0.17	1.3	525	0.20	1.3	50	0.14	1.0	35	0.15	1.0
	T7325	0.8	200	0.17	1.3	155	0.15	1.3	–	–	–	–	–	–	65	0.15	1.0	–	–	–
	T7335	0.8	195	0.17	1.3	150	0.15	1.3	–	–	–	–	–	–	60	0.15	1.0	–	–	–
	T8315	0.8	185	0.17	1.3	110	0.15	1.3	175	0.17	1.3	555	0.20	1.3	45	0.14	1.0	35	0.15	1.0
	T8330	0.8	175	0.17	1.3	105	0.15	1.3	165	0.17	1.3	525	0.20	1.3	40	0.14	1.0	35	0.15	1.0
	T8430	0.8	205	0.17	1.3	110	0.15	1.3	170	0.17	1.3	570	0.20	1.3	45	0.14	1.0	35	0.15	1.0
	T9315	0.8	275	0.17	1.3	–	–	–	260	0.17	1.3	–	–	–	–	–	–	55	0.15	1.0
	T9325	0.8	250	0.17	1.3	150	0.15	1.3	235	0.17	1.3	–	–	–	55	0.15	1.0	–	–	–
	TNMG 160412E-SF	T6310	1.2	160	0.30	1.3	115	0.27	1.3	125	0.30	1.3	480	0.36	1.3	45	0.21	1.0	30	0.15
T7325		1.2	175	0.30	1.3	135	0.27	1.3	–	–	–	–	–	55	0.21	1.0	–	–	–	
T9325		1.2	205	0.30	1.3	120	0.27	1.3	190	0.30	1.3	–	–	–	45	0.21	1.0	–	–	–
TNMG 220404E-SF	T6310	0.4	145	0.17	1.7	100	0.15	1.7	115	0.17	1.7	435	0.20	1.7	40	0.15	1.4	25	0.15	1.0
	T7325	0.4	160	0.17	1.7	120	0.15	1.7	–	–	–	–	–	50	0.15	1.4	–	–	–	
	T9325	0.4	205	0.17	1.7	120	0.15	1.7	190	0.17	1.7	–	–	–	45	0.15	1.4	–	–	–
TNMG 220408E-SF	T6310	0.8	170	0.17	1.7	120	0.15	1.7	135	0.17	1.7	510	0.20	1.7	50	0.15	1.4	30	0.15	1.0
	T8315	0.8	180	0.17	1.7	105	0.15	1.7	170	0.17	1.7	540	0.20	1.7	45	0.15	1.4	35	0.15	1.0
	T8430	0.8	195	0.17	1.7	105	0.15	1.7	160	0.17	1.7	540	0.20	1.7	40	0.15	1.4	30	0.15	1.0
TNMG 220412E-SF	T6310	1.2	155	0.30	1.7	110	0.27	1.7	125	0.30	1.7	465	0.36	1.7	45	0.21	1.4	30	0.15	1.0
	T7325	1.2	170	0.30	1.7	130	0.27	1.7	–	–	–	–	–	55	0.21	1.4	–	–	–	
	T9325	1.2	205	0.30	1.7	120	0.27	1.7	190	0.30	1.7	–	–	–	45	0.21	1.4	–	–	–

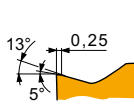

SM geometry with positive design for medium machining, and continuous to interrupted cuts.

TNMG 160404E-SM	T6310	0.4	135	0.22	1.7	95	0.20	1.7	105	0.22	1.7	405	0.26	1.7	40	0.20	1.4	25	0.15	1.0
	T7325	0.4	150	0.22	1.7	115	0.20	1.7	–	–	–	–	–	45	0.20	1.4	–	–	–	
	T7335	0.4	145	0.22	1.7	110	0.20	1.7	–	–	–	–	–	45	0.20	1.4	–	–	–	
	T8330	0.4	135	0.22	1.7	80	0.20	1.7	125	0.22	1.7	405	0.26	1.7	30	0.20	1.4	25	0.15	1.0
	T8430	0.4	145	0.22	1.7	80	0.20	1.7	120	0.22	1.7	405	0.26	1.7	30	0.20	1.4	25	0.15	1.0
	T9315	0.4	210	0.20	1.7	–	–	–	195	0.20	1.7	–	–	–	–	–	–	40	0.15	1.0
	T9325	0.4	185	0.22	1.7	110	0.20	1.7	175	0.22	1.7	–	–	–	40	0.20	1.4	–	–	–
	TNMG 160408E-SM	T6310	0.8	150	0.25	1.7	105	0.23	1.7	120	0.25	1.7	450	0.30	1.7	45	0.20	1.4	30	0.15
T7325		0.8	170	0.25	1.7	130	0.23	1.7	–	–	–	–	–	55	0.20	1.4	–	–	–	
T7335		0.8	165	0.25	1.7	125	0.23	1.7	–	–	–	–	–	50	0.20	1.4	–	–	–	
T8330		0.8	150	0.25	1.7	90	0.23	1.7	140	0.25	1.7	450	0.30	1.7	35	0.20	1.4	30	0.15	1.0
T8430		0.8	170	0.25	1.7	90	0.23	1.7	135	0.25	1.7	465	0.30	1.7	35	0.20	1.4	25	0.15	1.0
T9315		0.8	230	0.25	1.7	–	–	–	215	0.25	1.7	–	–	–	–	–	–	45	0.15	1.0
T9325		0.8	205	0.25	1.7	120	0.23	1.7	190	0.25	1.7	–	–	–	45	0.20	1.4	–	–	–
TNMG 160412E-SM	T6310	1.2	155	0.30	1.7	110	0.27	1.7	125	0.30	1.7	465	0.36	1.7	45	0.24	1.4	30	0.15	1.0
	T7325	1.2	170	0.30	1.7	130	0.27	1.7	–	–	–	–	–	55	0.24	1.4	–	–	–	
	T7335	1.2	165	0.30	1.7	125	0.27	1.7	–	–	–	–	–	50	0.24	1.4	–	–	–	
	T9325	1.2	205	0.30	1.7	120	0.27	1.7	190	0.30	1.7	–	–	–	45	0.24	1.4	–	–	–
TNMG 220404E-SM	T6310	0.4	130	0.24	1.7	90	0.22	1.7	100	0.24	1.7	390	0.29	1.7	35	0.22	1.4	25	0.15	1.0
	T7325	0.4	145	0.24	1.7	110	0.22	1.7	–	–	–	–	–	45	0.22	1.4	–	–	–	
	T8330	0.4	130	0.24	1.7	75	0.22	1.7	120	0.24	1.7	390	0.29	1.7	30	0.22	1.4	25	0.15	1.0
	T8430	0.4	145	0.24	1.7	80	0.22	1.7	120	0.24	1.7	405	0.29	1.7	30	0.22	1.4	25	0.15	1.0
	T9325	0.4	175	0.24	1.7	105	0.22	1.7	165	0.24	1.7	–	–	–	35	0.22	1.4	–	–	–
TNMG 220408E-SM	T6310	0.8	150	0.25	1.7	105	0.23	1.7	120	0.25	1.7	450	0.30	1.7	45	0.20	1.4	30	0.15	1.0
	T7325	0.8	170	0.25	1.7	130	0.23	1.7	–	–	–	–	–	55	0.20	1.4	–	–	–	
	T7335	0.8	165	0.25	1.7	125	0.23	1.7	–	–	–	–	–	50	0.20	1.4	–	–	–	
	T8330	0.8	150	0.25	1.7	90	0.23	1.7	140	0.25	1.7	450	0.30	1.7	35	0.20	1.4	30	0.15	1.0
	T8430	0.8	170	0.25	1.7	90	0.23	1.7	135	0.25	1.7	465	0.30	1.7	35	0.20	1.4	25	0.15	1.0
	T9315	0.8	230	0.25	1.7	–	–	–	215	0.25	1.7	–	–	–	–	–	–	45	0.15	1.0
	T9325	0.8	205	0.25	1.7	120	0.23	1.7	190	0.25	1.7	–	–	–	45	0.20	1.4	–	–	–



Suitability and starting values for cutting speed (vc), feed (f) and depth of cut (ap). Refer to our Machining Calculator app for further calculations.

Product	RE [mm]	P			M			K			N			S			H		
		vc [m/min]	f [mm/rev]	ap [mm]	vc [m/min]	f [mm/rev]	ap [mm]	vc [m/min]	f [mm/rev]	ap [mm]	vc [m/min]	f [mm/rev]	ap [mm]	vc [m/min]	f [mm/rev]	ap [mm]	vc [m/min]	f [mm/rev]	ap [mm]

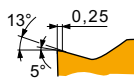

SM geometry with positive design for medium machining, and continuous to interrupted cuts.

TNMG 220412E-SM	T6310	1.2	155	0.30	1.7	110	0.27	1.7	125	0.30	1.7	465	0.36	1.7	45	0.24	1.4	30	0.15	1.0
	T7325	1.2	170	0.30	1.7	130	0.27	1.7	-	-	-	-	-	-	55	0.24	1.4	-	-	-
	T7335	1.2	165	0.30	1.7	125	0.27	1.7	-	-	-	-	-	-	50	0.24	1.4	-	-	-
	T9315	1.2	225	0.30	1.7	-	-	-	210	0.30	1.7	-	-	-	-	-	-	45	0.15	1.0
	T9325	1.2	205	0.30	1.7	120	0.27	1.7	190	0.30	1.7	-	-	-	45	0.24	1.4	-	-	-

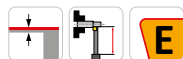
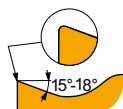

ER-SI geometry with positive right-handed design for fine-finish to semi-rough machining, and continuous cuts.

TNMG 160404ER-SI	T7325	0.4	190	0.20	1.5	145	0.18	1.5	-	-	-	-	-	-	60	0.18	1.2	-	-	-
	T7335	0.4	180	0.20	1.5	140	0.18	1.5	-	-	-	-	-	-	55	0.18	1.2	-	-	-
	T8315	0.4	175	0.20	1.5	105	0.18	1.5	-	-	-	525	0.24	1.5	40	0.18	1.2	-	-	-
	T8330	0.4	165	0.20	1.5	95	0.18	1.5	-	-	-	495	0.24	1.5	40	0.18	1.2	-	-	-
	T8430	0.4	185	0.20	1.5	100	0.18	1.5	-	-	-	510	0.24	1.5	40	0.18	1.2	-	-	-
	T9325	0.4	230	0.20	1.5	135	0.18	1.5	-	-	-	-	-	-	50	0.18	1.2	-	-	-
TNMG 160408ER-SI	T7325	0.8	190	0.35	1.5	145	0.32	1.5	-	-	-	-	-	-	60	0.25	1.2	-	-	-
	T7335	0.8	180	0.35	1.5	140	0.32	1.5	-	-	-	-	-	-	55	0.25	1.2	-	-	-
	T8315	0.8	175	0.35	1.5	105	0.32	1.5	-	-	-	525	0.42	1.5	40	0.25	1.2	-	-	-
	T8330	0.8	170	0.35	1.5	100	0.32	1.5	-	-	-	510	0.42	1.5	40	0.25	1.2	-	-	-
	T8430	0.8	180	0.35	1.5	95	0.32	1.5	-	-	-	495	0.42	1.5	35	0.25	1.2	-	-	-
	T9325	0.8	215	0.35	1.5	125	0.32	1.5	-	-	-	-	-	-	45	0.25	1.2	-	-	-
T9335	0.8	190	0.35	1.5	110	0.32	1.5	-	-	-	-	-	-	40	0.25	1.2	-	-	-	

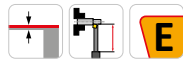
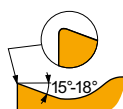

EL-SI geometry with positive left-handed design for fine-finish to semi-rough machining, and continuous cuts.

TNMG 160404EL-SI	T7325	0.4	190	0.20	1.5	145	0.18	1.5	-	-	-	-	-	-	60	0.18	1.2	-	-	-
	T7335	0.4	180	0.20	1.5	140	0.18	1.5	-	-	-	-	-	-	55	0.18	1.2	-	-	-
	T8315	0.4	175	0.20	1.5	105	0.18	1.5	-	-	-	525	0.24	1.5	40	0.18	1.2	-	-	-
	T8330	0.4	165	0.20	1.5	95	0.18	1.5	-	-	-	495	0.24	1.5	40	0.18	1.2	-	-	-
	T8430	0.4	185	0.20	1.5	100	0.18	1.5	-	-	-	510	0.24	1.5	40	0.18	1.2	-	-	-
	T9325	0.4	230	0.20	1.5	135	0.18	1.5	-	-	-	-	-	-	50	0.18	1.2	-	-	-
TNMG 160408EL-SI	T7325	0.8	190	0.35	1.5	145	0.32	1.5	-	-	-	-	-	-	60	0.25	1.2	-	-	-
	T7335	0.8	180	0.35	1.5	140	0.32	1.5	-	-	-	-	-	-	55	0.25	1.2	-	-	-
	T8315	0.8	175	0.35	1.5	105	0.32	1.5	-	-	-	525	0.42	1.5	40	0.25	1.2	-	-	-
	T8330	0.8	170	0.35	1.5	100	0.32	1.5	-	-	-	510	0.42	1.5	40	0.25	1.2	-	-	-
	T8430	0.8	180	0.35	1.5	95	0.32	1.5	-	-	-	495	0.42	1.5	35	0.25	1.2	-	-	-
	T9325	0.8	215	0.35	1.5	125	0.32	1.5	-	-	-	-	-	-	45	0.25	1.2	-	-	-
T9335	0.8	190	0.35	1.5	110	0.32	1.5	-	-	-	-	-	-	40	0.25	1.2	-	-	-	



TNMM

	IC	D1	L	S
	[mm]	[mm]	[mm]	[mm]
1604	9.525	3.81	16.50	4.76
2204	12.700	5.16	22.00	4.76
2706	15.875	6.35	27.50	6.35

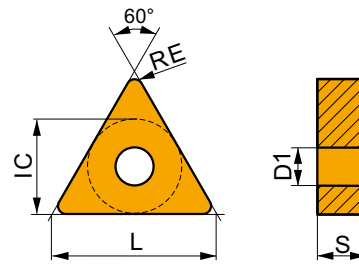

Suitability and starting values for cutting speed (vc), feed (f) and depth of cut (ap). Refer to our Machining Calculator app for further calculations.

Product	RE	P			M			K			N			S			H		
		vc	f	ap	vc	f	ap	vc	f	ap	vc	f	ap	vc	f	ap	vc	f	ap
	[mm]	[m/min]	[mm/rev]	[mm]	[m/min]	[mm/rev]	[mm]	[m/min]	[mm/rev]	[mm]	[m/min]	[mm/rev]	[mm]	[m/min]	[mm/rev]	[mm]	[m/min]	[mm/rev]	[mm]

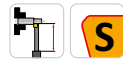
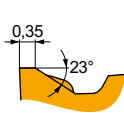

DR geometry for semi-rough to rough machining, and continuous to interrupted cuts.

TNMM 160408E-DR	T9325	0.8	█	175	0.40	4.0	█	105	0.36	4.0	█	165	0.40	4.0	–	–	–	–	–	–
TNMM 220408E-DR	T9325	0.8	█	175	0.40	4.0	█	105	0.36	4.0	█	165	0.40	4.0	–	–	–	–	–	–
	T9335	0.8	█	155	0.40	4.0	█	90	0.36	4.0	–	–	–	–	–	–	–	–	–	
TNMM 220412E-DR	T9315	1.2	█	205	0.40	4.0	–	–	–	█	190	0.40	4.0	–	–	–	–	–	–	
	T9325	1.2	█	185	0.40	4.0	█	110	0.36	4.0	█	175	0.40	4.0	–	–	–	–	–	
	T9335	1.2	█	160	0.40	4.0	█	95	0.36	4.0	–	–	–	–	–	–	–	–		
TNMM 220416E-DR	T9325	1.6	█	195	0.40	4.0	█	115	0.36	4.0	█	185	0.40	4.0	–	–	–	–	–	
TNMM 270616E-DR	T9325	1.6	█	135	0.40	4.0	█	80	0.36	4.0	█	125	0.40	4.0	–	–	–	–	–	
	T9335	1.6	█	110	0.40	4.0	█	65	0.36	4.0	–	–	–	–	–	–	–	–		

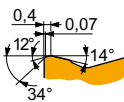

HR geometry for rough to heavy-rough machining, and continuous to interrupted cuts.

TNMM 270616E-HR	T9325	1.6	█	90	0.60	7.0	█	50	0.54	7.0	█	85	0.60	7.0	–	–	–	–	–
	T9335	1.6	█	75	0.60	7.0	█	45	0.54	7.0	–	–	–	–	–	–	–	–	
TNMM 270624E-HR	T9226	2.4	█	80	0.65	7.0	█	45	0.59	7.0	█	75	0.65	7.0	–	–	–	–	–

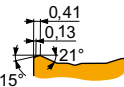

NR2 geometry for semi-rough to rough machining, and continuous to interrupted cuts.

TNMM 160408E-NR2	T9325	0.8	█	165	0.40	3.0	█	95	0.36	3.0	█	155	0.40	3.0	–	–	–	█	35	0.28	2.4
TNMM 220408E-NR2	T7325	0.8	█	145	0.40	4.0	█	110	0.36	4.0	–	–	–	–	–	–	–	█	45	0.28	3.2
	T9325	0.8	█	160	0.40	4.0	█	95	0.36	4.0	█	150	0.40	4.0	–	–	–	█	35	0.28	3.2
TNMM 220412E-NR2	T7325	1.2	█	150	0.40	4.0	█	115	0.36	4.0	–	–	–	–	–	–	–	█	45	0.32	3.2
	T8330	1.2	█	135	0.40	4.0	█	80	0.36	4.0	█	125	0.40	4.0	–	–	–	█	30	0.32	3.2
	T8430	1.2	█	140	0.40	4.0	█	75	0.36	4.0	█	115	0.40	4.0	–	–	–	█	30	0.32	3.2
	T9325	1.2	█	170	0.40	4.0	█	100	0.36	4.0	█	160	0.40	4.0	–	–	–	█	35	0.32	3.2

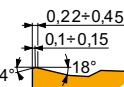

OR geometry for semi-rough to rough machining, and continuous to interrupted cuts.

TNMM 160408E-OR	T9315	0.8	█	185	0.40	3.0	–	–	–	█	175	0.40	3.0	–	–	–	–	–	–	–	
	T9325	0.8	█	165	0.40	3.0	█	95	0.36	3.0	█	155	0.40	3.0	–	–	–	█	35	0.28	2.4
TNMM 160412E-OR	T9325	1.2	█	175	0.40	3.0	█	105	0.36	3.0	█	165	0.40	3.0	–	–	–	█	35	0.32	2.4
TNMM 220408E-OR	T9315	0.8	█	180	0.40	4.0	–	–	–	█	170	0.40	4.0	–	–	–	–	–	–	–	
	T9325	0.8	█	160	0.40	4.0	█	95	0.36	4.0	█	150	0.40	4.0	–	–	–	█	35	0.32	3.2
	T9335	0.8	█	140	0.40	4.0	█	80	0.36	4.0	–	–	–	–	–	–	–	█	30	0.32	3.2
TNMM 220412E-OR	T9325	1.2	█	175	0.40	3.0	█	105	0.36	3.0	█	165	0.40	3.0	–	–	–	█	35	0.32	2.4
	T9335	1.2	█	150	0.40	3.0	█	90	0.36	3.0	–	–	–	–	–	–	–	█	30	0.32	2.4



Suitability and starting values for cutting speed (vc), feed (f) and depth of cut (ap). Refer to our Machining Calculator app for further calculations.

Product	RE [mm]	P			M			K			N			S			H		
		vc [m/min]	f [mm/rev]	ap [mm]	vc [m/min]	f [mm/rev]	ap [mm]	vc [m/min]	f [mm/rev]	ap [mm]	vc [m/min]	f [mm/rev]	ap [mm]	vc [m/min]	f [mm/rev]	ap [mm]	vc [m/min]	f [mm/rev]	ap [mm]

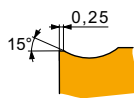

ER geometry with right-handed design for medium to semi-rough machining, and continuous cuts.

TNMM 220412ER	T9335	1.2	190	0.35	2.1	110	0.32	2.1	-	-	-	-	-	-	40	0.25	1.7	-	-	-
---------------	-------	-----	-----	------	-----	-----	------	-----	---	---	---	---	---	---	----	------	-----	---	---	---

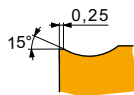

EL geometry with left handed design for medium to semi-rough machining, and continuous cuts.

TNMM 220412EL	T9335	1.2	190	0.35	2.1	110	0.32	2.1	-	-	-	-	-	40	0.25	1.7	-	-	-
---------------	-------	-----	-----	------	-----	-----	------	-----	---	---	---	---	---	----	------	-----	---	---	---

TNGA CER



	IC [mm]	D1 [mm]	L [mm]	S [mm]
1604	9.525	3.81	16.50	4.76

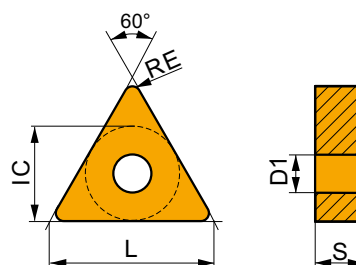

Suitability and starting values for cutting speed (vc), feed (f) and depth of cut (ap). Refer to our Machining Calculator app for further calculations.

Product	RE [mm]	P			M			K			N			S			H		
		vc [m/min]	f [mm/rev]	ap [mm]	vc [m/min]	f [mm/rev]	ap [mm]	vc [m/min]	f [mm/rev]	ap [mm]	vc [m/min]	f [mm/rev]	ap [mm]	vc [m/min]	f [mm/rev]	ap [mm]	vc [m/min]	f [mm/rev]	ap [mm]

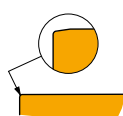

For machining with high speeds and continuous cuts.

TNGA 160408 T01020	TC100	0.8	-	-	-	-	-	-	475	0.20	1.5	-	-	-	-	-	-	-	-	-
TNGA 160412 T01020	TC100	1.2	-	-	-	-	-	-	500	0.20	1.5	-	-	-	-	-	-	-	-	-



TNGN CER

	IC	L	S
	[mm]	[mm]	[mm]
1604	9.525	16.50	4.76
1607	9.525	16.50	7.94

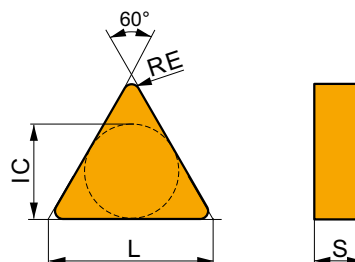

Suitability and starting values for cutting speed (vc), feed (f) and depth of cut (ap). Refer to our Machining Calculator app for further calculations.

Product	RE	P			M			K			N			S			H		
		vc	f	ap	vc	f	ap	vc	f	ap	vc	f	ap	vc	f	ap	vc	f	ap
	[mm]	[m/min]	[mm/rev]	[mm]	[m/min]	[mm/rev]	[mm]	[m/min]	[mm/rev]	[mm]	[m/min]	[mm/rev]	[mm]	[m/min]	[mm/rev]	[mm]	[m/min]	[mm/rev]	[mm]

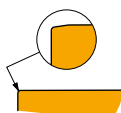

For machining with high speeds and continuous cuts.

TNGN 160408 T01020	TC100	0.8	-	-	-	-	-	-	475	0.20	1.5	-	-	-	-	-	-	-	-	-
TNGN 160412 T01020	TC100	1.2	-	-	-	-	-	-	500	0.20	1.5	-	-	-	-	-	-	-	-	-
TNGN 160708 T02020	TC100	0.8	-	-	-	-	-	-	475	0.20	1.5	-	-	-	-	-	-	-	-	-

TNGA CBN

	IC	D1	L	S
	[mm]	[mm]	[mm]	[mm]
1604	9.525	3.81	16.50	4.76

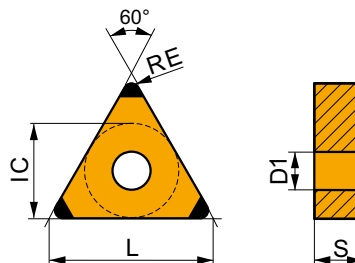

Suitability and starting values for cutting speed (vc), feed (f) and depth of cut (ap). Refer to our Machining Calculator app for further calculations.

Product	RE	P			M			K			N			S			H		
		vc	f	ap	vc	f	ap	vc	f	ap	vc	f	ap	vc	f	ap	vc	f	ap
	[mm]	[m/min]	[mm/rev]	[mm]	[m/min]	[mm/rev]	[mm]	[m/min]	[mm/rev]	[mm]	[m/min]	[mm/rev]	[mm]	[m/min]	[mm/rev]	[mm]	[m/min]	[mm/rev]	[mm]

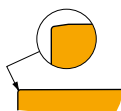

For finish machining and continuous cuts.

TNGA 160408S01020C	TB310	0.8	-	-	-	-	-	-	450	0.15	0.6	-	-	-	115	0.11	0.5	95	0.15	1.0
--------------------	-------	-----	---	---	---	---	---	---	-----	------	-----	---	---	---	-----	------	-----	----	------	-----



DTFN(RL) EXT

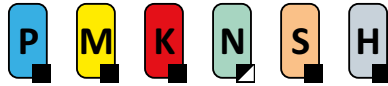

External Double Clamp Holder with 91° (Face) Cutting Angle for TN.. Insert

External Right/Left hand double clamp tool holder with 91° cutting angle. Suited for face turning with shoulder and chamfering with negative TN.. 16 or 22 size inserts. Available in 20x20 and 25x25 mm shank. Body treated for longer tool life.

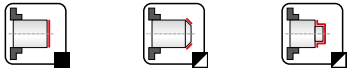
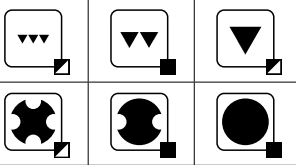
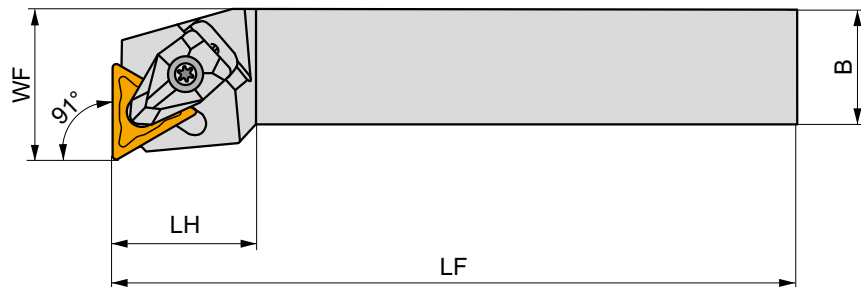
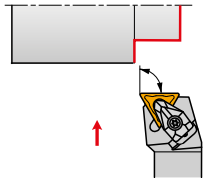

Product	H	B	HF	WF	LF	LH	LAMS	GAMO	kg			
	[mm]	[mm]	[mm]	[mm]	[mm]	[mm]	[°]	[°]				
R	DTFNR 2020 K 16	20	20	20	25	125	23.6	-6	-6	0.43	GI024	DT16
	DTFNR 2525 M 16	25	25	25	32	150	23.6	-6	-6	0.77	GI024	DT16
	DTFNR 2525 M 22	25	25	25	32	150	30.5	-6	-6	0.79	GI025	DT22
L	DTFNL 2020 K 16	20	20	20	25	125	23.6	-6	-6	0.43	GI024	DT16
	DTFNL 2525 M 16	25	25	25	32	150	23.6	-6	-6	0.76	GI024	DT16
	DTFNL 2525 M 22	25	25	25	32	150	30.5	-6	-6	0.79	GI025	DT22



GI024

TN.. 1604..

GI025

TN.. 2204..



DT16

DCS 09

1.7

DTS 315-02

US 2004-T09P

FLAG T09P

DT22

DCS 12

3.9

DTS 315-04

US 2002-T15P

FLAG T15P/3,5



DTGN(RL) EXT



PRAMET

D



External Double Clamp Holder with 91° Cutting Angle for TN.. Insert

External Right/Left hand double clamp tool holder with 91° cutting angle. Suited for longitudinal turning with shoulder, taper turning and chamfering with negative TN.. 16 or 22 size inserts. Available in 20x20 up to 32x32 mm shank. Body treated for longer tool life.

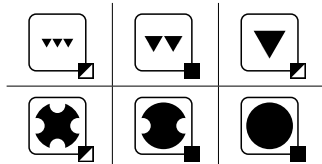
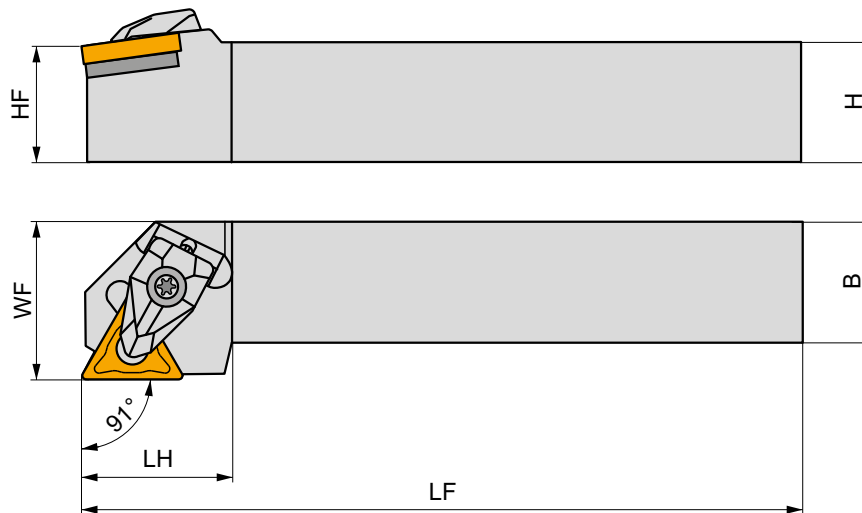
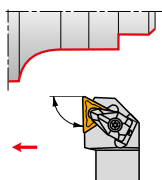

Product	H	B	HF	WF	LF	LH	LAMS	GAMO	kg	GI	DT
	[mm]	[mm]	[mm]	[mm]	[mm]	[mm]	[°]	[°]			
R DTGNR 2020 K 16	20	20	20	25	125	25.4	-6	-6	0.43	GI024	DT16
DTGNR 2525 M 16	25	25	25	32	150	24.6	-6	-6	0.76	GI024	DT16
DTGNR 2525 M 22	25	25	25	32	150	32.1	-6	-6	0.83	GI025	DT22
DTGNR 3232 P 22	32	32	32	40	170	33.1	-6	-6	1.42	GI025	DT22
L DTGNL 2020 K 16	20	20	20	25	125	25.4	-6	-6	0.44	GI024	DT16
DTGNL 2525 M 16	25	25	25	32	150	24.6	-6	-6	0.78	GI024	DT16
DTGNL 2525 M 22	25	25	25	32	150	32.1	-6	-6	0.78	GI025	DT22
DTGNL 3232 P 22	32	32	32	40	170	33.1	-6	-6	1.42	GI025	DT22



GI024

TN.. 1604..

GI025

TN.. 2204..



DT16

DCS 09

1.7

DTS 315-02

US 2004-T09P

FLAG T09P

DT22

DCS 12

3.9

DTS 315-04

US 2002-T15P

FLAG T15P/3,5



MTJN(RL) EXT



PRAMET

M



External Multi-Clamp Holder with 93° Cutting Angle for TN.. Insert

External Right/Left hand multi-clamp tool holder with 93° cutting angle. Suited for longitudinal turning with shoulder, taper and copy turning up to 22°, and chamfering with negative TN.. 16 or 22 size inserts. Available in 20x20 up to 32x32 mm shank. Body treated for longer tool life.

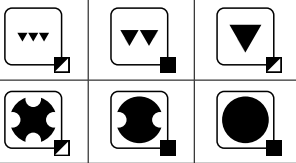
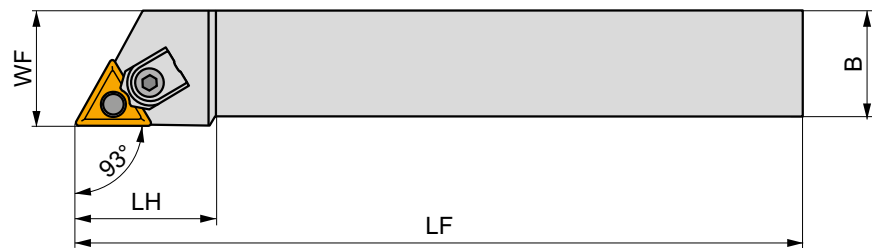
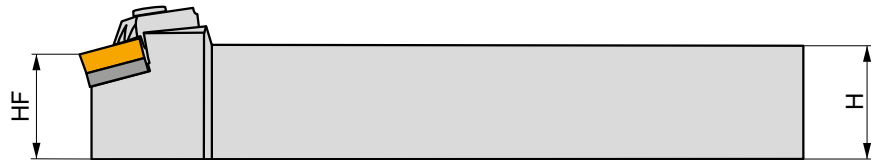
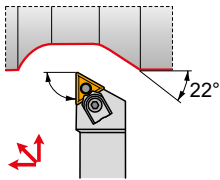

Product	H	B	HF	WF	LF	LH	LAMS	GAMO	kg	GI024	GI025	
	[mm]	[mm]	[mm]	[mm]	[mm]	[mm]	[°]	[°]				
R	MTJNR 2020 K 16	20	20	20	25	125	34	-6	-6	0.42	GI024	MT16
	MTJNR 2525 M 16	25	25	25	32	150	34	-6	-6	0.73	GI024	MT16
	MTJNR 3232 P 22	32	32	32	40	175	42	-6	-6	1.37	GI025	MT22
L	MTJNL 2020 K 16	20	20	20	25	125	34	-6	-6	0.43	GI024	MT16
	MTJNL 2525 M 16	25	25	25	32	150	34	-6	-6	0.75	GI024	MT16
	MTJNL 3232 P 22	32	32	32	40	175	42	-6	-6	1.38	GI025	MT22



GI024

TN.. 1604..

GI025

TN.. 2204..



MT16

UE 16

3.0

MTN 160312

UC 52

HS 93

HXK 5

MT22

UE 22

5.0

MTN 220612

UC 53

HS 94

HXK 5



PTFN(RL) EXT



PRAMET

P



External Lever Lock Holder with 90° (Face) Cutting Angle for TN.. Insert

External Right/Left hand lever lock tool holder with 90° cutting angle. Suited for face turning with shoulder and chamfering with negative TN.. 16, 22 or 27 size inserts. Available in 16x16 up to 40x40 mm shank. Body treated for longer tool life.

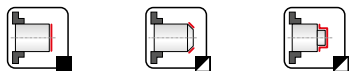
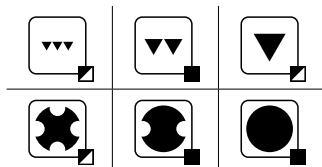
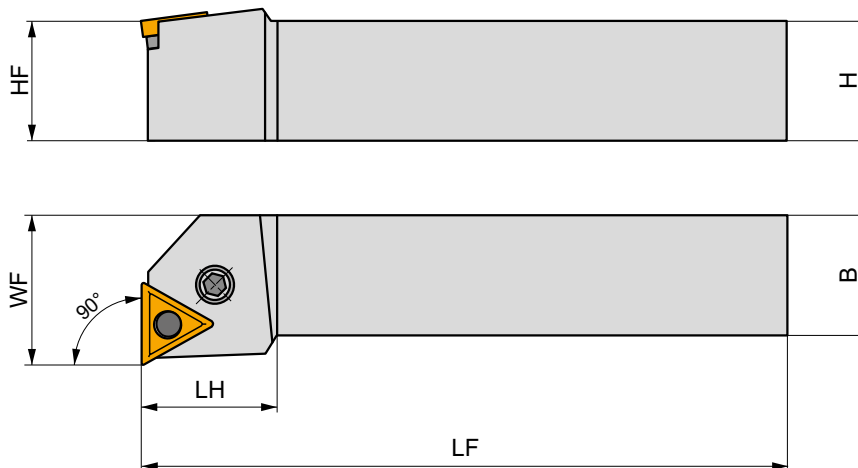
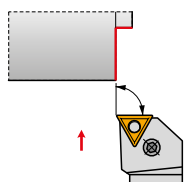

	Product	≠	B	HF	WF	LF	LH	LAMS	GAMO	kg		
		[mm]	[mm]	[mm]	[mm]	[mm]	[mm]	[°]	[°]			
R	PTFNR 1616 H 16	16	16	16	20	100	32	-6	-6	0.23	G1024	PT11
	PTFNR 2020 K 16	20	20	20	25	125	32	-6	-6	0.44	G1024	PT10
	PTFNR 2525 M 16	25	25	25	32	150	32	-6	-6	0.76	G1024	PT10
	PTFNR 2525 M 22	25	25	25	32	150	36	-6	-6	0.79	G1025	PT20
	PTFNR 3225 P 22	32	25	32	32	170	36	-6	-6	1.05	G1025	PT20
	PTFNR 4040 R 27	40	40	40	50	200	40	-6	-6	2.55	G1077	PT40
L	PTFNL 1616 H 16	16	16	16	20	100	32	-6	-6	0.24	G1024	PT11
	PTFNL 2020 K 16	20	20	20	25	125	32	-6	-6	0.43	G1024	PT10
	PTFNL 2525 M 16	25	25	25	32	150	32	-6	-6	0.65	G1024	PT10
	PTFNL 2525 M 22	25	25	25	32	150	36	-6	-6	0.79	G1025	PT20
	PTFNL 3225 P 22	32	25	32	32	170	36	-6	-6	1.14	G1025	PT20
	PTFNL 4040 R 27	40	40	40	50	200	40	-6	-6	2.55	G1077	PT40



G1024

TN.. 1604..

G1025

TN.. 2204..

G1077

TN.. 2706..



PT10

TNU 160308

PU 01

US 34

5.0

M 6x0.75

19

NT 04

MT 04

HXK 3

PT11

TNU 160308

PU 01

US 46

5.0

M 6x0.75

13.2

NT 04

MT 04

HXK 3

PT20

TNU 220312

PU 02

US 35

6.0

M 8x1

22.5

NT 05

MT 05

HXK 4

PT40

TNU 270416

PU 04

US 36

6.0

M 8x1

26

NT 07

MT 07

HXK 4



PTGN(RL) EXT

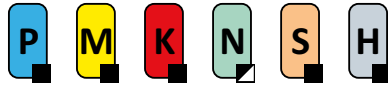

External Lever Lock Holder with 90° Cutting Angle for TN.. Insert

External Right/Left hand lever lock tool holder with 90° cutting angle. Suited for longitudinal turning with shoulder, taper turning and chamfering with negative TN.. 16, 22 or 27 size inserts. Available in 16x16 up to 40x40 mm shank. Body treated for longer tool life.

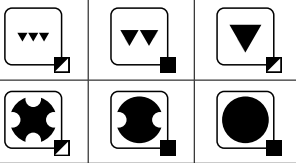
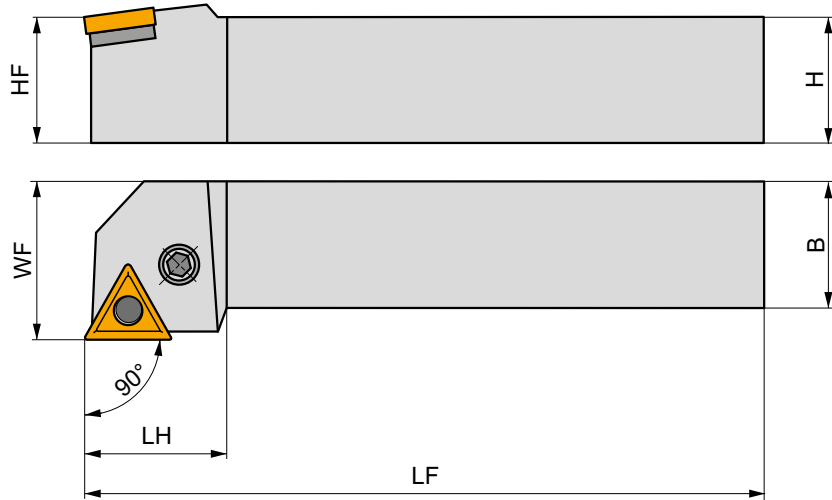
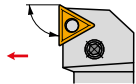

Product	H	B	HF	WF	LF	LH	LAMS	GAMO	kg	G1024	G1025	G1077
	[mm]	[mm]	[mm]	[mm]	[mm]	[mm]	[°]	[°]				
R	PTGNR 1616 H 16	16	16	16	20	100	32	-6	-6	0.24	G1024	PT11
	PTGNR 2020 K 16	20	20	20	25	125	32	-6	-6	0.40	G1024	PT10
	PTGNR 2525 M 16	25	25	25	32	150	32	-6	-6	0.73	G1024	PT10
	PTGNR 2525 M 22	25	25	25	32	150	36	-6	-6	0.75	G1025	PT20
	PTGNR 3225 P 22	32	25	32	32	170	36	-6	-6	1.11	G1025	PT20
	PTGNR 3232 P 22	32	32	32	40	170	36	-6	-6	1.39	G1025	PT20
PTGNR 4040 R 27	40	40	40	50	200	40	-6	-6	2.55	G1077	PT40	
L	PTGNL 1616 H 16	16	16	16	20	100	32	-6	-6	0.25	G1024	PT11
	PTGNL 2020 K 16	20	20	20	25	125	32	-6	-6	0.40	G1024	PT10
	PTGNL 2525 M 16	25	25	25	32	150	32	-6	-6	0.77	G1024	PT10
	PTGNL 2525 M 22	25	25	25	32	150	36	-6	-6	0.79	G1025	PT20
	PTGNL 3225 P 22	32	25	32	32	170	36	-6	-6	1.11	G1025	PT20
	PTGNL 3232 P 22	32	32	32	40	170	36	-6	-6	1.40	G1025	PT20
PTGNL 4040 R 27	40	40	40	50	200	40	-6	-6	2.40	G1077	PT40	



G1024



TN.. 1604..

G1025

TN.. 2204..

G1077

TN.. 2706..



PT10

TNU 160308

PU 01

US 34

5.0

M 6x0.75

19

NT 04

MT 04

HXK 3

PT11

TNU 160308

PU 01

US 46

5.0

M 6x0.75

13.2

NT 04

MT 04

HXK 3

PT20

TNU 220312

PU 02

US 35

6.0

M 8x1

22.5

NT 05

MT 05

HXK 4

PT40

TNU 270416

PU 04

US 36

6.0

M 8x1

26

NT 07

MT 07

HXK 4



PTTN(RL) EXT



PRAMET

P



External Lever Lock Holder with 60° Cutting Angle for TN.. Insert

External Right/Left hand lever lock tool holder with 60° cutting angle. Suited for longitudinal turning with shoulder, taper and copy turning up to 30° and chamfering with negative TN.. 16 and 22 size inserts. Available in 20x20 up to 32x25 mm shank. Body treated for longer tool life.

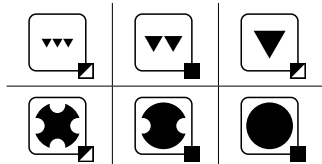
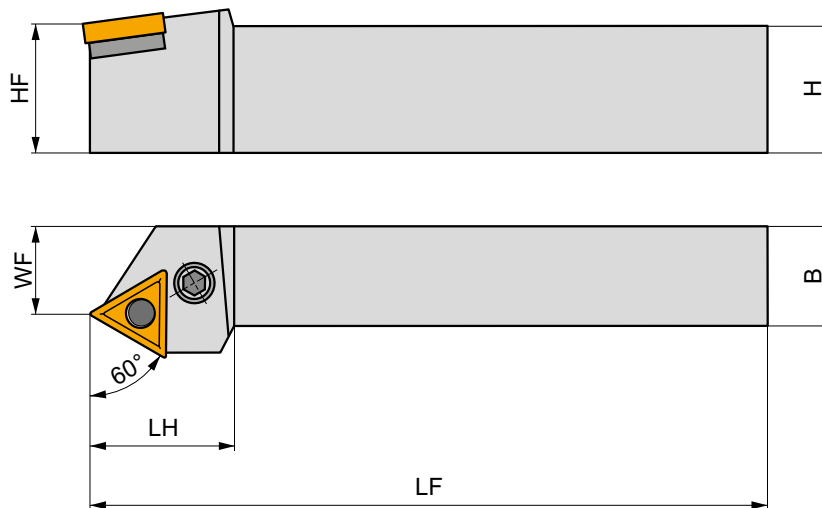
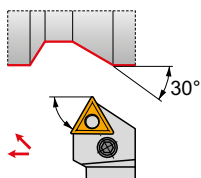

	Product	H	B	HF	WF	LF	LH	LAMS	GAMO	kg		
		[mm]	[mm]	[mm]	[mm]	[mm]	[mm]	[°]	[°]			
R	PTTNR 2020 K 16	20	20	20	17	125	32	-6	-6	0.43	GI024	PT10
	PTTNR 2525 M 16	25	25	25	22	150	32	-6	-6	0.63	GI024	PT10
	PTTNR 2525 M 22	25	25	25	22	150	36	-6	-6	0.73	GI025	PT20
	PTTNR 3225 P 22	32	25	32	22	170	36	-6	-6	1.07	GI025	PT20
L	PTTNL 2020 K 16	20	20	20	17	125	32	-6	-6	0.38	GI024	PT10
	PTTNL 3225 P 22	32	25	32	22	170	36	-6	-6	1.04	GI025	PT20



GI024
GI025

TN.. 1604..
TN.. 2204..



PT10
PT20

TNU 160308
TNU 220312

PU 01
PU 02

US 34
US 35

5.0
6.0

M 6x0.75
M 8x1

19
22.5

NT 04
NT 05

MT 04
MT 05

HXK 3
HXK 4



C.-DTJN(RL) EXT

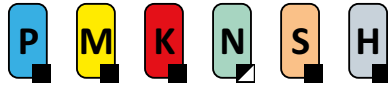

External PSC Quick Change Tool, Double Clamp, 93° Cutting Angle, TN.. Insert

External Right/Left hand double clamp tool, through coolant, with 93° cutting angle for longitudinal turning with shoulder, taper turning and chamfering with negative TN.. 16 size inserts. Available with PSC (Polygon Shank Coupling) C4 and C5 shank. Body treated for longer tool life.

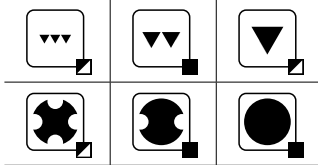
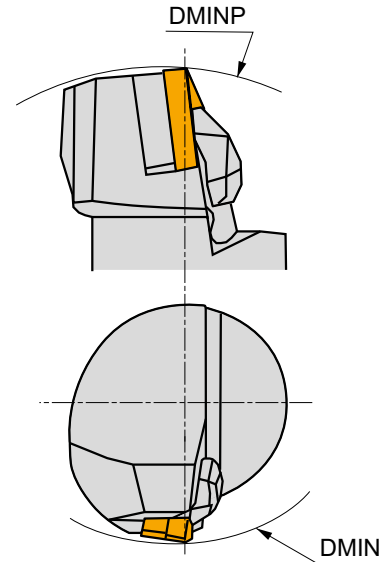
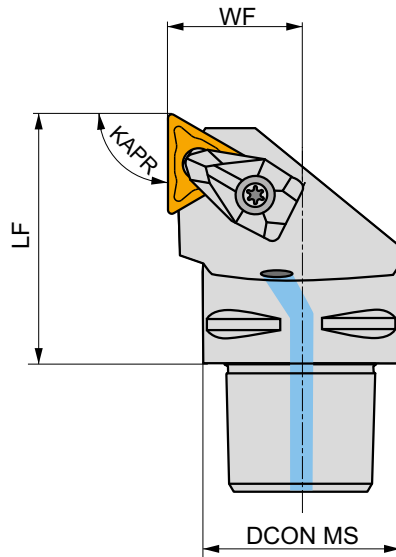
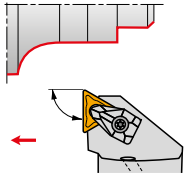

Product	DCON MS	DMIN	DMINP	WF	LF	KAPR	LAMS	GAMO				
	[mm]	[mm]	[mm]	[mm]	[mm]	[°]	[°]	[°]				
R C4-DTJNR-27050-16	40	110	140	27	50	93	-6	-6	✓	0.43	GI024	C-DT16
	C5-DTJNR-35060-16	50	110	165	35	60	93	-6	-6	✓	0.79	GI024
L C4-DTJNL-27050-16	40	110	140	27	50	93	-6	-6	✓	0.44	GI024	C-DT16
	C5-DTJNL-35060-16	50	110	165	35	60	93	-6	-6	✓	0.79	GI024



GI024



TN.. 1604..



C-DT16



DCS 09



1.7



DTS 315-02



US 2004-T09P



FLAG T09P



CN 045-01



DTFN(RL) INT



Internal Double Clamp Holder with 91° Cutting Angle for TN.. Insert

Internal Right/Left hand double clamp boring bar, through coolant, 91° cutting angle for TN.. 16 and 22 inserts. Minimum internal turning diameter Ø32 mm. For internal taper and longitudinal turning with shoulder and chamfer turning. Available with shank size Ø25 up to Ø40 mm. Body treated for longer tool life.

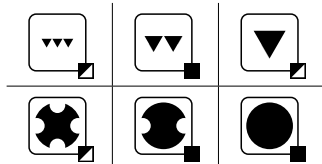
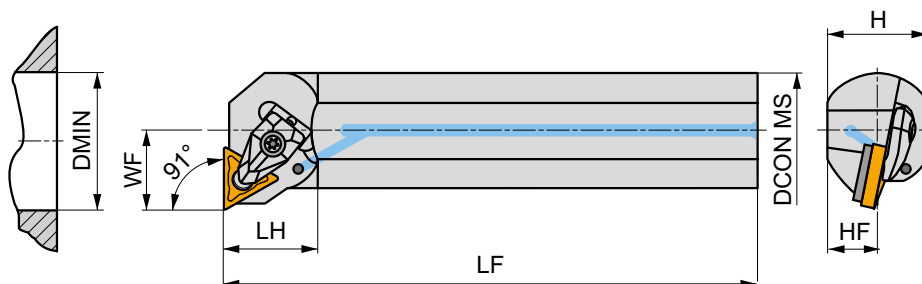
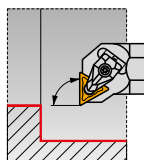

	Product	DCON MS	DMIN	WF	H	HF	LF	LH	LAMS	GAMO				
		[mm]	[mm]	[mm]	[mm]	[mm]	[mm]	[mm]	[°]	[°]				
R	A25T-DTFNR 16	25	32	17	23	11.5	300	32	-12	-6	✓	0.96	G1024	DT116
	A32T-DTFNR 16	32	40	22	30	15	300	33	-10	-6	✓	1.67	G1024	DT116
	A40T-DTFNR 22	40	50	27	37	18.5	300	36	-13	-6	✓	2.58	G1025	DT22
L	A25T-DTFNL 16	25	32	17	23	11.5	300	32	-12	-6	✓	0.96	G1024	DT116
	A32T-DTFNL 16	32	40	22	30	15	300	33	-10	-6	✓	1.67	G1024	DT116
	A40T-DTFNL 22	40	50	27	37	18.5	300	36	-13	-6	✓	2.58	G1025	DT22



G1024
G1025

TN.. 1604..
TN.. 2204..



DT22
DT116

DCS 12
DCS 09

3.9
1.7

DTS 315-04
DTS 316-01

US 2002-T15P
US 2004-T09P

FLAG T15P/3,5
FLAG T09P



PTFN(RL) INT



PRAMET

P



Internal Lever Lock Holder with 90° Cutting Angle for TN.. Insert

Internal Right/Left hand lever lock boring bar, through coolant available, 90° cutting angle for TN.. 16 and 22 inserts. Minimum internal turning diameter Ø32 mm. For internal taper and longitudinal turning with shoulder and chamfer turning. Ø25 up to Ø40 mm shanks available. Body treated for longer tool life.

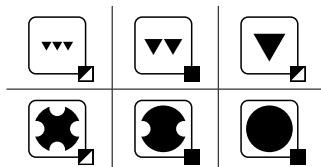
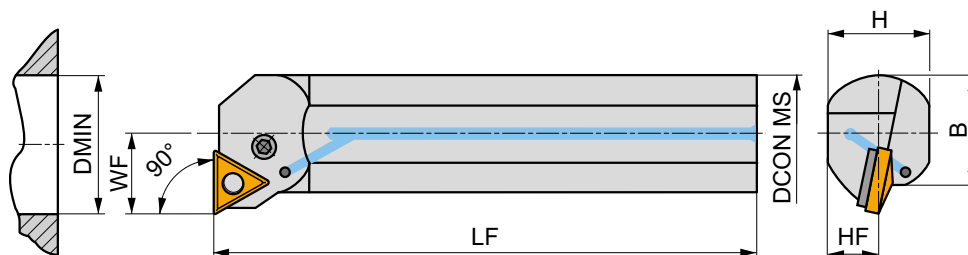
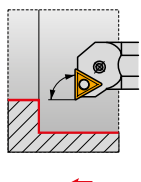

Product	DCON MS	DMIN	WF	H	B	LF	LAMS	GAMO					
	[mm]	[mm]	[mm]	[mm]	[mm]	[mm]	[°]	[°]					
R	A25R-PTFNR 16	25	32	17	23	23	200	-12	-6	✓	0.74	GI024	PT11
	A32S-PTFNR 16	32	40	22	30	30	250	-12	-6	✓	1.49	GI024	PT10
	A40T-PTFNR 22	40	50	27	38	38	300	-12	-6	✓	2.58	GI025	PT20
L	A25R-PTFNL 16	25	32	17	23	23	200	-12	-6	✓	0.74	GI024	PT11
	A32S-PTFNL 16	32	40	22	30	30	250	-12	-6	✓	1.48	GI024	PT10
	A40T-PTFNL 22	40	50	27	38	38	300	-12	-6	✓	2.90	GI025	PT20



GI024

TN.. 1604..

GI025

TN.. 2204..



PT10

TNU 160308

PU 01

US 34

5.0

M 6x0.75

19

NT 04

MT 04

HXK 3

PT11

TNU 160308

PU 01

US 46

5.0

M 6x0.75

13.2

NT 04

MT 04

HXK 3

PT20

TNU 220312

PU 02

US 35

6.0

M 8x1

22.5

NT 05

MT 05

HXK 4



C.-DTFN(RL) INT



PRAMET

D



Internal PSC Quick Change Tool, Double Clamp, 91° Cutting Angle, TN.. Insert

Internal Right/Left hand double clamp tool, through coolant, with 91° cutting angle for a wide range of internal turning applications with TN.. 16 inserts, minimum turning diameter Ø32mm. PSC shank (Polygon Shank Coupling) size C4 with turning length of 68 mm. Body treated for longer tool life.

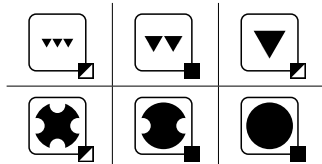
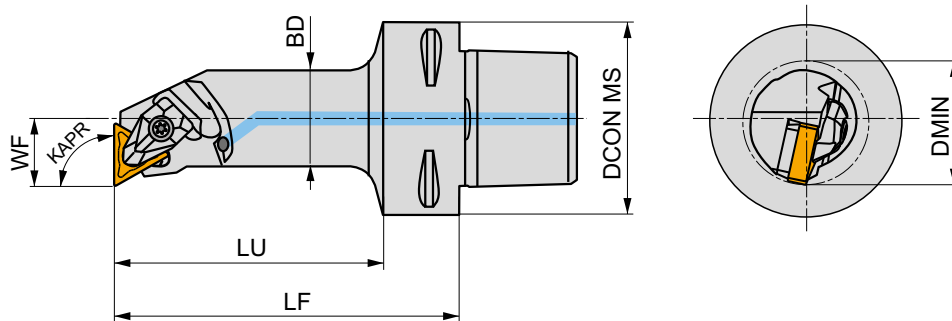
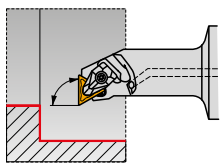

Product	DCON MS [mm]	DMIN [mm]	WF [mm]	LF [mm]	LU [mm]	BD [mm]	KAPR [°]	LAMS [°]	GAMO [°]				
R C4-DTFNR-17090-16	40	32	17	90	68	25	91	-12	-6	✓	0.51	GI024	DTI16

	GI024												
							TN.. 1604..						

DTI16	DCS 09	1.7		DTS 316-01	US 2004-T09P	FLAG T09P



CARBIDE INSERTS

VNMG



356

CER AND CBN INSERTS

VNGA CER



359

VNGA CBN



359

MATCH THE RIGHT SIZE (example)

Insert

VNMG 160404E-SF

Tool Holder

DVJNL 2020 K 16

ISO TURNING – EXTERNAL

DVJN(RL) EXT

93°

VN..

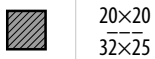
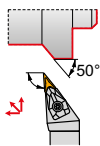

16

20×20
32×25

360

356 – 359

DVPN(RL) EXT

62°30'

VN..

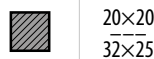
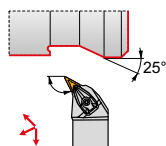

16

20×20
32×25

361

356 – 359

MVJN(RL) EXT

93°

VN..

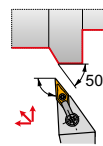

16

20×20
32×25

362

356 – 359

C.-DVJN(RL) EXT

93°

VN..

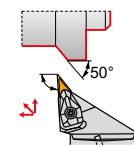

16

C4
C6

363

356 – 359

ISO TURNING – INTERNAL

DVUN(RL) INT

VN..



16

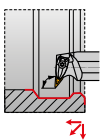

50

364

356 – 359



VNMG



IC

D1

L

S

[mm]

[mm]

[mm]

[mm]

1604

9.525

3.81

16.60

4.76

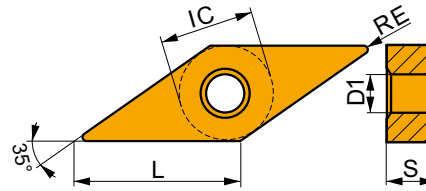

Suitability and starting values for cutting speed (vc), feed (f) and depth of cut (ap). Refer to our Machining Calculator app for further calculations.

Product	RE [mm]	P			M			K			N			S			H		
		vc [m/min]	f [mm/rev]	ap [mm]	vc [m/min]	f [mm/rev]	ap [mm]	vc [m/min]	f [mm/rev]	ap [mm]	vc [m/min]	f [mm/rev]	ap [mm]	vc [m/min]	f [mm/rev]	ap [mm]	vc [m/min]	f [mm/rev]	ap [mm]

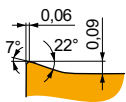

FF geometry with highly positive design for fine-finish machining and continuous to slightly interrupted cuts.

VNMG 160404E-FF	T7325	0.4	165	0.12	1.0	125	0.11	1.0	—	—	—	—	—	—	—	—	—	—
	T8315	0.4	150	0.12	1.0	90	0.11	1.0	140	0.12	1.0	—	—	—	—	—	—	—
	T8330	0.4	140	0.12	1.0	80	0.11	1.0	130	0.12	1.0	—	—	—	—	—	—	—
	T8430	0.4	175	0.12	1.0	95	0.11	1.0	140	0.12	1.0	—	—	—	—	—	—	—

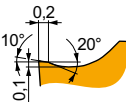

FM geometry with positive design for finish to semi-rough machining and continuous to slightly interrupted cuts.

VNMG 160404E-FM	T7325	0.4	140	0.20	1.2	105	0.18	1.2	—	—	—	45	0.20	1.0	—	—	—
	T8330	0.4	120	0.20	1.2	70	0.18	1.2	110	0.20	1.2	30	0.14	1.0	—	—	—
	T8430	0.4	135	0.20	1.2	75	0.18	1.2	110	0.20	1.2	25	0.14	1.0	—	—	—
	T9310	0.4	210	0.20	1.2	—	—	—	195	0.20	1.2	—	—	—	—	—	—
	T9315	0.4	190	0.20	1.2	—	—	—	180	0.20	1.2	—	—	—	—	—	—
	T9325	0.4	170	0.20	1.2	100	0.18	1.2	160	0.20	1.2	35	0.20	1.0	—	—	—
VNMG 160408E-FM	T7325	0.8	160	0.20	1.4	120	0.18	1.4	—	—	—	50	0.16	1.1	—	—	—
	T8330	0.8	145	0.20	1.4	85	0.18	1.4	135	0.20	1.4	35	0.16	1.1	—	—	—
	T8430	0.8	165	0.20	1.4	90	0.18	1.4	135	0.20	1.4	35	0.16	1.1	—	—	—
	T9310	0.8	245	0.20	1.4	—	—	—	230	0.20	1.4	—	—	—	—	—	—
	T9315	0.8	220	0.20	1.4	—	—	—	205	0.20	1.4	—	—	—	—	—	—
	T9325	0.8	200	0.20	1.4	120	0.18	1.4	190	0.20	1.4	45	0.16	1.1	—	—	—
VNMG 160412E-FM	T7325	1.2	165	0.22	1.4	125	0.20	1.4	—	—	—	50	0.18	1.1	—	—	—
	T8330	1.2	150	0.22	1.4	90	0.20	1.4	140	0.22	1.4	35	0.18	1.1	—	—	—
	T8430	1.2	165	0.22	1.4	90	0.20	1.4	135	0.22	1.4	35	0.18	1.1	—	—	—
	T9315	1.2	225	0.22	1.4	—	—	—	210	0.22	1.4	—	—	—	—	—	—
	T9325	1.2	200	0.22	1.4	120	0.20	1.4	190	0.22	1.4	45	0.18	1.1	—	—	—

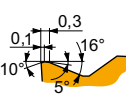

M geometry for finish to semi-rough machining and continuous to interrupted cuts.

VNMG 160404E-M	T5315	0.4	180	0.20	1.2	—	—	—	170	0.20	1.2	—	—	—	35	0.15	1.0
	T9315	0.4	170	0.20	1.2	—	—	—	160	0.20	1.2	—	—	—	30	0.15	1.0
	T9325	0.4	155	0.20	1.2	—	—	—	145	0.20	1.2	—	—	—	—	—	—
	T9335	0.4	130	0.20	1.2	—	—	—	—	—	—	—	—	—	—	—	—
VNMG 160408E-M	T5305	0.8	205	0.30	1.4	—	—	—	190	0.30	1.4	—	—	—	40	0.15	1.0
	T5315	0.8	185	0.30	1.4	—	—	—	175	0.30	1.4	—	—	—	35	0.15	1.0
	T9310	0.8	185	0.30	1.4	—	—	—	175	0.30	1.4	—	—	—	35	0.15	1.0
	T9315	0.8	170	0.30	1.4	—	—	—	160	0.30	1.4	—	—	—	30	0.15	1.0
	T9325	0.8	150	0.30	1.4	—	—	—	140	0.30	1.4	—	—	—	—	—	—
	T9335	0.8	130	0.30	1.4	—	—	—	—	—	—	—	—	—	—	—	—
VNMG 160412E-M	T9325	1.2	140	0.40	1.4	—	—	—	130	0.40	1.4	—	—	—	—	—	—



Suitability and starting values for cutting speed (vc), feed (f) and depth of cut (ap). Refer to our Machining Calculator app for further calculations.

Product	RE [mm]	P			M			K			N			S			H		
		vc [m/min]	f [mm/rev]	ap [mm]	vc [m/min]	f [mm/rev]	ap [mm]	vc [m/min]	f [mm/rev]	ap [mm]	vc [m/min]	f [mm/rev]	ap [mm]	vc [m/min]	f [mm/rev]	ap [mm]	vc [m/min]	f [mm/rev]	ap [mm]

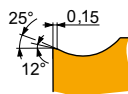

NF geometry with highly positive design for fine-finish to medium machining, and continuous cuts.

VNMG 160404E-NF	T6310	0.4	140	0.12	1.2	100	0.11	1.2	110	0.12	1.2	420	0.14	1.2	40	0.11	1.0	-	-	-
	T7325	0.4	140	0.18	1.2	105	0.16	1.2	-	-	-	-	-	-	45	0.16	1.0	-	-	-
	T7335	0.4	140	0.18	1.2	105	0.16	1.2	-	-	-	-	-	-	45	0.16	1.0	-	-	-
	T8315	0.4	150	0.12	1.2	90	0.11	1.2	140	0.12	1.2	450	0.14	1.2	35	0.11	1.0	-	-	-
	T8330	0.4	140	0.12	1.2	80	0.11	1.2	130	0.12	1.2	420	0.14	1.2	35	0.11	1.0	-	-	-
	T8430	0.4	175	0.12	1.2	95	0.11	1.2	140	0.12	1.2	480	0.14	1.2	35	0.11	1.0	-	-	-
	T9315	0.4	235	0.12	1.2	-	-	-	220	0.12	1.2	-	-	-	-	-	-	-	-	-
	T9325	0.4	180	0.18	1.2	105	0.16	1.2	170	0.18	1.2	-	-	-	40	0.16	1.0	-	-	-
	T9325	0.4	180	0.18	1.2	105	0.16	1.2	170	0.18	1.2	-	-	-	40	0.16	1.0	-	-	-
VNMG 160408E-NF	T6310	0.8	145	0.17	1.4	100	0.15	1.4	115	0.17	1.4	435	0.20	1.4	40	0.14	1.1	-	-	-
	T7325	0.8	165	0.18	1.4	125	0.16	1.4	-	-	-	-	-	50	0.16	1.1	-	-	-	
	T7335	0.8	160	0.18	1.4	120	0.16	1.4	-	-	-	-	-	50	0.16	1.1	-	-	-	
	T8315	0.8	160	0.17	1.4	95	0.15	1.4	150	0.17	1.4	480	0.20	1.4	40	0.14	1.1	-	-	-
	T8330	0.8	150	0.17	1.4	90	0.15	1.4	140	0.17	1.4	450	0.20	1.4	35	0.14	1.1	-	-	-
	T8430	0.8	175	0.17	1.4	95	0.15	1.4	140	0.17	1.4	480	0.20	1.4	35	0.14	1.1	-	-	-
	T9315	0.8	240	0.17	1.4	-	-	-	225	0.17	1.4	-	-	-	-	-	-	-	-	-
	T9325	0.8	210	0.18	1.4	125	0.16	1.4	195	0.18	1.4	-	-	-	45	0.16	1.1	-	-	-
	T9325	0.8	210	0.18	1.4	125	0.16	1.4	195	0.18	1.4	-	-	-	45	0.16	1.1	-	-	-

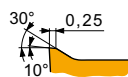

NM geometry with highly positive design for fine-finish, medium and rough machining, with continuous cuts.

VNMG 160404E-NM	T7325	0.4	145	0.20	1.2	110	0.18	1.2	-	-	-	-	-	45	0.20	1.0	-	-	-	
	T7335	0.4	140	0.20	1.2	105	0.18	1.2	-	-	-	-	-	45	0.20	1.0	-	-	-	
	T8315	0.4	135	0.20	1.2	80	0.18	1.2	-	-	-	405	0.24	1.2	30	0.20	1.0	-	-	-
	T8330	0.4	125	0.20	1.2	75	0.18	1.2	-	-	-	375	0.24	1.2	30	0.20	1.0	-	-	-
	T8430	0.4	145	0.20	1.2	80	0.18	1.2	-	-	-	405	0.24	1.2	30	0.20	1.0	-	-	-
	T9325	0.4	180	0.20	1.2	105	0.18	1.2	-	-	-	-	-	-	40	0.20	1.0	-	-	-
VNMG 160408E-NM	T7325	0.8	160	0.25	1.4	120	0.23	1.4	-	-	-	-	-	50	0.20	1.1	-	-	-	
	T7335	0.8	155	0.25	1.4	120	0.23	1.4	-	-	-	-	-	50	0.20	1.1	-	-	-	
	T8315	0.8	145	0.25	1.4	85	0.23	1.4	-	-	-	435	0.30	1.4	35	0.20	1.1	-	-	-
	T8330	0.8	140	0.25	1.4	80	0.23	1.4	-	-	-	420	0.30	1.4	35	0.20	1.1	-	-	-
	T8430	0.8	155	0.25	1.4	85	0.23	1.4	-	-	-	435	0.30	1.4	30	0.20	1.1	-	-	-
	T9325	0.8	190	0.25	1.4	110	0.23	1.4	-	-	-	-	-	-	40	0.20	1.1	-	-	-

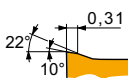

NMR geometry with positive design for medium to rough machining, and continuous cuts.

VNMG 160404E-NMR	T7325	0.4	125	0.20	1.2	95	0.18	1.2	-	-	-	-	-	40	0.18	1.0	-	-	-
	T7335	0.4	120	0.20	1.2	90	0.18	1.2	-	-	-	-	-	35	0.18	1.0	-	-	-
	T9325	0.4	155	0.20	1.2	90	0.18	1.2	-	-	-	-	-	30	0.18	1.0	-	-	-
VNMG 160408E-NMR	T7325	0.8	130	0.30	1.4	100	0.27	1.4	-	-	-	-	-	40	0.24	1.1	-	-	-
	T7335	0.8	125	0.30	1.4	95	0.27	1.4	-	-	-	-	-	40	0.24	1.1	-	-	-
	T8430	0.8	125	0.30	1.4	65	0.27	1.4	-	-	-	-	-	25	0.24	1.1	-	-	-
	T9315	0.8	170	0.30	1.4	-	-	-	-	-	-	-	-	-	-	-	-	-	-
	T9325	0.8	150	0.30	1.4	90	0.27	1.4	-	-	-	-	-	30	0.24	1.1	-	-	-
VNMG 160412E-NMR	T7325	1.2	140	0.30	1.4	105	0.27	1.4	-	-	-	-	-	45	0.24	1.1	-	-	-
	T8330	1.2	120	0.30	1.4	70	0.27	1.4	-	-	-	-	-	30	0.24	1.1	-	-	-
	T8430	1.2	130	0.30	1.4	70	0.27	1.4	-	-	-	-	-	25	0.24	1.1	-	-	-
	T9325	1.2	160	0.30	1.4	95	0.27	1.4	-	-	-	-	-	35	0.24	1.1	-	-	-



Suitability and starting values for cutting speed (vc), feed (f) and depth of cut (ap). Refer to our Machining Calculator app for further calculations.

Product	RE  (mm)	P			M			K			N			S			H		
		vc [m/min]	f [mm/rev]	ap [mm]	vc [m/min]	f [mm/rev]	ap [mm]	vc [m/min]	f [mm/rev]	ap [mm]	vc [m/min]	f [mm/rev]	ap [mm]	vc [m/min]	f [mm/rev]	ap [mm]	vc [m/min]	f [mm/rev]	ap [mm]

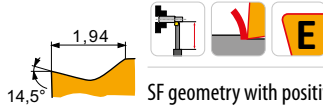

SF geometry with positive design for fine-finish machining and for machining thin walls, with continuous cuts.

VNMG 160404E-SF	T6310	0.4	█	135	0.12	1.2	█	95	0.11	1.2	█	105	0.12	1.2	█	405	0.14	1.2	█	40	0.11	1.0	█	25	0.15	1.0
	T7325	0.4	█	140	0.17	1.2	█	105	0.15	1.2	█	–	–	–	█	–	–	–	█	45	0.15	1.0	█	–	–	–
	T8315	0.4	█	140	0.12	1.2	█	80	0.11	1.2	█	130	0.12	1.2	█	420	0.14	1.2	█	35	0.11	1.0	█	25	0.15	1.0
	T8330	0.4	█	135	0.12	1.2	█	80	0.11	1.2	█	125	0.12	1.2	█	405	0.14	1.2	█	30	0.11	1.0	█	25	0.15	1.0
	T8430	0.4	█	165	0.12	1.2	█	90	0.11	1.2	█	135	0.12	1.2	█	450	0.14	1.2	█	35	0.11	1.0	█	25	0.15	1.0
	T9315	0.4	█	225	0.12	1.2	█	–	–	–	█	210	0.12	1.2	█	–	–	–	█	–	–	–	█	45	0.15	1.0
VNMG 160408E-SF	T6310	0.8	█	140	0.17	1.4	█	100	0.15	1.4	█	110	0.17	1.4	█	420	0.20	1.4	█	40	0.14	1.1	█	25	0.15	1.0
	T8315	0.8	█	150	0.17	1.4	█	90	0.15	1.4	█	140	0.17	1.4	█	450	0.20	1.4	█	35	0.14	1.1	█	30	0.15	1.0
	T8330	0.8	█	145	0.17	1.4	█	85	0.15	1.4	█	135	0.17	1.4	█	435	0.20	1.4	█	35	0.14	1.1	█	25	0.15	1.0
	T8430	0.8	█	165	0.17	1.4	█	90	0.15	1.4	█	135	0.17	1.4	█	450	0.20	1.4	█	35	0.14	1.1	█	25	0.15	1.0
	T9315	0.8	█	230	0.17	1.4	█	–	–	–	█	215	0.17	1.4	█	–	–	–	█	–	–	–	█	45	0.15	1.0
	T9325	0.8	█	205	0.17	1.4	█	120	0.15	1.4	█	190	0.17	1.4	█	–	–	–	█	45	0.15	1.1	█	–	–	–
VNMG 160412E-SF	T6310	1.2	█	145	0.20	1.4	█	100	0.18	1.4	█	115	0.20	1.4	█	435	0.24	1.4	█	40	0.16	1.1	█	25	0.15	1.0
	T7325	1.2	█	165	0.20	1.4	█	125	0.18	1.4	█	–	–	–	█	–	–	–	█	50	0.16	1.1	█	–	–	–



SM geometry with positive design for medium machining, and continuous to interrupted cuts.

VNMG 160404E-SM	T6310	0.4	█	120	0.18	1.2	█	85	0.16	1.2	█	95	0.18	1.2	█	360	0.22	1.2	█	35	0.16	1.0	█	20	0.15	1.0
	T7325	0.4	█	135	0.18	1.2	█	105	0.16	1.2	█	–	–	–	█	–	–	–	█	40	0.16	1.0	█	–	–	–
	T7335	0.4	█	135	0.18	1.2	█	105	0.16	1.2	█	–	–	–	█	–	–	–	█	40	0.16	1.0	█	–	–	–
	T8330	0.4	█	120	0.18	1.2	█	70	0.16	1.2	█	110	0.18	1.2	█	360	0.22	1.2	█	30	0.16	1.0	█	20	0.15	1.0
	T8430	0.4	█	135	0.18	1.2	█	75	0.16	1.2	█	110	0.18	1.2	█	375	0.22	1.2	█	25	0.16	1.0	█	20	0.15	1.0
	T9315	0.4	█	190	0.18	1.2	█	–	–	–	█	180	0.18	1.2	█	–	–	–	█	–	–	–	█	35	0.15	1.0
VNMG 160408E-SM	T6310	0.8	█	125	0.25	1.4	█	90	0.23	1.4	█	100	0.25	1.4	█	375	0.30	1.4	█	35	0.20	1.1	█	25	0.15	1.0
	T7325	0.8	█	145	0.25	1.4	█	110	0.23	1.4	█	–	–	–	█	–	–	–	█	45	0.20	1.1	█	–	–	–
	T8330	0.8	█	125	0.25	1.4	█	75	0.23	1.4	█	115	0.25	1.4	█	375	0.30	1.4	█	30	0.20	1.1	█	25	0.15	1.0
	T8430	0.8	█	140	0.25	1.4	█	75	0.23	1.4	█	115	0.25	1.4	█	390	0.30	1.4	█	30	0.20	1.1	█	20	0.15	1.0
	T9315	0.8	█	195	0.25	1.4	█	–	–	–	█	185	0.25	1.4	█	–	–	–	█	–	–	–	█	35	0.15	1.0
	T9325	0.8	█	170	0.25	1.4	█	100	0.23	1.4	█	160	0.25	1.4	█	–	–	–	█	35	0.20	1.1	█	–	–	–
VNMG 160412E-SM	T6310	1.2	█	125	0.30	1.4	█	90	0.27	1.4	█	100	0.30	1.4	█	375	0.36	1.4	█	35	0.24	1.1	█	25	0.15	1.0



VNGA CER

	IC	D1	L	S
	[mm]	[mm]	[mm]	[mm]
1604	9.525	3.81	16.60	4.76

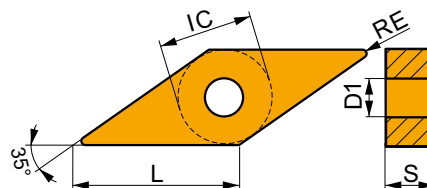

Suitability and starting values for cutting speed (vc), feed (f) and depth of cut (ap). Refer to our Machining Calculator app for further calculations.

Product	RE	P			M			K			N			S			H		
		vc	f	ap	vc	f	ap	vc	f	ap	vc	f	ap	vc	f	ap	vc	f	ap
	[mm]	[m/min]	[mm/rev]	[mm]	[m/min]	[mm/rev]	[mm]	[m/min]	[mm/rev]	[mm]	[m/min]	[mm/rev]	[mm]	[m/min]	[mm/rev]	[mm]	[m/min]	[mm/rev]	[mm]

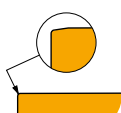

For machining with high speeds and continuous cuts.

VNGA 160404 T01020	TC100	0.4	–	–	–	–	–	–	–	–	–	–	–	–	–	–	–	–	–	–
VNGA 160408 T01020	TC100	0.8	–	–	–	–	–	–	–	–	–	–	–	–	–	–	–	–	–	–

VNGA CBN

	IC	D1	L	S
	[mm]	[mm]	[mm]	[mm]
1604	9.525	3.81	16.00	4.76

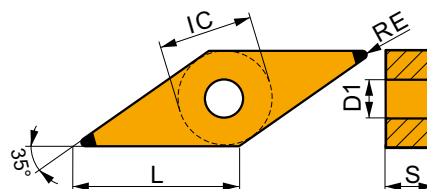

Suitability and starting values for cutting speed (vc), feed (f) and depth of cut (ap). Refer to our Machining Calculator app for further calculations.

Product	RE	P			M			K			N			S			H		
		vc	f	ap	vc	f	ap	vc	f	ap	vc	f	ap	vc	f	ap	vc	f	ap
	[mm]	[m/min]	[mm/rev]	[mm]	[m/min]	[mm/rev]	[mm]	[m/min]	[mm/rev]	[mm]	[m/min]	[mm/rev]	[mm]	[m/min]	[mm/rev]	[mm]	[m/min]	[mm/rev]	[mm]

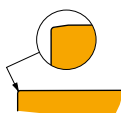

For finish machining and continuous cuts.

VNGA 160404S01020B	TB310	0.4	–	–	–	–	–	–	–	–	–	–	–	–	–	–	–	–	–	–
VNGA 160408S01020B	TB310	0.8	–	–	–	–	–	–	–	–	–	–	–	–	–	–	–	–	–	–



DVJN(RL) EXT



External Double Clamp Holder with 93° Cutting Angle for VN.. Insert

External Right/Left hand double clamp tool holder with 93° cutting angle. Suited for longitudinal turning with shoulder, copy and taper turning and chamfering with negative VN.. 16 size inserts. Available in 20x20 up to 32x32 mm shank. Body treated for longer tool life.

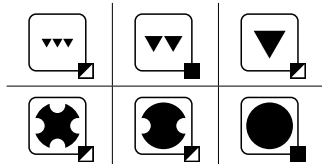
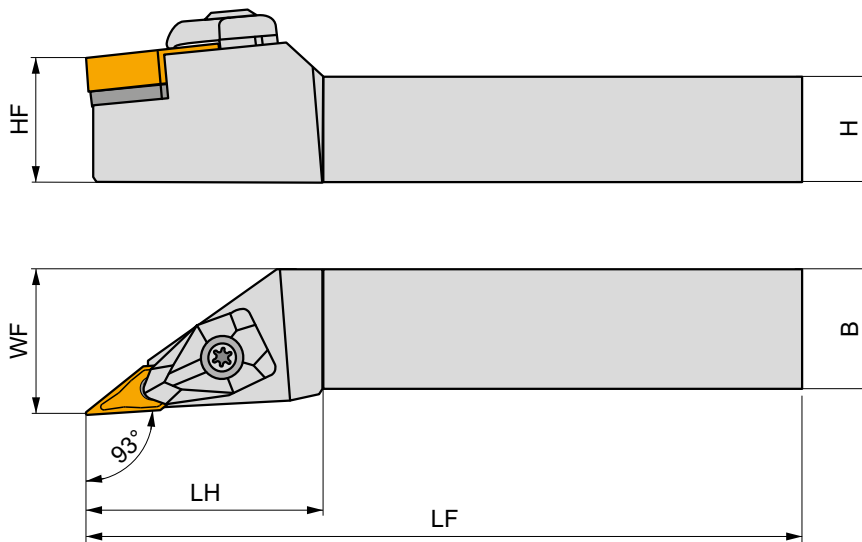
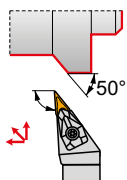

Product	H	B	HF	WF	LF	LH	LAMS	GAMO	kg			
	[mm]	[mm]	[mm]	[mm]	[mm]	[mm]	[°]	[°]				
R	DVJNR 2020 K 16	20	20	20	25	125	46.4	-13	-4	0.43	G1048	DV16
	DVJNR 2525 M 16	25	25	25	32	150	46.4	-13	-4	0.75	G1048	DV16
	DVJNR 3225 P 16	32	25	32	32	170	46.4	-13	-4	1.05	G1048	DV16
L	DVJNL 2020 K 16	20	20	20	25	125	46.4	-13	-4	0.43	G1048	DV16
	DVJNL 2525 M 16	25	25	25	32	150	46.4	-13	-4	0.75	G1048	DV16
	DVJNL 3225 P 16	32	25	32	32	170	46.4	-13	-4	1.06	G1048	DV16



G1048



VN.. 1604..



DV16



DCS 16V



3.0



DVS 269-01



US 2009-T15P



FLAGT15P/3,5



DVPN(RL) EXT

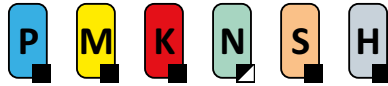

External Double Clamp Holder with 117.5° Cutting Angle for VN.. Insert

External Right/Left hand double clamp tool holder with 117.5° Cutting Angle. Suited for longitudinal and face turning with shoulder, copy and taper turning and chamfering with negative VN.. 16 size inserts. Available in 25x25 and 32x25 mm shank. Body treated for longer tool life.

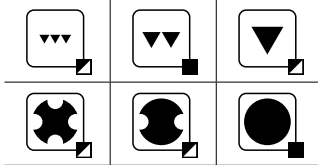
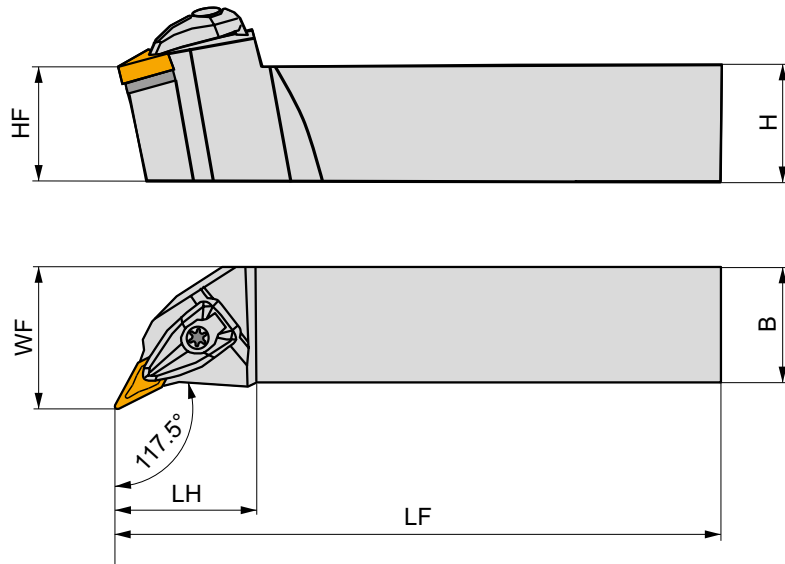
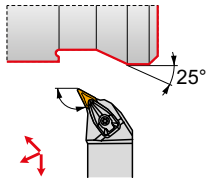

Product		H	B	HF	WF	LF	LH	LAMS	GAMO	kg		
		[mm]	[mm]	[mm]	[mm]	[mm]	[mm]	[°]	[°]			
R	DVPNR 2525 M 16	25	25	25	32	150	39.2	-13	-4	0.75	GI048	DV16
	DVPNR 3225 P 16	32	25	32	32	170	39.2	-13	-4	1.06	GI048	DV16
L	DVPNL 2525 M 16	25	25	25	32	150	39.2	-13	-4	0.74	GI048	DV16
	DVPNL 3225 P 16	32	25	32	32	170	39.2	-13	-4	1.06	GI048	DV16



GI048



VN.. 1604..



DV16



DCS 16V



3.0



DVS 269-01



US 2009-T15P



FLAG T15P/3,5



MVJN(RL) EXT



PRAMET

M



External Multi-Clamp Holder with 93° Cutting Angle for VN.. Insert

External Right/Left hand multi-clamp turning holder with 93° cutting angle. Suited for longitudinal turning with shoulder, copy turning up to 50°, taper and chamfer turning with negative VN.. 16 insert. Available with shank size 20x20 up to 32x25 mm. Body treated for longer tool life.

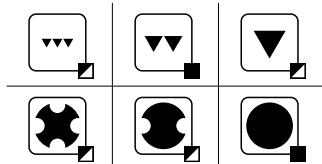
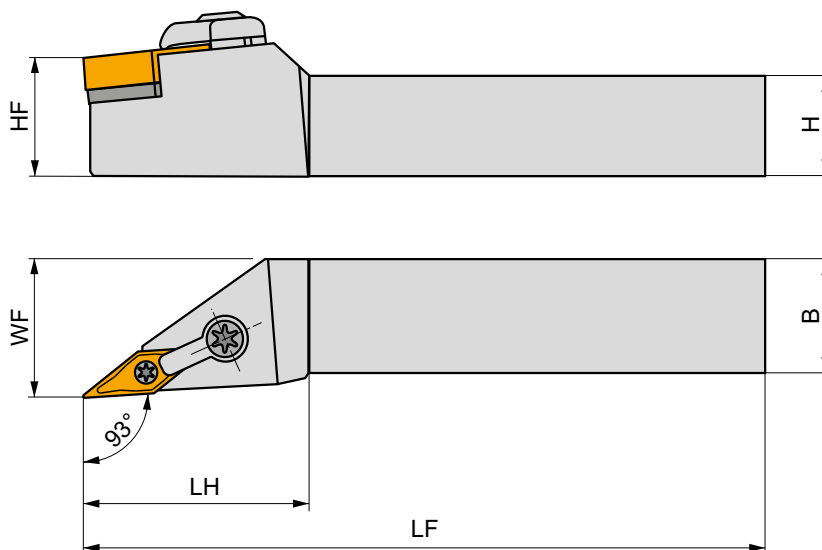
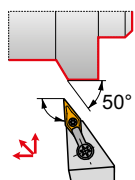

Product	H	B	HF	WF	LF	LH	LAMS	GAMO	kg		
	[mm]	[mm]	[mm]	[mm]	[mm]	[mm]	[°]	[°]			
R MVJNR 2020 K 16-A	20	20	20	25	125	41	-4.5	-13.5	0.40	G1048	MV2
	25	25	25	32	150	41	-4.5	-13.5	0.70	G1048	MV2
	32	25	32	32	170	41	-4.5	-13.5	0.98	G1048	MV2
L MVJNL 2020 K 16-A	20	20	20	25	125	41	-4.5	-13.5	0.40	G1048	MV2
	25	25	25	32	150	41	-4.5	-13.5	0.70	G1048	MV2
	32	25	32	32	170	41	-4.5	-13.5	0.96	G1048	MV2



G1048



VN.. 1604..



MV2



UPC22



MVN 160316



UP 0909-T09P



2.0



PS 6026-T09P



2.0



FLAG T09P



C.-DVJN(RL) EXT

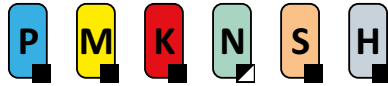

PRAMET

D



External PSC Quick Change Tool, Double Clamp, 93° Cutting Angle, VN.. Insert

External Right/Left hand double clamp tool, through coolant, with 93° cutting angle for longitudinal turning with shoulder, copy and taper turning and chamfering with negative VN.. 16 size inserts. Available with PSC (Polygon Shank Coupling) C4 up to C6 shank. Body treated for longer tool life.

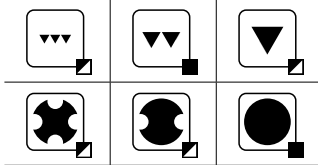
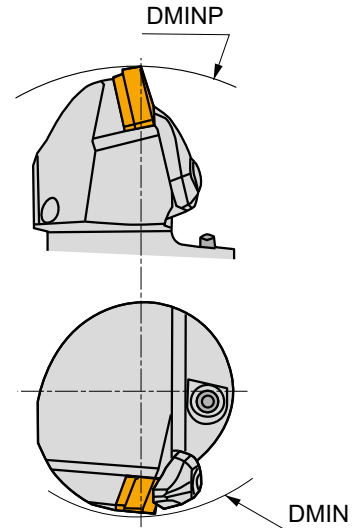
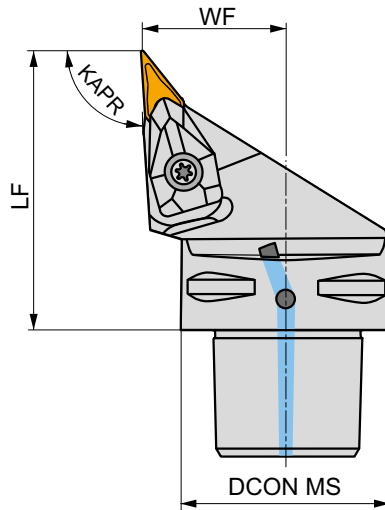
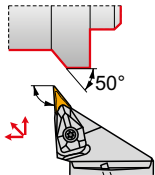

Product	DCON MS	DMIN	DMINP	WF	LF	KAPR	LAMS	GAMO					
	[mm]	[mm]	[mm]	[mm]	[mm]	[°]	[°]	[°]					
R	C4-DVJNR-27062-16	40	60	152	27	62	93	-13	-4	✓	0.45	GI048	C-DV16-1
	C5-DVJNR-35065-16	50	65	170	35	65	93	-13	-4	✓	0.47	GI048	C-DV16-2
	C6-DVJNR-45065-16	63	81	190	45	65	93	-13	-4	✓	1.13	GI048	C-DV16-2
L	C4-DVJNL-27062-16	40	60	152	27	62	93	-13	-4	✓	0.45	GI048	C-DV16-1
	C5-DVJNL-35065-16	50	65	170	35	65	93	-13	-4	✓	0.72	GI048	C-DV16-2
	C6-DVJNL-45065-16	63	81	190	45	65	93	-13	-4	✓	1.13	GI048	C-DV16-2



GI048



VN.. 1604..



C-DV16-1



DCS 16V



Nm

3.0



DVS 269-01



US 2009-T15P



FLAGT15P/3,5



CN 034-01

C-DV16-2

DCS 16V

3.0

DVS 269-01

US 2009-T15P

FLAGT15P/3,5

CN 034-02



DVUN(RL) INT



Internal Double Clamp Boring Bar with 93° Cutting Angle for VN.. Insert

Internal Right/Left hand double clamp boring bar, through coolant, with 93° cutting angle for VN.. 16 inserts. Minimum internal turning diameter Ø50 mm. Suited for internal taper, longitudinal turning with shoulder, copying and chamfer turning. Available with shank size Ø40 mm only. Body treated for longer tool life.

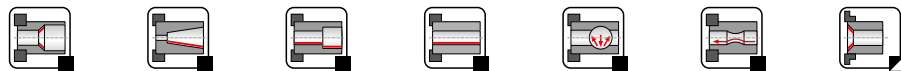
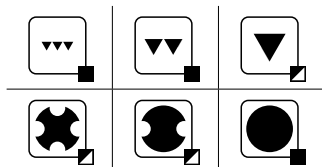
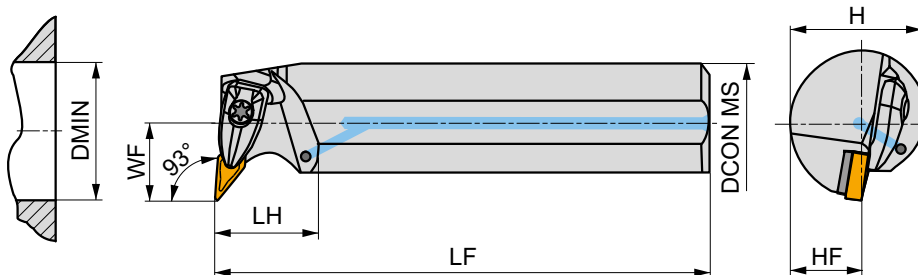
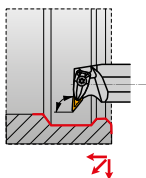

Product	DCON MS [mm]	DMIN [mm]	WF [mm]	H [mm]	HF [mm]	LF [mm]	LH [mm]	LAMS [°]	GAMO [°]		kg		
R A40T-DVUNR 16	40	50	27	37	18.5	300	36	-9	-6	✓	2.59	GI048	DV16
L A40T-DVUNL 16	40	50	27	37	18.5	300	36	-9	-6	✓	2.59	GI048	DV16



GI048



VN.. 1604..



DV16



DCS 16V



3.0



DVS 269-01



US 2009-T15P



FLAG T15P/3,5



WN

06/ 08/ 10/ 13

CARBIDE INSERTS

WNMA



366

WNMG



366

WNMM



375

CER AND CBN INSERTS

WNGA CBN



376

MATCH THE RIGHT SIZE (example)

Insert

WNMA 080408

Tool Holder

DWLNL 2020 K 08

ISO TURNING – EXTERNAL

DWLN(RL) EXT

95°

WN..

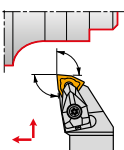
06
08
10
13
 $\frac{16 \times 16}{40 \times 40}$

377

366 – 376

MWLN(RL) EXT

95°

WN..

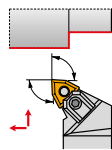

08

 $\frac{25 \times 25}{40 \times 40}$

379

366 – 376

PWLN(RL) EXT

95°

WN..

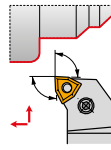
06
08
 $\frac{16 \times 16}{32 \times 25}$

380

366 – 376

C.-DWLN(RL) EXT

95°

WN..

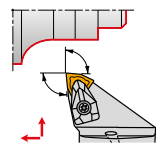
06
08
 $\frac{C4}{C6}$

381

366 – 376

ISO TURNING – INTERNAL

DWLN(RL) INT

95°

WN..

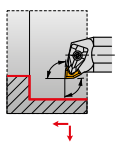
06
08
 $\frac{32}{63}$

382

366 – 376

PWLN(RL) INT

95°

WN..

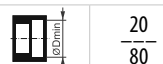
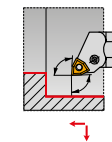
06
08
 $\frac{20}{80}$

383

366 – 376

C.-DWLN(RL) INT

95°

WN..

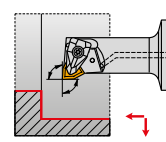
06
08
 $\frac{27}{33}$

385

366 – 376



WNMA



	IC	D1	L	S
	[mm]	[mm]	[mm]	[mm]
0804	12.700	5.16	8.70	4.76

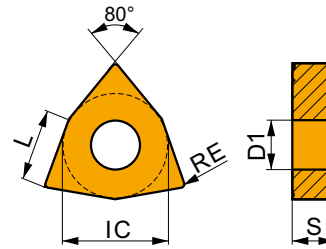

Suitability and starting values for cutting speed (vc), feed (f) and depth of cut (ap). Refer to our Machining Calculator app for further calculations.

Product	RE	P			M			K			N			S			H		
		vc	f	ap	vc	f	ap	vc	f	ap	vc	f	ap	vc	f	ap	vc	f	ap
	[mm]	[m/min]	[mm/rev]	[mm]	[m/min]	[mm/rev]	[mm]	[m/min]	[mm/rev]	[mm]	[m/min]	[mm/rev]	[mm]	[m/min]	[mm/rev]	[mm]	[m/min]	[mm/rev]	[mm]

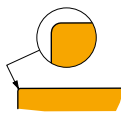

For fine-finish to semi-rough machining, and continuous to slightly interrupted cuts.

WNMA 080404	T5305	0.4	–	–	–	–	–	–	235	0.10	4.0	–	–	–	–	–	–	–	–	50	0.15	1.0
	T5315	0.4	–	–	–	–	–	–	200	0.10	4.0	–	–	–	–	–	–	–	–	40	0.15	1.0
WNMA 080408	T5305	0.8	–	–	–	–	–	–	220	0.20	4.0	–	–	–	–	–	–	–	–	45	0.15	1.0
	T5315	0.8	–	–	–	–	–	–	190	0.20	4.0	–	–	–	–	–	–	–	–	40	0.15	1.0
	T6310	0.8	–	–	–	–	–	–	100	0.20	4.0	–	–	–	–	–	–	–	–	25	0.15	1.0
WNMA 080412	T5305	1.2	–	–	–	–	–	–	195	0.30	4.0	–	–	–	–	–	–	–	–	40	0.15	1.0
	T5315	1.2	–	–	–	–	–	–	180	0.30	4.0	–	–	–	–	–	–	–	–	35	0.15	1.0
	T6310	1.2	–	–	–	–	–	–	95	0.30	4.0	–	–	–	–	–	–	–	–	20	0.15	1.0

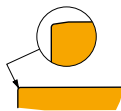

For fine-finish to semi-rough machining and continuous to slightly interrupted cuts.

WNMA 080408S	T5305	0.8	–	–	–	–	–	–	220	0.20	4.0	–	–	–	–	–	–	–	–	45	0.15	1.0
--------------	-------	-----	---	---	---	---	---	---	-----	------	-----	---	---	---	---	---	---	---	---	----	------	-----

WNMG



	IC	D1	L	S
	[mm]	[mm]	[mm]	[mm]
0604	9.525	3.81	6.50	4.76
06T3	9.525	3.81	6.50	3.97
0804	12.700	5.16	8.70	4.76

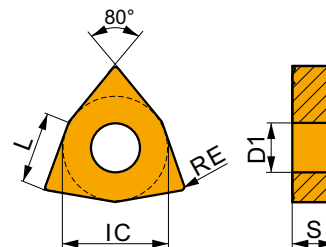

Suitability and starting values for cutting speed (vc), feed (f) and depth of cut (ap). Refer to our Machining Calculator app for further calculations.

Product	RE	P			M			K			N			S			H		
		vc	f	ap	vc	f	ap	vc	f	ap	vc	f	ap	vc	f	ap	vc	f	ap
	[mm]	[m/min]	[mm/rev]	[mm]	[m/min]	[mm/rev]	[mm]	[m/min]	[mm/rev]	[mm]	[m/min]	[mm/rev]	[mm]	[m/min]	[mm/rev]	[mm]	[m/min]	[mm/rev]	[mm]

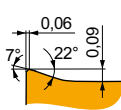

FF geometry with highly positive design for fine-finish machining, and continuous to slightly interrupted cuts.

WNMG 060402E-FF	T8315	0.2	215	0.10	1.0	125	0.09	1.0	200	0.10	1.0	–	–	–	–	–	–	–	–	–	–	–
WNMG 060404E-FF	T8315	0.4	220	0.12	1.0	130	0.11	1.0	205	0.12	1.0	–	–	–	–	–	–	–	–	–	–	–

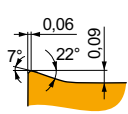
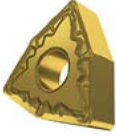
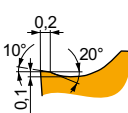

Suitability and starting values for cutting speed (vc), feed (f) and depth of cut (ap). Refer to our Machining Calculator app for further calculations.

Product	RE [mm]	P			M			K			N			S			H		
		vc	f	ap	vc	f	ap	vc	f	ap	vc	f	ap	vc	f	ap	vc	f	ap
		[m/min]	[mm/rev]	[mm]	[m/min]	[mm/rev]	[mm]	[m/min]	[mm/rev]	[mm]	[m/min]	[mm/rev]	[mm]	[m/min]	[mm/rev]	[mm]	[m/min]	[mm/rev]	[mm]
 																			
WNMG 080404E-FF	T7325	0.4	235	0.12	1.0	180	0.11	1.0	-	-	-	-	-	-	-	-	-	-	-
	T8315	0.4	220	0.12	1.0	130	0.11	1.0	205	0.12	1.0	-	-	-	-	-	-	-	-
WNMG 080408E-FF	T7325	0.8	265	0.15	1.0	205	0.14	1.0	-	-	-	-	-	-	-	-	-	-	-
	T8315	0.8	245	0.15	1.0	145	0.14	1.0	230	0.15	1.0	-	-	-	-	-	-	-	-
 																			
WNMG 060404E-FM	T7325	0.4	195	0.20	1.4	150	0.18	1.4	-	-	-	-	-	60	0.16	1.1	-	-	-
	T8315	0.4	180	0.20	1.4	105	0.18	1.4	170	0.20	1.4	-	-	45	0.14	1.1	-	-	-
WNMG 060408E-FM	T7325	0.8	235	0.20	1.4	180	0.18	1.4	-	-	-	-	-	75	0.16	1.1	-	-	-
	T8330	0.8	205	0.20	1.4	120	0.18	1.4	190	0.20	1.4	-	-	50	0.14	1.1	-	-	-
WNMG 060412E-FM	T7325	1.2	300	0.27	1.2	-	-	-	285	0.27	1.2	-	-	-	-	-	-	-	-
	T8315	1.2	195	0.20	1.4	150	0.18	1.4	-	-	-	-	-	60	0.16	1.1	-	-	-
WNMG 06T304E-FM	T7325	0.4	195	0.20	1.4	105	0.18	1.4	165	0.20	1.4	-	-	40	0.14	1.1	-	-	-
	T8330	0.4	175	0.20	1.4	105	0.18	1.4	160	0.20	1.4	-	-	40	0.14	1.1	-	-	-
WNMG 06T308E-FM	T7325	0.4	240	0.20	1.4	140	0.18	1.4	225	0.20	1.4	-	-	50	0.16	1.1	-	-	-
	T8330	0.8	205	0.20	1.4	120	0.18	1.4	190	0.20	1.4	-	-	50	0.14	1.1	-	-	-
WNMG 080404E-FM	T7325	0.4	190	0.20	1.9	145	0.18	1.9	-	-	-	-	-	60	0.16	1.5	-	-	-
	T7335	0.4	180	0.20	1.9	140	0.18	1.9	-	-	-	-	-	55	0.16	1.5	-	-	-
WNMG 080408E-FM	T7325	0.8	225	0.20	1.9	175	0.18	1.9	-	-	-	-	-	70	0.16	1.5	-	-	-
	T7335	0.8	215	0.20	1.9	165	0.18	1.9	-	-	-	-	-	65	0.16	1.5	-	-	-
WNMG 080412E-FM	T7325	1.2	220	0.27	1.9	170	0.24	1.9	-	-	-	-	-	70	0.19	1.5	-	-	-
	T7335	1.2	205	0.27	1.9	155	0.24	1.9	-	-	-	-	-	65	0.19	1.5	-	-	-



Suitability and starting values for cutting speed (vc), feed (f) and depth of cut (ap). Refer to our Machining Calculator app for further calculations.

Product	RE (mm)	P			M			K			N			S			H		
		vc [m/min]	f [mm/rev]	ap [mm]	vc [m/min]	f [mm/rev]	ap [mm]	vc [m/min]	f [mm/rev]	ap [mm]	vc [m/min]	f [mm/rev]	ap [mm]	vc [m/min]	f [mm/rev]	ap [mm]	vc [m/min]	f [mm/rev]	ap [mm]

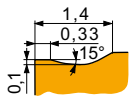

KR geometry for semi-rough to rough machining, and continuous to interrupted cuts.

WNMG 080408E-KR	T5305	0.8	255	0.35	3.5	-	-	-	240	0.35	3.5	-	-	-	-	-	50	0.15	1.0
	T5315	0.8	230	0.35	3.5	-	-	-	215	0.35	3.5	-	-	-	-	-	45	0.15	1.0
WNMG 080412E-KR	T5305	1.2	260	0.40	3.5	-	-	-	245	0.40	3.5	-	-	-	-	-	50	0.15	1.0
	T5315	1.2	235	0.40	3.5	-	-	-	220	0.40	3.5	-	-	-	-	-	45	0.15	1.0

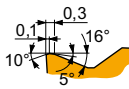

M geometry for finish to semi-rough machining, and continuous to interrupted cuts.

WNMG 060404E-M	T5315	0.4	250	0.20	1.8	-	-	-	235	0.20	1.8	-	-	-	-	-	50	0.15	1.0
	T9315	0.4	240	0.20	1.8	-	-	-	225	0.20	1.8	-	-	-	-	-	45	0.15	1.0
	T9325	0.4	215	0.20	1.8	-	-	-	200	0.20	1.8	-	-	-	-	-	-	-	-
	T9335	0.4	180	0.20	1.8	-	-	-	-	-	-	-	-	-	-	-	-	-	-
WNMG 060408E-M	T5315	0.8	255	0.32	1.8	-	-	-	240	0.32	1.8	-	-	-	-	-	50	0.15	1.0
	T9310	0.8	250	0.32	1.8	-	-	-	235	0.32	1.8	-	-	-	-	-	50	0.15	1.0
	T9315	0.8	230	0.32	1.8	-	-	-	215	0.32	1.8	-	-	-	-	-	45	0.15	1.0
	T9325	0.8	205	0.32	1.8	-	-	-	190	0.32	1.8	-	-	-	-	-	-	-	-
	T9335	0.8	180	0.32	1.8	-	-	-	-	-	-	-	-	-	-	-	-	-	-
WNMG 080404E-M	T5315	0.4	260	0.20	1.2	-	-	-	245	0.20	1.2	-	-	-	-	-	50	0.15	1.0
	T9315	0.4	235	0.20	2.1	-	-	-	220	0.20	2.1	-	-	-	-	-	45	0.15	1.0
	T9325	0.4	210	0.20	2.1	-	-	-	195	0.20	2.1	-	-	-	-	-	-	-	-
	T9335	0.4	180	0.20	2.1	-	-	-	-	-	-	-	-	-	-	-	-	-	-
WNMG 080408E-M	T5305	0.8	280	0.32	2.1	-	-	-	265	0.32	2.1	-	-	-	-	-	55	0.15	1.0
	T5315	0.8	250	0.32	2.1	-	-	-	235	0.32	2.1	-	-	-	-	-	50	0.15	1.0
	T8330	0.8	155	0.32	2.1	-	-	-	145	0.32	2.1	-	-	-	-	-	30	0.15	1.0
	T8430	0.8	170	0.32	2.1	-	-	-	135	0.32	2.1	-	-	-	-	-	25	0.15	1.0
	T9310	0.8	245	0.32	2.1	-	-	-	230	0.32	2.1	-	-	-	-	-	45	0.15	1.0
	T9315	0.8	225	0.32	2.1	-	-	-	210	0.32	2.1	-	-	-	-	-	45	0.15	1.0
	T9325	0.8	200	0.32	2.1	-	-	-	190	0.32	2.1	-	-	-	-	-	-	-	-
	T9335	0.8	180	0.32	2.1	-	-	-	-	-	-	-	-	-	-	-	-	-	-
	T9335	0.8	170	0.40	2.1	-	-	-	-	-	-	-	-	-	-	-	-	-	-
WNMG 080412E-M	T5305	1.2	275	0.40	2.1	-	-	-	260	0.40	2.1	-	-	-	-	-	55	0.15	1.0
	T5315	1.2	245	0.40	2.1	-	-	-	230	0.40	2.1	-	-	-	-	-	45	0.15	1.0
	T9310	1.2	235	0.40	2.1	-	-	-	220	0.40	2.1	-	-	-	-	-	45	0.15	1.0
	T9315	1.2	220	0.40	2.1	-	-	-	205	0.40	2.1	-	-	-	-	-	40	0.15	1.0
	T9325	1.2	195	0.40	2.1	-	-	-	185	0.40	2.1	-	-	-	-	-	-	-	-
T9335	1.2	170	0.40	2.1	-	-	-	-	-	-	-	-	-	-	-	-	-	-	

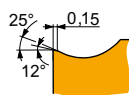

NF geometry with highly positive design for fine-finish to medium machining, and continuous cuts.

WNMG 060404E-NF	T6310	0.4	190	0.17	0.8	135	0.15	0.8	150	0.17	0.8	570	0.20	0.8	55	0.12	0.6	-	-	-
	T7325	0.4	215	0.18	0.8	165	0.16	0.8	-	-	-	-	-	-	65	0.16	0.6	-	-	-
	T7335	0.4	210	0.18	0.8	160	0.16	0.8	-	-	-	-	-	-	65	0.16	0.6	-	-	-
	T8315	0.4	200	0.17	0.8	120	0.15	0.8	190	0.17	0.8	600	0.20	0.8	50	0.12	0.6	-	-	-
	T8330	0.4	190	0.17	0.8	110	0.15	0.8	180	0.17	0.8	570	0.20	0.8	45	0.12	0.6	-	-	-
	T8430	0.4	225	0.17	0.8	120	0.15	0.8	185	0.17	0.8	615	0.20	0.8	45	0.12	0.6	-	-	-
	T9315	0.4	305	0.17	0.8	-	-	-	285	0.17	0.8	-	-	-	-	-	-	-	-	-
	T9325	0.4	265	0.18	0.8	155	0.16	0.8	250	0.18	0.8	-	-	-	55	0.16	0.6	-	-	-
	T9335	0.4	235	0.18	0.8	145	0.16	0.8	220	0.18	0.8	-	-	-	50	0.16	0.6	-	-	-
WNMG 060408E-NF	T6310	0.8	215	0.19	1.0	150	0.17	1.0	170	0.19	1.0	645	0.23	1.0	60	0.15	0.8	-	-	-
	T7325	0.8	245	0.19	1.0	190	0.17	1.0	-	-	-	-	-	75	0.15	0.8	-	-	-	
	T8330	0.8	215	0.19	1.0	125	0.17	1.0	200	0.19	1.0	645	0.23	1.0	50	0.15	0.8	-	-	-
	T8430	0.8	245	0.19	1.0	135	0.17	1.0	200	0.19	1.0	675	0.23	1.0	50	0.15	0.8	-	-	-
	T9315	0.8	335	0.19	1.0	-	-	-	315	0.19	1.0	-	-	-	-	-	-	-	-	-
	T9325	0.8	300	0.19	1.0	180	0.17	1.0	285	0.19	1.0	-	-	-	65	0.15	0.8	-	-	-



Suitability and starting values for cutting speed (vc), feed (f) and depth of cut (ap). Refer to our Machining Calculator app for further calculations.

Product	RE [mm]	P			M			K			N			S			H		
		vc	f	ap	vc	f	ap	vc	f	ap	vc	f	ap	vc	f	ap	vc	f	ap
		[m/min]	[mm/rev]	[mm]	[m/min]	[mm/rev]	[mm]	[m/min]	[mm/rev]	[mm]	[m/min]	[mm/rev]	[mm]	[m/min]	[mm/rev]	[mm]	[m/min]	[mm/rev]	[mm]

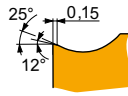

NF geometry with highly positive design for fine-finish to medium machining, and continuous cuts.

WNMG 080404E-NF	HF7	0.4	–	–	–	█	95	0.15	1.7	█	155	0.17	1.7	█	495	0.20	1.7	–	–	–	–	–	–		
	T6310	0.4	█	180	0.17	1.7	█	125	0.15	1.7	█	145	0.17	1.7	█	540	0.20	1.7	█	50	0.14	1.4	–	–	–
	T7325	0.4	█	200	0.18	1.7	█	155	0.16	1.7	–	–	–	–	–	–	–	–	█	65	0.16	1.4	–	–	–
	T7335	0.4	█	195	0.18	1.7	█	150	0.16	1.7	–	–	–	–	–	–	–	–	█	60	0.16	1.4	–	–	–
	T8315	0.4	█	185	0.17	1.7	█	110	0.15	1.7	█	175	0.17	1.7	█	555	0.20	1.7	█	45	0.14	1.4	–	–	–
	T8330	0.4	█	180	0.17	1.7	█	105	0.15	1.7	█	170	0.17	1.7	█	540	0.20	1.7	█	45	0.14	1.4	–	–	–
	T8430	0.4	█	200	0.17	1.7	█	110	0.15	1.7	█	165	0.17	1.7	█	555	0.20	1.7	█	40	0.14	1.4	–	–	–
	T9315	0.4	█	285	0.17	1.7	█	–	–	–	█	270	0.17	1.7	–	–	–	–	–	–	–	–	–	–	–
	T9325	0.4	█	250	0.18	1.7	█	150	0.16	1.7	█	235	0.18	1.7	–	–	–	–	–	█	55	0.16	1.4	–	–
WNMG 080408E-NF	HF7	0.8	–	–	–	█	110	0.17	1.7	█	180	0.19	1.7	█	570	0.23	1.7	–	–	–	–	–	–	–	
	T6310	0.8	█	200	0.19	1.7	█	140	0.17	1.7	█	160	0.19	1.7	█	600	0.23	1.7	█	60	0.15	1.4	–	–	–
	T7325	0.8	█	235	0.19	1.7	█	180	0.17	1.7	–	–	–	–	–	–	–	–	█	75	0.15	1.4	–	–	–
	T7335	0.8	█	225	0.19	1.7	█	175	0.17	1.7	–	–	–	–	–	–	–	–	█	70	0.15	1.4	–	–	–
	T8315	0.8	█	215	0.19	1.7	█	125	0.17	1.7	█	200	0.19	1.7	█	645	0.23	1.7	█	50	0.15	1.4	–	–	–
	T8330	0.8	█	200	0.19	1.7	█	120	0.17	1.7	█	190	0.19	1.7	█	600	0.23	1.7	█	50	0.15	1.4	–	–	–
	T8430	0.8	█	235	0.19	1.7	█	125	0.17	1.7	█	190	0.19	1.7	█	645	0.23	1.7	█	50	0.15	1.4	–	–	–
	T9315	0.8	█	320	0.19	1.7	█	–	–	–	█	300	0.19	1.7	–	–	–	–	–	–	–	–	–	–	–
	T9325	0.8	█	285	0.19	1.7	█	170	0.17	1.7	█	270	0.19	1.7	–	–	–	–	–	█	60	0.15	1.4	–	–
WNMG 080412E-NF	T6310	1.2	█	185	0.30	2.1	█	130	0.27	2.1	█	145	0.30	2.1	█	555	0.36	2.1	█	55	0.21	1.7	–	–	–
	T7325	1.2	█	205	0.30	2.1	█	155	0.27	2.1	–	–	–	–	–	–	–	–	█	65	0.21	1.7	–	–	–
	T8430	1.2	█	200	0.30	2.1	█	110	0.27	2.1	█	165	0.30	2.1	█	555	0.36	2.1	█	40	0.21	1.7	–	–	–
	T9315	1.2	█	275	0.30	2.1	█	–	–	–	█	260	0.30	2.1	–	–	–	–	–	–	–	–	–	–	–
	T9325	1.2	█	245	0.30	2.1	█	145	0.27	2.1	█	230	0.30	2.1	–	–	–	–	–	█	55	0.21	1.7	–	–

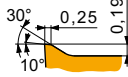

NM geometry with highly positive design for fine-finish, medium and rough machining, with continuous cuts.

WNMG 060404E-NM	T7325	0.4	█	200	0.20	1.8	█	155	0.18	1.8	–	–	–	–	–	–	–	–	█	65	0.16	1.4	–	–	–
	T7335	0.4	█	195	0.20	1.8	█	150	0.18	1.8	–	–	–	–	–	–	–	–	█	60	0.16	1.4	–	–	–
	T8315	0.4	█	185	0.20	1.8	█	110	0.18	1.8	–	–	–	█	555	0.24	1.8	█	45	0.16	1.4	–	–	–	
	T8330	0.4	█	175	0.20	1.8	█	105	0.18	1.8	–	–	–	█	525	0.24	1.8	█	40	0.16	1.4	–	–	–	
	T8430	0.4	█	185	0.25	1.8	█	100	0.23	1.8	–	–	–	█	510	0.30	1.8	█	40	0.20	1.4	–	–	–	
	T9325	0.4	█	245	0.20	1.8	█	145	0.18	1.8	–	–	–	–	–	–	–	–	█	55	0.16	1.4	–	–	–
WNMG 060408E-NM	T7325	0.8	█	220	0.25	1.8	█	170	0.23	1.8	–	–	–	–	–	–	–	–	█	70	0.20	1.4	–	–	–
	T7335	0.8	█	215	0.25	1.8	█	165	0.23	1.8	–	–	–	–	–	–	–	–	█	65	0.20	1.4	–	–	–
	T8315	0.8	█	205	0.25	1.8	█	120	0.23	1.8	–	–	–	█	615	0.30	1.8	█	50	0.20	1.4	–	–	–	
	T8330	0.8	█	195	0.25	1.8	█	115	0.23	1.8	–	–	–	█	585	0.30	1.8	█	45	0.20	1.4	–	–	–	
	T8430	0.8	█	220	0.25	1.8	█	120	0.23	1.8	–	–	–	█	600	0.30	1.8	█	45	0.20	1.4	–	–	–	
	T9315	0.8	█	290	0.25	1.8	█	–	–	–	–	–	–	–	–	–	–	–	–	–	–	–	–	–	–
WNMG 060412E-NM	T7325	1.2	█	220	0.30	1.8	█	170	0.27	1.8	–	–	–	–	–	–	–	–	█	70	0.24	1.4	–	–	–
	T7335	1.2	█	220	0.30	1.2	█	170	0.27	1.2	–	–	–	–	–	–	–	–	█	70	0.24	1.0	–	–	–
	T9315	1.2	█	285	0.30	1.8	█	–	–	–	–	–	–	–	–	–	–	–	–	–	–	–	–	–	
	T9325	1.2	█	255	0.30	1.8	█	150	0.27	1.8	–	–	–	–	–	–	–	–	█	55	0.24	1.4	–	–	–
WNMG 080404E-NM	T7325	0.4	█	195	0.20	2.1	█	150	0.18	2.1	–	–	–	–	–	–	–	–	█	60	0.16	1.7	–	–	–
	T7335	0.4	█	190	0.20	2.1	█	145	0.18	2.1	–	–	–	–	–	–	–	–	█	60	0.16	1.7	–	–	–
	T8315	0.4	█	180	0.20	2.1	█	105	0.18	2.1	–	–	–	█	540	0.24	2.1	█	45	0.16	1.7	–	–	–	
	T8330	0.4	█	170	0.20	2.1	█	100	0.18	2.1	–	–	–	█	510	0.24	2.1	█	40	0.16	1.7	–	–	–	
	T8430	0.4	█	180	0.25	2.1	█	95	0.23	2.1	–	–	–	█	495	0.30	2.1	█	35	0.20	1.7	–	–	–	
	T9315	0.4	█	270	0.20	2.1	█	–	–	–	–	–	–	–	–	–	–	–	–	–	–	–	–	–	–
	T9325	0.4	█	240	0.20	2.1	█	140	0.18	2.1	–	–	–	–	–	–	–	–	█	50	0.16	1.7	–	–	–



Suitability and starting values for cutting speed (vc), feed (f) and depth of cut (ap). Refer to our Machining Calculator app for further calculations.

Product	RE (mm)	P			M			K			N			S			H		
		vc [m/min]	f [mm/rev]	ap [mm]	vc [m/min]	f [mm/rev]	ap [mm]	vc [m/min]	f [mm/rev]	ap [mm]	vc [m/min]	f [mm/rev]	ap [mm]	vc [m/min]	f [mm/rev]	ap [mm]	vc [m/min]	f [mm/rev]	ap [mm]

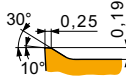

NM geometry with highly positive design for fine-finish, medium and rough machining, with continuous cuts.

WNMG 080408E-NM	T7325	0.8	215	0.25	2.1	165	0.23	2.1	-	-	-	-	-	-	65	0.20	1.7	-	-	-
	T7335	0.8	210	0.25	2.1	160	0.23	2.1	-	-	-	-	-	-	65	0.20	1.7	-	-	-
	T8315	0.8	205	0.25	2.1	120	0.23	2.1	-	-	-	615	0.30	2.1	50	0.20	1.7	-	-	-
	T8330	0.8	195	0.25	2.1	115	0.23	2.1	-	-	-	585	0.30	2.1	45	0.20	1.7	-	-	-
	T8430	0.8	210	0.25	2.1	115	0.23	2.1	-	-	-	585	0.30	2.1	45	0.20	1.7	-	-	-
	T9315	0.8	290	0.25	2.1	-	-	-	-	-	-	-	-	-	-	-	-	-	-	-
WNMG 080412E-NM	T9325	0.8	260	0.25	2.1	155	0.23	2.1	-	-	-	-	-	-	55	0.20	1.7	-	-	-
	T7325	1.2	215	0.30	2.1	165	0.27	2.1	-	-	-	-	-	-	65	0.24	1.7	-	-	-
	T7335	1.2	210	0.30	2.1	160	0.27	2.1	-	-	-	-	-	-	65	0.24	1.7	-	-	-
	T8315	1.2	205	0.30	2.1	120	0.27	2.1	-	-	-	615	0.36	2.1	50	0.24	1.7	-	-	-
T9325	1.2	255	0.30	2.1	150	0.27	2.1	-	-	-	-	-	-	55	0.24	1.7	-	-	-	

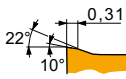

NMR geometry with positive design for medium to rough machining, and continuous cuts.

WNMG 060404E-NMR	T6310	0.4	145	0.25	1.6	100	0.23	1.6	-	-	-	-	-	-	40	0.20	1.3	-	-	-
	T7325	0.4	160	0.25	1.6	120	0.23	1.6	-	-	-	-	-	-	50	0.20	1.3	-	-	-
	T8430	0.4	145	0.31	1.6	80	0.28	1.6	-	-	-	-	-	-	30	0.25	1.3	-	-	-
	T9325	0.4	200	0.25	1.6	120	0.23	1.6	-	-	-	-	-	-	45	0.20	1.3	-	-	-
WNMG 060408E-NMR	T6310	0.8	155	0.35	1.6	110	0.32	1.6	-	-	-	-	-	-	45	0.25	1.3	-	-	-
	T7325	0.8	175	0.35	1.6	135	0.32	1.6	-	-	-	-	-	-	55	0.25	1.3	-	-	-
	T7335	0.8	170	0.35	1.6	130	0.32	1.6	-	-	-	-	-	-	55	0.25	1.3	-	-	-
	T9315	0.8	225	0.35	1.6	-	-	-	-	-	-	-	-	-	-	-	-	-	-	-
WNMG 080404E-NMR	T9325	0.8	200	0.35	1.6	120	0.32	1.6	-	-	-	-	-	-	45	0.25	1.3	-	-	-
	T6310	0.4	140	0.25	2.7	100	0.23	2.7	-	-	-	-	-	-	40	0.20	2.2	-	-	-
	T7325	0.4	155	0.25	2.7	120	0.23	2.7	-	-	-	-	-	-	50	0.20	2.2	-	-	-
	T7335	0.4	150	0.25	2.7	115	0.23	2.7	-	-	-	-	-	-	45	0.20	2.2	-	-	-
	T8330	0.4	140	0.25	2.7	80	0.23	2.7	-	-	-	-	-	-	35	0.20	2.2	-	-	-
	T8430	0.4	140	0.31	2.7	75	0.28	2.7	-	-	-	-	-	-	30	0.25	2.2	-	-	-
	T9315	0.4	205	0.25	2.7	-	-	-	-	-	-	-	-	-	-	-	-	-	-	-
	T9325	0.4	185	0.25	2.7	110	0.23	2.7	-	-	-	-	-	-	40	0.20	2.2	-	-	-
WNMG 080408E-NMR	T6310	0.8	150	0.35	2.7	105	0.32	2.7	-	-	-	-	-	-	45	0.25	2.2	-	-	-
	T7325	0.8	170	0.35	2.7	130	0.32	2.7	-	-	-	-	-	-	55	0.25	2.2	-	-	-
	T7335	0.8	160	0.35	2.7	120	0.32	2.7	-	-	-	-	-	-	50	0.25	2.2	-	-	-
	T8330	0.8	150	0.35	2.7	90	0.32	2.7	-	-	-	-	-	-	35	0.25	2.2	-	-	-
	T8430	0.8	155	0.35	2.7	85	0.32	2.7	-	-	-	-	-	-	30	0.25	2.2	-	-	-
	T9315	0.8	210	0.35	2.7	-	-	-	-	-	-	-	-	-	-	-	-	-	-	-
	T9325	0.8	190	0.35	2.7	110	0.32	2.7	-	-	-	-	-	-	40	0.25	2.2	-	-	-
	T6310	1.2	150	0.40	2.7	105	0.36	2.7	-	-	-	-	-	-	45	0.28	2.2	-	-	-
WNMG 080412E-NMR	T7325	1.2	170	0.40	2.7	130	0.36	2.7	-	-	-	-	-	-	55	0.28	2.2	-	-	-
	T7335	1.2	160	0.40	2.7	120	0.36	2.7	-	-	-	-	-	-	50	0.28	2.2	-	-	-
	T8330	1.2	150	0.40	2.7	90	0.36	2.7	-	-	-	-	-	-	35	0.28	2.2	-	-	-
	T8430	1.2	155	0.40	2.7	85	0.36	2.7	-	-	-	-	-	-	30	0.28	2.2	-	-	-
	T9315	1.2	215	0.40	2.7	-	-	-	-	-	-	-	-	-	-	-	-	-	-	-
	T9325	1.2	190	0.40	2.7	110	0.36	2.7	-	-	-	-	-	-	40	0.28	2.2	-	-	-

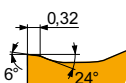
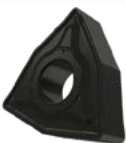

NRM geometry with positive design for semi-rough to rough machining, and continuous to moderate interrupted cuts.

WNMG 080404-NRM	T7325	0.4	155	0.25	2.7	120	0.23	2.7	-	-	-	-	-	-	50	0.18	2.2	-	-	-
	T7335	0.4	150	0.25	2.7	115	0.23	2.7	-	-	-	-	-	-	45	0.18	2.2	-	-	-
	T9315	0.4	205	0.25	2.7	-	-	-	-	-	-	-	-	-	-	-	-	-	-	-
WNMG 080408-NRM	T7325	0.8	170	0.35	2.7	130	0.32	2.7	-	-	-	-	-	-	55	0.28	2.2	-	-	-
	T7335	0.8	160	0.35	2.7	120	0.32	2.7	-	-	-	-	-	-	50	0.28	2.2	-	-	-
	T9315	0.8	210	0.35	2.7	-	-	-	-	-	-	-	-	-	-	-	-	-	-	-



Suitability and starting values for cutting speed (vc), feed (f) and depth of cut (ap). Refer to our Machining Calculator app for further calculations.

Product	RE [mm]	P			M			K			N			S			H							
		vc	f	ap	vc	f	ap	vc	f	ap	vc	f	ap	vc	f	ap	vc	f	ap					
		[m/min]	[mm/rev]	[mm]	[m/min]	[mm/rev]	[mm]	[m/min]	[mm/rev]	[mm]	[m/min]	[mm/rev]	[mm]	[m/min]	[mm/rev]	[mm]	[m/min]	[mm/rev]	[mm]					
 NRM geometry with positive design for semi-rough to rough machining, and continuous to moderate interrupted cuts.		WNMG 080412-NRM	T7325	1.2	170	0.40	2.7	130	0.36	2.7	-	-	-	-	-	-	55	0.28	2.2	-	-	-		
		T7335	1.2	160	0.40	2.7	120	0.36	2.7	-	-	-	-	-	-	-	-	50	0.28	2.2	-	-	-	
		T9315	1.2	215	0.40	2.7	-	-	-	-	-	-	-	-	-	-	-	-	-	-	-	-	-	-
 R geometry for semi-rough to rough machining, and continuous to interrupted cuts.		WNMG 080408E-R	T5305	0.8	245	0.40	3.5	-	-	-	230	0.40	3.5	-	-	-	-	-	-	45	0.15	1.0		
		T5315	0.8	220	0.40	3.5	-	-	-	205	0.40	3.5	-	-	-	-	-	-	-	-	40	0.15	1.0	
		T9310	0.8	210	0.40	3.5	-	-	-	195	0.40	3.5	-	-	-	-	-	-	-	-	40	0.15	1.0	
		T9315	0.8	195	0.40	3.5	-	-	-	185	0.40	3.5	-	-	-	-	-	-	-	-	35	0.15	1.0	
		T9325	0.8	175	0.40	3.5	-	-	-	165	0.40	3.5	-	-	-	-	-	-	-	-	-	-	-	
		T9335	0.8	155	0.40	3.5	-	-	-	-	-	-	-	-	-	-	-	-	-	-	-	-	-	-
		WNMG 080412E-R	T5305	1.2	250	0.45	3.5	-	-	-	235	0.45	3.5	-	-	-	-	-	-	-	-	50	0.15	1.0
T5315	1.2	225	0.45	3.5	-	-	-	210	0.45	3.5	-	-	-	-	-	-	-	-	45	0.15	1.0			
T9310	1.2	215	0.45	3.5	-	-	-	200	0.45	3.5	-	-	-	-	-	-	-	-	40	0.15	1.0			
T9315	1.2	200	0.45	3.5	-	-	-	190	0.45	3.5	-	-	-	-	-	-	-	-	40	0.15	1.0			
T9325	1.2	180	0.45	3.5	-	-	-	170	0.45	3.5	-	-	-	-	-	-	-	-	-	-	-			
T9335	1.2	155	0.45	3.5	-	-	-	-	-	-	-	-	-	-	-	-	-	-	-	-	-			
 RM geometry for semi-rough to rough machining, and continuous to interrupted cuts.		WNMG 060412E-RM	T9310	1.2	245	0.45	3.0	-	-	-	230	0.45	3.0	-	-	-	-	-	-	-	-	-		
		T9315	1.2	230	0.45	3.0	-	-	-	215	0.45	3.0	-	-	-	-	-	-	-	-	-	-	-	
		T9325	1.2	230	0.45	1.2	135	0.41	1.2	215	0.45	1.2	-	-	-	-	-	-	-	-	-	-	-	
WNMG 080408E-RM	T5305	0.8	275	0.40	4.0	-	-	-	260	0.40	4.0	-	-	-	-	-	-	-	-	-	-	-		
	T5315	0.8	250	0.40	4.0	-	-	-	235	0.40	4.0	-	-	-	-	-	-	-	-	-	-	-		
	T7325	0.8	180	0.40	4.0	140	0.36	4.0	-	-	-	-	-	-	-	-	-	-	-	-	-	-		
	T7335	0.8	165	0.40	4.0	125	0.36	4.0	-	-	-	-	-	-	-	-	-	-	-	-	-	-		
	T8315	0.8	165	0.40	4.0	95	0.36	4.0	155	0.40	4.0	-	-	-	-	-	-	-	-	-	-	-		
	T8330	0.8	155	0.40	4.0	90	0.36	4.0	145	0.40	4.0	-	-	-	-	-	-	-	-	-	-	-		
	T8430	0.8	165	0.40	4.0	90	0.36	4.0	135	0.40	4.0	-	-	-	-	-	-	-	-	-	-	-		
	T9310	0.8	240	0.40	4.0	-	-	-	225	0.40	4.0	-	-	-	-	-	-	-	-	-	-	-		
	T9315	0.8	220	0.40	4.0	-	-	-	205	0.40	4.0	-	-	-	-	-	-	-	-	-	-	-		
	T9325	0.8	200	0.40	4.0	120	0.36	4.0	190	0.40	4.0	-	-	-	-	-	-	-	-	-	-	-		
	T9335	0.8	170	0.40	4.0	100	0.36	4.0	-	-	-	-	-	-	-	-	-	-	-	-	-	-		
WNMG 080412E-RM	T5305	1.2	280	0.45	4.0	-	-	-	265	0.45	4.0	-	-	-	-	-	-	-	-	-	-	-		
	T5315	1.2	250	0.45	4.0	-	-	-	235	0.45	4.0	-	-	-	-	-	-	-	-	-	-	-		
	T7325	1.2	180	0.45	4.0	140	0.41	4.0	-	-	-	-	-	-	-	-	-	-	-	-	-	-		
	T7335	1.2	170	0.45	4.0	130	0.41	4.0	-	-	-	-	-	-	-	-	-	-	-	-	-	-		
	T8315	1.2	170	0.45	4.0	100	0.41	4.0	160	0.45	4.0	-	-	-	-	-	-	-	-	-	-	-		
	T9310	1.2	240	0.45	4.0	-	-	-	225	0.45	4.0	-	-	-	-	-	-	-	-	-	-	-		
	T9315	1.2	220	0.45	4.0	-	-	-	205	0.45	4.0	-	-	-	-	-	-	-	-	-	-	-		
	T9325	1.2	200	0.45	4.0	120	0.41	4.0	190	0.45	4.0	-	-	-	-	-	-	-	-	-	-	-		
	T9335	1.2	175	0.45	4.0	105	0.41	4.0	-	-	-	-	-	-	-	-	-	-	-	-	-	-		
WNMG 080416E-RM	T5305	1.6	280	0.50	4.0	-	-	-	265	0.50	4.0	-	-	-	-	-	-	-	-	-	-	-		
	T5315	1.6	255	0.50	4.0	-	-	-	240	0.50	4.0	-	-	-	-	-	-	-	-	-	-	-		
	T7335	1.6	175	0.50	4.0	135	0.45	4.0	-	-	-	-	-	-	-	-	-	-	-	-	-	-		
	T8430	1.6	170	0.50	4.0	90	0.45	4.0	135	0.50	4.0	-	-	-	-	-	-	-	-	-	-	-		
	T9310	1.6	240	0.50	4.0	-	-	-	225	0.50	4.0	-	-	-	-	-	-	-	-	-	-	-		
	T9315	1.6	220	0.50	4.0	-	-	-	205	0.50	4.0	-	-	-	-	-	-	-	-	-	-	-		
	T9325	1.6	205	0.50	4.0	120	0.45	4.0	190	0.50	4.0	-	-	-	-	-	-	-	-	-	-	-		
T9335	1.6	175	0.50	4.0	105	0.45	4.0	-	-	-	-	-	-	-	-	-	-	-	-	-	-			



Suitability and starting values for cutting speed (vc), feed (f) and depth of cut (ap). Refer to our Machining Calculator app for further calculations.

Product	RE  [mm]	P			M			K			N			S			H		
		vc [m/min]	f [mm/rev]	ap [mm]	vc [m/min]	f [mm/rev]	ap [mm]	vc [m/min]	f [mm/rev]	ap [mm]	vc [m/min]	f [mm/rev]	ap [mm]	vc [m/min]	f [mm/rev]	ap [mm]	vc [m/min]	f [mm/rev]	ap [mm]

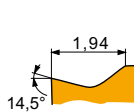

SF geometry with positive design for fine-finish machining and for machining thin walls, with continuous cuts.

WNMG 060404E-SF	H07	0.4	–	–	–	90	0.14	1.0	145	0.15	1.0	470	0.18	1.0	45	0.12	0.8	–	–	–
	T6310	0.4	180	0.15	1.0	125	0.14	1.0	145	0.15	1.0	540	0.18	1.0	50	0.12	0.8	35	0.15	1.0
	T7325	0.4	205	0.17	1.0	155	0.15	1.0	–	–	–	–	–	–	65	0.15	0.8	–	–	–
	T7335	0.4	200	0.17	1.0	155	0.15	1.0	–	–	–	–	–	–	65	0.15	0.8	–	–	–
	T8315	0.4	195	0.15	1.0	115	0.14	1.0	185	0.15	1.0	585	0.18	1.0	45	0.12	0.8	35	0.15	1.0
	T8330	0.4	180	0.15	1.0	105	0.14	1.0	170	0.15	1.0	540	0.18	1.0	45	0.12	0.8	35	0.15	1.0
	T8430	0.4	220	0.15	1.0	120	0.14	1.0	180	0.15	1.0	600	0.18	1.0	45	0.12	0.8	35	0.15	1.0
	T9325	0.4	255	0.17	1.0	150	0.15	1.0	240	0.17	1.0	–	–	–	55	0.15	0.8	–	–	–
	T9315	0.8	–	–	–	95	0.18	1.0	155	0.20	1.0	495	0.24	1.0	50	0.14	0.8	–	–	–
WNMG 060408E-SF	T6310	0.8	200	0.20	1.0	140	0.18	1.0	160	0.20	1.0	600	0.24	1.0	60	0.14	0.8	40	0.15	1.0
	T7335	0.8	220	0.20	1.0	170	0.18	1.0	–	–	–	–	–	70	0.16	0.8	–	–	–	
	T8315	0.8	210	0.20	1.0	125	0.18	1.0	195	0.20	1.0	630	0.24	1.0	50	0.14	0.8	40	0.15	1.0
	T8330	0.8	200	0.20	1.0	120	0.18	1.0	190	0.20	1.0	600	0.24	1.0	50	0.14	0.8	40	0.15	1.0
	T8430	0.8	230	0.20	1.0	125	0.18	1.0	185	0.20	1.0	630	0.24	1.0	45	0.14	0.8	35	0.15	1.0
	T9315	0.8	315	0.20	1.0	–	–	–	295	0.20	1.0	–	–	–	–	–	–	60	0.15	1.0
	T9325	0.8	280	0.20	1.0	165	0.18	1.0	265	0.20	1.0	–	–	–	60	0.16	0.8	–	–	–
	H07	0.4	–	–	–	90	0.14	1.0	145	0.15	1.0	470	0.18	1.0	45	0.12	0.8	–	–	–
	T6310	0.4	180	0.15	1.0	125	0.14	1.0	145	0.15	1.0	540	0.18	1.0	50	0.12	0.8	35	0.15	1.0
WNMG 080404E-SF	T7325	0.4	205	0.17	1.0	155	0.15	1.0	–	–	–	–	–	65	0.15	0.8	–	–	–	
	T7335	0.4	200	0.17	1.0	155	0.15	1.0	–	–	–	–	–	65	0.15	0.8	–	–	–	
	T8315	0.4	195	0.15	1.0	115	0.14	1.0	185	0.15	1.0	585	0.18	1.0	45	0.12	0.8	35	0.15	1.0
	T8330	0.4	180	0.15	1.0	105	0.14	1.0	170	0.15	1.0	540	0.18	1.0	45	0.12	0.8	35	0.15	1.0
	T8430	0.4	220	0.15	1.0	120	0.14	1.0	180	0.15	1.0	600	0.18	1.0	45	0.12	0.8	35	0.15	1.0
	T9315	0.4	300	0.15	1.0	–	–	–	285	0.15	1.0	–	–	–	–	–	–	60	0.15	1.0
	T9325	0.4	255	0.17	1.0	150	0.15	1.0	240	0.17	1.0	–	–	–	55	0.15	0.8	–	–	–
	H07	0.8	–	–	–	95	0.18	1.0	155	0.20	1.0	495	0.24	1.0	50	0.14	0.8	–	–	–
	T6310	0.8	200	0.20	1.0	140	0.18	1.0	160	0.20	1.0	600	0.24	1.0	60	0.14	0.8	40	0.15	1.0
WNMG 080408E-SF	T7325	0.8	230	0.20	1.0	175	0.18	1.0	–	–	–	–	–	70	0.16	0.8	–	–	–	
	T7335	0.8	220	0.20	1.0	170	0.18	1.0	–	–	–	–	–	70	0.16	0.8	–	–	–	
	T8315	0.8	210	0.20	1.0	125	0.18	1.0	195	0.20	1.0	630	0.24	1.0	50	0.14	0.8	40	0.15	1.0
	T8330	0.8	200	0.20	1.0	120	0.18	1.0	190	0.20	1.0	600	0.24	1.0	50	0.14	0.8	40	0.15	1.0
	T8430	0.8	230	0.20	1.0	125	0.18	1.0	185	0.20	1.0	630	0.24	1.0	45	0.14	0.8	35	0.15	1.0
	T9315	0.8	315	0.20	1.0	–	–	–	295	0.20	1.0	–	–	–	–	–	–	60	0.15	1.0
	T9325	0.8	280	0.20	1.0	165	0.18	1.0	265	0.20	1.0	–	–	–	60	0.16	0.8	–	–	–
	H07	1.2	220	0.25	1.5	170	0.23	1.5	–	–	–	–	–	–	70	0.18	1.2	–	–	–

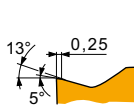

SM geometry with positive design for medium machining, and continuous to interrupted cuts.

WNMG 060404E-SM	T7325	0.4	180	0.22	1.7	140	0.20	1.7	–	–	–	–	–	55	0.20	1.4	–	–	–	
	T7335	0.4	175	0.22	1.7	135	0.20	1.7	–	–	–	–	–	55	0.20	1.4	–	–	–	
	T8330	0.4	155	0.22	1.7	90	0.20	1.7	145	0.22	1.7	465	0.26	1.7	35	0.20	1.4	30	0.15	1.0
	T8430	0.4	175	0.22	1.7	95	0.20	1.7	140	0.22	1.7	480	0.26	1.7	35	0.20	1.4	30	0.15	1.0
	T9315	0.4	250	0.20	1.7	–	–	–	235	0.20	1.7	–	–	–	–	–	–	50	0.15	1.0
	T9325	0.4	215	0.22	1.7	125	0.20	1.7	200	0.22	1.7	–	–	–	45	0.20	1.4	–	–	–
WNMG 060408E-SM	T6310	0.8	175	0.25	1.7	125	0.23	1.7	140	0.25	1.7	525	0.30	1.7	50	0.20	1.4	35	0.15	1.0
	T7325	0.8	200	0.25	1.7	155	0.23	1.7	–	–	–	–	–	65	0.20	1.4	–	–	–	
	T7335	0.8	195	0.25	1.7	150	0.23	1.7	–	–	–	–	–	60	0.20	1.4	–	–	–	
	T8330	0.8	175	0.25	1.7	105	0.23	1.7	165	0.25	1.7	525	0.30	1.7	40	0.20	1.4	35	0.15	1.0
	T8430	0.8	195	0.25	1.7	105	0.23	1.7	160	0.25	1.7	540	0.30	1.7	40	0.20	1.4	30	0.15	1.0
	T9325	0.8	240	0.25	1.7	140	0.23	1.7	225	0.25	1.7	–	–	–	50	0.20	1.4	–	–	–
WNMG 060412E-SM	T7325	1.2	200	0.30	1.7	155	0.27	1.7	–	–	–	–	–	65	0.24	1.4	–	–	–	
	T8330	1.2	180	0.30	1.7	105	0.27	1.7	170	0.30	1.7	540	0.36	1.7	45	0.24	1.4	35	0.15	1.0
	T8430	1.2	195	0.30	1.7	105	0.27	1.7	160	0.30	1.7	540	0.36	1.7	40	0.24	1.4	30	0.15	1.0
	T9325	1.2	240	0.30	1.7	140	0.27	1.7	225	0.30	1.7	–	–	–	50	0.24	1.4	–	–	–



Suitability and starting values for cutting speed (vc), feed (f) and depth of cut (ap). Refer to our Machining Calculator app for further calculations.

Product	RE (mm)	P			M			K			N			S			H		
		vc (m/min)	f (mm/rev)	ap (mm)	vc (m/min)	f (mm/rev)	ap (mm)	vc (m/min)	f (mm/rev)	ap (mm)	vc (m/min)	f (mm/rev)	ap (mm)	vc (m/min)	f (mm/rev)	ap (mm)	vc (m/min)	f (mm/rev)	ap (mm)

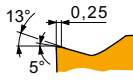

SM geometry with positive design for medium machining, and continuous to interrupted cuts.

WNMG 080404E-SM	T6310	0.4	155	0.22	2.0	110	0.20	2.0	125	0.22	2.0	465	0.26	2.0	45	0.20	1.6	30	0.15	1.0
	T7325	0.4	175	0.22	2.0	135	0.20	2.0	-	-	-	-	-	-	55	0.20	1.6	-	-	-
	T7335	0.4	170	0.22	2.0	130	0.20	2.0	-	-	-	-	-	-	55	0.20	1.6	-	-	-
	T8330	0.4	155	0.22	2.0	90	0.20	2.0	145	0.22	2.0	465	0.26	2.0	35	0.20	1.6	30	0.15	1.0
	T8430	0.4	170	0.22	2.0	90	0.20	2.0	135	0.22	2.0	465	0.26	2.0	35	0.20	1.6	25	0.15	1.0
	T9315	0.4	245	0.20	2.0	-	-	-	230	0.20	2.0	-	-	-	-	-	-	45	0.15	1.0
T9325	0.4	210	0.22	2.0	125	0.20	2.0	195	0.22	2.0	-	-	-	45	0.20	1.6	-	-	-	-
WNMG 080408E-SM	T6310	0.8	175	0.25	2.0	125	0.23	2.0	140	0.25	2.0	525	0.30	2.0	50	0.20	1.6	35	0.15	1.0
	T7325	0.8	200	0.25	2.0	155	0.23	2.0	-	-	-	-	-	65	0.20	1.6	-	-	-	-
	T7335	0.8	190	0.25	2.0	145	0.23	2.0	-	-	-	-	-	60	0.20	1.6	-	-	-	-
	T8330	0.8	175	0.25	2.0	105	0.23	2.0	165	0.25	2.0	525	0.30	2.0	40	0.20	1.6	35	0.15	1.0
	T8430	0.8	195	0.25	2.0	105	0.23	2.0	160	0.25	2.0	540	0.30	2.0	40	0.20	1.6	30	0.15	1.0
	T9315	0.8	265	0.25	2.0	-	-	-	250	0.25	2.0	-	-	-	-	-	50	0.15	1.0	-
T9325	0.8	235	0.25	2.0	140	0.23	2.0	220	0.25	2.0	-	-	-	50	0.20	1.6	-	-	-	-
WNMG 080412E-SM	T6310	1.2	175	0.30	2.0	125	0.27	2.0	140	0.30	2.0	525	0.36	2.0	50	0.24	1.6	35	0.15	1.0
	T7325	1.2	195	0.30	2.0	150	0.27	2.0	-	-	-	-	-	60	0.24	1.6	-	-	-	-
	T7335	1.2	190	0.30	2.0	145	0.27	2.0	-	-	-	-	-	60	0.24	1.6	-	-	-	-
	T8330	1.2	175	0.30	2.0	105	0.27	2.0	165	0.30	2.0	525	0.36	2.0	40	0.24	1.6	35	0.15	1.0
	T8430	1.2	190	0.30	2.0	105	0.27	2.0	155	0.30	2.0	525	0.36	2.0	40	0.24	1.6	30	0.15	1.0
	T9315	1.2	260	0.30	2.0	-	-	-	245	0.30	2.0	-	-	-	-	-	50	0.15	1.0	-
T9325	1.2	235	0.30	2.0	140	0.27	2.0	220	0.30	2.0	-	-	-	50	0.24	1.6	-	-	-	-

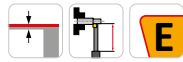
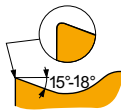

ER-SI geometry with positive right-handed geometry for fine-finish to semi-rough machining, and continuous cuts.

WNMG 060404ER-SI	T8330	0.4	195	0.20	1.7	115	0.18	1.7	-	-	-	585	0.24	1.7	45	0.18	1.4	-	-	-
	T8430	0.4	225	0.20	1.7	120	0.18	1.7	-	-	-	615	0.24	1.7	45	0.18	1.4	-	-	-
	T9325	0.4	270	0.20	1.7	160	0.18	1.7	-	-	-	-	-	-	60	0.18	1.4	-	-	-
WNMG 080404ER-SI	T7325	0.4	220	0.20	1.7	170	0.18	1.7	-	-	-	-	-	-	70	0.18	1.4	-	-	-
	T7335	0.4	215	0.20	1.7	165	0.18	1.7	-	-	-	-	-	-	65	0.18	1.4	-	-	-
	T8315	0.4	205	0.20	1.7	120	0.18	1.7	-	-	-	615	0.24	1.7	50	0.18	1.4	-	-	-
	T8330	0.4	195	0.20	1.7	115	0.18	1.7	-	-	-	585	0.24	1.7	45	0.18	1.4	-	-	-
	T8430	0.4	225	0.20	1.7	120	0.18	1.7	-	-	-	615	0.24	1.7	45	0.18	1.4	-	-	-
	T9325	0.4	270	0.20	1.7	160	0.18	1.7	-	-	-	-	-	-	60	0.18	1.4	-	-	-
WNMG 080408ER-SI	T7325	0.8	215	0.35	1.7	165	0.32	1.7	-	-	-	-	-	-	65	0.25	1.4	-	-	-
	T7335	0.8	205	0.35	1.7	155	0.32	1.7	-	-	-	-	-	-	65	0.25	1.4	-	-	-
	T8315	0.8	205	0.35	1.7	120	0.32	1.7	-	-	-	615	0.42	1.7	50	0.25	1.4	-	-	-
	T8330	0.8	195	0.35	1.7	115	0.32	1.7	-	-	-	585	0.42	1.7	45	0.25	1.4	-	-	-
	T8430	0.8	210	0.35	1.7	115	0.32	1.7	-	-	-	585	0.42	1.7	45	0.25	1.4	-	-	-
	T9325	0.8	255	0.35	1.7	150	0.32	1.7	-	-	-	-	-	-	55	0.25	1.4	-	-	-
WNMG 080412ER-SI	T8430	1.2	225	0.35	1.7	120	0.32	1.7	-	-	-	615	0.42	1.7	45	0.25	1.4	-	-	-
	T9325	1.2	265	0.35	1.7	155	0.32	1.7	-	-	-	-	-	-	55	0.25	1.4	-	-	-

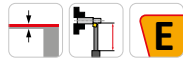
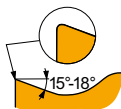









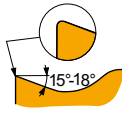

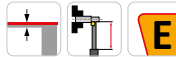
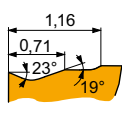

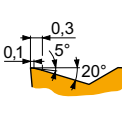
EL-SI geometry with positive left-handed design for fine-finish to semi-rough machining, and continuous cuts.

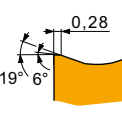
WNMG 060404EL-SI	T8330	0.4	195	0.20	1.7	115	0.18	1.7	-	-	-	585	0.24	1.7	45	0.18	1.4	-	-	-
	T8430	0.4	225	0.20	1.7	120	0.18	1.7	-	-	-	615	0.24	1.7	45	0.18	1.4	-	-	-
	T9325	0.4	270	0.20	1.7	160	0.18	1.7	-	-	-	-	-	-	60	0.18	1.4	-	-	-
WNMG 080404EL-SI	T7325	0.4	220	0.20	1.7	170	0.18	1.7	-	-	-	-	-	-	70	0.18	1.4	-	-	-
	T7335	0.4	215	0.20	1.7	165	0.18	1.7	-	-	-	-	-	-	65	0.18	1.4	-	-	-
	T8315	0.4	205	0.20	1.7	120	0.18	1.7	-	-	-	615	0.24	1.7	50	0.18	1.4	-	-	-
	T8330	0.4	195	0.20	1.7	115	0.18	1.7	-	-	-	585	0.24	1.7	45	0.18	1.4	-	-	-
	T8430	0.4	225	0.20	1.7	120	0.18	1.7	-	-	-	615	0.24	1.7	45	0.18	1.4	-	-	-
	T9325	0.4	270	0.20	1.7	160	0.18	1.7	-	-	-	-	-	-	60	0.18	1.4	-	-	-

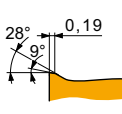

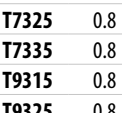
Suitability and starting values for cutting speed (vc), feed (f) and depth of cut (ap). Refer to our Machining Calculator app for further calculations.

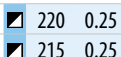
Product	RE (mm)	P			M			K			N			S			H					
		vc [m/min]	f [mm/rev]	ap [mm]	vc [m/min]	f [mm/rev]	ap [mm]	vc [m/min]	f [mm/rev]	ap [mm]	vc [m/min]	f [mm/rev]	ap [mm]	vc [m/min]	f [mm/rev]	ap [mm]	vc [m/min]	f [mm/rev]	ap [mm]			
 EL-SI geometry with positive left-handed design for fine-finish to semi-rough machining, and continuous cuts.			T7325	0.8	215	0.35	1.7	165	0.32	1.7	–	–	–	615	0.42	1.7	65	0.25	1.4	–	–	–
			T7335	0.8	205	0.35	1.7	155	0.32	1.7	–	–	–	615	0.42	1.7	65	0.25	1.4	–	–	–
			T8315	0.8	205	0.35	1.7	120	0.32	1.7	–	–	–	615	0.42	1.7	50	0.25	1.4	–	–	–
			T8330	0.8	195	0.35	1.7	115	0.32	1.7	–	–	–	585	0.42	1.7	45	0.25	1.4	–	–	–
			T8430	0.8	210	0.35	1.7	115	0.32	1.7	–	–	–	585	0.42	1.7	45	0.25	1.4	–	–	–
			T9325	0.8	255	0.35	1.7	150	0.32	1.7	–	–	–	–	–	–	55	0.25	1.4	–	–	–
			T8430	1.2	225	0.35	1.7	120	0.32	1.7	–	–	–	615	0.42	1.7	45	0.25	1.4	–	–	–
 W-F wiper geometry for fine to finish machining with increased feed rates and improved surface finish.			T9315	0.8	215	0.45	0.8	–	–	–	200	0.45	0.8	–	–	–	–	–	–	–	–	
			T9325	0.8	190	0.45	0.8	–	–	–	180	0.45	0.8	–	–	–	–	–	–	–	–	
			T9315	0.4	250	0.25	0.4	–	–	–	235	0.25	0.4	–	–	–	–	–	–	–	–	
			T9325	0.4	225	0.25	0.4	–	–	–	210	0.25	0.4	–	–	–	–	–	–	–	–	
 W-M wiper geometry for semi-rough to rough machining with increased feed rates and improved surface finish.			T9310	0.8	220	0.45	1.2	–	–	–	205	0.45	1.2	–	–	–	–	–	–	–		
			T9315	0.8	205	0.45	1.2	–	–	–	190	0.45	1.2	–	–	–	–	–	–	–		
			T9325	0.8	190	0.45	1.2	–	–	–	180	0.45	1.2	–	–	–	–	–	–	–		
			T5315	1.2	235	0.55	1.2	–	–	–	220	0.55	1.2	–	–	–	–	–	–	–		
			T9315	1.2	205	0.55	1.2	–	–	–	190	0.55	1.2	–	–	–	–	–	–	–		
 W-MR wiper geometry for finish to rough machining with increased feed rates and improved surface finish.			T9315	0.8	200	0.45	1.5	–	–	–	190	0.45	1.5	–	–	–	–	–	–			
			T9325	0.8	185	0.45	1.5	–	–	–	175	0.45	1.5	–	–	–	–	–	–			
			T9325	1.2	180	0.55	1.5	–	–	–	170	0.55	1.5	–	–	–	–	–	–			
 W-NM wiper geometry for finish to rough machining with increased feed rates and improved surface finish.			T9315	0.8	205	0.45	1.2	–	–	–	190	0.45	1.2	–	–	–	–	–	–			
			T9325	0.8	190	0.45	1.2	110	0.41	1.2	180	0.45	1.2	–	–	–	–	–	–			
			T9315	0.4	200	0.30	1.5	–	–	–	190	0.30	1.5	–	–	–	–	–	–			
			T9325	0.4	180	0.30	1.5	105	0.27	1.5	170	0.30	1.5	–	–	–	–	–	–			
			T5315	0.8	230	0.45	1.5	–	–	–	215	0.45	1.5	–	–	–	–	–	–			
			T9310	0.8	215	0.45	1.5	–	–	–	200	0.45	1.5	–	–	–	–	–	–			
			T9315	0.8	200	0.45	1.5	–	–	–	190	0.45	1.5	–	–	–	–	–	–			
			T9325	0.8	185	0.45	1.5	110	0.41	1.5	175	0.45	1.5	–	–	–	–	–	–			
			T5315	1.2	230	0.55	1.5	–	–	–	215	0.55	1.5	–	–	–	–	–	–			
			T9310	1.2	210	0.55	1.5	–	–	–	195	0.55	1.5	–	–	–	–	–	–			
T9315	1.2	200	0.55	1.5	–	–	–	190	0.55	1.5	–	–	–	–	–	–						
T9325	1.2	180	0.55	1.5	105	0.50	1.5	170	0.55	1.5	–	–	–	–	–	–						
 W-NM wiper geometry for finish to rough machining with increased feed rates and improved surface finish.			T7325	0.8	220	0.25	1.8	170	0.23	1.8	–	–	–	70	0.20	1.4	–	–	–			
			T7335	0.8	215	0.25	1.8	165	0.23	1.8	–	–	–	65	0.20	1.4	–	–	–			
			T9315	0.8	290	0.25	1.8	–	–	–	275	0.25	1.8	–	–	–	–	–	–			
			T9325	0.8	265	0.25	1.8	155	0.23	1.8	250	0.25	1.8	–	–	–	55	0.20	1.4	–	–	



Suitability and starting values for cutting speed (vc), feed (f) and depth of cut (ap). Refer to our Machining Calculator app for further calculations.

Product	RE [mm]	P			M			K			N			S			H		
		vc [m/min]	f [mm/rev]	ap [mm]	vc [m/min]	f [mm/rev]	ap [mm]	vc [m/min]	f [mm/rev]	ap [mm]	vc [m/min]	f [mm/rev]	ap [mm]	vc [m/min]	f [mm/rev]	ap [mm]	vc [m/min]	f [mm/rev]	ap [mm]

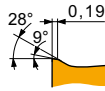

W-NM wiper geometry for finish to rough machining with increased feed rates and improved surface finish.

WNMG 080404W-NM	T7325	0.4	195	0.20	2.1	150	0.18	2.1	-	-	-	-	-	-	60	0.16	1.7	-	-	-
	T7335	0.4	190	0.20	2.1	145	0.18	2.1	-	-	-	-	-	-	60	0.16	1.7	-	-	-
	T9315	0.4	270	0.20	2.1	-	-	-	255	0.20	2.1	-	-	-	-	-	-	-	-	-
	T9325	0.4	240	0.20	2.1	140	0.18	2.1	225	0.20	2.1	-	-	-	50	0.16	1.7	-	-	-
WNMG 080408W-NM	T7325	0.8	215	0.25	2.1	165	0.23	2.1	-	-	-	-	-	-	65	0.20	1.7	-	-	-
	T7335	0.8	210	0.25	2.1	160	0.23	2.1	-	-	-	-	-	-	65	0.20	1.7	-	-	-
	T9315	0.8	290	0.25	2.1	-	-	-	275	0.25	2.1	-	-	-	-	-	-	-	-	-
	T9325	0.8	260	0.25	2.1	155	0.23	2.1	245	0.25	2.1	-	-	-	55	0.20	1.7	-	-	-
WNMG 080412W-NM	T7325	1.2	215	0.30	2.1	165	0.27	2.1	-	-	-	-	-	-	65	0.24	1.7	-	-	-
	T7335	1.2	210	0.30	2.1	160	0.27	2.1	-	-	-	-	-	-	65	0.24	1.7	-	-	-
	T9315	1.2	285	0.30	2.1	-	-	-	270	0.30	2.1	-	-	-	-	-	-	-	-	-

WNMM



	IC [mm]	D1 [mm]	L [mm]	S [mm]
0804	12.700	5.16	8.70	4.76
1006	15.875	6.35	10.80	6.35
1306	19.050	7.94	13.00	6.35

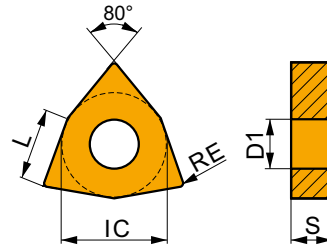

Suitability and starting values for cutting speed (vc), feed (f) and depth of cut (ap). Refer to our Machining Calculator app for further calculations.

Product	RE [mm]	P			M			K			N			S			H		
		vc [m/min]	f [mm/rev]	ap [mm]	vc [m/min]	f [mm/rev]	ap [mm]	vc [m/min]	f [mm/rev]	ap [mm]	vc [m/min]	f [mm/rev]	ap [mm]	vc [m/min]	f [mm/rev]	ap [mm]	vc [m/min]	f [mm/rev]	ap [mm]

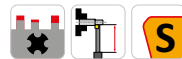
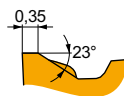

DR geometry for semi-rough to rough machining, and continuous to interrupted cuts.

WNMM 100608E-DR	T9325	0.8	205	0.40	5.0	120	0.36	5.0	190	0.40	5.0	-	-	-	-	-	-	-	-
	T9335	0.8	175	0.40	5.0	105	0.36	5.0	-	-	-	-	-	-	-	-	-	-	-
WNMM 130612E-DR	T9325	1.2	200	0.45	6.0	120	0.41	6.0	190	0.45	6.0	-	-	-	-	-	-	-	-
	T9335	1.2	170	0.45	6.0	100	0.41	6.0	-	-	-	-	-	-	-	-	-	-	-

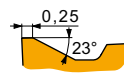

NR geometry for semi-rough to rough machining, and continuous to interrupted cuts.

WNMM 080408E-NR	T7325	0.8	175	0.40	3.0	135	0.36	3.0	-	-	-	-	-	55	0.28	2.4	-	-	-
	T8330	0.8	155	0.40	3.0	90	0.36	3.0	145	0.40	3.0	-	-	35	0.28	2.4	-	-	-
	T8430	0.8	165	0.40	3.0	90	0.36	3.0	135	0.40	3.0	-	-	35	0.28	2.4	-	-	-
	T9325	0.8	195	0.40	3.0	115	0.36	3.0	185	0.40	3.0	-	-	40	0.28	2.4	-	-	-

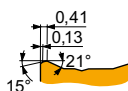

NR2 geometry for semi-rough to rough machining, and continuous to interrupted cuts.

WNMM 080408E-NR2	T7335	0.8	160	0.40	4.0	120	0.36	4.0	-	-	-	-	-	50	0.28	3.2	-	-	-
	T9325	0.8	190	0.40	4.0	110	0.36	4.0	180	0.40	4.0	-	-	40	0.28	3.2	-	-	-



Suitability and starting values for cutting speed (vc), feed (f) and depth of cut (ap). Refer to our Machining Calculator app for further calculations.

Product	RE [mm]	P			M			K			N			S			H		
		vc [m/min]	f [mm/rev]	ap [mm]	vc [m/min]	f [mm/rev]	ap [mm]	vc [m/min]	f [mm/rev]	ap [mm]	vc [m/min]	f [mm/rev]	ap [mm]	vc [m/min]	f [mm/rev]	ap [mm]	vc [m/min]	f [mm/rev]	ap [mm]

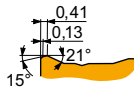

NR2 geometry for semi-rough to rough machining, and continuous to interrupted cuts.

WNMM 080412E-NR2	T7325	1.2	175	0.45	4.0	135	0.41	4.0	—	—	—	—	—	—	55	0.32	3.2	—	—	—
	T9325	1.2	190	0.45	4.0	110	0.41	4.0	180	0.45	4.0	—	—	—	40	0.32	3.2	—	—	—

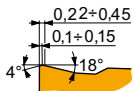

OR geometry for semi-rough to rough machining, and continuous to interrupted cuts.

WNMM 080408E-OR	T8330	0.8	150	0.40	4.0	90	0.36	4.0	140	0.40	4.0	—	—	—	35	0.28	3.2	—	—	—
	T8430	0.8	155	0.40	4.0	85	0.36	4.0	130	0.40	4.0	—	—	—	30	0.28	3.2	—	—	—
	T9325	0.8	190	0.40	4.0	110	0.36	4.0	180	0.40	4.0	—	—	—	40	0.28	3.2	—	—	—
	T9335	0.8	165	0.40	4.0	95	0.36	4.0	—	—	—	—	—	—	35	0.28	3.2	—	—	—
WNMM 080412E-OR	T9325	1.2	190	0.45	4.0	110	0.41	4.0	180	0.45	4.0	—	—	—	40	0.36	3.2	—	—	—
	T9335	1.2	170	0.45	4.0	100	0.41	4.0	—	—	—	—	—	—	35	0.36	3.2	—	—	—
WNMM 080416E-OR	T9325	1.6	195	0.50	4.0	115	0.45	4.0	185	0.50	4.0	—	—	—	40	0.40	3.2	—	—	—
WNMM 130612E-OR	T9325	1.2	185	0.45	6.0	110	0.41	6.0	175	0.45	6.0	—	—	—	40	0.36	4.8	—	—	—
WNMM 130616E-OR	T9325	1.6	180	0.50	6.0	105	0.45	6.0	170	0.50	6.0	—	—	—	40	0.40	4.8	—	—	—

WNGA CBN

PRAMET

	IC [mm]	D1 [mm]	L [mm]	S [mm]
0804	12.700	5.16	8.70	4.76

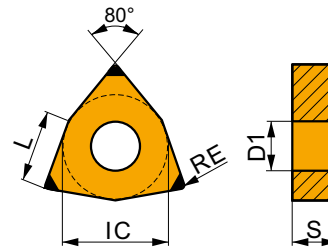

Suitability and starting values for cutting speed (vc), feed (f) and depth of cut (ap). Refer to our Machining Calculator app for further calculations.

Product	RE [mm]	P			M			K			N			S			H		
		vc [m/min]	f [mm/rev]	ap [mm]	vc [m/min]	f [mm/rev]	ap [mm]	vc [m/min]	f [mm/rev]	ap [mm]	vc [m/min]	f [mm/rev]	ap [mm]	vc [m/min]	f [mm/rev]	ap [mm]	vc [m/min]	f [mm/rev]	ap [mm]

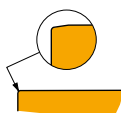

For finish machining and continuous cuts.

WNGA 080408S01020C	TB310	0.8	—	—	—	—	—	—	530	0.15	0.6	—	—	—	140	0.11	0.5	110	0.15	1.0
--------------------	-------	-----	---	---	---	---	---	---	-----	------	-----	---	---	---	-----	------	-----	-----	------	-----

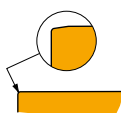

For finish machining and continuous cuts.

WNGA080408S01020WC	TB310	0.8	—	—	—	—	—	—	530	0.15	0.6	—	—	—	140	0.11	0.5	110	0.15	1.0
--------------------	-------	-----	---	---	---	---	---	---	-----	------	-----	---	---	---	-----	------	-----	-----	------	-----

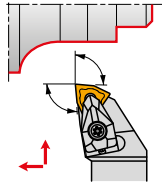

DWLN(RL) EXT

External Double Clamp Holder with 95° Cutting Angle for WN.. Insert

External Right/Left hand double clamp turning holder with 95° cutting angle. Suited for longitudinal turning with shoulder, face, taper and chamfer turning with negative WN.. 06 to 13 inserts. Available with shank size 16x16 up to 40x40 mm. Body treated for longer tool life.

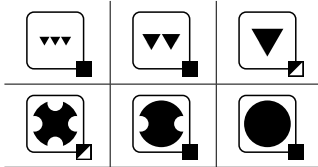
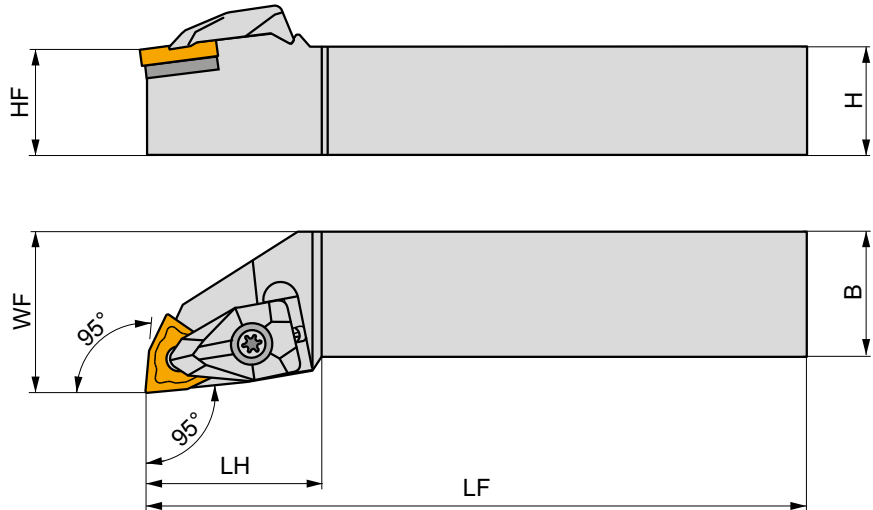

Product	H	B	HF	WF	LF	LH	LAMS	GAMO	kg				
	[mm]	[mm]	[mm]	[mm]	[mm]	[mm]	[°]	[°]					
R	DWLN R 1616 H 06	16	16	16	20	100	26.4	-6	-6	0.22	GI028	DW06	-
	DWLN R 2020 K 06	20	20	20	25	125	27.1	-6	-6	0.41	GI028	DW06	-
	DWLN R 2525 M 06	25	25	25	32	150	27.1	-6	-6	0.75	GI028	DW06	-
	DWLN R 2020 K 08	20	20	20	25	125	34.3	-6	-6	0.43	GI072	DW08	AT004
	DWLN R 2525 M 08	25	25	25	32	150	35	-6	-6	0.75	GI072	DW08	AT004
	DWLN R 3225 P 08	32	25	32	32	170	35	-6	-6	1.01	GI072	DW08	AT004
	DWLN R 3225 P 10	32	25	32	32	170	38	-6	-6	1.06	GI166	DW10	-
	DWLN R 3232 P 13	32	32	32	40	170	40	-6	-6	1.44	GI167	DW13	-
	DWLN R 4040 S 13	40	40	40	50	250	41	-6	-6	3.19	GI167	DW13	-
L	DWLN L 1616 H 06	16	16	16	20	100	26.4	-6	-6	0.22	GI028	DW06	-
	DWLN L 2020 K 06	20	20	20	25	125	27.1	-6	-6	0.41	GI028	DW06	-
	DWLN L 2525 M 06	25	25	25	32	150	27.1	-6	-6	0.76	GI028	DW06	-
	DWLN L 2020 K 08	20	20	20	25	125	34.3	-6	-6	0.43	GI072	DW08	AT004
	DWLN L 2525 M 08	25	25	25	32	150	35	-6	-6	0.75	GI072	DW08	AT004
	DWLN L 3225 P 08	32	25	32	32	170	35	-6	-6	1.10	GI072	DW08	AT004
	DWLN L 3225 P 10	32	25	32	32	170	38	-6	-6	1.14	GI166	DW10	-
	DWLN L 3232 P 13	32	32	32	40	170	40	-6	-6	1.45	GI167	DW13	-
	DWLN L 4040 S 13	40	40	40	50	250	41	-6	-6	3.17	GI167	DW13	-



GI028

WN.. 0604..

GI072

WN.. 0804..







GI166



WN.. 1006..

GI167

WN.. 1306..



						
DW06	DCS 09	1.7	DWS 328-01	US 2004-T09P	FLAG T09P	–
DW08	DCS 12	3.9	DWS 331-12	US 2002-T15P	FLAG T15P/3,5	–
DW10	DCS 16	6.4	DWN 100612	US 5018-T20P	–	LK T20P
DW13	DCS 19	6.4	DWN 130612	US 6013-T20P	–	LK T20P

		
AT004a	CER WN.N 0804..	DCS 12C4
AT004b	CER WN.A 0804..	DCS 12C2



MWLN(RL) EXT



PRAMET

M



External Multi-Clamp Holder with 95° Cutting Angle for WN.. Insert

External Right/Left hand multi-clamp turning holder with 95° cutting angle. Suited for longitudinal turning with shoulder, face, taper and chamfer turning with negative WN..08 inserts. Available with shank size 25x25 up to 40x40 mm. Body treated for longer tool life.

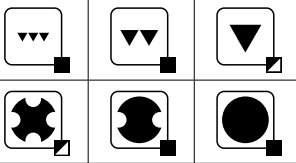
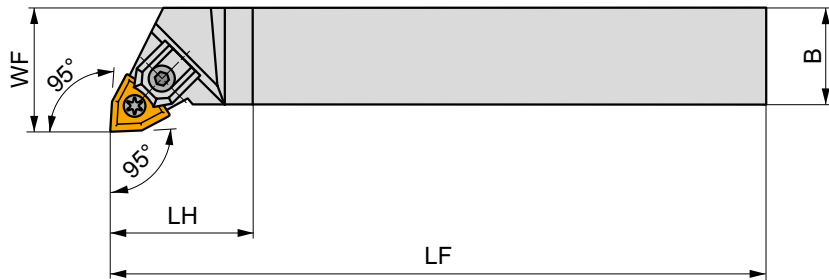
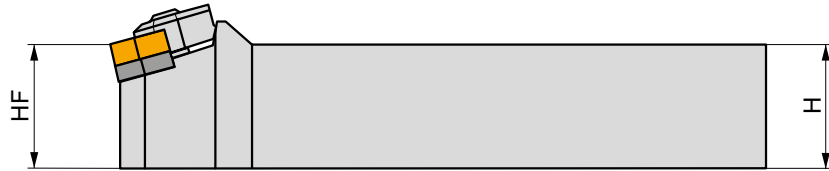
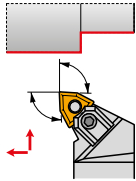

Product	H	B	HF	WF	LF	LH	LAMS	GAMO	kg	GI072	MW1	
	[mm]	[mm]	[mm]	[mm]	[mm]	[mm]	[°]	[°]				
R	MWLN R 2525 M 08	25	25	25	32	150	32	-6	-6	0.73	GI072	MW1
	MWLN R 3225 P 08	32	25	32	32	170	32	-6	-6	1.30	GI072	MW1
	MWLN R 4040 R 08	40	40	40	50	200	32	-6	-6	2.50	GI072	MW1
L	MWLN L 2525 M 08	25	25	25	32	150	32	-6	-6	0.70	GI072	MW1
	MWLN L 3225 P 08	32	25	32	32	170	32	-6	-6	1.02	GI072	MW1
	MWLN L 4040 R 08	40	40	40	50	200	32	-6	-6	2.50	GI072	MW1



GI072



WN..0804..



MW1



UE 05



5.0



WNW 080412



UC 51



HS 0408



HXK 3



PWLN(RL) EXT



PRAMET

P



External Lever Lock Holder with 95° Cutting Angle for WN.. Insert

External Right/Left hand lever lock turning holder with 95° cutting angle. Suited for longitudinal turning with shoulder, face, taper and chamfer turning with negative WN.. 06 and 08 inserts. Available with shank size 16x16 up to 32x25 mm. Body treated for longer tool life.

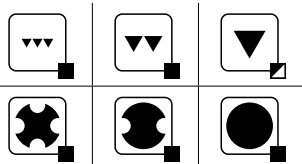
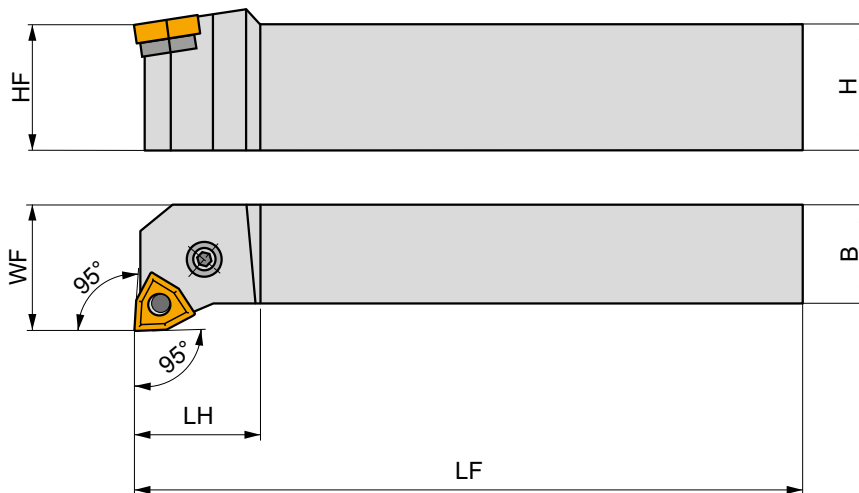
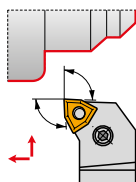

	Product	≠	B	HF	WF	LF	LH	LAMS	GAMO	kg		
		[mm]	[mm]	[mm]	[mm]	[mm]	[mm]	[°]	[°]			
R	PWLN R 1616 H 0604	16	16	16	20	100	20	-6	-6	0.23	G1028	PW11
	PWLN R 2020 K 0604	20	20	20	25	125	20	-6	-6	0.40	G1028	PW10
	PWLN R 2525 M 0604	25	25	25	32	150	20	-6	-6	0.78	G1028	PW10
	PWLN R 2020 K 08	20	20	20	25	125	22	-6	-6	0.42	G1072	PW22
	PWLN R 2525 M 08	25	25	25	32	150	22	-6	-6	0.73	G1072	PW20
	PWLN R 3225 P 08	32	25	32	32	170	22	-6	-6	1.05	G1072	PW20
L	PWLN L 1616 H 0604	16	16	16	20	100	20	-6	-6	0.21	G1028	PW11
	PWLN L 2020 K 0604	20	20	20	25	125	20	-6	-6	0.40	G1028	PW10
	PWLN L 2525 M 0604	25	25	25	32	150	20	-6	-6	0.75	G1028	PW10
	PWLN L 2020 K 08	20	20	20	25	125	22	-6	-6	0.40	G1072	PW22
	PWLN L 2525 M 08	25	25	25	32	150	22	-6	-6	0.74	G1072	PW20
	PWLN L 3225 P 08	32	25	32	32	170	22	-6	-6	1.05	G1072	PW20

G1028
G1072WN.. 0604..
WN.. 0804..

PW10

WNU 060308

PU 01

US 34

5.0

M 6x0.75

19

NT 04

MT 04

HXK 3

PW11

WNU 060308

PU 01

US 46

5.0

M 6x0.75

13.2

NT 04

MT 04

HXK 3

PW20

WNU 080312

PU 02

US 35

6.0

M 8x1

22.5

NT 05

MT 05

HXK 4

PW22

WNU 080312

PU 02

US 42

6.0

M 8x1

21

NT 05

MT 05

HXK 4



C.-DWLN(RL) EXT



External PSC Quick Change Tool, Double Clamp, 95° Cutting Angle, WN.. Ins

External Right/Left hand double clamp tool, through coolant, with 95° cutting angle for face and longitudinal turning with shoulder, taper and chamfering with negative WN.. 06 and 08 inserts. Available with PSC (Polygon Shank Coupling) size C4 up to C6. Body treated for longer tool life.

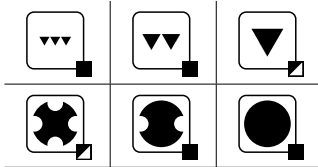
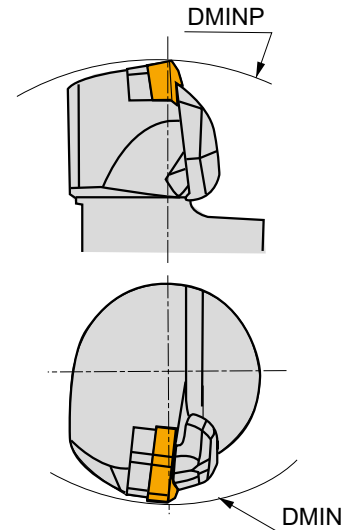
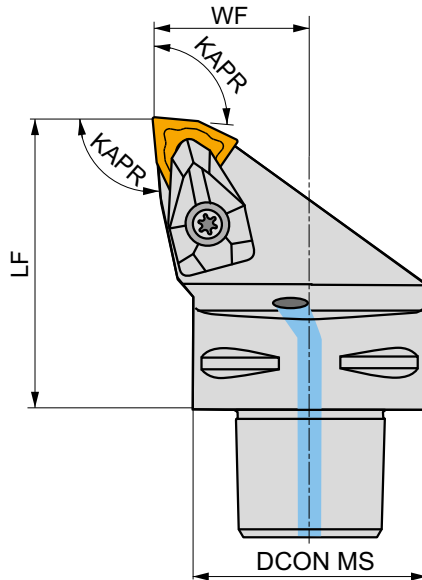
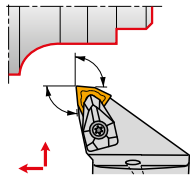

Product	DCON MS	DMIN	DMINP	WF	LF	KAPR	LAMS	GAMO						
	[mm]	[mm]	[mm]	[mm]	[mm]	[°]	[°]	[°]						[kg]
R	C4-DWLN-27050-06	40	60	140	27	50	95	-6	-6	✓	0.42	GI028	C-DW06	-
	C4-DWLN-27050-08	40	110	140	27	50	95	-6	-6	✓	0.42	GI072	C-DW08-1	AT004
	C5-DWLN-35060-08	50	110	165	35	60	95	-6	-6	✓	0.74	GI072	C-DW08-2	AT004
	C6-DWLN-45065-08	63	110	190	45	65	95	-6	-6	✓	1.34	GI072	C-DW08-2	AT004
L	C4-DWLN-27050-06	40	60	140	27	50	95	-6	-6	✓	0.43	GI028	C-DW06	-
	C4-DWLN-27050-08	40	110	140	27	50	95	-6	-6	✓	0.42	GI072	C-DW08-1	AT004
	C5-DWLN-35060-08	50	110	165	35	60	95	-6	-6	✓	0.76	GI072	C-DW08-2	AT004
	C6-DWLN-45065-08	63	110	190	45	65	95	-6	-6	✓	1.34	GI072	C-DW08-2	AT004



GI028
GI072



WN.. 0604..
WN.. 0804..



C-DW06	DCS 09	1.7	DWS 328-01	US 2004-T09P	FLAG T09P	CN 034-01
C-DW08-1	DCS 12	3.9	DWS 331-12	US 2002-T15P	FLAG T15P/3,5	CN 034-01
C-DW08-2	DCS 12	3.9	DWS 331-12	US 2002-T15P	FLAG T15P/3,5	CN 045-01



AT004a
AT004b

CER WN.N 0804..
CER WN.A 0804..

DCS 12C4
DCS 12C2



DWLN(RL) INT

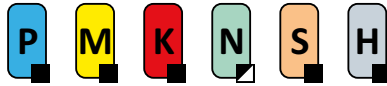

PRAMET

D



Internal Double Clamp Boring Bar with 95° Cutting Angle for WN.. Insert

Internal Right/Left hand double clamp boring bar, through coolant, 95° cutting angle for negative WN.. 06 and 08 inserts. Minimum internal turning diameter Ø32 mm. For internal taper, longitudinal turning with shoulder and chamfer turning, shank sizes Ø25 up to Ø50 mm available. Body treated for longer tool life.

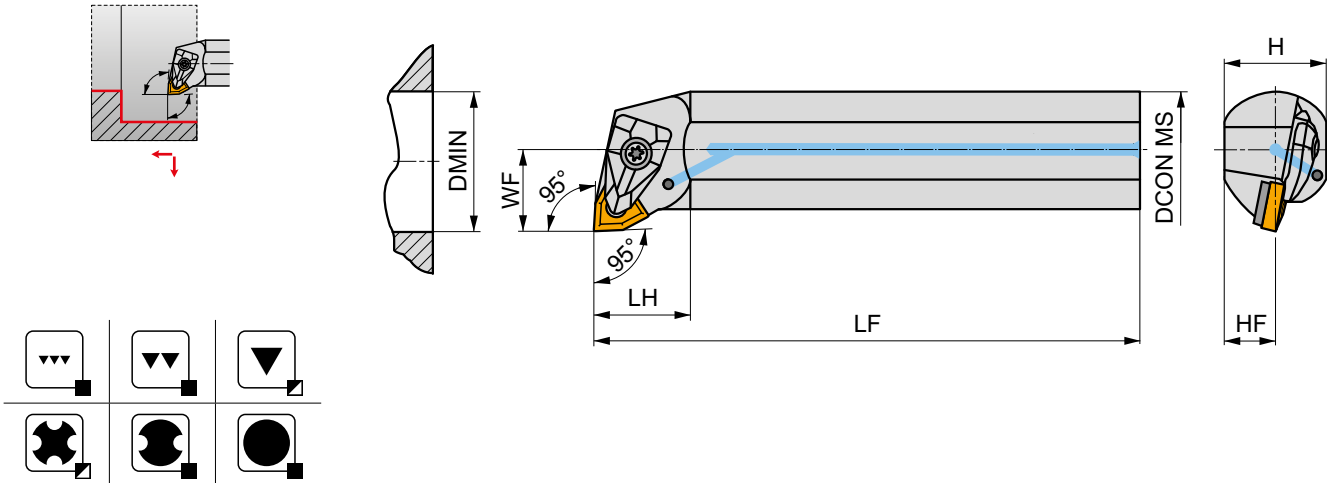

Product	DCON MS [mm]	DMIN [mm]	WF [mm]	H [mm]	HF [mm]	LF [mm]	LH [mm]	LAMS [°]	GAMO [°]					
R	A25T-DWLN R 06	25	32	17	23	11.5	300	31	-14	-6	✓	0.97	GI028	DW06
	A25T-DWLN R 08	25	33	17	23	11.5	300	31	-12	-6	✓	0.98	GI072	DWI08
	A32T-DWLN R 08	32	40	22	30	15	300	33	-10	-6	✓	1.71	GI072	DWI08
	A40T-DWLN R 08	40	50	27	37	18.5	300	36	-13	-6	✓	2.59	GI072	DW08
	A50U-DWLN R 08	50	63	35	47	23.5	350	39	-11	-6	✓	5.24	GI072	DW08
L	A25T-DWLN L 06	25	32	17	23	11.5	300	31	-14	-6	✓	0.97	GI028	DW06
	A25T-DWLN L 08	25	33	17	23	11.5	300	31	-12	-6	✓	0.98	GI072	DWI08
	A32T-DWLN L 08	32	40	22	30	15	300	33	-10	-6	✓	1.70	GI072	DWI08
	A40T-DWLN L 08	40	50	27	37	18.5	300	36	-13	-6	✓	2.59	GI072	DW08
	A50U-DWLN L 08	50	63	35	47	23.5	350	39	-11	-6	✓	5.25	GI072	DW08



G1028

G1072



WN.. 0604..

WN.. 0804..



DW06



DCS 09



1.7



DWS 328-01



US 2004-T09P



FLAG T09P

DW08

DCS 12

3.9

DWS 331-12

US 2002-T15P

FLAG T15P/3,5

DWI08

DCS 12

3.9

DWS 328-02

US 2002-T15P

FLAG T15P/3,5



PWLN(RL) INT



Internal Lever Lock Boring Bar with 95° Cutting Angle for WN.. Insert

Internal Right/Left hand lever lock boring bar, through coolant available, 95° cutting angle for WN.. 06 and 08 inserts. Minimum internal turning diameter Ø20 mm. For internal taper and longitudinal turning with shoulder and chamfer turning. Shank sizes Ø16 to Ø60 mm available. Body treated for longer tool life.

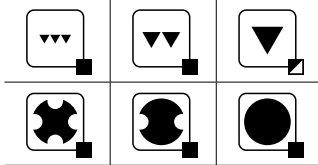
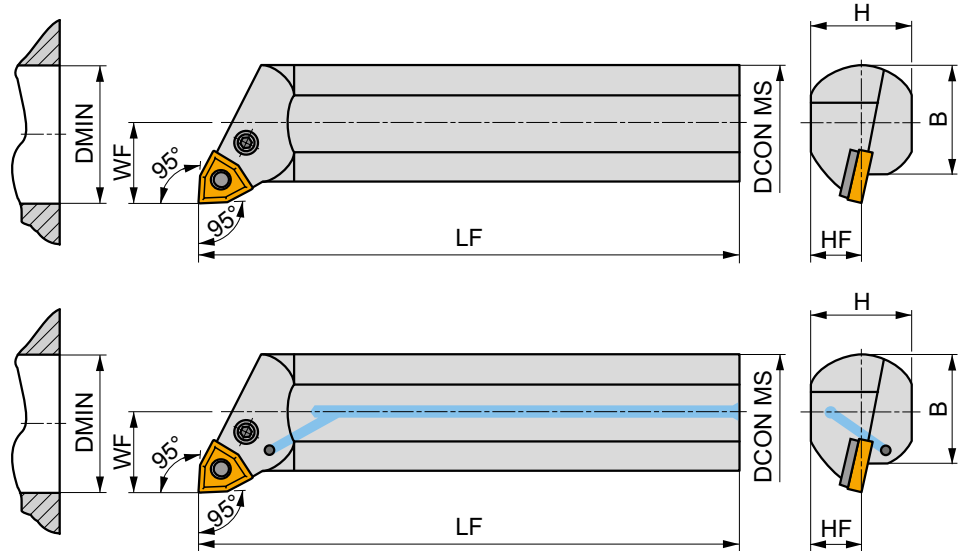
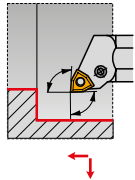

Product	DCON MS	DMIN	WF	H	B	LF	LAMS	GAMO				
	[mm]	[mm]	[mm]	[mm]	[mm]	[mm]	[°]	[°]				
R	A16M-PWLNR 0604	16	20	11	15	150	-13.5	-6	✓	0.22	G1028	PW09
	A20Q-PWLNR 0604	20	27	13	18	180	-13.5	-6	✓	0.36	G1028	PW09
	S25T-PWLNR 0604	25	32	17	23	300	-12	-6	-	1.10	G1028	PW11
	A32S-PWLNR 0604	32	40	22	30	250	-12	-6	✓	1.30	G1028	PW11
	A25R-PWLNR 08	25	32	17	23	200	-12	-6	✓	0.66	G1072	PW25
	S25T-PWLNR 08	25	32	17	23	300	-12	-6	-	1.10	G1072	PW25
	A32S-PWLNR 08	32	40	22	30	250	-12	-6	✓	1.46	G1072	PW21
	S32U-PWLNR 08	32	40	22	30	350	-12	-6	-	2.09	G1072	PW21
	A40T-PWLNR 08	40	50	27	38	300	-12	-6	✓	2.40	G1072	PW20
	A50U-PWLNR 08	50	63	35	47	48.5	350	-12	-6	✓	4.88	G1072
A60V-PWLNR 08	60	80	43	57	58.5	400	-12	-6	✓	8.10	G1072	PW20
L	A16M-PWLNL 0604	16	20	11	15	150	-13.5	-6	✓	0.22	G1028	PW09
	A20Q-PWLNL 0604	20	27	13	18	180	-13.5	-6	✓	0.36	G1028	PW09
	S25T-PWLNL 0604	25	32	17	23	300	-12	-6	-	0.98	G1028	PW11
	A32S-PWLNL 0604	32	40	22	30	250	-12	-6	✓	1.28	G1028	PW11
	A25R-PWLNL 08	25	32	17	23	200	-12	-6	✓	0.75	G1072	PW25
	S25T-PWLNL 08	25	32	17	23	300	-12	-6	-	1.01	G1072	PW25
	A32S-PWLNL 08	32	40	22	30	250	-12	-6	✓	1.47	G1072	PW21
	S32U-PWLNL 08	32	40	22	30	350	-12	-6	-	2.08	G1072	PW21
	A40T-PWLNL 08	40	50	27	38	300	-12	-6	✓	2.90	G1072	PW20
	A50U-PWLNL 08	50	63	35	47	48.5	350	-12	-6	✓	4.88	G1072
A60V-PWLNL 08	60	80	43	57	58.5	400	-12	-6	✓	8.70	G1072	PW20



G1028
G1072



WN.. 0604..
WN.. 0804..



PW09	–	–	PU 3611-A	PS 0512-A	2.0	M 5	12	–	–	HXX 2
PW11	WNU 060308	–	PU 01	US 46	5.0	M 6x0.75	13.2	NT 04	MT 04	HXX 3
PW20	WNU 080312	–	PU 02	US 35	6.0	M 8x1	22.5	NT 05	MT 05	HXX 4
PW21	WNU 080312	–	PU 02	US 41	6.0	M 8x1	17	NT 05	MT 05	HXX 4
PW25	–	–	PU 32	US 46	5.0	M 6x0.75	13.2	–	–	HXX 3



C.-DWLN(RL) INT

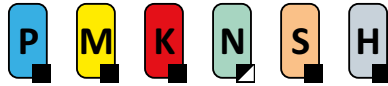

PRAMET

D



Internal PSC Quick Change Tool, Double Clamp, 95° Cutting Angle, WN.. Insert

Internal Right/Left hand double clamp tool, through coolant, with 95° cutting angle for internal taper and longitudinal turning with shoulder and chamfering with WN.. 06 and 08 inserts, minimum internal diameter Ø27 mm. Available with PSC shank (Polygon Shank Coupling) size C4. Body treated for longer tool life.

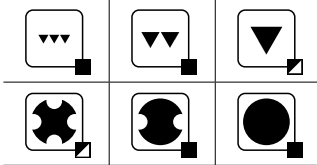
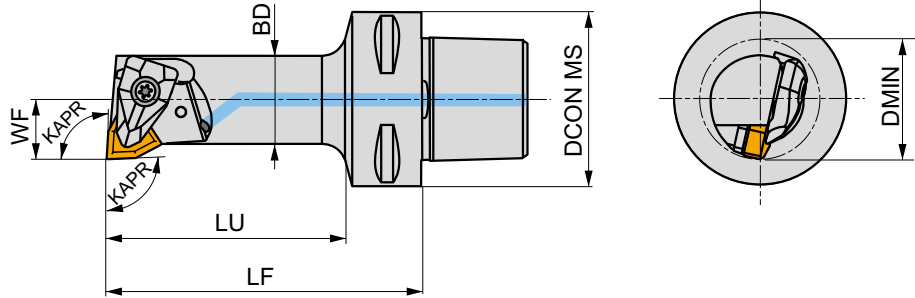
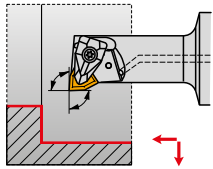

Product	DCON MS	DMIN	WF	LF	LU	BD	KAPR	LAMS	GAMO				
	[mm]	[mm]	[mm]	[mm]	[mm]	[mm]	[°]	[°]	[°]				
R C4-DWLN-13075-06	40	27	13	75	52	20	95	-17	-6	✓	0.42	GI028	DW06
	C4-DWLN-17090-08	40	33	17	90	68	25	95	-12	-6	✓	0.53	GI072
L C4-DWLN-13075-06	40	27	13	75	52	20	95	-17	-6	✓	0.42	GI028	DW06
	C4-DWLN-17090-08	40	33	17	90	68	25	95	-12	-6	✓	0.53	GI072



GI028
GI072



WN.. 0604..
WN.. 0804..



DW06
DWI08



DCS 09
DCS 12



1.7
3.9



DWS 328-01
DWS 328-02



US 2004-T09P
US 2002-T15P



FLAG T09P
FLAG T15P/3,5

**PARTING-OFF
& GROOVING**





TURNING – GENERAL CONTENT

6		WMG & ISO 13399
10	ISO TURNING	INSTRUCTIONS
18		NAVIGATORS
57		POSITIVE INSERTS
219		NEGATIVE INSERTS
386		PARTING – OFF & GROOVING
482		THREAD TURNING
528		BROACHING
536		GENERAL TECHNICAL INFORMATION



PARTING – OFF & GROOVING INSERTS – PAGE OVERVIEW



1 GL. D - GM

	CW	CWTOLL	CWTOLU	INSL
	[mm]	[mm]	[mm]	[mm]
200	2.00	-0.05	0.05	25.0
300	3.00	-0.05	0.05	25.0
400	4.00	-0.05	0.05	25.0
500	5.00	-0.05	0.05	25.0
600	6.00	-0.05	0.05	25.0

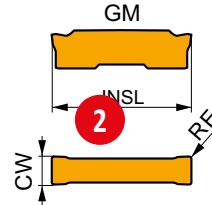

Workpiece material suitability and starting values for cutting speed (vc), feed (f) and depth of cut (ap).

Product	RE	P			M			K			N			S			H		
		vc	f	ap	vc	f	ap	vc	f	ap	vc	f	ap	vc	f	ap			
	[mm]	[m/min]	[mm/rev]	[mm]	[m/min]	[mm/rev]	[mm]	[m/min]	[mm/rev]	[mm]	[m/min]	[mm/rev]	[mm]	[m/min]	[mm/rev]	[mm]	[m/min]	[mm/rev]	[mm]

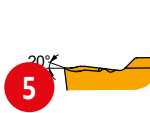

GM geometry for grooving and longitudinal turning of continuous to interrupted cuts.

GL2-D200M02-GM	G8330	0.2	190	0.10	0.8	110	0.09	0.8	180	0.10	0.8	-	-	-	45	0.08	0.6	-	-	-
GL2-D200M02-GM	T7325	0.2	220	0.10	0.8	170	0.09	0.8	-	-	-	-	-	-	70	0.08	0.6	-	-	-
GL3-D300M04-GM	G8330	0.4	150	0.20	1.0	90	0.18	1.0	140	0.20	1.0	-	-	-	35	0.14	0.8	-	-	-
GL3-D300M04-GM	T7325	0.4	175	0.20	1.0	135	0.18	1.0	-	-	-	-	-	-	55	0.14	0.8	-	-	-
GL4-D400M04-GM	G8330	0.4	160	0.20	1.0	95	0.18	1.0	150	0.20	1.0	-	-	-	40	0.14	0.8	-	-	-
GL4-D400M04-GM	T7325	0.4	185	0.20	1.0	140	0.18	1.0	-	-	-	-	-	-	60	0.14	0.8	-	-	-
GL4-D400M08-GM	G8330	0.8	150	0.25	1.2	90	0.23	1.2	140	0.25	1.2	-	-	-	35	0.18	1.0	-	-	-
GL4-D400M08-GM	T7325	0.8	170	0.25	1.2	130	0.23	1.2	-	-	-	-	-	-	55	0.18	1.0	-	-	-
GL5-D500M08-GM	G8330	0.8	180	0.25	1.2	105	0.23	1.2	170	0.25	1.2	-	-	-	45	0.18	1.0	-	-	-
GL5-D500M08-GM	T7325	0.8	200	0.25	1.2	155	0.23	1.2	-	-	-	-	-	-	65	0.18	1.0	-	-	-
GL6-D600M08-GM	G8330	0.8	170	0.30	1.2	100	0.27	1.2	160	0.30	1.2	-	-	-	40	0.21	1.0	-	-	-
GL6-D600M08-GM	T7325	0.8	190	0.30	1.2	145	0.27	1.2	-	-	-	-	-	-	60	0.21	1.0	-	-	-

GL5-D500M08-GM:T7325

Use full insert specification code when ordering!

Grade

Include colon

ISO insert code



PARTING – OFF & GROOVING INSERTS – PAGE OVERVIEW

Pos.	Description	Pos.	Description
1	Designation of insert	7	ISO insert code
2	Schematic drawing of insert	8	Grade
3	Table with insert sizes [mm]	9	Insert radii [mm]
4	Picture of representative insert	10	Geometry description
5	Profile of main cutting edge	11	Application area of insert
6	Icons – specific features and cutting edge type		

1 GG.(RL) INT

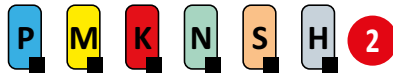

PRAMET

3 G



Internal Grooving Boring Bar for LCM. Inserts

Internal Right/Left hand grooving boring bar for grooving with **5** 0313 and 0413 inserts. Minimum internal grooving diameter Ø16 mm. Suited for internal grooving and multi-directional turning. Available with shank size Ø16 up to Ø32 mm. Body treated for longer tool life.

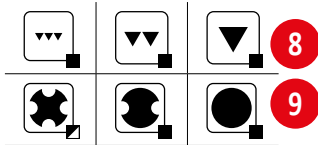
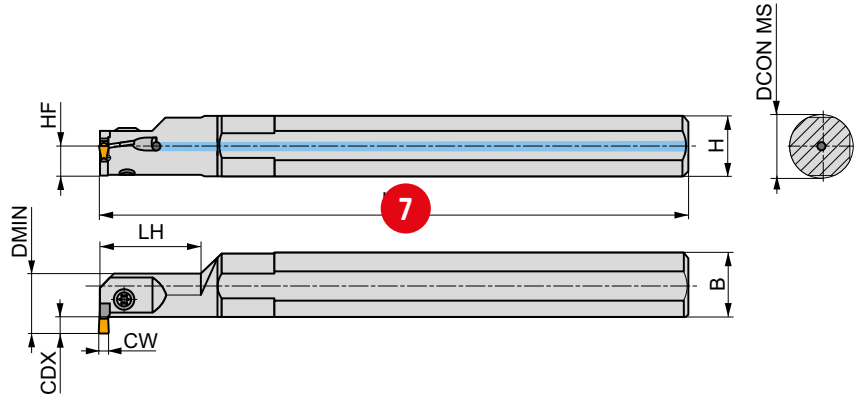
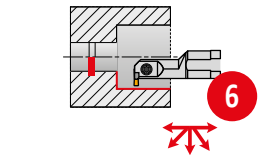

Product	DCON MS [mm]	HF [mm]	H [mm]	B [mm]	L _F [mm]	L _H [mm]	CW [mm]	CDX [mm]	DMIN [mm]		kg		
R A16Q-GGER 0313	16	7.5	15	15.5	180	25	3.00	3	16	✓	0.26	GI143	GL06
A16Q-GGER 0313-04	16	7.5	15	15.5	180	25	3.00	3	16	✓	0.26	GI190	GL06
A20R-GGFR 0313	20	9	18	19	200	30	3.00	4.5	20	✓	0.36	GI143	GL06
A20R-GGFR 0313-04	20	9	18	19	200	30	3.00	4.5	20	✓	0.39	GI190	GL06
A25S-GGHR 0313	25	11.5	23	24	250	40	3.00	6.5	25	✓	0.78	GI143	GL06
11 A25S-GGFL 0313 12	25	11.5	23	24	250	40	4.00	6.5	25	✓	0.78	GI143	GL06
A32T-GGHR 0413	32	15	30	31	300	50	4.00	9.5	32	✓	1.59	GI170	GL06
L A16Q-GGEL 0313	16	7.5	15	15.5	180	25	3.00	3	16	✓	0.29	GI143	GL06
A16Q-GGEL 0313-04	16	7.5	15	15.5	180	25	3.00	3	16	✓	0.28	GI190	GL06
A20R-GGFL 0313	20	9	18	19	200	30	3.00	4.5	20	✓	0.38	GI143	GL06
A20R-GGFL 0313-04	20	9	18	19	200	30	3.00	4.5	20	✓	0.38	GI190	GL06
A25S-GGHL 0313	25	11.5	23	24	250	40	3.00	6.5	25	✓	0.81	GI143	GL06
A25S-GGFL 0413	25	11.5	23	24	250	40	4.00	6.5	25	✓	0.82	GI170	GL06
A32T-GGHL 0413	32	15	30	31	300	50	4.00	9.5	32	✓	1.59	GI170	GL06

	18
GI143	LCM. 0313..
GI170	LCM. 0413..
GI190	LCM. 0313.....-04

			19			
GL06	SR 85011-T15P	5.0	M 5	9		FLAGT15P



PARTING – OFF & GROOVING HOLDERS – PAGE OVERVIEW

Pos.	Description	Pos.	Description
1	Designation of parting-off & grooving holder	11	Tool design
2	Material group recommendations	12	Code of holder
3	Clamping system of insert	13	Dimensions [mm] and angles ²⁾ [°] of holder
4	Illustrative picture ¹⁾	14	Internal coolant supply
5	Tool description	15	Weight [kg]
6	Workpiece profile	16	Group of compatible inserts ³⁾
7	Schematic drawing of tool	17	Group of spare parts ^{3),4)}
8	Achievable quality of surface	18	Compatible inserts
9	Character of cut/working conditions	19	Spare parts
10	Product applications		

¹⁾ Turning holder is primarily displayed in its right design (R)

²⁾ GAMO = orthogonal rake angle (see technical pages)

LAMS = inclination angle of main cutting edge (see technical pages)

³⁾ Code of Group of compatible inserts, spare parts and special accessories is used only for purposes of this catalogue. It cannot be used for orders.

⁴⁾ Spare parts and special accessories icons are designed schematically for ease of understanding. They aren't included in list of icons. Screws are, in some cases, completed with info on torque value in Nm, length of screw and size of thread.



PARTING – OFF & GROOVING – ICONS OVERVIEW

General icons

	Primary use		Finishing – very good surface quality		Suitable for stable working conditions
	Possible use		Medium machining – good surface quality		Suitable for unstable working conditions
			Roughing – unlimited surface roughness		Suitable for very unstable working conditions

Turning operations

	Copy turning (multi directional machining)		Internal grooving		Shallow radial groove
	Deep and wide axial groove (with following expansion)		Internal grooving (with following expansion)		Tube parting off
	Deep axial groove		Parting off		Wide radial groove (with following expansion)
	Deep radial groove		Shallow and wide axial groove (with following expansion)		
	Face copy turning		Shallow axial groove		

Features













	First choice		Universal wide range option		Rounded edge
	Large overhang		Heavy working conditions		Rounded edge with facet

Other

	Clamping torque of screw [Nm]		Internal supply of coolant
--	-------------------------------	--	----------------------------



INSERTS FOR PARTING – OFF & GROOVING – NAVIGATOR

GL. D  406	LCMF 13  418	LCMF 16, LCMF 30  432	LCMF 20  453	LCMR 13  419
LCMR 16, LCMR 30  435	LFMX  456	LFUX  464		
TN R EXT  475	TN R INT  475	TN ZZ EXT  476	TN ZZ INT  477	
X 61  468	X 61 R  469	X 61 R-1  473	X 61-1  472	



PARTING – OFF & GROOVING GEOMETRIES – NAVIGATOR

		Type of operation	insert family choice	
			First choice	Optional choice
EXTERNAL		Grooving	GL. D	
			GM	F
				
			 406	 432
		Parting off	gL. D	
			PM	M2
				
			 407	 457
		Face grooving	ICMF13	
			F	F
				
		 418	 432	
	Copy profiling	gL. D		
		MM	MP	
				
		 406	 433	
	Circlips grooving	x61		
				
		 469	 476	
INTERNAL		Grooving	ICMF13	
			F	
				
			 418	
		Copy profiling	ICMF13	
			MP	
				
		 419		
	Circlips grooving	x61		
				
		 468	 477	



PARTING – OFF & GROOVING GRADES – NAVIGATOR

Grade Identification	Area of Application	Application	Feed	Cutting speed	Resistance to adverse Working Conditions	Coating	Colour	Substrate	Coolant benefit	Grade description
T9325	P15 - P35	☐				MT-CVD	FGM	FGM	++	From a technological perspective this is an extremely versatile grade with high resistance to mechanical damage in adverse cutting conditions and retains excellent wear resistance. The correct application of this material requires high cutting speeds.
	M10 - M30	☐								
	K15 - K35	☐								
	S10 - S20	☐								
T7325	P15 - P35	☐				MT-CVD	FGM	FGM	+++	One of the most universal turning grades. Especially designed for stainless steel machining. Optimal balance between wear resistance and performance reliability. Suitable for broad variety of application in turning operations.
	M10 - M25	☐								
	S10 - S25	☐								
6640	P20 - P40	☐				MT-CVD	H	H	+++	One of the toughest turning materials which can be used especially in roughing operations, or where operational reliability under adverse cutting conditions is a priority. Another ideal choice for machines working with low to medium cutting speeds and medium to high feed rates.
	M20 - M35	☐								
	K25 - K40	☐								
T8330	P25 - P40	☐				PVD	submicron H	submicron H	+++	Versatile cutting material, this is useful for machining of all types of machined materials and is practically applicable in almost all types of turning operations. Its main benefits are its high operational reliability and very good frictional properties; it is therefore suitable for applications at medium and lower cutting speeds.
	M20 - M35	☐								
	K20 - K40	☐								
	N15 - N30	☐								
	S15 - S25	☐								
G8330	P25 - P40	☐				PVD	submicron H	submicron H	+++	Universal cutting grade for grooving and parting-off applications. This grade is characterized by its exceptional reliability and versatility. Developed to fit machining conditions for most workpiece materials.
	M20 - M35	☐								
	K20 - K40	☐								
	S15 - S25	☐								

Substrat	
H	WC-Co based substrate
submicron H	WC-Co based substrate fine grained (< 1 μm)
FGM	Functionally graded substrate

Coating	
MT-CVD	Medium-temperature chemical method of coating
PVD	Low-temperature physical method of coating

Benefits of cutting fluid	
+++	Use of coolant is essential
++	Highly recommended

PARTING-OFF & GROOVING – EXTERNAL

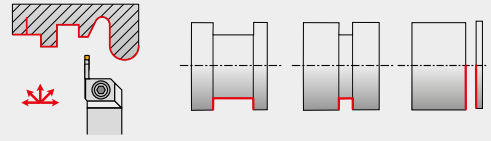

GLSF(RL) EXT		GL.D GL2 GL3 GL4 GL5 GL6	 	GL.D GL2 GL3 GL4 GL5 GL6	 	GLSF(RL) EXT-G	GL.D GL2 GL3 GL4 GL5 GL6	 	GLSF(RL) EXT-S	GL.D GL2 GL3 GL4	 	GFK(RL) EXT	LCMF 0220	
 20×20 25×25 410	406 – 408	 20×20 25×25 412	406 – 408	 12×12 16×16 413	406 – 408	 16×16 25×25 455	418 – 454							
GFI(RL) EXT		LCMF, LCMR 0316 0416 0516 0616 0830	 	LCMF, LCMR 0316 0416 0516 0616 0830	 	GFM(RL) EXT	LCMF, LCMR 0316 0416 0516 0616 0830	 	P61 (RL) EXT	X61 	 	XLCF(RL)	LFUX 03 04 05 06	
 16×16 32×25 437	418 – 454	 20×20 32×25 439	418 – 454	 16×16 25×25 470	468 – 469	 16×12 32×25 465	464							
XLCCN 25 BS + MS-EN		LCMF, LCMR 0316 0416 0516 0616	 	LCMF, LCMR 0316 0416 0516 0616	 	XLCCF(NRL) BS + MS-EN	LFMX 1.50 1.60 2.00 2.20 3.10 4.10 5.10 6.35	 	GLS B + DU, D	GL.D GL2 GL3 GL4 GL5 GL6	 	XLCCN B + DU, D	LCMF, LCMR 0316 0416 0516 0616	
 25×25 32×25 442	418 – 454	 12×12 32×25 461, 463	456 – 458	 20×20 32×29 414, 415	406 – 409	 20×20 32×29 440, 441	418 – 454							
GLS B + DU, D		GL.D GL2 GL3 GL4 GL5 GL6	 	LCMF, LCMR 0316 0416 0516 0616	 	XLCCN B + DU, D	LCMF, LCMR 0316 0416 0516 0616	 	XLCFN B + DU, D	LFMX 1.50 1.60 2.00 2.20 3.10 4.10 5.10 6.35	 	XLCFN B LFUX + DU, D	LFUX 03 04 05 06	
 20×20 32×29 414, 415	406 – 409	 20×20 32×29 440, 441	418 – 454	 20×20 40×36 459, 460	456 – 458	 20×20 40×40 466, 467	464							

FACE GROOVING

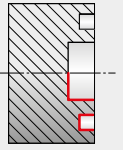

GFIL-L AXIAL	
LCMF, LCMR	
0313 0316	
	17-30 140-230
422, 444	418 – 454

GFIL-R AXIAL	
LCMF, LCMR	
0313 0316 0413 0416	
	17-30 140-230
423, 445	418 – 454

GFIR-L AXIAL	
LCMF, LCMR	
0313 0316 0413 0416	
	17-30 140-230
424, 446	418 – 454

GFIR-R AXIAL	
LCMF, LCMR	
0313 0316	
	17-30 140-230
425, 447	418 – 454

GFML-L AXIAL	
LCMF, LCMR	
0413 0416	
	17-30 140-230
426, 448	418 – 454

GFML-R AXIAL	
LCMF, LCMR	
0413 0416	
	17-30 140-230
427, 449	418 – 454

GFMR-L AXIAL	
LCMF, LCMR	
0413 0416	
	17-30 140-230
428, 450	418 – 454

GFMR-R AXIAL	
LCMF, LCMR	
0413 0416	
	17-30 140-230
429, 451	418 – 454



GGI(RL)-90 AXIAL	
LCMF, LCMR	
0313 0316	
	17-30 110-170
430, 452	418 – 454

XLXFL BS AXIAL + MS-EN	
LFMX	
3.10	
	60-85 150-280
462, 463	456 – 458

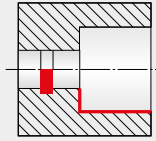
GROOVING – INTERNAL

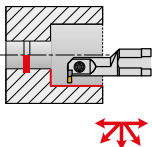
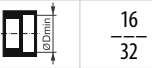

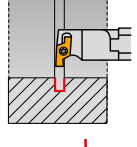
GG.(RL) INT	
	LCMF, LCMR 0313 0413
	$\frac{16}{32}$
421	418 – 454

P61 (RL) INT	
	X61
	$\frac{16}{40}$
471	468

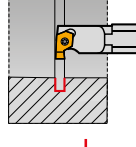
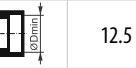
P61S(RL)-1 INT	
	X61-1
	12.5
474	472



PARTING-OFF & GROOVING INSERTS – GL – CODE DESIGNATION

1	2		3	4	5	6	7	8
GL	3	-	D	300	G	02	L06	- PM



1	2	3	4
Tool group	Pocket size	Number of edges	Cutting width – CW

1, 2, 3, 4, 5, 6

GL

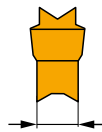

S	One edge
D	Two edges

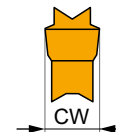

		CW
	200	2.00
	250	2.50
	300	3.00
	400	4.00
	500	5.00
	600	6.00

5	6	7	8
Edge design	Nose radius	Primary cutting edge angle	Chipbreaker designation

G	Ground
M	Direct pressed

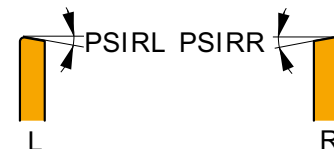
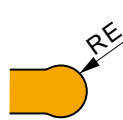
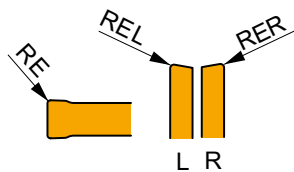

	RE, RER, REL [mm]
02	0.2
03	0.3
04	0.4
08	0.8

ROUND GEOMETRY	
	RE [mm]
MO	RE = CW/2

	[°]
06	6
12	12

PM
PR
GM
MM



PARTING – OFF & GROOVING HOLDERS (EXTERNAL TURNING) – GL – CODE DESIGNATION

1	2	3	4	5	6	7	8	9	10	11
GL	3	S	2525	M	F	L	20	R	120	090

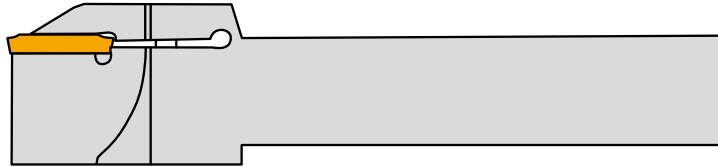

1	2	3	4																			
Tool group	Pocket size	Shank type	Shank dimensions																			
GL	1, 2, 3, 4, 5, 6	<table border="1" style="width: 100%; border-collapse: collapse;"> <tr> <td style="width: 5%; text-align: center;">A</td> <td>steel shank with internal coolant</td> </tr> <tr> <td style="text-align: center;">S</td> <td>steel shank without internal coolant</td> </tr> </table>	A	steel shank with internal coolant	S	steel shank without internal coolant	<table border="1" style="width: 100%; border-collapse: collapse; margin-top: 10px;"> <thead> <tr> <th colspan="2"></th> <th style="text-align: right;">H/B [mm]/[mm]</th> </tr> </thead> <tbody> <tr> <td style="text-align: center;">1212</td> <td style="text-align: center;">–</td> <td style="text-align: right;">12/12</td> </tr> <tr> <td style="text-align: center;">1616</td> <td style="text-align: center;">–</td> <td style="text-align: right;">16/16</td> </tr> <tr> <td style="text-align: center;">2020</td> <td style="text-align: center;">–</td> <td style="text-align: right;">20/20</td> </tr> <tr> <td style="text-align: center;">2525</td> <td style="text-align: center;">–</td> <td style="text-align: right;">25/25</td> </tr> </tbody> </table>			H/B [mm]/[mm]	1212	–	12/12	1616	–	16/16	2020	–	20/20	2525	–	25/25
A	steel shank with internal coolant																					
S	steel shank without internal coolant																					
		H/B [mm]/[mm]																				
1212	–	12/12																				
1616	–	16/16																				
2020	–	20/20																				
2525	–	25/25																				

5	6	7	8																
Holder total length – LF	Tool style – cutting edge angle	Version (right/left)	Cutting depth maximum – CDX																
<table border="1" style="width: 100%; border-collapse: collapse; margin-top: 10px;"> <thead> <tr> <th></th> <th style="text-align: right;">LF [mm]</th> </tr> </thead> <tbody> <tr> <td style="text-align: center;">H</td> <td style="text-align: right;">100</td> </tr> <tr> <td style="text-align: center;">K</td> <td style="text-align: right;">125</td> </tr> <tr> <td style="text-align: center;">M</td> <td style="text-align: right;">150</td> </tr> <tr> <td style="text-align: center;">P</td> <td style="text-align: right;">170</td> </tr> </tbody> </table>		LF [mm]	H	100	K	125	M	150	P	170	<table border="1" style="width: 100%; border-collapse: collapse; margin-top: 10px;"> <thead> <tr> <th></th> <th style="text-align: right;">[°]</th> </tr> </thead> <tbody> <tr> <td style="text-align: center;">G</td> <td style="text-align: right;">0</td> </tr> <tr> <td style="text-align: center;">F</td> <td style="text-align: right;">90</td> </tr> </tbody> </table>		[°]	G	0	F	90		
	LF [mm]																		
H	100																		
K	125																		
M	150																		
P	170																		
	[°]																		
G	0																		
F	90																		

9	10	11
Blade curvature direction	Maximum diameter	Minimum diameter
<p style="text-align: center; margin-top: 10px;">Additional information for axial turning.</p>		



PARTING – OFF & GROOVING BLADES (EXTERNAL TURNING) – GL – CODE DESIGNATION

1	2	-	3	4	5	6
GL	3		S	32	M	B



1	2	3
Tool group	Pocket size	Shank type

1, 2, 3, 4, 5, 6

GL

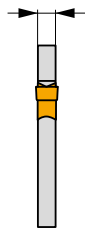

A	Steel shank with internal coolant
S	Steel shank without internal coolant

4	5	6
Shank dimensions	Blade total length – LF	Tool style



	H [mm]
26	26
32	32

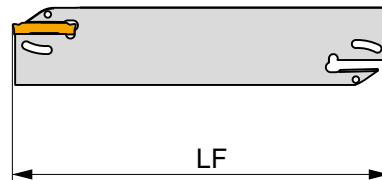

	LF [mm]	LF ["]
K	125	5.000"
M	150	6.000"

B – blade



ISO CODE DESIGNATION – INSERTS

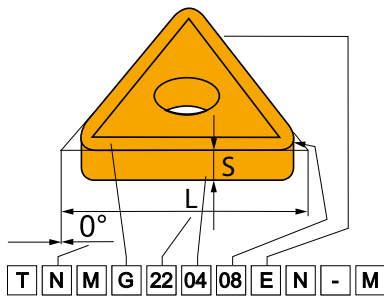

ISO	1	2	3	4
	T	N	U	N
ANSI	1	2	3	4
	T	N	U	G

1				2		4	
Insert shape				Insert clearance angle		Insert type	
H	O	P	R	A	B	N	
						R	
S	T	C	D	C	D	F	
						A	
E	M	V	W	E	F	M	
						G	
L	A	B	K	G	N	W	
						T	
				P	O	Q	
					Special	U	
						B	
						H	
						C	
						J	
						X	Special

3 Tolerances

	[mm]			["]		
	M (±)	S (±)	IC (±)	M (±)	S (±)	IC (±)
A	0.005	0.025	0.025	.0002"	.001"	.0010"
F	0.005	0.025	0.013	.0002"	.001"	.0005"
C	0.013	0.025	0.025	.0005"	.001"	.0010"
H	0.013	0.025	0.013	.0005"	.001"	.0005"
E	0.025	0.025	0.025	.0010"	.001"	.0010"
G	0.025	0.130	0.025	.0010"	.005"	.0010"
J	0.005	0.025	0.05 – 0.13	.0002"	.001"	.002 – 0.005"
K	0.013	0.025	0.05 – 0.13	.0005"	.001"	.002 – 0.005"
L	0.025	0.025	0.05 – 0.13	.0010"	.001"	.002 – 0.005"
M	0.08 – 0.18	0.130	0.05 – 0.13	.003 – 0.007"	.005"	.002 – 0.005"
N	0.08 – 0.18	0.025	0.05 – 0.13	.003 – 0.007"	.001"	.002 – 0.005"
U	0.05 – 0.38	0.130	0.05 – 0.13	.005 – 0.015"	.005"	.003 – 0.010"

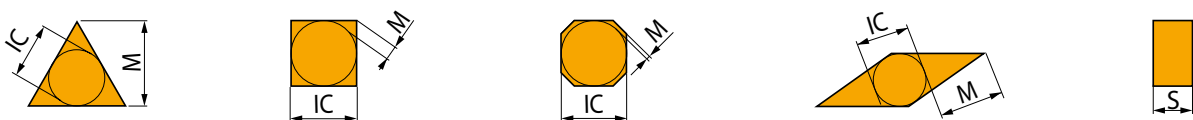

ISO CODE DESIGNATION – INSERTS

5	6	7	8	9	10
22	04	08			
22	04	08	E	N	-
5	6	7	8	9	10
4	3	2			
4	3	2	E	N	-
					M

5		5												
Insert cutting edge length (insert size)														
d = IC		H	O	P	S	T	C	D	E	M	V	W	R	K
[mm]	[in]													
3.97	5/32"				03	06		04			06	02		
4.76	3/16"				04	08	04	05	04	04	08	L3		
5.56	7/32"				05	09	05	06	05	05	09	03		
6.35	1/4"	03	02	04	08	11	06	07	08	08	11	04	06	
7.94	5/16"	04	03	05	07	13	08	09	06	07	13	05	07	
9.525	3/8"	05	04	07	09	16	09	11	09	09	16	06	09	16
12.7	1/2"	07	05	09	12	22	12	15	13	12	22	08	12	
15.875	5/8"	09	06	11	15	27	16	19	16	15	27	10	15	
19.05	3/4"	11	07	13	19	33	19	23	19	19	33	13	19	
25.40	1"	14	10	18	25	44	25	31	26	25	44	17	25	
31.75	1 1/4"	18	13	23	31	54	32	38	32	31	54	21	31	

6		7	
Insert thickness		Insert nose radius	
	s		
	[mm]		
	["]		
01	1.59	1/16"	
T1	1.98	5/64"	
02	2.38	3/32"	
03	3.18	1/8"	
T3	3.97	5/32"	
04	4.76	3/16"	
05	5.56	7/32"	
06	6.35	1/4"	
07	7.94	5/16"	
09	9.52	3/8"	

7		8	
Insert thickness		Insert nose radius	
	s		
	[mm]		
	["]		
01	1.59	1/16"	
T1	1.98	5/64"	
02	2.38	3/32"	
03	3.18	1/8"	
T3	3.97	5/32"	
04	4.76	3/16"	
05	5.56	7/32"	
06	6.35	1/4"	
07	7.94	5/16"	
09	9.52	3/8"	

ANSI					
5		6		7	
Inscribed circle		Insert thickness		Insert nose radius	
	d = I.C.		S		RE
	[mm]		[mm]		[mm]
	["]		["]		["]
1	3.175	1/8"	1.588	1/16"	0
1.2	3.969	5/32"	1.984	5/64"	0.099
1.5	4.763	3/16"	2.381	3/32"	0.198
1.8	5.556	7/32"	3.175	1/8"	0.397
2	6.350	1/4"	3.969	5/32"	0.794
2.5	7.938	5/16"	4.763	3/16"	1.191
3	9.525	3/8"	5.556	7/32"	1.588
4	12.700	1/2"	6.350	1/4"	1.984
5	15.875	5/8"	7.938	5/16"	2.381
6	19.050	3/4"	9.525	3/8"	2.778
7	22.225	7/8"	11.113	7/16"	3.175
8	25.400	1"	12.700	1/2"	3.572
10	31.750	5/4"	14.288	9/16"	3.969
12	38.100	6/4"	15.875	5/8"	4.366

8		8	
Insert cutting edge design			
	Sharp edges		Rounded edges
	Edges with facet		Rounded edges with facet
	Edges with double facet		Rounded edges with double facet

9		9	
Feed direction			
R		N	
L			

10		10	
Chip breaker designation			



PARTING – OFF & GROOVING TOOLS – EXTERNAL TURNING – ISO CODE DESIGNATION

ISO	1	2	3	4	5	6	7	8	9	10	11
ANSI	1	2	3	4	5 & 6	7	8	9	10	11	
G	F	I	L	25	25	M	0316	R	030	017	
G	F	I	L	16	D	0316	R	1.18	.670		



1	1	2	2	3	3	4	4
Clamping designation		Holder style – cutting edge angle		Cutting depth maximum – CDX		Version (right/left) R/L	

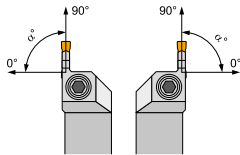
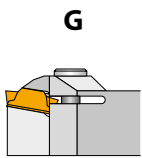

α°	
G = 0°	K = 75°
R = 15°	F = 90°
T = 30°	B = 105°
S = 45°	E = 120°
W = 60°	D = 135°



G = 2.0 × CW	N = 5.5 × CW
H = 2.5 × CW	O = 6.0 × CW
I = 3.0 × CW	P = 6.5 × CW
J = 3.5 × CW	Q = 7.0 × CW
K = 4.0 × CW	R = 7.5 × CW
L = 4.5 × CW	S = 8.0 × CW
M = 5.0 × CW	T = 8.5 × CW

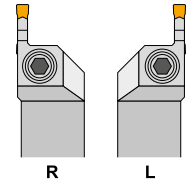

5	6	7	7	8	8		
Shank height [mm]		Shank width [mm]		Holder total length		Insert width	

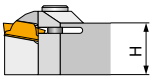

12 = 12 mm
16 = 16 mm
20 = 20 mm
etc.

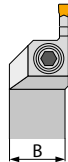

12 = 12 mm
16 = 16 mm
20 = 20 mm
etc.

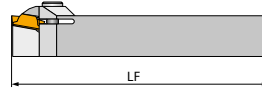

	LF [mm]		LF ["]
H	100	A	4.000"
J	110	B	4.500"
K	125	C	5.000"
L	140	D	6.000"
M	150	E	7.000"
N	160	F	8.000"
P	170		
Q	180		
R	200		

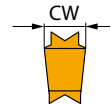

	CW [mm]	CW ["]
02	2.0	.079"
03, 0313, 0316	3.0	.118"
04, 0413, 0416	4.0	.157"
05, 0516	5.0	.197"
06, 0616	6.0	.236"
08, 0830	8.0	.315"

5 & 6		
	B ["]	H ["]
05	5/16"	5/16"
06	3/8"	3/8"
08	1/2"	1/2"
10	5/8"	5/8"
12	3/4"	3/4"
16	1"	1"
85	1"	1 1/4"
86	1"	1 1/2"
20	1 1/4"	1 1/4"
24	1 1/2"	1 1/2"
32	2"	2"

For square shanks, the number is the width or height in terms of 16ths. For rectangular shanks the first digit is the width in terms of 8ths and the second digit is the height in terms of 4ths.

10	10
Maximum diameter – face grooving	
Additional information for axial turning	

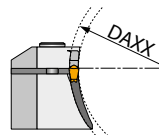

9	9
Blade curvature direction	
Additional information for axial turning	

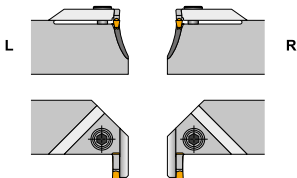

11	11
Minimum diameter – face grooving	
Additional information for axial turning	

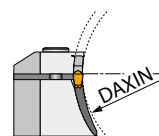



PARTING – OFF & GROOVING TOOLS – INTERNAL TURNING – ISO CODE DESIGNATION

ISO	1 A	2 25	3 S	-	4 G	5 G	6 H	7 L	8 0313
ANSI	1 A	2 16	3 S	-	4 G	5 G	6 H	7 L	8 0313

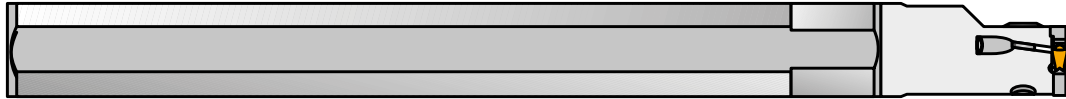

1	1	2	2	3	3		
Shank		Diameter of shank		Diameter of shank		Holder total length	
S	Steel shank						
		DCON MS [mm]		DCON MS ["]		LF [mm] LF ["]	
A	Steel shank with coolant hole	12	12	08	.500"		
		16	16	10	.625"		
		20	20	12	.750"		
		25	25	16	1.000"		
		32	32	20	1.250"		
		40	40	24	1.500"		

4	4	5	5	6	6																								
Clamping designation		Tool style – cutting edge angle		Cutting depth maximum – CDX																									
		<table border="1"> <tr> <td colspan="2">α°</td> </tr> <tr> <td>G = 0°</td> <td>K = 75°</td> </tr> <tr> <td>R = 15°</td> <td>F = 90°</td> </tr> <tr> <td>T = 30°</td> <td>B = 105°</td> </tr> <tr> <td>S = 45°</td> <td>E = 120°</td> </tr> <tr> <td>W = 60°</td> <td>D = 135°</td> </tr> </table>		α°		G = 0°	K = 75°	R = 15°	F = 90°	T = 30°	B = 105°	S = 45°	E = 120°	W = 60°	D = 135°	<table border="1"> <tr> <td>E = 1.0 × CW</td> <td>J = 3.5 × CW</td> </tr> <tr> <td>F = 1.5 × CW</td> <td>K = 4.0 × CW</td> </tr> <tr> <td>G = 2.0 × CW</td> <td>L = 4.5 × CW</td> </tr> <tr> <td>H = 2.5 × CW</td> <td>M = 5.0 × CW</td> </tr> <tr> <td>I = 3.0 × CW</td> <td>N = 5.5 × CW</td> </tr> <tr> <td colspan="2">X = Special</td> </tr> </table>		E = 1.0 × CW	J = 3.5 × CW	F = 1.5 × CW	K = 4.0 × CW	G = 2.0 × CW	L = 4.5 × CW	H = 2.5 × CW	M = 5.0 × CW	I = 3.0 × CW	N = 5.5 × CW	X = Special	
α°																													
G = 0°	K = 75°																												
R = 15°	F = 90°																												
T = 30°	B = 105°																												
S = 45°	E = 120°																												
W = 60°	D = 135°																												
E = 1.0 × CW	J = 3.5 × CW																												
F = 1.5 × CW	K = 4.0 × CW																												
G = 2.0 × CW	L = 4.5 × CW																												
H = 2.5 × CW	M = 5.0 × CW																												
I = 3.0 × CW	N = 5.5 × CW																												
X = Special																													

7	7	8	8						
Version (right/left) R/L		Insert width							
		<table border="1"> <tr> <td></td> <td>CW [mm]</td> </tr> <tr> <td>0313</td> <td>3.0</td> </tr> <tr> <td>0413</td> <td>4.0</td> </tr> </table>			CW [mm]	0313	3.0	0413	4.0
	CW [mm]								
0313	3.0								
0413	4.0								



GL. D - GM

	CW	CWTOLL	CWTOLU	INSL
	[mm]	[mm]	[mm]	[mm]
200	2.00	-0.05	0.05	25.0
300	3.00	-0.05	0.05	25.0
400	4.00	-0.05	0.05	25.0
500	5.00	-0.05	0.05	25.0
600	6.00	-0.05	0.05	25.0

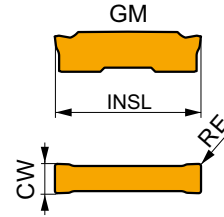

Workpiece material suitability and starting values for cutting speed (vc), feed (f) and depth of cut (ap).

Product	RE	P			M			K			N			S			H		
		vc	f	ap	vc	f	ap	vc	f	ap	vc	f	ap	vc	f	ap	vc	f	ap
	[mm]	[m/min]	[mm/rev]	[mm]	[m/min]	[mm/rev]	[mm]	[m/min]	[mm/rev]	[mm]	[m/min]	[mm/rev]	[mm]	[m/min]	[mm/rev]	[mm]	[m/min]	[mm/rev]	[mm]

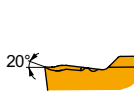

GM geometry for grooving and longitudinal turning, and continuous to interrupted cuts.

GL2-D200M02-GM	G8330	0.2	■	190	0.10	0.8	■	110	0.09	0.8	■	180	0.10	0.8	–	–	–	■	45	0.08	0.6	–	–	–
	T7325	0.2	■	220	0.10	0.8	■	170	0.09	0.8	–	–	–	–	–	–	–	■	70	0.08	0.6	–	–	–
GL3-D300M02-GM	G8330	0.2	■	150	0.20	1.0	■	90	0.18	1.0	■	140	0.20	1.0	–	–	–	■	35	0.14	0.8	–	–	–
	T7325	0.2	■	175	0.20	1.0	■	135	0.18	1.0	–	–	–	–	–	–	–	■	55	0.14	0.8	–	–	–
GL3-D300M04-GM	G8330	0.4	■	160	0.20	1.0	■	95	0.18	1.0	■	150	0.20	1.0	–	–	–	■	40	0.14	0.8	–	–	–
	T7325	0.4	■	185	0.20	1.0	■	140	0.18	1.0	–	–	–	–	–	–	–	■	60	0.14	0.8	–	–	–
GL4-D400M04-GM	G8330	0.4	■	150	0.25	1.2	■	90	0.23	1.2	■	140	0.25	1.2	–	–	–	■	35	0.18	1.0	–	–	–
	T7325	0.4	■	170	0.25	1.2	■	130	0.23	1.2	–	–	–	–	–	–	–	■	55	0.18	1.0	–	–	–
GL4-D400M08-GM	G8330	0.8	■	180	0.25	1.2	■	105	0.23	1.2	■	170	0.25	1.2	–	–	–	■	45	0.18	1.0	–	–	–
	T7325	0.8	■	200	0.25	1.2	■	155	0.23	1.2	–	–	–	–	–	–	–	■	65	0.18	1.0	–	–	–
GL5-D500M08-GM	G8330	0.8	■	170	0.30	1.2	■	100	0.27	1.2	■	160	0.30	1.2	–	–	–	■	40	0.21	1.0	–	–	–
	T7325	0.8	■	190	0.30	1.2	■	145	0.27	1.2	–	–	–	–	–	–	–	■	60	0.21	1.0	–	–	–
GL6-D600M08-GM	G8330	0.8	■	170	0.30	1.2	■	100	0.27	1.2	■	160	0.30	1.2	–	–	–	■	40	0.21	1.0	–	–	–
	T7325	0.8	■	190	0.30	1.2	■	145	0.27	1.2	–	–	–	–	–	–	–	■	60	0.21	1.0	–	–	–

GL. D - MM

	CW	CWTOLL	CWTOLU	INSL
	[mm]	[mm]	[mm]	[mm]
200	2.00	-0.05	0.05	25.0
300	3.00	-0.05	0.05	25.0
400	4.00	-0.05	0.05	25.0
500	5.00	-0.05	0.05	26.0
600	6.00	-0.05	0.05	26.0

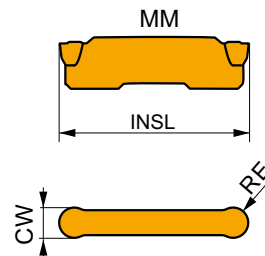

Workpiece material suitability and starting values for cutting speed (vc), feed (f) and depth of cut (ap).

Product	RE	P			M			K			N			S			H		
		vc	f	ap	vc	f	ap	vc	f	ap	vc	f	ap	vc	f	ap	vc	f	ap
	[mm]	[m/min]	[mm/rev]	[mm]	[m/min]	[mm/rev]	[mm]	[m/min]	[mm/rev]	[mm]	[m/min]	[mm/rev]	[mm]	[m/min]	[mm/rev]	[mm]	[m/min]	[mm/rev]	[mm]

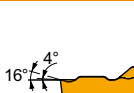

MM geometry, with full radius shape for copy profiling and longitudinal turning, and continuous to interrupted cuts.

GL2-D200MM0-MM	G8330	1.0	■	250	0.10	1.0	■	150	0.09	1.0	■	235	0.10	1.0	–	–	–	■	60	0.08	0.8	–	–	–
	T7325	1.0	■	285	0.10	1.0	■	220	0.09	1.0	–	–	–	–	–	–	–	■	90	0.08	0.8	–	–	–



Workpiece material suitability and starting values for cutting speed (vc), feed (f) and depth of cut (ap).

Product	RE [mm]	P			M			K			N			S			H		
		vc [m/min]	f [mm/rev]	ap [mm]	vc [m/min]	f [mm/rev]	ap [mm]	vc [m/min]	f [mm/rev]	ap [mm]	vc [m/min]	f [mm/rev]	ap [mm]	vc [m/min]	f [mm/rev]	ap [mm]	vc [m/min]	f [mm/rev]	ap [mm]

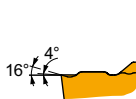

MM geometry, with full radius shape for copy profiling and longitudinal turning, and continuous to interrupted cuts.

GL3-D300MM0-MM	G8330	1.5	210	0.20	1.2	125	0.18	1.2	195	0.20	1.2	-	-	-	50	0.14	1.0	-	-	-
	T7325	1.5	240	0.20	1.2	185	0.18	1.2	-	-	-	-	-	-	75	0.14	1.0	-	-	-
GL4-D400MM0-MM	G8330	2.0	220	0.20	1.2	130	0.18	1.2	205	0.20	1.2	-	-	-	55	0.14	1.0	-	-	-
	T7325	2.0	250	0.20	1.2	195	0.18	1.2	-	-	-	-	-	-	80	0.14	1.0	-	-	-
GL5-D500MM0-MM	G8330	2.5	205	0.25	1.2	120	0.23	1.2	190	0.25	1.2	-	-	-	50	0.18	1.0	-	-	-
	T7325	2.5	235	0.25	1.2	180	0.23	1.2	-	-	-	-	-	-	75	0.18	1.0	-	-	-
GL6-D600MM0-MM	G8330	3.0	195	0.30	1.2	115	0.27	1.2	185	0.30	1.2	-	-	-	45	0.21	1.0	-	-	-
	T7325	3.0	220	0.30	1.2	170	0.27	1.2	-	-	-	-	-	-	70	0.21	1.0	-	-	-

GL. D - PM



	CW [mm]	CWTOLL [mm]	CWTOLU [mm]	INSL [mm]
200	2.00	-0.05	0.05	25.0
250	2.55	-0.05	0.05	25.0
300	3.00	-0.05	0.05	25.0
400	4.00	-0.05	0.05	25.0
500	5.00	-0.05	0.05	25.0
600	6.00	-0.05	0.05	25.0

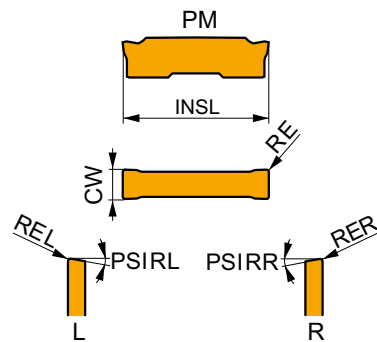

Suitability and starting values for cutting speed (vc) and feed (f). Refer to our Machining Calculator app for further calculations.

Product	RE [mm]	P		M		K		N		S		H		PSIRR [°]	PSIRL [°]
		vc [m/min]	f [mm/rev]	vc [m/min]	f [mm/rev]	vc [m/min]	f [mm/rev]	vc [m/min]	f [mm/rev]	vc [m/min]	f [mm/rev]	vc [m/min]	f [mm/rev]		

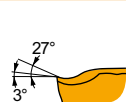

PM geometry, first choice for parting-off and grooving, and continuous to slightly interrupted cuts.

GL2-D200M02-PM	G8330	0.2	130	0.08	75	0.07	120	0.08	-	-	30	0.06	-	-	-
	T7325	0.2	150	0.08	115	0.07	-	-	-	-	45	0.06	-	-	-
GL3-D250G02-PM	G8330	0.2	130	0.10	75	0.09	120	0.10	-	-	30	0.07	-	-	-
	G8330	0.2	130	0.10	75	0.09	120	0.10	-	-	30	0.07	-	-	-
GL3-D300M02-PM	G8330	0.2	130	0.10	75	0.09	120	0.10	-	-	30	0.07	-	-	-
	T7325	0.2	150	0.10	115	0.09	-	-	-	-	45	0.07	-	-	-
GL4-D400M02-PM	G8330	0.2	130	0.12	75	0.11	120	0.12	-	-	30	0.10	-	-	-
	T7325	0.2	150	0.12	115	0.11	-	-	-	-	45	0.10	-	-	-
GL5-D500M03-PM	G8330	0.3	130	0.15	75	0.14	120	0.15	-	-	30	0.12	-	-	-
GL6-D600M03-PM	G8330	0.3	130	0.15	75	0.14	120	0.15	-	-	30	0.12	-	-	-



R-PM right-handed geometry, first choice for parting-off, and continuous to slightly interrupted cuts.

GL2-D200G02R06-PM	G8330	0.2	130	0.08	75	0.07	120	0.08	-	-	30	0.06	-	-	6
	T7325	0.2	150	0.08	115	0.07	-	-	-	-	45	0.06	-	-	6
GL2-D200G02R12-PM	G8330	0.2	130	0.08	75	0.07	120	0.08	-	-	30	0.06	-	-	12
	G8330	0.2	130	0.10	75	0.09	120	0.10	-	-	30	0.07	-	-	6
GL3-D300G02R06-PM	G8330	0.2	130	0.10	75	0.09	120	0.10	-	-	30	0.07	-	-	6
	T7325	0.2	150	0.10	115	0.09	-	-	-	-	45	0.07	-	-	6
GL3-D300G02R12-PM	G8330	0.2	130	0.10	75	0.09	120	0.10	-	-	30	0.07	-	-	12
	G8330	0.2	130	0.10	75	0.09	120	0.10	-	-	30	0.07	-	-	12
GL4-D400G02R06-PM	G8330	0.2	130	0.12	75	0.11	120	0.12	-	-	30	0.10	-	-	6
	T7325	0.2	150	0.12	115	0.11	-	-	-	-	45	0.10	-	-	6
GL4-D400G02R12-PM	G8330	0.2	130	0.12	75	0.11	120	0.12	-	-	30	0.10	-	-	12
	G8330	0.2	130	0.12	75	0.11	120	0.12	-	-	30	0.10	-	-	12



Suitability and starting values for cutting speed (vc) and feed (f). Refer to our Machining Calculator app for further calculations.

Product	RE [mm]	P		M		K		N		S		H		PSIRR [°]	PSIRL [°]
		vc [m/min]	f [mm/rev]	vc [m/min]	f [mm/rev]	vc [m/min]	f [mm/rev]	vc [m/min]	f [mm/rev]	vc [m/min]	f [mm/rev]	vc [m/min]	f [mm/rev]		

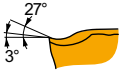

L-PM left-handed geometry, first choice for parting-off and continuous to slightly interrupted cuts.

GL2-D200G02L06-PM	G8330	0.2	■	130	0.08	■	75	0.07	▣	120	0.08	—	—	▣	30	0.06	—	—	—	6
	T7325	0.2	▣	150	0.08	■	115	0.07	—	—	—	—	—	▣	45	0.06	—	—	—	6
GL2-D200G02L12-PM	G8330	0.2	■	130	0.08	■	75	0.07	▣	120	0.08	—	—	▣	30	0.06	—	—	—	12
	G8330	0.2	■	130	0.10	■	75	0.09	▣	120	0.10	—	—	▣	30	0.07	—	—	—	6
GL3-D300G02L06-PM	T7325	0.2	▣	150	0.10	■	115	0.09	—	—	—	—	—	▣	45	0.07	—	—	—	6
	G8330	0.2	■	130	0.10	■	75	0.09	▣	120	0.10	—	—	▣	30	0.07	—	—	—	12
GL3-D300G02L12-PM	G8330	0.2	■	130	0.12	■	75	0.11	▣	120	0.12	—	—	▣	30	0.10	—	—	—	6
GL4-D400G02L06-PM	T7325	0.2	▣	150	0.12	■	115	0.11	—	—	—	—	—	▣	45	0.10	—	—	—	6
	G8330	0.2	■	130	0.12	■	75	0.11	▣	120	0.12	—	—	▣	30	0.10	—	—	—	12

GL. D - PR



	CW [mm]	CWTOLL [mm]	CWTOLU [mm]	INSL [mm]
200	2.00	-0.05	0.05	25.0
300	3.00	-0.05	0.05	25.0
400	4.00	-0.05	0.05	25.0
500	5.00	-0.05	0.05	25.0
600	6.00	-0.05	0.05	25.0

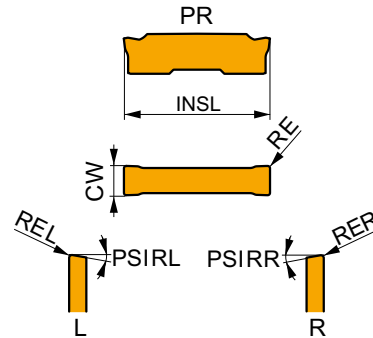

Suitability and starting values for cutting speed (vc) and feed (f). Refer to our Machining Calculator app for further calculations.

Product	RE [mm]	P		M		K		N		S		H		PSIRR [°]	PSIRL [°]
		vc [m/min]	f [mm/rev]	vc [m/min]	f [mm/rev]	vc [m/min]	f [mm/rev]	vc [m/min]	f [mm/rev]	vc [m/min]	f [mm/rev]	vc [m/min]	f [mm/rev]		

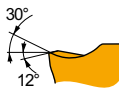

PR geometry, first choice for parting-off and grooving, and continuous to interrupted cuts.

GL2-D200M02-PR	G8330	0.2	■	130	0.10	▣	75	0.09	■	120	0.10	—	—	—	—	—	—	—	—	—
	T7325	0.2	▣	150	0.10	▣	115	0.09	—	—	—	—	—	—	—	—	—	—	—	—
GL3-D300M02-PR	G8330	0.2	■	130	0.12	▣	75	0.11	■	120	0.12	—	—	—	—	—	—	—	—	—
	T7325	0.2	▣	150	0.12	▣	115	0.11	—	—	—	—	—	—	—	—	—	—	—	—
GL4-D400M02-PR	G8330	0.2	■	130	0.15	▣	75	0.14	■	120	0.15	—	—	—	—	—	—	—	—	—
	T7325	0.2	▣	150	0.15	▣	115	0.14	—	—	—	—	—	—	—	—	—	—	—	—
GL5-D500M04-PR	G8330	0.4	■	130	0.18	▣	75	0.16	■	120	0.18	—	—	—	—	—	—	—	—	—
GL6-D600M04-PR	G8330	0.4	■	130	0.18	▣	75	0.16	■	120	0.18	—	—	—	—	—	—	—	—	—

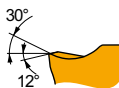

R-PR right-handed geometry, first choice for parting-off, and continuous to interrupted cuts.

GL2-D200G02R06-PR	G8330	0.2	■	130	0.10	▣	75	0.09	■	120	0.10	—	—	—	—	—	—	—	6	—
GL2-D200G02R12-PR	G8330	0.2	■	130	0.10	▣	75	0.09	■	120	0.10	—	—	—	—	—	—	—	12	—
GL3-D300G02R06-PR	G8330	0.2	■	130	0.12	▣	75	0.11	■	120	0.12	—	—	—	—	—	—	—	6	—
GL3-D300G02R12-PR	G8330	0.2	■	130	0.12	▣	75	0.11	■	120	0.12	—	—	—	—	—	—	—	12	—
GL4-D400G02R06-PR	G8330	0.2	■	130	0.15	▣	75	0.14	■	120	0.15	—	—	—	—	—	—	—	6	—
GL4-D400G02R12-PR	G8330	0.2	■	130	0.15	▣	75	0.14	■	120	0.15	—	—	—	—	—	—	—	12	—



Suitability and starting values for cutting speed (vc) and feed (f). Refer to our Machining Calculator app for further calculations.

Product		RE [mm]	P		M		K		N		S		H		PSIRR [°]	PSIRL [°]
			vc	f	vc	f	vc	f	vc	f	vc	f	vc	f		
			[m/min]	[mm/rev]	[m/min]	[mm/rev]	[m/min]	[mm/rev]	[m/min]	[mm/rev]	[m/min]	[mm/rev]	[m/min]	[mm/rev]		

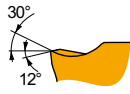

L-PR left-handed geometry, first choice for parting-off, and continuous to interrupted cuts.

GL2-D200G02L06-PR	G8330	0.2	■	130	0.10	▣	75	0.09	■	120	0.10	—	—	—	—	—	6
GL2-D200G02L12-PR	G8330	0.2	■	130	0.10	▣	75	0.09	■	120	0.10	—	—	—	—	—	12
GL3-D300G02L06-PR	G8330	0.2	■	130	0.12	▣	75	0.11	■	120	0.12	—	—	—	—	—	6
GL3-D300G02L12-PR	G8330	0.2	■	130	0.12	▣	75	0.11	■	120	0.12	—	—	—	—	—	12
GL4-D400G02L06-PR	G8330	0.2	■	130	0.15	▣	75	0.14	■	120	0.15	—	—	—	—	—	6
GL4-D400G02L12-PR	G8330	0.2	■	130	0.15	▣	75	0.14	■	120	0.15	—	—	—	—	—	12



GLSF(RL) EXT



PRAMET

G



External V-Groove Top Clamp Grooving and Parting-Off tool for GL Inserts

External Right/Left hand radial tool holder for grooving with double-sided GL 2, 3, 4, 5, or 6 style inserts. Suited for radial grooving and parting-off applications, up to 32 mm maximum depth of cut. Available with shank size 20x20 or 25x25 mm. Reinforced body design for longer tool life and low vibrations.

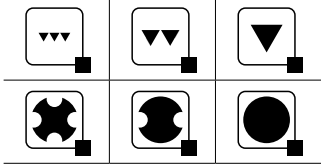
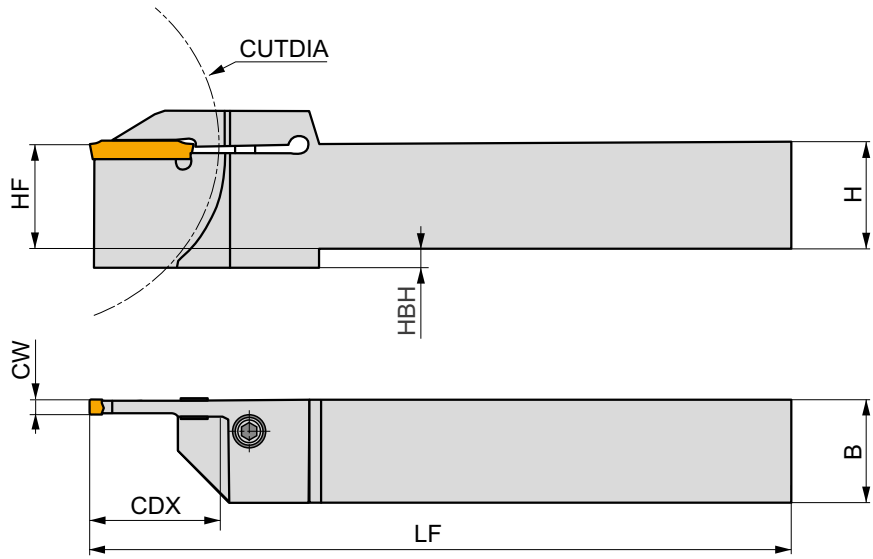
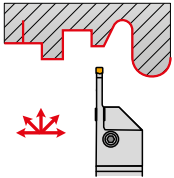

Product	HF	HBH	H	B	LF	CW	CDX	CUTDIA	kg	G334	GL11
	[mm]	[mm]	[mm]	[mm]	[mm]	[mm]	[mm]	[mm]			
R GL2-S2020KFR-20-80	20	-	20	20	125	2.00	20	80	0.38	G1334	GL11
GL2-S2020KFR-24-80	20	5	20	20	125	2.00	24	80	0.36	G1334	GL11
GL2-S2525MFR-20-80	25	-	25	25	150	2.00	20	80	0.68	G1334	GL11
GL2-S2525MFR-24-80	25	-	25	25	150	2.00	24	80	0.64	G1334	GL11
GL3-S2020KFR-20-80	20	-	20	20	125	3.00	20	80	0.38	G1335	GL11
GL3-S2020KFR-24-80	20	5	20	20	125	3.00	24	80	0.36	G1335	GL11
GL3-S2525MFR-20-80	25	-	25	25	150	3.00	20	80	0.68	G1335	GL11
GL3-S2525MFR-24-80	25	-	25	25	150	3.00	24	80	0.65	G1335	GL11
GL3-S2525PFR-32-80	25	5	25	25	170	3.00	32	80	0.72	G1335	GL11
R GL4-S2020KFR-20-80	20	-	20	20	125	4.00	20	80	0.38	G1336	GL11
GL4-S2020KFR-24-80	20	5	20	20	125	4.00	24	80	0.37	G1336	GL11
GL4-S2525MFR-20-80	25	-	25	25	150	4.00	20	80	0.68	G1336	GL11
GL4-S2525MFR-24-80	25	-	25	25	150	4.00	24	80	0.65	G1336	GL11
GL4-S2525PFR-32-80	25	5	25	25	170	4.00	32	80	0.78	G1336	GL11
GL5-S2020KFR-20-80	20	-	20	20	125	5.00	20	80	0.38	G1337	GL11
GL5-S2525MFR-20-80	25	-	25	25	150	5.00	20	80	0.68	G1337	GL11
GL5-S2525PFR-32-100	25	5	25	25	170	5.00	32	100	0.75	G1337	GL11
GL6-S2020KFR-20-80	20	-	20	20	125	6.00	20	80	0.39	G1338	GL11
GL6-S2525MFR-20-80	25	-	25	25	150	6.00	20	80	0.68	G1338	GL11
GL6-S2525PFR-32-100	25	5	25	25	170	6.00	32	100	0.75	G1338	GL11
L GL2-S2020KFL-20-80	20	-	20	20	125	2.00	20	80	0.38	G1334	GL11
GL2-S2020KFL-24-80	20	5	20	20	125	2.00	24	80	0.36	G1334	GL11
GL2-S2525MFL-20-80	25	-	25	25	150	2.00	20	80	0.70	G1334	GL11
GL2-S2525MFL-24-80	25	-	25	25	150	2.00	24	80	0.64	G1334	GL11
GL3-S2020KFL-20-80	20	-	20	20	125	3.00	20	80	0.38	G1335	GL11
GL3-S2020KFL-24-80	20	5	20	20	125	3.00	24	80	0.36	G1335	GL11
GL3-S2525MFL-20-80	25	-	25	25	150	3.00	20	80	0.68	G1335	GL11



Product	HF	HBH	H	B	LF	CW	CDX	CUTDIA			
	[mm]	[mm]	[mm]	[mm]	[mm]	[mm]	[mm]	[mm]			
GL3-S2525MFL-24-80	25	–	25	25	150	3.00	24	80	0.65	GI335	GL11
GL3-S2525PFL-32-80	25	5	25	25	170	3.00	32	80	0.78	GI335	GL11
GL4-S2020KFL-20-80	20	–	20	20	125	4.00	20	80	0.38	GI336	GL11
GL4-S2020KFL-24-80	20	5	20	20	125	4.00	24	80	0.37	GI336	GL11
GL4-S2525MFL-20-80	25	–	25	25	150	4.00	20	80	0.68	GI336	GL11
GL4-S2525MFL-24-80	25	–	25	25	150	4.00	24	80	0.65	GI336	GL11
GL4-S2525PFL-32-80	25	5	25	25	170	4.00	32	80	0.72	GI336	GL11
GL5-S2020KFL-20-80	20	–	20	20	125	5.00	20	80	0.38	GI337	GL11
GL5-S2525MFL-20-80	25	–	25	25	150	5.00	20	80	0.71	GI337	GL11
GL5-S2525PFL-32-100	25	5	25	25	170	5.00	32	100	0.75	GI337	GL11
GL6-S2020KFL-20-80	20	–	20	20	125	6.00	20	80	0.39	GI338	GL11
GL6-S2525MFL-20-80	25	–	25	25	150	6.00	20	80	0.71	GI338	GL11
GL6-S2525PFL-32-100	25	5	25	25	170	6.00	32	100	0.75	GI338	GL11

L

GI334	GL2..
GI335	GL3..
GI336	GL4..
GI337	GL5..
GI338	GL6..

GL11	US 5018-T20P	5.0	M 5	18.2	LK T20P

Cutting depths on machined diameter on page xxx.



GLSF(RL) EXT-G

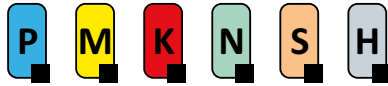

PRAMET

G



External V-Groove Top Clamp Grooving and Turning tool for GL Inserts

External Right/Left hand radial tool holder for grooving with double-sided GL 2, 3, 4, 5, or 6 style inserts. Suited for radial grooving, longitudinal turning and profiling applications, up to 12 mm maximum depth of cut. Available with shank size 20x20 or 25x25 mm. Body treated for longer tool life.

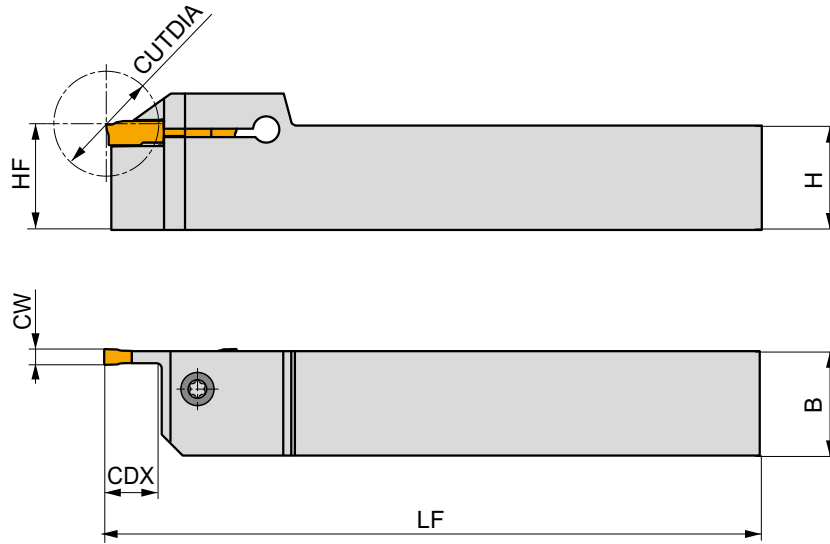
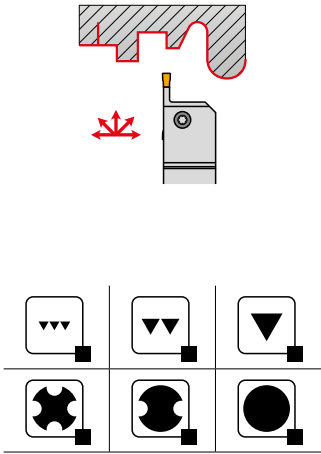

Product	≡	H	B	LF	CW	CDX	CUTDIA	kg				
	[mm]	[mm]	[mm]	[mm]	[mm]	[mm]	[mm]					
R	GL2-S2020KFR-10	20	20	20	125	2.00	10	20	0.38	G1334	GL11	
	GL2-S2525MFR-10	25	25	25	150	2.00	10	20	0.69	G1334	GL11	
	GL3-S2020KFR-10	20	20	20	125	3.00	10	20	0.36	G1335	GL11	
	GL3-S2525MFR-10	25	25	25	150	3.00	10	20	0.69	G1335	GL11	
	GL4-S2020KFR-12	20	20	20	125	4.00	12	24	0.37	G1336	GL11	
	GL4-S2525MFR-12	25	25	25	150	4.00	12	24	0.69	G1336	GL11	
	GL5-S2020KFR-12	20	20	20	125	5.00	12	24	0.36	G1337	GL11	
	GL5-S2525MFR-12	25	25	25	150	5.00	12	24	0.70	G1337	GL11	
	GL6-S2020KFR-12	20	20	20	125	6.00	12	24	0.36	G1338	GL11	
	GL6-S2525MFR-12	25	25	25	150	6.00	12	24	0.68	G1338	GL11	
	L	GL2-S2020KFL-10	20	20	20	125	2.00	10	20	0.37	G1334	GL11
		GL2-S2525MFL-10	25	25	25	150	2.00	10	20	0.70	G1334	GL11
GL3-S2020KFL-10		20	20	20	125	3.00	10	20	0.36	G1335	GL11	
GL3-S2525MFL-10		25	25	25	150	3.00	10	20	0.70	G1335	GL11	
GL4-S2020KFL-12		20	20	20	125	4.00	12	24	0.37	G1336	GL11	
GL4-S2525MFL-12		25	25	25	150	4.00	12	24	0.69	G1336	GL11	
GL5-S2020KFL-12		20	20	20	125	5.00	12	24	0.36	G1337	GL11	
GL5-S2525MFL-12		25	25	25	150	5.00	12	24	0.69	G1337	GL11	
GL6-S2020KFL-12		20	20	20	125	6.00	12	24	0.36	G1338	GL11	
GL6-S2525MFL-12		25	25	25	150	6.00	12	24	0.68	G1338	GL11	

G1334	G1335	G1336	G1337	G1338	GL2..
					GL3..
					GL4..
					GL5..
					GL6..

GL11	US 5018-T20P	5.0	M 5	18.2	LKT20P



GLSF(RL) EXT-S

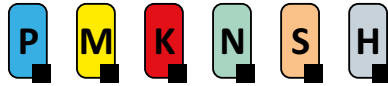

PRAMET

G



External Grooving and Parting-Off tool, GL Inserts for Sliding head machines

External Right/Left hand radial tool holder for sliding head machines GL 2, 3, 4 pocket widths. For radial grooving, profiling and parting-off applications up to 16 mm maximum depth of cut. Available with shank size 12x12 or 16x16 mm. Reinforced body design for longer tool life and low vibrations, easy access clamping.

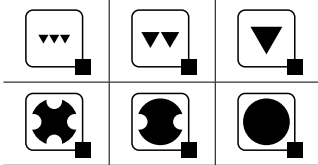
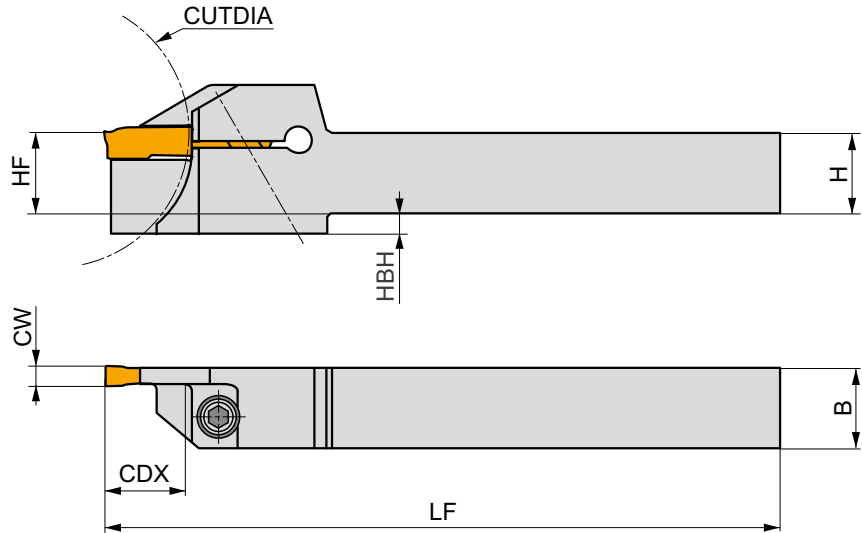
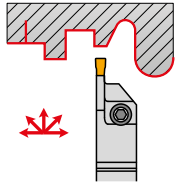

Product	HF	HBH	H	B	LF	CW	CDX	CUTDIA	kg	GL	GL	
	[mm]	[mm]	[mm]	[mm]	[mm]	[mm]	[mm]	[mm]				
R	GL2-S1212HFR-12-40	12	3	12	12	100	2.00	12	40	0.11	GI334	GL13
	GL2-S1616KFR-16-45	16	3	16	16	125	2.00	16	45	0.23	GI334	GL12
	GL3-S1212HFR-12-40	12	3	12	12	100	3.00	12	40	0.11	GI335	GL13
	GL3-S1616KFR-16-45	16	3	16	16	125	3.00	16	45	0.23	GI335	GL12
	GL4-S1616KFR-16-45	16	4	16	16	125	4.00	16	45	0.26	GI336	GL12
L	GL2-S1212HFL-12-40	12	3	12	12	100	2.00	12	40	0.11	GI334	GL13
	GL2-S1616KFL-16-45	16	3	16	16	125	2.00	16	45	0.23	GI334	GL12
	GL3-S1212HFL-12-40	12	3	12	12	100	3.00	12	40	0.11	GI335	GL13
	GL3-S1616KFL-16-45	16	3	16	16	125	3.00	16	45	0.23	GI335	GL12
	GL4-S1616KFL-16-45	16	4	16	16	125	4.00	16	45	0.24	GI336	GL12

GL	HS	Nm	M	mm	HXX
GI334			GL2..		
GI335			GL3..		
GI336			GL4..		

GL	HS	Nm	M	mm	HXX
GL12	HS 0516	5.0	M 5	16	HXX 4
GL13	HS 0412	5.0	M 4	12	HXX 3

Cutting depths on machined diameter on page xxx.



GLS B

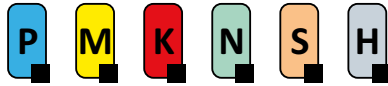

PRAMET



Double-Ended Parting-off Blade for GL Inserts

Blade for parting-off applications up to 60 mm maximum depth or Ø120 mm bar material. Suited for double-sided inserts GL family. Available in height of 26 and 32 mm. Can be fitted into the DU Pramet basic holders. Blade treated for longer tool life.

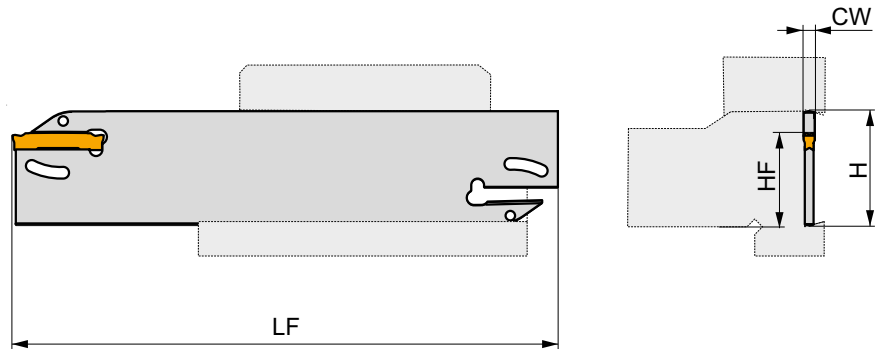
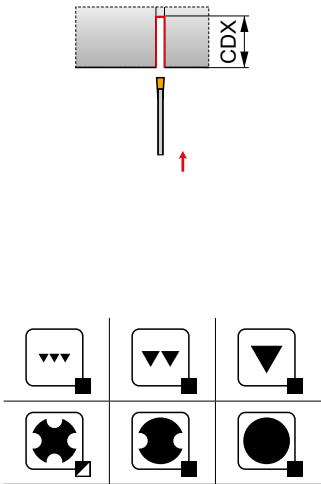

Product	≡ [mm]	H [mm]	LF [mm]	CW [mm]	CDX [mm]	kg		
GL2-S26KB	21.4	26	125	2.00	35	0.13	GI334	KV2
GL2-S32MB	25	32	150	2.00	50	0.15	GI334	KV2
GL3-S26KB	21.4	26	125	3.00	35	0.15	GI335	KV2
GL3-S32MB	25	32	150	3.00	50	0.16	GI335	KV2
GL4-S32MB	25	32	150	4.00	50	0.16	GI336	KV2
GL5-S32MB	25	32	150	5.00	60	0.16	GI337	KV2
GL6-S32MB	25	32	150	6.00	60	0.16	GI338	KV2

GI334	GL2..
GI335	GL3..
GI336	GL4..
GI337	GL5..
GI338	GL6..

KV2	KV 15x150



DU, D



Tool Holder Block for Parting-off Blades

Tool holder to fit GL or XLC. blades for parting-off. Available with shank size 20x20 up to 40x40 mm. Body treated for longer tool life.

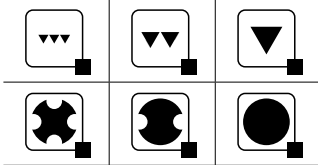
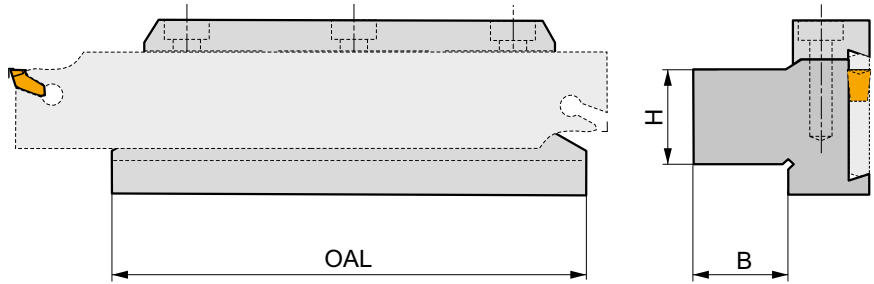
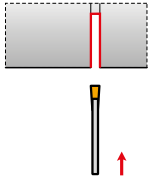

Product	H [mm]	B [mm]	LB [mm]	kg		
26-DU 2020	20	20	90	0.70	GI007	ND2
26-D 2020	20	20	100	0.82	GI007	ND2
32-DU 2523	25	23	110	1.02	GI008	ND2
32-DU 2532	25	32	110	1.10	GI008	ND2
32-DU 3229	32	29	110	1.25	GI008	ND2
32-D 2530	25	30	115	1.30	GI008	ND2
45-DU 3229	32	29	110	1.50	GI009	ND7
45-DU 4036	40	36	110	2.05	GI009	ND7
47-D 4040	40	40	150	3.88	GI091	ND3

GI007	XLC.N 26..	GL.-S26.B
GI008	XLC.N 32..	GL.-S32.B
GI009	XLC.N 45..	-
GI091	XLC.N 47..	-

ND2	HS 0625	6.0	M 6	25	HXK 5
ND3	HS 1030	8.0	M 10	30	HXK 8
ND7	HS 0630	6.0	M 6	30	HXK 5



CUTTING DEPTHS DEPENDING ON MACHINED DIAMETER

GLSF (RL) EXT

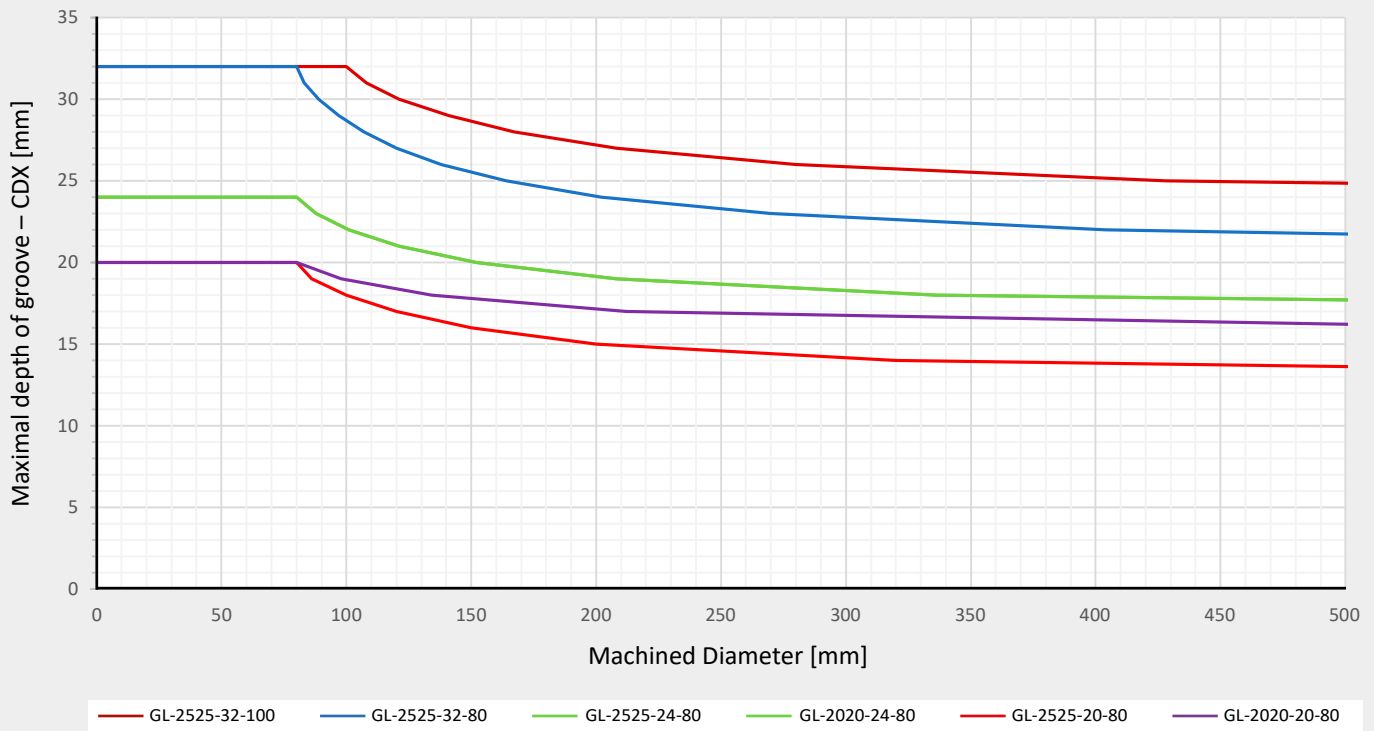

GLSF (RL) EXT-S

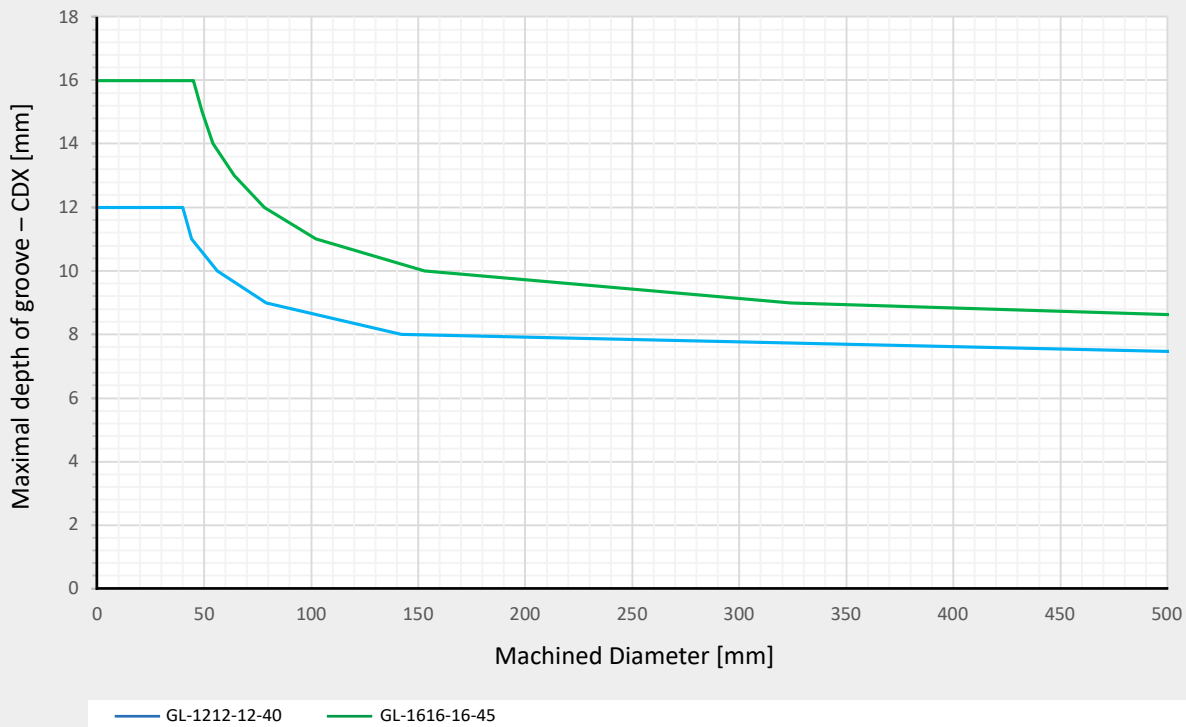



CUTTING DEPTHS DEPENDING ON MACHINED DIAMETER

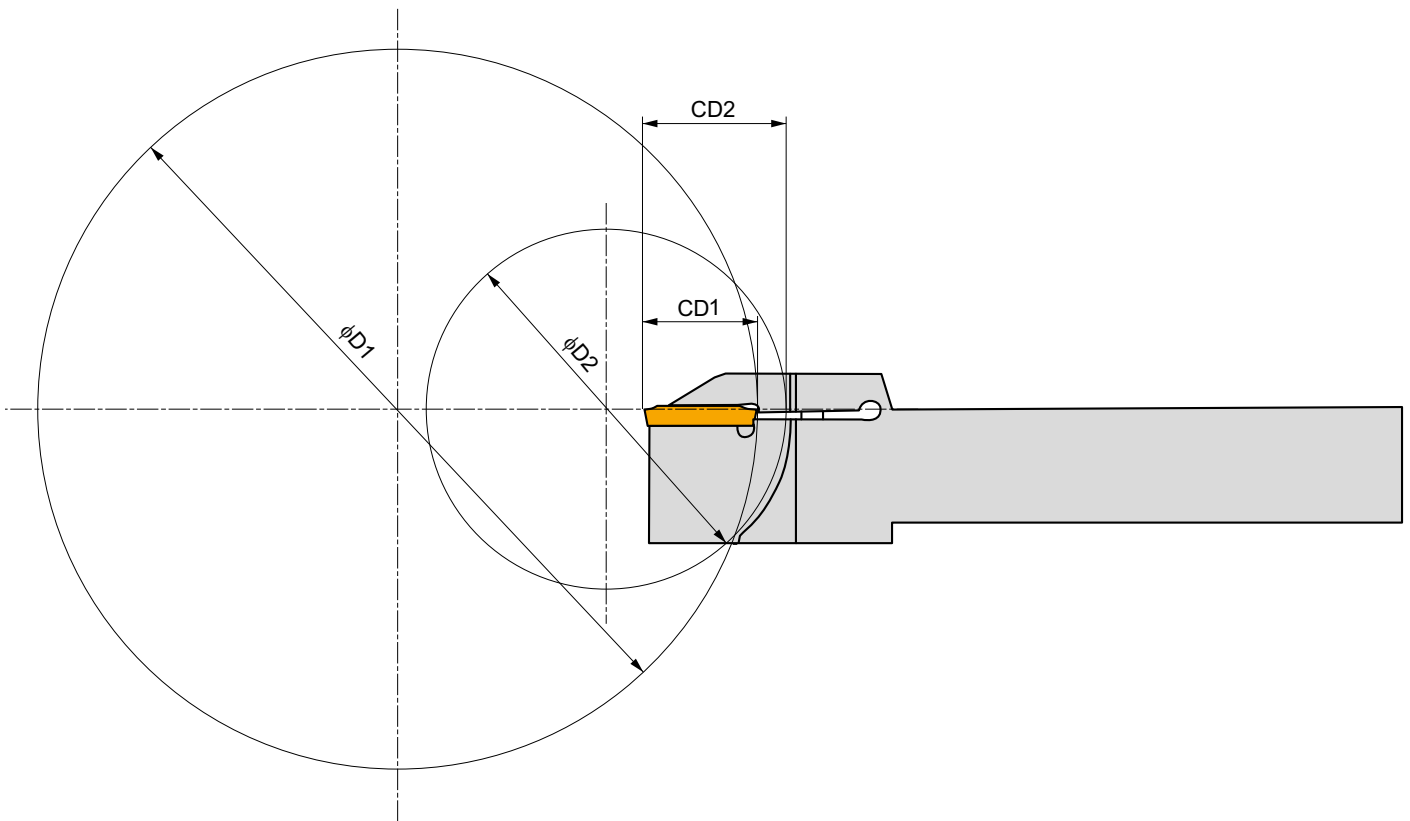



LCMF 13 - CM

	CW	CWTOLL	CWTOLU	INSL
	[mm]	[mm]	[mm]	[mm]
0313	3.00	-0.05	0.05	12.6
0413	4.00	-0.05	0.05	12.6

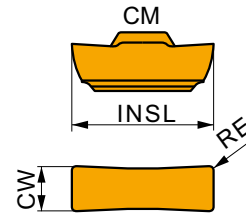

Suitability and starting values for cutting speed (vc) and feed (f). Refer to our Machining Calculator app for further calculations.

Product	RE	P		M		K		N		S		H		PSIRR	PSIRL
		vc	f	vc	f	vc	f	vc	f	vc	f	[°]	[°]		
	[mm]	[m/min]	[mm/rev]	[m/min]	[mm/rev]	[m/min]	[mm/rev]	[m/min]	[mm/rev]	[m/min]	[mm/rev]	[m/min]	[mm/rev]		

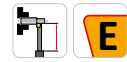
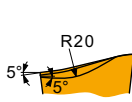

CM geometry and first choice for grooving.

LCMF 031304-CM	T8330	0.4	130	0.11	75	0.10	120	0.11	-	-	-	-	-	-	-
LCMF 031304-CM-04	T8330 ¹⁾	0.4	130	0.11	75	0.10	120	0.11	-	-	-	-	-	-	-
LCMF 041304-CM	T8330	0.4	130	0.11	75	0.10	120	0.11	-	-	-	-	-	-	-

¹⁾ Insert for internal holder A16Q-GGERIL0313-04, A20R-GGFRIL0313-04.

LCMF 13 - F

	CW	CWTOLL	CWTOLU	INSL
	[mm]	[mm]	[mm]	[mm]
0313	3.00	-0.05	0.05	12.6
0413	4.00	-0.05	0.05	12.6

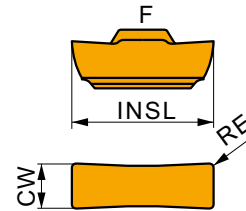

Suitability and starting values for cutting speed (vc), feed (f) and depth of cut (ap). Refer to our Machining Calculator app for further calculations.

Product	RE	P			M			K			N			S			H		
		vc	f	ap	vc	f	ap	vc	f	ap	vc	f	ap	vc	f	ap	vc	f	ap
	[mm]	[m/min]	[mm/rev]	[mm]	[m/min]	[mm/rev]	[mm]	[m/min]	[mm/rev]	[mm]	[m/min]	[mm/rev]	[mm]	[m/min]	[mm/rev]	[mm]	[m/min]	[mm/rev]	[mm]

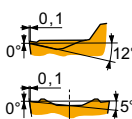

F geometry and first choice for turning.

LCMF 031302-F	T8330	0.2	195	0.10	0.3	115	0.09	0.3	185	0.10	0.3	-	-	-	-	-	-	-	-
LCMF 031302-F-04	T8330 ¹⁾	0.2	195	0.10	0.3	115	0.09	0.3	185	0.10	0.3	-	-	-	-	-	-	-	-
LCMF 031304-F	T8330	0.4	185	0.13	0.5	110	0.12	0.5	175	0.13	0.5	-	-	-	-	-	-	-	-
LCMF 031304-F-04	T8330 ¹⁾	0.4	185	0.13	0.5	110	0.12	0.5	175	0.13	0.5	-	-	-	-	-	-	-	-
LCMF 041304-F	T8330	0.4	185	0.13	0.5	110	0.12	0.5	175	0.13	0.5	-	-	-	-	-	-	-	-
	T9325	0.4	275	0.13	0.5	165	0.12	0.5	260	0.13	0.5	-	-	-	-	-	-	-	-

¹⁾ Insert for internal holder A16Q-GGERIL0313-04, A20R-GGFRIL0313-04.



LCMF 13 - MP

	CW	CWTOLL	CWTOLU	INSL
	[mm]	[mm]	[mm]	[mm]
0313	3.00	-0.05	0.05	12.6
0413	4.00	-0.05	0.05	12.6

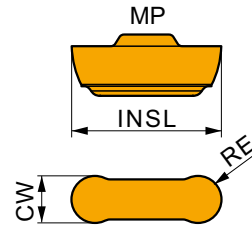

Suitability and starting values for cutting speed (vc), feed (f) and depth of cut (ap). Refer to our Machining Calculator app for further calculations.

Product	RE	P			M			K			N			S			H		
		vc	f	ap	vc	f	ap	vc	f	ap	vc	f	ap	vc	f	ap	vc	f	ap
	[mm]	[m/min]	[mm/rev]	[mm]	[m/min]	[mm/rev]	[mm]	[m/min]	[mm/rev]	[mm]	[m/min]	[mm/rev]	[mm]	[m/min]	[mm/rev]	[mm]	[m/min]	[mm/rev]	[mm]

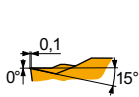

MP geometry for longitudinal turning and copy profiling, fine and finish machining, and continuous to interrupted cuts.

LCMF 0313MO-MP	T8330	1.5	■	190	0.30	0.8	☑	110	0.27	0.8	■	180	0.30	0.8	■	-	-	-	-	-	-
LCMF 0313MO-MP-04	T8330¹⁾	1.5	■	190	0.30	0.8	☑	110	0.27	0.8	■	180	0.30	0.8	■	-	-	-	-	-	-
LCMF 0413MO-MP	T8330	2.0	■	175	0.40	1.0	☑	105	0.36	1.0	■	165	0.40	1.0	■	-	-	-	-	-	-

¹⁾ Insert for internal holder A16Q-GGERIL0313-04, A20R-GGFRIL0313-04.

LCMR 13 - F

	CW	CWTOLL	CWTOLU	INSL
	[mm]	[mm]	[mm]	[mm]
0313	3.00	-0.05	0.05	12.6
0413	4.00	-0.05	0.05	12.6

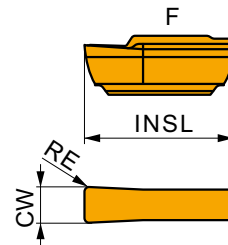

Suitability and starting values for cutting speed (vc), feed (f) and depth of cut (ap). Refer to our Machining Calculator app for further calculations.

Product	RE	P			M			K			N			S			H		
		vc	f	ap	vc	f	ap	vc	f	ap	vc	f	ap	vc	f	ap	vc	f	ap
	[mm]	[m/min]	[mm/rev]	[mm]	[m/min]	[mm/rev]	[mm]	[m/min]	[mm/rev]	[mm]	[m/min]	[mm/rev]	[mm]	[m/min]	[mm/rev]	[mm]	[m/min]	[mm/rev]	[mm]

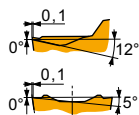

F geometry for grooving and turning, fine and finish machining, and continuous to slightly interrupted cuts.

LCMR 031304-F	T8330	0.4	■	185	0.13	0.5	☑	110	0.12	0.5	■	175	0.13	0.5	■	-	-	-	-	-	-
LCMR 041304-F	T8330	0.4	■	185	0.13	0.5	☑	110	0.12	0.5	■	175	0.13	0.5	■	-	-	-	-	-	-



LCMR 13 - MP

	CW	CWTOLL	CWTOLU	INSL
	[mm]	[mm]	[mm]	[mm]
0313	3.00	-0.05	0.05	12.6
0413	4.00	-0.05	0.05	12.6

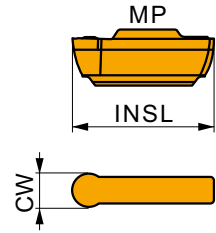

Suitability and starting values for cutting speed (vc), feed (f) and depth of cut (ap). Refer to our Machining Calculator app for further calculations.

Product	RE [mm]	P			M			K			N			S			H		
		vc [m/min]	f [mm/rev]	ap [mm]	vc [m/min]	f [mm/rev]	ap [mm]	vc [m/min]	f [mm/rev]	ap [mm]	vc [m/min]	f [mm/rev]	ap [mm]	vc [m/min]	f [mm/rev]	ap [mm]	vc [m/min]	f [mm/rev]	ap [mm]

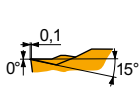

MP geometry for longitudinal turning and copy profiling, and continuous to interrupted cuts.

LCMR 0313MO-MP	T8330	1.5	190	0.30	0.8	110	0.27	0.8	180	0.30	0.8	-	-	-	-	-	-	-	-
LCMR 0413MO-MP	T8330	2.0	175	0.40	1.0	105	0.36	1.0	165	0.40	1.0	-	-	-	-	-	-	-	-



GG.(RL) INT

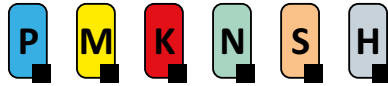

PRAMET

G



Internal Grooving Boring Bar for LCM. Inserts

Internal Right/Left hand grooving boring bar for grooving with LCM. 0313 and 0413 inserts. Minimum internal grooving diameter $\varnothing 16$ mm. Suited for internal grooving and multi-directional turning. Available with shank size $\varnothing 16$ up to $\varnothing 32$ mm. Body treated for longer tool life.

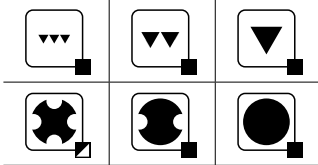
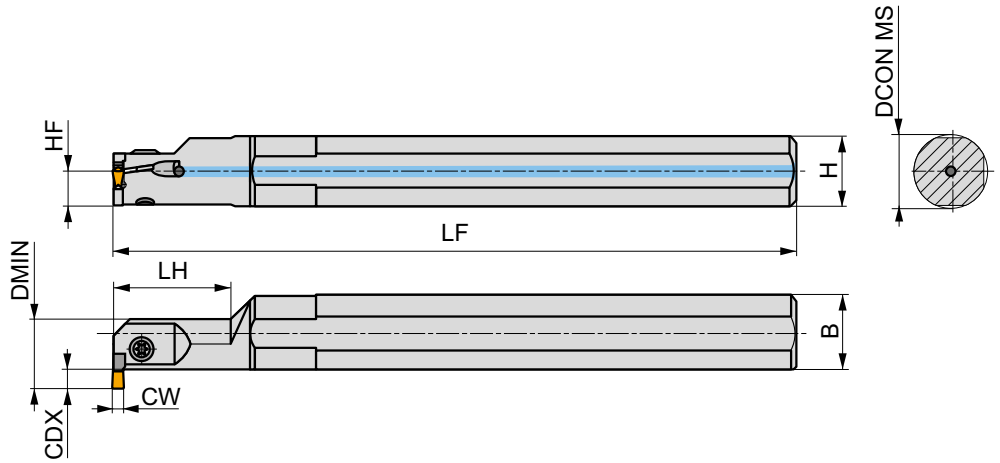
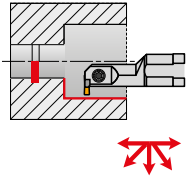

Product	DCON MS	HF	H	B	LF	LH	CW	CDX	DMIN					
														[mm]
R	A16Q-GGER 0313	16	7.5	15	15.5	180	25	3.00	3	16	✓	0.26	GI143	GL06
	A16Q-GGER 0313-04	16	7.5	15	15.5	180	25	3.00	3	16	✓	0.26	GI190	GL06
	A20R-GGFR 0313	20	9	18	19	200	30	3.00	4.5	20	✓	0.36	GI143	GL06
	A20R-GGFR 0313-04	20	9	18	19	200	30	3.00	4.5	20	✓	0.39	GI190	GL06
	A25S-GGHR 0313	25	11.5	23	24	250	40	3.00	6.5	25	✓	0.78	GI143	GL06
	A25S-GGFR 0413	25	11.5	23	24	250	40	4.00	6.5	25	✓	0.73	GI170	GL06
L	A32T-GGHR 0413	32	15	30	31	300	50	4.00	9.5	32	✓	1.59	GI170	GL06
	A16Q-GGEL 0313	16	7.5	15	15.5	180	25	3.00	3	16	✓	0.29	GI143	GL06
	A16Q-GGEL 0313-04	16	7.5	15	15.5	180	25	3.00	3	16	✓	0.28	GI190	GL06
	A20R-GGFL 0313	20	9	18	19	200	30	3.00	4.5	20	✓	0.38	GI143	GL06
	A20R-GGFL 0313-04	20	9	18	19	200	30	3.00	4.5	20	✓	0.38	GI190	GL06
	A25S-GGHL 0313	25	11.5	23	24	250	40	3.00	6.5	25	✓	0.81	GI143	GL06
	A25S-GGFL 0413	25	11.5	23	24	250	40	4.00	6.5	25	✓	0.82	GI170	GL06
A32T-GGHL 0413	32	15	30	31	300	50	4.00	9.5	32	✓	1.59	GI170	GL06	



GI143
GI170
GI190

LCM. 0313..
LCM. 0413..
LCM. 0313.....-04



GL06

SR 85011-T15P

5.0

M 5

9

FLAG T15P



GFIL-L AXIAL

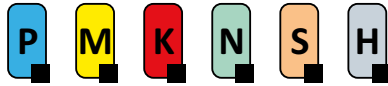

PRAMET

G



External Axial V-Groove Top Clamp Grooving Tool for LCM. 03 Inserts

External left-hand axial tool holder for grooving with single or double-sided LCM. 0313 or 0316 inserts. Suited for axial grooving, axial profiling or groove widening Ø17 up to Ø170 mm applications with maximum depth of cut 9 mm. Available with shank size 25x25 mm. Body treated for longer tool life.

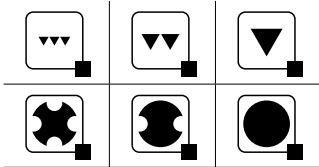
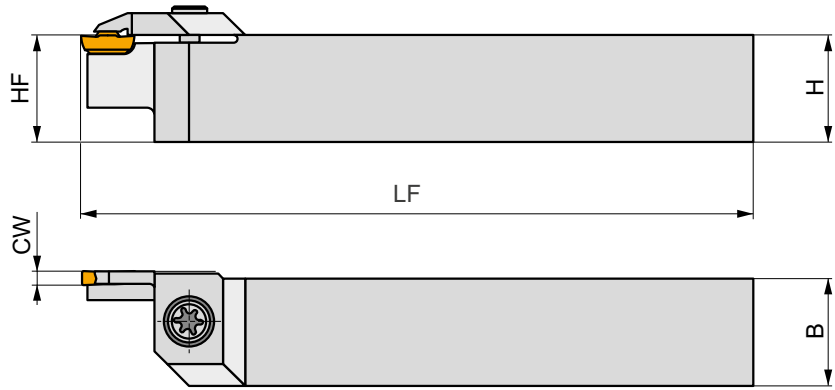
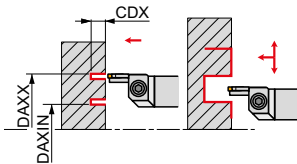

Product	HF	H	B	LF	CW	CDX	DAXIN	DAXX	kg	G1136	G1143
	[mm]	[mm]	[mm]	[mm]	[mm]	[mm]	[mm]				
GFIL 2525 M 0313L 030017	25	25	25	150	3.00	9	17	30	0.64	G1143	GL02
GFIL 2525 M 0313L 039024	25	25	25	150	3.00	9	24	39	0.66	G1143	GL07
GFIL 2525 M 0313L 050033	25	25	25	150	3.00	9	33	50	0.67	G1143	GL07
GFIL 2525 M 0313L 060043	25	25	25	150	3.00	9	43	60	0.67	G1143	GL07
GFIL 2525 M 0313L 076053	25	25	25	150	3.00	9	53	76	0.67	G1143	GL07
GFIL 2525 M 0316L 100070	25	25	25	150	3.00	9	70	100	0.69	G1136	GL07
GFIL 2525 M 0316L 130090	25	25	25	150	3.00	9	90	130	0.70	G1136	GL07
GFIL 2525 M 0316L 170110	25	25	25	150	3.00	9	110	170	0.71	G1136	GL07

G1136		G1143	
LCM. 0316..		LCM. 0313..	

GL02	GL07	US 5015-T20P	US 5018-T20P	5.0	5.0	M 5	M 5	15	18.2	FLAGT20P	FLAGT20P
				Nm							



GFIL-R AXIAL



PRAMET

G



External Axial V-Groove Top Clamp Grooving Tool for LCM. 03 or 04 Inserts

External left-hand axial tool holder for grooving with single or double-sided LCM. 0313, 0316, 0413 or 0416 inserts. Suited for axial grooving, axial profiling or groove widening $\varnothing 17$ up to $\varnothing 230$ mm applications, with maximum depth of cut 12 mm. Available with shank size 25x25. Body treated for longer tool life.

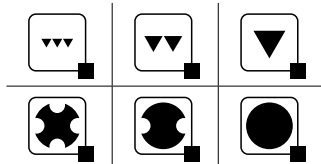
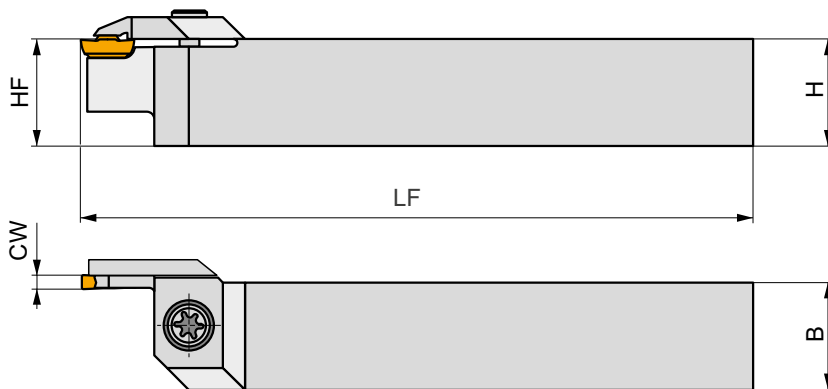
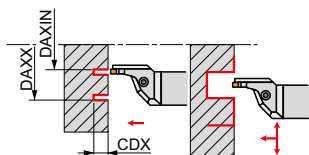

Product	HF	H	B	LF	CW	CDX	DAXIN	DAXX	kg		
	[mm]	[mm]	[mm]	[mm]	[mm]	[mm]		[mm]			
L GFIL 2525 M 03R 030017-A	25	25	25	150	3.00	9	17	30	0.69	GI143	GL07
GFIL 2525 M 03R 039024-A	25	25	25	150	3.00	9	24	39	0.69	GI143	GL07
GFIL 2525 M 03R 050033-A	25	25	25	150	3.00	9	33	50	0.72	GI143	GL07
GFIL 2525 M 03R 060043-A	25	25	25	150	3.00	9	43	60	0.69	GI143	GL07
GFIL 2525 M 03R 076053-A	25	25	25	150	3.00	9	53	76	0.68	GI143	GL07
GFIL 2525 M 03R 100070-A	25	25	25	150	3.00	9	70	100	0.79	GI136	GL08
GFIL 2525 M 03R 130090-A	25	25	25	150	3.00	9	90	130	0.73	GI136	GL08
GFIL 2525 M 03R 170110-A	25	25	25	150	3.00	9	110	170	0.76	GI136	GL08
GFIL 2525 M 04R 030017-A	25	25	25	150	3.00	9	17	30	0.71	GI170	GL07
GFIL 2525 M 04R 034021-A	25	25	25	150	4.00	9	21	34	0.69	GI170	GL07
GFIL 2525 M 04R 040026-A	25	25	25	150	4.00	11	26	40	0.00	GI170	GL07
GFIL 2525 M 04R 050032-A	25	25	25	150	4.00	11	32	50	0.68	GI170	GL07
GFIL 2525 M 04R 060042-A	25	25	25	150	4.00	11	42	60	0.66	GI170	GL07
GFIL 2525 M 04R 075052-A	25	25	25	150	4.00	11	52	75	0.67	GI170	GL07
GFIL 2525 M 04R 100070-A	25	25	25	150	4.00	12	70	100	0.75	GI137	GL08
L GFIL 2525 M 04R 130090-A	25	25	25	150	4.00	12	90	130	0.75	GI137	GL08
GFIL 2525 M 04R 170110-A	25	25	25	150	4.00	12	110	170	0.75	GI137	GL08
GFIL 2525 M 04R 230140-A	25	25	25	150	4.00	12	140	230	0.78	GI137	GL08



GI136

LCM. 0316..

GI137

LCM. 0416..

GI143

LCM. 0313..

GI170

LCM. 0413..



GL07

US 5018-T20P

5.0

M 5

18.2

FLAG T20P

GL08

US 6020-T25P

6.0

M 6

20.2

-

SDRT25P



GFIR-L AXIAL



PRAMET

G



External Axial V-Groove Top Clamp Grooving Tool for LCM. 03 or 04 Inserts

External right-hand axial tool holder for grooving with single or double-sided LCM. 0313, 0316, 0413 or 0416 inserts. Suited for axial grooving, axial profiling or groove widening Ø17 up to Ø230 mm applications, with maximum depth of cut 12 mm. Available with shank size 25x25 mm. Body treated for longer tool life.

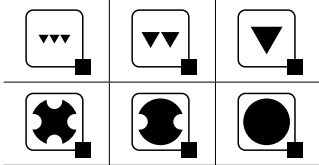
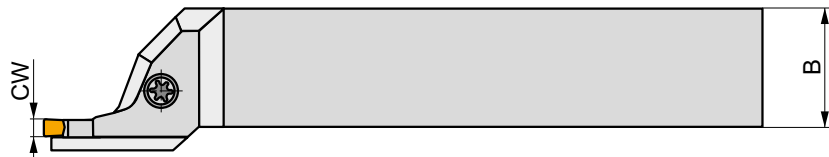
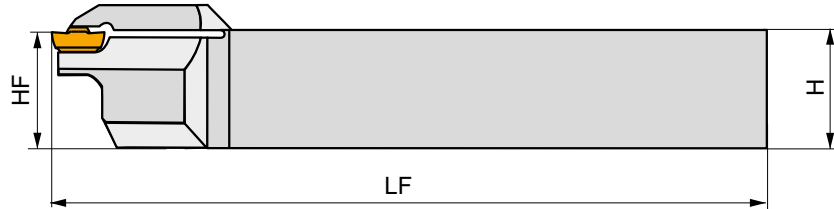
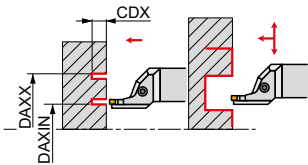

Product	HF	H	B	LF	CW	CDX	DAXIN	DAXX	kg	Icon 1	Icon 2
	[mm]	[mm]	[mm]	[mm]	[mm]	[mm]		[mm]			
R GFIR 2525 M 03L 030017-A	25	25	25	150	3.00	9	17	30	0.65	GI143	GL07
GFIR 2525 M 03L 039024-A	25	25	25	150	3.00	9	24	39	0.68	GI143	GL07
GFIR 2525 M 03L 050033-A	25	25	25	150	3.00	9	33	50	0.65	GI143	GL07
GFIR 2525 M 03L 060043-A	25	25	25	150	3.00	9	43	60	0.68	GI143	GL07
GFIR 2525 M 03L 076053-A	25	25	25	150	3.00	9	53	76	0.69	GI143	GL07
GFIR 2525 M 03L 100070-A	25	25	25	150	3.00	9	70	100	0.75	GI136	GL08
GFIR 2525 M 03L 130090-A	25	25	25	150	3.00	9	90	130	0.76	GI136	GL08
GFIR 2525 M 03L 170110-A	25	25	25	150	3.00	9	110	170	0.68	GI136	GL08
GFIR 2525 M 04L 030017-A	25	25	25	150	3.00	9	17	30	0.68	GI170	GL07
GFIR 2525 M 04L 034021-A	25	25	25	150	4.00	9	21	34	0.68	GI170	GL07
GFIR 2525 M 04L 040026-A	25	25	25	150	4.00	11	26	40	0.68	GI170	GL07
GFIR 2525 M 04L 050032-A	25	25	25	150	4.00	11	32	50	0.66	GI170	GL07
GFIR 2525 M 04L 060042-A	25	25	25	150	4.00	11	42	60	0.69	GI170	GL07
GFIR 2525 M 04L 075052-A	25	25	25	150	4.00	11	52	75	0.67	GI170	GL07
GFIR 2525 M 04L 100070-A	25	25	25	150	4.00	12	70	100	0.72	GI137	GL08
R GFIR 2525 M 04L 130090-A	25	25	25	150	4.00	12	90	130	0.75	GI137	GL08
GFIR 2525 M 04L 170110-A	25	25	25	150	4.00	12	110	170	0.72	GI137	GL08
GFIR 2525 M 04L 230140-A	25	25	25	150	4.00	12	140	230	0.79	GI137	GL08



GI136
GI137
GI143
GI170

LCM. 0316..
LCM. 0416..
LCM. 0313..
LCM. 0413..



GL07
GL08

US 5018-T20P
US 6020-T25P

5.0
6.0

M5
M6

18.2
20.2

FLAG T20P
-

-
SDRT25P



GFIR-R AXIAL

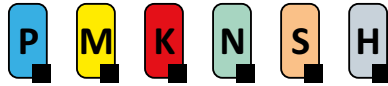

PRAMET

G



External Axial V-Groove Top Clamp Grooving Tool for LCM. 03 Inserts

External right-hand axial tool holder for grooving with single or double-sided LCM. 0313 or 0316 inserts. Suited for axial grooving, axial profiling or groove widening $\varnothing 17$ up to $\varnothing 170$ mm applications, with maximum depth of cut 9 mm. Available with shank size 25x25 mm. Body treated for longer tool life.

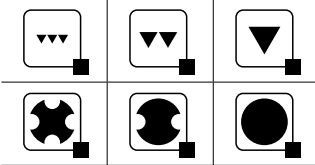
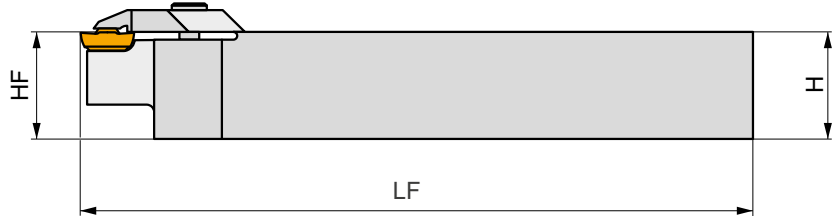
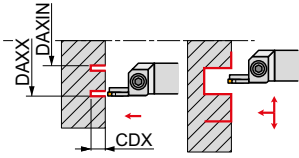

Product	\varnothing	H	B	LF	CW	CDX	DAXIN	DAXX	kg	G1136 G1143	GL02 GL07	
	[mm]	[mm]	[mm]	[mm]	[mm]	[mm]	[mm]	[mm]				
R	GFIR 2525 M 0313R 030017	25	25	25	150	3.00	9	17	30	0.65	G1143	GL02
	GFIR 2525 M 0313R 039024	25	25	25	150	3.00	9	24	39	0.66	G1143	GL07
	GFIR 2525 M 0313R 050033	25	25	25	150	3.00	9	33	50	0.68	G1143	GL07
	GFIR 2525 M 0313R 060043	25	25	25	150	3.00	9	43	60	0.68	G1143	GL07
	GFIR 2525 M 0313R 076053	25	25	25	150	3.00	9	53	76	0.68	G1143	GL07
	GFIR 2525 M 0316R 100070	25	25	25	150	3.00	9	70	100	0.69	G1136	GL07
	GFIR 2525 M 0316R 130090	25	25	25	150	3.00	9	90	130	0.70	G1136	GL07
	GFIR 2525 M 0316R 170110	25	25	25	150	3.00	9	110	170	0.70	G1136	GL07

Product	LCM. 0316..	LCM. 0313..
G1136	LCM. 0316..	
G1143		LCM. 0313..

Product	US 5015-T20P	Nm	M 5	15	FLAG T20P
GL02	US 5015-T20P	5.0	M 5	15	FLAG T20P
GL07	US 5018-T20P	5.0	M 5	18.2	FLAG T20P



GFML-L AXIAL



PRAMET

G



External Axial V-Groove Top Clamp Grooving Tool for LCM. 04 Inserts

External left-hand axial tool holder for grooving with single or double-sided LCM. 0413 or 0416 inserts. Suited for deep axial grooving, axial profiling or groove widening $\varnothing 17$ up to $\varnothing 230$ mm applications, with maximum depth of cut 20 mm. Available with shank size 25x25 mm. Body treated for longer tool life.

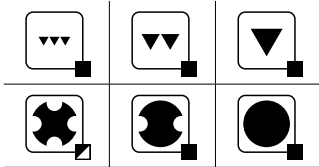
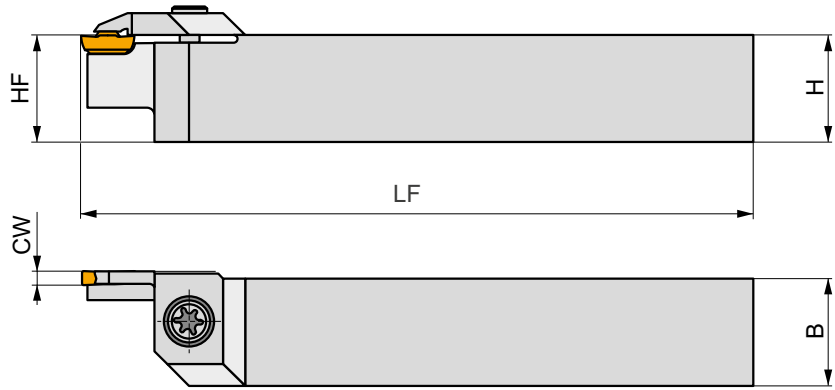
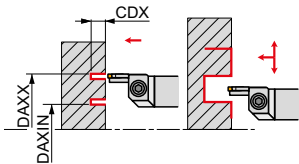

Product	HF	H	B	LF	CW	CDX	DAXIN	DAXX	kg	G170	GL02
	[mm]	[mm]	[mm]	[mm]	[mm]	[mm]	[mm]	[mm]			
GFML 2525 M 0413L 030017	25	25	25	150	4.00	20	17	30	0.62	G170	GL02
GFML 2525 M 0413L 034021	25	25	25	150	4.00	20	21	34	0.63	G170	GL07
GFML 2525 M 0413L 040026	25	25	25	150	4.00	20	26	40	0.65	G170	GL07
GFML 2525 M 0413L 050032	25	25	25	150	4.00	20	32	50	0.64	G170	GL07
GFML 2525 M 0413L 060042	25	25	25	150	4.00	20	42	60	0.65	G170	GL07
GFML 2525 M 0413L 075052	25	25	25	150	4.00	20	52	75	0.66	G170	GL07
GFML 2525 M 0416L 100070	25	25	25	150	4.00	20	70	100	0.66	G137	GL07
GFML 2525 M 0416L 130090	25	25	25	150	4.00	20	90	130	0.67	G137	GL07
GFML 2525 M 0416L 170110	25	25	25	150	4.00	20	110	170	0.67	G137	GL07
GFML 2525 M 0416L 230140	25	25	25	150	4.00	20	140	230	0.67	G137	GL07



G137
G170

LCM. 0416..
LCM. 0413..



GL02
GL07

US 5015-T20P
US 5018-T20P

5.0
5.0

M 5
M 5

15
18.2

FLAG T20P
FLAG T20P



GFML-R AXIAL

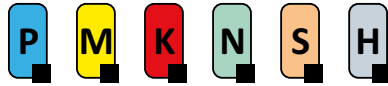

PRAMET

G



External Axial V-Groove Top Clamp Grooving Tool for LCM. 04 Inserts

External left-hand axial tool holder for grooving with single or double-sided LCM. 0413 or 0416 inserts. Suited for deep axial grooving, axial profiling or groove widening Ø17 up to Ø230 mm applications, with maximum depth of cut 20 mm. Available with shank size 25x25 mm. Body treated for longer tool life.

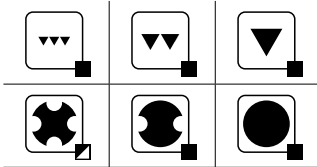
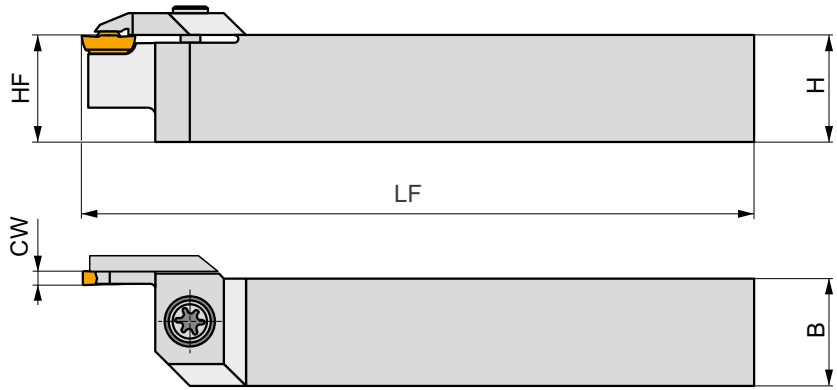
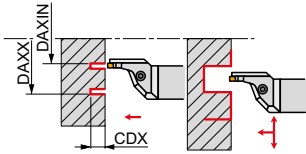

Product	HF	H	B	LF	CW	CDX	DAXIN	DAXX	kg	G1	G2	
	[mm]	[mm]	[mm]	[mm]	[mm]	[mm]	[mm]	[mm]				
L	GFML 2525 M 0413R 030017	25	25	25	150	4.00	20	17	30	0.68	G1170	GL07
	GFML 2525 M 0413R 034021	25	25	25	150	4.00	20	21	34	0.69	G1170	GL07
	GFML 2525 M 0413R 040026	25	25	25	150	4.00	20	26	40	0.69	G1170	GL07
	GFML 2525 M 0413R 050032	25	25	25	150	4.00	20	32	50	0.68	G1170	GL07
	GFML 2525 M 0413R 060042	25	25	25	150	4.00	20	42	60	0.69	G1170	GL07
	GFML 2525 M 0413R 075052	25	25	25	150	4.00	20	52	75	0.69	G1170	GL07
	GFML 2525 M 0416R 100070	25	25	25	150	4.00	20	70	100	0.80	G1137	GL08
	GFML 2525 M 0416R 130090	25	25	25	150	4.00	20	90	130	0.78	G1137	GL08
	GFML 2525 M 0416R 170110	25	25	25	150	4.00	20	110	170	0.78	G1137	GL08
	GFML 2525 M 0416R 230140	25	25	25	150	4.00	20	140	230	0.78	G1137	GL08



G1137

LCM. 0416..

G1170

LCM. 0413..



GL07

US 5018-T20P

5.0

M 5

18.2

FLAGT20P

-

GL08

US 6020-T25P

6.0

M 6

20.2

-

SDRT25P



GFMR-L AXIAL

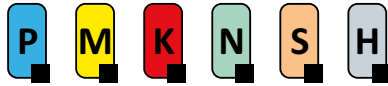

PRAMET

G



External Axial V-Groove Top Clamp Grooving Tool for LCM. 04 Inserts

External right-hand axial tool holder for grooving with single or double-sided LCM. 0413 or 0416 inserts. Suited for deep axial grooving, axial profiling or groove widening $\varnothing 17$ up to $\varnothing 230$ mm applications, with maximum depth of cut 20 mm. Available with shank size 25x25 mm. Body treated for longer tool life.

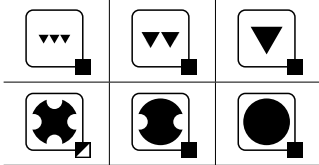
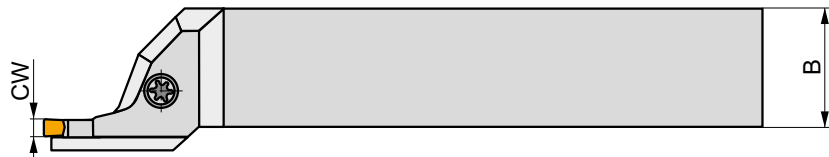
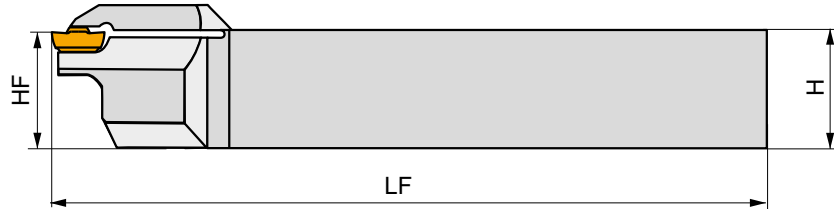
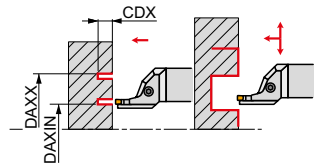

Product	HF	H	B	LF	CW	CDX	DAXIN	DAXX	kg	G1	G2
	[mm]	[mm]	[mm]	[mm]	[mm]	[mm]	[mm]	[mm]			
GFMR 2525 M 0413L 030017	25	25	25	150	4.00	20	17	30	0.70	G1170	GL07
GFMR 2525 M 0413L 034021	25	25	25	150	4.00	20	21	34	0.66	G1170	GL07
GFMR 2525 M 0413L 040026	25	25	25	150	4.00	20	26	40	0.66	G1170	GL07
GFMR 2525 M 0413L 050032	25	25	25	150	4.00	20	32	50	0.68	G1170	GL07
GFMR 2525 M 0413L 060042	25	25	25	150	4.00	20	42	60	0.66	G1170	GL07
GFMR 2525 M 0413L 075052	25	25	25	150	4.00	20	52	75	0.69	G1170	GL07
GFMR 2525 M 0416L 100070	25	25	25	150	4.00	20	70	100	0.88	G1137	GL08
GFMR 2525 M 0416L 130090	25	25	25	150	4.00	20	90	130	0.78	G1137	GL08
GFMR 2525 M 0416L 170110	25	25	25	150	4.00	20	110	170	0.81	G1137	GL08
GFMR 2525 M 0416L 230140	25	25	25	150	4.00	20	140	230	0.78	G1137	GL08

G1	LCM
G1137	LCM. 0416..
G1170	LCM. 0413..

GL	US	Nm	M	mm	FLAG	SDRT
GL07	US 5018-T20P	5.0	M 5	18.2	FLAG T20P	-
GL08	US 6020-T25P	6.0	M 6	20.2	-	SDRT25P



GFMR-R AXIAL

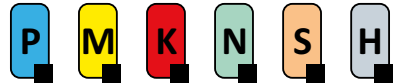

PRAMET



External Axial V-Groove Top Clamp Grooving Tool for LCM. 04 Inserts

External right-hand axial tool holder for grooving with single or double-sided LCM. 0413 or 0416 inserts. Suited for deep axial grooving, axial profiling or groove widening Ø17 up to Ø230 mm applications, with maximum depth of cut 20 mm. Available with shank size 25x25 mm. Body treated for longer tool life.

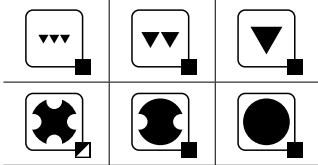
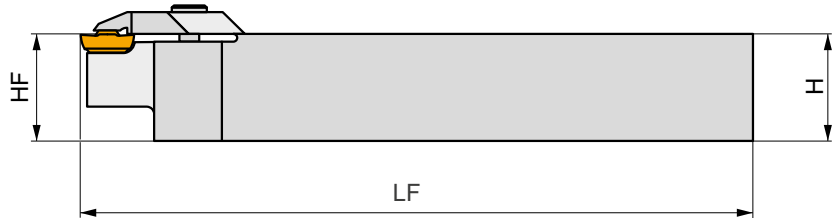
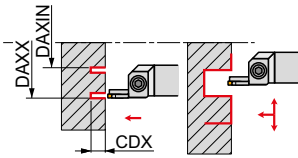

Product	⌀	H	B	LF	CW	CDX	DAXIN	DAXX	kg	G1	G2	
	[mm]	[mm]	[mm]	[mm]	[mm]	[mm]	[mm]					
R	GFMR 2525 M 0413R 030017	25	25	25	150	4.00	20	17	30	0.62	G1170	GL02
	GFMR 2525 M 0413R 034021	25	25	25	150	4.00	20	21	34	0.63	G1170	GL07
	GFMR 2525 M 0413R 040026	25	25	25	150	4.00	20	26	40	0.64	G1170	GL07
	GFMR 2525 M 0413R 050032	25	25	25	150	4.00	20	32	50	0.63	G1170	GL07
	GFMR 2525 M 0413R 060042	25	25	25	150	4.00	20	42	60	0.64	G1170	GL07
	GFMR 2525 M 0413R 075052	25	25	25	150	4.00	20	52	75	0.67	G1170	GL07
	GFMR 2525 M 0416R 100070	25	25	25	150	4.00	20	70	100	0.67	G1137	GL07
	GFMR 2525 M 0416R 130090	25	25	25	150	4.00	20	90	130	0.66	G1137	GL07
	GFMR 2525 M 0416R 170110	25	25	25	150	4.00	20	110	170	0.67	G1137	GL07
	GFMR 2525 M 0416R 230140	25	25	25	150	4.00	20	140	230	0.68	G1137	GL07

G1	Insert	LCM
G1137		LCM. 0416..
G1170		LCM. 0413..

GL	Clamp	Torque (Nm)	Thread	Length	Clamp Type
GL02		5.0	M 5	15	FLAG T20P
GL07		5.0	M 5	18.2	FLAG T20P



GGI(RL)-90 AXIAL



PRAMET

G



External Axial 90° V-Groove Top Clamp Grooving Tool for LCM. 03 Inserts

External Right/Left hand axial 90° tool holder for grooving with single or double-sided LCM. 0313 or 0316 inserts. Suited for axial grooving, axial profiling or groove widening Ø17 up to Ø170 mm applications, with maximum depth of cut 11 mm. Available with shank size 25x25 mm. Body treated for longer tool life.

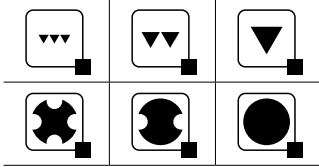
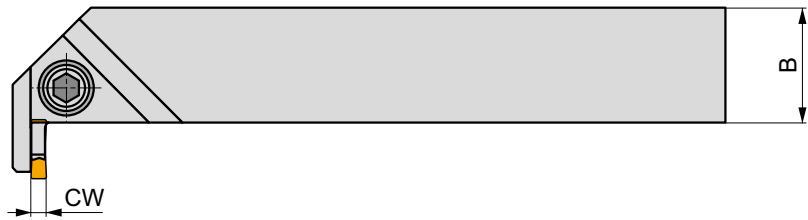
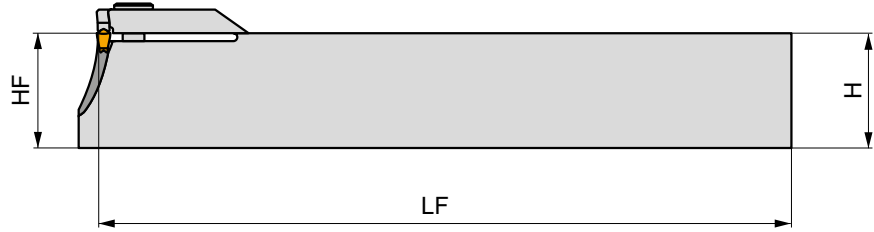
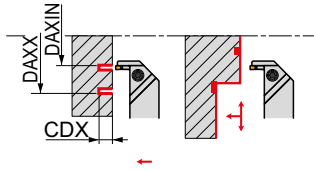

	Product	HF	H	B	LF	CW	CDX	DAXIN	DAXX	kg	G136	G143
		[mm]	[mm]	[mm]	[mm]	[mm]	[mm]	[mm]	[mm]			
R	GGIR 2525 M 03R 030017	25	25	25	150	3.00	9.5	17	30	0.75	G143	GL01
	GGIR 2525 M 03R 039024	25	25	25	150	3.00	9.5	24	39	0.78	G143	GL01
	GGIR 2525 M 03R 050033	25	25	25	150	3.00	11	33	50	0.75	G143	GL01
	GGIR 2525 M 03R 060043	25	25	25	150	3.00	11	43	60	0.78	G143	GL01
	GGIR 2525 M 03R 076053	25	25	25	150	3.00	11	53	76	0.75	G143	GL01
	GGIR 2525 M 03R 100070	25	25	25	150	3.00	9	70	100	0.78	G136	GL04
	GGIR 2525 M 03R 130090	25	25	25	150	3.00	9	90	130	0.73	G136	GL04
	GGIR 2525 M 03R 170110	25	25	25	150	3.00	9	110	170	0.76	G136	GL04
L	GGIL 2525 M 03L 030017	25	25	25	150	3.00	9.5	17	30	0.75	G143	GL01
	GGIL 2525 M 03L 039024	25	25	25	150	3.00	9.5	24	39	0.25	G143	GL01
	GGIL 2525 M 03L 050033	25	25	25	150	3.00	11	33	50	0.75	G143	GL01
	GGIL 2525 M 03L 060043	25	25	25	150	3.00	11	43	60	0.75	G143	GL01
	GGIL 2525 M 03L 076053	25	25	25	150	3.00	11	53	76	0.75	G143	GL01
	GGIL 2525 M 03L 100070	25	25	25	150	3.00	9	70	100	0.77	G136	GL04
	GGIL 2525 M 03L 130090	25	25	25	150	3.00	9	90	130	0.77	G136	GL04
	GGIL 2525 M 03L 170110	25	25	25	150	3.00	9	110	170	0.76	G136	GL04

G136		LCM. 0316..	
G143		LCM. 0313..	

GL01	HS 0520C	5.0	M 5	20	HXK 4
GL04	HS 0620C	6.0	M 6	20	HXK 5



LCMF 16 - CM

	CW	CWTOLL	CWTOLU	INSL
	[mm]	[mm]	[mm]	[mm]
0316	3.00	-0.05	0.05	16.4
0416	4.00	-0.05	0.05	16.4
0516	5.00	-0.05	0.05	16.4
0616	6.00	-0.05	0.05	16.4

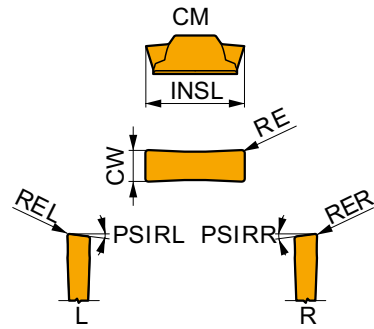

Suitability and starting values for cutting speed (vc), feed (f) and depth of cut (ap). Refer to our cutting conditions app for further options.

Product	RE [mm]	P		M		K		N		S		H		PSIRR [°]	PSIRL [°]
		vc [m/min]	f [mm/rev]	vc [m/min]	f [mm/rev]	vc [m/min]	f [mm/rev]	vc [m/min]	f [mm/rev]	vc [m/min]	f [mm/rev]	vc [m/min]	f [mm/rev]		

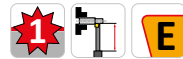
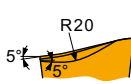

CM geometry, first choice for parting-off and grooving, and continuous to slightly interrupted cuts.

LCMF 031602-CM	T8330	0.2	130	0.11	75	0.10	120	0.11	-	-	-	-	-	-	-
LCMF 031604-CM	T8330	0.4	130	0.11	75	0.10	120	0.11	-	-	-	-	-	-	-
LCMF 041602-CM	T8330	0.2	130	0.11	75	0.10	120	0.11	-	-	-	-	-	-	-
LCMF 041604-CM	T8330	0.4	130	0.11	75	0.10	120	0.11	-	-	-	-	-	-	-
LCMF 051604-CM	T8330	0.4	130	0.11	75	0.11	120	0.11	-	-	-	-	-	-	-
LCMF 061604-CM	T8330	0.4	130	0.11	75	0.11	120	0.11	-	-	-	-	-	-	-

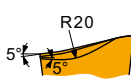

R-CM geometry, right-handed design, first choice for parting-off and continuous to slightly interrupted cuts.

LCMF 031602R15-CM	T8330 ¹⁾	0.2	130	0.11	75	0.10	120	0.11	-	-	-	-	15	-
LCMF 031602R6-CM	T8330	0.2	130	0.11	75	0.10	120	0.11	-	-	-	-	6	-
LCMF 041602R15-CM	T8330 ¹⁾	0.2	130	0.11	75	0.10	120	0.11	-	-	-	-	15	-
LCMF 041602R6-CM	T8330	0.2	130	0.11	75	0.10	120	0.11	-	-	-	-	6	-

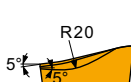

L-CM geometry, left-handed design, first choice for parting-off and continuous to slightly interrupted cuts.

LCMF 031602L15-CM	T8330 ¹⁾	0.2	130	0.11	75	0.10	120	0.11	-	-	-	-	-	15
LCMF 031602L6-CM	T8330	0.2	130	0.11	75	0.10	120	0.11	-	-	-	-	-	6
LCMF 041602L15-CM	T8330 ¹⁾	0.2	130	0.11	75	0.10	120	0.11	-	-	-	-	-	15
LCMF 041602L6-CM	T8330	0.2	130	0.11	75	0.10	120	0.11	-	-	-	-	-	6

¹⁾ Toolholders have to be modified.



LCMF 16, LCMF 30 - F



	CW	CWTOLL	CWTOLU	INSL
	[mm]	[mm]	[mm]	[mm]
0316	3.00	-0.05	0.05	16.4
0416	4.00	-0.05	0.05	16.4
0516	5.00	-0.05	0.05	16.4
0616	6.00	-0.05	0.05	16.4
0830	8.00	-0.05	0.05	30.0

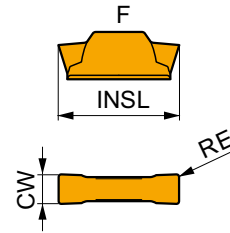

Suitability and starting values for cutting speed (vc), feed (f) and depth of cut (ap). Refer to our cutting conditions app for further options.

Product	RE	P			M			K			N			S			H		
		vc	f	ap	vc	f	ap	vc	f	ap	vc	f	ap	vc	f	ap	vc	f	ap
	[mm]	[m/min]	[mm/rev]	[mm]	[m/min]	[mm/rev]	[mm]	[m/min]	[mm/rev]	[mm]	[m/min]	[mm/rev]	[mm]	[m/min]	[mm/rev]	[mm]	[m/min]	[mm/rev]	[mm]

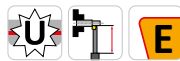
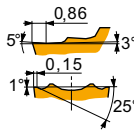

F geometry for parting-off, grooving and axial turning, fine and finish machining, and continuous to slightly interrupted cuts.

LCMF 031602-F	T8330	0.2	■	195	0.10	0.3	☑	115	0.09	0.3	☑	185	0.10	0.3	-	-	-	-	-	-
LCMF 031604-F	T8330	0.4	■	200	0.10	0.5	☑	120	0.09	0.5	☑	190	0.10	0.5	-	-	-	-	-	-
LCMF 041604-F	T8330	0.4	■	185	0.13	0.5	☑	110	0.12	0.5	☑	175	0.13	0.5	-	-	-	-	-	-
	T9325	0.4	■	275	0.13	0.5	☑	165	0.12	0.5	☑	260	0.13	0.5	-	-	-	-	-	-
LCMF 041608-F	T8330	0.8	■	205	0.13	1.0	☑	120	0.12	1.0	☑	190	0.13	1.0	-	-	-	-	-	-
	T9325	0.8	■	305	0.13	1.0	☑	180	0.12	1.0	☑	285	0.13	1.0	-	-	-	-	-	-
LCMF 051608-F	T8330	0.8	■	195	0.15	1.0	☑	115	0.14	1.0	☑	185	0.15	1.0	-	-	-	-	-	-
	T9325	0.8	■	285	0.15	1.0	☑	170	0.14	1.0	☑	270	0.15	1.0	-	-	-	-	-	-
LCMF 061608-F	T8330	0.8	■	190	0.17	1.0	☑	110	0.15	1.0	☑	180	0.17	1.0	-	-	-	-	-	-
	T9325	0.8	■	270	0.17	1.0	☑	160	0.15	1.0	☑	255	0.17	1.0	-	-	-	-	-	-

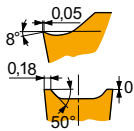

F geometry for parting-off, grooving and axial turning, fine and finish machining, and continuous to slightly interrupted cuts.

LCMF 083008-F	T8330	0.8	■	175	0.25	1.0	☑	105	0.23	1.0	☑	165	0.25	1.0	-	-	-	-	-	-
LCMF 083012-F	T8330	1.2	■	170	0.25	1.5	☑	100	0.23	1.5	☑	160	0.25	1.5	-	-	-	-	-	-



LCMF 16 - M



	CW	CWTOLL	CWTOLU	INSL
	[mm]	[mm]	[mm]	[mm]
0316	3.00	-0.05	0.05	16.4
0416	4.00	-0.05	0.05	16.4
0516	5.00	-0.05	0.05	16.4
0616	6.00	-0.05	0.05	16.4

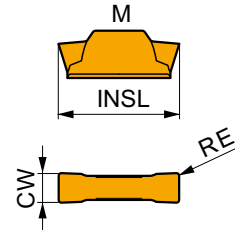

Suitability and starting values for cutting speed (vc), feed (f) and depth of cut (ap). Refer to our cutting conditions app for further options.

Product	RE	P			M			K			N			S			H		
		vc	f	ap	vc	f	ap	vc	f	ap	vc	f	ap	vc	f	ap	vc	f	ap
	[mm]	[m/min]	[mm/rev]	[mm]	[m/min]	[mm/rev]	[mm]	[m/min]	[mm/rev]	[mm]	[m/min]	[mm/rev]	[mm]	[m/min]	[mm/rev]	[mm]	[m/min]	[mm/rev]	[mm]

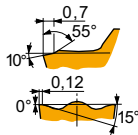

M geometry for grooving and longitudinal turning, and continuous to interrupted cuts.

LCMF 031602-M	T8330	0.2	160	0.13	1.0	95	0.12	1.0	150	0.13	1.0	-	-	-	30	0.15	1.0
LCMF 031604-M	T8330	0.4	170	0.13	1.0	100	0.12	1.0	160	0.13	1.0	-	-	-	30	0.15	1.0
LCMF 041604-M	T8330	0.4	155	0.18	1.0	90	0.16	1.0	145	0.18	1.0	-	-	-	30	0.15	1.0
	T9325	0.4	225	0.18	1.0	135	0.16	1.0	210	0.18	1.0	-	-	-	-	-	-
LCMF 041608-M	T8330	0.8	185	0.18	1.0	110	0.16	1.0	175	0.18	1.0	-	-	-	35	0.15	1.0
	T9325	0.8	265	0.18	1.0	155	0.16	1.0	250	0.18	1.0	-	-	-	-	-	-
LCMF 051608-M	T8330	0.8	180	0.20	1.0	105	0.18	1.0	170	0.20	1.0	-	-	-	35	0.15	1.0
	T9325	0.8	255	0.20	1.0	150	0.18	1.0	240	0.20	1.0	-	-	-	-	-	-
LCMF 061608-M	T8330	0.8	175	0.25	1.0	105	0.23	1.0	165	0.25	1.0	-	-	-	35	0.15	1.0
	T9325	0.8	230	0.25	1.0	135	0.23	1.0	215	0.25	1.0	-	-	-	-	-	-

LCMF 16, LCMF 30 - MP



	CW	CWTOLL	CWTOLU	INSL
	[mm]	[mm]	[mm]	[mm]
0316	3.00	-0.05	0.05	17.5
0416	4.00	-0.05	0.05	17.6
0516	5.00	-0.05	0.05	18.3
0616	6.00	-0.05	0.05	18.5
0830	8.00	-0.05	0.05	30.9

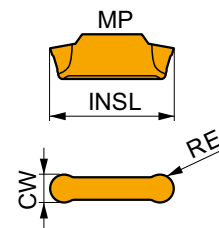

Suitability and starting values for cutting speed (vc), feed (f) and depth of cut (ap). Refer to our cutting conditions app for further options.

Product	RE	P			M			K			N			S			H		
		vc	f	ap	vc	f	ap	vc	f	ap	vc	f	ap	vc	f	ap	vc	f	ap
	[mm]	[m/min]	[mm/rev]	[mm]	[m/min]	[mm/rev]	[mm]	[m/min]	[mm/rev]	[mm]	[m/min]	[mm/rev]	[mm]	[m/min]	[mm/rev]	[mm]	[m/min]	[mm/rev]	[mm]

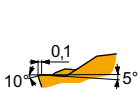

MP geometry for longitudinal turning and copy profiling, and continuous to interrupted cuts.

LCMF 0316M0-MP	T8330	1.5	190	0.30	0.8	110	0.27	0.8	180	0.30	0.8	-	-	-	-	-	-
LCMF 0416M0-MP	T8330	2.0	175	0.40	1.0	105	0.36	1.0	165	0.40	1.0	-	-	-	-	-	-
	T9325	2.0	220	0.40	1.0	130	0.36	1.0	205	0.40	1.0	-	-	-	-	-	-
LCMF 0516M0-MP	T8330	2.5	170	0.45	1.0	100	0.41	1.0	160	0.45	1.0	-	-	-	-	-	-
	T9325	2.5	205	0.45	1.0	120	0.41	1.0	190	0.45	1.0	-	-	-	-	-	-



Suitability and starting values for cutting speed (vc), feed (f) and depth of cut (ap). Refer to our cutting conditions app for further options.

Product	RE [mm]	P			M			K			N			S			H		
		vc [m/min]	f [mm/rev]	ap [mm]	vc [m/min]	f [mm/rev]	ap [mm]	vc [m/min]	f [mm/rev]	ap [mm]	vc [m/min]	f [mm/rev]	ap [mm]	vc [m/min]	f [mm/rev]	ap [mm]	vc [m/min]	f [mm/rev]	ap [mm]

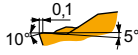

MP geometry for longitudinal turning and copy profiling, and continuous to interrupted cuts.

LCMF 0616MO-MP	T8330	3.0	165	0.50	1.0	95	0.45	1.0	155	0.50	1.0	—	—	—	—	—	—	—
	T9325	3.0	200	0.50	1.0	120	0.45	1.0	190	0.50	1.0	—	—	—	—	—	—	—
LCMF 0830MO-MP	T8330	4.0	150	0.60	1.2	90	0.54	1.2	140	0.60	1.2	—	—	—	—	—	—	—

LCMR 16 - CM



	CW [mm]	CWTOLL [mm]	CWTOLU [mm]	INSL [mm]
0316	3.00	-0.05	0.05	16.4
0416	4.00	-0.05	0.05	16.4

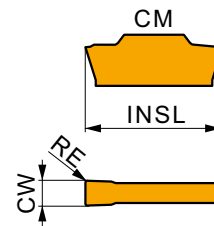

Suitability and starting values for cutting speed (vc) and feed (f). Refer to our Machining Calculator app for further calculations.

Product	RE [mm]	P		M		K		N		S		H		PSIRR [°]	PSIRL [°]
		vc [m/min]	f [mm/rev]	vc [m/min]	f [mm/rev]	vc [m/min]	f [mm/rev]	vc [m/min]	f [mm/rev]	vc [m/min]	f [mm/rev]				

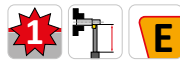

CM geometry, first choice for parting-off and grooving, and continuous to slightly interrupted cuts.

LCMR 031602-CM	T8330	0.2	130	0.11	75	0.10	120	0.11	—	—	—	—	—	—	—
LCMR 041604-CM	T8330	0.4	130	0.11	75	0.10	120	0.11	—	—	—	—	—	—	—



LCMR 16, LCMR 30 - F

	CW	CWTOLL	CWTOLU	INSL
	[mm]	[mm]	[mm]	[mm]
0316	3.00	-0.05	0.05	16.4
0416	4.00	-0.05	0.05	16.4
0516	5.00	-0.05	0.05	16.4
0616	6.00	-0.05	0.05	16.4
0830	8.00	-0.05	0.05	30.0

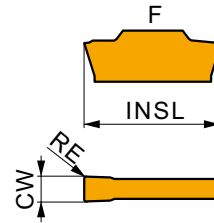

Suitability and starting values for cutting speed (vc), feed (f) and depth of cut (ap). Refer to our Machining Calculator app for further calculations.

Product	RE	P			M			K			N			S			H		
		vc	f	ap	vc	f	ap	vc	f	ap	vc	f	ap	vc	f	ap	vc	f	ap
	[mm]	[m/min]	[mm/rev]	[mm]	[m/min]	[mm/rev]	[mm]	[m/min]	[mm/rev]	[mm]	[m/min]	[mm/rev]	[mm]	[m/min]	[mm/rev]	[mm]	[m/min]	[mm/rev]	[mm]

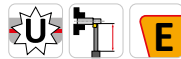
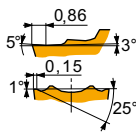

F geometry for parting-off, grooving and longitudinal turning, fine and finish machining, and continuous to slightly interrupted cuts.

LCMR 031604-F	T8330	0.4	200	0.10	0.5	120	0.09	0.5	190	0.10	0.5	-	-	-	-	-	-	-	-
LCMR 041604-F	T8330	0.4	185	0.13	0.5	110	0.12	0.5	175	0.13	0.5	-	-	-	-	-	-	-	-
LCMR 051604-F	T8330	0.4	180	0.15	0.5	105	0.14	0.5	170	0.15	0.5	-	-	-	-	-	-	-	-
LCMR 061608-F	T8330	0.8	190	0.17	1.0	110	0.15	1.0	180	0.17	1.0	-	-	-	-	-	-	-	-

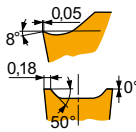

F geometry for parting-off, grooving and longitudinal turning, fine and finish machining, and continuous to slightly interrupted cuts.

LCMR 083008-F	T8330	0.8	175	0.25	1.0	105	0.23	1.0	165	0.25	1.0	-	-	-	-	-	-	-	-
---------------	-------	-----	-----	------	-----	-----	------	-----	-----	------	-----	---	---	---	---	---	---	---	---

LCMR 16 - M

	CW	CWTOLL	CWTOLU	INSL
	[mm]	[mm]	[mm]	[mm]
0316	3.00	-0.05	0.05	16.4
0416	4.00	-0.05	0.05	16.4
0516	5.00	-0.05	0.05	16.4
0616	6.00	-0.05	0.05	16.4

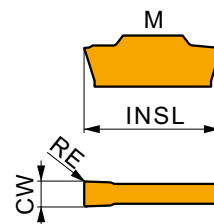

Suitability and starting values for cutting speed (vc), feed (f) and depth of cut (ap). Refer to our Machining Calculator app for further calculations.

Product	RE	P			M			K			N			S			H		
		vc	f	ap	vc	f	ap	vc	f	ap	vc	f	ap	vc	f	ap	vc	f	ap
	[mm]	[m/min]	[mm/rev]	[mm]	[m/min]	[mm/rev]	[mm]	[m/min]	[mm/rev]	[mm]	[m/min]	[mm/rev]	[mm]	[m/min]	[mm/rev]	[mm]	[m/min]	[mm/rev]	[mm]

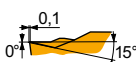
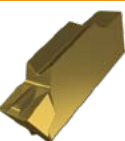

M geometry for grooving and longitudinal turning, and continuous to interrupted cuts.

LCMR 031604-M	T8330	0.4	170	0.13	1.0	100	0.12	1.0	160	0.13	1.0	-	-	-	-	-	-	30	0.15	1.0
LCMR 041604-M	T8330	0.4	155	0.18	1.0	90	0.16	1.0	145	0.18	1.0	-	-	-	-	-	-	30	0.15	1.0
LCMR 051604-M	T8330	0.4	150	0.20	1.0	90	0.18	1.0	140	0.20	1.0	-	-	-	-	-	-	30	0.15	1.0
LCMR 061608-M	T8330	0.8	175	0.25	1.0	105	0.23	1.0	165	0.25	1.0	-	-	-	-	-	-	35	0.15	1.0



LCMR 16 - MP

	CW	CWTOLL	CWTOLU	INSL
	[mm]	[mm]	[mm]	[mm]
0316	3.00	-0.05	0.05	17.4
0416	4.00	-0.05	0.05	17.5
0516	5.00	-0.05	0.05	18.1
0616	6.00	-0.05	0.05	18.3

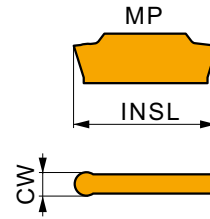

Suitability and starting values for cutting speed (vc), feed (f) and depth of cut (ap). Refer to our Machining Calculator app for further calculations.

Product	RE [mm]	P			M			K			N			S			H		
		vc [m/min]	f [mm/rev]	ap [mm]	vc [m/min]	f [mm/rev]	ap [mm]	vc [m/min]	f [mm/rev]	ap [mm]	vc [m/min]	f [mm/rev]	ap [mm]	vc [m/min]	f [mm/rev]	ap [mm]	vc [m/min]	f [mm/rev]	ap [mm]

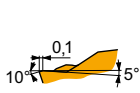

MP geometry for longitudinal turning and copy profiling, and continuous to interrupted cuts.

LCMR 0316MO-MP	T8330	1.5	■ 190	0.30	0.8	☑ 110	0.27	0.8	■ 180	0.30	0.8	—	—	—	—	—	—	—	—
LCMR 0416MO-MP	T8330	2.0	■ 175	0.40	1.0	☑ 105	0.36	1.0	■ 165	0.40	1.0	—	—	—	—	—	—	—	—
LCMR 0516MO-MP	T8330	2.5	■ 170	0.45	1.0	☑ 100	0.41	1.0	■ 160	0.45	1.0	—	—	—	—	—	—	—	—
LCMR 0616MO-MP	T8330	3.0	■ 165	0.50	1.0	☑ 95	0.45	1.0	■ 155	0.50	1.0	—	—	—	—	—	—	—	—



GFI(RL) EXT

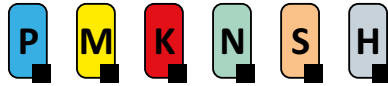

PRAMET

G





External V-Groove Top Clamp Grooving and Turning Tool for LCM. Inserts

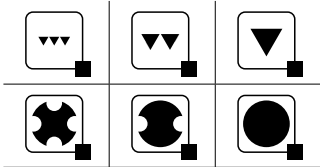
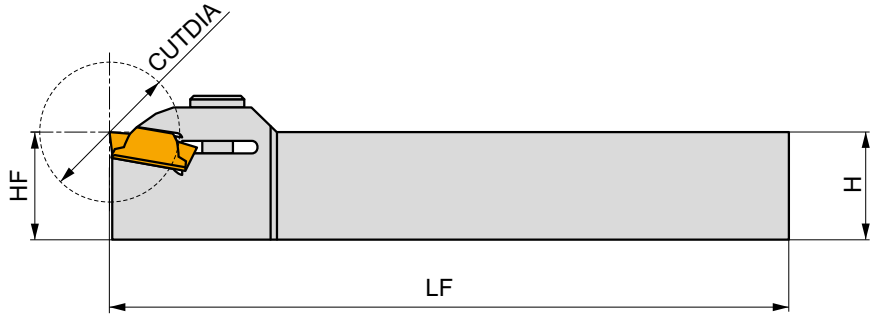
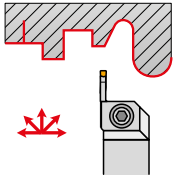





External Right/Left hand tool holder for grooving with LCM. 0316, 0416, 0516, 0616 and 0830 inserts. Suited for parting-off up to maximum of Ø48 mm material in grooving, profiling and longitudinal turning applications. Available with shank size 16x16 up to 32x25 mm. Body treated for longer tool life.



	Product	≡	H	B	L	CW	CUTDIA	kg		
		[mm]	[mm]	[mm]	[mm]	[mm]	[mm]			
R	GFIR 1616 H 03	16	16	16	100	3.00	18	0.22	G1136	GL03
	GFIR 2020 K 03	20	20	20	125	3.00	18	0.40	G1136	GL04
	GFIR 2525 M 03	25	25	25	150	3.00	18	0.73	G1136	GL05
	GFIR 1616 H 04	16	16	16	100	4.00	24	0.22	G1137	GL03
	GFIR 2020 K 04	20	20	20	125	4.00	24	0.38	G1137	GL04
	GFIR 2525 M 04	25	25	25	150	4.00	24	0.67	G1137	GL05
	GFIR 2020 K 05	20	20	20	125	5.00	28	0.38	G1138	GL04
	GFIR 2525 M 05	25	25	25	150	5.00	28	0.70	G1138	GL05
	GFIR 2020 K 06	20	20	20	125	6.00	28	0.38	G1139	GL04
	GFIR 2525 M 06	25	25	25	150	6.00	28	0.70	G1139	GL05
	GFIR 2525 M 08	25	25	25	150	8.00	48	0.74	G1193	GL09
	GFIR 3225 P 08	32	32	25	170	8.00	48	1.03	G1193	GL09
L	GFIL 1616 H 03	16	16	16	100	3.00	18	0.22	G1136	GL03
	GFIL 2020 K 03	20	20	20	125	3.00	18	0.39	G1136	GL04
	GFIL 2525 M 03	25	25	25	150	3.00	18	0.73	G1136	GL05
	GFIL 1616 H 04	16	16	16	100	4.00	24	0.20	G1137	GL03
	GFIL 2020 K 04	20	20	20	125	4.00	24	0.38	G1137	GL04
	GFIL 2525 M 04	25	25	25	150	4.00	24	0.69	G1137	GL05
	GFIL 2020 K 05	20	20	20	125	5.00	28	0.38	G1138	GL04
	GFIL 2525 M 05	25	25	25	150	5.00	28	0.71	G1138	GL05
	GFIL 2020 K 06	20	20	20	125	6.00	28	0.40	G1139	GL04
	GFIL 2525 M 06	25	25	25	150	6.00	28	0.70	G1139	GL05
	GFIL 2525 M 08	25	25	25	150	8.00	48	0.75	G1193	GL09
	GFIL 3225 P 08	32	32	25	170	8.00	48	1.03	G1193	GL09



	
GI136	LCM. 0316..
GI137	LCM. 0416..
GI138	LCM. 0516..
GI139	LCM. 0616..
GI193	LCM. 0830..

					
GL03	HS 0616C	6.0	M 6	16	HXX 5
GL04	HS 0620C	6.0	M 6	20	HXX 5
GL05	HS 0625C	6.0	M 6	25	HXX 5
GL09	HSI 1020	8.0	M 10	20	HXX 8



GFM(RL) EXT

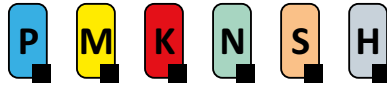

PRAMET

G



External V-Groove Top Clamp Grooving and Turning Tool for LCM. Inserts

External Right/Left hand tool holder for grooving with LCM. 0316, 0416, 0516, 0616 and 0830 inserts. Suited for parting-off up to maximum of Ø30 to Ø80 mm material in grooving, profiling and longitudinal turning applications. Available with shank size 20x20 up to 32x25 mm. Body treated for longer tool life.

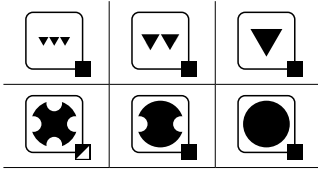
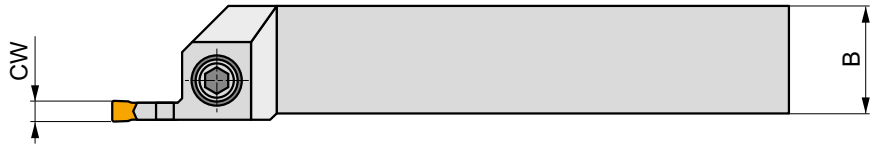
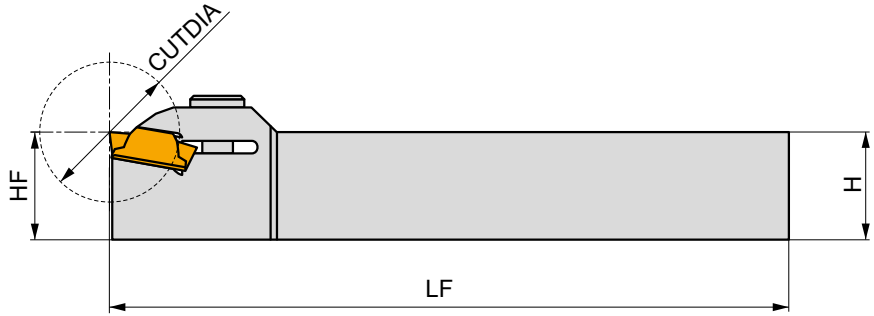
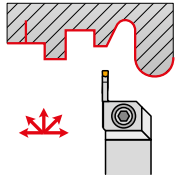

	Product	HF	H	B	LF	CW	CUTDIA	kg	G1	GL
		[mm]	[mm]	[mm]	[mm]	[mm]	[mm]			
R	GFMR 2020 K 0316	20	20	20	125	3.00	30	0.37	G1136	GL04
	GFMR 2525 M 0316	25	25	25	150	3.00	30	0.68	G1136	GL04
	GFMR 2020 K 0416	20	20	20	125	4.00	40	0.38	G1137	GL04
	GFMR 2525 M 0416	25	25	25	150	4.00	40	0.68	G1137	GL04
	GFMR 2525 M 0516	25	25	25	150	5.00	50	0.67	G1138	GL04
	GFMR 3225 P 0516	32	32	25	170	5.00	50	0.97	G1138	GL04
	GFMR 2525 M 0616	25	25	25	150	6.00	60	0.66	G1139	GL04
	GFMR 3225 P 0616	32	32	25	170	6.00	60	0.97	G1139	GL04
L	GFMR 3225 P 0830	32	32	25	170	8.00	80	0.97	G1193	GL10
	GFML 2020 K 0316	20	20	20	125	3.00	30	0.24	G1136	GL04
	GFML 2525 M 0316	25	25	25	150	3.00	30	0.70	G1136	GL04
	GFML 2020 K 0416	20	20	20	125	4.00	40	0.37	G1137	GL04
	GFML 2525 M 0416	25	25	25	150	4.00	40	0.69	G1137	GL04
	GFML 2525 M 0516	25	25	25	150	5.00	50	0.64	G1138	GL04
	GFML 3225 P 0516	32	32	25	170	5.00	50	0.97	G1138	GL04
	GFML 2525 M 0616	25	25	25	150	6.00	60	0.64	G1139	GL04
GFML 3225 P 0616	32	32	25	170	6.00	60	0.95	G1139	GL04	
	GFML 3225 P 0830	32	32	25	170	8.00	80	0.99	G1193	GL10



G1136	LCM. 0316..
G1137	LCM. 0416..
G1138	LCM. 0516..
G1139	LCM. 0616..
G1193	LCM. 0830..



GL04	HS 0620C	6.0	M 6	20	HXK 5
GL10	HSI 1020	8.0	M 10	20	HXK 8



XLCCN B



PRAMET



Double-Ended Parting-off Blade for LCM. Inserts

Blade for parting-off applications up to 60 mm maximum depth or Ø120 mm bar material. Suited for single or double sided LCM. inserts. Available in height of 26 or 32 mm. Can be fitted into the DU Pramet basic holders. Blade treated for longer tool life.

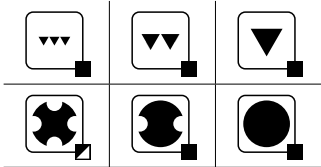
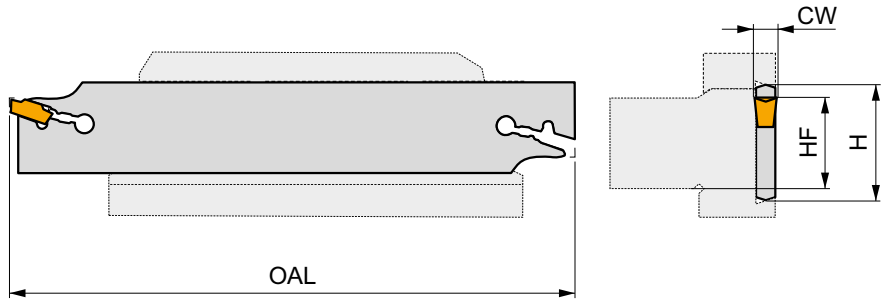
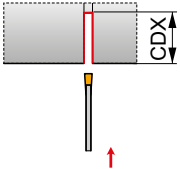

Product	Ξ	H	L _F	CW	CDX	kg		
	[mm]	[mm]	[mm]	[mm]	[mm]			
N XLCCN 2602 J 0316	21.4	26	110	3.00	35	0.09	G136	KV1
XLCCN 3202 M 0316	25	32	150	3.00	50	0.13	G136	KV1
XLCCN 3203 M 0416	25	32	150	4.00	50	0.15	G137	KV1
XLCCN 3204 M 0516	25	32	150	5.00	60	0.18	G138	KV1
XLCCN 3205 M 0616	25	32	150	6.00	60	0.17	G139	KV1

G136	LCM. 0316..
G137	LCM. 0416..
G138	LCM. 0516..
G139	LCM. 0616..

KV1	KV 5x100



DU, D

Tool Holder Block for Parting-off Blades

Tool holder to fit GL or XLC. blades for parting-off. Available with shank size 20x20 up to 40x40 mm. Body treated for longer tool life.

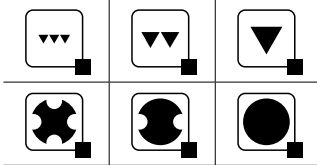
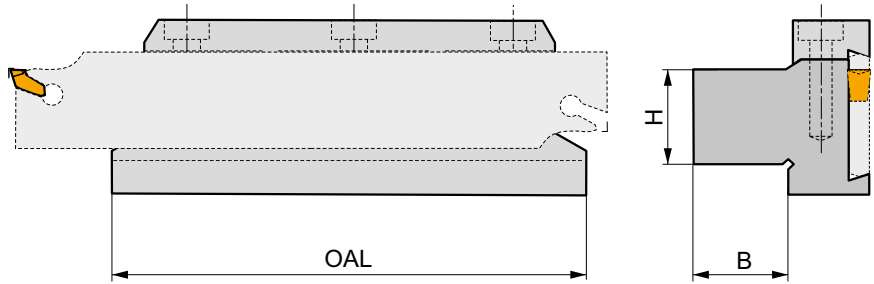
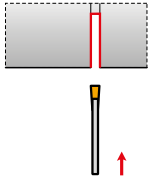

Product	H [mm]	B [mm]	LB [mm]	kg		
26-DU 2020	20	20	90	0.70	GI007	ND2
26-D 2020	20	20	100	0.82	GI007	ND2
32-DU 2523	25	23	110	1.02	GI008	ND2
32-DU 2532	25	32	110	1.10	GI008	ND2
32-DU 3229	32	29	110	1.25	GI008	ND2
32-D 2530	25	30	115	1.30	GI008	ND2
45-DU 3229	32	29	110	1.50	GI009	ND7
45-DU 4036	40	36	110	2.05	GI009	ND7
47-D 4040	40	40	150	3.88	GI091	ND3

GI007	XLC.N 26..	GL.-S26.B
GI008	XLC.N 32..	GL.-S32.B
GI009	XLC.N 45..	-
GI091	XLC.N 47..	-

ND2	HS 0625	6.0	M 6	25	HXK 5
ND3	HS 1030	8.0	M 10	30	HXK 8
ND7	HS 0630	6.0	M 6	30	HXK 5



XLCCN 25 BS

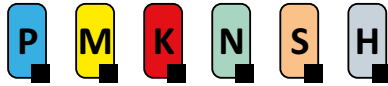

PRAMET

G



Radial Grooving Blade for Modular MS-EN Tool Holder for LCM. Inserts

Modular grooving blade for grooving with single or double-sided LCM. 0316, 0416, 0516 or 0616 inserts. Suited for grooving or parting-off (max. 25 mm cutting depth) applications. Can be fitted to MS-EN tool holder. Blades treated for longer tool life.

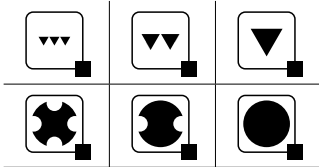
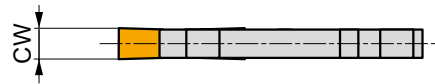
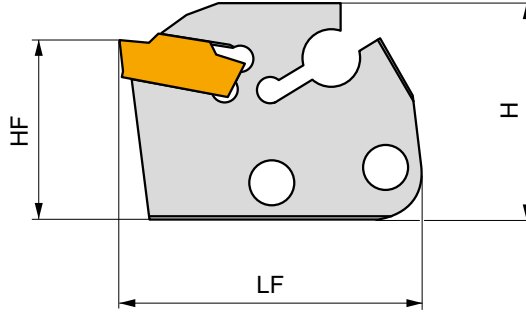
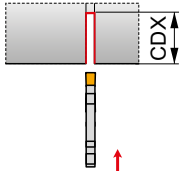

Product	Ξ	H	LF	CW	CDX	kg		
	[mm]	[mm]	[mm]	[mm]	[mm]			
N XLCCN 250215-0316	24	29	40	3.00	15	0.01	G136	-
XLCCN 250225-0316	24	29	50	3.00	25	0.02	G136	-
XLCCN 250315-0416	24	29	40	4.00	15	0.04	G137	-
XLCCN 250325-0416	24	29	50	4.00	25	0.04	G137	-
XLCCN 250425-0516	24	29	50	5.00	25	0.03	G138	-
XLCCN 250525-0616	24	29	50	6.00	25	0.04	G139	-

G136	LCM. 0316..
G137	LCM. 0416..
G138	LCM. 0516..
G139	LCM. 0616..



MS-EN



Modular Tool Holder for XLCCN, XLCF(NRL) or XLXFL Grooving Blade

Tool holder to fit modular grooving blades from the XLC 25 BS, XLCF(NRL) BS, XLXFL BS axial grooving blade. Available with shank size 12x12 up to 32x25 mm. Body treated for longer tool life.

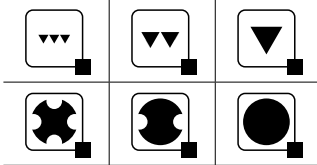
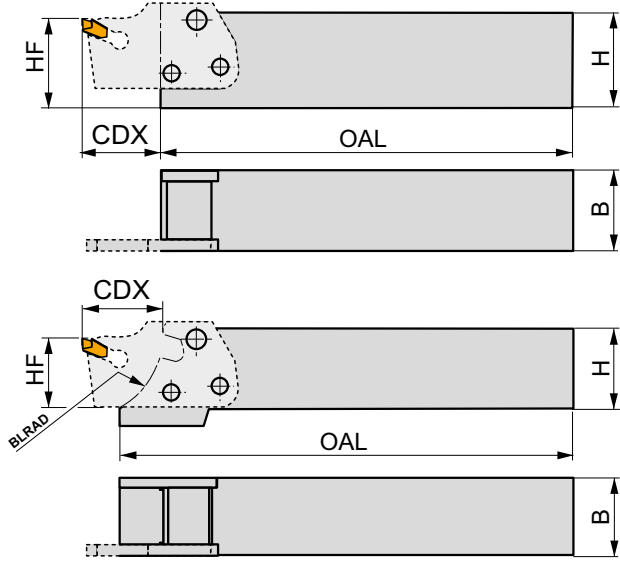
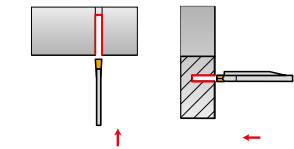

Product	HF [mm]	H [mm]	B [mm]	OAL [mm]	CDX [mm]	BLRAD [mm]	kg		
MS-EN-1212 F	12	12	12	75	15	-	0.13	GI006	ND4
MS-EN-1616 H	16	16	16	90	15	-	0.21	GI006	ND4
MS-EN-2020 K	20	20	20	115	15	-	0.23	GI003	ND5
MS-EN-2020 KS	20	20	20	129	15	25	0.42	GI060	ND5
MS-EN-2525 M	25	25	25	140	15	-	0.65	GI003	ND5
MS-EN-2525 MS	25	25	25	153	15	25	0.74	GI060	ND5
MS-EN-3225 P	32	32	25	160	15	-	0.95	GI003	ND5
MS-EN-3225 PS	32	32	25	174	15	25	1.00	GI060	ND5

GI003	XLC.. 25..15...	XLXFL 25...	XLC.. 25..25...
GI006	XLCF. 16..15...	XLCF. 16..20...	-
GI060	XLC.. 25..15...	XLC.. 25..25...	-

ND4	US 4011-T15P	3.5	M 4	10.6	-	-	-	-	FLAG T15P
ND5	US 45013-T20P	5.0	M 5	13	US 46017-T20P	5.0	M6	17	FLAG T15P

ND4 = 3 x US 4011-T15P; ND5 = 2 x US 45013-T20P



GFIL-L AXIAL

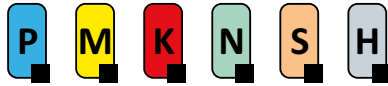

PRAMET

G



External Axial V-Groove Top Clamp Grooving Tool for LCM. 03 Inserts

External left-hand axial tool holder for grooving with single or double-sided LCM. 0313 or 0316 inserts. Suited for axial grooving, axial profiling or groove widening Ø17 up to Ø170 mm applications with maximum depth of cut 9 mm. Available with shank size 25x25 mm. Body treated for longer tool life.

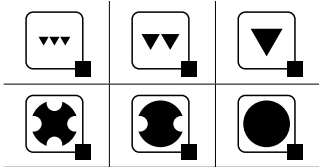
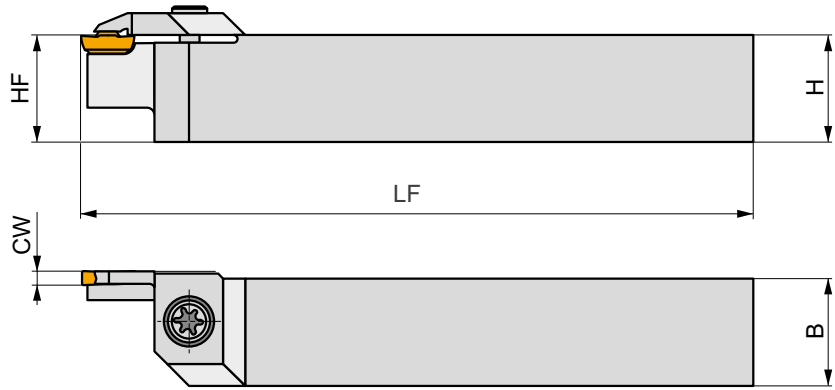
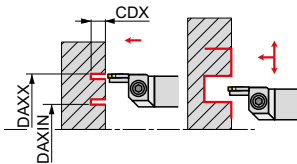

Product	HF	H	B	LF	CW	CDX	DAXIN	DAXX	kg	G136	G143
	[mm]	[mm]	[mm]	[mm]	[mm]	[mm]	[mm]				
L GFIL 2525 M 0313L 030017	25	25	25	150	3.00	9	17	30	0.64	G143	GL02
GFIL 2525 M 0313L 039024	25	25	25	150	3.00	9	24	39	0.66	G143	GL07
GFIL 2525 M 0313L 050033	25	25	25	150	3.00	9	33	50	0.67	G143	GL07
GFIL 2525 M 0313L 060043	25	25	25	150	3.00	9	43	60	0.67	G143	GL07
GFIL 2525 M 0313L 076053	25	25	25	150	3.00	9	53	76	0.67	G143	GL07
GFIL 2525 M 0316L 100070	25	25	25	150	3.00	9	70	100	0.69	G136	GL07
GFIL 2525 M 0316L 130090	25	25	25	150	3.00	9	90	130	0.70	G136	GL07
GFIL 2525 M 0316L 170110	25	25	25	150	3.00	9	110	170	0.71	G136	GL07

G136		G143	
LCM. 0316..		LCM. 0313..	

GL02	GL07	Nm	mm	mm	mm
US 5015-T20P	US 5018-T20P	5.0	M 5	15	18.2
		5.0	M 5		



GFIL-R AXIAL

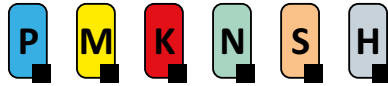

PRAMET

G



External Axial V-Groove Top Clamp Grooving Tool for LCM. 03 or 04 Inserts

External left-hand axial tool holder for grooving with single or double-sided LCM. 0313, 0316, 0413 or 0416 inserts. Suited for axial grooving, axial profiling or groove widening Ø17 up to Ø230 mm applications, with maximum depth of cut 12 mm. Available with shank size 25x25. Body treated for longer tool life.

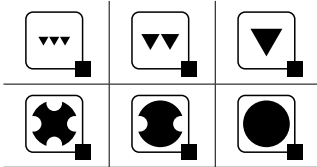
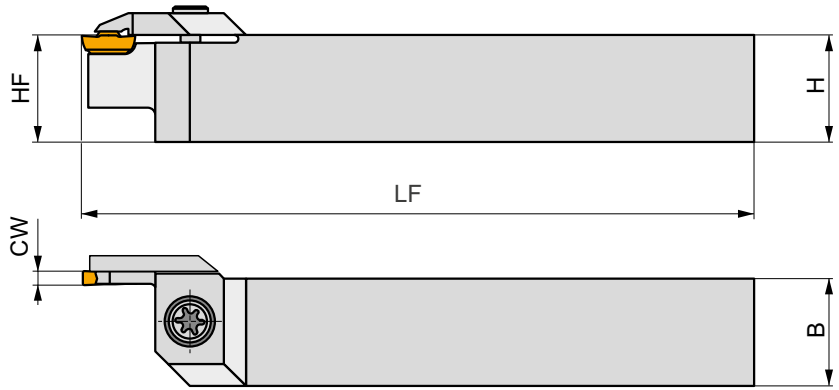
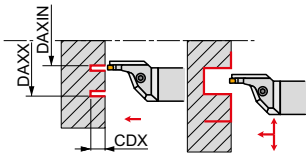

Product	HF	H	B	LF	CW	CDX	DAXIN	DAXX	kg	Icon 1	Icon 2
	[mm]	[mm]	[mm]	[mm]	[mm]	[mm]		[mm]			
L GFIL 2525 M 03R 030017-A	25	25	25	150	3.00	9	17	30	0.69	GI143	GL07
GFIL 2525 M 03R 039024-A	25	25	25	150	3.00	9	24	39	0.69	GI143	GL07
GFIL 2525 M 03R 050033-A	25	25	25	150	3.00	9	33	50	0.72	GI143	GL07
GFIL 2525 M 03R 060043-A	25	25	25	150	3.00	9	43	60	0.69	GI143	GL07
GFIL 2525 M 03R 076053-A	25	25	25	150	3.00	9	53	76	0.68	GI143	GL07
GFIL 2525 M 03R 100070-A	25	25	25	150	3.00	9	70	100	0.79	GI136	GL08
GFIL 2525 M 03R 130090-A	25	25	25	150	3.00	9	90	130	0.73	GI136	GL08
GFIL 2525 M 03R 170110-A	25	25	25	150	3.00	9	110	170	0.76	GI136	GL08
GFIL 2525 M 04R 030017-A	25	25	25	150	3.00	9	17	30	0.71	GI170	GL07
GFIL 2525 M 04R 034021-A	25	25	25	150	4.00	9	21	34	0.69	GI170	GL07
GFIL 2525 M 04R 040026-A	25	25	25	150	4.00	11	26	40	0.00	GI170	GL07
GFIL 2525 M 04R 050032-A	25	25	25	150	4.00	11	32	50	0.68	GI170	GL07
GFIL 2525 M 04R 060042-A	25	25	25	150	4.00	11	42	60	0.66	GI170	GL07
GFIL 2525 M 04R 075052-A	25	25	25	150	4.00	11	52	75	0.67	GI170	GL07
GFIL 2525 M 04R 100070-A	25	25	25	150	4.00	12	70	100	0.75	GI137	GL08
L GFIL 2525 M 04R 130090-A	25	25	25	150	4.00	12	90	130	0.75	GI137	GL08
GFIL 2525 M 04R 170110-A	25	25	25	150	4.00	12	110	170	0.75	GI137	GL08
GFIL 2525 M 04R 230140-A	25	25	25	150	4.00	12	140	230	0.78	GI137	GL08



GI136
GI137
GI143
GI170

LCM. 0316..
LCM. 0416..
LCM. 0313..
LCM. 0413..



GL07
GL08

US 5018-T20P
US 6020-T25P

5.0
6.0

M 5
M 6

18.2
20.2

FLAGT20P
-

-
SDRT25P



GFIR-L AXIAL



PRAMET

G



External Axial V-Groove Top Clamp Grooving Tool for LCM. 03 or 04 Inserts

External right-hand axial tool holder for grooving with single or double-sided LCM. 0313, 0316, 0413 or 0416 inserts. Suited for axial grooving, axial profiling or groove widening Ø17 up to Ø230 mm applications, with maximum depth of cut 12 mm. Available with shank size 25x25 mm. Body treated for longer tool life.

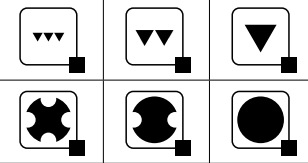
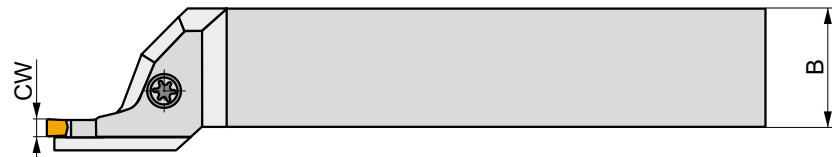
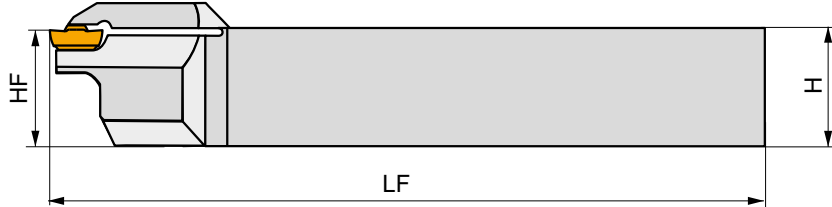
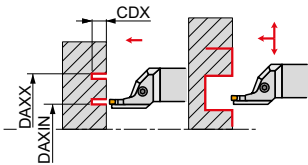

Product	⌀	H	B	LF	CW	CDX	DAXIN	DAXX	kg	Icon 1	Icon 2
	[mm]	[mm]	[mm]	[mm]	[mm]	[mm]		[mm]			
R GFIR 2525 M 03L 030017-A	25	25	25	150	3.00	9	17	30	0.65	GI143	GL07
GFIR 2525 M 03L 039024-A	25	25	25	150	3.00	9	24	39	0.68	GI143	GL07
GFIR 2525 M 03L 050033-A	25	25	25	150	3.00	9	33	50	0.65	GI143	GL07
GFIR 2525 M 03L 060043-A	25	25	25	150	3.00	9	43	60	0.68	GI143	GL07
GFIR 2525 M 03L 076053-A	25	25	25	150	3.00	9	53	76	0.69	GI143	GL07
GFIR 2525 M 03L 100070-A	25	25	25	150	3.00	9	70	100	0.75	GI136	GL08
GFIR 2525 M 03L 130090-A	25	25	25	150	3.00	9	90	130	0.76	GI136	GL08
GFIR 2525 M 03L 170110-A	25	25	25	150	3.00	9	110	170	0.68	GI136	GL08
GFIR 2525 M 04L 030017-A	25	25	25	150	3.00	9	17	30	0.68	GI170	GL07
GFIR 2525 M 04L 034021-A	25	25	25	150	4.00	9	21	34	0.68	GI170	GL07
GFIR 2525 M 04L 040026-A	25	25	25	150	4.00	11	26	40	0.68	GI170	GL07
GFIR 2525 M 04L 050032-A	25	25	25	150	4.00	11	32	50	0.66	GI170	GL07
GFIR 2525 M 04L 060042-A	25	25	25	150	4.00	11	42	60	0.69	GI170	GL07
GFIR 2525 M 04L 075052-A	25	25	25	150	4.00	11	52	75	0.67	GI170	GL07
GFIR 2525 M 04L 100070-A	25	25	25	150	4.00	12	70	100	0.72	GI137	GL08
R GFIR 2525 M 04L 130090-A	25	25	25	150	4.00	12	90	130	0.75	GI137	GL08
GFIR 2525 M 04L 170110-A	25	25	25	150	4.00	12	110	170	0.72	GI137	GL08
GFIR 2525 M 04L 230140-A	25	25	25	150	4.00	12	140	230	0.79	GI137	GL08

Icon	LCM. 0316..
GI136	LCM. 0316..
GI137	LCM. 0416..
GI143	LCM. 0313..
GI170	LCM. 0413..

Icon 1	Icon 2	Nm	Icon 3	Icon 4	Icon 5	Icon 6
GL07	US 5018-T20P	5.0	M 5	18.2	FLAG T20P	-
GL08	US 6020-T25P	6.0	M 6	20.2	-	SDRT25P



GFIR-R AXIAL

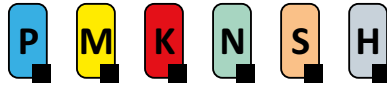

PRAMET

G



External Axial V-Groove Top Clamp Grooving Tool for LCM. 03 Inserts

External right-hand axial tool holder for grooving with single or double-sided LCM. 0313 or 0316 inserts. Suited for axial grooving, axial profiling or groove widening $\varnothing 17$ up to $\varnothing 170$ mm applications, with maximum depth of cut 9 mm. Available with shank size 25x25 mm. Body treated for longer tool life.

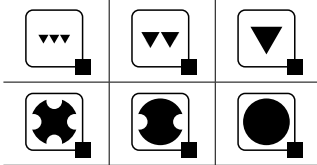
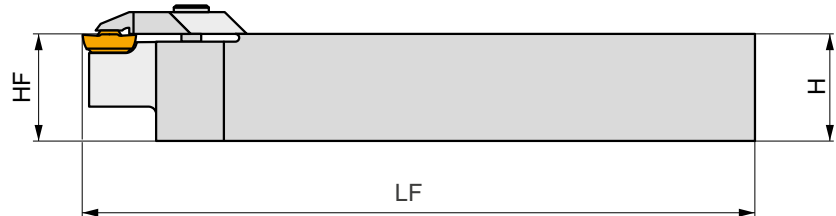
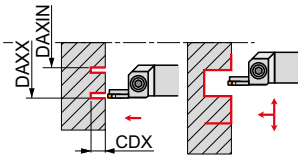

Product	\varnothing	H	B	LF	CW	CDX	DAXIN	DAXX	kg	G1136 G1143	GL02 GL07	
	[mm]	[mm]	[mm]	[mm]	[mm]	[mm]	[mm]					
R	GFIR 2525 M 0313R 030017	25	25	25	150	3.00	9	17	30	0.65	G1143	GL02
	GFIR 2525 M 0313R 039024	25	25	25	150	3.00	9	24	39	0.66	G1143	GL07
	GFIR 2525 M 0313R 050033	25	25	25	150	3.00	9	33	50	0.68	G1143	GL07
	GFIR 2525 M 0313R 060043	25	25	25	150	3.00	9	43	60	0.68	G1143	GL07
	GFIR 2525 M 0313R 076053	25	25	25	150	3.00	9	53	76	0.68	G1143	GL07
	GFIR 2525 M 0316R 100070	25	25	25	150	3.00	9	70	100	0.69	G1136	GL07
	GFIR 2525 M 0316R 130090	25	25	25	150	3.00	9	90	130	0.70	G1136	GL07
	GFIR 2525 M 0316R 170110	25	25	25	150	3.00	9	110	170	0.70	G1136	GL07



G1136
G1143

LCM. 0316..
LCM. 0313..



GL02
GL07

US 5015-T20P
US 5018-T20P

5.0
5.0

M 5
M 5

15
18.2

FLAG T20P
FLAG T20P



GFML-L AXIAL



PRAMET

G



External Axial V-Groove Top Clamp Grooving Tool for LCM. 04 Inserts

External left-hand axial tool holder for grooving with single or double-sided LCM. 0413 or 0416 inserts. Suited for deep axial grooving, axial profiling or groove widening $\varnothing 17$ up to $\varnothing 230$ mm applications, with maximum depth of cut 20 mm. Available with shank size 25x25 mm. Body treated for longer tool life.

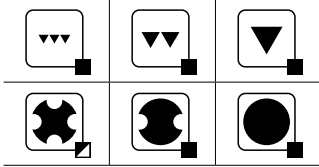
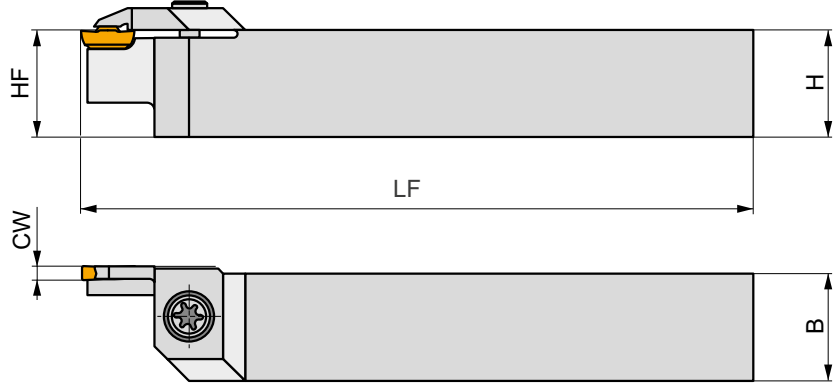
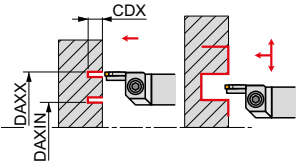

Product	HF	H	B	LF	CW	CDX	DAXIN	DAXX	kg	G1170	G1170
	[mm]	[mm]	[mm]	[mm]	[mm]	[mm]	[mm]	[mm]			
GFML 2525 M 0413L 030017	25	25	25	150	4.00	20	17	30	0.62	G1170	GL02
GFML 2525 M 0413L 034021	25	25	25	150	4.00	20	21	34	0.63	G1170	GL07
GFML 2525 M 0413L 040026	25	25	25	150	4.00	20	26	40	0.65	G1170	GL07
GFML 2525 M 0413L 050032	25	25	25	150	4.00	20	32	50	0.64	G1170	GL07
GFML 2525 M 0413L 060042	25	25	25	150	4.00	20	42	60	0.65	G1170	GL07
GFML 2525 M 0413L 075052	25	25	25	150	4.00	20	52	75	0.66	G1170	GL07
GFML 2525 M 0416L 100070	25	25	25	150	4.00	20	70	100	0.66	G1137	GL07
GFML 2525 M 0416L 130090	25	25	25	150	4.00	20	90	130	0.67	G1137	GL07
GFML 2525 M 0416L 170110	25	25	25	150	4.00	20	110	170	0.67	G1137	GL07
GFML 2525 M 0416L 230140	25	25	25	150	4.00	20	140	230	0.67	G1137	GL07



G1137

LCM. 0416..

G1170

LCM. 0413..



GL02

US 5015-T20P

5.0

M 5

15

FLAG T20P

GL07

US 5018-T20P

5.0

M 5

18.2

FLAG T20P



GFML-R AXIAL

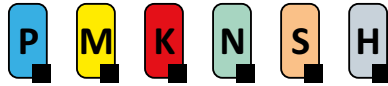

PRAMET

G



External Axial V-Groove Top Clamp Grooving Tool for LCM. 04 Inserts

External left-hand axial tool holder for grooving with single or double-sided LCM. 0413 or 0416 inserts. Suited for deep axial grooving, axial profiling or groove widening Ø17 up to Ø230 mm applications, with maximum depth of cut 20 mm. Available with shank size 25x25 mm. Body treated for longer tool life.

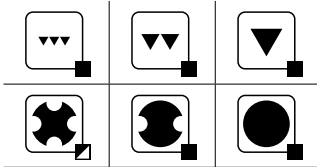
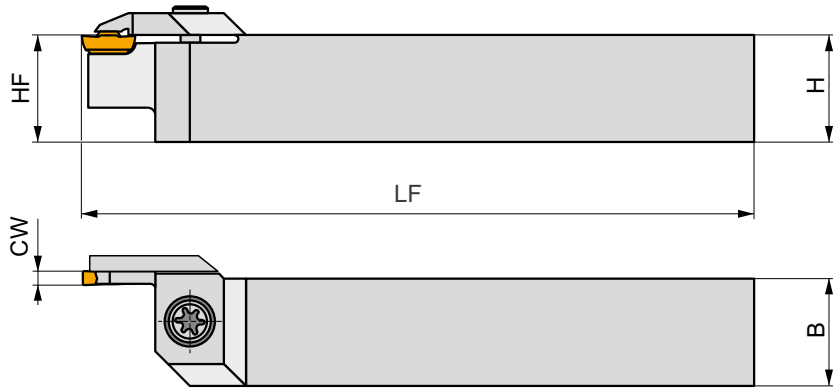
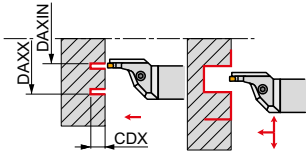

Product	HF	H	B	LF	CW	CDX	DAXIN	DAXX	kg	G1	G2	
	[mm]	[mm]	[mm]	[mm]	[mm]	[mm]	[mm]	[mm]				
L	GFML 2525 M 0413R 030017	25	25	25	150	4.00	20	17	30	0.68	G1170	GL07
	GFML 2525 M 0413R 034021	25	25	25	150	4.00	20	21	34	0.69	G1170	GL07
	GFML 2525 M 0413R 040026	25	25	25	150	4.00	20	26	40	0.69	G1170	GL07
	GFML 2525 M 0413R 050032	25	25	25	150	4.00	20	32	50	0.68	G1170	GL07
	GFML 2525 M 0413R 060042	25	25	25	150	4.00	20	42	60	0.69	G1170	GL07
	GFML 2525 M 0413R 075052	25	25	25	150	4.00	20	52	75	0.69	G1170	GL07
	GFML 2525 M 0416R 100070	25	25	25	150	4.00	20	70	100	0.80	G1137	GL08
	GFML 2525 M 0416R 130090	25	25	25	150	4.00	20	90	130	0.78	G1137	GL08
	GFML 2525 M 0416R 170110	25	25	25	150	4.00	20	110	170	0.78	G1137	GL08
	GFML 2525 M 0416R 230140	25	25	25	150	4.00	20	140	230	0.78	G1137	GL08

Product	LCM
G1137	LCM. 0416..
G1170	LCM. 0413..

Product	Tool	Nm	Thread	Length	Clamp	Wrench
GL07	US 5018-T20P	5.0	M 5	18.2	FLAGT20P	-
GL08	US 6020-T25P	6.0	M 6	20.2	-	SDRT25P



GFMR-L AXIAL

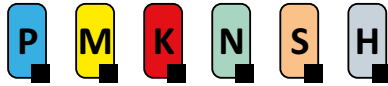

PRAMET

G



External Axial V-Groove Top Clamp Grooving Tool for LCM. 04 Inserts

External right-hand axial tool holder for grooving with single or double-sided LCM. 0413 or 0416 inserts. Suited for deep axial grooving, axial profiling or groove widening $\varnothing 17$ up to $\varnothing 230$ mm applications, with maximum depth of cut 20 mm. Available with shank size 25x25 mm. Body treated for longer tool life.

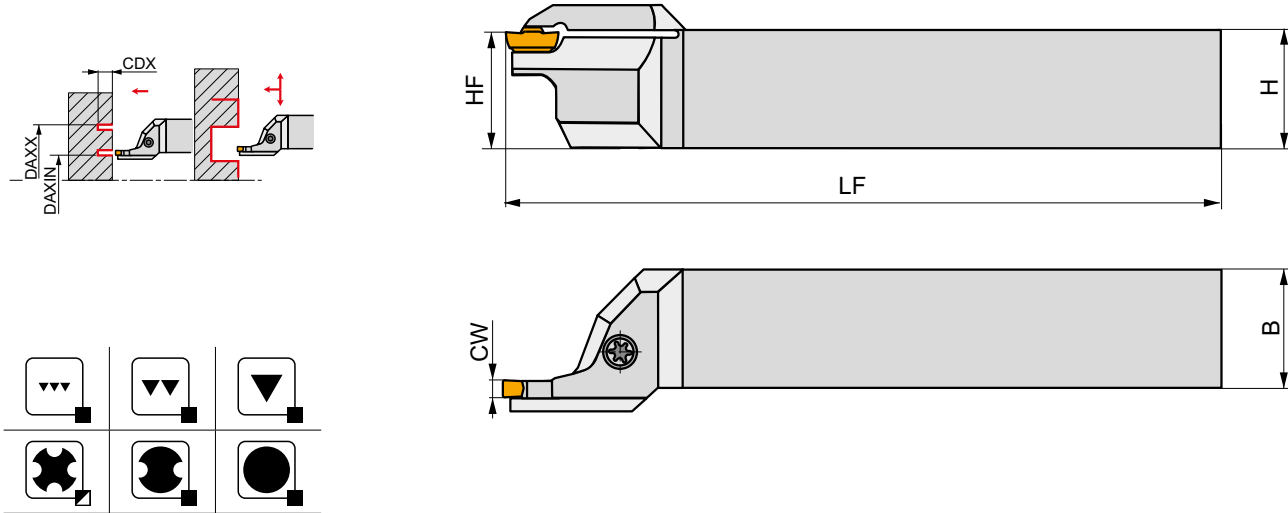

Product	\varnothing	H	B	LF	CW	CDX	DAXIN	DAXX	kg	G1	G2
	[mm]	[mm]	[mm]	[mm]	[mm]	[mm]	[mm]				
GFMR 2525 M 0413L 030017	25	25	25	150	4.00	20	17	30	0.70	G1170	GL07
GFMR 2525 M 0413L 034021	25	25	25	150	4.00	20	21	34	0.66	G1170	GL07
GFMR 2525 M 0413L 040026	25	25	25	150	4.00	20	26	40	0.66	G1170	GL07
GFMR 2525 M 0413L 050032	25	25	25	150	4.00	20	32	50	0.68	G1170	GL07
GFMR 2525 M 0413L 060042	25	25	25	150	4.00	20	42	60	0.66	G1170	GL07
GFMR 2525 M 0413L 075052	25	25	25	150	4.00	20	52	75	0.69	G1170	GL07
GFMR 2525 M 0416L 100070	25	25	25	150	4.00	20	70	100	0.88	G1137	GL08
GFMR 2525 M 0416L 130090	25	25	25	150	4.00	20	90	130	0.78	G1137	GL08
GFMR 2525 M 0416L 170110	25	25	25	150	4.00	20	110	170	0.81	G1137	GL08
GFMR 2525 M 0416L 230140	25	25	25	150	4.00	20	140	230	0.78	G1137	GL08

Product	Insert
G1137	LCM. 0416..
G1170	LCM. 0413..

Product	Tool	Nm	Thread	Length	Clamp	Clamp
GL07	US 5018-T20P	5.0	M 5	18.2	FLAG T20P	-
GL08	US 6020-T25P	6.0	M 6	20.2	-	SDR T25P



GFMR-R AXIAL

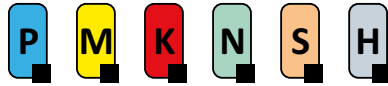

PRAMET



External Axial V-Groove Top Clamp Grooving Tool for LCM. 04 Inserts

External right-hand axial tool holder for grooving with single or double-sided LCM. 0413 or 0416 inserts. Suited for deep axial grooving, axial profiling or groove widening Ø17 up to Ø230 mm applications, with maximum depth of cut 20 mm. Available with shank size 25x25 mm. Body treated for longer tool life.

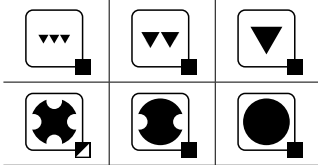
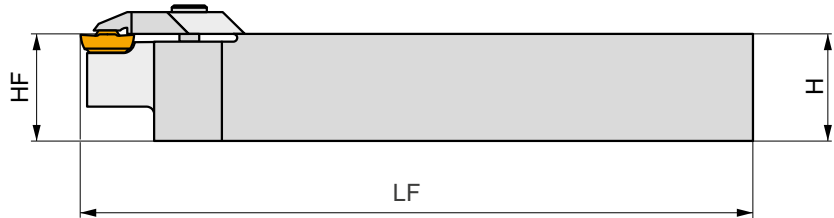
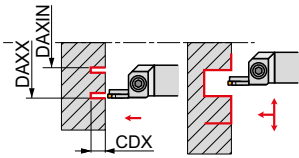

Product	⌀	H	B	LF	CW	CDX	DAXIN	DAXX	kg	G1	G2	
	[mm]	[mm]	[mm]	[mm]	[mm]	[mm]	[mm]					
R	GFMR 2525 M 0413R 030017	25	25	25	150	4.00	20	17	30	0.62	G170	GL02
	GFMR 2525 M 0413R 034021	25	25	25	150	4.00	20	21	34	0.63	G170	GL07
	GFMR 2525 M 0413R 040026	25	25	25	150	4.00	20	26	40	0.64	G170	GL07
	GFMR 2525 M 0413R 050032	25	25	25	150	4.00	20	32	50	0.63	G170	GL07
	GFMR 2525 M 0413R 060042	25	25	25	150	4.00	20	42	60	0.64	G170	GL07
	GFMR 2525 M 0413R 075052	25	25	25	150	4.00	20	52	75	0.67	G170	GL07
	GFMR 2525 M 0416R 100070	25	25	25	150	4.00	20	70	100	0.67	G137	GL07
	GFMR 2525 M 0416R 130090	25	25	25	150	4.00	20	90	130	0.66	G137	GL07
	GFMR 2525 M 0416R 170110	25	25	25	150	4.00	20	110	170	0.67	G137	GL07
	GFMR 2525 M 0416R 230140	25	25	25	150	4.00	20	140	230	0.68	G137	GL07

G137	LCM. 0416..
G170	LCM. 0413..

GL02	US 5015-T20P	5.0	M 5	15	FLAG T20P
GL07	US 5018-T20P	5.0	M 5	18.2	FLAG T20P



GGI(RL)-90 AXIAL

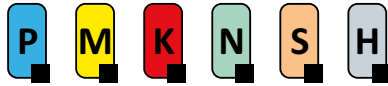

PRAMET

G



External Axial 90° V-Groove Top Clamp Grooving Tool for LCM. 03 Inserts

External Right/Left hand axial 90° tool holder for grooving with single or double-sided LCM. 0313 or 0316 inserts. Suited for axial grooving, axial profiling or groove widening Ø17 up to Ø170 mm applications, with maximum depth of cut 11 mm. Available with shank size 25x25 mm. Body treated for longer tool life.

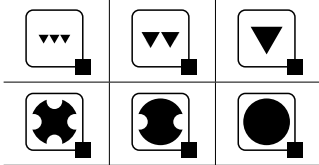
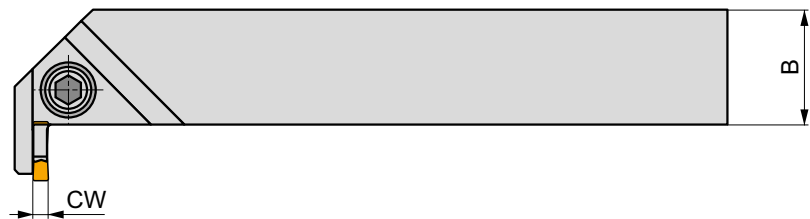
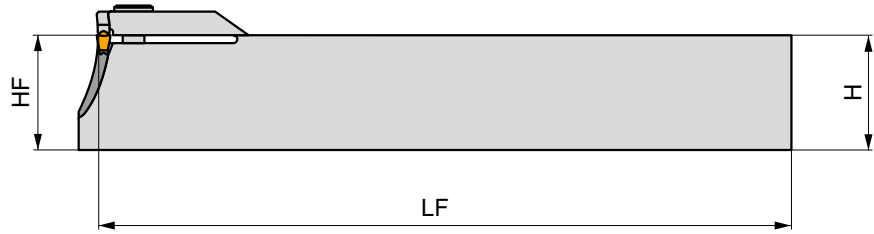
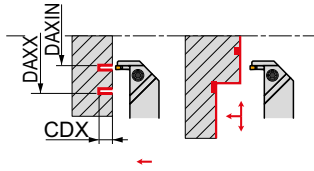

	Product	HF	H	B	LF	CW	CDX	DAXIN	DAXX	kg	G136	G143
		[mm]	[mm]	[mm]	[mm]	[mm]	[mm]	[mm]	[mm]			
R	GGIR 2525 M 03R 030017	25	25	25	150	3.00	9.5	17	30	0.75	G143	GL01
	GGIR 2525 M 03R 039024	25	25	25	150	3.00	9.5	24	39	0.78	G143	GL01
	GGIR 2525 M 03R 050033	25	25	25	150	3.00	11	33	50	0.75	G143	GL01
	GGIR 2525 M 03R 060043	25	25	25	150	3.00	11	43	60	0.78	G143	GL01
	GGIR 2525 M 03R 076053	25	25	25	150	3.00	11	53	76	0.75	G143	GL01
	GGIR 2525 M 03R 100070	25	25	25	150	3.00	9	70	100	0.78	G136	GL04
	GGIR 2525 M 03R 130090	25	25	25	150	3.00	9	90	130	0.73	G136	GL04
	GGIR 2525 M 03R 170110	25	25	25	150	3.00	9	110	170	0.76	G136	GL04
L	GGIL 2525 M 03L 030017	25	25	25	150	3.00	9.5	17	30	0.75	G143	GL01
	GGIL 2525 M 03L 039024	25	25	25	150	3.00	9.5	24	39	0.25	G143	GL01
	GGIL 2525 M 03L 050033	25	25	25	150	3.00	11	33	50	0.75	G143	GL01
	GGIL 2525 M 03L 060043	25	25	25	150	3.00	11	43	60	0.75	G143	GL01
	GGIL 2525 M 03L 076053	25	25	25	150	3.00	11	53	76	0.75	G143	GL01
	GGIL 2525 M 03L 100070	25	25	25	150	3.00	9	70	100	0.77	G136	GL04
	GGIL 2525 M 03L 130090	25	25	25	150	3.00	9	90	130	0.77	G136	GL04
	GGIL 2525 M 03L 170110	25	25	25	150	3.00	9	110	170	0.76	G136	GL04

G136		LCM. 0316..	
G143		LCM. 0313..	

GL01	HS 0520C	5.0	M 5	20	HXK 4
GL04	HS 0620C	6.0	M 6	20	HXK 5



LCMF 20 - F1

	CW	CWTOLL	CWTOLU	INSL
	[mm]	[mm]	[mm]	[mm]
0220	2.00	-0.03	0.03	19.5

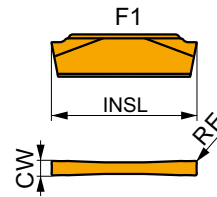

Suitability and starting values for cutting speed (vc) and feed (f). Refer to our Machining Calculator app for further calculations.

Product	RE [mm]	P		M		K		N		S		H		PSIRR [°]	PSIRL [°]
		vc [m/min]	f [mm/rev]	vc [m/min]	f [mm/rev]	vc [m/min]	f [mm/rev]	vc [m/min]	f [mm/rev]	vc [m/min]	f [mm/rev]	vc [m/min]	f [mm/rev]		
	0.2	205	0.09	120	0.08	190	0.09	-	-	-	-	-	-	-	-

F1 geometry for parting-off and grooving, fine and finish machining, and continuous to slightly interrupted cuts.

LCMF 20 - M2

	CW	CWTOLL	CWTOLU	INSL
	[mm]	[mm]	[mm]	[mm]
0220	2.00	-0.03	0.03	19.5

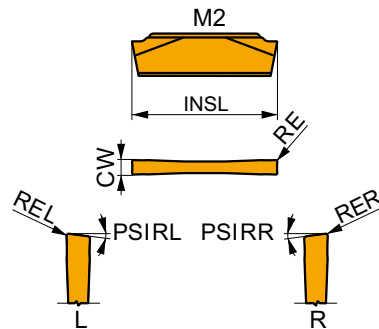

Suitability and starting values for cutting speed (vc) and feed (f). Refer to our Machining Calculator app for further calculations.

Product	RE [mm]	P		M		K		N		S		H		PSIRR [°]	PSIRL [°]
		vc [m/min]	f [mm/rev]	vc [m/min]	f [mm/rev]	vc [m/min]	f [mm/rev]	vc [m/min]	f [mm/rev]	vc [m/min]	f [mm/rev]	vc [m/min]	f [mm/rev]		
	0.2	180	0.12	105	0.11	170	0.12	-	-	-	-	-	-	-	-
	0.2	130	0.12	75	0.11	120	0.12	-	-	-	-	-	6	-	
	0.2	130	0.12	75	0.11	120	0.12	-	-	-	-	-	-	6	

M2 geometry for parting-off and grooving, fine and finish machining, and continuous to slightly interrupted cuts.

R-M2 geometry, with right-handed design, for parting-off, and continuous to slightly interrupted cuts.

L-M2 geometry, with left-handed design, for parting-off and continuous to slightly interrupted cuts.



LCMF 20 - MP

	CW	CWTOLL	CWTOLU	INSL
	[mm]	[mm]	[mm]	[mm]
0220	2.00	-0.03	0.03	19.5

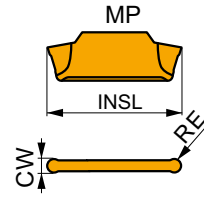

Suitability and starting values for cutting speed (vc), feed (f) and depth of cut (ap). Refer to our Machining Calculator app for further calculations.

Product	RE [mm]	P			M			K			N			S			H		
		vc [m/min]	f [mm/rev]	ap [mm]	vc [m/min]	f [mm/rev]	ap [mm]	vc [m/min]	f [mm/rev]	ap [mm]	vc [m/min]	f [mm/rev]	ap [mm]	vc [m/min]	f [mm/rev]	ap [mm]	vc [m/min]	f [mm/rev]	ap [mm]

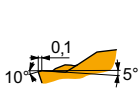

MP geometry for longitudinal turning and copy profiling, fine and finish machining, and continuous to interrupted cuts.

LCMF 0220MO-MP	T8330	1.0	200	0.30	0.5	120	0.27	0.5	190	0.30	0.5	-	-	-	-	-	-	-
----------------	-------	-----	-----	------	-----	-----	------	-----	-----	------	-----	---	---	---	---	---	---	---



GFK(RL) EXT

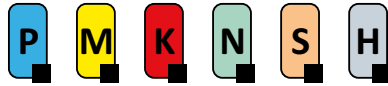

PRAMET

G



External V-Groove Top Clamp Grooving and Parting-Off tool, LCMF 0220 Ins

External Right/Left hand tool holder for grooving with LCMF 0220 inserts. Suited for parting-off, grooving and profiling applications up to 16 mm maximum depth of cut. Available with shank size 16x16 up to 25x25 mm. Body treated for longer tool life.

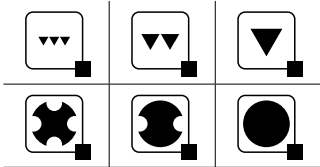
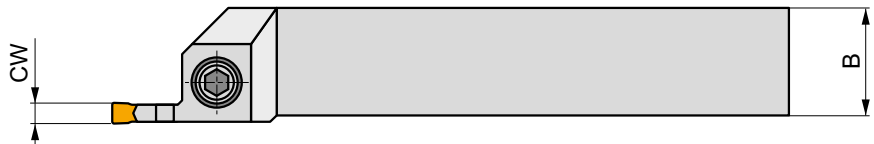
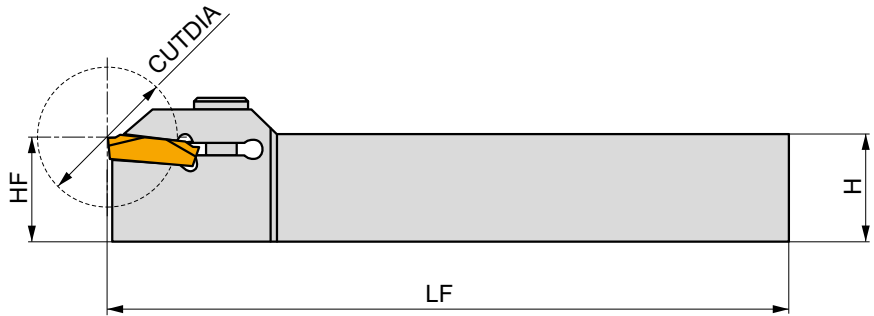
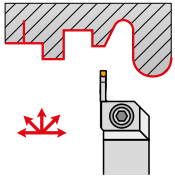

	Product	⌀	H	B	LF	CW	CUTDIA	kg		
		[mm]	[mm]	[mm]	[mm]	[mm]	[mm]			
R	GFKR 1616 H 02	16	16	16	100	2.00	32	0.20	G1168	GL03
	GFKR 2020 K 02	20	20	20	125	2.00	32	0.38	G1168	GL04
	GFKR 2525 M 02	25	25	25	150	2.00	32	0.68	G1168	GL05
L	GFKL 1616 H 02	16	16	16	100	2.00	32	0.20	G1168	GL03
	GFKL 2020 K 02	20	20	20	125	2.00	32	0.38	G1168	GL04
	GFKL 2525 M 02	25	25	25	150	2.00	32	0.68	G1168	GL05

G1168	LCMF 0220..

GL03	HS 0616C	6.0	M 6	16	HXK 5
GL04	HS 0620C	6.0	M 6	20	HXK 5
GL05	HS 0625C	6.0	M 6	25	HXK 5



LFMX - F1

	CW	CWTOLL	CWTOLU	BW
	[mm]	[mm]	[mm]	[mm]
1.5	1.50	-0.03	0.03	1.30
1.6	1.60	-0.03	0.03	1.30
2.0	2.00	-0.03	0.03	1.60
3.1	3.10	-0.04	0.04	2.60
4.1	4.10	-0.04	0.04	3.60

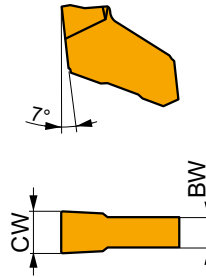

Suitability and starting values for cutting speed (vc) and feed (f). Refer to our Machining Calculator app for further calculations.

Product	RE	P		M		K		N		S		H		PSIRR	PSIRL
		vc	f	vc	f	vc	f	vc	f	vc	f	vc	f		
	[mm]	[m/min]	[mm/rev]	[m/min]	[mm/rev]	[m/min]	[mm/rev]	[m/min]	[mm/rev]	[m/min]	[mm/rev]	[m/min]	[mm/rev]	[°]	[°]

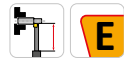

F1 geometry for parting-off and grooving, and continuous cuts.

LFMX 1.5-.16ENF1	T8330	0.2	130	0.08	75	0.07	120	0.08	-	-	-	-	-	-	-
LFMX 1.6-.16ENF1	T8330	0.2	130	0.08	75	0.07	120	0.08	-	-	-	-	-	-	-
LFMX 2.0-.16ENF1	T8330	0.2	130	0.08	75	0.07	120	0.08	-	-	-	-	-	-	-
LFMX 3.1-.20ENF1	T8330	0.2	130	0.10	75	0.09	120	0.10	-	-	-	-	-	-	-
LFMX 4.1-.20ENF1	T8330	0.2	130	0.10	75	0.09	120	0.10	-	-	-	-	-	-	-

LFMX - F2

	CW	CWTOLL	CWTOLU	BW
	[mm]	[mm]	[mm]	[mm]
1.6	1.60	-0.03	0.03	1.30
2.0	2.00	-0.03	0.03	1.60
3.1	3.10	-0.04	0.04	2.60
4.1	4.10	-0.04	0.04	3.60
5.1	5.10	-0.04	0.04	4.60
6.35	6.35	-0.04	0.04	5.80

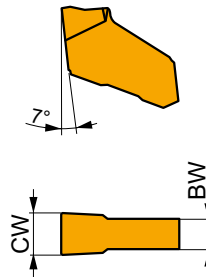

Suitability and starting values for cutting speed (vc) and feed (f). Refer to our Machining Calculator app for further calculations.

Product	RE	P		M		K		N		S		H		PSIRR	PSIRL
		vc	f	vc	f	vc	f	vc	f	vc	f	vc	f		
	[mm]	[m/min]	[mm/rev]	[m/min]	[mm/rev]	[m/min]	[mm/rev]	[m/min]	[mm/rev]	[m/min]	[mm/rev]	[m/min]	[mm/rev]	[°]	[°]



SN-F2 geometry for parting-off and grooving, and continuous cuts.

LFMX 1.6-.16SNF2	T8330	0.2	130	0.10	75	0.09	120	0.10	-	-	-	-	-	-	-
LFMX 2.0-.16SNF2	6640	0.2	150	0.10	90	0.09	140	0.10	-	-	-	-	-	-	-
	T8330	0.2	130	0.10	75	0.09	120	0.10	-	-	-	-	-	-	-
LFMX 3.1-.20SNF2	6640	0.2	150	0.10	90	0.09	140	0.10	-	-	-	-	-	-	-
	T8330	0.2	130	0.10	75	0.09	120	0.10	-	-	-	-	-	-	-
LFMX 4.1-.20SNF2	T8330	0.2	130	0.12	75	0.11	120	0.12	-	-	-	-	-	-	-
LFMX 5.1-.20SNF2	T8330	0.2	130	0.12	75	0.11	120	0.12	-	-	-	-	-	-	-
LFMX 6.35-.20SNF2	T8330	0.2	130	0.15	75	0.14	120	0.15	-	-	-	-	-	-	-



Suitability and starting values for cutting speed (vc) and feed (f). Refer to our Machining Calculator app for further calculations.

Product	RE [mm]	P		M		K		N		S		H		PSIRR [°]	PSIRL [°]
		vc [m/min]	f [mm/rev]	vc [m/min]	f [mm/rev]	vc [m/min]	f [mm/rev]	vc [m/min]	f [mm/rev]	vc [m/min]	f [mm/rev]	vc [m/min]	f [mm/rev]		

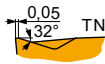

TN-F2 geometry for parting-off and grooving, and continuous cuts.

LFMX 3.1-.20TNF2	6640	0.2	150	0.10	90	0.09	140	0.10	-	-	-	-	-	-	-
	T8330	0.2	130	0.10	75	0.09	120	0.10	-	-	-	-	-	-	-
LFMX 4.1-.20TNF2	6640	0.2	150	0.12	90	0.11	140	0.12	-	-	-	-	-	-	-
	T8330	0.2	130	0.12	75	0.11	120	0.12	-	-	-	-	-	-	-

LFMX - M2



	CW [mm]	CWTOLL [mm]	CWTOLU [mm]	BW [mm]
2.0	2.00	-0.03	0.03	1.60
2.2	2.20	-0.03	0.03	1.60
3.1	3.10	-0.04	0.04	2.60
4.1	4.10	-0.04	0.04	3.60
5.1	5.10	-0.04	0.04	4.60
6.35	6.35	-0.04	0.04	5.80

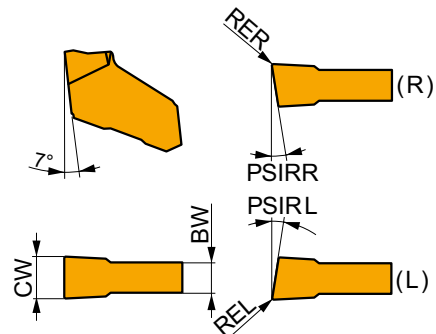

Suitability and starting values for cutting speed (vc) and feed (f). Refer to our Machining Calculator app for further calculations.

Product	RE [mm]	P		M		K		N		S		H		PSIRR [°]	PSIRL [°]
		vc [m/min]	f [mm/rev]	vc [m/min]	f [mm/rev]	vc [m/min]	f [mm/rev]	vc [m/min]	f [mm/rev]	vc [m/min]	f [mm/rev]	vc [m/min]	f [mm/rev]		

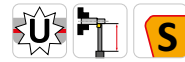
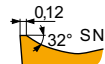

SN-M2 geometry for parting-off and grooving, and continuous to slightly interrupted cuts.

LFMX 2.0-.16SNM2	6640	0.2	150	0.11	90	0.10	140	0.11	-	-	-	-	-	-	-
	T8330	0.2	130	0.11	75	0.10	120	0.11	-	-	-	-	-	-	-
LFMX 2.2-.16SNM2	6640	0.2	150	0.11	90	0.10	140	0.11	-	-	-	-	-	-	-
	T8330	0.2	130	0.11	75	0.10	120	0.11	-	-	-	-	-	-	-
LFMX 3.1-.20SNM2	6640	0.2	150	0.15	90	0.14	140	0.15	-	-	-	-	-	-	-
	T8330	0.2	130	0.15	75	0.14	120	0.15	-	-	-	-	-	-	-
LFMX 4.1-.20SNM2	6640	0.2	150	0.15	90	0.14	140	0.15	-	-	-	-	-	-	-
	T8330	0.2	130	0.15	75	0.14	120	0.15	-	-	-	-	-	-	-
LFMX 5.1-.20SNM2	6640	0.2	150	0.20	90	0.18	140	0.20	-	-	-	-	-	-	-
	T8330	0.2	130	0.20	75	0.18	120	0.20	-	-	-	-	-	-	-
LFMX 6.35-.20SNM2	6640	0.2	150	0.20	90	0.18	140	0.20	-	-	-	-	-	-	-
	T8330	0.2	130	0.20	75	0.18	120	0.20	-	-	-	-	-	-	-

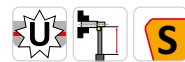
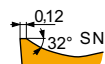
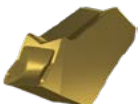

SR-M2 geometry, with right-handed design, for parting-off, and continuous to slightly interrupted cuts.

LFMX 2.0-.16SR12M2	T8330	0.2	130	0.09	75	0.08	120	0.09	-	-	-	-	12	-
LFMX 2.0-.16SR6M2	T8330	0.2	130	0.09	75	0.08	120	0.09	-	-	-	-	6	-
LFMX 3.1-.20SR8M2	T8330	0.2	130	0.11	75	0.10	120	0.11	-	-	-	-	8	-
LFMX 4.1-.20SR8M2	T8330	0.2	130	0.15	75	0.14	120	0.15	-	-	-	-	8	-

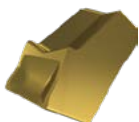

M2-SL geometry, with left-handed design, for parting-off, and continuous to slightly interrupted cuts.

LFMX 2.0-.16SL12M2	T8330	0.2	130	0.09	75	0.08	120	0.09	-	-	-	-	-	12
LFMX 2.0-.16SL6M2	T8330	0.2	130	0.09	75	0.08	120	0.09	-	-	-	-	-	6



Suitability and starting values for cutting speed (vc) and feed (f). Refer to our Machining Calculator app for further calculations.

Product	RE <small>(mm)</small>	P		M		K		N		S		H		PSIRR <small>[°]</small>	PSIRL <small>[°]</small>
		vc <small>[m/min]</small>	f <small>[mm/rev]</small>	vc <small>[m/min]</small>	f <small>[mm/rev]</small>	vc <small>[m/min]</small>	f <small>[mm/rev]</small>	vc <small>[m/min]</small>	f <small>[mm/rev]</small>	vc <small>[m/min]</small>	f <small>[mm/rev]</small>	vc <small>[m/min]</small>	f <small>[mm/rev]</small>		

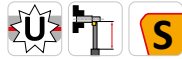
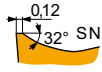
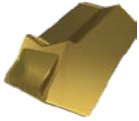

M2-SL geometry, with left-handed design, for parting-off, and continuous to slightly interrupted cuts.

LFMX 3.1-.20SL8M2	T8330	0.2	130	0.11	75	0.10	120	0.11	–	–	–	–	–	–	8
LFMX 4.1-.20SL8M2	T8330	0.2	130	0.15	75	0.14	120	0.15	–	–	–	–	–	–	8

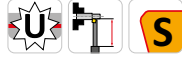
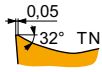

TN-M2 geometry for parting-off and grooving, and continuous to slightly interrupted cuts.

LFMX 3.1-.20TNM2	6640	0.2	150	0.15	90	0.14	140	0.15	–	–	–	–	–	–	–
	T8330	0.2	130	0.15	75	0.14	120	0.15	–	–	–	–	–	–	–
LFMX 4.1-.20TNM2	6640	0.2	150	0.15	90	0.14	140	0.15	–	–	–	–	–	–	–
	T8330	0.2	130	0.15	75	0.14	120	0.15	–	–	–	–	–	–	–



XLCFN B

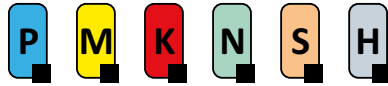

PRAMET



Double-Ended Parting-off Blade for LFMX Inserts

Blade for parting-off applications up to 80 mm maximum depth or Ø160 mm bar material. Suited for single-sided LFMX inserts. Available in heights of 26, 32 or 45 mm. Can be fitted into the DU Pramet basic holders. Blade treated for longer tool life.

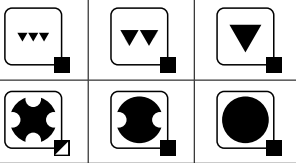
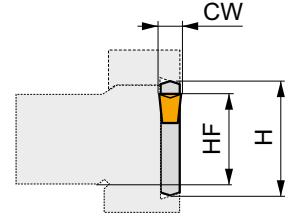
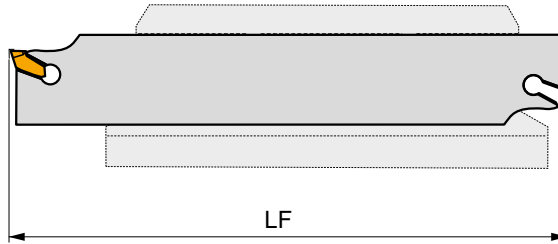
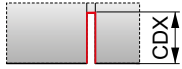

Product	⌀	H	LF	CW	CDX	kg	GI	KV
	[mm]	[mm]	[mm]	[mm]	[mm]			
N	XLCFN 2601 J 1.60	21.4	26	110	1.50	0.03	GI132	KV
	XLCFN 2601 J 2.00	21.4	26	110	2.00	0.04	GI061	KV
	XLCFN 2602 J 3.00	21.4	26	110	3.10	0.05	GI001	KV
	XLCFN 2603 J 4.00	21.4	26	110	4.10	0.06	GI002	KV
	XLCFN 3201 M 1.60	25	32	150	1.50	0.06	GI132	KV
	XLCFN 3201 M 2.00	25	32	150	2.00	0.11	GI061	KV
	XLCFN 3202 M 3.00	25	32	150	3.10	0.08	GI001	KV
	XLCFN 3203 M 4.00	25	32	150	4.10	0.11	GI002	KV
	XLCFN 3204 M 5.00	25	32	150	5.10	0.14	GI004	KV
	XLCFN 3205 M 6.35	25	32	150	6.35	0.17	GI005	KV
	XLCFN 4502 S 3.00	32	45	250	3.10	0.12	GI001	KV
	XLCFN 4503 S 4.00	32	45	250	4.10	0.19	GI002	KV
	XLCFN 4504 S 5.00	32	45	250	5.10	0.28	GI004	KV
	XLCFN 4505 S 6.35	32	45	250	6.35	0.40	GI005	KV

GI	LFMX	
GI001	LFMX 3.1-	-
GI002	LFMX 4.1-	-
GI004	LFMX 5.1-	-
GI005	LFMX 6.35-	-
GI061	LFMX 2.0-	LFMX 2.2-
GI132	LFMX 1.5-	LFMX 1.6-

KV	
KV	KV 5x70



DU, D



Tool Holder Block for Parting-off Blades

Tool holder to fit GL or XLC. blades for parting-off. Available with shank size 20x20 up to 40x40 mm. Body treated for longer tool life.

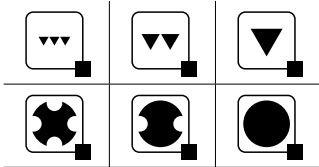
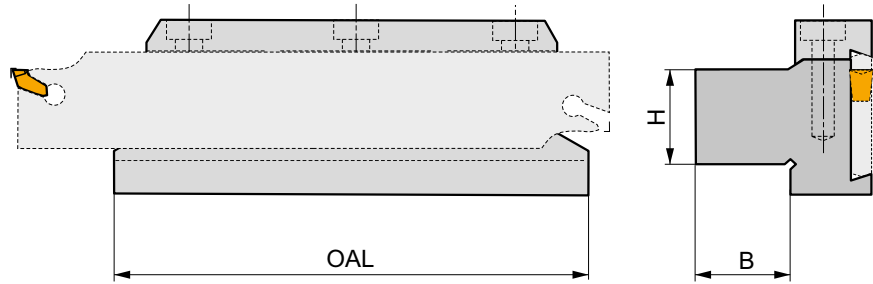
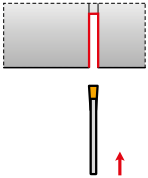

Product	H [mm]	B [mm]	LB [mm]	kg		
26-DU 2020	20	20	90	0.70	GI007	ND2
26-D 2020	20	20	100	0.82	GI007	ND2
32-DU 2523	25	23	110	1.02	GI008	ND2
32-DU 2532	25	32	110	1.10	GI008	ND2
32-DU 3229	32	29	110	1.25	GI008	ND2
32-D 2530	25	30	115	1.30	GI008	ND2
45-DU 3229	32	29	110	1.50	GI009	ND7
45-DU 4036	40	36	110	2.05	GI009	ND7
47-D 4040	40	40	150	3.88	GI091	ND3

GI007	XLC.N 26..	GL.-S26.B
GI008	XLC.N 32..	GL.-S32.B
GI009	XLC.N 45..	-
GI091	XLC.N 47..	-

ND2	HS 0625	6.0	M 6	25	HXX 5
ND3	HS 1030	8.0	M 10	30	HXX 8
ND7	HS 0630	6.0	M 6	30	HXX 5



XLCF(NRL) BS

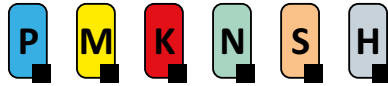

PRAMET



Radial Grooving Blade for Modular MS-EN Tool Holder for LFMX Inserts

Modular grooving blade for grooving with single-sided LFMX inserts. Suited for grooving or parting-off (max. 25 mm cutting depth) applications. Blades treated for longer tool life.

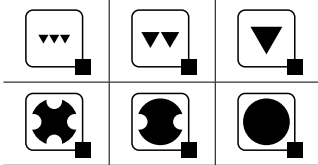
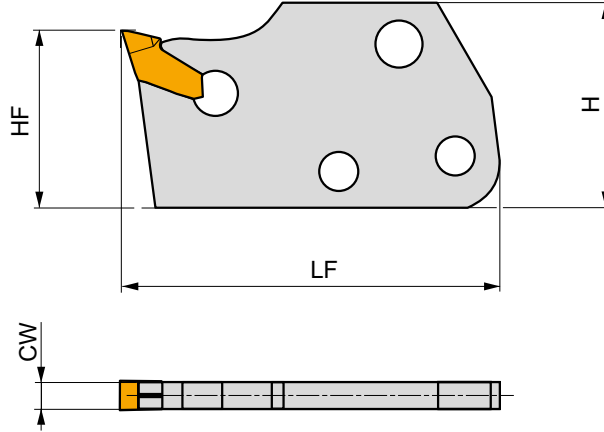
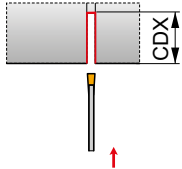

Product	Ξ	H	LF	CW	CDX	kg			
	[mm]	[mm]	[mm]	[mm]	[mm]				
R	XLCFR 160115-1.60	12	25	35	1.50	15	0.01	GI132	KV
	XLCFR 160115-2.00	12	25	35	2.00	15	0.01	GI061	KV
	XLCFR 250115-1.60	24	29	40	1.50	15	0.01	GI132	KV
	XLCFR 250115-2.00	24	29	40	2.00	15	0.05	GI061	KV
L	XLCFL 160115-1.60	12	25	35	1.50	15	0.01	GI132	KV
	XLCFL 160115-2.00	12	25	35	2.00	15	0.04	GI061	KV
	XLCFL 250115-1.60	24	29	40	1.50	15	0.01	GI132	KV
	XLCFL 250115-2.00	24	29	40	2.00	15	0.05	GI061	KV
N	XLCFN 160215-3.00	12	25	35	3.10	15	0.01	GI001	KV
	XLCFN 160220-3.00	12	25	40	3.10	20	0.02	GI001	KV
	XLCFN 250215-3.00	24	29	40	3.10	15	0.02	GI001	KV
	XLCFN 250225-3.00	24	29	50	3.10	25	0.02	GI001	KV
	XLCFN 250315-4.00	24	29	40	4.10	15	0.02	GI002	KV
	XLCFN 250325-4.00	24	29	50	4.10	25	0.03	GI002	KV
	XLCFN 250425-5.00	24	29	50	5.10	25	0.04	GI004	KV
	XLCFN 250525-6.35	24	29	50	6.35	25	0.04	GI005	KV

GI001	LFMX 3.1-	-
GI002	LFMX 4.1-	-
GI004	LFMX 5.1-	-
GI005	LFMX 6.35-	-
GI061	LFMX 2.0-	LFMX 2.2-
GI132	LFMX 1.5-	LFMX 1.6-

KV	KV 5x70



XLXFL BS AXIAL

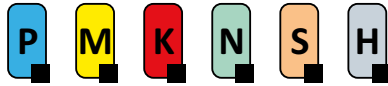

PRAMET

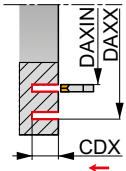

Axial Grooving Blade for Modular MS-EN Tool Holder for LFMX Inserts

Modular grooving blade for grooving with single-sided LFMX 3.1 inserts. Suited for axial grooving (max. 20 mm cutting depth) applications. Can be fitted to MS-EN tool holder. Blades treated for longer tool life.

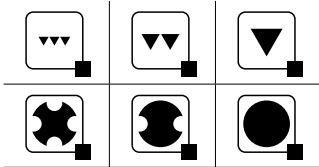
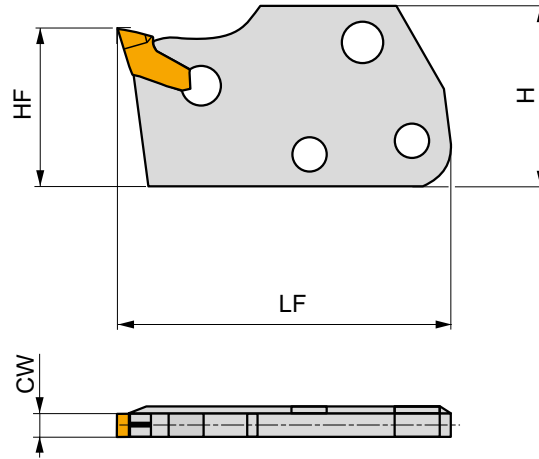

Product	H	HF	LF	CW	CDX	DAXIN	DAXX	kg		
	[mm]	[mm]	[mm]	[mm]	[mm]		[mm]			
XLXFL 250220-3.00-60	29	24	46	3.10	20	60	85	0.07	G1001	KV
XLXFL 250220-3.00-80	29	24	46	3.10	20	80	105	0.05	G1001	KV
XLXFL 250220-3.00-100	29	24	46	3.10	20	100	155	0.03	G1001	KV
XLXFL 250220-3.00-150	29	24	46	3.10	20	150	280	0.03	G1001	KV



G1001



LFMX 3.1-



KV



KV 5x70



MS-EN



Modular Tool Holder for XLCCN, XLCF(NRL) or XLXFL Grooving Blade

Tool holder to fit modular grooving blades from the XLC 25 BS, XLCF(NRL) BS, XLXFL BS axial grooving blade. Available with shank size 12x12 up to 32x25 mm. Body treated for longer tool life.

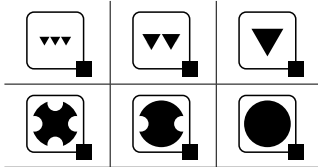
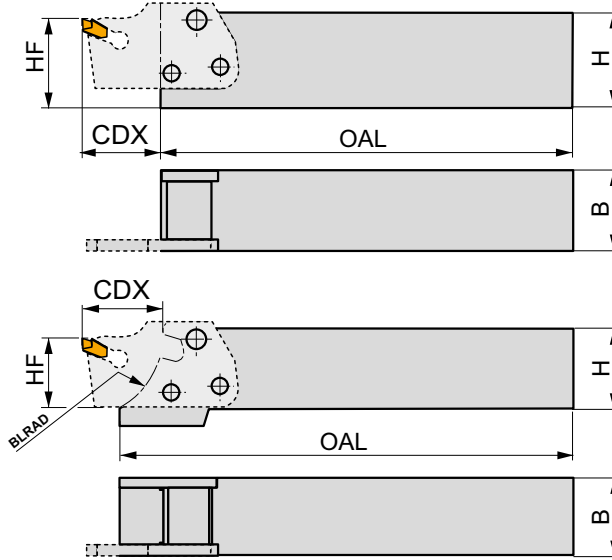
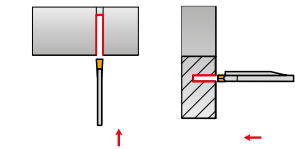

Product	HF [mm]	H [mm]	B [mm]	OAL [mm]	CDX [mm]	BLRAD [mm]	kg		
MS-EN-1212 F	12	12	12	75	15	-	0.13	GI006	ND4
MS-EN-1616 H	16	16	16	90	15	-	0.21	GI006	ND4
MS-EN-2020 K	20	20	20	115	15	-	0.23	GI003	ND5
MS-EN-2020 KS	20	20	20	129	15	25	0.42	GI060	ND5
MS-EN-2525 M	25	25	25	140	15	-	0.65	GI003	ND5
MS-EN-2525 MS	25	25	25	153	15	25	0.74	GI060	ND5
MS-EN-3225 P	32	32	25	160	15	-	0.95	GI003	ND5
MS-EN-3225 PS	32	32	25	174	15	25	1.00	GI060	ND5

GI003	XLC.. 25..15...	XLXFL 25...	XLC.. 25..25...
GI006	XLCF. 16..15...	XLCF. 16..20...	-
GI060	XLC.. 25..15...	XLC.. 25..25...	-

ND4	US 4011-T15P	3.5	M 4	10.6	-	-	-	-	FLAG T15P
ND5	US 45013-T20P	5.0	M 5	13	US 46017-T20P	5.0	M6	17	FLAG T15P

ND4 = 3 x US 4011-T15P; ND5 = 2 x US 45013-T20P



LFUX



	CW	BW	INSL
	[mm]	[mm]	[mm]
0308	3.00	2.51	11.5
0408	4.00	3.44	11.5
0508	5.00	4.30	11.5
0608	6.00	5.30	11.5

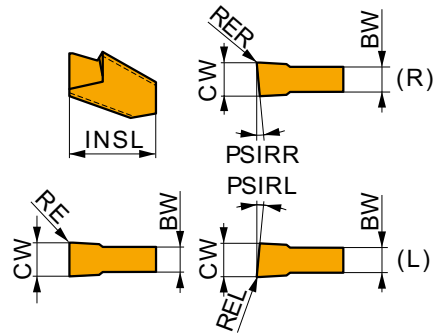

Suitability and starting values for cutting speed (vc) and feed (f). Refer to our Machining Calculator app for further calculations.

Product	RE	P		M		K		N		S		H		PSIRR	PSIRL
		vc	f	vc	f	vc	f	vc	f	vc	f	vc	f		
	[mm]	[m/min]	[mm/rev]	[m/min]	[mm/rev]	[m/min]	[mm/rev]	[m/min]	[mm/rev]	[m/min]	[mm/rev]	[m/min]	[mm/rev]	[°]	[°]

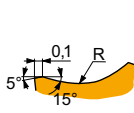

TN geometry for parting-off and grooving, and continuous to slightly interrupted cuts.

LFUX 030802TN	6640	0.2	150	0.10	–	–	140	0.10	–	–	–	–	–	–	–
	T8330	0.2	130	0.10	–	–	120	0.10	–	–	–	–	–	–	–
LFUX 040802TN	6640	0.2	150	0.12	–	–	140	0.12	–	–	–	–	–	–	–
	T8330	0.2	130	0.12	–	–	120	0.12	–	–	–	–	–	–	–
LFUX 050802TN	6640	0.2	150	0.15	–	–	140	0.15	–	–	–	–	–	–	–
	T8330	0.2	130	0.15	–	–	120	0.15	–	–	–	–	–	–	–
LFUX 060802TN	6640	0.2	150	0.20	–	–	140	0.20	–	–	–	–	–	–	–
	T8330	0.2	130	0.20	–	–	120	0.20	–	–	–	–	–	–	–

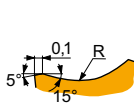

TR geometry, right-handed, for parting-off and continuous to slightly interrupted cuts.

LFUX 030800TR	6640	0.2	150	0.10	–	–	140	0.10	–	–	–	–	5	–
	T8330	0.2	130	0.10	–	–	120	0.10	–	–	–	–	5	–
LFUX 040800TR	6640	0.2	150	0.12	–	–	140	0.12	–	–	–	–	5	–
	T8330	0.2	130	0.12	–	–	120	0.12	–	–	–	–	5	–

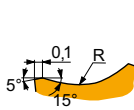

TL geometry, left-handed, for parting-off and continuous to slightly interrupted cuts.

LFUX 030800TL	6640	0.2	150	0.10	–	–	140	0.10	–	–	–	–	–	5
	T8330	0.2	130	0.10	–	–	120	0.10	–	–	–	–	–	5



XLCF(RL)

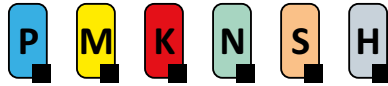

PRAMET



External Grooving and Parting-Off tool for LFUX Inserts

External Right/Left hand radial tool holder for grooving with single-sided LFUX 0308, 0408, 0508 or 0608 inserts. Suited for parting-off up to a maximum of $\varnothing 65$ mm. Available with shank size 16x12 up to 32x25 mm. Body treated for longer tool life.

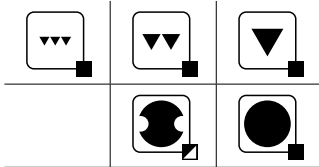
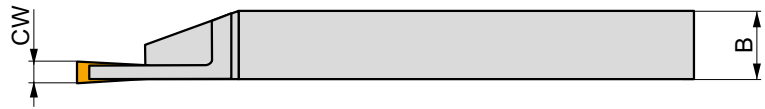
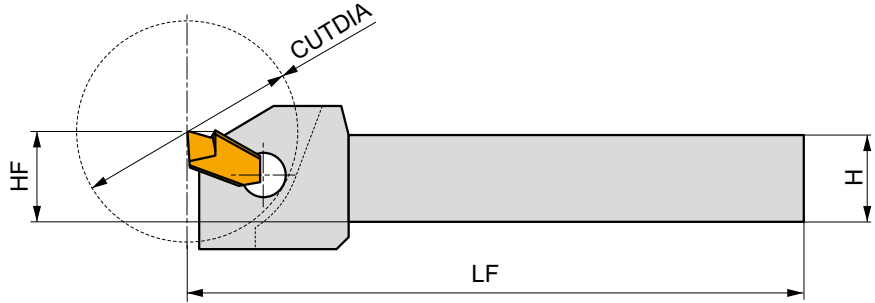
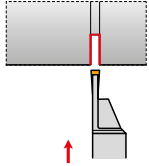

	Product	Ξ	H	B	L _F	CW	CUTDIA	kg	G1018	KV
		[mm]	[mm]	[mm]	[mm]	[mm]	[mm]			
R	XLCFR 1612 H 03	16	16	12	100	3.00	40	0.14	G1018	KV
	XLCFR 2016 K 03	20	20	16	130	3.00	50	0.30	G1018	KV
	XLCFR 2520 K 03	25	25	20	130	3.00	50	0.44	G1018	KV
	XLCFR 2016 K 04	20	20	16	130	4.00	50	0.30	G1019	KV
	XLCFR 2520 K 04	25	25	20	130	4.00	50	0.43	G1019	KV
	XLCFR 2520 K 05	25	25	20	130	5.00	50	0.45	G1020	KV
	XLCFR 3225 P 05	32	32	25	170	5.00	65	0.90	G1020	KV
	XLCFR 3225 P 06	32	32	25	170	6.00	65	0.91	G1021	KV
L	XLCFL 1612 H 03	16	16	12	100	3.00	40	0.15	G1018	KV
	XLCFL 2016 K 03	20	20	16	130	3.00	50	0.30	G1018	KV
	XLCFL 2520 K 03	25	25	20	130	3.00	50	0.47	G1018	KV
	XLCFL 2016 K 04	20	20	16	130	4.00	50	0.30	G1019	KV
	XLCFL 2520 K 04	25	25	20	130	4.00	50	0.46	G1019	KV
	XLCFL 2520 K 05	25	25	20	130	5.00	50	0.50	G1020	KV
	XLCFL 3225 P 05	32	32	25	170	5.00	65	0.95	G1020	KV
	XLCFL 3225 P 06	32	32	25	170	6.00	65	0.70	G1021	KV



G1018
G1019
G1020
G1021

LFUX 0308..
LFUX 0408..
LFUX 0508..
LFUX 0608..



KV

KV 5x70



XLCFN B LFUX

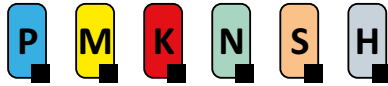

PRAMET



Double-Ended Parting-off Blade for LFUX Inserts

Blade for parting-off applications up to 100 mm maximum depth or Ø200 mm bar material. Suited for single sided LFUX inserts. Available in heights of 26, 32 or 47 mm. Can be fitted into the DU, D Pramet basic holders. Blade treated for longer tool life.

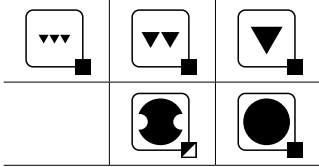
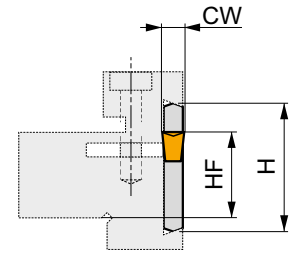
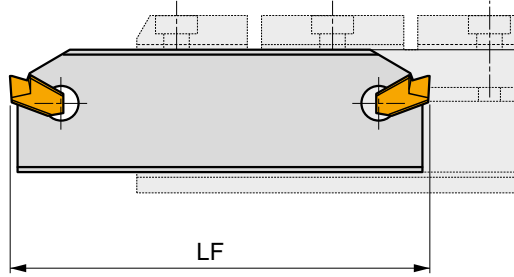
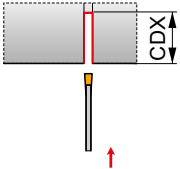

Product	Ξ	H	LF	CW	CDX	kg		
	[mm]	[mm]	[mm]	[mm]	[mm]			
XLCFN 2603 J 03	21.4	26	110	3.10	37.5	0.06	GI018	KV
XLCFN 3202 M 03	25	32	150	3.10	50	0.09	GI018	KV
XLCFN 3203 M 04	25	32	150	4.10	50	0.11	GI019	KV
XLCFN 3204 M 05	25	32	150	5.10	60	0.14	GI020	KV
XLCFN 4704 S 05	38	47	270	5.10	100	0.47	GI020	KV
XLCFN 4705 S 06	38	47	270	6.10	100	0.50	GI021	KV

GI018	LFUX 0308..
GI019	LFUX 0408..
GI020	LFUX 0508..
GI021	LFUX 0608..

KV	KV 5x70



DU, D

Tool Holder Block for Parting-off Blades

Tool holder to fit GL or XLC. blades for parting-off. Available with shank size 20x20 up to 40x40 mm. Body treated for longer tool life.

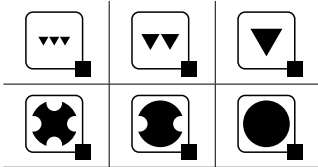
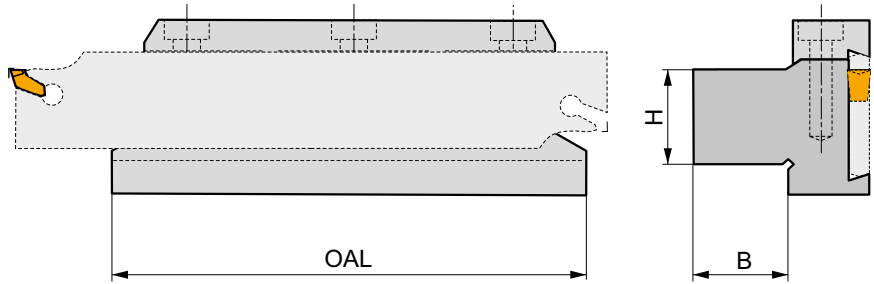
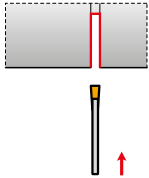

Product	H [mm]	B [mm]	LB [mm]	kg		
26-DU 2020	20	20	90	0.70	GI007	ND2
26-D 2020	20	20	100	0.82	GI007	ND2
32-DU 2523	25	23	110	1.02	GI008	ND2
32-DU 2532	25	32	110	1.10	GI008	ND2
32-DU 3229	32	29	110	1.25	GI008	ND2
32-D 2530	25	30	115	1.30	GI008	ND2
45-DU 3229	32	29	110	1.50	GI009	ND7
45-DU 4036	40	36	110	2.05	GI009	ND7
47-D 4040	40	40	150	3.88	GI091	ND3

GI007	XLC.N 26..	GL.-S26.B
GI008	XLC.N 32..	GL.-S32.B
GI009	XLC.N 45..	-
GI091	XLC.N 47..	-

ND2	HS 0625	6.0	M 6	25	HXK 5
ND3	HS 1030	8.0	M 10	30	HXK 8
ND7	HS 0630	6.0	M 6	30	HXK 5



X 61



	W1	CWTOLL	CWTOLU	S
	[mm]	[mm]	[mm]	[mm]
0602	6.350	-0.03	0.03	2.33

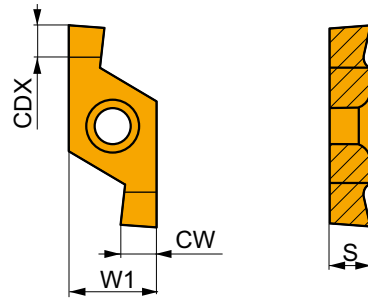

Suitability and starting values for cutting speed (vc) and feed (f). Refer to our Machining Calculator app for further calculations.

Product	RE	P		M		K		N		S		H		CW	CDX
		vc	f	vc	f	vc	f	vc	f	vc	f	vc	f		
	[mm]	[m/min]	[mm/rev]	[m/min]	[mm/rev]	[m/min]	[mm/rev]	[m/min]	[mm/rev]	[m/min]	[mm/rev]	[m/min]	[mm/rev]	[mm]	[mm]

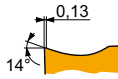

X 61-R external and internal, right-handed geometry, for o-ring and circlip groove machining, with continuous cuts.

X61 0602-080 R	6640	—	■	195	0.06	■	115	0.05	■	185	0.06	—	—	—	—	0.85	0.8
	G8330	—	■	145	0.06	■	85	0.05	■	135	0.06	—	—	—	—	0.85	0.8
X61 0602-090 R	6640	—	■	195	0.06	■	115	0.05	■	185	0.06	—	—	—	—	0.95	0.8
	G8330	—	■	145	0.06	■	85	0.05	■	135	0.06	—	—	—	—	0.95	0.8
X61 0602-100 R	6640	—	■	195	0.06	■	115	0.05	■	185	0.06	—	—	—	—	1.05	0.8
	G8330	—	■	145	0.06	■	85	0.05	■	135	0.06	—	—	—	—	1.05	0.8
X61 0602-110 R	6640	—	■	185	0.06	■	110	0.05	■	175	0.06	—	—	—	—	1.15	1.2
	G8330	—	■	140	0.06	■	80	0.05	■	130	0.06	—	—	—	—	1.15	1.2
X61 0602-130 R	6640	—	■	185	0.06	■	110	0.05	■	175	0.06	—	—	—	—	1.35	1.4
	G8330	—	■	140	0.06	■	80	0.05	■	130	0.06	—	—	—	—	1.35	1.4
X61 0602-150 R	6640	—	■	180	0.06	■	105	0.05	■	170	0.06	—	—	—	—	1.55	1.6
	G8330	—	■	135	0.06	■	80	0.05	■	125	0.06	—	—	—	—	1.55	1.6
X61 0602-160 R	6640	—	■	180	0.06	■	105	0.05	■	170	0.06	—	—	—	—	1.65	1.7
	G8330	—	■	135	0.06	■	80	0.05	■	125	0.06	—	—	—	—	1.65	1.7
X61 0602-185 R	6640	—	■	150	0.09	■	90	0.08	■	140	0.09	—	—	—	—	1.90	2
	G8330	—	■	120	0.09	■	70	0.08	■	110	0.09	—	—	—	—	1.90	2
X61 0602-200 R	G8330	—	■	115	0.09	■	65	0.08	■	105	0.09	—	—	—	—	2.05	2.2
X61 0602-215 R	6640	—	■	145	0.09	■	85	0.08	■	135	0.09	—	—	—	—	2.20	2.4
	G8330	—	■	115	0.09	■	65	0.08	■	105	0.09	—	—	—	—	2.20	2.4
X61 0602-250 R	G8330	—	■	115	0.09	■	65	0.08	■	105	0.09	—	—	—	—	2.55	2.6
X61 0602-265 R	6640	—	■	125	0.12	■	75	0.11	■	115	0.12	—	—	—	—	2.70	2.7
	G8330	—	■	105	0.12	■	60	0.11	■	95	0.12	—	—	—	—	2.70	2.7
X61 0602-300 R	6640	—	■	125	0.12	■	75	0.11	■	115	0.12	—	—	—	—	3.05	3
	G8330	—	■	105	0.12	■	60	0.11	■	95	0.12	—	—	—	—	3.05	3
X61 0602-315 R	6640	—	■	125	0.12	■	75	0.11	■	115	0.12	—	—	—	—	3.20	3
	G8330	—	■	105	0.12	■	60	0.11	■	95	0.12	—	—	—	—	3.20	3

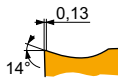

X 61-L external and internal, left-handed geometry, for o-ring and circlip groove machining, with continuous cuts.

X61 0602-080 L	6640	—	■	195	0.06	■	115	0.05	■	185	0.06	—	—	—	—	0.85	0.8
	G8330	—	■	145	0.06	■	85	0.05	■	135	0.06	—	—	—	—	0.85	0.8
X61 0602-090 L	6640	—	■	195	0.06	■	115	0.05	■	185	0.06	—	—	—	—	0.95	0.8
	G8330	—	■	145	0.06	■	85	0.05	■	135	0.06	—	—	—	—	0.95	0.8
X61 0602-100 L	6640	—	■	195	0.06	■	115	0.05	■	185	0.06	—	—	—	—	1.05	0.8
	G8330	—	■	145	0.06	■	85	0.05	■	135	0.06	—	—	—	—	1.05	0.8
X61 0602-110 L	6640	—	■	185	0.06	■	110	0.05	■	175	0.06	—	—	—	—	1.15	1.2
	G8330	—	■	140	0.06	■	80	0.05	■	130	0.06	—	—	—	—	1.15	1.2
X61 0602-130 L	6640	—	■	185	0.06	■	110	0.05	■	175	0.06	—	—	—	—	1.35	1.4
	G8330	—	■	140	0.06	■	80	0.05	■	130	0.06	—	—	—	—	1.35	1.4



Suitability and starting values for cutting speed (vc) and feed (f). Refer to our Machining Calculator app for further calculations.

Product		RE [mm]	P		M		K		N		S		H		CW [mm]	CDX [mm]			
			vc [m/min]	f [mm/rev]	vc [m/min]	f [mm/rev]	vc [m/min]	f [mm/rev]	vc [m/min]	f [mm/rev]	vc [m/min]	f [mm/rev]	vc [m/min]	f [mm/rev]					
 X61 0602-150 L		0.13	14°			X 61-L external and internal, left-handed geometry, for o-ring and circlip groove machining, with continuous cuts.													
						6640	–	180	0.06	105	0.05	170	0.06	–	–	–	–	–	–
X61 0602-160 L		0.13	14°			6640	–	180	0.06	105	0.05	170	0.06	–	–	–	–	1.55	1.6
						G8330	–	135	0.06	80	0.05	125	0.06	–	–	–	–	–	–
X61 0602-185 L		0.13	14°			6640	–	180	0.06	105	0.05	170	0.06	–	–	–	–	1.65	1.7
						G8330	–	135	0.06	80	0.05	125	0.06	–	–	–	–	–	–
X61 0602-200 L		0.13	14°			6640	–	150	0.09	90	0.08	140	0.09	–	–	–	–	1.90	2
						G8330	–	120	0.09	70	0.08	110	0.09	–	–	–	–	–	–
X61 0602-215 L		0.13	14°			6640	–	115	0.09	65	0.08	105	0.09	–	–	–	–	2.05	2.2
						G8330	–	145	0.09	85	0.08	135	0.09	–	–	–	–	–	–
X61 0602-250 L		0.13	14°			6640	–	115	0.09	65	0.08	105	0.09	–	–	–	–	2.20	2.4
						G8330	–	115	0.09	65	0.08	105	0.09	–	–	–	–	–	–
X61 0602-265 L		0.13	14°			6640	–	115	0.09	65	0.08	105	0.09	–	–	–	–	2.55	2.6
						G8330	–	125	0.12	75	0.11	115	0.12	–	–	–	–	–	–
X61 0602-300 L		0.13	14°			6640	–	105	0.12	60	0.11	95	0.12	–	–	–	–	2.70	2.7
						G8330	–	125	0.12	75	0.11	115	0.12	–	–	–	–	–	–
X61 0602-315 L		0.13	14°			6640	–	105	0.12	60	0.11	95	0.12	–	–	–	–	3.05	3
						G8330	–	105	0.12	60	0.11	95	0.12	–	–	–	–	–	–
		0.13	14°			6640	–	125	0.12	75	0.11	115	0.12	–	–	–	–	3.20	3
						G8330	–	105	0.12	60	0.11	95	0.12	–	–	–	–	–	–

X 61 R



	W1 [mm]	CWTOLL [mm]	CWTOLU [mm]	S [mm]
0602	6.350	-0.03	0.03	2.33

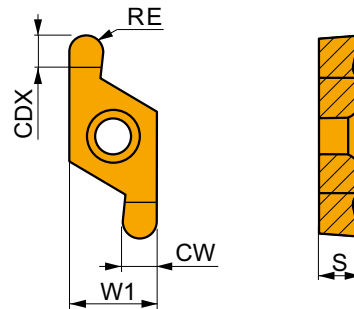

Suitability and starting values for cutting speed (vc) and feed (f). Refer to our Machining Calculator app for further calculations.

Product		RE [mm]	P		M		K		N		S		H		CW [mm]	CDX [mm]			
			vc [m/min]	f [mm/rev]	vc [m/min]	f [mm/rev]	vc [m/min]	f [mm/rev]	vc [m/min]	f [mm/rev]	vc [m/min]	f [mm/rev]	vc [m/min]	f [mm/rev]					
 X61 0602-R100 R		1.0	13°			X 61 R-R external and internal, right-handed geometry, for o-ring and circlip groove machining, with continuous cuts.													
						6640	1.0	170	0.06	100	0.05	160	0.06	–	–	–	–	–	–
X61 0602-R150 R		1.5	13°			6640	1.0	130	0.06	75	0.05	120	0.06	–	–	–	–	2.09	3
						G8330	1.5	170	0.06	100	0.05	160	0.06	–	–	–	–	–	–
X61 0602-R100 L		1.0	13°			6640	1.5	130	0.06	75	0.05	120	0.06	–	–	–	–	3.09	3
						G8330	1.0	170	0.06	100	0.05	160	0.06	–	–	–	–	–	–
X61 0602-R150 L		1.5	13°			6640	1.5	130	0.06	75	0.05	120	0.06	–	–	–	–	3.09	3
						G8330	1.5	130	0.06	75	0.05	120	0.06	–	–	–	–	–	–



P61(RL) EXT

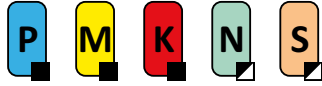

PRAMET

S



External Grooving Tool Holder for X61 Circlips and O-Ring Inserts

External Right/Left hand radial tool holder for grooving with X61 double-sided circlip or O-ring inserts. Gives smooth cutting action for high tolerated dimensions. Available with shank size 16x16 up to 25x25 mm. Body treated for longer tool life.

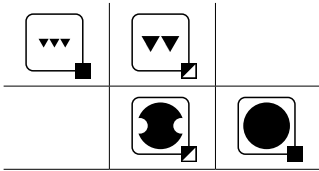
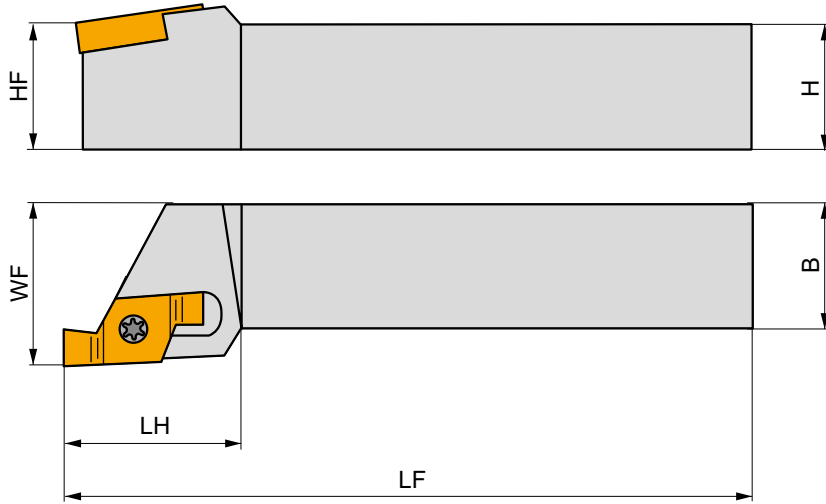
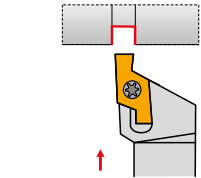

Product	HF	H	B	WF	LH	LF	kg		
	[mm]	[mm]	[mm]	[mm]	[mm]	[mm]			
R P61.SFR-1616H-06	16	16	16	20	100	21	0.23	G332	SV11
P61.SFR-2020K-06	20	20	20	25	125	25	0.40	G332	SV11
P61.SFR-2525M-06	25	25	25	32	150	32	0.73	G332	SV11
L P61.SFL-1616H-06	16	16	16	20	100	21	0.23	G332	SV11
P61.SFL-2020K-06	20	20	20	25	125	25	0.42	G332	SV11
P61.SFL-2525M-06	25	25	25	32	150	32	0.73	G332	SV11



G332



X61 0602..



SV11



US 2003-T07P



0.8



M 2.5



6.5



FLAGT07P



P61(RL) INT



PRAMET

S



Internal Circlip Grooving Boring bar for X61 Insert

Internal Right/Left hand grooving boring bar for grooving with X61 double-sided inserts. Minimum internal grooving diameter Ø16 mm. Suited for internal cutting of circlip or O-ring grooves. Available with shank size Ø12 up to Ø32 mm. Body treated for longer tool life.

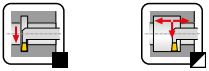
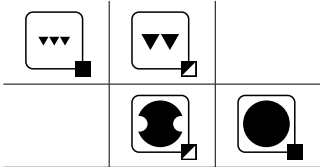
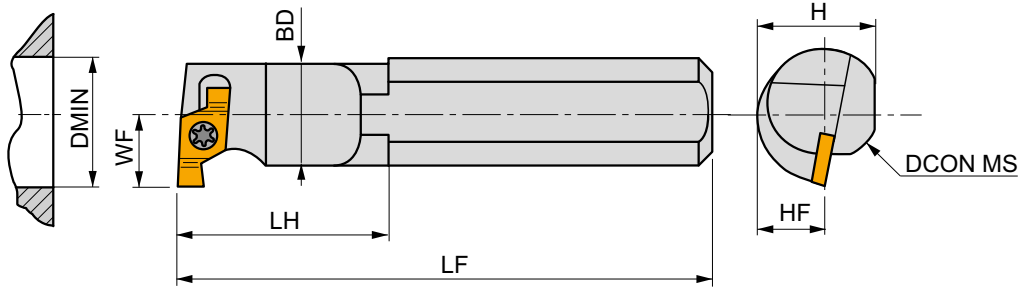
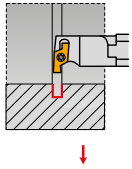

Product	DCON MS	DMIN	BD	WF	H	LF	LH	KAPR					
	[mm]	[mm]	[mm]	[mm]	[mm]	[mm]	[mm]	[°]					
R	P61.SGR-0012M-06	12	16	11.5	9	11	150	22	0	-	0.17	G1332	SV11
	P61.SGR-A-0016M-06	16	20	15	11	15	150	29	0	✓	0.21	G1332	SV11
	P61.SGR-A-0020P-06	20	25	19	13	18	170	29	0	✓	0.38	G1332	SV11
	P61.SGR-A-0025R-06	25	32	24	17	23	200	31	0	✓	0.70	G1332	SV11
	P61.SGR-A-0032T-06	32	40	31	22	30	300	49	0	✓	1.72	G1332	SV11
L	P61.SGL-0012M-06	12	16	11.5	9	11	150	22	0	-	0.17	G1332	SV11
	P61.SGL-A-0016M-06	16	20	15	11	15	150	29	0	✓	0.24	G1332	SV11
	P61.SGL-A-0020P-06	20	25	19	13	18	170	29	0	✓	0.40	G1332	SV11
	P61.SGL-A-0025R-06	25	32	24	17	23	200	31	0	✓	0.72	G1332	SV11
	P61.SGL-A-0032T-06	32	40	31	22	30	300	49	0	✓	1.72	G1332	SV11



G1332



X61 0602..



SV11



US 2003-T07P



0.8



M 2.5



6.5



FLAG T07P

Left hand insert mount to right hand boring bar.



X 61-1



	W1	CWTOLL	CWTOLU	S
	[mm]	[mm]	[mm]	[mm]
0602	6.350	-0.03	0.03	2.33

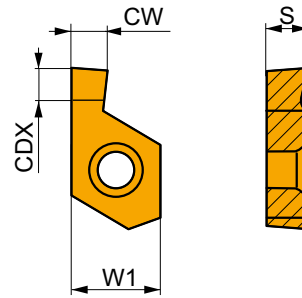

Suitability and starting values for cutting speed (vc) and feed (f). Refer to our Machining Calculator app for further calculations.

Product	RE	P		M		K		N		S		H		CW	CDX
		vc	f	vc	f	vc	f	vc	f	vc	f	vc	f		
	[mm]	[m/min]	[mm/rev]	[m/min]	[mm/rev]	[m/min]	[mm/rev]	[m/min]	[mm/rev]	[m/min]	[mm/rev]	[m/min]	[mm/rev]	[mm]	[mm]

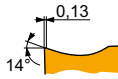

X 61-1-R internal, right-handed design, with one cutting edge for o-ring and circlip groove machining, with continuous cuts.

X61 0602-080 R1	6640	—	■ 195	0.06	▣ 115	0.05	▣ 185	0.06	—	—	—	—	—	0.85	0.8
X61 0602-090 R1	6640	—	■ 195	0.06	▣ 115	0.05	▣ 185	0.06	—	—	—	—	—	0.95	0.8
X61 0602-110 R1	6640	—	■ 185	0.06	▣ 110	0.05	▣ 175	0.06	—	—	—	—	—	1.15	1.2
X61 0602-130 R1	6640	—	■ 185	0.06	▣ 110	0.05	▣ 175	0.06	—	—	—	—	—	1.35	1.4
X61 0602-160 R1	6640	—	■ 180	0.06	▣ 105	0.05	▣ 170	0.06	—	—	—	—	—	1.65	1.7
X61 0602-185 R1	6640	—	■ 150	0.09	▣ 90	0.08	▣ 140	0.09	—	—	—	—	—	1.90	2
X61 0602-215 R1	6640	—	■ 145	0.09	▣ 85	0.08	▣ 135	0.09	—	—	—	—	—	2.20	2.2

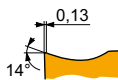

X 61-1-L internal, left-handed design, with one cutting edge for o-ring and circlip groove machining, with continuous cuts.

X61 0602-080 L1	6640	—	■ 195	0.06	▣ 115	0.05	▣ 185	0.06	—	—	—	—	—	0.85	0.8
X61 0602-090 L1	6640	—	■ 195	0.06	▣ 115	0.05	▣ 185	0.06	—	—	—	—	—	0.95	0.8
X61 0602-110 L1	6640	—	■ 185	0.06	▣ 110	0.05	▣ 175	0.06	—	—	—	—	—	1.15	1.2
X61 0602-130 L1	6640	—	■ 185	0.06	▣ 110	0.05	▣ 175	0.06	—	—	—	—	—	1.35	1.4
X61 0602-160 L1	6640	—	■ 180	0.06	▣ 105	0.05	▣ 170	0.06	—	—	—	—	—	1.65	1.7
X61 0602-185 L1	6640	—	■ 150	0.09	▣ 90	0.08	▣ 140	0.09	—	—	—	—	—	1.90	2
X61 0602-215 L1	6640	—	■ 145	0.09	▣ 85	0.08	▣ 135	0.09	—	—	—	—	—	2.20	2.2







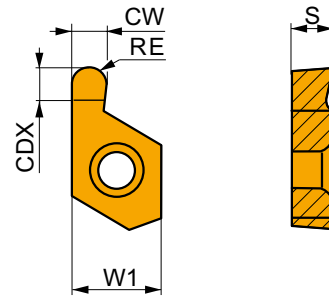

X 61 R-1



	W1	CWTOLL	CWTOLU	S
	[mm]	[mm]	[mm]	[mm]
0602	6.350	-0.03	0.03	2.33



Suitability and starting values for cutting speed (vc) and feed (f). Refer to our Machining Calculator app for further calculations.

Product	RE [mm]	P		M		K		N		S		H		CW [mm]	CDX [mm]	
		vc [m/min]	f [mm/rev]	vc [m/min]	f [mm/rev]	vc [m/min]	f [mm/rev]	vc [m/min]	f [mm/rev]	vc [m/min]	f [mm/rev]	vc [m/min]	f [mm/rev]			
  X 61 R-1-R internal, right-handed design, with one cutting edge for o-ring and circlip groove machining, with continuous cuts.																
	X61 0602-R050 R1	6640	0.5	185	0.06	110	0.05	175	0.06	–	–	–	–	–	–	1.09
X61 0602-R100 R1	6640	1.0	170	0.06	100	0.05	160	0.06	–	–	–	–	–	–	2.09	2.8
  X 61 R-1-L internal, left-handed design, with one cutting edge for o-ring and circlip groove machining, with continuous cuts.																
	X61 0602-R050 L1	6640	0.5	185	0.06	110	0.05	175	0.06	–	–	–	–	–	1.09	1.3
X61 0602-R100 L1	6640	1.0	170	0.06	100	0.05	160	0.06	–	–	–	–	–	2.09	2.8	



P61S(RL)-1 INT

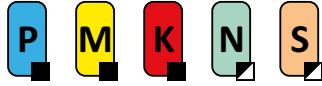

PRAMET

S



Internal Circlip Grooving Boring Bar for X61-1 Insert

Internal Right/Left hand grooving boring bar for grooving with single-sided X61-1 inserts. Minimum internal grooving diameter $\varnothing 12.5$ mm. Suited for internal cutting of circlip or O-ring grooves. Available with shank size $\varnothing 10$ and $\varnothing 12$ mm. Body treated for longer tool life.

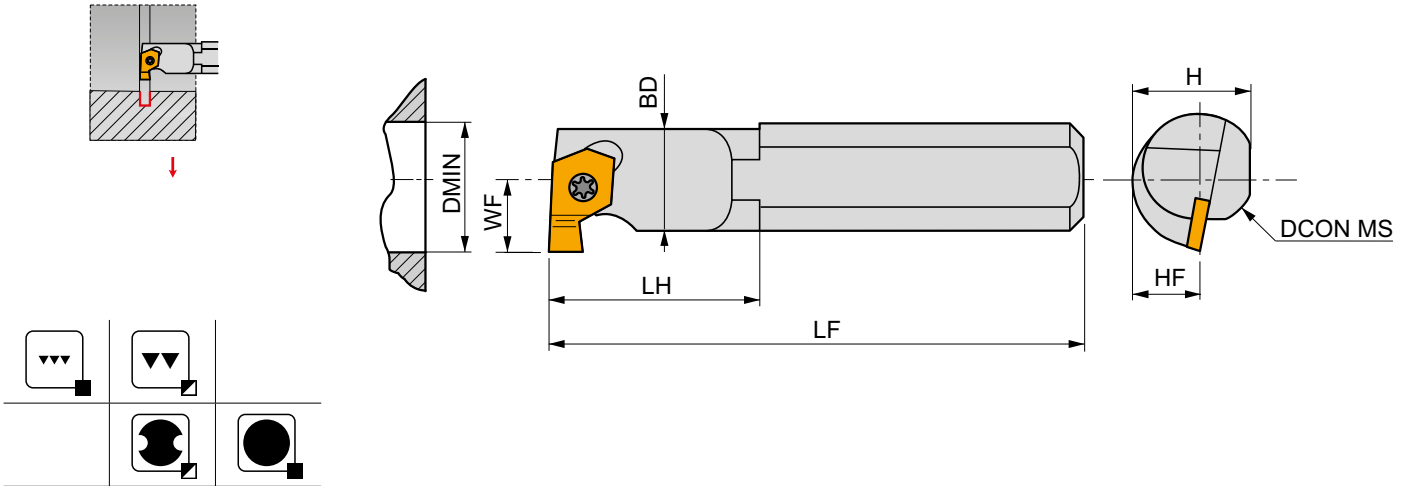

Product	DCON MS	DMIN	BD	WF	H	LF	LH	KAPR	kg	G333	SV11
	[mm]	[mm]	[mm]	[mm]	[mm]	[mm]	[mm]	[°]			
R P61.SGR-0010M-06/1	10	12.5	10	7.5	9	150	19	0	0.24	G333	SV11
	12	12.5	10	7.5	11	150	19	0	0.17	G333	SV11
L P61.SGL-0010M-06/1	10	12.5	10	7.5	9	150	19	0	0.13	G333	SV11
	12	12.5	10	7.5	11	150	19	0	0.17	G333	SV11

G333	X61 0602..-1
------	--------------

SV11	US 2003-T07P	0.8	M 2.5	6.5	FLAG T07P
------	--------------	-----	-------	-----	-----------

Left hand insert mount to right hand boring bar.



TN R EXT

	IC	D1	S	CWTOLL	CWTOLU
	[mm]	[mm]	[mm]	[mm]	[mm]
16	9.525	3.90	3.58	0.00	0.05
22	12.700	4.90	4.70	0.00	0.05

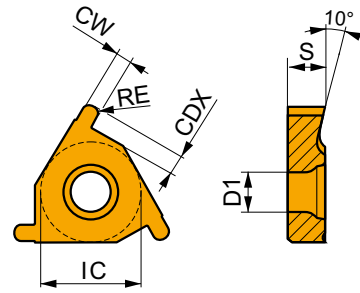

Suitability and starting values for cutting speed (vc) and feed (f). Refer to our Machining Calculator app for further calculations.

Product	RE [mm]	P		M		K		N		S		H		CW [mm]	CDX [mm]
		vc [m/min]	f [mm/rev]	vc [m/min]	f [mm/rev]	vc [m/min]	f [mm/rev]	vc [m/min]	f [mm/rev]	vc [m/min]	f [mm/rev]	vc [m/min]	f [mm/rev]		

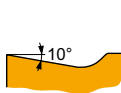

TN ER-R external, right-handed geometry, for o-ring and circlip groove machining, with continuous cuts.

TN 16ER-R050	T8330	0.5	■ 130	0.06	■ 75	0.05	■ 120	0.06	■ —	■ —	■ —	■ —	■ —	1.00	1.3
TN 16ER-R100	T8330	1.0	■ 130	0.06	■ 75	0.05	■ 120	0.06	■ —	■ —	■ —	■ —	■ —	2.00	1.85
TN 22ER-R150	T8330	1.5	■ 130	0.06	■ 75	0.05	■ 120	0.06	■ —	■ —	■ —	■ —	■ —	3.00	2.2

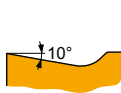

TN EL-R external, left-handed geometry, for o-ring and circlip groove machining, with continuous cuts.

TN 16EL-R050	T8330	0.5	■ 130	0.06	■ 75	0.05	■ 120	0.06	■ —	■ —	■ —	■ —	■ —	1.00	1.3
TN 16EL-R100	T8330	1.0	■ 130	0.06	■ 75	0.05	■ 120	0.06	■ —	■ —	■ —	■ —	■ —	2.00	1.85
TN 22EL-R150	T8330	1.5	■ 130	0.06	■ 75	0.05	■ 120	0.06	■ —	■ —	■ —	■ —	■ —	3.00	2.2

TN R INT

	IC	D1	S	CWTOLL	CWTOLU
	[mm]	[mm]	[mm]	[mm]	[mm]
11	6.350	2.80	3.10	0.00	0.05
16	9.525	3.90	3.58	0.00	0.05
22	12.700	4.90	4.70	0.00	0.05

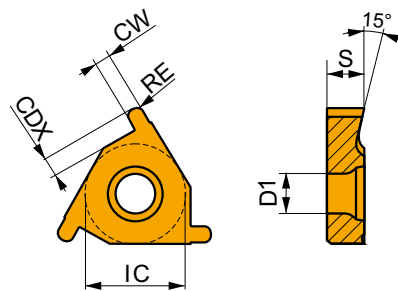

Suitability and starting values for cutting speed (vc) and feed (f). Refer to our Machining Calculator app for further calculations.

Product	RE [mm]	P		M		K		N		S		H		CW [mm]	CDX [mm]
		vc [m/min]	f [mm/rev]	vc [m/min]	f [mm/rev]	vc [m/min]	f [mm/rev]	vc [m/min]	f [mm/rev]	vc [m/min]	f [mm/rev]	vc [m/min]	f [mm/rev]		

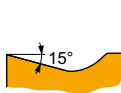

TN NR-R internal, right-handed geometry, for o-ring and circlip groove machining, with continuous cuts.

TN 11NR-R050	T8330	0.5	■ 130	0.06	■ 75	0.05	■ 120	0.06	■ —	■ —	■ —	■ —	■ —	1.00	1.3
TN 16NR-R100	T8330	1.0	■ 130	0.06	■ 75	0.05	■ 120	0.06	■ —	■ —	■ —	■ —	■ —	2.00	1.85
TN 22NR-R150	T8330	1.5	■ 130	0.06	■ 75	0.05	■ 120	0.06	■ —	■ —	■ —	■ —	■ —	3.00	2.2



Suitability and starting values for cutting speed (vc) and feed (f). Refer to our Machining Calculator app for further calculations.

Product	RE [mm]	P		M		K		N		S		H		CW [mm]	CDX [mm]
		vc [m/min]	f [mm/rev]	vc [m/min]	f [mm/rev]	vc [m/min]	f [mm/rev]	vc [m/min]	f [mm/rev]	vc [m/min]	f [mm/rev]	vc [m/min]	f [mm/rev]		

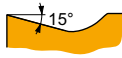

TN NL-R internal, left-handed geometry, for o-ring and circlip groove machining, with continuous cuts.

TN 11NL-R050	T8330	0.5	130	0.06	75	0.05	120	0.06	-	-	-	-	-	1.00	1.3
TN 16NL-R100	T8330	1.0	130	0.06	75	0.05	120	0.06	-	-	-	-	-	2.00	1.85
TN 22NL-R150	T8330	1.5	130	0.06	75	0.05	120	0.06	-	-	-	-	-	3.00	2.2

TN ZZ EXT



	IC [mm]	D1 [mm]	S [mm]
16	9.525	3.90	3.40
22	12.700	4.90	4.70

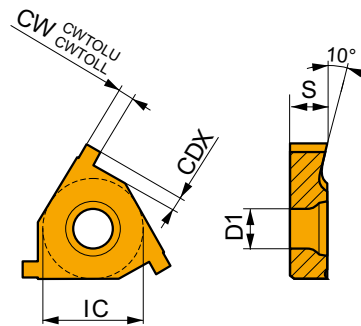

Suitability and starting values for cutting speed (vc) and feed (f). Refer to our Machining Calculator app for further calculations.

Product	RE [mm]	P		M		K		N		S		H		CW [mm]	CWTOLL [mm]	CWTOLU [mm]	CDX [mm]
		vc [m/min]	f [mm/rev]	vc [m/min]	f [mm/rev]	vc [m/min]	f [mm/rev]	vc [m/min]	f [mm/rev]	vc [m/min]	f [mm/rev]	vc [m/min]	f [mm/rev]				

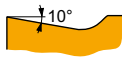
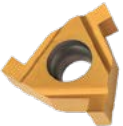

TN ER-ZZ external, right-handed geometry, for o-ring and circlip groove machining, with continuous cuts.

TN 16ER090ZZ	T8330	-	130	0.09	75	0.08	120	0.09	-	-	-	-	-	0.90	0.05	0.10	0.9
TN 16ER110ZZ	T8330	-	130	0.09	75	0.08	120	0.09	-	-	-	-	-	1.10	0.05	0.10	1.3
TN 16ER130ZZ	T8330	-	130	0.09	75	0.08	120	0.09	-	-	-	-	-	1.30	0.05	0.10	1.6
TN 16ER160ZZ	T8330	-	130	0.09	75	0.08	120	0.09	-	-	-	-	-	1.60	0.05	0.10	1.85
TN 16ER185ZZ	T8330	-	130	0.09	75	0.08	120	0.09	-	-	-	-	-	1.85	0.05	0.10	1.85
TN 16ER215ZZ	T8330	-	130	0.09	75	0.08	120	0.09	-	-	-	-	-	2.15	0.05	0.10	1.85
TN 16ER265ZZ	T8330	-	130	0.12	75	0.11	120	0.12	-	-	-	-	-	2.65	0.05	0.10	2.05
TN 22ER265ZZ	T8330	-	130	0.12	75	0.11	120	0.12	-	-	-	-	-	2.65	0.08	0.13	2.2
TN 22ER315ZZ	T8330	-	130	0.12	75	0.11	120	0.12	-	-	-	-	-	3.15	0.08	0.13	2.2
TN 22ER415ZZ	T8330	-	130	0.12	75	0.11	120	0.12	-	-	-	-	-	4.15	0.08	0.13	2.4

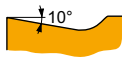

TN EL-ZZ external, left-handed geometry, for o-ring and circlip groove machining, with continuous cuts.

TN 16EL090ZZ	T8330	-	130	0.06	75	0.05	120	0.06	-	-	-	-	-	0.90	0.05	0.10	0.9
TN 16EL110ZZ	T8330	-	130	0.06	75	0.05	120	0.06	-	-	-	-	-	1.10	0.05	0.10	1.3
TN 16EL130ZZ	T8330	-	130	0.06	75	0.05	120	0.06	-	-	-	-	-	1.30	0.05	0.10	1.6
TN 16EL160ZZ	T8330	-	130	0.06	75	0.05	120	0.06	-	-	-	-	-	1.60	0.05	0.10	1.85
TN 16EL185ZZ	T8330	-	130	0.06	75	0.05	120	0.06	-	-	-	-	-	1.85	0.05	0.10	1.85
TN 16EL215ZZ	T8330	-	130	0.09	75	0.08	120	0.09	-	-	-	-	-	2.15	0.05	0.10	1.85
TN 16EL265ZZ	T8330	-	130	0.09	75	0.08	120	0.09	-	-	-	-	-	2.65	0.05	0.10	2.05
TN 22EL265ZZ	T8330	-	130	0.12	75	0.11	120	0.12	-	-	-	-	-	2.65	0.08	0.13	2.2
TN 22EL315ZZ	T8330	-	130	0.12	75	0.11	120	0.12	-	-	-	-	-	3.15	0.08	0.13	2.2
TN 22EL415ZZ	T8330	-	130	0.12	75	0.11	120	0.12	-	-	-	-	-	4.15	0.08	0.13	2.4



TN ZZ INT

	IC	D1	S
	[mm]	[mm]	[mm]
11	6.350	2.80	3.00
16	9.525	3.90	3.40
22	12.700	4.90	4.70

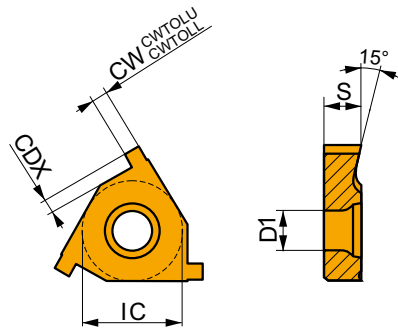

Suitability and starting values for cutting speed (vc) and feed (f). Refer to our Machining Calculator app for further calculations.

Product	RE	P		M		K		N		S		H		CW	CWTOLL	CWTOLU	CDX
		vc	f	vc	f	vc	f	vc	f	vc	f	vc	f				
	[mm]	[m/min]	[mm/rev]	[m/min]	[mm/rev]	[m/min]	[mm/rev]	[m/min]	[mm/rev]	[m/min]	[mm/rev]	[m/min]	[mm/rev]	[mm]	[mm]	[mm]	[mm]

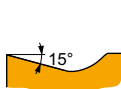

TN NR-ZZ internal, right-handed geometry, for o-ring and circlip groove machining, with continuous cuts.

TN 11NR090ZZ	T8330	-	█	130	0.06	█	75	0.05	█	120	0.06	-	-	-	-	0.90	0.05	0.10	0.9
TN 11NR110ZZ	T8330	-	█	130	0.06	█	75	0.05	█	120	0.06	-	-	-	-	1.10	0.05	0.10	1.3
TN 16NR090ZZ	T8330	-	█	130	0.06	█	75	0.05	█	120	0.06	-	-	-	-	0.90	0.05	0.10	0.9
TN 16NR110ZZ	T8330	-	█	130	0.06	█	75	0.05	█	120	0.06	-	-	-	-	1.10	0.05	0.10	1.3
TN 16NR130ZZ	T8330	-	█	130	0.06	█	75	0.05	█	120	0.06	-	-	-	-	1.30	0.05	0.10	1.6
TN 16NR160ZZ	T8330	-	█	130	0.06	█	75	0.05	█	120	0.06	-	-	-	-	1.60	0.05	0.10	1.85
TN 16NR185ZZ	T8330	-	█	130	0.06	█	75	0.05	█	120	0.06	-	-	-	-	1.85	0.05	0.10	1.85
TN 16NR215ZZ	T8330	-	█	130	0.09	█	75	0.08	█	120	0.09	-	-	-	-	2.15	0.05	0.10	1.85
TN 16NR265ZZ	T8330	-	█	130	0.12	█	75	0.11	█	120	0.12	-	-	-	-	2.65	0.05	0.10	2.05
TN 22NR265ZZ	T8330	-	█	130	0.12	█	75	0.11	█	120	0.12	-	-	-	-	2.65	0.08	0.13	2.2
TN 22NR315ZZ	T8330	-	█	130	0.12	█	75	0.11	█	120	0.12	-	-	-	-	3.15	0.08	0.13	2.2
TN 22NR415ZZ	T8330	-	█	130	0.12	█	75	0.11	█	120	0.12	-	-	-	-	4.15	0.08	0.13	2.4

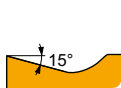
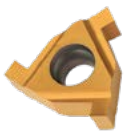

TN NL-ZZ internal, left-handed geometry, for o-ring and circlip groove machining, with continuous cuts.

TN 11NL090ZZ	T8330	-	█	130	0.06	█	75	0.05	█	120	0.06	-	-	-	-	0.90	0.05	0.10	0.9
TN 11NL110ZZ	T8330	-	█	130	0.06	█	75	0.05	█	120	0.06	-	-	-	-	1.10	0.05	0.10	1.3
TN 16NL090ZZ	T8330	-	█	130	0.06	█	75	0.05	█	120	0.06	-	-	-	-	0.90	0.05	0.10	0.9
TN 16NL110ZZ	T8330	-	█	130	0.06	█	75	0.05	█	120	0.06	-	-	-	-	1.10	0.05	0.10	1.3
TN 16NL130ZZ	T8330	-	█	130	0.06	█	75	0.05	█	120	0.06	-	-	-	-	1.30	0.05	0.10	1.6
TN 16NL160ZZ	T8330	-	█	130	0.06	█	75	0.05	█	120	0.06	-	-	-	-	1.60	0.05	0.10	1.85
TN 16NL185ZZ	T8330	-	█	130	0.06	█	75	0.05	█	120	0.06	-	-	-	-	1.85	0.05	0.10	1.85
TN 16NL215ZZ	T8330	-	█	130	0.09	█	75	0.08	█	120	0.09	-	-	-	-	2.15	0.05	0.10	1.85
TN 16NL265ZZ	T8330	-	█	130	0.09	█	75	0.08	█	120	0.09	-	-	-	-	2.65	0.05	0.10	2.05
TN 22NL265ZZ	T8330	-	█	130	0.12	█	75	0.11	█	120	0.12	-	-	-	-	2.65	0.08	0.13	2.2
TN 22NL315ZZ	T8330	-	█	130	0.12	█	75	0.11	█	120	0.12	-	-	-	-	3.15	0.08	0.13	2.2
TN 22NL415ZZ	T8330	-	█	130	0.12	█	75	0.11	█	120	0.12	-	-	-	-	4.15	0.08	0.13	2.4



SE(RL)

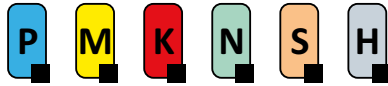

PRAMET

S

External Screw Clamped Threading Holder for TN 16 or 22 Insert

Right/Left hand screw lock tool holder for external threading with TN16 or 22 ER/EL inserts. Suited for threading in metric or inch profile. Also suited for shallow grooving. Body treated for longer tool life.

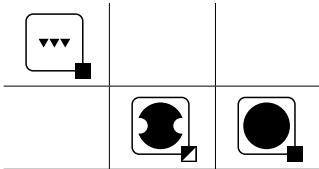
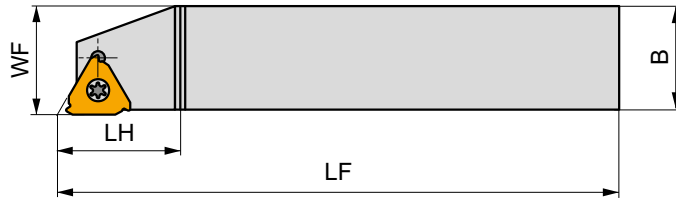
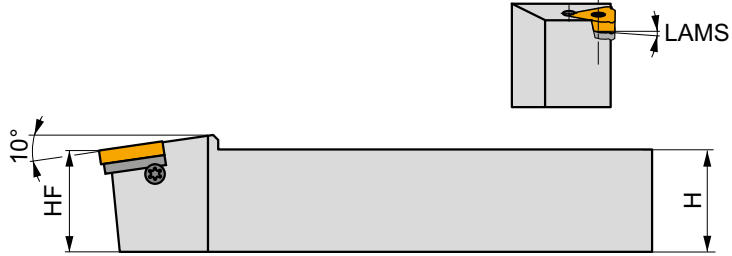
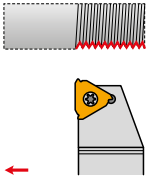

Product	H	H _F	B	WF	LF	H _F	LAMS		
	[mm]	[mm]	[mm]	[mm]	[mm]	[mm]	[°]		
R SER 2020 K 16	20	20	20	20	125	22.5	–	GI068	Z12
SER 2525 M 16	25	25	25	25	150	24	–	GI068	Z12
SER 3225 P 16	32	32	25	25	170	24.5	–	GI068	Z12
SER 2525 M 22-A	25	25	25	25	150	25.5	–	GI071	Z13
SER 3225 P 22-A	32	32	25	25	170	25.5	–	GI071	Z13
L SEL 2020 K 16	20	20	20	20	125	22.5	–	GI068	Z12
SEL 2525 M 16	25	25	25	25	150	24	–	GI068	Z12
SEL 3225 P 16	32	32	25	25	170	24.5	–	GI068	Z12
SEL 2525 M 22-A	25	25	25	25	150	25.5	–	GI071	Z13
SEL 3225 P 22-A	32	32	25	25	170	25.5	–	GI071	Z13

GI068	TN 16ER..	TN 16EL..
GI071	TN 22ER..	TN 22EL..

Z12	US 3512A-T15P	3.0	M 3.5	12.7	–	HS 0304	FLAG T15P	HXK 2.5	Page xx
Z13	US 4514A-T20	5.0	M 4.5	14	SP 0405	–	FLAG T20	–	Page xx



SI(RL)

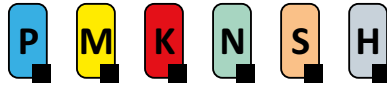

PRAMET

S



Internal Screw Clamped Threading Holder for TN 11, 16 or 22 Insert



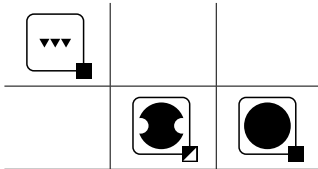
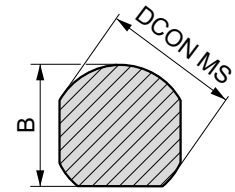
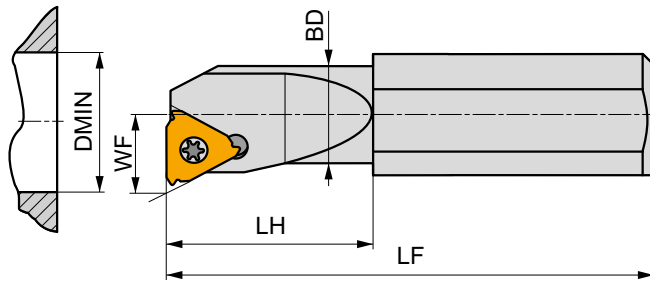
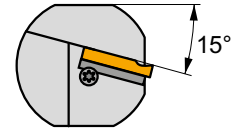
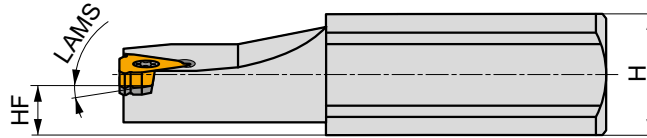
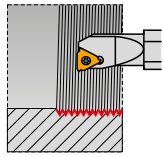







Right/Left hand screw lock boring bar for internal threading with TN11, 16 or 22 ER/EL inserts. Suited for threading in metric or inch profile. Minimum internal diameter Ø13 mm. Also suited for shallow grooving. Available with shank size Ø16 up to Ø40 mm. Body treated for longer tool life.



Product	B	DCON MS	DMIN	BD	WF	H	HF	LF	LH	LAMS	Handedness	Material	Grade	
	[mm]	[mm]	[mm]	[mm]	[mm]	[mm]	[mm]	[mm]	[mm]	[°]				
R	SIR 0010 K 11-0	14.5	16	13	10	7.45	14	7	125	25	0	–	GI085	Z11
	SIR 0010 K 11-1	14.5	16	13	10	7.45	14	7	125	25	1	–	GI085	Z11
	SIR 0013 M 11-0	14.5	16	16	13	9	14	7	150	32	0	–	GI085	Z11
	SIR 0013 M 11-1	14.5	16	16	13	9	14	7	150	32	1	–	GI085	Z11
	SIR 1416 N 16-0	14	16	22	17	11.4	14.5	7.5	160	–	0	–	GI022	Z9
	SIR 1416 N 16-1	14	16	22	17	11.4	14.5	7.5	160	–	1	–	GI022	Z9
	SIR 1416 N 16-2	14	16	16.5	15.5	10.6	14.5	7.5	160	40	2	✓	GI022	Z10
	SIR 1820 P 16	18.5	20	27	21	13.85	18	9	170	–	–	–	GI022	Z12
	SIR 2325 Q 16	23.5	25	29	26	16.55	23	11.5	180	–	–	–	GI022	Z12
	SIR 2532 S 16	30	32	36	32	19.75	25	12.5	250	–	–	–	GI022	Z12
	SIR 2532 S 22-2	30	32	25	25	16.65	25	12.5	250	80	2	✓	GI076	Z14
	SIR 2532 S 22-A	30	32	36	32	21.65	25	12.5	250	–	–	–	GI076	Z13
SIR 3240 T 22-A	38	40	48	40	25.85	32	16	300	–	–	–	GI076	Z13	
L	SIL 0010 K 11-0	14.5	16	13	10	7.45	14	7	125	25	0	–	GI085	Z11
	SIL 0010 K 11-1	14.5	16	13	10	7.55	14	7	125	25	1	–	GI085	Z11
	SIL 0013 M 11-0	14.5	16	16	13	9	14	7	150	32	0	–	GI085	Z11
	SIL 0013 M 11-1	14.5	16	16	13	9	14	7	150	32	1	–	GI085	Z11
	SIL 1416 N 16-0	14	16	22	17	11.4	14.5	7.5	160	–	0	–	GI022	Z9
	SIL 1416 N 16-1	14	16	22	17	11.4	14.5	7.5	160	–	1	–	GI022	Z9
	SIL 1416 N 16-2	14	16	16.5	15.5	10.6	14.5	7.5	160	40	2	✓	GI022	Z10
	SIL 1820 P 16	18.5	20	27	21	13.85	18	9	170	–	–	–	GI022	Z12
	SIL 2325 Q 16	23.5	25	29	26	16.55	23	11.5	180	–	–	–	GI022	Z12
	SIL 2532 S 16	30	32	36	32	19.75	25	12.5	250	–	–	–	GI022	Z12
	SIL 2532 S 22-2	30	32	25	25	16.65	25	12.5	250	80	2	✓	GI076	Z14
	SIL 2532 S 22-A	30	32	36	32	21.65	25	12.5	250	–	–	–	GI076	Z13
SIL 3240 T 22-A	38	40	48	40	25.85	32	16	300	–	–	–	GI076	Z13	



		
GI022	TN 16NR..	TN 16NL..
GI076	TN 22NR..	TN 22NL..
GI085	TN 11NR..	TN 11NL..

		 Nm							
Z10	US 3510A-T15P	3.0	M 3.5	10.6	-	-	FLAG T15P	-	-
Z11	US 2506-T07P	0.9	M 2.5	6.3	-	-	FLAG T07P	-	-
Z12	US 3512A-T15P	3.0	M 3.5	12.7	-	HS 0304	FLAG T15P	HXK 2.5	Page xx
Z13	US 4514A-T20	5.0	M 4.5	14	SP 0405	-	FLAG T20	-	Page xx
Z14	US 4514A-T20	5.0	M 4.5	14	-	-	FLAG T20	-	-
Z9	US 3510A-T15P	3.0	M 3.5	10.6	-	-	FLAG T15P	-	P-16



TECHNICAL INFO

Choice of shim

Helix angle λ	Positive					Negative		for grooving inserts TN16... ZZ, TN22... ZZ
	4,5°	3,5°	2,5°	1,5°	0,5°	-0,5°	-1,5°	
Tool holder	Anvil specification							
SER16; SIL16	PE16+4,5	PE16+3,5	PE16+2,5	PE16+1,5	PE16+0,5	PE16-0,5	PE16-1,5	PE16ZZ
SEL16; SIR16	PI16+4,5	PI16+3,5	PI16+2,5	PI16+1,5	PI16+0,5	PI16-0,5	PI16-1,5	PI16ZZ
SER22; SIL22	PE22+4,5	PE22+3,5	PE22+2,5	PE22+1,5	PE22+0,5	PE22-0,5	PE22-1,5	PE22ZZ
SEL22; SIR22	PI22+4,5	PI22+3,5	PI22+2,5	PI22+1,5	PI22+0,5	PI22-0,5	PI22-1,5	PI22ZZ
SER-S22; SIL-S22	PE22S+4,5	PE22S+3,5	PE22S+2,5	PE22S+1,5	PE22S+0,5	PE22S-0,5	PE22S-1,5	-
SEL-S22; SIR-S22	PI22S+4,5	PI22S+3,5	PI22S+2,5	PI22S+1,5	PI22S+0,5	PI22S-0,5	PI22S-1,5	-

Tool holders are usually supplied with a helix angle $\lambda = 1.5^\circ$. A different helix angle can be selected by changing the anvil.
Shims for holders SER-S, SIR-S are marked with „S“

**THREAD
TURNING**





TURNING – GENERAL CONTENT

6		WMG & ISO 13399
10	ISO TURNING	INSTRUCTIONS
18		NAVIGATORS
57		POSITIVE INSERTS
219		NEGATIVE INSERTS
386		PARTING-OFF & GROOVING
482		THREAD TURNING
528		BROACHING
536		GENERAL TECHNICAL INFORMATION



THREAD TURNING INSERTS – PAGE OVERVIEW



1 TN M INT

	IC [mm]	L [mm]	S [mm]
11	6.350	11.00	3.00
16	9.525	16.50	3.47
22	12.700	22.00	4.71

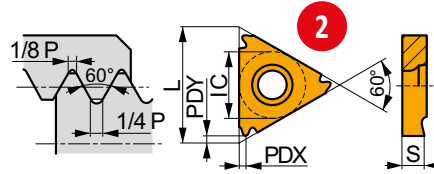

Suitability and starting values for cutting speed (vc). Refer to our Machining Calculator app for further calculations.

Product	RE [mm]	P	M	K	N	S	H	TP [mm]	TPI	PDX [mm]	PDY [mm]
		vc [m/min]	vc [m/min]	vc [m/min]	vc [m/min]	vc [m/min]	vc [m/min]				

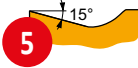

TN M NR internal, right-handed design, for machining ISO M **10** threads, and continuous cuts.

TN 11NR050M	T8010	–	█	175	█	105	█	165	█	–	█	40	–	0.50	–	0.8	0.8
	T8030	–	█	160	█	95	█	150	█	–	█	40	–	0.50	–	0.8	0.8
TN 11NR075M	T8010	–	█	175	█	105	█	165	█	–	█	40	–	0.75	–	0.8	0.8
	T8030	–	█	160	█	95	█	150	█	480	█	40	–	0.75	–	0.8	0.8
TN 11NR100M	T8010	–	█	175	█	105	█	165	█	–	█	40	–	1.00	–	0.8	0.8
	T8030	–	█	160	█	95	█	150	█	480	█	40	–	1.00	–	0.8	0.8
TN 11NR125M	T8010	–	█	175	█	105	█	165	█	–	█	40	–	1.25	–	0.8	0.8
	T8030	–	█	160	█	95	█	150	█	480	█	40	–	1.25	–	0.8	0.8
TN 11NR150M	T8010	–	█	175	█	105	█	165	█	–	█	40	–	1.50	–	0.8	0.8
	T8030	–	█	160	█	95	█	150	█	480	█	40	–	1.50	–	0.8	0.8
TN 11NR200M	T8010	–	█	175	█	105	█	165	█	–	█	40	–	2.00	–	0.9	0.8
	T8030	–	█	160	█	95	█	150	█	480	█	40	–	2.00	–	0.9	0.8
TN 16NR050M	T8010	–	█	175	█	105	█	165	█	–	█	40	–	0.50	–	0.8	0.8
	T8030	–	█	160	█	95	█	150	█	480	█	40	–	0.50	–	0.8	0.8
TN 16NR075M	T8010	–	█	175	█	105	█	165	█	–	█	40	–	0.75	–	0.8	0.8
	T8030	–	█	160	█	95	█	150	█	480	█	40	–	0.75	–	0.8	0.8
TN 16NR100M	T8010	–	█	175	█	105	█	165	█	–	█	40	–	1.00	–	0.8	0.8
	T8030	–	█	160	█	95	█	150	█	480	█	40	–	1.00	–	0.8	0.8
TN 16NR125M	T8010	–	█	175	█	105	█	165	█	–	█	40	–	1.25	–	0.8	0.8

TN 16NR075M:T8010

Use full insert specification code when ordering!

Grade

Include colon

ISO insert code



THREAD TURNING INSERTS – PAGE OVERVIEW

Pos.	Description	Pos.	Description
1	Designation of insert	7	ISO insert code
2	Schematic drawing of insert	8	Grade
3	Table with insert sizes [mm]	9	Insert radii [mm]
4	Picture of representative insert	10	Geometry description
5	Profile of main cutting edge	11	Application area of insert
6	Icons – specific features and cutting edge type		

1 SI(RL)



Internal Screw Clamped Threading Holder for TN 11, 16 or 22 Insert

Right/Left hand screw lock boring bar for internal threading **5** 11, 16 or 22 ER/EL inserts. Suited for threading in metric or inch profile. Minimum internal diameter Ø13 mm. Also suited for shallow grooving. Available with shank size Ø16 up to Ø40 mm. Body treated for longer tool life.

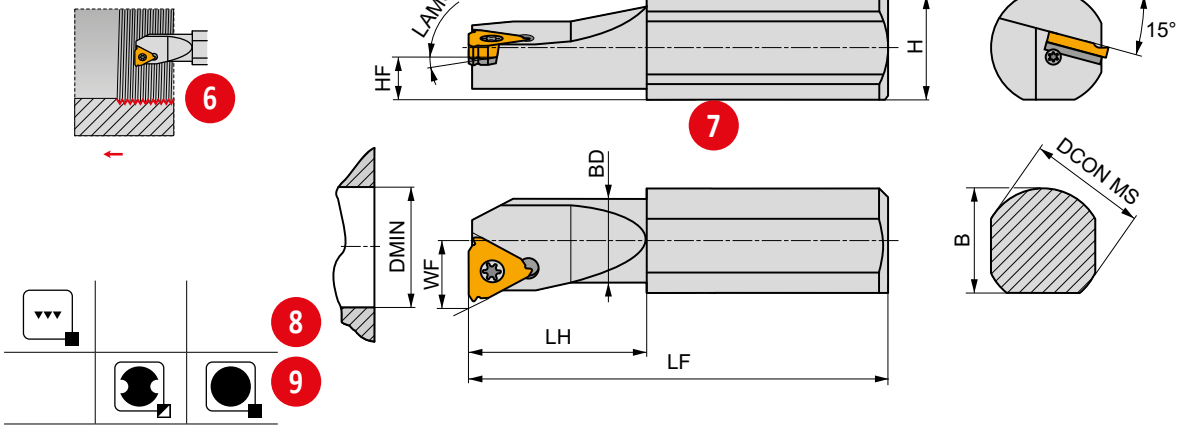

Product	B	DCON MS	DMIN	BD	WF	H	HF	LF	LH	LAMS			
	[mm]	[mm]	[mm]	[mm]	[mm]	[mm]	[mm]	[mm]	[mm]	[°]			
SIR 0010 K 11-0	14.5	16	13	10	7.45	14	7	125	25	0	–	GI085	Z11
SIR 0010 K 11-1	14.5	16	13	10	7.45	14	7	125	25	1	–	GI085	Z11
SIR 0013 M 11-0	14.5	16	16	13	9	14	7	150	32	0	–	GI085	Z11
11 SIR 0013 12	14.5	16	16	13	9	14	7	150	32	1	14	15	16
SIR 1416 N 16-0	14	16	22	17	11.4	14.5	7.5	160	–	0	–	GI022	Z9
SIR 1416 N 16-1	14	16	22	17	11.4	14.5	7.5	160	–	1	–	GI022	Z9
R SIR 1416 N 16-2	14	16	16.5	15.5	10.6	14.5	7.5	160	40	2	✓	GI022	Z10
SIR 1820 P 16	18.5	20	27	21	13.85	18	9	170	–	–	–	GI022	Z12
SIR 2325 Q 16	23.5	25	29	26	16.55	23	11.5	180	–	–	–	GI022	Z12
SIR 2532 S 16	30	32	36	32	19.75	25	12.5	250	–	–	–	GI022	Z12
SIR 2532 S 22-2	30	32	25	25	16.65	25	12.5	250	80	2	✓	GI076	Z14
SIR 2532 S 22-A	30	32	36	32	21.65	25	12.5	250	–	–	–	GI076	Z13
SIR 3240 T 22-A	38	40	48	40	25.85	32	16	300	–	–	–	GI076	Z13

		17	
GI022	TN 16NR..		TN 16NL..
GI076	TN 22NR..		TN 22NL..
GI085	TN 11NR..		TN 11NL..

					18				
Z10	US 3510A-T15P	3.0	M 3.5	10.6	–	–	FLAG T15P	–	–
Z11	US 2506-T07P	0.9	M 2.5	6.3	–	–	FLAG T07P	–	–
Z12	US 3512A-T15P	3.0	M 3.5	12.7	–	HS 0304	FLAG T15P	HXK 2.5	Page xx
Z13	US 4514A-T20	5.0	M 4.5	14	SP 0405	–	FLAG T20	–	Page xx
Z14	US 4514A-T20	5.0	M 4.5	14	–	–	FLAG T20	–	–
Z9	US 3510A-T15P	3.0	M 3.5	10.6	–	–	FLAG T15P	–	P-16



THREAD TURNING HOLDERS – PAGE OVERVIEW

Pos.	Description
1	Designation of thread turning holder
2	Material group recommendations
3	Clamping system of insert
4	Illustrative picture ¹⁾
5	Tool description
6	Workpiece profile
7	Schematic drawing of tool
8	Achievable quality of surface
9	Character of cut/working conditions

Pos.	Description
10	Product applications
11	Tool design
12	ISO code of holder
13	Dimensions [mm] and angles ²⁾ [°] of holder
14	Internal coolant supply
15	Group of compatible inserts ³⁾
16	Group of spare parts ^{3), 4)}
17	Compatible inserts
18	Spare parts

¹⁾ Turning holder is primarily displayed in its right design (R)

²⁾ GAMO = orthogonal rake angle (see technical pages)

LAMS = inclination angle of main cutting edge (see technical pages)









³⁾ Code of Group of compatible inserts, spare parts and special accessories is used only for purposes of this catalogue. It cannot be used for orders.

⁴⁾ Spare parts and special accessories icons are designed schematically for ease of understanding. They aren't included in list of icons. Screws are, in some cases, completed with info on torque value in Nm, length of screw and size of thread.



THREAD TURNING – ICONS OVERVIEW





General icons

 Primary use	 Finishing – very good surface quality	 Suitable for stable working conditions
 Possible use	 Medium machining – good surface quality	 Suitable for unstable working conditions
	 Roughing – unlimited surface roughness	 Suitable for very unstable working conditions

Features

 Thread turning – external	 Thread turning – internal
--	---

Coating

 First choice	 Universal wide range option	 Sharp edge
 For tough materials (long chipping)	 Rounded edge	

Other

 Clamping torque of screw [Nm]	 Internal supply of coolant
--	--



THREADING INSERTS – NAVIGATOR

M

Full profile

TN M EXT

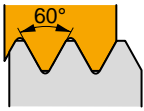

495

TN M INT

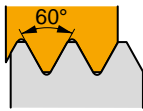

497

M

Partial profile

TN 60° PP EXT

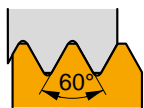

499

TN 60° PP INT

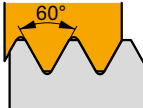

500

TN 60°-S PP EXT

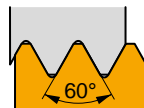

501

TN 60°-S PP INT

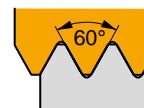

501

MJ

Full profile

TN MJ EXT

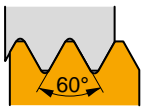

499

UN

Full profile

TN UN EXT

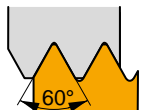

502

TN UN INT

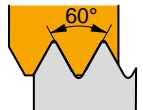

503

UNJ

Full profile

TN UNJ EXT

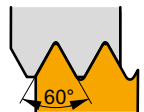

504

W

Full profile

TN W EXT

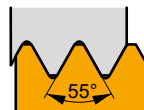

505

TN W INT

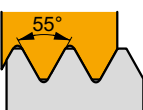

506

W

Partial profile

TN 55° PP EXT

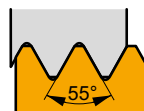

508

TN 55° PP INT

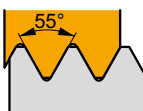

509



THREADING INSERTS – NAVIGATOR

BSPT

Full profile

TN BSPT EXT

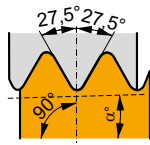

510

TN BSPT INT

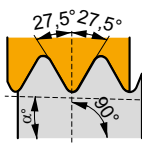

510

NPT

Full profile

TN NPT EXT

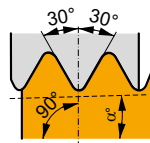

511

TN NPT INT

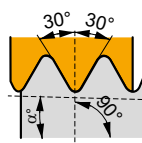

512

TR

Full profile

TN TR EXT

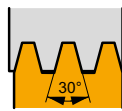

512

TN TR INT

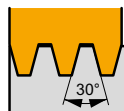

513

TN TR-S EXT

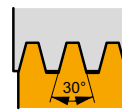

514

TN TR-S INT

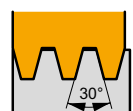

514

ACME

Full profile

TN ACME EXT

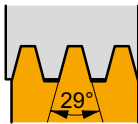

515

TN ACME INT

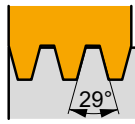

516

STACME

Full profile

TN STACME EXT

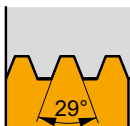

517

TN STACME INT

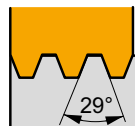

518

API RD

Full profile

TN API RD EXT

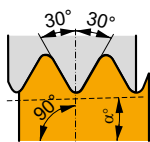

519

TN API RD INT

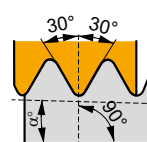

519

RD

Full profile

TN RD EXT

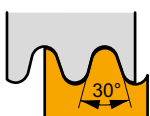

520

TN RD INT

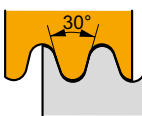

520



THREADING GRADES – NAVIGATOR

Grade Identification	Area of Application	Application	Feed	Cutting speed	Resistance to adverse Working Conditions	Coating	Colour	Substrate	Coolant benefit	Grade description
T8010	P05 - P15	■				PVD	Yellow	submicron H	+++	This grade is suitable for continuous high precision thread turning of steels, stainless steel, cast iron and super alloys. Offering excellent wear resistance while ensuring operational reliability
	M05 - M15	■								
	K10 - K20	■								
	S10 - S15	■								
T8030	P25 - P40	■				PVD	Yellow	submicron H	+++	Undoubtedly the most versatile grade it is suitable for machining all types of materials and can be applied in almost all turning operations. It's main benefits are high operational reliability and excellent frictional properties; it is therefore suited to applications at medium to low cutting speeds.
	M20 - M35	■								
	K20 - K40	■								
	N15 - N30	■								
	S15 - S25	■								
H15 - H25	■									
HF7	M10 - M20	■				X	Grey	submicron H	++	Uncoated grade which is primarily designed for machining non-ferrous metals; but can also be used for other machined materials (except steel). This material can be used in turning, milling, and even boring.
	K10 - K25	■								
	N10 - N25	■								

Substrat

submicron H WC-Co based substrate fine grained (< 1 µm)

Coating

PVD Low-temperature physical method of coating

ISO THREAD TURNING – EXTERNAL

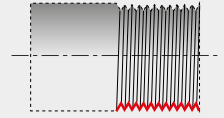

SE(RL)	
TN..	
16 22	
←	
	$\frac{20 \times 20}{32 \times 25}$
522	459 – 521

SE(RL)-S	
TN..	
22	
←	
	$\frac{25 \times 25}{32 \times 25}$
523	459 – 521

ISO THREAD TURNING – INTERNAL

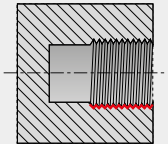

SI(RL)	
TN..	
11 16 22	
←	
	$\frac{13}{48}$
524	459 – 521

SI(RL)-S	
TN..	
22	
←	
	$\frac{39}{48}$
526	459 – 521

INDEXABLE CUTTING INSERTS FOR THREADING ISO – CODE DESIGNATION

ISO	1 T	2 N	3 16	4 E	5 R	6 175	7 M	8 P1
ANSI	1 T	2 N	3 16	4 E	5 R	6 120	7 W	8 P1

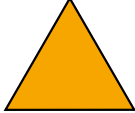
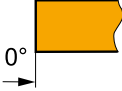
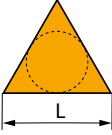
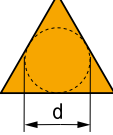
1	1	2	2	3	3	4	4
Insert shape		Insert clearance angle		Insert cutting edge length (insert size)			
T		N					
				L	d = IC		
				[mm]	["]	[mm]	["]
				11	.433"	6,350	1/4"
		16	.650"	9,525	3/8"		
		22	.866"	12,7	1/2"		
						E	External
						N	Internal

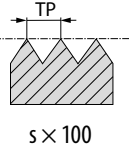
5	5	6	6	7	7
Direction of cut		Thread pitch		Thread profile	
R	Right		Thread Pitch mm × 100	M	Metric 60°
	L				Left
N	Neutral			MJ	SEA MA1370
		6		UN	American UN 60° ISO 5864–1978
		No. of threads		W	Whitworth 55° ISO 228–1982
		No. of threads per inch × 10		UNJ	SEA AS8879
				RD	Round 30°
				ACME	ACME 29° ANSI B1.5–1988

8	8
Chip breaker designation	
P1	Pressed
AL	For nonferrous
BSPT	ISO 228/1 35 21 1959 ISO 7/1
STACME	ASME/ANSI B1.8-1988
NPT	ANSI B1.1–1983
API RD	API



ISO CODE DESIGNATION – HOLDERS THREADING

ISO	1	2	3	-	4	5	6	7	-	8
ANSI	1	2	3	-	4	5	6	7	-	8
	S	E	R	-	S	2525	M	16	-	
	S	E	R	-	S	16	D	16	-	

1		2		3		4				
Clamping designation		Machining orientation		Direction of cut		Type of construction				
C		E	External		R	Right	External		-	Normal
							Internal			
M		I	Internal		L	Left	External		S	Special
							Internal			

5		6		7															
Holder dimensions [mm]		Holder total length [mm]		Insert cutting edge length (insert size)															
External turning	2525	25 × 25 mm		LF [mm]															
				K 125	<table border="1" style="width: 100%; border-collapse: collapse; text-align: center;"> <tr> <th colspan="2">d = IC</th> <th>T</th> </tr> <tr> <td></td> <td></td> <td></td> </tr> <tr> <td>[mm]</td> <td>["]</td> <td></td> </tr> <tr> <td>6.350</td> <td>1/4"</td> <td>11</td> </tr> <tr> <td>9.525</td> <td>3/8"</td> <td>16</td> </tr> <tr> <td>12.700</td> <td>1/2"</td> <td>22</td> </tr> </table>	d = IC		T				[mm]	["]		6.350	1/4"	11	9.525	3/8"
d = IC		T																	
[mm]	["]																		
6.350	1/4"	11																	
9.525	3/8"	16																	
12.700	1/2"	22																	
Internal turning	1416	Shank – 14 mm Shank height Ø – 16 mm		L 140															
				M 150															
				N 160															
				P 170															
				Q 180															
				R 200															
				S 250															
				T 300															

5		6		8			
Tool dimensions ["]		Holder total length ["]		Helix angle λ			
	10	B ["]	H ["]		0	Helix angle λ = 0°	
	12	5/8"	5/8"				C 5.000"
	16	3/4"	3/4"				D 6.000"
	85	1"	1 1/4"				E 7.000"
	86	1"	1 1/2"				F 8.000"
	20	1 1/4"	1 1/4"				K 5.000"
	08	DCON ["]		M 6.000"	1	Helix angle λ = 1°	
	10	.500"		P 6.250"			
	12	.625"		Q 7.250"			
	16	.750"		R 8.000"			
	20	1.000"		S 10.000"			
	24	1.250"		T 12.000"			
			U 14.000"	2	Helix angle λ = 2°		



TN M EXT



	IC	L	S
	[mm]	[mm]	[mm]
16	9.525	16.50	3.47
22	12.700	22.00	4.71

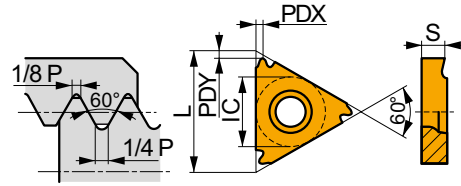

Suitability and starting values for cutting speed (vc). Refer to our Machining Calculator app for further calculations.

Product	RE	P	M	K	N	S	H	TP	TPI	PDX	PDY

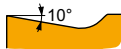

TN M ER external, right-handed design, for machining ISO Metric threads, and continuous cuts.

TN 16ER050M	T8010	-	█	175	█	105	█	165	-	█	40	-	0.50	-	0.8	0.8	
	T8030	-	█	160	█	95	█	150	█	480	█	40	-	0.50	-	0.8	0.8
TN 16ER075M	T8010	-	█	175	█	105	█	165	-	█	40	-	0.75	-	0.8	0.8	
	T8030	-	█	160	█	95	█	150	█	480	█	40	-	0.75	-	0.8	0.8
TN 16ER080M	T8010	-	█	175	█	105	█	165	-	█	40	-	0.80	-	0.6	0.8	
	T8030	-	█	160	█	95	█	150	█	480	█	40	-	0.80	-	0.6	0.8
TN 16ER100M	T8010	-	█	175	█	105	█	165	-	█	40	-	1.00	-	0.8	0.8	
	T8030	-	█	160	█	95	█	150	█	480	█	40	-	1.00	-	0.8	0.8
TN 16ER125M	T8010	-	█	175	█	105	█	165	-	█	40	-	1.25	-	0.8	0.8	
	T8030	-	█	160	█	95	█	150	█	480	█	40	-	1.25	-	0.8	0.8
TN 16ER150M	T8010	-	█	175	█	105	█	165	-	█	40	-	1.50	-	0.8	0.8	
	T8030	-	█	160	█	95	█	150	█	480	█	40	-	1.50	-	0.8	0.8
TN 16ER175M	T8010	-	█	175	█	105	█	165	-	█	40	-	1.75	-	1.5	1.2	
	T8030	-	█	160	█	95	█	150	█	480	█	40	-	1.75	-	1.5	1.2
TN 16ER200M	T8010	-	█	175	█	105	█	165	-	█	40	-	2.00	-	1.5	1.2	
	T8030	-	█	160	█	95	█	150	█	480	█	40	-	2.00	-	1.5	1.2
TN 16ER250M	T8010	-	█	175	█	105	█	165	-	█	40	-	2.50	-	1.5	1.2	
	T8030	-	█	160	█	95	█	150	█	480	█	40	-	2.50	-	1.5	1.2
TN 16ER300M	T8010	-	█	175	█	105	█	165	-	█	40	-	3.00	-	1.5	1.2	
	T8030	-	█	160	█	95	█	150	█	480	█	40	-	3.00	-	1.5	1.2
TN 16ER350M	T8030 ¹⁾	-	█	160	█	95	█	150	█	480	█	40	-	3.50	-	1.7	1.2
TN 22ER350M	T8010	-	█	175	█	105	█	165	-	█	40	-	3.50	-	2.5	1.8	
	T8030	-	█	160	█	95	█	150	█	480	█	40	-	3.50	-	2.5	1.8
TN 22ER400M	T8010	-	█	175	█	105	█	165	-	█	40	-	4.00	-	2.5	1.8	
	T8030	-	█	160	█	95	█	150	█	480	█	40	-	4.00	-	2.5	1.8
TN 22ER450M	T8010	-	█	175	█	105	█	165	-	█	40	-	4.50	-	2.5	1.8	
	T8030	-	█	160	█	95	█	150	█	480	█	40	-	4.50	-	2.5	1.8
TN 22ER500M	T8010	-	█	175	█	105	█	165	-	█	40	-	5.00	-	2.5	1.8	
	T8030	-	█	160	█	95	█	150	█	480	█	40	-	5.00	-	2.5	1.8



TN M EL external, left-handed design, for machining ISO Metric threads, and continuous cuts.

TN 16EL050M	T8030	-	█	160	█	95	█	150	█	480	█	40	-	0.50	-	0.8	0.8
TN 16EL075M	T8030	-	█	160	█	95	█	150	█	480	█	40	-	0.75	-	0.8	0.8
TN 16EL080M	T8030	-	█	160	█	95	█	150	█	480	█	40	-	0.80	-	0.6	0.8
TN 16EL100M	T8010	-	█	175	█	105	█	165	-	█	40	-	1.00	-	0.8	0.8	
	T8030	-	█	160	█	95	█	150	█	480	█	40	-	1.00	-	0.8	0.8
TN 16EL125M	T8010	-	█	175	█	105	█	165	-	█	40	-	1.25	-	0.8	0.8	
	T8030	-	█	160	█	95	█	150	█	480	█	40	-	1.25	-	0.8	0.8



Suitability and starting values for cutting speed (vc). Refer to our Machining Calculator app for further calculations.

Product	RE (mm)	P	M	K	N	S	H	TP	TPI	PDX	PDY

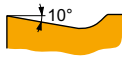

TN M EL external, left-handed design, for machining ISO Metric threads, and continuous cuts.

TN 16EL150M	T8010	–	■	175	▣	105	■	165	▣	–	▣	40	–	–	1.50	–	0.8	0.8
	T8030	–	■	160	■	95	■	150	▣	480	▣	40	–	–	1.50	–	0.8	0.8
TN 16EL175M	T8010	–	■	175	▣	105	■	165	–	–	▣	40	–	–	1.75	–	1.5	1.2
	T8030	–	■	160	▣	95	■	150	▣	480	▣	40	–	–	1.75	–	1.5	1.2
TN 16EL200M	T8010	–	■	175	▣	105	■	165	–	–	▣	40	–	–	2.00	–	1.5	1.2
	T8030	–	■	160	■	95	■	150	▣	480	▣	40	–	–	2.00	–	1.5	1.2
TN 16EL250M	T8010	–	■	175	▣	105	■	165	–	–	▣	40	–	–	2.50	–	1.5	1.2
	T8030	–	■	160	■	95	■	150	▣	480	▣	40	–	–	2.50	–	1.5	1.2
TN 16EL300M	T8010	–	■	175	▣	105	■	165	–	–	▣	40	–	–	3.00	–	1.5	1.2
	T8030	–	■	160	■	95	■	150	▣	480	▣	40	–	–	3.00	–	1.5	1.2
TN 16EL350M	T8030 ¹⁾	–	■	160	■	95	■	150	▣	480	▣	40	–	–	3.50	–	1.7	1.2
TN 22EL350M	T8030	–	■	160	■	95	■	150	▣	480	▣	40	–	–	3.50	–	2.5	1.8
TN 22EL400M	T8030	–	■	160	■	95	■	150	▣	480	▣	40	–	–	4.00	–	2.5	1.8
TN 22EL450M	T8030	–	■	160	■	95	■	150	▣	480	▣	40	–	–	4.50	–	2.5	1.8
TN 22EL500M	T8030	–	■	160	■	95	■	150	▣	480	▣	40	–	–	5.00	–	2.5	1.8

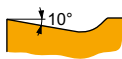

TN M-P1 ER pressed external, right-handed design, for machining ISO Metric threads, and continuous cuts.

TN 16ER100M-P1	T8030	–	■	160	■	95	■	150	▣	480	▣	40	–	–	1.00	–	0.8	0.8
TN 16ER125M-P1	T8030	–	■	160	■	95	■	150	▣	480	▣	40	–	–	1.25	–	0.8	0.8
TN 16ER150M-P1	T8030	–	■	160	■	95	■	150	▣	480	▣	40	–	–	1.50	–	0.8	0.8
TN 16ER175M-P1	T8030	–	■	160	■	95	■	150	▣	480	▣	40	–	–	1.75	–	1.5	1.2
TN 16ER200M-P1	T8030	–	■	160	■	95	■	150	▣	480	▣	40	–	–	2.00	–	1.5	1.2
TN 16ER250M-P1	T8030	–	■	160	■	95	■	150	▣	480	▣	40	–	–	2.50	–	1.5	1.2
TN 16ER300M-P1	T8030	–	■	160	■	95	■	150	▣	480	▣	40	–	–	3.00	–	1.5	1.2

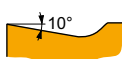
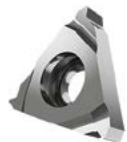

TN M-AL ER external, right-handed design, for machining ISO Metric threads, and continuous cuts.

TN 16ER050M-AL	HF7	–	■	–	▣	95	■	–	■	480	–	–	–	–	0.50	–	0.8	0.8
TN 16ER075M-AL	HF7	–	■	–	▣	95	■	–	■	480	–	–	–	–	0.75	–	0.8	0.8
TN 16ER080M-AL	HF7	–	■	–	▣	95	■	–	■	480	–	–	–	–	0.80	–	0.6	0.8
TN 16ER100M-AL	HF7	–	■	–	▣	95	■	–	■	480	–	–	–	–	1.00	–	0.8	0.8
TN 16ER125M-AL	HF7	–	■	–	▣	95	■	–	■	480	–	–	–	–	1.25	–	0.8	0.8
TN 16ER150M-AL	HF7	–	■	–	▣	95	■	–	■	480	–	–	–	–	1.50	–	0.8	0.8
TN 16ER175M-AL	HF7	–	■	–	▣	95	■	–	■	480	–	–	–	–	1.75	–	1.5	1.2
TN 16ER200M-AL	HF7	–	■	–	▣	95	■	–	■	480	–	–	–	–	2.00	–	1.5	1.2
TN 16ER250M-AL	HF7	–	■	–	▣	95	■	–	■	480	–	–	–	–	2.50	–	1.5	1.2
TN 16ER300M-AL	HF7	–	■	–	▣	95	■	–	■	480	–	–	–	–	3.00	–	1.5	1.2

¹⁾ Toolholders have to be modified.



TN M INT



	IC	L	S
	[mm]	[mm]	[mm]
11	6.350	11.00	3.00
16	9.525	16.50	3.47
22	12.700	22.00	4.71

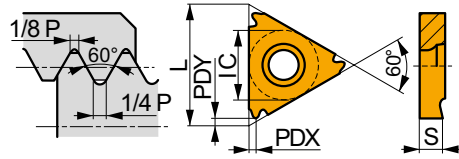

Suitability and starting values for cutting speed (vc). Refer to our Machining Calculator app for further calculations.

Product	RE [mm]	P	M	K	N	S	H	TP [mm]	TPI	PDX [mm]	PDY [mm]
		vc [m/min]	vc [m/min]	vc [m/min]	vc [m/min]	vc [m/min]	vc [m/min]				

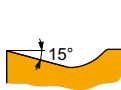
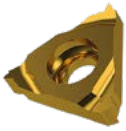

TN M NR internal, right-handed design, for machining ISO Metric threads, and continuous cuts.

TN 11NR050M	T8010	-	█	175	█	105	█	165	-	█	40	-	0.50	-	0.8	0.8	
	T8030	-	█	160	█	95	█	150	█	480	█	40	-	0.50	-	0.8	0.8
TN 11NR075M	T8010	-	█	175	█	105	█	165	-	█	40	-	0.75	-	0.8	0.8	
	T8030	-	█	160	█	95	█	150	█	480	█	40	-	0.75	-	0.8	0.8
TN 11NR100M	T8010	-	█	175	█	105	█	165	-	█	40	-	1.00	-	0.8	0.8	
	T8030	-	█	160	█	95	█	150	█	480	█	40	-	1.00	-	0.8	0.8
TN 11NR125M	T8010	-	█	175	█	105	█	165	-	█	40	-	1.25	-	0.8	0.8	
	T8030	-	█	160	█	95	█	150	█	480	█	40	-	1.25	-	0.8	0.8
TN 11NR150M	T8010	-	█	175	█	105	█	165	-	█	40	-	1.50	-	0.8	0.8	
	T8030	-	█	160	█	95	█	150	█	480	█	40	-	1.50	-	0.8	0.8
TN 11NR200M	T8010	-	█	175	█	105	█	165	-	█	40	-	2.00	-	0.9	0.8	
	T8030	-	█	160	█	95	█	150	█	480	█	40	-	2.00	-	0.9	0.8
TN 16NR050M	T8010	-	█	175	█	105	█	165	-	█	40	-	0.50	-	0.8	0.8	
	T8030	-	█	160	█	95	█	150	█	480	█	40	-	0.50	-	0.8	0.8
TN 16NR075M	T8010	-	█	175	█	105	█	165	-	█	40	-	0.75	-	0.8	0.8	
	T8030	-	█	160	█	95	█	150	█	480	█	40	-	0.75	-	0.8	0.8
TN 16NR100M	T8010	-	█	175	█	105	█	165	-	█	40	-	1.00	-	0.8	0.8	
	T8030	-	█	160	█	95	█	150	█	480	█	40	-	1.00	-	0.8	0.8
TN 16NR125M	T8010	-	█	175	█	105	█	165	-	█	40	-	1.25	-	0.8	0.8	
	T8030	-	█	160	█	95	█	150	█	480	█	40	-	1.25	-	0.8	0.8
TN 16NR150M	T8010	-	█	175	█	105	█	165	-	█	40	-	1.50	-	0.8	0.8	
	T8030	-	█	160	█	95	█	150	█	480	█	40	-	1.50	-	0.8	0.8
TN 16NR175M	T8010	-	█	175	█	105	█	165	-	█	40	-	1.75	-	1.5	1.2	
	T8030	-	█	160	█	95	█	150	█	480	█	40	-	1.75	-	1.5	1.2
TN 16NR200M	T8010	-	█	175	█	105	█	165	-	█	40	-	2.00	-	1.5	1.2	
	T8030	-	█	160	█	95	█	150	█	480	█	40	-	2.00	-	1.5	1.2
TN 16NR250M	T8010	-	█	175	█	105	█	165	-	█	40	-	2.50	-	1.5	1.2	
	T8030	-	█	160	█	95	█	150	█	480	█	40	-	2.50	-	1.5	1.2
TN 16NR300M	T8010	-	█	175	█	105	█	165	-	█	40	-	3.00	-	1.5	1.2	
	T8030	-	█	160	█	95	█	150	█	480	█	40	-	3.00	-	1.5	1.2
TN 16NR350M	T8030 ¹⁾	-	█	160	█	95	█	150	█	480	█	40	-	3.50	-	1.6	1.2
TN 22NR350M	T8010	-	█	175	█	105	█	165	-	█	40	-	3.50	-	2.5	1.8	
	T8030	-	█	160	█	95	█	150	█	480	█	40	-	3.50	-	2.5	1.8
TN 22NR400M	T8010	-	█	175	█	105	█	165	-	█	40	-	4.00	-	2.5	1.8	
	T8030	-	█	160	█	95	█	150	█	480	█	40	-	4.00	-	2.5	1.8
TN 22NR450M	T8010	-	█	175	█	105	█	165	-	█	40	-	4.50	-	2.5	1.8	
	T8030	-	█	160	█	95	█	150	█	480	█	40	-	4.50	-	2.5	1.8
TN 22NR500M	T8010	-	█	175	█	105	█	165	-	█	40	-	5.00	-	2.5	1.8	
	T8030	-	█	160	█	95	█	150	█	480	█	40	-	5.00	-	2.5	1.8



Suitability and starting values for cutting speed (vc). Refer to our Machining Calculator app for further calculations.

Product	RE (mm)	P	M	K	N	S	H	TP	TPI	PDX	PDY

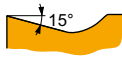

TN M NL internal, left-handed design, for machining ISO Metric threads, and continuous cuts.

TN 11NL050M	T8030	–	■	160	■	95	■	150	▣	480	▣	40	–	0.50	–	0.8	0.8
TN 11NL075M	T8030	–	■	160	■	95	■	150	▣	480	▣	40	–	0.75	–	0.8	0.8
TN 11NL100M	T8030	–	■	160	■	95	■	150	▣	480	▣	40	–	1.00	–	0.8	0.8
TN 11NL125M	T8030	–	■	160	■	95	■	150	▣	480	▣	40	–	1.25	–	0.8	0.8
TN 11NL150M	T8010	–	■	175	▣	105	■	165	▣	–	▣	40	–	1.50	–	0.8	0.8
	T8030	–	■	160	■	95	■	150	▣	480	▣	40	–	1.50	–	0.8	0.8
TN 11NL200M	T8010	–	■	175	▣	105	■	165	▣	–	▣	40	–	2.00	–	0.9	0.8
	T8030	–	■	160	■	95	■	150	▣	480	▣	40	–	2.00	–	0.9	0.8
TN 16NL050M	T8030	–	■	160	■	95	■	150	▣	480	▣	40	–	0.50	–	0.8	0.8
TN 16NL075M	T8030	–	■	160	■	95	■	150	▣	480	▣	40	–	0.75	–	0.8	0.8
TN 16NL100M	T8010	–	■	175	▣	105	■	165	▣	–	▣	40	–	1.00	–	0.8	0.8
	T8030	–	■	160	■	95	■	150	▣	480	▣	40	–	1.00	–	0.8	0.8
TN 16NL125M	T8010	–	■	175	▣	105	■	165	▣	–	▣	40	–	1.25	–	0.8	0.8
	T8030	–	■	160	■	95	■	150	▣	480	▣	40	–	1.25	–	0.8	0.8
TN 16NL150M	T8010	–	■	175	▣	105	■	165	▣	–	▣	40	–	1.50	–	0.8	0.8
	T8030	–	■	160	■	95	■	150	▣	480	▣	40	–	1.50	–	0.8	0.8
TN 16NL175M	T8010	–	■	175	▣	105	■	165	▣	–	▣	40	–	1.75	–	1.5	1.2
	T8030	–	■	160	■	95	■	150	▣	480	▣	40	–	1.75	–	1.5	1.2
TN 16NL200M	T8010	–	■	175	▣	105	■	165	▣	–	▣	40	–	2.00	–	1.5	1.2
	T8030	–	■	160	■	95	■	150	▣	480	▣	40	–	2.00	–	1.5	1.2
TN 16NL250M	T8010	–	■	175	▣	105	■	165	▣	–	▣	40	–	2.50	–	1.5	1.2
	T8030	–	■	160	■	95	■	150	▣	480	▣	40	–	2.50	–	1.5	1.2
TN 16NL300M	T8010	–	■	175	▣	105	■	165	▣	–	▣	40	–	3.00	–	1.5	1.2
	T8030	–	■	160	■	95	■	150	▣	480	▣	40	–	3.00	–	1.5	1.2
TN 16NL350M	T8030 ¹⁾	–	■	160	■	95	■	150	▣	480	▣	40	–	3.50	–	1.6	1.2
TN 22NL350M	T8030	–	■	160	■	95	■	150	▣	480	▣	40	–	3.50	–	2.5	1.8
TN 22NL400M	T8030	–	■	160	■	95	■	150	▣	480	▣	40	–	4.00	–	2.5	1.8
TN 22NL500M	T8030	–	■	160	■	95	■	150	▣	480	▣	40	–	5.00	–	2.5	1.8

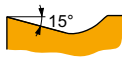

TN M-P1 NR pressed internal, right-handed design, for machining ISO Metric threads, and continuous cuts.

TN 11NR100M-P1	T8030	–	■	160	■	95	■	150	▣	480	▣	40	–	1.00	–	0.8	0.8
TN 11NR150M-P1	T8030	–	■	160	■	95	■	150	▣	480	▣	40	–	1.50	–	0.8	0.8
TN 16NR100M-P1	T8030	–	■	160	■	95	■	150	▣	480	▣	40	–	1.00	–	0.8	0.8
TN 16NR150M-P1	T8030	–	■	160	■	95	■	150	▣	480	▣	40	–	1.50	–	0.8	0.8
TN 16NR200M-P1	T8030	–	■	160	■	95	■	150	▣	480	▣	40	–	2.00	–	1.5	1.2
TN 16NR250M-P1	T8030	–	■	160	■	95	■	150	▣	480	▣	40	–	2.50	–	1.5	1.2
TN 16NR300M-P1	T8030	–	■	160	■	95	■	150	▣	480	▣	40	–	3.00	–	1.5	1.2

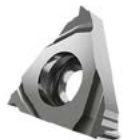

TN M-AL NR internal, right-handed design, for machining ISO Metric threads, and continuous cuts.

TN 16NR050M-AL	HF7	–	■	–	▣	95	■	–	■	480	–	–	–	0.50	–	0.8	0.8
TN 16NR075M-AL	HF7	–	■	–	▣	95	■	–	■	480	–	–	–	0.75	–	0.8	0.8
TN 16NR100M-AL	HF7	–	■	–	▣	95	■	–	■	480	–	–	–	1.00	–	0.8	0.8
TN 16NR125M-AL	HF7	–	■	–	▣	95	■	–	■	480	–	–	–	1.25	–	0.8	0.8
TN 16NR150M-AL	HF7	–	■	–	▣	95	■	–	■	480	–	–	–	1.50	–	0.8	0.8
TN 16NR175M-AL	HF7	–	■	–	▣	95	■	–	■	480	–	–	–	1.75	–	1.5	1.2
TN 16NR200M-AL	HF7	–	■	–	▣	95	■	–	■	480	–	–	–	2.00	–	1.5	1.2
TN 16NR250M-AL	HF7	–	■	–	▣	95	■	–	■	480	–	–	–	2.50	–	1.5	1.2
TN 16NR300M-AL	HF7	–	■	–	▣	95	■	–	■	480	–	–	–	3.00	–	1.5	1.2

¹⁾ Toolholders have to be modified.



TN MJ EXT

	IC [mm]	L [mm]	S [mm]
16	9.525	16.50	3.47

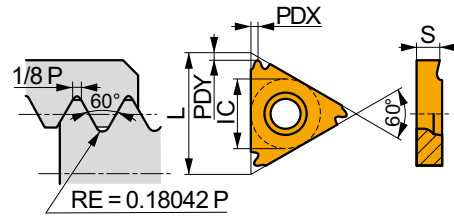

Suitability and starting values for cutting speed (vc). Refer to our Machining Calculator app for further calculations.

Product	RE [mm]	P	M	K	N	S	H	TP [mm]	TPI	PDX [mm]	PDY [mm]
		vc [m/min]	vc [m/min]	vc [m/min]	vc [m/min]	vc [m/min]	vc [m/min]				

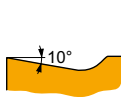

TN MJ ER external, right-handed design, for machining Metric "J form" threads, and continuous cuts.

TN 16ER100MJ	T8030	-	█	160	█	95	█	150	█	480	█	40	-	1.00	-	0.8	0.8
TN 16ER150MJ	T8030	-	█	160	█	95	█	150	█	480	█	40	-	1.50	-	0.8	0.8

TN 60° PP EXT

	IC [mm]	L [mm]	S [mm]
16	9.525	16.50	3.47
22	12.700	22.00	4.71

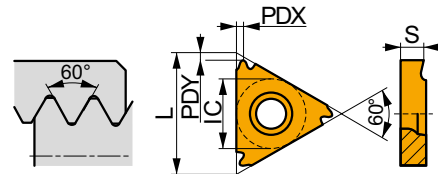

Suitability and starting values for cutting speed (vc). Refer to our Machining Calculator app for further calculations.

Product	RE [mm]	P	M	K	N	S	H	TPN [mm]	TPX [mm]	TPIN	TPIX	PDX [mm]	PDY [mm]
		vc [m/min]	vc [m/min]	vc [m/min]	vc [m/min]	vc [m/min]	vc [m/min]						

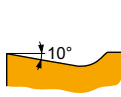

TN 60° PP ER external, right-handed design, for machining Metric and Unified threads, and continuous cuts.

TN 16ERA60	T8010	-	█	175	█	105	█	165	█	-	█	40	-	0.50	1.50	16	48	0.8	0.6
	T8030	-	█	160	█	95	█	150	█	480	█	40	-	0.50	1.50	16	48	0.8	0.6
TN 16ERAG60	T8010	-	█	175	█	105	█	165	█	-	█	40	-	0.50	3.00	8	48	1.5	1.1
	T8030	-	█	160	█	95	█	150	█	480	█	40	-	0.50	3.00	8	48	1.5	1.1
TN 16ERG60	T8010	-	█	175	█	105	█	165	█	-	█	40	-	1.75	3.00	8	14	1.5	1.1
	T8030	-	█	160	█	95	█	150	█	480	█	40	-	1.75	3.00	8	14	1.5	1.1
TN 22ERN60	T8010	-	█	175	█	105	█	165	█	-	█	40	-	3.50	5.00	5	7	2.5	1.8
	T8030	-	█	160	█	95	█	150	█	480	█	40	-	3.50	5.00	5	7	2.5	1.8



Suitability and starting values for cutting speed (vc). Refer to our Machining Calculator app for further calculations.

Product	RE [mm]	P	M	K	N	S	H	TPN [mm]	TPX [mm]	TPIN	TPIX	PDX [mm]	PDY [mm]
		vc [m/min]	vc [m/min]	vc [m/min]	vc [m/min]	vc [m/min]	vc [m/min]						

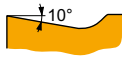
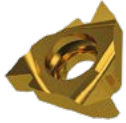

TN M60 PP EL external, left-handed design, for machining Metric and Unified threads, and continuous cuts.

TN 16ELA60	T8030	–	■	160	■	95	■	150	▣	480	▣	40	–	0.50	1.50	16	48	0.8	0.6
TN 16ELAG60	T8010	–	■	175	▣	105	■	165	–	–	▣	40	–	0.50	3.00	8	48	1.5	1.1
	T8030	–	■	160	■	95	■	150	▣	480	▣	40	–	0.50	3.00	8	48	1.5	1.1
TN 16ELG60	T8030	–	■	160	■	95	■	150	▣	480	▣	40	–	1.75	3.00	8	14	1.5	1.1
TN 22ELN60	T8030	–	■	160	■	95	■	150	▣	480	▣	40	–	3.50	5.00	5	7	2.5	1.8

TN 60° PP INT



	IC [mm]	L [mm]	S [mm]
11	6.350	11.00	3.00
16	9.525	16.50	3.47
22	12.700	22.00	4.71

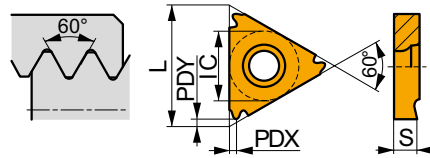

Suitability and starting values for cutting speed (vc). Refer to our Machining Calculator app for further calculations.

Product	RE [mm]	P	M	K	N	S	H	TPN [mm]	TPX [mm]	TPIN	TPIX	PDX [mm]	PDY [mm]
		vc [m/min]	vc [m/min]	vc [m/min]	vc [m/min]	vc [m/min]	vc [m/min]						

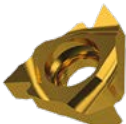

TN M60 PP NR internal, right-handed design, for machining Metric and Unified threads, and continuous cuts.

TN 11NRA60	T8010	–	■	175	▣	105	■	165	–	–	▣	40	–	0.50	1.50	16	48	0.8	0.7
	T8030	–	■	160	■	95	■	150	▣	480	▣	40	–	0.50	1.50	16	48	0.8	0.7
TN 16NRA60	T8010	–	■	175	▣	105	■	165	–	–	▣	40	–	0.50	1.50	16	48	0.8	0.7
	T8030	–	■	160	■	95	■	150	▣	480	▣	40	–	0.50	1.50	16	48	0.8	0.7
TN 16NRAG60	T8010	–	■	175	▣	105	■	165	–	–	▣	40	–	0.50	3.00	8	48	1.5	1.1
	T8030	–	■	160	■	95	■	150	▣	480	▣	40	–	0.50	3.00	8	48	1.5	1.1
TN 16NRG60	T8010	–	■	175	▣	105	■	165	–	–	▣	40	–	1.75	3.00	8	14	1.5	1.1
	T8030	–	■	160	■	95	■	150	▣	480	▣	40	–	1.75	3.00	8	14	1.5	1.1
TN 22NRN60	T8010	–	■	175	▣	105	■	165	–	–	▣	40	–	3.50	5.00	5	7	2.5	1.8
	T8030	–	■	160	■	95	■	150	▣	480	▣	40	–	3.50	5.00	5	7	2.5	1.8



TN M60 PP NL internal, left-handed design, for machining Metric and Unified threads, and continuous cuts.

TN 11NLA60	T8030	–	■	160	■	95	■	150	▣	480	▣	40	–	0.50	1.50	16	48	0.8	0.7
TN 16NLA60	T8030	–	■	160	■	95	■	150	▣	480	▣	40	–	0.50	1.50	16	48	0.8	0.7
TN 16NLAG60	T8010	–	■	175	▣	105	■	165	–	–	▣	40	–	0.50	3.00	8	48	1.5	1.1
	T8030	–	■	160	■	95	■	150	▣	480	▣	40	–	0.50	3.00	8	48	1.5	1.1
TN 16NLG60	T8030	–	■	160	■	95	■	150	▣	480	▣	40	–	1.75	3.00	8	14	1.5	1.1
TN 22NLN60	T8030	–	■	160	■	95	■	150	▣	480	▣	40	–	3.50	5.00	5	7	2.5	1.8



TN 60°-S PP EXT

	IC [mm]	L [mm]	S [mm]
22	12.700	22.00	4.60

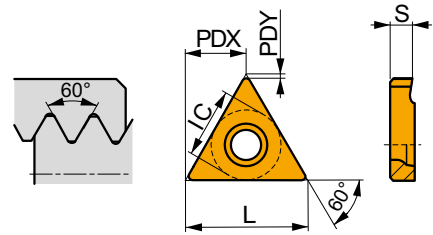

Suitability and starting values for cutting speed (vc). Refer to our Machining Calculator app for further calculations.

Product	RE [mm]	P	M	K	N	S	H	TPN [mm]	TPX [mm]	TPIN [mm]	TPIX [mm]	PDX [mm]	PDY [mm]
		vc [m/min]	vc [m/min]	vc [m/min]	vc [m/min]	vc [m/min]	vc [m/min]						

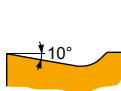

TN M60-S PP EN external, left and right-handed design, for machining Metric and Unified threads, and continuous cuts.

TN 22EN350-500M	T8030	-	160	95	150	480	40	-	3.50	5.00	5	7	11.0	0.5
TN 22EN550-800M	T8030	-	160	95	150	480	40	-	5.50	8.00	3	4.5	11.0	0.8

TN 60°-S PP INT

	IC [mm]	L [mm]	S [mm]
22	12.700	22.00	4.60

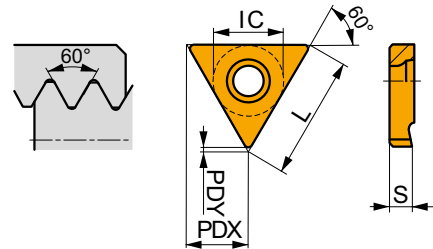

Suitability and starting values for cutting speed (vc). Refer to our Machining Calculator app for further calculations.

Product	RE [mm]	P	M	K	N	S	H	TPN [mm]	TPX [mm]	TPIN [mm]	TPIX [mm]	PDX [mm]	PDY [mm]
		vc [m/min]	vc [m/min]	vc [m/min]	vc [m/min]	vc [m/min]	vc [m/min]						

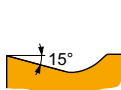
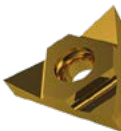

TN M60-S PP NN internal, left and right-handed design, for machining Metric and Unified threads, and continuous cuts.

TN 22NN350-500M	T8030	-	160	95	150	480	40	-	3.50	5.00	5	7	11.0	0.2
TN 22NN550-800M	T8030	-	160	95	150	480	40	-	5.50	8.00	3	4.5	11.0	0.5



TN UN EXT



	IC	L	S
	[mm]	[mm]	[mm]
16	9.525	16.50	3.47
22	12.700	22.00	4.71

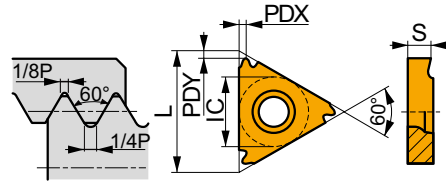

Suitability and starting values for cutting speed (vc). Refer to our Machining Calculator app for further calculations.

Product	RE	P	M	K	N	S	H	TP	TPI	PDX	PDY

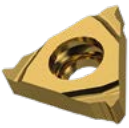

TN UN ER external, right-handed design, for machining Unified threads and continuous cuts.

TN 16ER320UN	T8030	–	■	160	■	95	■	150	■	480	■	40	–	–	32.0	0.8	0.8
TN 16ER280UN	T8030	–	■	160	■	95	■	150	■	480	■	40	–	–	28.0	0.8	0.8
TN 16ER240UN	T8030	–	■	160	■	95	■	150	■	480	■	40	–	–	24.0	0.8	0.8
TN 16ER200UN	T8010	–	■	175	■	105	■	165	■	–	■	40	–	–	20.0	0.8	0.8
	T8030	–	■	160	■	95	■	150	■	480	■	40	–	–	20.0	0.8	0.8
TN 16ER180UN	T8030	–	■	160	■	95	■	150	■	480	■	40	–	–	18.0	0.8	0.8
TN 16ER160UN	T8030	–	■	160	■	95	■	150	■	480	■	40	–	–	16.0	0.8	0.8
TN 16ER140UN	T8030	–	■	160	■	95	■	150	■	480	■	40	–	–	14.0	1.5	1.2
TN 16ER130UN	T8030	–	■	160	■	95	■	150	■	480	■	40	–	–	13.0	1.5	1.2
TN 16ER120UN	T8030	–	■	160	■	95	■	150	■	480	■	40	–	–	12.0	1.5	1.2
TN 16ER115UN	T8030	–	■	160	■	95	■	150	■	480	■	40	–	–	11.5	1.5	1.2
TN 16ER110UN	T8030	–	■	160	■	95	■	150	■	480	■	40	–	–	11.0	1.5	1.2
TN 16ER100UN	T8030	–	■	160	■	95	■	150	■	480	■	40	–	–	10.0	1.5	1.2
TN 16ER090UN	T8030	–	■	160	■	95	■	150	■	480	■	40	–	–	9.0	1.5	1.2
TN 16ER080UN	T8030	–	■	160	■	95	■	150	■	480	■	40	–	–	8.0	1.5	1.2
TN 22ER070UN	T8030	–	■	160	■	95	■	150	■	480	■	40	–	–	7.0	2.5	1.8
TN 22ER060UN	T8030	–	■	160	■	95	■	150	■	480	■	40	–	–	6.0	2.5	1.8
TN 22ER050UN	T8030	–	■	160	■	95	■	150	■	480	■	40	–	–	5.0	2.5	1.8

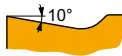
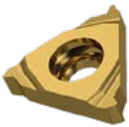

TN UN EL external, left-handed design, for machining Unified threads, and continuous cuts.

TN 16EL320UN	T8030	–	■	160	■	95	■	150	■	480	■	40	–	–	32.0	0.8	0.8
TN 16EL280UN	T8030	–	■	160	■	95	■	150	■	480	■	40	–	–	28.0	0.8	0.8
TN 16EL240UN	T8030	–	■	160	■	95	■	150	■	480	■	40	–	–	24.0	0.8	0.8
TN 16EL200UN	T8030	–	■	160	■	95	■	150	■	480	■	40	–	–	20.0	0.8	0.8
TN 16EL180UN	T8030	–	■	160	■	95	■	150	■	480	■	40	–	–	18.0	0.8	0.8
TN 16EL160UN	T8030	–	■	160	■	95	■	150	■	480	■	40	–	–	16.0	0.8	0.8
TN 16EL140UN	T8030	–	■	160	■	95	■	150	■	480	■	40	–	–	14.0	1.5	1.2
TN 16EL120UN	T8030	–	■	160	■	95	■	150	■	480	■	40	–	–	12.0	1.5	1.2
TN 16EL110UN	T8030	–	■	160	■	95	■	150	■	480	■	40	–	–	11.0	1.5	1.2
TN 16EL100UN	T8030	–	■	160	■	95	■	150	■	480	■	40	–	–	10.0	1.5	1.2
TN 16EL090UN	T8030	–	■	160	■	95	■	150	■	480	■	40	–	–	9.0	1.5	1.2
TN 16EL080UN	T8030	–	■	160	■	95	■	150	■	480	■	40	–	–	8.0	1.5	1.2
TN 22EL070UN	T8030	–	■	160	■	95	■	150	■	480	■	40	–	–	7.0	2.5	1.8
TN 22EL060UN	T8030	–	■	160	■	95	■	150	■	480	■	40	–	–	6.0	2.5	1.8
TN 22EL050UN	T8030	–	■	160	■	95	■	150	■	480	■	40	–	–	5.0	2.5	1.8



Suitability and starting values for cutting speed (vc). Refer to our Machining Calculator app for further calculations.

Product	RE [mm]	P	M	K	N	S	H	TP [mm]	TPI	PDX [mm]	PDY [mm]
		vc [m/min]	vc [m/min]	vc [m/min]	vc [m/min]	vc [m/min]	vc [m/min]				

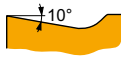

TN UN-P1 ER pressed external, right-handed design, for machining Unified threads, and continuous cuts.

TN 16ER200UN-P1	T8030	-	■	160	■	95	■	150	▣	480	▣	40	-	-	20.0	0.8	0.8
TN 16ER180UN-P1	T8030	-	■	160	■	95	■	150	▣	480	▣	40	-	-	18.0	0.8	0.8
TN 16ER160UN-P1	T8030	-	■	160	■	95	■	150	▣	480	▣	40	-	-	16.0	0.8	0.8
TN 16ER140UN-P1	T8030	-	■	160	■	95	■	150	▣	480	▣	40	-	-	14.0	1.5	1.2
TN 16ER120UN-P1	T8030	-	■	160	■	95	■	150	▣	480	▣	40	-	-	12.0	1.5	1.2
TN 16ER080UN-P1	T8030	-	■	160	■	95	■	150	▣	480	▣	40	-	-	8.0	1.5	1.2

TN UN INT



	IC [mm]	L [mm]	S [mm]
16	9.525	16.50	3.47
22	12.700	22.00	4.71

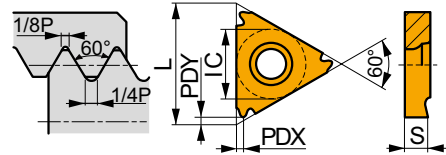

Suitability and starting values for cutting speed (vc). Refer to our Machining Calculator app for further calculations.

Product	RE [mm]	P	M	K	N	S	H	TP [mm]	TPI	PDX [mm]	PDY [mm]
		vc [m/min]	vc [m/min]	vc [m/min]	vc [m/min]	vc [m/min]	vc [m/min]				

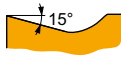
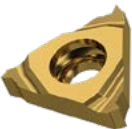

TN UN NR internal, right-handed design, for machining Unified threads, and continuous cuts.

TN 16NR320UN	T8030	-	■	160	■	95	■	150	▣	480	▣	40	-	-	32.0	0.8	0.8
TN 16NR280UN	T8030	-	■	160	■	95	■	150	▣	480	▣	40	-	-	28.0	0.8	0.8
TN 16NR240UN	T8030	-	■	160	■	95	■	150	▣	480	▣	40	-	-	24.0	0.8	0.8
TN 16NR200UN	T8010	-	■	175	▣	105	■	165	-	-	▣	40	-	-	20.0	0.8	0.8
	T8030	-	■	160	■	95	■	150	▣	480	▣	40	-	-	20.0	0.8	0.8
TN 16NR180UN	T8030	-	■	160	■	95	■	150	▣	480	▣	40	-	-	18.0	0.8	0.8
TN 16NR160UN	T8030	-	■	160	■	95	■	150	▣	480	▣	40	-	-	16.0	0.8	0.8
TN 16NR140UN	T8030	-	■	160	■	95	■	150	▣	480	▣	40	-	-	14.0	1.5	1.2
TN 16NR130UN	T8030	-	■	160	■	95	■	150	▣	480	▣	40	-	-	13.0	1.5	1.2
TN 16NR120UN	T8010	-	■	175	▣	105	■	165	-	-	▣	40	-	-	12.0	1.5	1.2
	T8030	-	■	160	■	95	■	150	▣	480	▣	40	-	-	12.0	1.5	1.2
TN 16NR115UN	T8030	-	■	160	■	95	■	150	▣	480	▣	40	-	-	11.5	1.5	1.2
TN 16NR110UN	T8030	-	■	160	■	95	■	150	▣	480	▣	40	-	-	11.0	1.5	1.2
TN 16NR100UN	T8030	-	■	160	■	95	■	150	▣	480	▣	40	-	-	10.0	1.5	1.2
TN 16NR080UN	T8010	-	■	175	▣	105	■	165	-	-	▣	40	-	-	8.0	1.5	1.2
	T8030	-	■	160	■	95	■	150	▣	480	▣	40	-	-	8.0	1.5	1.2
TN 22NR070UN	T8030	-	■	160	■	95	■	150	▣	480	▣	40	-	-	7.0	2.5	1.8
TN 22NR060UN	T8030	-	■	160	■	95	■	150	▣	480	▣	40	-	-	6.0	2.5	1.8
TN 22NR050UN	T8030	-	■	160	■	95	■	150	▣	480	▣	40	-	-	5.0	2.5	1.8

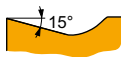

TN UN NL internal, left-handed design, for machining Unified threads, and continuous cuts.

TN 16NL320UN	T8030	-	■	160	■	95	■	150	▣	480	▣	40	-	-	32.0	0.8	0.8
--------------	-------	---	---	-----	---	----	---	-----	---	-----	---	----	---	---	------	-----	-----



Suitability and starting values for cutting speed (vc). Refer to our Machining Calculator app for further calculations.

Product	RE [mm]	P vc [m/min]	M vc [m/min]	K vc [m/min]	N vc [m/min]	S vc [m/min]	H vc [m/min]	TP [mm]	TPI	PDX [mm]	PDY [mm]

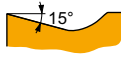

TN UN NL internal, left-handed design, for machining Unified threads, and continuous cuts.

TN 16NL280UN	T8030	-	█	160	█	95	█	150	▣	480	▣	40	-	-	28.0	0.8	0.8
TN 16NL240UN	T8030	-	█	160	█	95	█	150	▣	480	▣	40	-	-	24.0	0.8	0.8
TN 16NL200UN	T8030	-	█	160	█	95	█	150	▣	480	▣	40	-	-	20.0	0.8	0.8
TN 16NL180UN	T8030	-	█	160	█	95	█	150	▣	480	▣	40	-	-	18.0	0.8	0.8
TN 16NL160UN	T8030	-	█	160	█	95	█	150	▣	480	▣	40	-	-	16.0	0.8	0.8
TN 16NL140UN	T8030	-	█	160	█	95	█	150	▣	480	▣	40	-	-	14.0	1.5	1.2
TN 16NL120UN	T8030	-	█	160	█	95	█	150	▣	480	▣	40	-	-	12.0	1.5	1.2
TN 16NL110UN	T8030	-	█	160	█	95	█	150	▣	480	▣	40	-	-	11.0	1.5	1.2
TN 16NL100UN	T8030	-	█	160	█	95	█	150	▣	480	▣	40	-	-	10.0	1.5	1.2
TN 16NL080UN	T8030	-	█	160	█	95	█	150	▣	480	▣	40	-	-	8.0	1.5	1.2
TN 22NL070UN	T8030	-	█	160	█	95	█	150	▣	480	▣	40	-	-	7.0	2.5	1.8
TN 22NL060UN	T8030	-	█	160	█	95	█	150	▣	480	▣	40	-	-	6.0	2.5	1.8



TN UN-P1 NR pressed internal, right-handed design, for machining Unified threads, and continuous cuts.

TN 16NR200UN-P1	T8030	-	█	160	█	95	█	150	▣	480	▣	40	-	-	20.0	0.8	0.8
TN 16NR180UN-P1	T8030	-	█	160	█	95	█	150	▣	480	▣	40	-	-	18.0	0.8	0.8
TN 16NR160UN-P1	T8030	-	█	160	█	95	█	150	▣	480	▣	40	-	-	16.0	0.8	0.8
TN 16NR140UN-P1	T8030	-	█	160	█	95	█	150	▣	480	▣	40	-	-	14.0	1.5	1.2
TN 16NR120UN-P1	T8030	-	█	160	█	95	█	150	▣	480	▣	40	-	-	12.0	1.5	1.2
TN 16NR080UN-P1	T8030	-	█	160	█	95	█	150	▣	480	▣	40	-	-	8.0	1.5	1.2

TN UNJ EXT



	IC [mm]	L [mm]	S [mm]
16	9.525	16.50	3.47

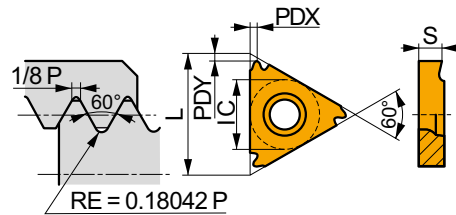

Suitability and starting values for cutting speed (vc). Refer to our Machining Calculator app for further calculations.

Product	RE [mm]	P vc [m/min]	M vc [m/min]	K vc [m/min]	N vc [m/min]	S vc [m/min]	H vc [m/min]	TP [mm]	TPI	PDX [mm]	PDY [mm]







TN UNJ ER external, right-handed design, for machining Unified "J form" threads, and continuous cuts.

TN 16ER320UNJ	T8030	-	█	160	█	95	█	150	▣	480	▣	40	-	-	32.0	0.8	0.8
TN 16ER280UNJ	T8030	-	█	160	█	95	█	150	▣	480	▣	40	-	-	28.0	0.8	0.8
TN 16ER240UNJ	T8030	-	█	160	█	95	█	150	▣	480	▣	40	-	-	24.0	0.8	0.8
TN 16ER200UNJ	T8030	-	█	160	█	95	█	150	▣	480	▣	40	-	-	20.0	0.8	0.8
TN 16ER180UNJ	T8030	-	█	160	█	95	█	150	▣	480	▣	40	-	-	18.0	0.8	0.8
TN 16ER160UNJ	T8030	-	█	160	█	95	█	150	▣	480	▣	40	-	-	16.0	1.5	1.2
TN 16ER120UNJ	T8030	-	█	160	█	95	█	150	▣	480	▣	40	-	-	12.0	1.5	1.2



Suitability and starting values for cutting speed (vc). Refer to our Machining Calculator app for further calculations.

Product	RE [mm]	P vc [m/min]	M vc [m/min]	K vc [m/min]	N vc [m/min]	S vc [m/min]	H vc [m/min]	TP [mm]	TPI	PDX [mm]	PDY [mm]	
												
TN UNJ EL external, left-handed design, for machining Unified "J form" threads, and continuous cuts.												
TN 16EL320UNJ	T8030	-	160	95	150	480	40	-	-	32.0	0.8	0.8
TN 16EL280UNJ	T8030	-	160	95	150	480	40	-	-	28.0	0.8	0.8
TN 16EL240UNJ	T8030	-	160	95	150	480	40	-	-	24.0	0.8	0.8
TN 16EL200UNJ	T8030	-	160	95	150	480	40	-	-	20.0	0.8	0.8
TN 16EL180UNJ	T8030	-	160	95	150	480	40	-	-	18.0	0.8	0.8
TN 16EL160UNJ	T8030	-	160	95	150	480	40	-	-	16.0	1.5	1.2
TN 16EL120UNJ	T8030	-	160	95	150	480	40	-	-	12.0	1.5	1.2





TN W EXT

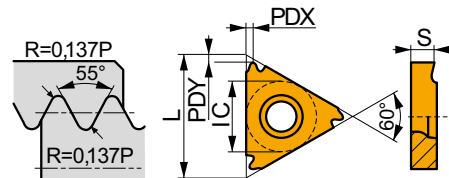

	IC [mm]	L [mm]	S [mm]
16	9.525	16.50	3.47
22	12.700	22.00	4.71



Suitability and starting values for cutting speed (vc). Refer to our Machining Calculator app for further calculations.

Product	RE [mm]	P vc [m/min]	M vc [m/min]	K vc [m/min]	N vc [m/min]	S vc [m/min]	H vc [m/min]	TP [mm]	TPI	PDX [mm]	PDY [mm]	
												
TN W ER external, right-handed design, for machining Whitworth form threads, and continuous cuts.												
TN 16ER280W	T8030	-	160	95	150	480	40	-	-	28.0	0.8	0.8
TN 16ER260W	T8030	-	160	95	150	480	40	-	-	26.0	0.8	0.8
TN 16ER240W	T8030	-	160	95	150	480	40	-	-	24.0	0.8	0.8
TN 16ER200W	T8030	-	160	95	150	480	40	-	-	20.0	0.8	0.8
TN 16ER190W	T8010	-	175	105	165	-	40	-	-	19.0	0.8	0.8
	T8030	-	160	95	150	480	40	-	-	19.0	0.8	0.8
TN 16ER180W	T8030	-	160	95	150	480	40	-	-	18.0	0.8	0.8
TN 16ER160W	T8030	-	160	95	150	480	40	-	-	16.0	0.8	0.8
TN 16ER140W	T8010	-	175	105	165	-	40	-	-	14.0	1.5	1.2
	T8030	-	160	95	150	480	40	-	-	14.0	1.5	1.2
TN 16ER120W	T8030	-	160	95	150	480	40	-	-	12.0	1.5	1.2
TN 16ER110W	T8010	-	175	105	165	-	40	-	-	11.0	1.5	1.2
	T8030	-	160	95	150	480	40	-	-	11.0	1.5	1.2
TN 16ER100W	T8030	-	160	95	150	480	40	-	-	10.0	1.5	1.2
TN 16ER090W	T8030	-	160	95	150	480	40	-	-	9.0	1.5	1.2
TN 16ER080W	T8030	-	160	95	150	480	40	-	-	8.0	1.5	1.2
TN 22ER070W	T8030	-	160	95	150	480	40	-	-	7.0	2.5	1.8
TN 22ER060W	T8030	-	160	95	150	480	40	-	-	6.0	2.5	1.8
TN 22ER050W	T8030	-	160	95	150	480	40	-	-	5.0	2.5	1.7



Suitability and starting values for cutting speed (vc). Refer to our Machining Calculator app for further calculations.

Product	RE [mm]	P vc [m/min]	M vc [m/min]	K vc [m/min]	N vc [m/min]	S vc [m/min]	H vc [m/min]	TP [mm]	TPI	PDX [mm]	PDY [mm]

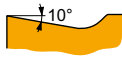
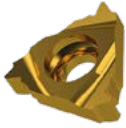

TN W EL external, left-handed design, for machining Whitworth form threads, and continuous cuts.

TN 16EL280W	T8030	–	■	160	■	95	■	150	■	480	■	40	–	–	28.0	0.8	0.8
TN 16EL260W	T8030	–	■	160	■	95	■	150	■	480	■	40	–	–	26.0	0.8	0.8
TN 16EL240W	T8030	–	■	160	■	95	■	150	■	480	■	40	–	–	24.0	0.8	0.8
TN 16EL200W	T8030	–	■	160	■	95	■	150	■	480	■	40	–	–	20.0	0.8	0.8
TN 16EL190W	T8030	–	■	160	■	95	■	150	■	480	■	40	–	–	19.0	0.8	0.8
TN 16EL160W	T8030	–	■	160	■	95	■	150	■	480	■	40	–	–	16.0	0.8	0.8
TN 16EL140W	T8030	–	■	160	■	95	■	150	■	480	■	40	–	–	14.0	1.5	1.2
TN 16EL120W	T8030	–	■	160	■	95	■	150	■	480	■	40	–	–	12.0	1.5	1.2
TN 16EL110W	T8030	–	■	160	■	95	■	150	■	480	■	40	–	–	11.0	1.5	1.2
TN 16EL100W	T8030	–	■	160	■	95	■	150	■	480	■	40	–	–	10.0	1.5	1.2
TN 16EL090W	T8030	–	■	160	■	95	■	150	■	480	■	40	–	–	9.0	1.5	1.2
TN 16EL080W	T8030	–	■	160	■	95	■	150	■	480	■	40	–	–	8.0	1.5	1.2
TN 22EL070W	T8030	–	■	160	■	95	■	150	■	480	■	40	–	–	7.0	2.5	1.8
TN 22EL060W	T8030	–	■	160	■	95	■	150	■	480	■	40	–	–	6.0	2.5	1.8
TN 22EL050W	T8030	–	■	160	■	95	■	150	■	480	■	40	–	–	5.0	2.5	1.7

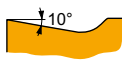

TN W-P1 ER pressed external, right-handed design, for machining Whitworth form threads, and continuous cuts.

TN 16ER190W-P1	T8030	–	■	160	■	95	■	150	■	480	■	40	–	–	19.0	0.8	0.8
TN 16ER140W-P1	T8030	–	■	160	■	95	■	150	■	480	■	40	–	–	14.0	1.5	1.2
TN 16ER110W-P1	T8030	–	■	160	■	95	■	150	■	480	■	40	–	–	11.0	1.5	1.2

TN W INT



	IC [mm]	L [mm]	S [mm]
11	6.350	11.00	3.00
16	9.525	16.50	3.47
22	12.700	22.00	4.71

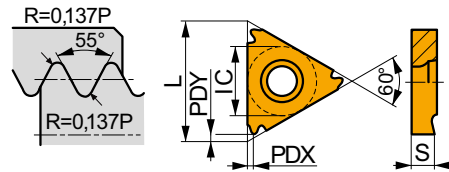

Suitability and starting values for cutting speed (vc). Refer to our Machining Calculator app for further calculations.

Product	RE [mm]	P vc [m/min]	M vc [m/min]	K vc [m/min]	N vc [m/min]	S vc [m/min]	H vc [m/min]	TP [mm]	TPI	PDX [mm]	PDY [mm]

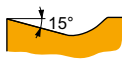
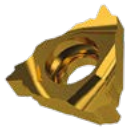

TN W NR internal, right-handed design, for machining Whitworth form threads, and continuous cuts.

TN 11NR190W	T8010	–	■	175	■	105	■	165	■	480	■	40	–	–	19.0	0.8	0.8
	T8030	–	■	160	■	95	■	150	■	480	■	40	–	–	19.0	0.8	0.8
TN 11NR140W	T8010	–	■	175	■	105	■	165	■	480	■	40	–	–	14.0	0.9	0.7
	T8030	–	■	160	■	95	■	150	■	480	■	40	–	–	14.0	0.9	0.7
TN 16NR280W	T8030	–	■	160	■	95	■	150	■	480	■	40	–	–	28.0	0.8	0.8
TN 16NR260W	T8030	–	■	160	■	95	■	150	■	480	■	40	–	–	26.0	0.8	0.8
TN 16NR240W	T8030	–	■	160	■	95	■	150	■	480	■	40	–	–	24.0	0.8	0.8
TN 16NR200W	T8030	–	■	160	■	95	■	150	■	480	■	40	–	–	20.0	0.8	0.8



Suitability and starting values for cutting speed (vc). Refer to our Machining Calculator app for further calculations.

Product	RE [mm]	P	M	K	N	S	H	TP	TPI	PDX	PDY	vc	
												[m/min]	[m/min]

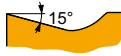
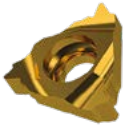

TN W NR internal, right-handed design, for machining Whitworth form threads, and continuous cuts.

TN 16NR190W	T8010	–	■	175	☑	105	■	165	–	☑	40	–	–	19.0	0.8	0.8	
	T8030	–	■	160	■	95	■	150	☑	480	☑	40	–	–	19.0	0.8	0.8
TN 16NR160W	T8030	–	■	160	■	95	■	150	☑	480	☑	40	–	–	16.0	0.8	0.8
TN 16NR140W	T8010	–	■	175	☑	105	■	165	–	☑	40	–	–	14.0	1.5	1.2	
	T8030	–	■	160	■	95	■	150	☑	480	☑	40	–	–	14.0	1.5	1.2
TN 16NR120W	T8030	–	■	160	■	95	■	150	☑	480	☑	40	–	–	12.0	1.5	1.2
TN 16NR110W	T8010	–	■	175	☑	105	■	165	–	☑	40	–	–	11.0	1.5	1.2	
	T8030	–	■	160	■	95	■	150	☑	480	☑	40	–	–	11.0	1.5	1.2
TN 16NR100W	T8030	–	■	160	■	95	■	150	☑	480	☑	40	–	–	10.0	1.5	1.2
TN 16NR090W	T8030	–	■	160	■	95	■	150	☑	480	☑	40	–	–	9.0	1.5	1.2
TN 16NR080W	T8030	–	■	160	■	95	■	150	☑	480	☑	40	–	–	8.0	1.5	1.2
TN 22NR070W	T8030	–	■	160	■	95	■	150	☑	480	☑	40	–	–	7.0	2.5	1.8
TN 22NR060W	T8030	–	■	160	■	95	■	150	☑	480	☑	40	–	–	6.0	2.5	1.8
TN 22NR050W	T8030	–	■	160	■	95	■	150	☑	480	☑	40	–	–	5.0	2.5	1.7



TN W NL internal, left-handed design, for machining Whitworth form threads, and continuous cuts.

TN 11NL190W	T8030	–	■	160	■	95	■	150	☑	480	☑	40	–	–	19.0	0.8	0.8
TN 11NL140W	T8030	–	■	160	■	95	■	150	☑	480	☑	40	–	–	14.0	0.9	0.7
TN 16NL280W	T8030	–	■	160	■	95	■	150	☑	480	☑	40	–	–	28.0	0.8	0.8
TN 16NL260W	T8030	–	■	160	■	95	■	150	☑	480	☑	40	–	–	26.0	0.8	0.8
TN 16NL240W	T8030	–	■	160	■	95	■	150	☑	480	☑	40	–	–	24.0	0.8	0.8
TN 16NL200W	T8030	–	■	160	■	95	■	150	☑	480	☑	40	–	–	20.0	0.8	0.8
TN 16NL190W	T8030	–	■	160	■	95	■	150	☑	480	☑	40	–	–	19.0	0.8	0.8
TN 16NL160W	T8030	–	■	160	■	95	■	150	☑	480	☑	40	–	–	16.0	0.8	0.8
TN 16NL140W	T8030	–	■	160	■	95	■	150	☑	480	☑	40	–	–	14.0	1.5	1.2
TN 16NL120W	T8030	–	■	160	■	95	■	150	☑	480	☑	40	–	–	12.0	1.5	1.2
TN 16NL110W	T8030	–	■	160	■	95	■	150	☑	480	☑	40	–	–	11.0	1.5	1.2
TN 16NL100W	T8030	–	■	160	■	95	■	150	☑	480	☑	40	–	–	10.0	1.5	1.2
TN 16NL090W	T8030	–	■	160	■	95	■	150	☑	480	☑	40	–	–	9.0	1.5	1.2
TN 16NL080W	T8030	–	■	160	■	95	■	150	☑	480	☑	40	–	–	8.0	1.5	1.2
TN 22NL070W	T8030	–	■	160	■	95	■	150	☑	480	☑	40	–	–	7.0	2.5	1.8
TN 22NL060W	T8030	–	■	160	■	95	■	150	☑	480	☑	40	–	–	6.0	2.5	1.8
TN 22NL050W	T8030	–	■	160	■	95	■	150	☑	480	☑	40	–	–	5.0	2.5	1.7

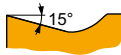

TN W-P1 NR pressed internal, right-handed design, for machining Whitworth form threads, and continuous cuts.

TN 11NR190W-P1	T8030	–	■	160	■	95	■	150	☑	480	☑	40	–	–	19.0	0.8	0.8
TN 11NR140W-P1	T8030	–	■	160	■	95	■	150	☑	480	☑	40	–	–	14.0	0.9	0.7
TN 16NR140W-P1	T8030	–	■	160	■	95	■	150	☑	480	☑	40	–	–	14.0	1.5	1.2
TN 16NR110W-P1	T8030	–	■	160	■	95	■	150	☑	480	☑	40	–	–	11.0	1.5	1.2



TN 55° PP EXT



	IC [mm]	L [mm]	S [mm]
16	9.525	16.50	3.47
22	12.700	22.00	4.71

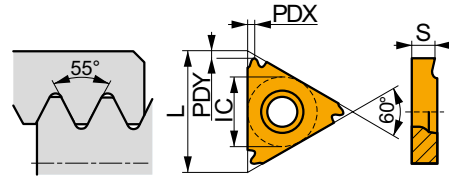

Suitability and starting values for cutting speed (vc). Refer to our Machining Calculator app for further calculations.

Product	RE [mm]	P	M	K	N	S	H	TPN [mm]	TPX [mm]	TPIN [mm]	TPIX [mm]	PDX [mm]	PDY [mm]
		vc [m/min]	vc [m/min]	vc [m/min]	vc [m/min]	vc [m/min]	vc [m/min]						



TN W55 PP ER external, right-handed design, for machining Whitworth threads, and continuous cuts.

TN 16ERA55	T8030	–	■ 160	■ 95	■ 150	▣ 480	▣ 40	–	0.50	1.50	16	48	0.8	0.6
TN 16ERAG55	T8010	–	■ 175	▣ 105	■ 165	–	▣ 40	–	0.50	3.00	8	48	1.5	1.1
	T8030	–	■ 160	■ 95	■ 150	▣ 480	▣ 40	–	0.50	3.00	8	48	1.5	1.1
TN 16ERG55	T8030	–	■ 160	■ 95	■ 150	▣ 480	▣ 40	–	1.75	3.00	8	14	1.5	1.1
TN 22ERN55	T8010	–	■ 175	▣ 105	■ 165	–	▣ 40	–	3.50	5.00	5	7	2.5	1.8
	T8030	–	■ 160	■ 95	■ 150	▣ 480	▣ 40	–	3.50	5.00	5	7	2.5	1.8



TN W55 PP EL external, left-handed design, for machining Whitworth threads, and continuous cuts.

TN 16ELA55	T8030	–	■ 160	■ 95	■ 150	▣ 480	▣ 40	–	0.50	1.50	16	48	0.8	0.6
TN 16ELAG55	T8030	–	■ 160	■ 95	■ 150	▣ 480	▣ 40	–	0.50	3.00	8	48	1.5	1.1
TN 16ELG55	T8030	–	■ 160	■ 95	■ 150	▣ 480	▣ 40	–	1.75	3.00	8	14	1.5	1.1
TN 22ELN55	T8030	–	■ 160	■ 95	■ 150	▣ 480	▣ 40	–	3.50	5.00	5	7	2.5	1.8



TN 55° PP INT



	IC [mm]	L [mm]	S [mm]
11	6.350	11.00	3.00
16	9.525	16.50	3.47
22	12.700	22.00	4.71

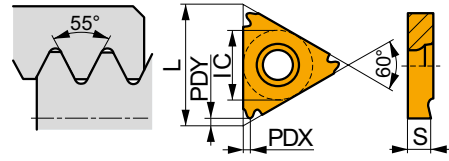

Suitability and starting values for cutting speed (vc). Refer to our Machining Calculator app for further calculations.

Product	RE [mm]	P vc [m/min]	M vc [m/min]	K vc [m/min]	N vc [m/min]	S vc [m/min]	H vc [m/min]	TPN [mm]	TPX [mm]	TPIN [mm]	TPIX [mm]	PDX [mm]	PDY [mm]

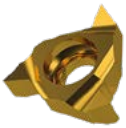

TN W55 PP NR internal, right-handed design, for machining Whitworth threads, and continuous cuts.

TN 11NRA55	T8030	–	■	160	■	95	■	150	☑	480	☑	40	–	0.50	1.50	16	48	0.8	0.6
TN 16NRA55	T8030	–	■	160	■	95	■	150	☑	480	☑	40	–	0.50	1.50	16	48	0.8	0.6
TN 16NRAG55	T8010	–	■	175	☑	105	■	165	–	–	☑	40	–	0.50	3.00	8	48	1.5	1.1
	T8030	–	■	160	■	95	■	150	☑	480	☑	40	–	0.50	3.00	8	48	1.5	1.1
TN 16NRG55	T8030	–	■	160	■	95	■	150	☑	480	☑	40	–	1.75	3.00	8	14	1.5	1.1
TN 22NRN55	T8030	–	■	160	■	95	■	150	☑	480	☑	40	–	3.50	5.00	5	7	2.5	1.8



TN W55 PP NL internal, left-handed design, for machining Whitworth threads, and continuous cuts.

TN 11NLA55	T8030	–	■	160	■	95	■	150	☑	480	☑	40	–	0.50	1.50	16	48	0.8	0.6
TN 16NLA55	T8030	–	■	160	■	95	■	150	☑	480	☑	40	–	0.50	1.50	16	48	0.8	0.6
TN 16NLAG55	T8030	–	■	160	■	95	■	150	☑	480	☑	40	–	0.50	3.00	8	48	1.5	1.1
TN 16NLG55	T8030	–	■	160	■	95	■	150	☑	480	☑	40	–	1.75	3.00	8	14	1.5	1.1
TN 22NLN55	T8030	–	■	160	■	95	■	150	☑	480	☑	40	–	3.50	5.00	5	7	2.5	1.8



TN BSPT EXT



	IC [mm]	L [mm]	S [mm]
16	9.525	16.50	3.47

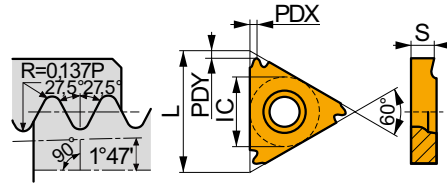

Suitability and starting values for cutting speed (vc). Refer to our Machining Calculator app for further calculations.

Product	RE [mm]	P vc [m/min]	M vc [m/min]	K vc [m/min]	N vc [m/min]	S vc [m/min]	H vc [m/min]	TP [mm]	TPI	PDX [mm]	PDY [mm]



TN BSPT ER external, right-handed design, for machining BSPT threads, and continuous cuts.

TN 16ER280BSPT	T8030	–	160	95	150	480	40	–	–	28.0	0.8	0.8
TN 16ER190BSPT	T8030	–	160	95	150	480	40	–	–	19.0	1.5	1.2
TN 16ER140BSPT	T8030	–	160	95	150	480	40	–	–	14.0	1.5	1.2
TN 16ER110BSPT	T8030	–	160	95	150	480	40	–	–	11.0	1.5	1.2

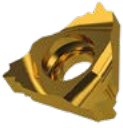

TN BSPT EL external, left-handed design, for machining BSPT threads, and continuous cuts.

TN 16EL280BSPT	T8030	–	160	95	150	480	40	–	–	28.0	0.8	0.8
TN 16EL190BSPT	T8030	–	160	95	150	480	40	–	–	19.0	1.5	1.2
TN 16EL140BSPT	T8030	–	160	95	150	480	40	–	–	14.0	1.5	1.2
TN 16EL110BSPT	T8030	–	160	95	150	480	40	–	–	11.0	1.5	1.2

TN BSPT INT



	IC [mm]	L [mm]	S [mm]
16	9.525	16.50	3.47

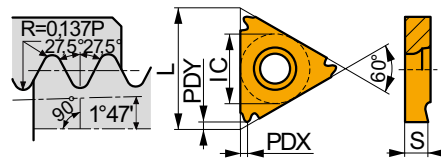

Suitability and starting values for cutting speed (vc). Refer to our Machining Calculator app for further calculations.

Product	RE [mm]	P vc [m/min]	M vc [m/min]	K vc [m/min]	N vc [m/min]	S vc [m/min]	H vc [m/min]	TP [mm]	TPI	PDX [mm]	PDY [mm]



TN BSPT NR internal, right-handed design, for machining BSPT threads, and continuous cuts.

TN 16NR280BSPT	T8030	–	160	95	150	480	40	–	–	28.0	0.8	0.8
TN 16NR190BSPT	T8030	–	160	95	150	480	40	–	–	19.0	1.5	1.2



Suitability and starting values for cutting speed (vc). Refer to our Machining Calculator app for further calculations.

Product	RE [mm]	P vc [m/min]	M vc [m/min]	K vc [m/min]	N vc [m/min]	S vc [m/min]	H vc [m/min]	TP [mm]	TPI	PDX [mm]	PDY [mm]

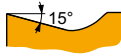
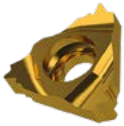

TN BSPT NR internal, right-handed design, for machining BSPT threads, and continuous cuts.

TN 16NR140BSPT	T8030	-	█	160	█	95	█	150	█	480	█	40	-	-	14.0	1.5	1.2
TN 16NR110BSPT	T8030	-	█	160	█	95	█	150	█	480	█	40	-	-	11.0	1.5	1.2

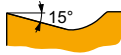

TN BSPT NL internal, left-handed design, for machining BSPT threads, and continuous cuts.

TN 16NL280BSPT	T8030	-	█	160	█	95	█	150	█	480	█	40	-	-	28.0	0.8	0.8
TN 16NL190BSPT	T8030	-	█	160	█	95	█	150	█	480	█	40	-	-	19.0	1.5	1.2
TN 16NL140BSPT	T8030	-	█	160	█	95	█	150	█	480	█	40	-	-	14.0	1.5	1.2
TN 16NL110BSPT	T8030	-	█	160	█	95	█	150	█	480	█	40	-	-	11.0	1.5	1.2

TN NPT EXT



	IC [mm]	L [mm]	S [mm]
16	9.525	16.50	3.47

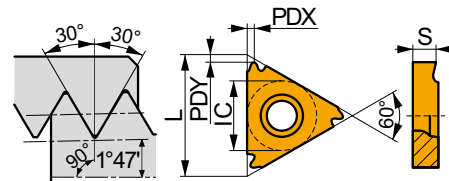

Suitability and starting values for cutting speed (vc). Refer to our Machining Calculator app for further calculations.

Product	RE [mm]	P vc [m/min]	M vc [m/min]	K vc [m/min]	N vc [m/min]	S vc [m/min]	H vc [m/min]	TP [mm]	TPI	PDX [mm]	PDY [mm]

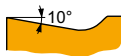

TN NPT ER external, right-handed design, for machining NPT threads, and continuous cuts.

TN 16ER270NPT	T8030	-	█	160	█	95	█	150	█	480	█	40	-	-	27.0	0.8	0.7
TN 16ER180NPT	T8030	-	█	160	█	95	█	150	█	480	█	40	-	-	18.0	0.8	0.7
TN 16ER140NPT	T8010	-	█	175	█	105	█	165	-	-	█	40	-	-	14.0	1.5	1.1
	T8030	-	█	160	█	95	█	150	█	480	█	40	-	-	14.0	1.5	1.1
TN 16ER115NPT	T8010	-	█	175	█	105	█	165	-	-	█	40	-	-	11.5	1.5	1.1
	T8030	-	█	160	█	95	█	150	█	480	█	40	-	-	11.5	1.5	1.1
TN 16ER080NPT	T8030	-	█	160	█	95	█	150	█	480	█	40	-	-	8.0	1.6	1.1



TN NPT INT



	IC [mm]	L [mm]	S [mm]
11	6.350	11.00	3.00
16	9.525	16.50	3.47

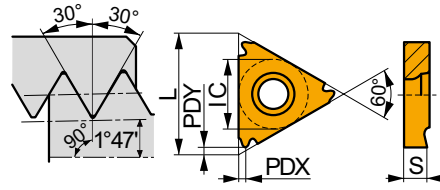

Suitability and starting values for cutting speed (vc). Refer to our Machining Calculator app for further calculations.

Product	RE [mm]	P	M	K	N	S	H	TP [mm]	TPI	PDX [mm]	PDY [mm]
		vc [m/min]	vc [m/min]	vc [m/min]	vc [m/min]	vc [m/min]	vc [m/min]				

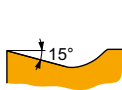
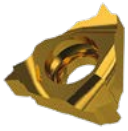

TN NPT NR internal, right-handed design, for machining NPT threads, and continuous cuts.

TN 11NR180NPT	T8030	–	■	160	■	95	■	150	■	480	■	40	–	–	18.0	0.8	0.7
TN 11NR140NPT	T8030	–	■	160	■	95	■	150	■	480	■	40	–	–	14.0	1.0	0.7
TN 16NR140NPT	T8010	–	■	175	■	105	■	165	■	–	■	40	–	–	14.0	1.5	1.1
	T8030	–	■	160	■	95	■	150	■	480	■	40	–	–	14.0	1.5	1.1
TN 16NR115NPT	T8010	–	■	175	■	105	■	165	■	–	■	40	–	–	11.5	1.5	1.1
	T8030	–	■	160	■	95	■	150	■	480	■	40	–	–	11.5	1.5	1.1
TN 16NR080NPT	T8030	–	■	160	■	95	■	150	■	480	■	40	–	–	8.0	1.6	1.1

TN TR EXT



	IC [mm]	L [mm]	S [mm]
16	9.525	16.50	3.47
22	12.700	22.00	4.71

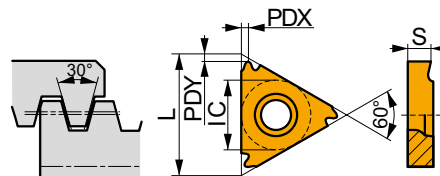

Suitability and starting values for cutting speed (vc). Refer to our Machining Calculator app for further calculations.

Product	RE [mm]	P	M	K	N	S	H	TP [mm]	TPI	PDX [mm]	PDY [mm]
		vc [m/min]	vc [m/min]	vc [m/min]	vc [m/min]	vc [m/min]	vc [m/min]				

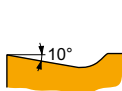

TN TR ER external, right-handed design, for machining Trapezoidal threads, and continuous cuts.

TN 16ER150TR	T8030	–	■	160	■	95	■	150	■	480	■	40	–	1.50	–	0.8	0.9
TN 16ER200TR	T8030	–	■	160	■	95	■	150	■	480	■	40	–	2.00	–	1.5	1.3
TN 16ER300TR	T8030	–	■	160	■	95	■	150	■	480	■	40	–	3.00	–	1.6	1.3
TN 22ER400TR	T8030	–	■	160	■	95	■	150	■	480	■	40	–	4.00	–	2.2	1.8
TN 22ER500TR	T8030	–	■	160	■	95	■	150	■	480	■	40	–	5.00	–	2.2	1.8



Suitability and starting values for cutting speed (vc). Refer to our Machining Calculator app for further calculations.

Product	RE [mm]	P	M	K	N	S	H	TP [mm]	TPI	PDX [mm]	PDY [mm]
		vc [m/min]	vc [m/min]	vc [m/min]	vc [m/min]	vc [m/min]	vc [m/min]				

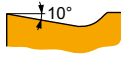

TN TR EL external, left-handed design, for machining Trapezoidal threads, and continuous cuts.

TN 16EL150TR	T8030	-	■	160	■	95	■	150	☑	480	☑	40	-	1.50	-	0.8	0.9
TN 16EL200TR	T8030	-	■	160	■	95	■	150	☑	480	☑	40	-	2.00	-	1.5	1.3
TN 16EL300TR	T8030	-	■	160	■	95	■	150	☑	480	☑	40	-	3.00	-	1.6	1.3
TN 22EL400TR	T8030	-	■	160	■	95	■	150	☑	480	☑	40	-	4.00	-	2.2	1.8
TN 22EL500TR	T8030	-	■	160	■	95	■	150	☑	480	☑	40	-	5.00	-	2.2	1.8

TN TR INT



	IC [mm]	L [mm]	S [mm]
16	9.525	16.50	3.47
22	12.700	22.00	4.71

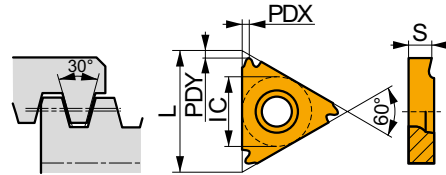

Suitability and starting values for cutting speed (vc). Refer to our Machining Calculator app for further calculations.

Product	RE [mm]	P	M	K	N	S	H	TP [mm]	TPI	PDX [mm]	PDY [mm]
		vc [m/min]	vc [m/min]	vc [m/min]	vc [m/min]	vc [m/min]	vc [m/min]				

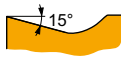

TN TR NR internal, right-handed design, for machining Trapezoidal threads, and continuous cuts.

TN 16NR150TR	T8030	-	■	160	■	95	■	150	☑	480	☑	40	-	1.50	-	0.8	0.9
TN 16NR200TR	T8030	-	■	160	■	95	■	150	☑	480	☑	40	-	2.00	-	1.5	1.3
TN 16NR300TR	T8030	-	■	160	■	95	■	150	☑	480	☑	40	-	3.00	-	1.6	1.3
TN 22NR400TR	T8030	-	■	160	■	95	■	150	☑	480	☑	40	-	4.00	-	2.2	1.8
TN 22NR500TR	T8030	-	■	160	■	95	■	150	☑	480	☑	40	-	5.00	-	2.2	1.8

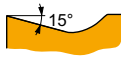

TN TR NL internal, left-handed design, for machining Trapezoidal threads, and continuous cuts.

TN 16NL150TR	T8030	-	■	160	■	95	■	150	☑	480	☑	40	-	1.50	-	0.8	0.9
TN 16NL200TR	T8030	-	■	160	■	95	■	150	☑	480	☑	40	-	2.00	-	1.5	1.3
TN 16NL300TR	T8030	-	■	160	■	95	■	150	☑	480	☑	40	-	3.00	-	1.6	1.3
TN 22NL400TR	T8030	-	■	160	■	95	■	150	☑	480	☑	40	-	4.00	-	2.2	1.8
TN 22NL500TR	T8030	-	■	160	■	95	■	150	☑	480	☑	40	-	5.00	-	2.2	1.8



TN TR-S EXT

PRAMET

	IC [mm]	L [mm]	S [mm]
22	12.700	22.00	4.60

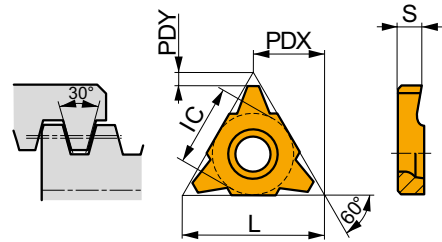

Suitability and starting values for cutting speed (vc). Refer to our Machining Calculator app for further calculations.

Product	RE [mm]	P	M	K	N	S	H	TP [mm]	TPI	PDX [mm]	PDY [mm]
		vc [m/min]	vc [m/min]	vc [m/min]	vc [m/min]	vc [m/min]	vc [m/min]				

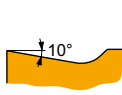

TN TR-S PP EN external, left and right-handed design for machining Trapezoidal threads, and continuous cuts.

TN 22EN600TR	T8030	-	160	95	150	480	40	-	6.00	-	11.0	1.9
TN 22EN700TR	T8030	-	160	95	150	480	40	-	7.00	-	11.0	2.3

TN TR-S INT

PRAMET

	IC [mm]	L [mm]	S [mm]
22	12.700	22.00	4.60

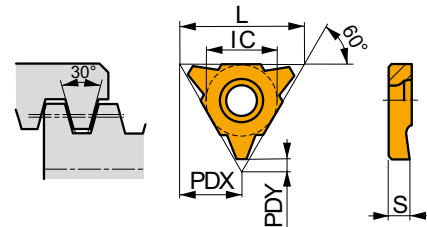

Suitability and starting values for cutting speed (vc). Refer to our Machining Calculator app for further calculations.

Product	RE [mm]	P	M	K	N	S	H	TP [mm]	TPI	PDX [mm]	PDY [mm]
		vc [m/min]	vc [m/min]	vc [m/min]	vc [m/min]	vc [m/min]	vc [m/min]				

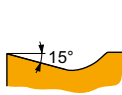

TN M60-S PP NN internal, left and right-handed design, for machining Metric and Unified threads, and continuous cuts.

TN 22NN600TR	T8030	-	160	95	150	480	40	-	6.00	-	11.0	1.9
TN 22NN700TR	T8030	-	160	95	150	480	40	-	7.00	-	11.0	2.3



TN ACME EXT

	IC	L	S
	[mm]	[mm]	[mm]
16	9.525	16.50	3.47
22	12.700	22.00	4.71

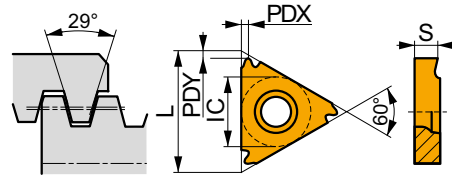

Suitability and starting values for cutting speed (vc). Refer to our Machining Calculator app for further calculations.

Product	RE	P	M	K	N	S	H	TP	TPI	PDX	PDY

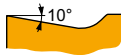

TN ACME ER external, right-handed design, for machining ACME threads, and continuous cuts.

TN 16ER120ACME	T8030	-	160	95	150	480	40	-	-	12.0	1.5	1.3
TN 16ER100ACME	T8030	-	160	95	150	480	40	-	-	10.0	1.5	1.3
TN 16ER080ACME	T8030	-	160	95	150	480	40	-	-	8.0	1.5	1.3
TN 22ER060ACME	T8030	-	160	95	150	480	40	-	-	6.0	2.5	2.0
TN 22ER050ACME	T8030	-	160	95	150	480	40	-	-	5.0	2.3	2.0

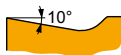

TN ACME EL external, left-handed design, for machining ACME threads, and continuous cuts.

TN 16EL120ACME	T8030	-	160	95	150	480	40	-	-	12.0	1.5	1.3
TN 16EL100ACME	T8030	-	160	95	150	480	40	-	-	10.0	1.5	1.3
TN 16EL080ACME	T8030	-	160	95	150	480	40	-	-	8.0	1.5	1.3
TN 22EL060ACME	T8030	-	160	95	150	480	40	-	-	6.0	2.5	2.0
TN 22EL050ACME	T8030	-	160	95	150	480	40	-	-	5.0	2.3	2.0



TN ACME INT



	IC [mm]	L [mm]	S [mm]
16	9.525	16.50	3.47
22	12.700	22.00	4.71

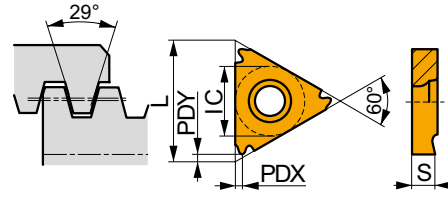

Suitability and starting values for cutting speed (vc). Refer to our Machining Calculator app for further calculations.

Product	RE [mm]	P	M	K	N	S	H	TP [mm]	TPI	PDX [mm]	PDY [mm]
		vc [m/min]	vc [m/min]	vc [m/min]	vc [m/min]	vc [m/min]	vc [m/min]				



TN ACME NR internal, right-handed design, for machining ACME threads, and continuous cuts.

TN 16NR120ACME	T8030	–	160	95	150	480	40	–	–	12.0	1.5	1.3
TN 16NR100ACME	T8030	–	160	95	150	480	40	–	–	10.0	1.5	1.3
TN 16NR080ACME	T8030 ¹⁾	–	160	95	150	480	40	–	–	8.0	1.5	1.3
TN 22NR060ACME	T8030	–	160	95	150	480	40	–	–	6.0	2.5	2.0
TN 22NR050ACME	T8030	–	160	95	150	480	40	–	–	5.0	2.3	2.0



TN ACME NL internal, left-handed design, for machining ACME threads, and continuous cuts.

TN 16NL120ACME	T8030	–	160	95	150	480	40	–	–	12.0	1.5	1.3
TN 16NL100ACME	T8030	–	160	95	150	480	40	–	–	10.0	1.5	1.3
TN 16NL080ACME	T8030 ¹⁾	–	160	95	150	480	40	–	–	8.0	1.5	1.3
TN 22NL060ACME	T8030	–	160	95	150	480	40	–	–	6.0	2.5	2.0
TN 22NL050ACME	T8030	–	160	95	150	480	40	–	–	5.0	2.3	2.0

¹⁾ Toolholders have to be modified.



TN STACME EXT

	IC	L	S
	[mm]	[mm]	[mm]
16	9.525	16.50	3.47

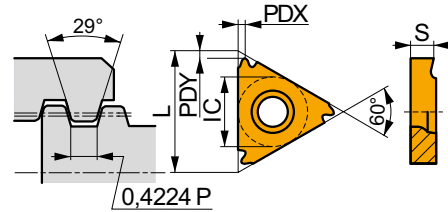

Suitability and starting values for cutting speed (vc). Refer to our Machining Calculator app for further calculations.

Product	RE	P	M	K	N	S	H	TP	TPI	PDX	PDY

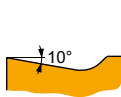

TN STACME ER external, right-handed design, for machining Stub ACME threads, and continuous cuts.

TN 16ER160STACME	T8030	–	160	95	150	480	40	–	–	16.0	0.8	0.8
TN 16ER120STACME	T8030	–	160	95	150	480	40	–	–	12.0	0.8	0.8
TN 16ER100STACME	T8030	–	160	95	150	480	40	–	–	10.0	1.5	1.3
TN 16ER080STACME	T8030	–	160	95	150	480	40	–	–	8.0	1.5	1.3
TN 16ER060STACME	T8030	–	160	95	150	480	40	–	–	6.0	1.4	1.3

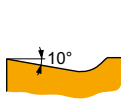

TN STACME EL external, left-handed design, for machining Stub ACME threads, and continuous cuts.

TN 16EL160STACME	T8030	–	160	95	150	480	40	–	–	16.0	0.8	0.8
TN 16EL120STACME	T8030	–	160	95	150	480	40	–	–	12.0	0.8	0.8
TN 16EL100STACME	T8030	–	160	95	150	480	40	–	–	10.0	1.5	1.3
TN 16EL080STACME	T8030	–	160	95	150	480	40	–	–	8.0	1.5	1.3
TN 16EL060STACME	T8030	–	160	95	150	480	40	–	–	6.0	1.4	1.3



TN STACME INT

	IC [mm]	L [mm]	S [mm]
16	9.525	16.50	3.47

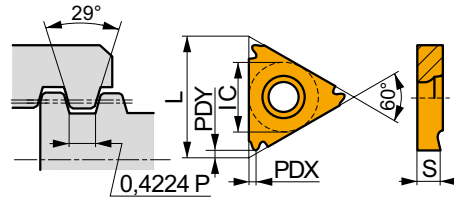

Suitability and starting values for cutting speed (vc). Refer to our Machining Calculator app for further calculations.

Product	RE [mm]	P	M	K	N	S	H	TP [mm]	TPI	PDX [mm]	PDY [mm]
		vc [m/min]	vc [m/min]	vc [m/min]	vc [m/min]	vc [m/min]	vc [m/min]				



TN STACME NR internal, right-handed, design for machining Stub ACME threads, and continuous cuts.

TN 16NR160STACME	T8030	–	160	95	150	480	40	–	–	16.0	0.8	0.8
TN 16NR120STACME	T8030	–	160	95	150	480	40	–	–	12.0	0.8	0.8
TN 16NR100STACME	T8030	–	160	95	150	480	40	–	–	10.0	1.5	1.3
TN 16NR080STACME	T8030	–	160	95	150	480	40	–	–	8.0	1.5	1.3
TN 16NR060STACME	T8030¹⁾	–	160	95	150	480	40	–	–	6.0	1.3	1.3

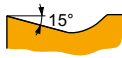

TN STACME NL internal, left-handed design, for machining Stub ACME threads, and continuous cuts.

TN 16NL160STACME	T8030	–	160	95	150	480	40	–	–	16.0	0.8	0.8
TN 16NL120STACME	T8030	–	160	95	150	480	40	–	–	12.0	0.8	0.8
TN 16NL100STACME	T8030	–	160	95	150	480	40	–	–	10.0	1.5	1.3
TN 16NL080STACME	T8030	–	160	95	150	480	40	–	–	8.0	1.5	1.3
TN 16NL060STACME	T8030¹⁾	–	160	95	150	480	40	–	–	6.0	1.3	1.3

¹⁾ Toolholders have to be modified.



TN API RD EXT

	IC [mm]	L [mm]	S [mm]
16	9.525	16.50	3.47

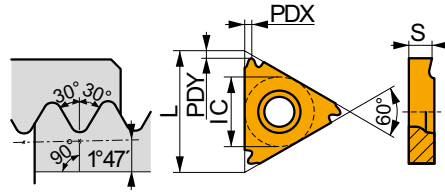

Suitability and starting values for cutting speed (vc). Refer to our Machining Calculator app for further calculations.

Product	RE [mm]	P	M	K	N	S	H	TP [mm]	TPI	PDX [mm]	PDY [mm]
		vc [m/min]	vc [m/min]	vc [m/min]	vc [m/min]	vc [m/min]	vc [m/min]				

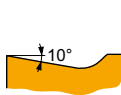

TN API ER external, right-handed design, for machining API threads, and continuous cuts.

TN 16ER100API-RD01	T8030	-	160	95	150	480	40	-	-	10.0	1.5	1.2
TN 16ER080API-RD01	T8030	-	160	95	150	480	40	-	-	8.0	1.5	1.2

TN API RD INT

	IC [mm]	L [mm]	S [mm]
16	9.525	16.50	3.47

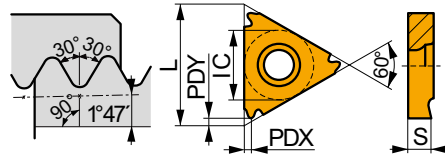

Suitability and starting values for cutting speed (vc). Refer to our Machining Calculator app for further calculations.

Product	RE [mm]	P	M	K	N	S	H	TP [mm]	TPI	PDX [mm]	PDY [mm]
		vc [m/min]	vc [m/min]	vc [m/min]	vc [m/min]	vc [m/min]	vc [m/min]				

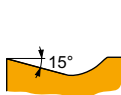
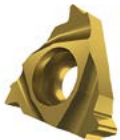

TN API NR internal, right-handed design, for machining API threads, and continuous cuts.

TN 16NR100API-RD01	T8030	-	160	95	150	480	40	-	-	10.0	1.5	1.2
TN 16NR080API-RD01	T8030	-	160	95	150	480	40	-	-	8.0	1.5	1.2



TN RD EXT



	IC [mm]	L [mm]	S [mm]
16	9.525	16.50	3.47
22	12.700	22.00	4.71

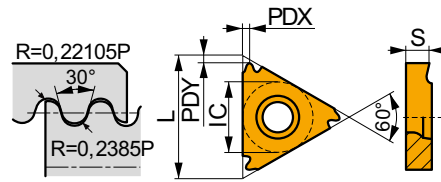

Suitability and starting values for cutting speed (vc). Refer to our Machining Calculator app for further calculations.

Product	RE	P	M	K	N	S	H	TP	TPI	PDX	PDY

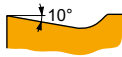

TN RD ER external, right-handed design, for machining Metric Round threads, and continuous cuts.

TN 16ER100RD	T8030	–	160	95	150	480	40	–	–	10.0	1.5	1.2
TN 16ER080RD	T8030	–	160	95	150	480	40	–	–	8.0	1.5	1.2
TN 16ER060RD	T8030¹⁾	–	160	95	150	480	40	–	–	6.0	1.5	1.2
TN 22ER060RD	T8030	–	160	95	150	480	40	–	–	6.0	2.5	1.8

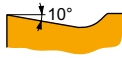

TN RD EL external, left-handed design, for machining Metric Round threads, and continuous cuts.

TN 16EL100RD	T8030	–	160	95	150	480	40	–	–	10.0	1.5	1.2
TN 16EL080RD	T8030	–	160	95	150	480	40	–	–	8.0	1.5	1.2
TN 16EL060RD	T8030¹⁾	–	160	95	150	480	40	–	–	6.0	1.5	1.2
TN 22EL060RD	T8030	–	160	95	150	480	40	–	–	6.0	2.5	1.8

¹⁾ Toolholders have to be modified.

TN RD INT



	IC [mm]	L [mm]	S [mm]
16	9.525	16.50	3.47
22	12.700	22.00	4.71

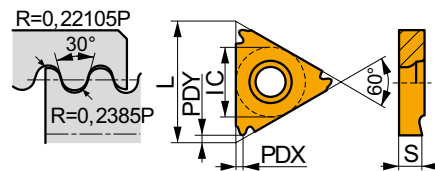

Suitability and starting values for cutting speed (vc). Refer to our Machining Calculator app for further calculations.

Product	RE	P	M	K	N	S	H	TP	TPI	PDX	PDY



TN RD NR internal, right-handed design, for machining Metric Round threads, and continuous cuts.

TN 16NR100RD	T8030	–	160	95	150	480	40	–	–	10.0	1.5	1.2
TN 16NR080RD	T8030	–	160	95	150	480	40	–	–	8.0	1.5	1.2



Suitability and starting values for cutting speed (vc). Refer to our Machining Calculator app for further calculations.

Product		RE [mm]	P		M		K		N		S		H		TP [mm]	TPI	PDX [mm]	PDY [mm]
			vc [m/min]		vc [m/min]		vc [m/min]		vc [m/min]		vc [m/min]		vc [m/min]					

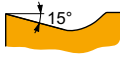

TN RD NR internal, right-handed design, for machining Metric Round threads, and continuous cuts.

TN 16NR060RD	T8030¹⁾	–	■	160	■	95	■	150	☑	480	☑	40	–	–	6.0	1.5	1.2
TN 22NR060RD	T8030	–	■	160	■	95	■	150	☑	480	☑	40	–	–	6.0	2.5	1.8

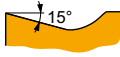

TN RD NL internal, left-handed design, for machining Metric Round threads, and continuous cuts.

TN 16NL100RD	T8030	–	■	160	■	95	■	150	☑	480	☑	40	–	–	10.0	1.5	1.2
TN 16NL080RD	T8030	–	■	160	■	95	■	150	☑	480	☑	40	–	–	8.0	1.5	1.2
TN 16NL060RD	T8030¹⁾	–	■	160	■	95	■	150	☑	480	☑	40	–	–	6.0	1.5	1.2
TN 22NL060RD	T8030	–	■	160	■	95	■	150	☑	480	☑	40	–	–	6.0	2.5	1.8

¹⁾ Toolholders have to be modified.



SE(RL)

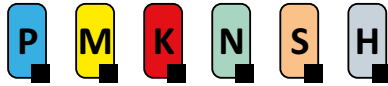

PRAMET

S



External Screw Clamped Threading Holder for TN 16 or 22 Insert

Right/Left hand screw lock tool holder for external threading with TN16 or 22 ER/EL inserts. Suited for threading in metric or inch profile. Also suited for shallow grooving. Body treated for longer tool life.

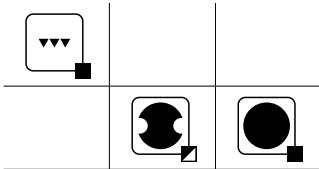
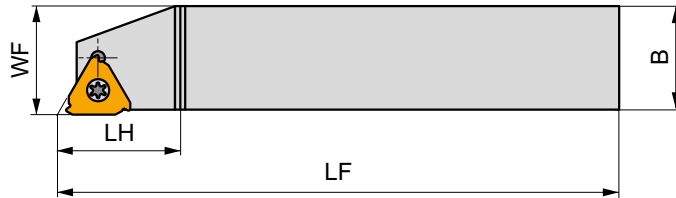
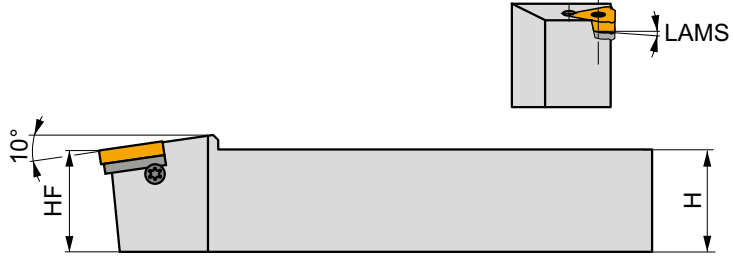
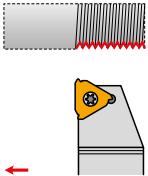

Product	H	H _F	B	WF	LF	H _F	LAMS		
	[mm]	[mm]	[mm]	[mm]	[mm]	[mm]	[°]		
R SER 2020 K 16	20	20	20	20	125	22.5	–	GI068	Z12
SER 2525 M 16	25	25	25	25	150	24	–	GI068	Z12
SER 3225 P 16	32	32	25	25	170	24.5	–	GI068	Z12
SER 2525 M 22-A	25	25	25	25	150	25.5	–	GI071	Z13
SER 3225 P 22-A	32	32	25	25	170	25.5	–	GI071	Z13
L SEL 2020 K 16	20	20	20	20	125	22.5	–	GI068	Z12
SEL 2525 M 16	25	25	25	25	150	24	–	GI068	Z12
SEL 3225 P 16	32	32	25	25	170	24.5	–	GI068	Z12
SEL 2525 M 22-A	25	25	25	25	150	25.5	–	GI071	Z13
SEL 3225 P 22-A	32	32	25	25	170	25.5	–	GI071	Z13

GI068	TN 16ER..	TN 16EL..
GI071	TN 22ER..	TN 22EL..

Z12	US 3512A-T15P	3.0	M 3.5	12.7	–	HS 0304	FLAG T15P	HXK 2.5	–	Page xx
Z13	US 4514A-T20	5.0	M 4.5	14	SP 0405	–	FLAG T20	–	–	Page xx



SE(RL)-S

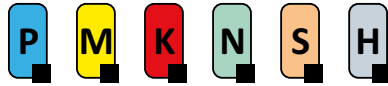

PRAMET

S



External Screw Clamped Threading Holder for TN 22 Neutral Insert

Right/Left hand screw lock tool holder for external large threading with TN22 EN insert. Suited for threading in metric or inch profile. Body treated for longer tool life.

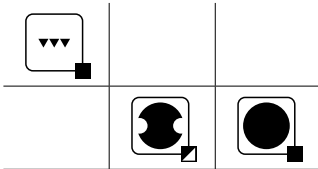
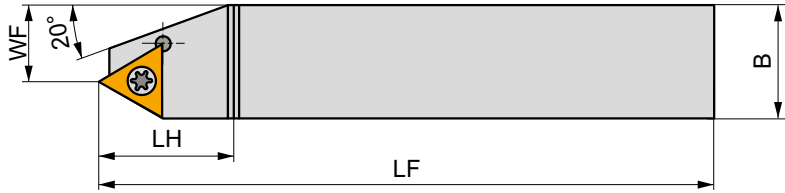
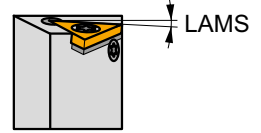
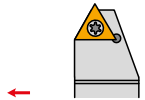
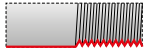

Product	H	HF	B	WF	LF	LH	LAMS		
	[mm]	[mm]	[mm]	[mm]	[mm]	[mm]	[°]		
R SER-S 2525 M 22-A	25	25	25	14	150	30	-	GI086	Z15
SER-S 3225 P 22-A	32	32	25	14	170	30	-	GI086	Z15
L SEL-S 2525 M 22-A	25	25	25	14	150	30	-	GI086	Z15
SEL-S 3225 P 22-A	32	32	25	14	170	30	-	GI086	Z15



GI086



TN 22EN..



Z15



US 4514A-T20



5.0



M 4.5



14



SP 0405



FLAG T20



Page xx



SI(RL)



PRAMET

S



Internal Screw Clamped Threading Holder for TN 11, 16 or 22 Insert

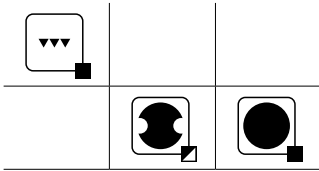
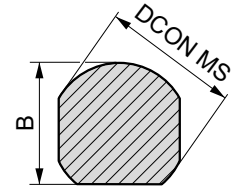
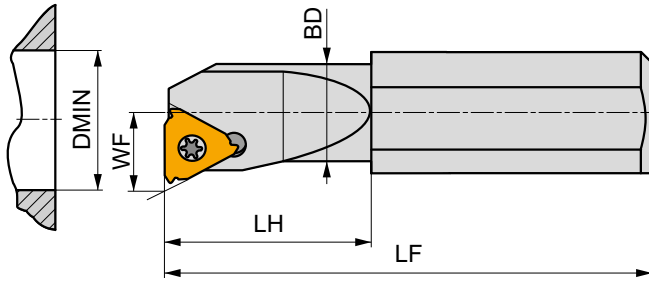
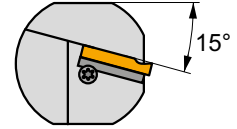
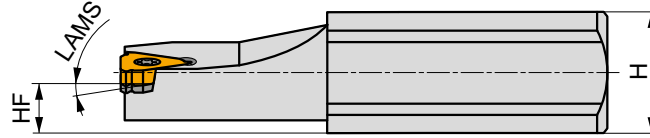
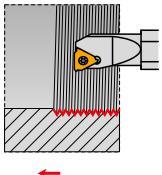









Right/Left hand screw lock boring bar for internal threading with TN11, 16 or 22 ER/EL inserts. Suited for threading in metric or inch profile. Minimum internal diameter Ø13 mm. Also suited for shallow grooving. Available with shank size Ø16 up to Ø40 mm. Body treated for longer tool life.



Product	B	DCON MS	DMIN	BD	WF	H	HF	LF	LH	LAMS	[°]	[Icon]	[Icon]	[Icon]
	[mm]	[mm]	[mm]	[mm]	[mm]	[mm]	[mm]	[mm]	[mm]					
R SIR 0010 K 11-0	14.5	16	13	10	7.45	14	7	125	25	0	-	GI085	Z11	
SIR 0010 K 11-1	14.5	16	13	10	7.45	14	7	125	25	1	-	GI085	Z11	
SIR 0013 M 11-0	14.5	16	16	13	9	14	7	150	32	0	-	GI085	Z11	
SIR 0013 M 11-1	14.5	16	16	13	9	14	7	150	32	1	-	GI085	Z11	
SIR 1416 N 16-0	14	16	22	17	11.4	14.5	7.5	160	-	0	-	GI022	Z9	
SIR 1416 N 16-1	14	16	22	17	11.4	14.5	7.5	160	-	1	-	GI022	Z9	
SIR 1416 N 16-2	14	16	16.5	15.5	10.6	14.5	7.5	160	40	2	✓	GI022	Z10	
SIR 1820 P 16	18.5	20	27	21	13.85	18	9	170	-	-	-	GI022	Z12	
SIR 2325 Q 16	23.5	25	29	26	16.55	23	11.5	180	-	-	-	GI022	Z12	
SIR 2532 S 16	30	32	36	32	19.75	25	12.5	250	-	-	-	GI022	Z12	
SIR 2532 S 22-2	30	32	25	25	16.65	25	12.5	250	80	2	✓	GI076	Z14	
SIR 2532 S 22-A	30	32	36	32	21.65	25	12.5	250	-	-	-	GI076	Z13	
SIR 3240 T 22-A	38	40	48	40	25.85	32	16	300	-	-	-	GI076	Z13	
L SIL 0010 K 11-0	14.5	16	13	10	7.45	14	7	125	25	0	-	GI085	Z11	
SIL 0010 K 11-1	14.5	16	13	10	7.55	14	7	125	25	1	-	GI085	Z11	
SIL 0013 M 11-0	14.5	16	16	13	9	14	7	150	32	0	-	GI085	Z11	
SIL 0013 M 11-1	14.5	16	16	13	9	14	7	150	32	1	-	GI085	Z11	
SIL 1416 N 16-0	14	16	22	17	11.4	14.5	7.5	160	-	0	-	GI022	Z9	
SIL 1416 N 16-1	14	16	22	17	11.4	14.5	7.5	160	-	1	-	GI022	Z9	
SIL 1416 N 16-2	14	16	16.5	15.5	10.6	14.5	7.5	160	40	2	✓	GI022	Z10	
SIL 1820 P 16	18.5	20	27	21	13.85	18	9	170	-	-	-	GI022	Z12	
SIL 2325 Q 16	23.5	25	29	26	16.55	23	11.5	180	-	-	-	GI022	Z12	
SIL 2532 S 16	30	32	36	32	19.75	25	12.5	250	-	-	-	GI022	Z12	
SIL 2532 S 22-2	30	32	25	25	16.65	25	12.5	250	80	2	✓	GI076	Z14	
SIL 2532 S 22-A	30	32	36	32	21.65	25	12.5	250	-	-	-	GI076	Z13	
SIL 3240 T 22-A	38	40	48	40	25.85	32	16	300	-	-	-	GI076	Z13	



		
GI022	TN 16NR..	TN 16NL..
GI076	TN 22NR..	TN 22NL..
GI085	TN 11NR..	TN 11NL..

									
Z10	US 3510A-T15P	3.0	M 3.5	10.6	-	-	FLAG T15P	-	-
Z11	US 2506-T07P	0.9	M 2.5	6.3	-	-	FLAG T07P	-	-
Z12	US 3512A-T15P	3.0	M 3.5	12.7	-	HS 0304	FLAG T15P	HXK 2.5	Page xx
Z13	US 4514A-T20	5.0	M 4.5	14	SP 0405	-	FLAG T20	-	Page xx
Z14	US 4514A-T20	5.0	M 4.5	14	-	-	FLAG T20	-	-
Z9	US 3510A-T15P	3.0	M 3.5	10.6	-	-	FLAG T15P	-	P-16



SI(RL)-S

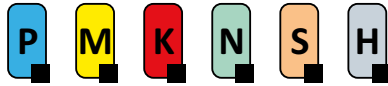

PRAMET

S



Internal Screw Clamped Threading Holder for TN 22 Neutral Insert

Right/Left hand screw lock boring bar for internal large threading with TN22 EN insert. Suited for threading in metric or inch profile. Minimum internal Ø39 mm. Available with shank size Ø32 up to Ø40 mm. Body treated for longer tool life.

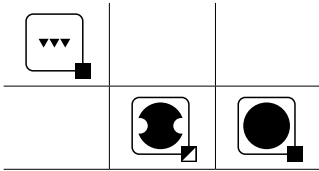
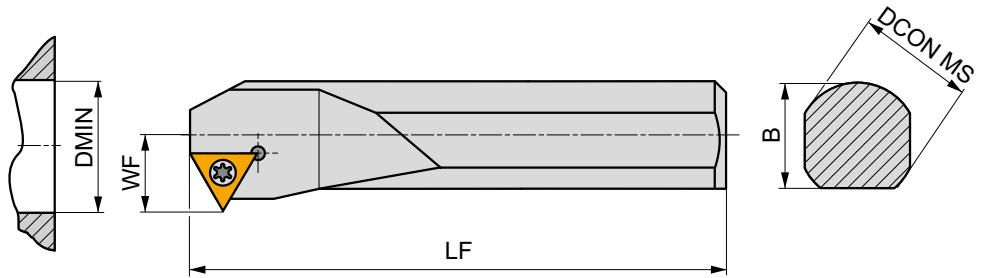
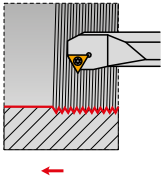

Product	B	DCON MS	DMIN	WF	H	HF	LF	LAMS		
	[mm]	[mm]	[mm]	[mm]	[mm]	[mm]	[mm]	[°]		
R SIR-S 2532 S 22-A	30	32	39	22.3	25	12.5	250	-	G1107	Z15
SIR-S 3240 T 22-A	38	40	48	27	32	16	300	-	G1107	Z15
L SIL-S 2532 S 22-A	30	32	39	22.3	25	12.5	250	-	G1107	Z15
SIL-S 3240 T 22-A	38	40	48	27	32	16	300	-	G1107	Z15



G1107



TN 22NN..



Z15



US 4514A-T20



5.0



M 4.5



14



SP 0405



FLAG T20



Page xx



DORMER PRAMET



EVERY MATERIAL

Machining steel, stainless steel, cast iron, super-alloys or non-ferrous materials, all are covered within our calculator app. Download it from your app store today. **Simply Reliable.**

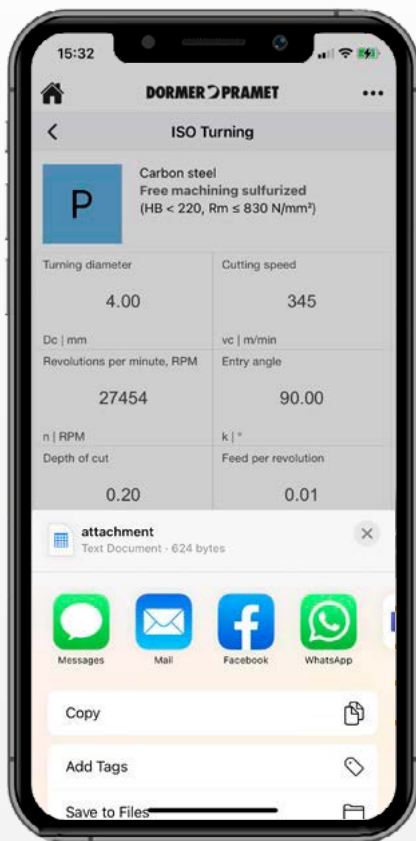



BROACHING





TURNING – GENERAL CONTENT

6		WMG & ISO 13399
10	ISO TURNING	INSTRUCTIONS
18		NAVIGATORS
57		POSITIVE INSERTS
219		NEGATIVE INSERTS
386		PARTING-OFF & GROOVING
482		THREAD TURNING
528		BROACHING
536		GENERAL TECHNICAL INFORMATION



BROACHING – ICONS OVERVIEW

General icons

	Primary use		Finishing – very good surface quality		Suitable for stable working conditions
	Possible use		Medium machining – good surface quality		Suitable for unstable working conditions
			Roughing – unlimited surface roughness		Suitable for very unstable working conditions

Features

	Internal shaping		Universal wide range option		Sharp edge
--	------------------	--	-----------------------------	--	------------

Other

	Clamping torque of screw [Nm]		Internal supply of coolant
--	-------------------------------	--	----------------------------

BROACHING INSERTS – NAVIGATOR

HZ	HZ-2
531	532

BROACHING HOLDERS – NAVIGATOR

PHZ		PHZ-2	
	HZ		HZ/2..
	03		14
	04		16
	05		18
	06		20
08			
10			
12			
	$\frac{\varnothing 9,5}{\varnothing 24,7}$		$\frac{\varnothing 44}{\varnothing 58}$
533	531	534	532



HZ

	IC	INSL	APMX	S	S1	CW
	[mm]	[mm]	[mm]	[mm]	[mm]	[mm]
0604-30	6.000	7.5	1.60	4.66	4.76	3.00
0604-40	6.000	8.0	2.50	4.66	4.76	4.00
0604-50	6.000	8.0	3.00	4.66	4.76	5.00
1006-60	10.000	13.5	4.20	6.25	6.35	6.00
1006-80	10.000	13.5	5.20	6.25	6.35	8.00
1309-100	13.000	18.5	6.20	9.40	9.53	10.00
1309-120	13.000	18.5	7.20	9.40	9.53	12.00

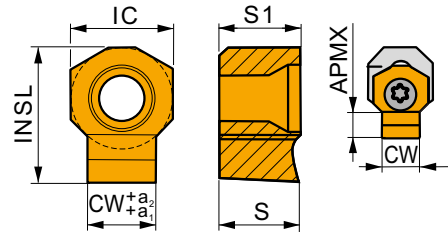

Suitability and starting values for cutting speed (vc) and feed (fz). Refer to our Machining Calculator app for further calculations.

Product	RE	P		M		K		N		S		H		CW	CWTOLL	CWTOLU
		vc	fz	vc	fz	vc	fz	vc	fz	vc	fz	vc	fz			
	[mm]	[m/min]	[mm/tooth]	[m/min]	[mm/tooth]	[m/min]	[mm/tooth]	[m/min]	[mm/tooth]	[m/min]	[mm/tooth]	[m/min]	[mm/tooth]	[mm]	[mm]	[mm]

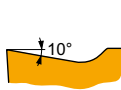

Positive geometry for broaching (one cutting edge).

HZ 1006-60 C11	333TN	-	50	0.10	30	0.09	45	0.10	-	-	-	-	6.00	0.07	0.14
HZ 1006-60 D10	333TN	-	50	0.10	30	0.09	45	0.10	-	-	-	-	6.00	0.03	0.08
HZ 1006-60 H7	333TN	-	50	0.10	30	0.09	45	0.10	-	-	-	-	6.00	0.00	0.01
HZ 1006-60 P9	333TN	-	50	0.10	30	0.09	45	0.10	-	-	-	-	6.00	-0.04	-0.01
HZ 1006-80 C11	333TN	-	50	0.10	30	0.09	45	0.10	-	-	-	-	8.00	0.08	0.17
HZ 1006-80 D10	333TN	-	50	0.10	30	0.09	45	0.10	-	-	-	-	8.00	0.04	0.10
HZ 1006-80 H7	333TN	-	50	0.10	30	0.09	45	0.10	-	-	-	-	8.00	0.00	0.02
HZ 1006-80 P9	333TN	-	50	0.10	30	0.09	45	0.10	-	-	-	-	8.00	-0.05	-0.02
HZ 1309-100 C11	333TN	-	50	0.10	30	0.09	45	0.10	-	-	-	-	10.00	0.08	0.17
HZ 1309-100 D10	333TN	-	50	0.10	30	0.09	45	0.10	-	-	-	-	10.00	0.04	0.10
HZ 1309-100 H7	333TN	-	50	0.10	30	0.09	45	0.10	-	-	-	-	10.00	0.00	0.02
HZ 1309-100 P9	333TN	-	50	0.10	30	0.09	45	0.10	-	-	-	-	10.00	-0.05	-0.02
HZ 1309-120 C11	333TN	-	50	0.10	30	0.09	45	0.10	-	-	-	-	12.00	0.10	0.21
HZ 1309-120 D10	333TN	-	50	0.10	30	0.09	45	0.10	-	-	-	-	12.00	0.05	0.12
HZ 1309-120 H7	333TN	-	50	0.10	30	0.09	45	0.10	-	-	-	-	12.00	0.00	0.02
HZ 1309-120 P9	333TN	-	50	0.10	30	0.09	45	0.10	-	-	-	-	12.00	-0.06	-0.02
HZ90 0604-30 C11	333TN	-	50	0.10	30	0.09	45	0.10	-	-	-	-	3.00	0.06	0.12
HZ90 0604-30 D10	333TN	-	50	0.10	30	0.09	45	0.10	-	-	-	-	3.00	0.02	0.06
HZ90 0604-30 H7	333TN	-	50	0.10	30	0.09	45	0.10	-	-	-	-	3.00	0.00	0.01
HZ90 0604-30 P9	333TN	-	50	0.10	30	0.09	45	0.10	-	-	-	-	3.00	-0.03	-0.01
HZ90 0604-40 C11	333TN	-	50	0.10	30	0.09	45	0.10	-	-	-	-	4.00	0.07	0.14
HZ90 0604-40 D10	333TN	-	50	0.10	30	0.09	45	0.10	-	-	-	-	4.00	0.03	0.08
HZ90 0604-40 H7	333TN	-	50	0.10	30	0.09	45	0.10	-	-	-	-	4.00	0.00	0.01
HZ90 0604-40 P9	333TN	-	50	0.10	30	0.09	45	0.10	-	-	-	-	4.00	-0.04	-0.01
HZ90 0604-50 C11	333TN	-	50	0.10	30	0.09	45	0.10	-	-	-	-	5.00	0.07	0.14
HZ90 0604-50 D10	333TN	-	50	0.10	30	0.09	45	0.10	-	-	-	-	5.00	0.03	0.08
HZ90 0604-50 H7	333TN	-	50	0.10	30	0.09	45	0.10	-	-	-	-	5.00	0.00	0.01
HZ90 0604-50 P9	333TN	-	50	0.10	30	0.09	45	0.10	-	-	-	-	5.00	-0.04	-0.01



HZ-2



	INSL	APMX	S	S1	CW
	[mm]	[mm]	[mm]	[mm]	[mm]
14-14	36.0	8.00	13.90	14.00	14.00
16-16	36.0	9.00	13.90	14.00	16.00
18-18	45.0	12.00	15.90	16.00	18.00
20-20	45.0	13.00	15.90	16.00	20.00

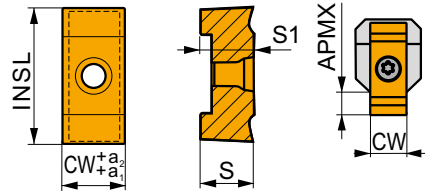

Suitability and starting values for cutting speed (vc) and feed (fz). Refer to our Machining Calculator app for further calculations.

Product	RE	P		M		K		N		S		H		CW	CWTOLL	CWTOLU
		vc	fz	vc	fz	vc	fz	vc	fz	vc	fz	vc	fz			
	[mm]	[m/min]	[mm/tooth]	[m/min]	[mm/tooth]	[m/min]	[mm/tooth]	[m/min]	[mm/tooth]	[m/min]	[mm/tooth]	[m/min]	[mm/tooth]	[mm]	[mm]	[mm]

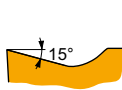

Positive geometry for broaching (two cutting edges).

HZ/2 14-14 C11	333TN	-	50	0.10	30	0.09	45	0.10	-	-	-	-	-	14.00	0.10	0.21
HZ/2 14-14 H7	333TN	-	50	0.10	30	0.09	45	0.10	-	-	-	-	-	14.00	0.00	0.02
HZ/2 14-14 P9	333TN	-	50	0.10	30	0.09	45	0.10	-	-	-	-	-	14.00	-0.06	-0.02
HZ/2 16-16 C11	333TN	-	50	0.10	30	0.09	45	0.10	-	-	-	-	-	16.00	0.10	0.21
HZ/2 16-16 H7	333TN	-	50	0.10	30	0.09	45	0.10	-	-	-	-	-	16.00	0.00	0.02
HZ/2 16-16 P9	333TN	-	50	0.10	30	0.09	45	0.10	-	-	-	-	-	16.00	-0.06	-0.02
HZ/2 18-18 C11	333TN	-	50	0.10	30	0.09	45	0.10	-	-	-	-	-	18.00	0.10	0.21
HZ/2 18-18 H7	333TN	-	50	0.10	30	0.09	45	0.10	-	-	-	-	-	18.00	0.00	0.02
HZ/2 18-18 P9	333TN	-	50	0.10	30	0.10	45	0.10	-	-	-	-	-	18.00	-0.06	-0.02
HZ/2 20-20 C11	333TN	-	50	0.10	30	0.09	45	0.10	-	-	-	-	-	20.00	0.11	0.24
HZ/2 20-20 H7	333TN	-	50	0.10	30	0.09	45	0.10	-	-	-	-	-	20.00	0.00	0.02
HZ/2 20-20 P9	333TN	-	50	0.10	30	0.10	45	0.10	-	-	-	-	-	20.00	-0.07	-0.02



PHZ

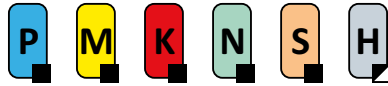

PRAMET

S



Int. Broaching Tool Holder for Small Diameters with Single-Sided HZ Inserts

Internal tool holder for broaching up to 12 mm width. Minimum internal diameter $\varnothing 9.5$ mm. Body treated for longer tool life.

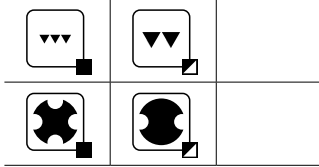
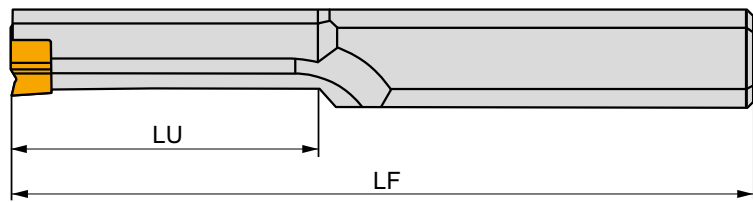
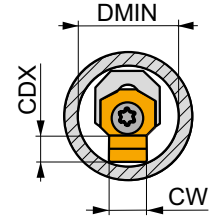
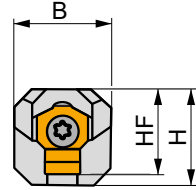
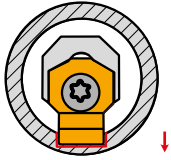

Product	H	HF	B	OAL	LU	CW	DMIN	CDX	kg	G	S	
	[mm]	[mm]	[mm]	[mm]	[mm]	[mm]	[mm]					
N	PHZ 90 1104-06	11.3	9	8.5	160	35	3.00	9.5	1.6	0.17	GI239	SH21
	PHZ 90 1107-06	11.3	10	7	200	60	-	-	-	0.19	GI240	SH21
	PHZ 90 1111-06	11.3	12	-	200	60	-	-	-	0.19	GI240	SH21
	PHZ 1512-10	15.5	16.2	-	220	-	-	-	-	0.40	GI224	SH22
	PHZ 2014-13	20.6	21.5	-	250	-	-	-	-	0.65	GI225	SH23

GI224		HZ 1006-60	HZ 1006-80
GI225		HZ 1309-100	HZ 1309-120
GI239		HZ90 0604-30	-
GI240		HZ90 0604-40	HZ90 0604-50

SH21	DVF 3593	0.8	M 2.5	10	TX207PLUS
SH22	DVF 2260	3.6	M 4	15	TX215PLUS
SH23	5513 020-14	8.5	M 6	18	TX225PLUS



PHZ-2

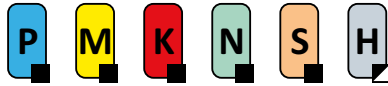

PRAMET

S



Int. Broaching Tool Holder for Larger Diameters with Double-Sided HZ Inserts

Internal tool holder for broaching up to 20 mm width. Minimum internal diameter Ø44 mm. Body treated for longer tool life.

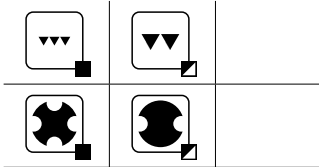
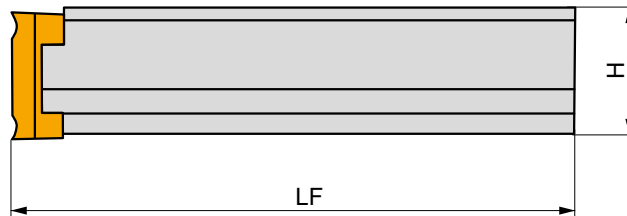
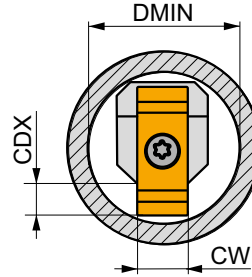
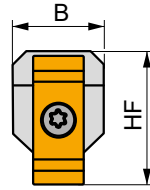
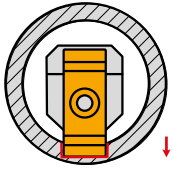

Product	H	HF	B	OAL	CW	DMIN	CDX	kg	GI235	SH23
	[mm]	[mm]	[mm]	[mm]	[mm]	[mm]	[mm]			
N PHZ/2 3625-14	36	37.5	25	300	-	44	-	1.86	GI235	SH23
	PHZ/2 4832-18	48	50	32	400	-	58	2.00	GI241	SH24

GI235	HZ/2 14-14	HZ/2 16-16
GI241	HZ/2 18-18	HZ/2 20-20

		Nm			
SH23	5513 020-14	8.5	M 6	18	TX225PLUS
SH24	5513 021-03	13.0	M 8	22	DMN 3124



DORMER PRAMET



HELP IS AT HAND

Our technical support team are always at hand to help with any technical questions or queries you have about our technical apps. Use the contact us details to reach out to your local Dormer Pramet sales office. **Simply Reliable.**

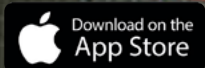
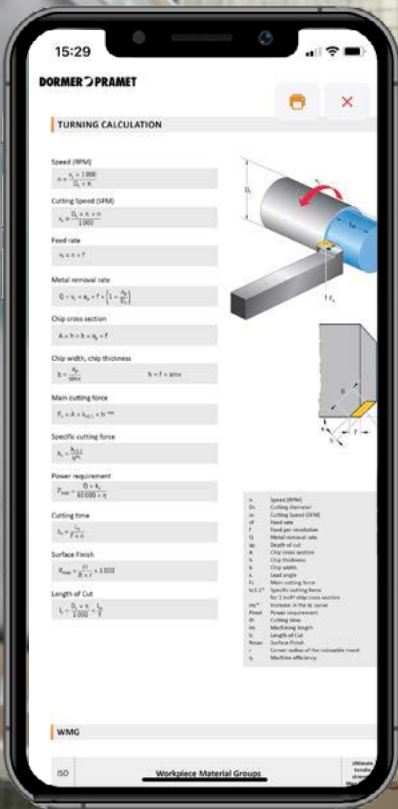



GENERAL TECHNICAL INFORMATION





TURNING – GENERAL CONTENT

6		WMG & ISO 13399
10	ISO TURNING	INSTRUCTIONS
18		NAVIGATORS
57		POSITIVE INSERTS
219		NEGATIVE INSERTS
386		PARTING-OFF & GROOVING
482		THREAD TURNING
528		BROACHING
536		GENERAL TECHNICAL INFORMATION



WORKPIECE MATERIAL GROUP (WGM)

ISO To select a cutting grade and geometry for a broad range of workpiece materials

General definition
i.e. Steel, Stainless Steel...

P **M** **K** **N** **S** **H**

Subgroup To navigate and select a tool by suitability for a more specific range of workpiece materials

Definition by structure/composition
i.e. Plain Carbon Steel, Alloy Steel...

P **M** **K** **N** **S** **H**

P1

P2

P3

P4

WGM To select and provide cutting conditions within a bandwidth of $\pm 10\%$

Definition by hardness/ultimate tensile strength
i.e. $160 < 220$ HB, $620 < 900$ N/mm² ...

P

P1 **P1.1** **P1.2** **P1.3**

P2 **P2.1** **P2.2** **P2.3**

P3 **P3.1** **P3.2** **P3.3**

P4 **P4.1** **P4.2** **P4.3**

ABOUT DORMER PRAMET'S WORKPIECE MATERIAL CLASSIFICATION

Workpiece Material Groups (WGM) are used to support easy and reliable selection of the right cutting tool and starting values for machining conditions in particular applications.

Dormer Pramet classifies workpiece materials into six different coloured groups;

- **Blue:** Steel and cast steel (P-group)
- **Yellow:** Stainless steel (M-group)
- **Red:** Cast iron (K-group)
- **Green:** Non-ferrous metals (N-group)
- **Brown:** High-temperature alloys (S-group)
- **Grey:** Hardened materials (H-group)

Each of these are divided into subgroups on the basis of their structure and/or composition. For example, P-group steel and cast steel is split into four subgroups, namely;

- **P1** – Free machining steel
- **P2** – Plain carbon steel
- **P3** – Alloy steel
- **P4** – Tool steel

A final division includes material properties, such as hardness and ultimate tensile strength. This is to provide our customers with a complete tool recommendation, including starting values for cutting speed and feed.

The table on the next page includes a description of each workpiece material group, as well as examples of commonly used designations.

WORKPIECE MATERIAL GROUP (WMG)

ISO group	Subgroup	WMG (Work Material Group)	k_{vc}	Examples of material (AISI, EN, DIN, ČSN, GB, SS, STN, BS, UNE, AFNOR, ASTM, GOST, UNS, UNI, ...)
P Steel and cast steel (steels with alloy content ≤ 10 % and a hardness of < 45HRC)	P1 Free machining steel (carbon steels with increased machinability)	P1.1 Free machining sulfurized carbon steel with a hardness of < 220 HB	1.33	AISI 1108, EN 15522, DIN 1.0723, SS 1922, ČSN 11120, BS 210A15, UNE F.210F, GB Y15, AFNOR 10F1, GOST A30, UNI CF10S20
		P1.2 Free machining sulfurized and phosphorized carbon steel with a hardness of < 180 HB	1.49	AISI 1211, EN 115Mn30, DIN 1.0715, SS 1912, ČSN 11109, BS 230M7, UNE F.2111, GB Y15, AFNOR S250, GOST A40G, UNI CF95Mn28
		P1.3 Free machining sulfurized/phosphorized and leaded carbon steel with a hardness of < 160 HB	1.53	AISI 12L13, EN 115MnPb30, DIN 1.0718, SS 1914, ČSN 12110, BS 210M16, UNE F.2114, GB Y15Pb, AFNOR S250Pb, GOST A35G2, UNI CF10SPb20
	P2 Plain carbon steel (steels comprised of mainly iron and carbon)	P2.1 Plain low carbon steel containing < 0.25 % C with a hardness of < 180 HB	1.14	AISI 1015, EN C15, DIN 1.0401, SS 1350, ČSN 11301, BS 080A15, UNE F.111, GB 15, AFNOR C18RR, GOST S22ps, UNI Fe360
		P2.2 Plain medium carbon steel containing < 0.55 % C with a hardness of < 240 HB	1.00	AISI 1030, EN C30, DIN 1.0528, SS 1550, ČSN 12031, BS 080M32, UNE F.1130, GB 30, AFNOR AF50C30, GOST 30G, UNI Fe590
		P2.3 Plain high carbon steel containing > 0.55 % C, with a hardness of < 300 HB	0.89	AISI 1060, EN C60, DIN 1.0601, SS 1655, ČSN 12061, BS 080A62, UNE F.513, GB 60, AFNOR 1C60, GOST 60G, UNI C60
	P3 Alloy steel (carbon steels with an alloying content ≤ 10 %)	P3.1 Alloy steel with a hardness of < 180 HB	0.92	AISI 5015, EN 16Mo3, DIN 1.5415, SS 2912, ČSN 15020, BS 1501-240, UNE F.2601, GB 16Mo, AFNOR 15D3, GOST 15M, UNI 16Mo3KW
		P3.2 Alloy steel with a hardness of 180 – 260 HB	0.74	AISI 4140, EN 42CrMo4, DIN 1.7225, SS 2244, ČSN 15142, BS 708M40, UNE F.8232, GB 42CrMo, AFNOR 42CD4, GOST 40CHFA, UNI 42CrMo4
		P3.3 Alloy steel with a hardness of 260 – 360 HB	0.63	AISI 4140, EN 42CrMo4, DIN 1.7225, SS 2244, ČSN 15142, BS 708M40, UNE F.8232, GB 42CrMo, AFNOR 42CD4, GOST 40CHFA, UNI 42CrMo4
	P4 Tool steel (special alloy steel for tools, dies and molds)	P4.1 Tool steel with a hardness of < 26 HRC	0.55	AISI D2, EN X155CrVMo12-1, DIN 1.2370, SS 2736, ČSN 19573, BS BD2, UNE F.520A, GB Cr12Mo1V1, AFNOR Z160CDV12, GOST Ch12MF, UNI X155CrVMo121KU
		P4.2 Tool steel with a hardness of 26 – 39 HRC	0.47	AISI D2, EN X155CrVMo12-1, DIN 1.2370, SS 2736, ČSN 19573, BS BD2, UNE F.520A, GB Cr12Mo1V1, AFNOR Z160CDV12, GOST Ch12MF, UNI X155CrVMo121KU
		P4.3 Tool steel with a hardness of 39 – 45 HRC	0.38	AISI D2, EN X155CrVMo12-1, DIN 1.2370, SS 2736, ČSN 19573, BS BD2, UNE F.520A, GB Cr12Mo1V1, AFNOR Z160CDV12, GOST Ch12MF, UNI X155CrVMo121KU

WORKPIECE MATERIAL GROUP (WMG)



ISO group	Subgroup	WMG (Work Material Group)	k_{vg}	Examples of material (AISI, EN, DIN, ČSN, GB, SS, STN, BS, UNE, AFNOR, ASTM, GOST, UNS, UNI, ...)
M Stainless steel (corrosion resistant steels with $\geq 11\%$ chromium content)	M1 Ferritic stainless steel (straight chromium non-hardenable alloys)	M1.1 Stainless steel, ferritic with a hardness of < 160 HB	1.22	AISI 5429, EN X7Cr14, DIN 1.4001, SS 2326, BS 434517, UNE F.3401, AFNOR Z8C12, GOST 08Ch13, UNI X6CrTi12
		M1.2 Stainless steel, ferritic with a hardness of 160 – 220 HB	1.03	AISI 446, EN X10CrAl24, DIN 1.4762, SS 2322, ČSN 17113, BS 430517, UNE F.3154, GB 10Cr17, AFNOR Z10CA524, GOST 12Ch17, UNI X16Cr26
		M2.1 Stainless steel, martensitic with a hardness of < 200 HB	1.08	AISI 430F, EN X14CrMo517, DIN 1.4104, SS 2383, ČSN 17140, BS 410521, UNE F.3117, AFNOR Z10CF17, UNI X10Cr517
	M2 Martensitic stainless steel (straight chromium hardenable alloys)	M2.2 Stainless steel, martensitic with a hardness of 200 – 280 HB	0.89	AISI 440C, EN X105CrMo17, DIN 1.4125, SS 2385, ČSN 17023, BS 425C11, UNE F.3402, GB 102Cr17Mo, AFNOR Z100CD17, GOST 95Ch18, UNI 6X6CrNi 13 04
		M2.3 Stainless steel, martensitic with a hardness of 280 – 380 HB	0.75	AISI 420, EN X45Cr13, DIN 1.4034, ČSN 17029, BS 425C11, UNE F.3405, AFNOR Z44C14, GOST 20X17H12, UNI X30Cr13
		M3.1 Stainless steel, austenitic with a hardness of < 200 HB	1.00	AISI 304, EN X5CrNi18-12, DIN 1.4303, SS 2352, ČSN 17249, BS 305517, UNE F.3513, GB 10Cr18Ni12, AFNOR Z8CN18.12, UNI X7CrNi18 10
	M3 Austenitic stainless steel (chromium-nickel and chromium-nickel-manganese alloys)	M3.2 Stainless steel, austenitic with a hardness of 200 – 260 HB	0.86	AISI 309, EN X15CrNiSi20-12, DIN 1.4828, ČSN 17251, BS 309S24, UNE F.3312, GB 1G23Ni13, AFNOR Z15CNS20.12, GOST 20Ch20Ni452, UNI 16CrNi23 14
		M3.3 Stainless steel, austenitic with a hardness of 260 – 300 HB	0.77	AISI 5848, EN X45CrNiW18-9, DIN 1.4873, BS 331540, UNE F.3211, AFNOR Z35CNW514-4, UNI X45CrNiW 18 9
		M4.1 Stainless steel, austenitic-ferritic or super-austenitic with a hardness of < 300 HB	0.75	AISI 329, EN X1-NiCrMoCu25-20-5, DIN 1.4539, SS 2562, ČSN 17265, BS 318513, UNE F.3552, GB 022Cr25NiMo2N, AFNOR Z1NCUDU25.20
	M4 Super-austenitic, Duplex or Precipitation Hardening stainless steel (austenitic alloys with $> 20\%$ Ni, austenitic-ferritic microstructure or precipitation hardened)	M4.2 Stainless steel, precipitation hardening austenitic with a hardness of 300 – 380 HB	0.64	AISI 631 (17-7PH), EN X7CrNiAl17-7, DIN 1.4568, SS 2388, ČSN 17465, BS 301513, UNE F.3217, GB 07Cr17Ni7Al, AFNOR Z9CNAl17-07, GOST 09Ch17Ni7Al, UNI X53CrMnNi21 9



WORKPIECE MATERIAL GROUP (WMG)

ISO group	Subgroup	WMG (Work Material Group)	k_{wc}	Examples of material (AISI, EN, DIN, ČSN, GB, SS, STN, BS, UNE, AFNOR, ASTM, GOST, UNS, UNI, ...)		
K	K1	Gray iron (GG) (iron-carbon castings with a lamellar graphite microstructure)	K1.1	Gray iron, ferritic or ferritic-pearlitic with a hardness of < 180 HB	1.35	ASTM A48 Grade 20 (F11401), EN-JL-100, DIN GG-10 (0.6010), SS 0110, STN 422410, BS Grade 150, UNE FG10, GB HAT 100, AFNOR Fc10D, GOST SC 10, UNI G10
			K1.2	Gray iron, ferritic-pearlitic or pearlitic with a hardness of 180 – 240 HB	1.00	ASTM A48 Grade 30 (F12101), EN-JL-1030, DIN GG-20 (0.6020), SS 0120, STN 422420, BS Grade 220, UNE FG20, GB HT200, AFNOR Fc20D, GOST Ч420, UNI G20
			K1.3	Gray iron, pearlitic with a hardness of 240 – 280 HB	0.75	ASTM A48 Grade 50 (F13501), EN-JL-1060, DIN GG-35 (0.6035), SS 0135, STN 422435, BS Grade 350, UNE FG35, GB HAT300, AFNOR Fc35D, GOST SC35, UNI G35
	K2	Malleable iron (GTS/GTW) (heat-treated iron-carbon castings with a graphite-free microstructure)	K2.1	Malleable iron, ferritic with a hardness of < 160 HB	1.39	ASTM A602 Grade M3210 (F20000), EN-JM-1130, DIN GTS-35 (0.8135), SS 0815, BS B340/12, UNE Type A, AFNOR MN 35-10, GOST K435-10
			K2.2	Malleable iron, ferritic or pearlitic with a hardness of 160 – 200 HB	1.13	ASTM A602 Grade M4504 (F20001), EN-JM-1040, DIN GTS-50-05 (0.8045), BS P50-05, AFNOR MB 45-7
			K2.3	Malleable iron, pearlitic with a hardness of 200 – 240 HB	0.90	ASTM A602 Grade M7002 (F20004), EN-JM-1140, DIN GTS-45 (0.8145), SS 0854, STN 422540, BS P 45-06, UNE Typ B, AFNOR MP 50-5, GOST K445-7, UNI GMM 45
	K3	Ductile iron (GGG) (iron-carbon castings with a nodular graphite microstructure)	K3.1	Ductile (nodular/spheroidal) iron, ferritic with a hardness of < 180 HB	1.23	ASTM A536 Grade 60-40-18 (F32800), EN-JS-1030, DIN GGG-40 (0.7040), SS 0717, STN 422304, BS 420/12, UNE FGE 42-12, GB QT 400, AFNOR FGS 400-12, GOST B440
			K3.2	Ductile (nodular/spheroidal) iron, ferritic or pearlitic with a hardness of 180 – 220 HB	0.94	ASTM A536 Grade 80-55-06 (F33800), EN-JS-1050, DIN GGG-50 (0.7050), SS 0727, STN 422305, BS 500/7, UNE FGE 50-7, GB QT 500-7, AFNOR FGS 500-7, GOST B450
			K3.3	Ductile (nodular/spheroidal) iron, pearlitic with a hardness of 220 – 260 HB	0.76	ASTM A536 Grade 100-70-03 (F34800), EN-JS-1060, DIN GGG-60 (0.7060), SS 0732, STN 422306, BS 600/3, UNE FGT 0-2, GB QT 600-3, AFNOR FGS 600-3, GOST B460
	K4	Austenitic or austempered ductile iron (NI-Resist/ADI) (iron-carbon alloy castings with an austenitic or ausferrite microstructure)	K4.1	Austenitic cast iron with a hardness of < 180 HB	1.14	ASTM A436 Type 1 (L-NiCuCr 15 6 2, F41000), EN-JL-3011, DIN GGL-NiMn 13 7 (0.6652), SS 0523, BS Grade F1, AFNOR FGL-Ni13Mn7, GOST S-NiMn 13 7
			K4.2	Austenitic cast iron with a hardness of 180 – 240 HB	0.86	ASTM A439 Type D-2B (S-NiCr 20 3, F43001), EN-JS-3021, DIN GGG-NiMn 23 4, SS 0776, BS Grade S2M, AFNOR FGS Ni23 Mn4, GOST ЧН19Х3U
			K4.3	Austempered ductile iron with a hardness of 240 – 280 HB	0.63	ASTM A897 Grade 110-70-11
	K5	Compacted graphite iron (CGI) (iron-carbon castings with a vermicular graphite structure)	K4.4	Austempered ductile iron with a hardness of 280 – 320 HB	0.54	ASTM A897 Grade 125-80-10, EN-JS-1100, DIN GGG-90 (5.3400)
K4.5			Austempered ductile iron with a hardness of 320 – 360 HB	0.45	ASTM A897 Grade 2 (150-110-07), EN-JS-1110, DIN GGG-100 (5.3403)	
K5.1			Vermicular, compacted graphite iron with a hardness of < 180 HB	1.29	ASTM A842 Grade 300, EN-GJV-300, DIN GGV 30, GOST ЧBT30,	
K5		K5.2	Vermicular, compacted graphite iron with a hardness of 180 – 220 HB	0.97	ASTM A842 Grade 350, EN-GJV-350, DIN GGV 35 (5.2200), GOST ЧBT30,	
		K5.3	Vermicular, compacted graphite iron with a hardness of 220 – 260 HB	0.75	ASTM A842 Grade 450, EN-GJV-450, DIN GGV 45, GOST ЧBT45,	



WORKPIECE MATERIAL GROUP (WMG)

ISO group	Subgroup	WMG (Work Material Group)	k_{vg}	Examples of material (AISI, EN, DIN, ČSN, GB, SS, STN, BS, UNE, AFNOR, ASTM, GOST, UNS, UNI, ...)
N Non-ferrous metals (metals including alloys without an appreciable amount of iron)	N1 Wrought aluminium	N1.1 Pure aluminium and wrought aluminium alloys with a hardness of < 60 HB	1.33	UNS A91200, EN AL99.6, DIN 3.0205, SS 4010, STN 424009, BS 1C, UNE L-3001, GB L5, AFNOR A4, GOST A1C, UNI 3567
		N1.2 Wrought aluminium alloys with a hardness of 60 – 100 HB	1.00	UNS A93004, EN AlMn0.5Mg0.5, DIN 3.0505, SS 4054, STN 424432, BS N31, UNE L-3831, GB LF2, AFNOR A-M1, GOST AlMn, UNI 3568
		N1.3 Wrought aluminium alloys with a hardness of 100 – 150 HB	0.67	UNS A95083, EN AlMg4.5Mn0.7, DIN 3.3547, SS 4140, STN 424415, BS N8, UNE L-3321, GB AlMg4.5Mn, AFNOR A-G4.5Mn, GOST AlMg 4.5, UNI P-AlMg4.4
	N2 Cast aluminium	N2.1 Cast aluminium alloys with a hardness of < 75 HB	0.67	UNS A02080, EN AlCu45, BS LM11, STN 424331, UNE AlSi1Cu, GOST AlMg5K, UNI G-AlSi7Mg
		N2.2 Cast aluminium alloys with a hardness of 75 – 90 HB	0.60	UNS A02420, EN AlCu4Ni2Mg2, SS AlSi7MgFe, BS LM6, STN 424519, UNE Al-7SiMg, AFNOR A-S7G, GOST AK7, UNI G-AlSi7Mg
		N2.3 Cast aluminium alloys with a hardness of 90 < 140 HB	0.43	UNS A03360, EN G-ALCu4NiMg2, SS AlSi10Mg, STN 424336, BS LM 30, AFNOR A-S10G, UNI G-AlSi9Mg
	N3 Copper or copper alloys	N3.1 Free-cutting copper-alloys materials with excellent machining properties	0.70	UNS C14700, EN CuPb1P, DIN 2.1498, STN 423214, BS C111, AFNOR CuZn35Pb2, GOST L63-3, UNI CuS(P0.01)
		N3.2 Short-chip copper-alloys with good to moderate machining properties	0.41	UNS C81540, EN CuNi25Cr, DIN 2.0857, STN 423220, BS NS113, UNE CuSn12, AFNOR CuZn40, GOST L60, UNI P-CuZn-40
		N3.3 Electrolytic copper and long-chip copper-alloys with moderate to poor machining properties	0.21	UNS C10100, EN CuAg0.1, DIN 2.1203, SS 5010, UNE CuS13Mn1, AFNOR Cu-C2, GOST M1f, UNI Cu-0F
	N4 Polymers (synthetic or semi-synthetic materials)	N4.1 Thermoplastic polymers	0.70	ABS, Acryl, Duraplast, Elastomer, EP, Epoxid, FEP, Fluor, Gummi, Kautschuk, Latex, ME, MPF, PA, PAl, PC, PE, PEEK, PEI, PES, PET, PF, Phenolharze, PI, PMMA, Polyamide, Polyester, Polyolefine, Polysulfon, POM, PP, PPE, PPS, PS, PSU, PTFE, PU, PUR, PVDF, SAN, SI, Styrol, UF, Ureol
		N4.2 Thermosetting polymers	0.27	Aramid, Epoxy, Fluoropolymer, Methacrylate, Melamine, Phenolic, Polyester, Polyimide, Polymethacrylimide, Polyurethane
		N4.3 Reinforced polymers or composites	0.29	CFK, GFK, GMT, Honeycomb, Kevlar, LFT, Organo, SMC
	N5 Graphite	N5.1	1.0	CGM-1, CM-00, GM-10, GM-11, GR030, GR030PI, GR060, GR060PI, GR125, MC-01, MC-01R0, MC-03, MC-03M, IG11, IG-15, IG-32, IG-43, IG-45, IG-70, ISEM-1, ISEM-2, ISEM-3, R8340, R8500X, Technograph 15, Technograph 30, ISO-63, EDM C-3, EDM1, EDM3, ISO-90, ISO-93, ISO-95, R8510, R8650, R8650



WORKPIECE MATERIAL GROUP (WMG)

ISO group	Subgroup	WMG (Work Material Group)	$k_{w,g}$	Examples of material (AISI, EN, DIN, ČSN, GB, SS, STN, BS, UNE, AFNOR, ASTM, GOST, UNS, UNI, ...)
S High-temperature alloys (superalloys with high temperature strength and corrosion resistant surpassing that of stainless steel)	S1 Titanium or titanium alloys	S1.1 Titanium or titanium alloys, with a hardness of <200 HB	1.94	UNS R50250 (Grade 1), EN Ti 99.6, DIN 3.7035, BS TA.2, UNE Ti-Po2, AFNOR T-40, GOST BT1-00, AISI R50250, 3.7025, T35, 2TA1, R50400, 3.7035, 2TAZ,
		S1.2 Titanium alloys, with a hardness of 200 – 280 HB	1.72	UNS R56404 (Grade 29), EN Ti2Cu, DIN 3.7124, BS TA.21, UNE Ti-P11, AFNOR T-U2, AISI TA6V, Ti-6Al-4V, Ti 10.2.3, Ti5553
		S1.3 Titanium alloys, a hardness of 280 – 360 HB	1.44	UNS R54250 (Grade 38), EN TiAl6V4, DIN 3.7165, ČSN TiAl6VELI, BS TA. 13, UNE Ti-P63, AFNOR T-A6V, GOST BT6, AISI TA6V, Ti-6Al-4V, Ti 10.2.3, Ti5553
	S2 Fe-based high-temperature alloys	S2.1 High-temperature Fe-based alloys with a hardness of <200 HB	1.33	UNS N08801 (Incoloy 801), EN X8 NiCrAlTi31-21, DIN 1.4959, BS NA 15, AFNOR Z8NC33-21, AISI A-286, Discaloy, Haynes 556, Inconel 909, Greek Ascology
		S2.2 High-temperature Fe-based alloys with a hardness of 200 – 280 HB	1.17	UNS N19907, EN X6NiCrTiMoVB25-15-2, DIN 1.4980, SS 2570, BS HR52, AFNOR Z6NCTDV25.15B, GOST 36HXT10, AISI A-286, Discaloy, Haynes 556, Inconel 909, Greek Ascology
		S3.1 High-temperature Ni-based alloys with a hardness of <280 HB	1.00	UNS A09706 (Inconel 706), EN NiCr25FeAl, DIN 2.4856, BS HR 6, ČSN Inconel 625, UNE F.3313, GB 1Cr16Ni35, AFNOR NC22FeDNB, GOST XH38BT, AISI Inconel 718, 706 Waspalloy, Udimet 720, Inconel 625
	S3 Ni-based high-temperature alloys	S3.2 High-temperature Ni-based alloys with a hardness of 280 – 360 HB	0.83	UNS N07001, EN NiCr20Co13Mo4Ti3Al, DIN 2.4654, BS HR 2, ČSN Waspalloy, AFNOR NCKD 20ATV, GOST XH80T5K0, AISI Inconel 718, 706 Waspalloy, Udimet 720, Inconel 625
		S4 Co-based high-temperature alloys	S4.1 High-temperature Co-based alloys with a hardness of <240 HB	0.78
	S4.2 High-temperature Co-based alloys with a hardness of 240 – 320 HB		0.67	UNS R30016 (Stellite 6b), EN CoCr20W15Ni, DIN 2.4964, AFNOR KC 20 WN, GOST ЛК52, AISI Haynes 25, Stellite 21, 31









WORKPIECE MATERIAL GROUP (WMG)

ISO group	Subgroup	WMG (Work Material Group)	k_{vg}	Examples of material (AISI, EN, DIN, ČSN, GB, SS, STN, BS, UNE, AFNOR, ASTM, GOST, UNS, UNI, ...)
H Hardened materials (any engineering metal with a hardness > 45 HRC)	H1 Chilled cast iron	H1.1 Chilled cast iron with a hardness of < 440 HB	1.52	UNS F45001, EN-GJS-1050-6, DIN 5.3406, SS 0512, BS Grade 2A
		H2.1 Hardened cast iron with a hardness < 55 HRC	0.90	UNS F45003, EN-GJS-1400-1, DIN 5.3405, SS 0457, BS Grade 3D
	H2 Hardened cast iron	H2.2 Hardened cast iron with a hardness > 55 HRC	0.77	UNS F45003, EN G-X260NiCr4-2, DIN 0.9620, SS 0466, BS Grade S
		H3.1 Hardened steel with a hardness of < 51 HRC	1.00	AISI 4135, EN 34CrMo4, DIN 1.7220, SS 2234, STN 415131, BS 198, UNE F.1250, GB 35CrMo, AFNOR 35CD4, GOST AC38XTM, UNI 35CrMo4KB
	H3 Hardened steel < 55 HRC	H3.2 Hardened steel with a hardness of 51 – 55 HRC	0.82	AISI 4135, EN 34CrMo4, DIN 1.7220, SS 2234, STN 415131, BS 198, UNE F.1250, GB 35CrMo, AFNOR 35CD4, GOST AC38XTM, UNI 35CrMo4KB
		H4 Hardened steel > 55 HRC	H4.1 Hardened steel with a hardness of 55 – 59 HRC	0.64
	H4.2 Hardened steel with a hardness of > 59 HRC		0.54	UNS T31501, EN 100MnCrW4, DIN 1.2510, SS 2140, STN 419413, BS B01, UNE F.5220, GB 9CrWMn, AFNOR 90MnWCrV5, GOST 9XBТ, UNI 95MnWCr5KU

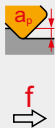

CORRECTION FACTORS

Correction factors for specific type of operation C_{VcO}

 															
	0.5			1.5			2.5			5.0			12.0		
	I	II	III	I	II	III	I	II	III	I	II	III	I	II	III
	0.05	0.08	0.10	0.10	0.15	0.20	0.20	0.30	0.40	0.40	0.60	0.80	0.80	1.00	1.30
Chip-breakers for fine finishing (FF, FF2...)	1.15	1.00	0.95	0.85	0.80	–	–	–	–	–	–	–	–	–	–
Chip-breakers for finishing (NF, SF...)	–	–	1.20	1.05	1.00	1.05	1.00	0.90	–	–	–	–	–	–	–
Chip-breakers for medium machining (FM, M, NM, NMR, SM...)	–	–	–	–	–	1.15	1.10	1.00	0.95	0.85	–	–	–	–	–
Chip-breakers for roughing (RM, NRM, NR, R...)	–	–	–	–	–	–	–	–	1.25	1.10	1.00	0.95	0.65	–	–
Chip-breakers for heavy roughing (HR, HR2, NR2, OR...) for 45 min durability	–	–	–	–	–	–	–	–	–	1.25	1.20	1.15	1.05	1.00	0.95

Correction factors for required durability C_{VcT}

	minutes	10	15	20	30	45	60
General machining operations (fine finishing up to roughing)		1.13	1.00	0.93	0.84	0.76	0.71
Heavy machining operations (heavy roughing)		–	–	–	1.10	1.00	0.93

Additional correction factors C_{VcA}

Machining environment	C_{VcA}
Condition of the work-material (hard skin due to forging or casting)	0.70
Internal turning	0.75
Parting and grooving (radial)	0.88
Face grooving	0.80
Interrupted cut	0.80
Unstable machining conditions	0.85
Common machining conditions	1.00
Stable machining conditions	1.20

Resulting corrected cutting speed v_{cC}

$$v_{cC} = v_c \cdot k_{vG} \cdot C_{VcO} \cdot C_{VcT} \cdot C_{VcA}$$

- k_{vG} – coefficient of used material
- v_c – starting speed from catalogue page



DEFINITION OF BASIC TERMS

Insert parts

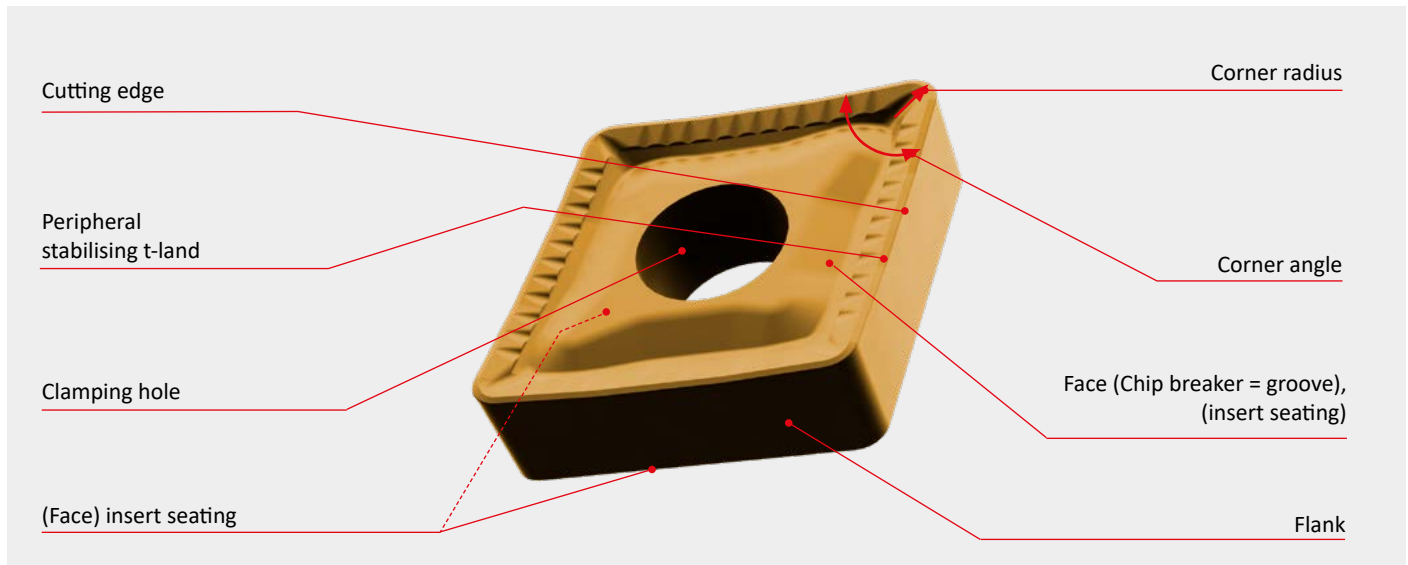

Corner radius – determines in most cases the recommended minimum depth of cut and, together with the feed, also determines the achieved roughness.

The **Cutting edge** is the intersection of face and flank surfaces. Its longitudinal roughness is one of the first evaluation criteria when assessing an insert.

The **insert corner angle** is very important with regard to the usable cutting edge length, resistance in the interrupted cut, heat dissipation from the cutting point, etc.

The **peripheral stabilising t-land** is an area located after the cutting edge. Its width is very often variable and its angle also changes regularly. In most cases, the width of the t-land, together with the adjustment angle at which the insert works, is a limiting factor for specifying the minimum feed.

The **chip breaker** – together with the t-land determines the application area (narrow grooves – finishing and materials with short chip, wide grooves – mostly roughing operations and tough materials).

The **clamping hole** – if there is no hole, the insert will definitely be designed for the ISO C clamping system. If the hole is cylindrical, the insert is designed for the ISO P, M, D + clamping systems (in nearly all cases the flank angle is 0°). If the hole is trumpet-shaped and the flank angle is positive, the insert is single-sided and is designed for the ISO S clamping system. If the hole is conical and is the same on both sides of the insert, then it is most likely a tangential insert (double-sided).

The **insert seating** – if it is formed by the same relief as the face surface, the insert is double-sided, if it is different, the insert is single-sided. It must be assessed with regard to the planned load or the type of cut. (the size and distance of the radius and the cutting edges).

Tool holder parts

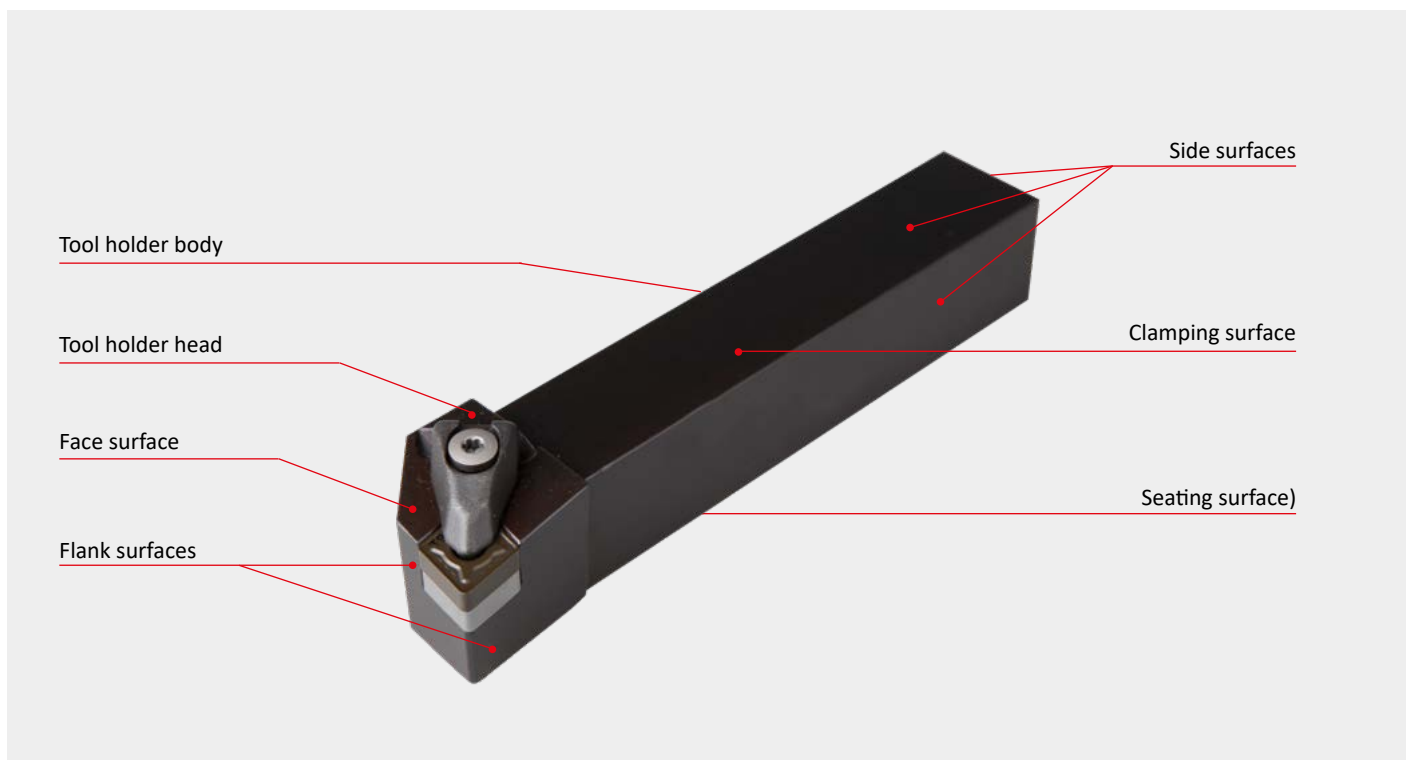

The turning tool consists of two basic parts:

1) the body consisting of:

- seating surface
- clamping surface
- side surfaces (which can further be provided with adjusting screws)

Note: For external turning, the tool holder body is usually a square cross section (square or rectangle). For internal turning, the cross section of the holder body is circular and, for larger cross sections, it is provided with adjusting surfaces. But the holder body can also be formed by a special type of shank, such as CAPTO (PSC) or HSK

2) the head with:

- face
- flank surfaces

The tool holder head also includes a clamping system into which the inserts are inserted

From the face side (for radial inserts) or from the flank surface side (for tangential inserts)

Note: the types of heads are:

- straight – allows turning in both directions
- side – distinguish between right and left design
- bent – distinguish between right and left design (allows better access when turning more complex surfaces)

Working and construction angles of turning tools

The position and orientation of the cutting edge in relation to the workpiece and its geometric shape determine the cutting angle characteristics.

The angles on the cutting edge are determined by a two coordinate system:

- a) design
- b) working

a) tool coordinate system (stationary), which is used to determine the cutting edge geometry during design, production and checking. All angles defined in this system are called tool cutting angles. All angles defined by ISO standards according to the insert shape belong in this group.

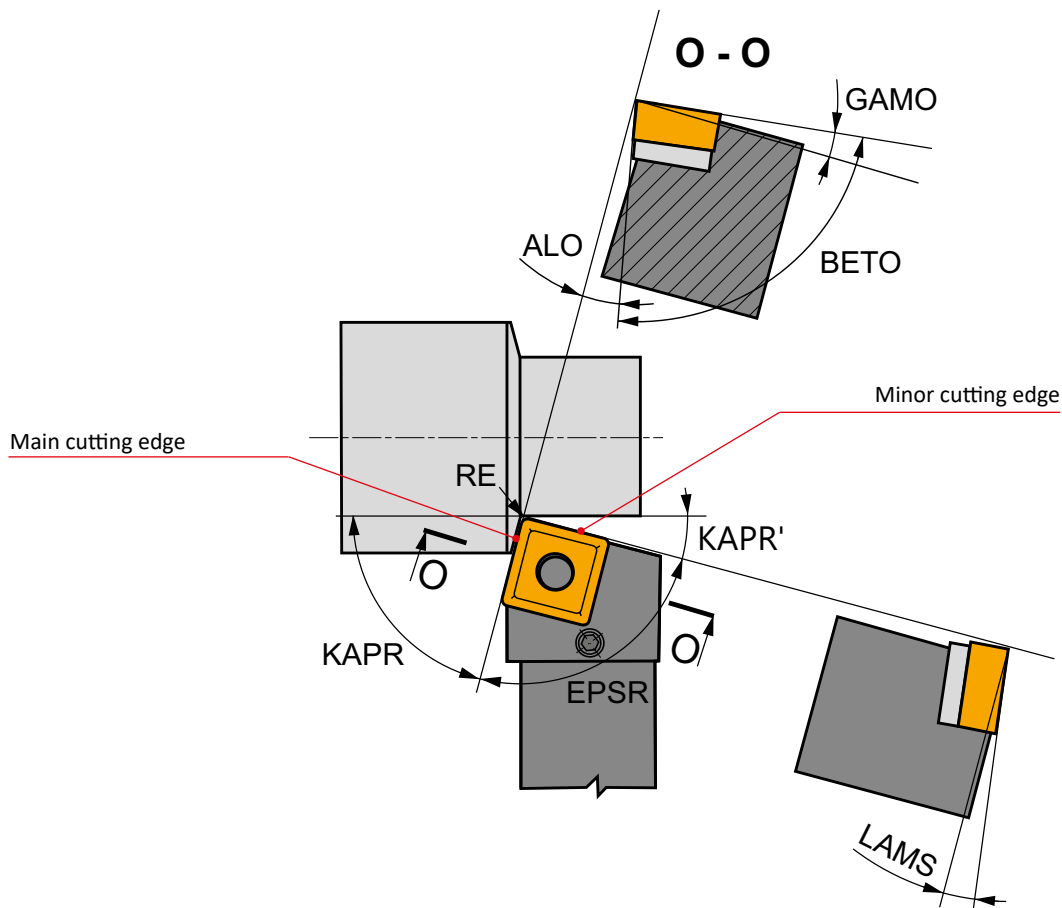

DEFINITION OF BASIC TERMS

b) working coordinate system, used to determine the cutting edge geometry during the machining process. These angles are called working angles and they depend on the position of the insert clamped into the tool holder. For example, the cutting insert SNUN has a tool clearance angle $AN = 0^\circ$ and a rake angle $GAMP = 0^\circ$, however the insert is clamped in the tool holder to give a working clearance angle $ALO = 6^\circ$ and a working rake angle $GAMO = -6^\circ$. The working angles affect the tool angles with pre-formed chip breakers. However the most important are the working angles for the cutting process.

The basic tool angles are indicated in the picture in the basic tool plane (interlaid by the bearing surface of the tool holder) and in the normal tool plane (interlaid across to cutting edge – cut O-O).

We are concerned with the following angles:

The rake angle $GAMO$ – substantially affects the cutting process. Its size determines the progress and the intensity of plastic deformation during chip forming; it also determines the value of the cutting forces and the thermal stress on the cutting edge. The range of rake angles is wide, from $GAMO = +25^\circ$ to -15° for cutting tools with indexable cutting inserts for milling and turning. A positive rake angle improves the chip forming conditions, reduces the cutting forces and reduces the cutting temperature level. A negative rake angle improves the strength of the cutting edge, however it increases plastic deformation during chip forming and thereby also the cutting forces and temperatures.

Clearance angle ALO affects the value of friction between the flank and the machined surface. Increasing the clearance angle ALO reduces this friction and thereby flank wear as well.

Wedge angle $BETO$ is the angle of the cutting insert's wedge. Increasing angle $BETO$ increases the strength of the cutting edge (resistance against shock), however it also increases the cutting resistance.

Inclination angle of main cutting edge $LAMS$ – determines the point of first contact between the cutting edge and the workpiece, which is important for interrupted cut. If $LAMS$ is positive, the point of contact is close to the nose of the cutting insert. The negative angle $LAMS$ moves the point of first contact far from the nose and thereby affects the resistance of the cutting edge against mechanical stress. Furthermore, $LAMS$ affects the direction of chip evacuation. If $LAMS$ is negative, the direction of chip evacuation is towards the machined surface. Whereas if $LAMS$ is positive, the direction of chip evacuation is away from the machined surface.

Setting angle of main cutting edge $KAPR$ has main influence on the values of cutting forces and the cross section shape of the chip. Reducing angle $KAPR$ makes the chip thinner at a given feed f and depth of cut a_p . Whereas if $KAPR = 90^\circ$ the chip thickness $h = f$ and the chip width $b = a_p$ becomes wider. Regarding the decreasing setting angle the function width of the T-land is increasing and the rake angle of insert is decreasing.

Setting angle of minor cutting edge $KAPR'$ together with corner radius RE define the final surface quality.

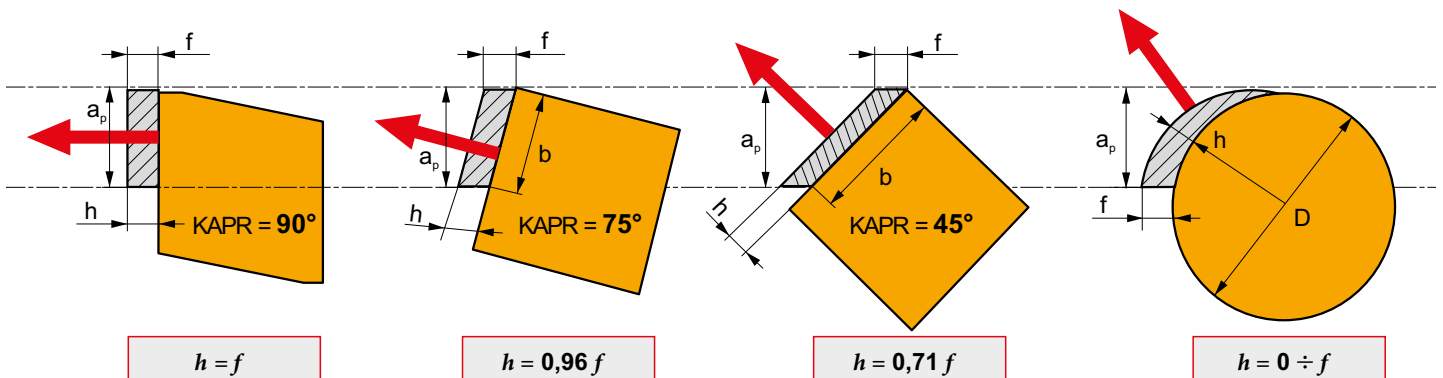



DEFINITION OF BASIC TERMS

Effect of working tool geometry

Parameter	Change	Abrasion of the flank	Crater wear formation	Tendency for plastic deformation	Resistance to adverse working conditions	Surface	Cutting forces	Tendency to vibrate	Medium cutting temperature	Chip formation
Main cutting edge angle	Less than or greater than 90°	Slightly reduced	Slightly reduced	Slightly reduced	Slightly improved	Effect not proven	Slightly increased	Increased	Lower	Chip is thinner and wider (b/h changes)
Minor cutting edge angle	Decreased	Slightly reduced	Effect not proven	Slightly increased	Very slightly improved	Improved (conditional)	Slightly increased	Increased	Very slightly higher	Insignificant effect
Corner angle	Increased	Effect not proven	Effect not proven	Reduced	Improved	Effect not proven	Effect not proven (-)	Slightly increased	Very slightly higher	Insignificant effect
Corner radius	Increased	Reduced (to certain level)	Reduced (to certain level)	Reduced	Improved	Improved (conditional)	Increased (to certain level)	Increased	Slightly higher	Softer formation (mostly – based on the chip breaker)
Flank angle	More positive	Reduced	Effect not proven	Very slightly Reduced	Slightly worse	Improved (conditional)	Slightly reduced	Slightly reduced	Slightly lower	Effect not proven
Face angle	More positive	Very slightly reduced	Reduced	Slightly reduced	Slightly worse	Effect not proven (+)	Slightly reduced	Reduced	Lower	Chip is less compressed, but is forced closer to the cutting edge
Cutting edge angle	Positive	Effect not proven	Slightly reduced	Slightly reduced	Slightly worse	Effect not proven (+)	Slightly reduced	Slightly reduced	Slightly lower	Deflects the chip from the workpiece
T-land width	Wider	Slightly increased	Slightly increased	Slightly increased	Slightly improved	Effect not proven (+)	Increased	Increased	Higher	Chip is more compressed, but presses to a larger surface
T-land angle (working)	Positive	Very slightly reduced	Slightly reduced	Slightly reduced	Slightly worse	Effect not proven (+)	Reduced	Reduced	Slightly lower	Chip is less compressed



DEFINITION OF BASIC TERMS

What affects cutting forces and how?

Conditions	Carbon steel (HB230)	Stainless steel (HB145)	Grey cast iron (HB130)
Cutting speed and cutting force $f = 0.2 \text{ mm/rev}$ $a_p = 2 \text{ mm}$ KAPR 90° RE 0.4			
Depth of cut and cutting force $V_c = 100 \text{ m/min}$ $a_p = 0.2 \text{ mm/rev}$ KAPR 90° RE 0.4			
Cutting feed and cutting force $V_c = 100 \text{ m/min}$ $a_p = 2 \text{ mm}$ KAPR 90° RE 0.4			
Corner radius and cutting force $V_c = 100 \text{ m/min}$ $f = 0.2 \text{ mm/rev}$ $a_p = 1.2 \text{ mm}$ KAPR 90°			
Main cutting edge angle $V_c = 100 \text{ m/min}$ $f = 0.2 \text{ mm/rev}$ $a_p = 2 \text{ mm}$ KAPR $45^\circ, 60^\circ, 75^\circ, 90^\circ$ (values on the x axis) RE 0.4			
Rake angle and cutting force $V_c = 100 \text{ m/min}$ $f = 0.2 \text{ mm/rev}$ $a_p = 2 \text{ mm}$ KAPR 90° RE 0.4			

Tool holder choice with regard to the clamping technique

The PRAMET TOOLS offer includes tool holders, adjustable holders, turret heads and adjustable holders for external longitudinal, facing, copy turning, and naturally also for internal turning. Tool holders are classified according to the inserts clamping system into six groups that are schematically illustrated in the following passage.

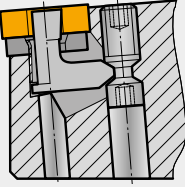
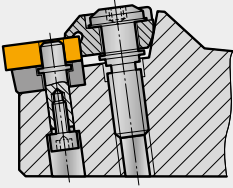
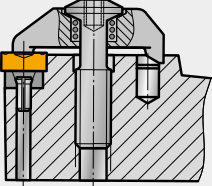
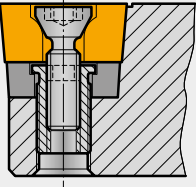
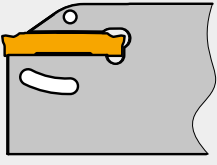
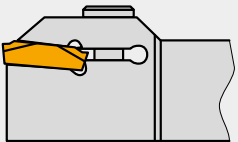
	<p>ISO P</p> <p>This system serves for the clamping of negative inserts with cylindrical hole, both with chip formers and/or without them. The insert clamping is achieved as a result of an angle lever that after tightening the screw presses the insert down to the holder bed. Tool holders with this clamping system of inserts ensure a reliable and exact clamping of an insert. They perform the best and also the most frequent use at external turning operations, namely both finishing and roughing ones. Alternatively this type of clamping can be also used for holders intended for internal turning of holes with larger diameters.</p>
	<p>ISO M</p> <p>This system is used for the clamping of cutting inserts of the same type as that of the system ISO P. In this case an insert is set onto a strong pin to which it is pressed by a clamp that is also fixing at the same time the top of insert. This clamping system is suitable mainly for holders with supposed enhanced dynamic load. These holders are used almost exclusively for the external turning.</p>
	<p>ISO C</p> <p>This system serves for the clamping of both negative and positive inserts without holes, namely with both chip formers (pre-pressed, ground and side-pressed ones) and without them. The insert is fixed in the bed of a tool holder by a screw-held clamp, under which there is still embedded a side-pressed chip former at some insert types. Holders with this clamping system are used for both the external and internal surface machining. At present the clamping system C loses its importance. Especially at tools for internal turning it is replaced by the system S with benefit.</p>
	<p>ISO S</p> <p>This clamping system is mainly used for small cross-section tools, designed for both external and internal turning (drilling). In this case a special screw, going through an insert cone hole, achieves the clamping. By tightening this screw an insert is fixed in the tool bed. This solution is especially convenient because there is no obstacle for chip flow.</p>
	<p>ISO X</p> <p>This marking identifies tools with so called special clamping system (i.e. it is different at individual tool manufacturers and suppliers). In our case we have identified under this marking tool holders that use the cutting resistance to clamp an insert into the self-locking bed. This clamping system is used for tools intended for parting and recessing.</p>
	<p>ISO G</p> <p>This clamping system is used at tools for recess turning and at tools for copy turning (system CTP). The insert is pushed into the holder bed by a clamp from the top. The contact surface in the holder, in the clamp and also in the insert is shaped in such a way that it hinders the insert displacing by a feeding component of cutting speed.</p>

CHOICE OF CUTTING TOOL

With reference to square cutting tool

External cutting tools (square cross section)

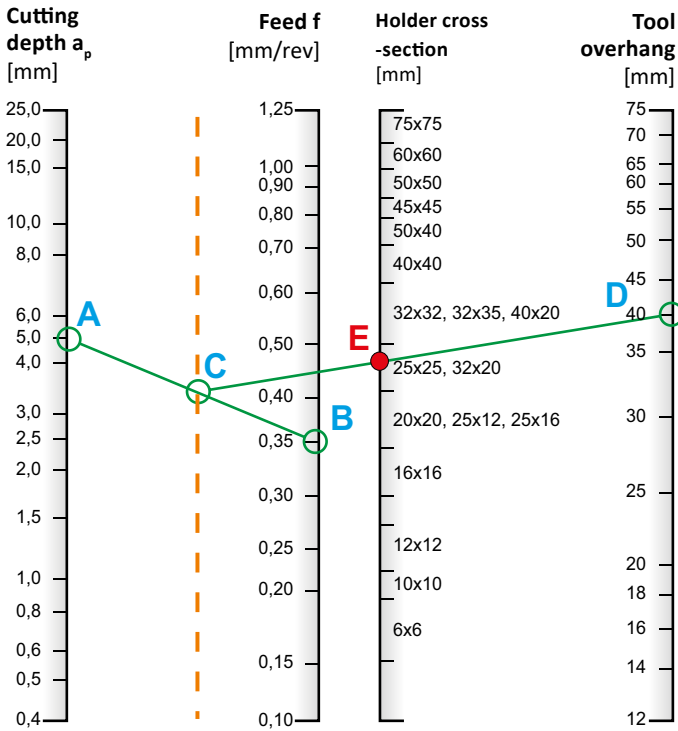

Unfortunately, we cannot offer you a similar diagram for choosing the diameter of the inner cutting tool as the situation in internal turning is complicated by the chip. Due to the larger overhang, a holder with the largest possible diameter should be chosen, but if the diameter of the holder is close to the diameter of the hole to be machined, problems can occur with the chip evacuation. It usually gets between the hole wall and the holder body damaging the surface being formed. In general, if you use tools with a steel body, the overhang should not exceed 4xD, and if you have tools with a carbide or heavy metal body, the maximum overhang should be 6xD. Remember that for both types of tools, the portion for clamping the tool should be at least 3xD.

Use the **maximum possible cross section** with regard to clamping options and process limitations.

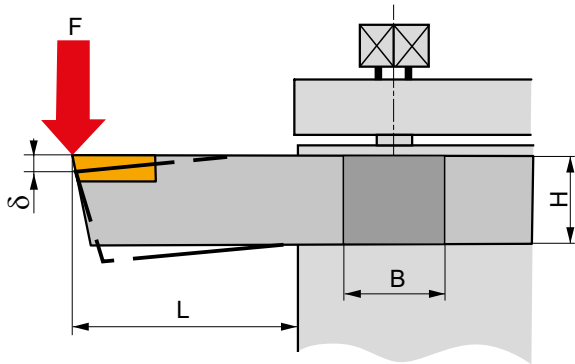

Bending stress

Tool holder deflection

$$\sigma = \frac{6 \cdot F \cdot L}{B \cdot H^2} \text{ [MPa]}$$

$$\delta = \frac{4 \cdot F \cdot L^3}{E \cdot B \cdot H^3} \text{ [mm]}$$

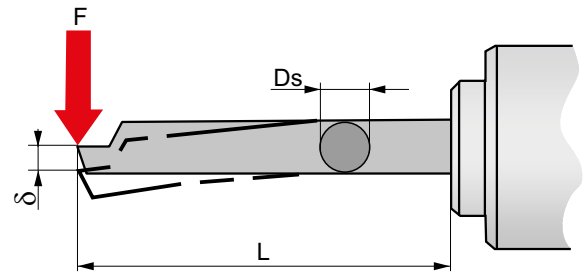

Bending stress

Tool holder deflection

$$\sigma = \frac{32 \cdot F \cdot L}{\pi \cdot D_s^3} \text{ [MPa]}$$

$$\delta = \frac{64 \cdot F \cdot L^3}{3 \cdot \pi \cdot E \cdot D_s^3} \text{ [mm]}$$

σ	Bending stress in the body [MPa]
F	Cutting force [N]
L	Tool overhang [mm]
B	Body width [mm]
H	Body height [mm]
D_s	Body diameter [mm]
E	Body material elastic modulus [MPa]









Material	MPa [N/mm ²]	[kgf/mm ²]
Steel	210.000	21.000
Sintered carbide	560.000 – 620.00	56.000 – 62.00

50% reduction in overhang reduces deflection by 88%.
1/3 increase in cross section reduces bending by 68%.

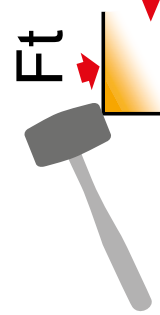

CHOICE OF INSERT

Choosing the shape and size of the insert

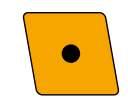
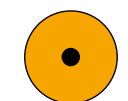
Priority of choice	Insert shape	Nose angle	Insert size		Maximum length of cutting edge Lmax		Roughing	Light roughing	Finishing	Profile turning	Face turning	Versatile applications	Tendency to vibrate	Hard material	Interrupted cut		
			ISO	ANSI	[mm]	["]											
<div style="display: flex; flex-direction: column; align-items: center;"> <div style="border: 1px solid red; padding: 5px; margin-bottom: 10px; transform: rotate(90deg); transform-origin: left top;"> Increasing the accessibility of the cutting edge for profiling and fewer vibrations. </div> <div style="display: flex; align-items: center; gap: 10px;"> <div style="text-align: center;">  <p style="color: red; font-weight: bold; font-size: 24px;">+</p> </div> <div style="text-align: center;">  <p style="color: red; font-weight: bold; font-size: 24px;">I</p> </div> <div style="text-align: center;"> <p style="color: red; font-weight: bold; font-size: 18px;">Pc [kW]</p> <p style="color: red; font-weight: bold; font-size: 24px;">↑</p> </div> </div> <div style="display: flex; align-items: center; gap: 10px; margin: 10px 0;"> <div style="text-align: center;"> <p style="color: red; font-weight: bold; font-size: 24px;">1</p> </div> <div style="text-align: center;"> <p style="color: red; font-weight: bold; font-size: 24px;">2</p> </div> </div> <div style="text-align: center;"> <p style="color: red; font-weight: bold; font-size: 18px;">Pc [kW]</p> <p style="color: red; font-weight: bold; font-size: 24px;">↑</p> </div> </div> <div style="border: 1px solid red; padding: 5px; margin-top: 10px; transform: rotate(90deg); transform-origin: left top;"> Increasing the strength of the cutting edge and suitability for interrupted cut. </div> <div style="margin-top: 10px;">  </div>		V	35°	11	2	0.25L	2.80	.110"									
				13			3.30	.130"		■	■	■	■				
				16	3		4.20	.165"									
		D	55°	07	2	0.25L	2.00	.078"									
				11	3		2.90	.114"		■	■	■	■	■	■		
				15	4		3.90	.153"									
		T	60°	11	2	0.33L	3.60	.141"									
				16	3		5.50	.216"	■	■	■	■	■	■	■		
				22	4		7.30	.287"	■	■	■	■	■	■	■		
				27	5		9.10	.358"									
		W	80°	06	3	0.50L	3.30	.129"									
				08	4		4.40	.173"	■	■	■	■	■	■	■	■	
		C	80°	06	2	0.66L	4.20	.165"									
				09	3		6.40	.251"									
				12	4		8.50	.334"	■	■	■	■	■	■	■		
				16	5		10.60	.417"									
				19	6		12.70	.500"									
		S	90°	09	3	0.66L	6.30	.248"									
				12	4		8.40	.330"									
				15	5		10.40	.409"	■	■	■	■	■	■			
19				6	12.60		.496"										
25				8	16.80		.661"										
	C	100°	12	4	0.66L	8.50	.334"										
			19	6		12.70	.500"	■									
			25	8		16.50	.649"										
	R		06		0.40D	2.40	.094"										
			08			3.20	.125"										
			10			4.00	.157"										
			12			4.80	.188"										
			15			6.00	.236"										
			16			6.40	.251"	■									
			19			7.60	.299"										
			20			8.00	.315"										
			25			10.00	.393"										
			32			12.80	.503"										



CHOICE OF INSERT

Choosing the optimum thickness of the insert

Based on practice, we recommend performing this only for interrupted cut and at a maximum load of inserts.

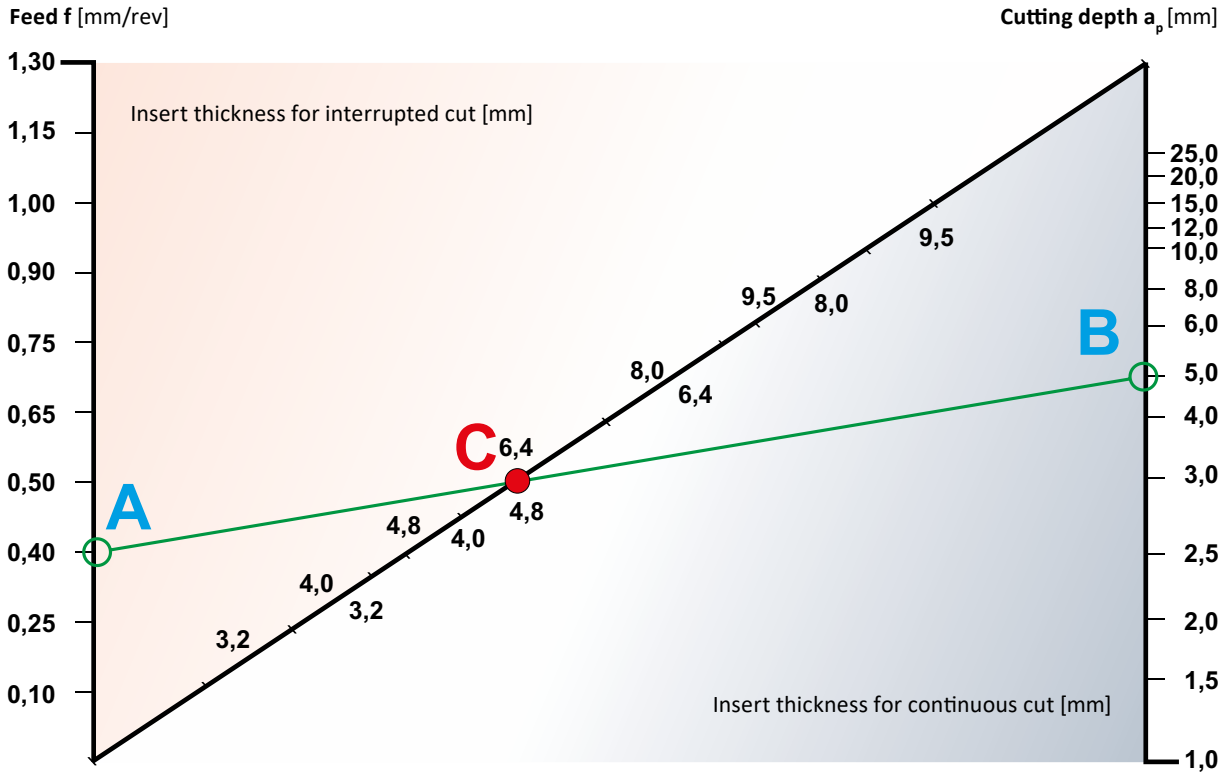

Choosing the nose radius of the insert

Based on practice, we recommend performing this only for interrupted cut and at a maximum load of inserts.

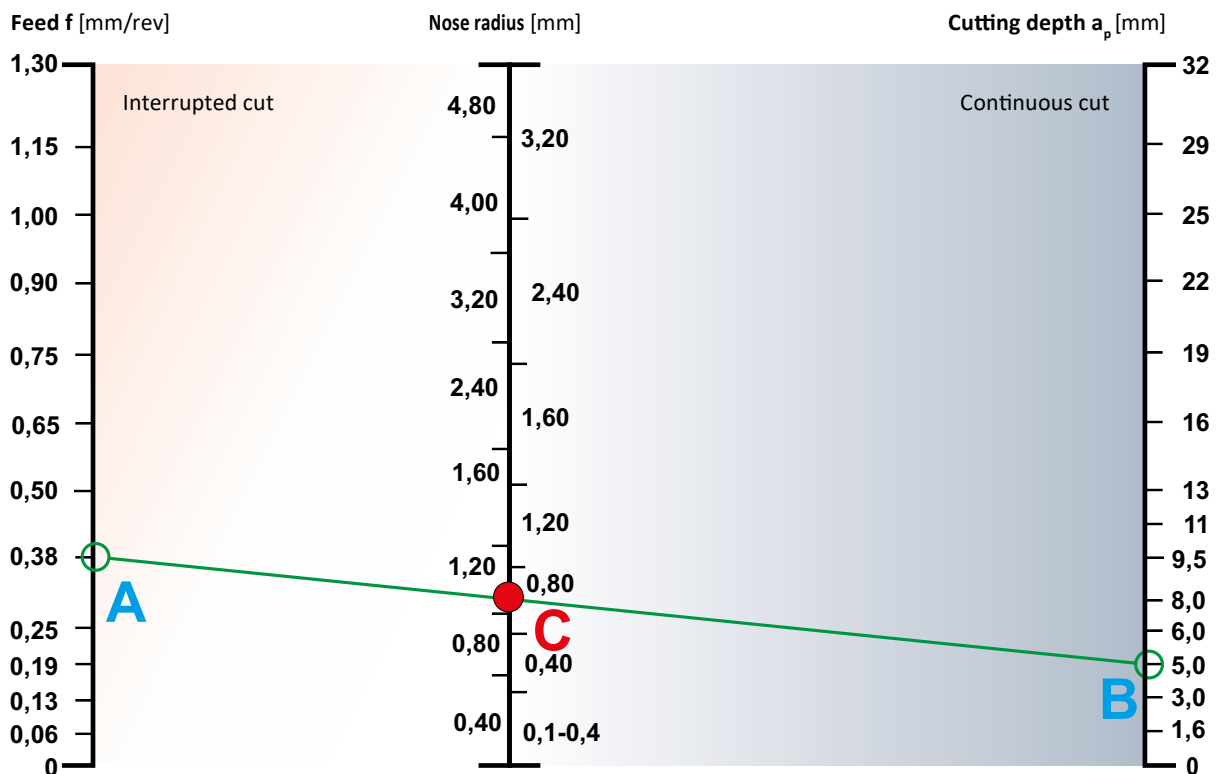



SURFACE QUALITY

The insert radius, together with the feed and the minor cutting edge angle, is one of the main criteria for determining the roughness of the machined surface. Obviously, the properties and type of material being machined, including the cutting environment, have a significant impact.

At the beginning of this section, we indicate the main roughness parameters most often specified in engineering practice.

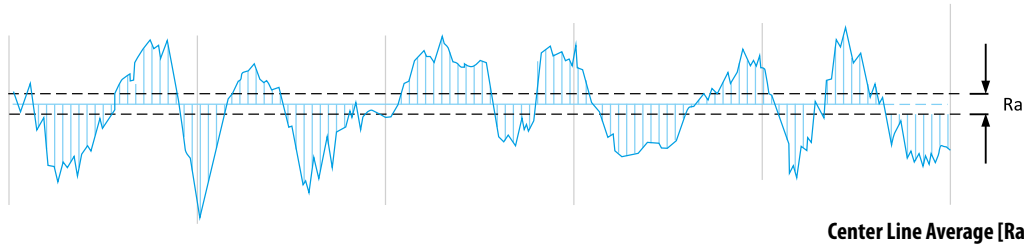

Ra – Average roughness

Ra is also known as Arithmetic Average (AA) or Center Line Average (CLA). It is the average roughness in the area between the roughness profile and its mean line. Graphically, Ra is the area between the roughness profile and its center-line divided by the evaluation length. The evaluation length is normally five sample lengths where each sample length is equal to one cut-off length. As shown in the graph.

Ra is by far the most commonly used Surface Finish parameter and a good starting point for quantifying parts even when there is no parameter callout (surface finish required). However, while common, Ra is not sufficient to completely characterize the roughness of a surface. Depending on the application, surfaces with the same roughness can perform quite differently. Lets look at the same surface roughness analysed in 3 other ways:

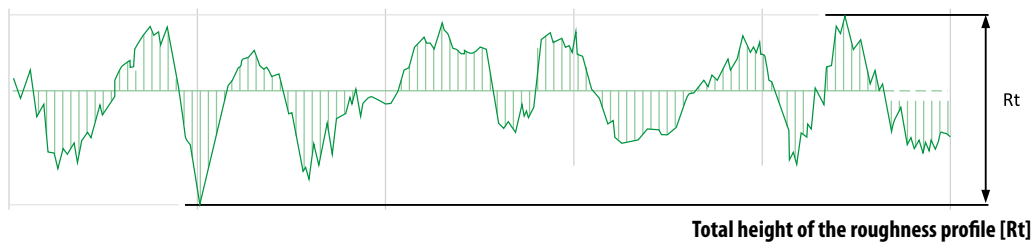

Rt – Total height of roughness profile

Difference between height of the highest peak and the depth of the deepest valley within the evaluation length as you can see in the bottom graph.

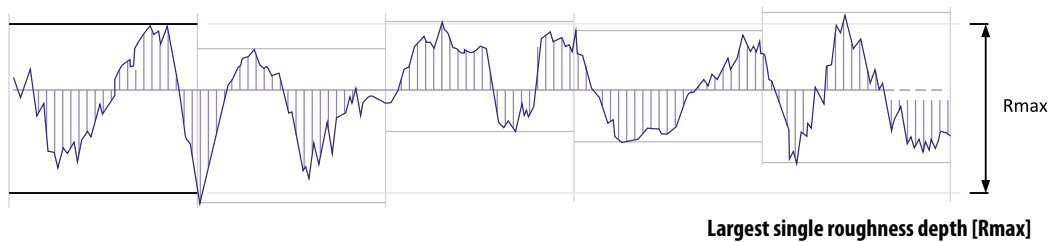

Rmax – Maximum distance from highest peak to lowest valley – of the total cut-off length

Or defining it differently but meaning the same Rmax is the largest single roughness depth measured within one of the sample lengths. Rmax is particularly sensitive to anomalies such as scratches and burrs that may not be obvious from measures such as Ra that rely on averages.

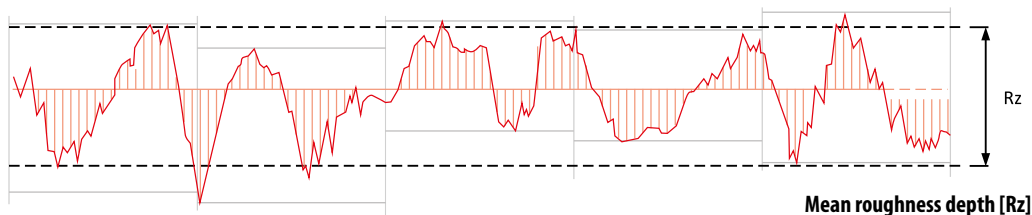

Rz – Mean roughness depth

Rz is often preferred to Ra in Europe and particularly Germany. Instead of measuring from center-line like Ra, Rz measures the average of the 5 largest peak to valley differences within five sampling lengths. While Ra is relatively insensitive to a few extremes, Rz is quite sensitive since it is the extremes it is designed to measure.



SURFACE QUALITY

Surface Roughness Grades: "N" Numbers

The N numbers are common used on technical drawings to described the surface finish roughness. In the past triangles where used but the are not so concrete to explain the correct surface finish.

Relationship with Triangle Symbol

Arithmetical Mean Roughness Ra [μm]	Max. Height Roughness Rz [μm]	Ten Points Mean Roughness RzJIS [μm]	Roughness Grade	Note: (Relationship with Triangle)
0.025	0.1	0.1	N1	VVV
0.05	0.2	0.2	N2	
0.1	0.4	0.4	N3	
0.2	0.8	0.8	N4	
0.4	1.6	1.6	N5	VV
0.8	3.2	3.2	N6	
1.6	6.3	6.3	N7	
3.2	12.5	12.5	N8	V
6.3	25	25	N9	
12.5	50	50	N10	V
25	100	100	N11	

Note: Finishing symbol (Triangle and wave~) was removed from JIS standard in the 1994 Revision.

In the market you can find some "RugoTest" where the surface finish can be checked visually if there is no electronical equipment available. Be aware that's only a guide and no measurement



Roughness values R_z and R_a specified in the following tables are valid for turning using inserts with larger minor cutting edge angles $KAPR'$, i.e. inserts of basic shapes **T...**, **S...**, **D...**, **K...**, **V...**. In turning using inserts with shapes **C ...**, **W ...**, and in particular using inserts with the WIPER geometry – i.e. tools with adjustment angles $KAPR = 90^\circ - 95^\circ$,

usually lower roughness values R_a are achieved as compared with the data from the table. This is caused by the low value of the minor cutting edge angle $KAPR'$. In this case rough areas are cut off and theoretical maximum rough areas are reduced to $R_{max3} < R_{max2} < R_{max1}$, as evident from the comparison in picture 17 that follows.

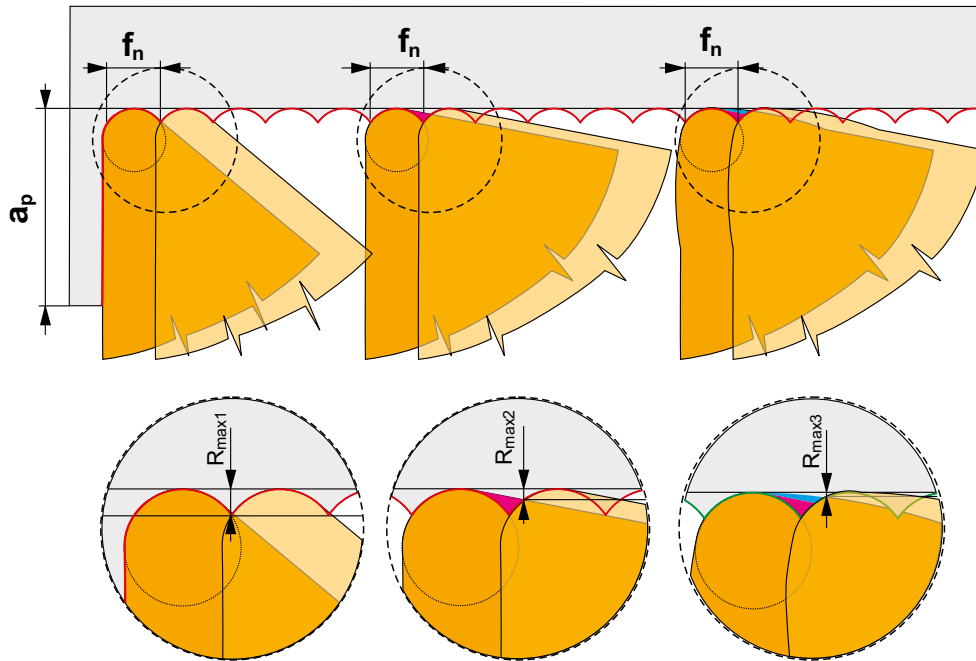



SURFACE QUALITY

Surface quality in turning R_{max}

$$R_{max} = \frac{f^2}{8 \cdot RE} \cdot 1000$$

f →	RE Radius																		
	0.1	0.2	0.4	0.5	0.8	1.0	1.2	1.5	1.6	2.0	2.4	2.5	3.0	3.2	3.5	4.0	5.0	6.0	8.0
	Surface R_{max} [μm]																		
0.05	3.13	1.56	0.78	0.63	0.39	0.31	0.26	0.21	0.20	0.16	0.13	0.13	0.10	0.10	0.09	0.08	0.06	0.05	0.04
0.07	6.1	3.06	1.53	1.23	0.77	0.61	0.51	0.41	0.38	0.31	0.26	0.25	0.20	0.19	0.18	0.15	0.12	0.10	0.08
0.08	8.0	4.0	2.00	1.60	1.00	0.80	0.67	0.53	0.50	0.40	0.33	0.32	0.27	0.25	0.23	0.20	0.16	0.13	0.10
0.10		6.3	3.13	2.50	1.56	1.25	1.04	0.83	0.78	0.63	0.52	0.50	0.42	0.39	0.36	0.31	0.25	0.21	0.16
0.12		9.0	4.50	3.60	2.25	1.80	1.50	1.20	1.13	0.90	0.75	0.72	0.60	0.56	0.51	0.45	0.36	0.30	0.23
0.15		14	7.0	5.6	3.52	2.81	2.34	1.88	1.76	1.41	1.17	1.13	0.94	0.88	0.80	0.70	0.56	0.47	0.35
0.16		16	8.0	6.4	4.00	3.20	2.67	2.13	2.00	1.60	1.33	1.28	1.07	1.00	0.91	0.80	0.64	0.53	0.40
0.18		20	10.1	8.1	5.1	4.05	3.38	2.70	2.53	2.03	1.69	1.62	1.35	1.27	1.16	1.01	0.81	0.68	0.51
0.20			13	10.0	6.3	5.0	4.17	3.33	3.13	2.50	2.08	2.00	1.67	1.56	1.43	1.25	1.00	0.83	0.63
0.22			15	12.1	7.6	6.1	5.0	4.03	3.78	3.03	2.52	2.42	2.02	1.89	1.73	1.51	1.21	1.01	0.76
0.25			20	16	9.8	7.8	6.5	5.2	4.88	3.91	3.26	3.13	2.60	2.44	2.23	1.95	1.56	1.30	0.98
0.27			23	18	11.4	9.1	7.6	6.1	5.7	4.56	3.80	3.65	3.04	2.85	2.60	2.28	1.82	1.52	1.14
0.30			28	23	14	11.3	9.4	7.5	7.0	5.6	4.69	4.50	3.75	3.52	3.21	2.81	2.25	1.88	1.41
0.32			32	26	16	13	10.7	8.5	8.0	6.4	5.3	5.1	4.27	4.00	3.66	3.20	2.56	2.13	1.60
0.35			38	31	19	15	13	10.2	9.6	7.7	6.4	6.1	5.1	4.79	4.38	3.83	3.06	2.55	1.91
0.37			43	34	21	17	14	11.4	10.7	8.6	7.1	6.8	5.7	5.3	4.89	4.28	3.42	2.85	2.14
0.40				40	25	20	17	13	13	10.0	8.3	8.0	6.7	6.3	5.7	5.0	4.00	3.33	2.50
0.45				51	32	25	21	17	16	13	10.5	10.1	8.4	7.9	7.2	6.3	5.1	4.22	3.16
0.50					39	31	26	21	20	16	13	13	10.4	9.8	8.9	7.8	6.3	5.2	3.91
0.55					47	38	32	25	24	19	16	15	13	11.8	10.8	9.5	7.6	6.3	4.73
0.60					56	45	38	30	28	23	19	18	15	14	13	11.3	9.0	7.5	5.6
0.65					66	53	44	35	33	26	22	21	18	17	15	13	10.6	8.8	6.6
0.70					77	61	51	41	38	31	26	25	20	19	18	15	12.3	10.2	7.7
0.75					88	70	59	47	44	35	29	28	23	22	20	18	14	11.7	8.8
0.80						80	67	53	50	40	33	32	27	25	23	20	16	13	10.0
0.85						90	75	60	56	45	38	36	30	28	26	23	18	15	11.3
0.90						101	84	68	63	51	42	41	34	32	29	25	20	17	13
0.95						113	94	75	71	56	47	45	38	35	32	28	23	19	14
1.00							104	83	78	63	52	50	42	39	36	31	25	21	16
1.20								120	113	90	75	72	60	56	51	45	36	30	23
1.30								141	132	106	88	85	70	66	60	53	42	35	26
1.40								163	153	123	102	98	82	77	70	61	49	41	31
1.50									176	141	117	113	94	88	80	70	56	47	35
1.60										160	133	128	107	100	91	80	64	53	40
1.70										181	151	145	120	113	103	90	72	60	45
1.80										203	169	162	135	127	116	101	81	68	51
1.90										226	188	181	150	141	129	113	90	75	56
2.00											208	200	167	156	143	125	100	83	63
2.20											252	242	202	189	173	151	121	101	76
2.50													260	244	223	195	156	130	98

Danger of hard chipbreaking



SURFACE QUALITY

Surface quality in turning R_a

$$R_a = 43,9 \frac{f^{1,88}}{RE^{0,97}}$$

f ⇒	RE Radius																		
	0.1	0.2	0.4	0.5	0.8	1.0	1.2	1.5	1.6	2.0	2.4	2.5	3.0	3.2	3.5	4.0	5.0	6.0	8.0
	Surface R_a [μm]																		
0.05	1.47	0.75	0.38	0.31	0.20	0.16	0.13	0.11	0.10	0.08	0.07	0.06	0.05	0.05	0.05	0.04	0.03	0.03	0.02
0.07	2.76	1.41	0.72	0.58	0.37	0.30	0.25	0.20	0.19	0.15	0.13	0.12	0.10	0.10	0.09	0.08	0.06	0.05	0.04
0.08	3.55	1.81	0.93	0.75	0.47	0.38	0.32	0.26	0.24	0.19	0.16	0.16	0.13	0.12	0.11	0.10	0.08	0.07	0.05
0.10		2.76	1.41	1.13	0.72	0.58	0.48	0.39	0.37	0.30	0.25	0.24	0.20	0.19	0.17	0.15	0.12	0.10	0.08
0.12		3.88	1.98	1.60	1.01	0.82	0.68	0.55	0.52	0.42	0.35	0.34	0.28	0.26	0.24	0.21	0.17	0.14	0.11
0.15		5.9	3.02	2.43	1.54	1.24	1.04	0.84	0.79	0.63	0.53	0.51	0.43	0.40	0.37	0.32	0.26	0.22	0.17
0.16		6.7	3.41	2.74	1.74	1.40	1.17	0.94	0.89	0.71	0.60	0.58	0.48	0.45	0.42	0.36	0.29	0.25	0.19
0.18		8.3	4.25	3.42	2.17	1.75	1.46	1.18	1.11	0.89	0.75	0.72	0.60	0.57	0.52	0.46	0.37	0.31	0.23
0.20			5.2	4.17	2.64	2.13	1.78	1.44	1.35	1.09	0.91	0.88	0.73	0.69	0.63	0.56	0.45	0.37	0.28
0.22			6.2	4.99	3.16	2.55	2.14	1.72	1.62	1.30	1.09	1.05	0.88	0.82	0.76	0.66	0.53	0.45	0.34
0.25			7.9	6.3	4.02	3.24	2.72	2.19	2.05	1.65	1.39	1.33	1.12	1.05	0.96	0.84	0.68	0.57	0.43
0.27			9.1	7.3	4.65	3.74	3.14	2.53	2.37	1.91	1.60	1.54	1.29	1.21	1.11	0.98	0.79	0.66	0.50
0.30			11.1	8.9	5.7	4.57	3.83	3.08	2.89	2.33	1.95	1.88	1.57	1.48	1.35	1.19	0.96	0.80	0.61
0.32			13	10.1	6.4	5.2	4.32	3.48	3.27	2.63	2.20	2.12	1.78	1.67	1.53	1.34	1.08	0.91	0.69
0.35			15	11.9	7.6	6.1	5.1	4.12	3.87	3.11	2.61	2.51	2.10	1.97	1.81	1.59	1.28	1.07	0.81
0.37			16	13	8.4	6.8	5.7	4.57	4.29	3.46	2.90	2.78	2.33	2.19	2.01	1.76	1.42	1.19	0.90
0.40				15	9.7	7.8	6.6	5.3	4.97	4.00	3.35	3.22	2.70	2.54	2.33	2.04	1.65	1.38	1.04
0.45				19	12.1	9.8	8.2	6.6	6.2	4.99	4.19	4.02	3.37	3.17	2.90	2.55	2.05	1.72	1.30
0.50					15	11.9	10.0	8.0	7.6	6.1	5.1	4.90	4.11	3.86	3.54	3.11	2.50	2.10	1.59
0.55					18	14	12.0	9.6	9.0	7.3	6.1	5.9	4.92	4.62	4.23	3.72	2.99	2.51	1.90
0.60					21	17	14	11.3	10.7	8.6	7.2	6.9	5.8	5.4	4.98	4.38	3.53	2.96	2.24
0.65					24	20	16	13	12.4	10.0	8.4	8.0	6.7	6.3	5.8	5.1	4.10	3.44	2.60
0.70					28	22	19	15	14	11.5	9.6	9.2	7.7	7.3	6.7	5.9	4.71	3.95	2.99
0.75					32	26	21	17	16	13	10.9	10.5	8.8	8.3	7.6	6.7	5.4	4.50	3.40
0.80						29	24	19	18	15	12.3	11.9	9.9	9.3	8.6	7.5	6.1	5.1	3.84
0.85						32	27	22	21	17	14	13	11.1	10.5	9.6	8.4	6.8	5.7	4.30
0.90						36	30	24	23	18	15	15	12.4	11.7	10.7	9.4	7.6	6.3	4.79
0.95						40	33	27	25	20	17	16	14	13	11.8	10.4	8.4	7.0	5.3
1.00							37	30	28	22	19	18	15	14	13	11.4	9.2	7.7	5.8
1.20								42	39	32	26	25	21	20	18	16	13	10.9	8.2
1.30								49	46	37	31	30	25	23	21	19	15	13	9.6
1.40								56	52	42	35	34	28	27	25	22	17	15	11.0
1.50									60	48	40	39	32	30	28	25	20	17	13
1.60										54	45	44	37	34	32	28	22	19	14
1.70										61	51	49	41	39	35	31	25	21	16
1.80										68	57	54	46	43	39	35	28	23	18
1.90										75	63	60	51	47	44	38	31	26	20
2.00											69	66	56	52	48	42	34	28	21
2.20												83	79	67	63	57	41	34	26
2.50													85	80	73	64	52	43	33

Danger of hard chipbreaking



Hardness of chip formation – great attention must be paid to proper chip formation (the chip must be easily transportable from the cutting point and, at the same time, it should have the smallest possible plastic deformation, i.e. the lowest possible cutting forces).

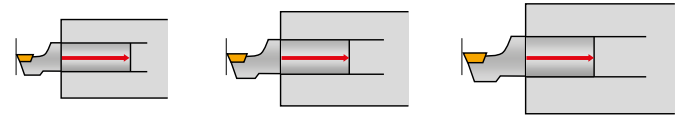

Tool body cross section (clamping rigidity) – the rigidity of the clamping itself is important. Therefore, we recommend using cutting tools with the largest possible body cross section that can be clamped. We also prefer to use monoblocks (PSC).

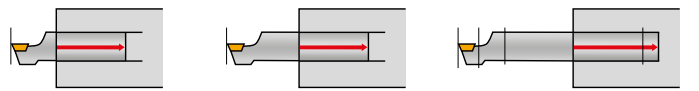

Overhang (clamping rigidity) – the tool overhang, or the rigidity of the clamping itself, is of great importance as well. Therefore, we recommend minimising the overhang.

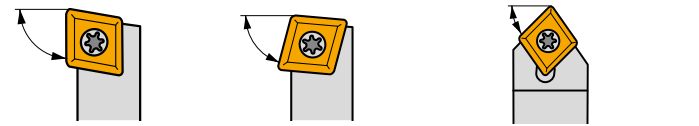

Main cutting edge angle – ideally, the tool adjustment angle should be close to 90°, i.e. the forces should be directed as much as possible to the axis of the machine spindle.

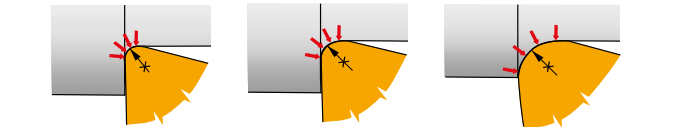

Insert radius – if there is a risk of vibration, we recommend selecting an insert with the smallest possible tip radius.

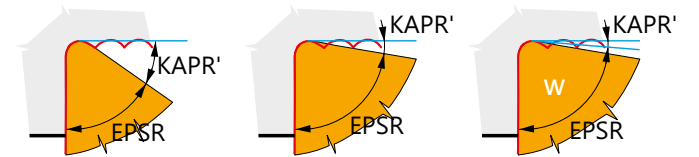

Corner angle and minor cutting edge angle – in this case it is recommended to choose an insert with the smallest possible tip angle, i.e. V (35°), D or K (55°), or T (60°). C or W shapes, or inserts with WIPER geometry, are not recommended. Please note this does not always apply (if torsional vibrations also occur, the application of these inserts can be beneficial).

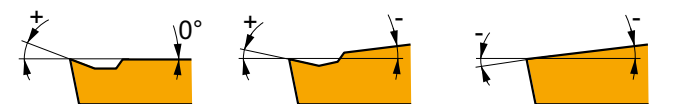

Geometry – when turning thin-walled and slim parts, it is recommended to opt for positive inserts with positive geometry, then negative inserts with positive geometry, and only if there is no other choice, then negative inserts with neutral to negative geometry should be chosen.

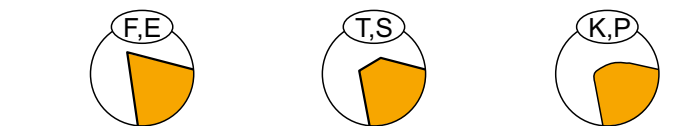

Micro-geometry (cutting edge design) – to reduce the risk of vibration, it is necessary to select inserts with the sharpest possible cutting edge geometry. If you use inserts with t-landing, these should be as narrow and positive as possible. It is very important that the tool generates as little cutting resistance as possible.

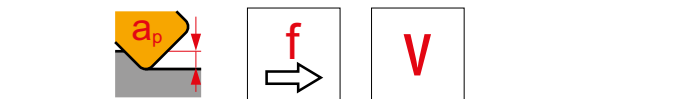

Cutting conditions:

- 1) When choosing the depth of cut, always make sure that the depth of cut is greater than the radius of the insert.
- 2) When choosing the feed, take into account that the specific cutting resistance increases with decreasing chip thickness, i.e. do not use extremely low feeds (below 0.1 mm).
- 3) If there are vibrations, cutting speed change (+/-) can also help – this is related to the inherent frequency of the machine.

NOTE: It is often advantageous to reduce the depth of cut (not below the radius) and increase the feed.



Do not use worn inserts – abrasion of the flank causes an increase in cutting forces, and thus the risk of vibration. If tool clamping allows it, move the cutting edge above the axis (in external turning) by approx. 2% of the diameter.



CHOICE OF CUTTING CONDITIONS

Choosing the chip breaker

The shape of the chip depends on several factors – the properties of the machined component, material strength, toughness and micro-structure, properties of the insert grade, especially the frictional properties (on the rake face), geometry of cutting edge, cutting conditions and the type of chip breaker, also static and dynamic properties of the machine.

Virtually all of these factors in the cutting process work to combine

and determine the shape of the chip (shearing action, flow of the chip, or curled chip – which can gather and clog the machining area). Each chip breaker works in a defined range of feed and depth of cut.

The minimum feed at which the chip breaker functions depends on the width of Top Land „ x ” and it’s angle. The maximum feed depends on the distance from the cutting edge to the end of the chip breaker y and the depth of the chip breaker z .

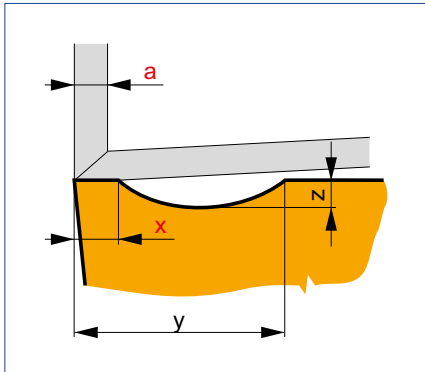

If the thickness of layer „ a ” cut away (at setting angle $KAPR = 90^\circ$, equal to the feed) is significantly smaller than the T-land „ x ”, the chip is only in contact with the chamfer. It cannot enter the chip breaker and therefore it cannot be broken (see picture).

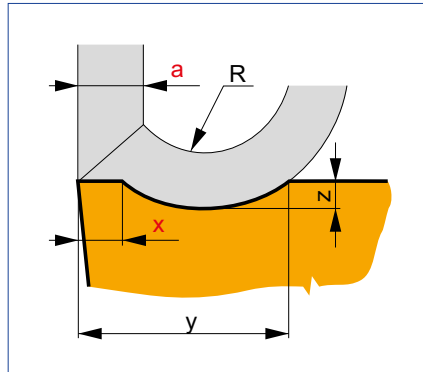

If the feed „ f ” is greater (thickness greater than the depth of „ a ” and $x < a$ (f)), the chip enters the chip breaker and is curved at specific values of radius R (see picture).

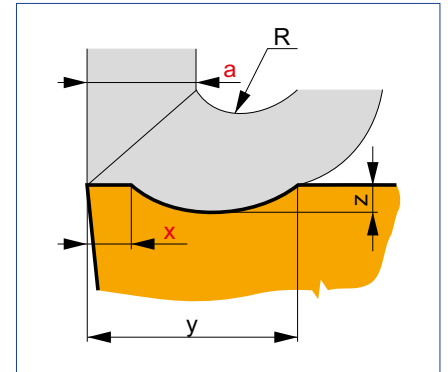

If $x \ll a$ (see picture) the chip is excessively deformed (chip is crushed). If the chip misses the chip breaker it will not be broken.

All chip breakers work in a defined range of cutting conditions. This is why the chip breaking area is shown as a continuous range in order to define the most commonly used depth of cut and feed combinations (see following picture). The chip breaker application ranges also overlap.

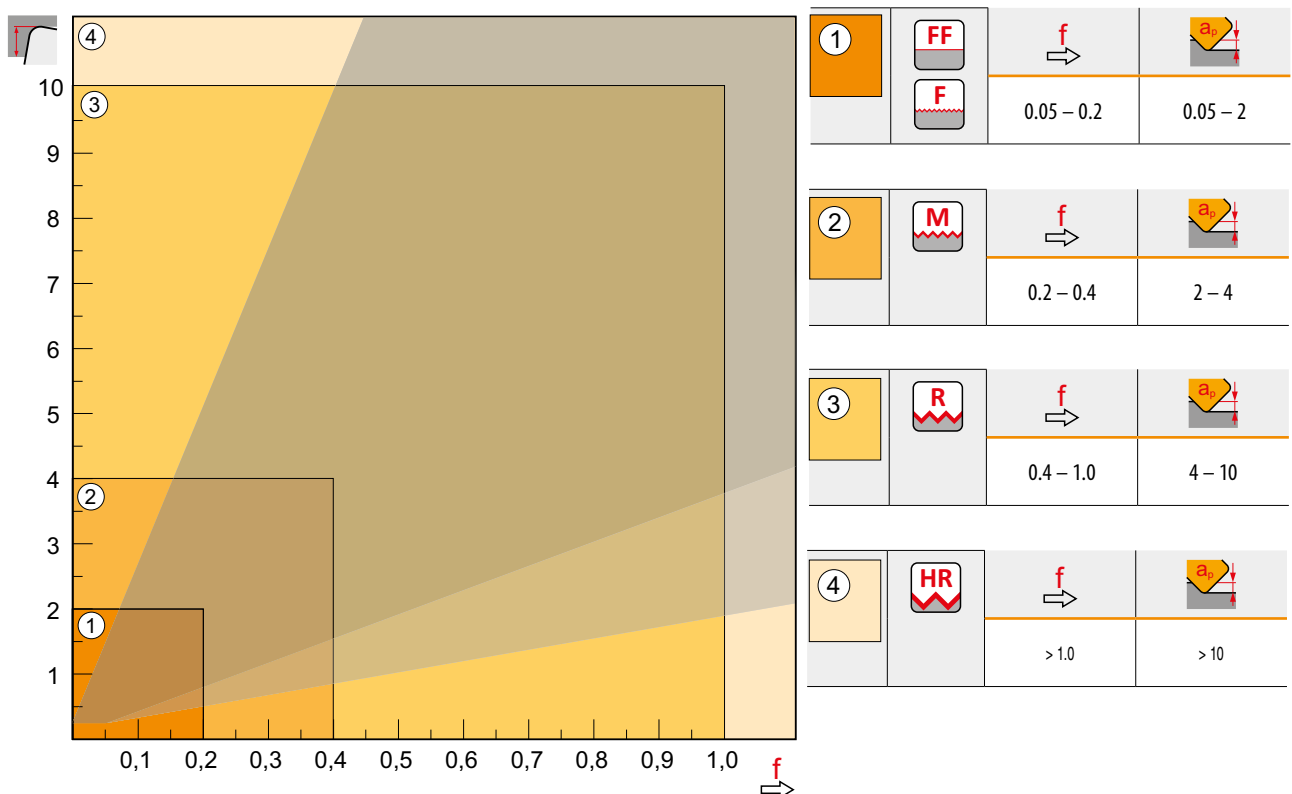



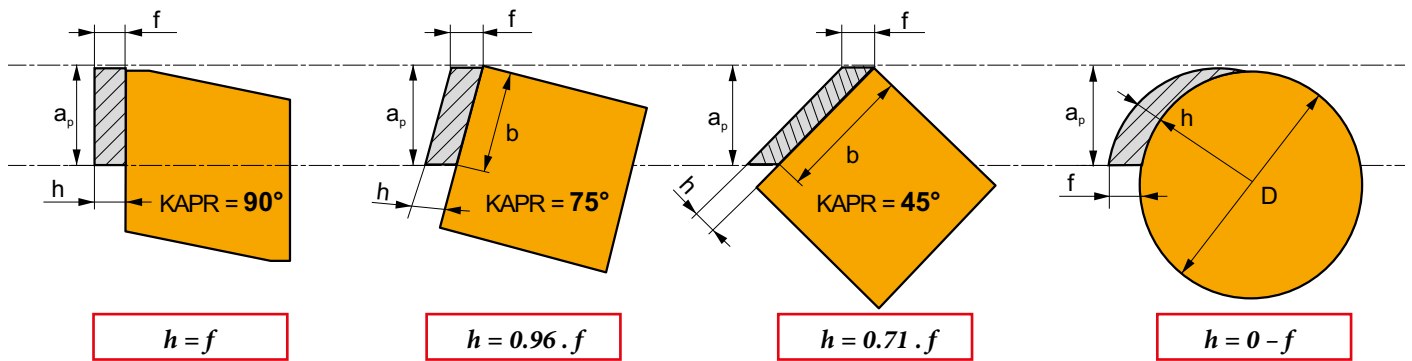

CHOICE OF CUTTING TOOL



Optimal combination of depth of cut and feed varies for each material. The following table shows ranges of the optimal ratios b (chip width) to h (chip thickness). For adjustment angles close to 90° , this is essentially the ratio of depth of cut to feed. See picture.

Material		min b/h	max b/h	
P		5	15	
M	8	12		
K	3	30		
N	9	11		
S	Square chip $b=h$	8	12	Ribbon chip $b/h > 30$
H	5	20		

As follows from the table, when choosing cutting conditions, you should avoid the so-called square chip, i.e. values where the width is close to the thickness of the chip and, on the other hand, the ribbon chip, i.e. high depths of cut in combination with low feed. The above table shows that the most problematic chip formation re-

lates to non-ferrous metal alloys, in particular aluminium alloys with or without a low silicon content. This is followed by superalloys and stainless steels (especially austenitic and duplex steels). Next are steels, and the best situation is with hardened materials and cast irons.



CHOICE OF CUTTING TOOL

Also, keep in mind that the chip formation diagram moves slightly towards higher depths of cut (up), with increasing cutting edge length (insert size), and towards higher feeds (to the right), with increasing radius.

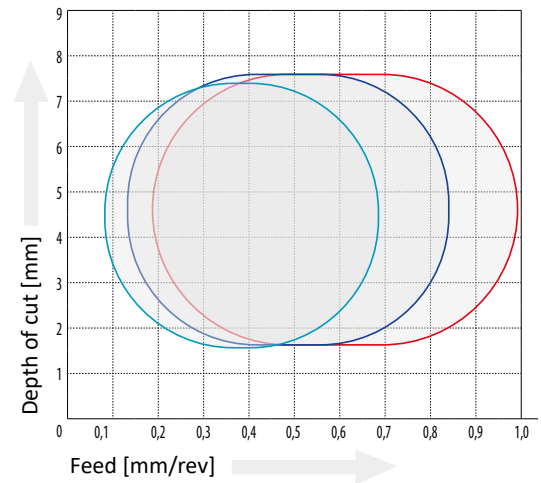
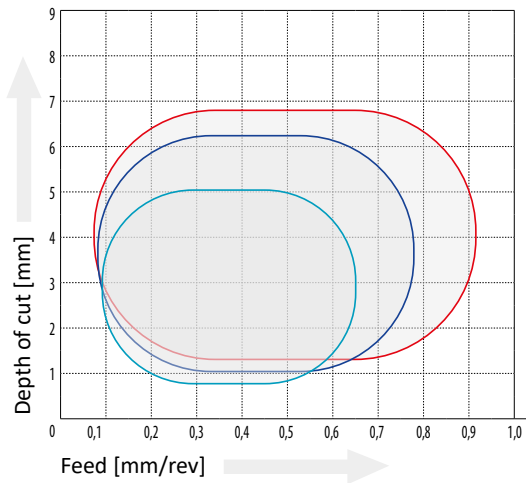

- An insert with the diameter of an inscribed circle IC = 19.050 [mm]
- An insert with the diameter of an inscribed circle IC = 15.875 [mm]
- An insert with the diameter of an inscribed circle IC = 12.700 [mm]

- An insert with the tip radius RE = 1.6 [mm]
- An insert with the tip radius RE = 1.2 [mm]
- An insert with the tip radius RE = 0.8 [mm]

Aside from shape of the chip, the direction of its evacuation is also very important. The following figure shows the basic directions of chip evacuation:

- 1 – from the workpiece in the feed direction,
- 2 – to the workpiece in the feed direction
- 3 – to the workpiece against the feed,
- 4 – from the workpiece against the feed,

- 5 – broken against the cutting area surface,
- 6 – broken against the side of the tool,
- 7 – broken against the surface being machined,
- 8 – broken against the machined surface,

Obviously, directions that can cause damage or scratching of the machined surface are undesirable.

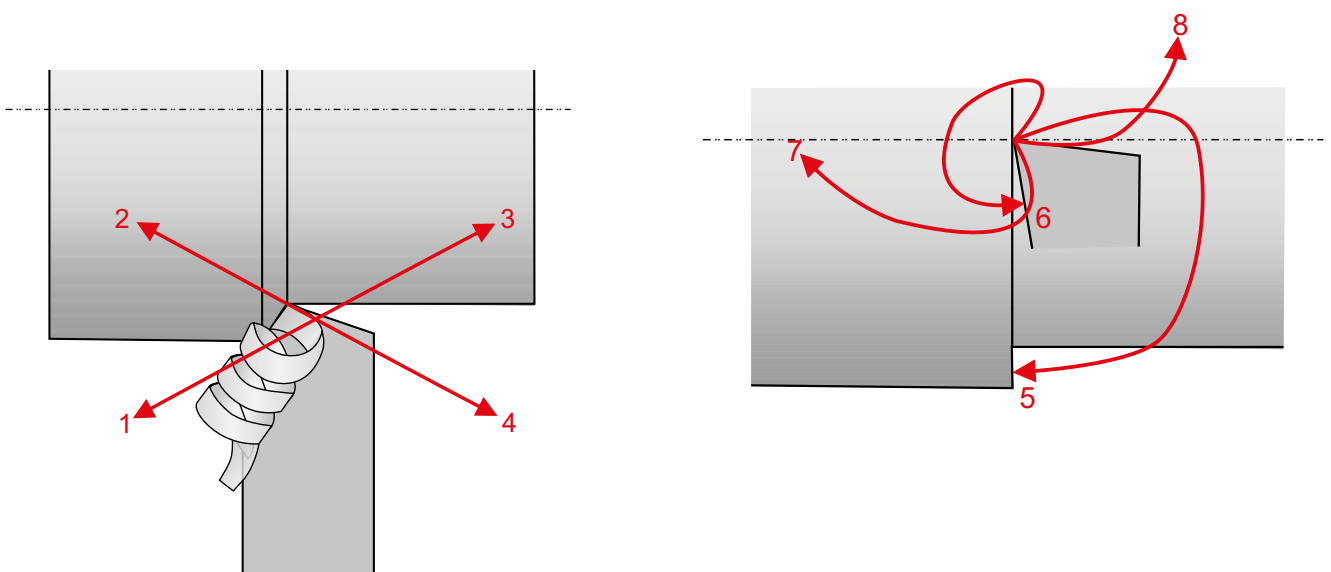

The following section clearly specifies all the geometries we offer you in structured groups. These tables should give you an optimal and more accurate choice.



OVERVIEW OF TURNING INSERT GEOMETRIES

POSITIVE INSERTS Clamping designation ISO S		NEGATIVE INSERTS Clamping designation ISO P, M, D		GEOMETRY OF CUTTING GROOVING INSERTS Clamping designation iso X and G	
371 (RCMT)	565	000 (LNUX)	575	GM (GL.D)	586
372 (RCMT)	565	002 (LNUX)	575	MM (GL.D)	586
...W	565	003 (LNUX)	575	PM (GL. D)	586
AL	565	08 (RNMG)	575	PR (GL. D)	586
DR4 (SCMT)	566	81 (RNMG)	576	13 CM (LCMF)	587
FF	566	432 (LNMX)	576	13 F (LCM.)	587
FF2	566	923	576	13 MP (LCM.)	587
FM	566	...A	576	16 CM (LCM.)	587
FM (RCMT)	567	DR	577	16 F (LCM.)	588
FM2	567	FF	577	16 M (LCM.)	588
NF1	567	FM	577	16 MP (LCM.)	588
NF2	567	HR	577	20 F1 (LCMF)	588
OR (SCMT)	568	HR2	578	20 M2 (LCMF)	589
RF	568	KR	578	30 F (LCM.)	589
RM	568	M	578	F1 (LFMX)	589
RM3	568	NF	578	F2 (LFMX)	589
SF2	569	NM	579	M2 (LFMX)	590
SF3	569	NMR	579	LFUX	590
SI	569	NR	579	TN. EXT	591
SR (SCMT)	569	NRM	579	TN. INT	591
UR (RCMT)	570	NR2	580	X61	591
UR	570	OR	580	X61 R	591
W-FM	570	OR1	580		
W-UR	570	R	580		
46	571	RM	581		
47	571	SF	581		
48	571	SI	581		
61	571	SM	581		
.PUN	572	SR	582		
		W-MR	582		
		W-F	582		
		W-M	582		
		W-NM	583		
POSITIVE INSERTS Clamping designation ISO P, M, D		NEGATIVE INSERTS Clamping designation ISO C			
31 (RCMX)	573	22	584		
321 (RCMX)	573	32	584		
331 (RCMX)	573	72	584		
361 (RCMX)	573	73	584		
RF1 (RCMX)	574	74	585		
RM1 (RCMX)	574				
RM2 (RCM.)	574				
RR2 (RCM.)	574				

GEOMETRY OF CUTTING POSITIVE INSERTS – CLAMPING DESIGNATION ISO S

371 (RCMT)

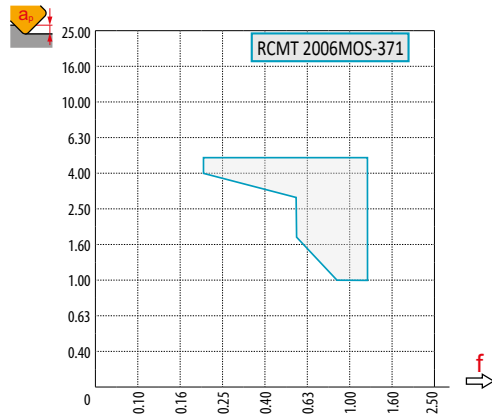
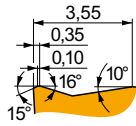

P	M	K	N	S	H
■		■			
f	0.20 – 1.20				
a_p	1.0 – 5.0				
?	RCMT				

372 (RCMT)

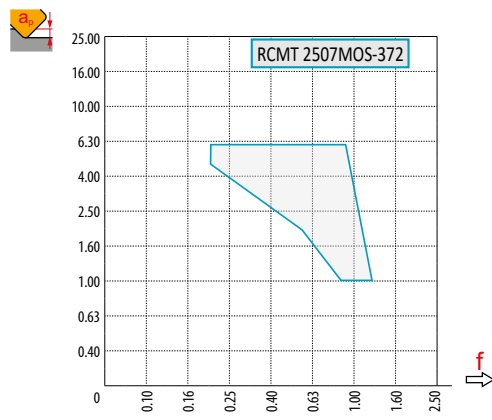
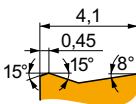

P	M	K	N	S	H
■		■			
f	0.20 – 1.20				
a_p	1.0 – 6.0				
?	RCMT				

...W

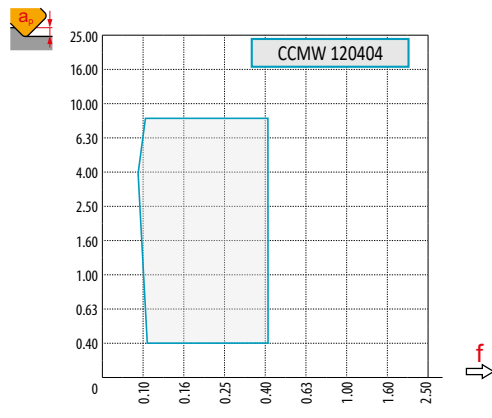
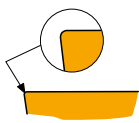
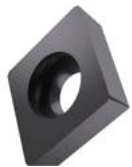

P	M	K	N	S	H
		■			■
f	0.05 – 0.60				
a_p	0.4 – 8.4				
?	CCMW, DCMW, SCMW, RCMW, TCMW, VCMW				

AL

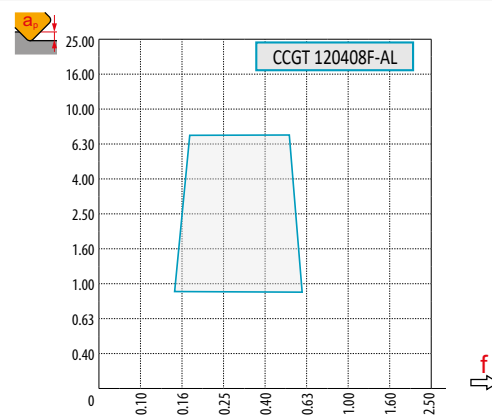

P	M	K	N	S	H
			■	■	
f	0.05 – 0.60				
a_p	0.2 – 7.0				
?	CCGT, DCGT, SCGT, RCGT, TCGT, VCGT, WCGT				



GEOMETRY OF CUTTING POSITIVE INSERTS – CLAMPING DESIGNATION ISO S

DR4 (SCMT)

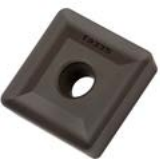
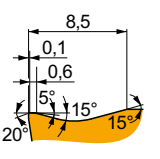
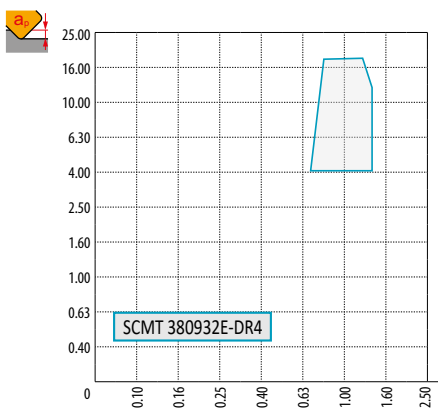
SCMT 380932E-DR4

P	M	K	N	S	H
■	▣	■			
f	0.70 – 1.40				
a_p	4.0 – 18.0				

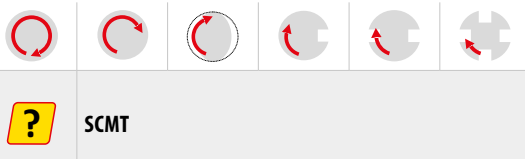

SCMT

FF

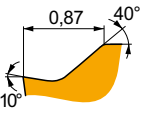
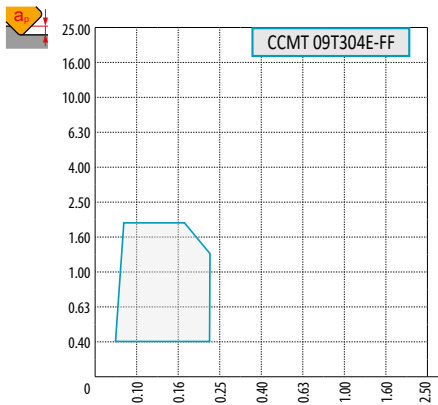
CCMT 09T304E-FF

P	M	K	N	S	H
■	▣				
f	0.05 – 0.23				
a_p	0.2 – 2.0				

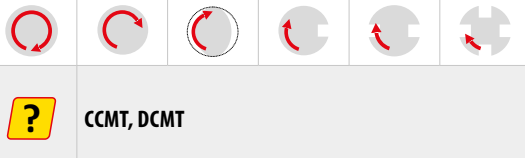

CCMT, DCMT

FF2

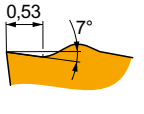
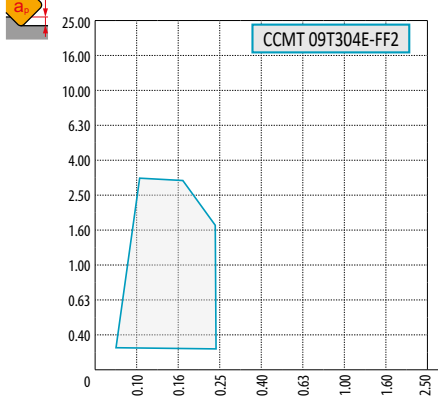

CCMT 09T304E-FF2

P	M	K	N	S	H
■		■			
f	0.02 – 0.28				
a_p	0.20 – 3.0				

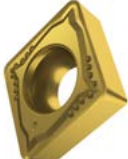

CCMT, CCGT, DCGT, DCMT, SCMT, TCMT, VBMT, VCGT, VCGX, WCGT

FM

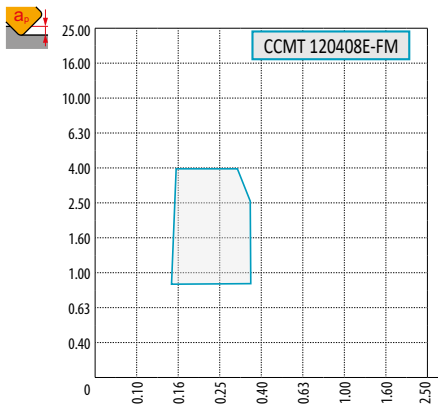
CCMT 120408E-FM

P	M	K	N	S	H
■	■	▣	▣		
f	0.05 – 0.45				
a_p	0.2 – 4.0				



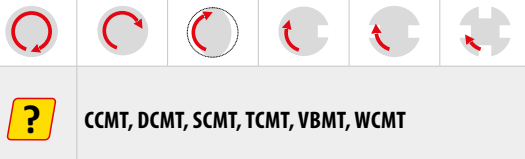

CCMT, DCMT, SCMT, TCMT, VBMT, WCMT

GEOMETRY OF CUTTING POSITIVE INSERTS – CLAMPING DESIGNATION ISO S

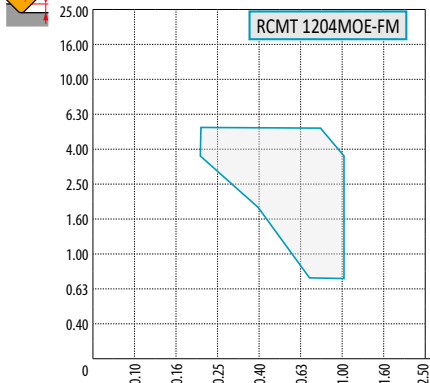

FM (RCMT)

P	M	K	N	S	H
■	■	▣	▣		
f	0.10 – 1.0				
a_p	0.3 – 5.0				
					
					
?	RCMT				

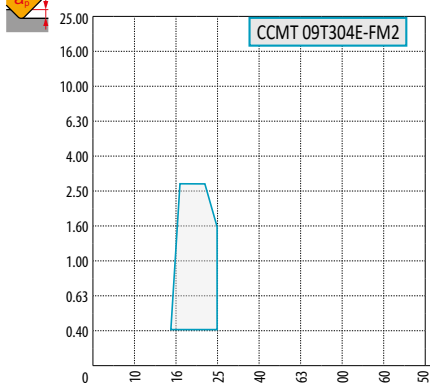

FM2

P	M	K	N	S	H
■	▣	■			
f	0.04 – 0.4				
a_p	0.2 – 4.0				
					
					
?	CCMT, DCMT, ECMT, SCMT, TCMT, VBMT, VCGT				

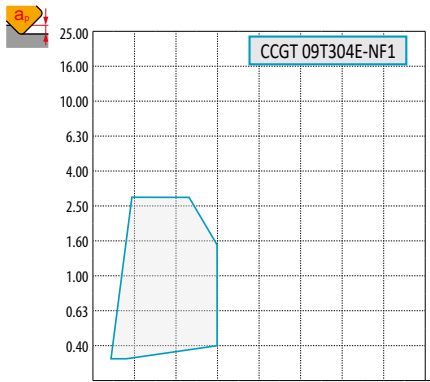

NF1

P	M	K	N	S	H
■	■		▣	■	▣
f	0.04 – 0.35				
a_p	0.3 – 3.5				
					
					
?	CCGT, DCGT, SCGT, TCGT				

NF2

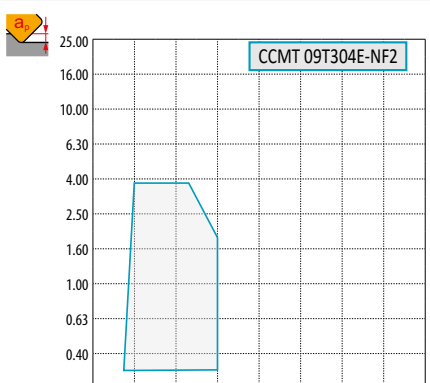
P	M	K	N	S	H
▣	■	▣	▣	■	
f	0.05 – 0.45				
a_p	0.2 – 4.0				
					
					
?	CCMT, EPMT, SCMT, TCMT, VCGT				

GEOMETRY OF CUTTING POSITIVE INSERTS – CLAMPING DESIGNATION ISO S

OR (SCMT)

P	M	K	N	S	H
■	■	■	■	■	■

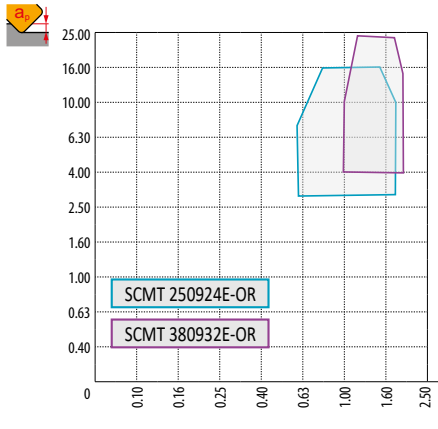
f : 0.60 – 2.00

a_p : 3.0 – 24.0



? SCMT

RF

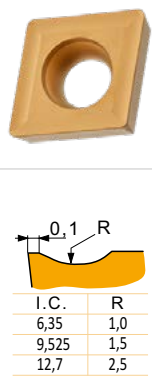

I.C.	R
6,35	1,0
9,525	1,5
12,7	2,5

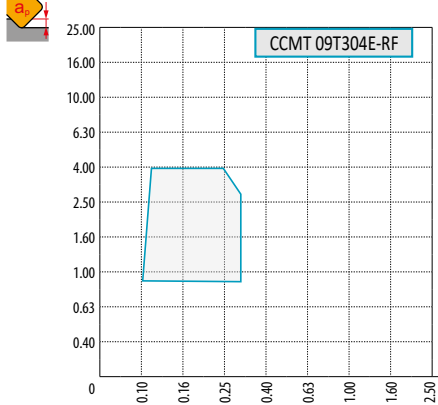

P	M	K	N	S	H
■	■	■	■	■	■

f : 0.10 – 0.60

a_p : 0.8 – 8.0



? CCMT, DCMT, SCMT, TCMT, WCMT

RM

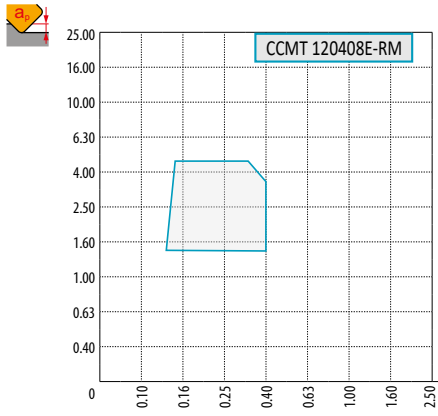
P	M	K	N	S	H
■	■	■	■	■	■

f : 0.10 – 0.50

a_p : 0.8 – 4.5



? CCMT, DCMT, SCMT, TCMT, VBMT

RM3

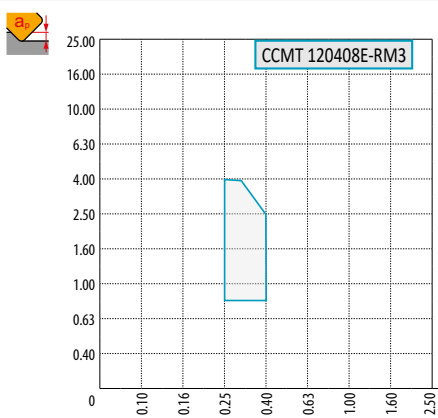
P	M	K	N	S	H
■	■	■	■	■	■

f : 0.15 – 0.90

a_p : 0.4 – 6.00



? CCMT, SCMT, TCMT, RCMT

GEOMETRY OF CUTTING POSITIVE INSERTS – CLAMPING DESIGNATION ISO S

SF2

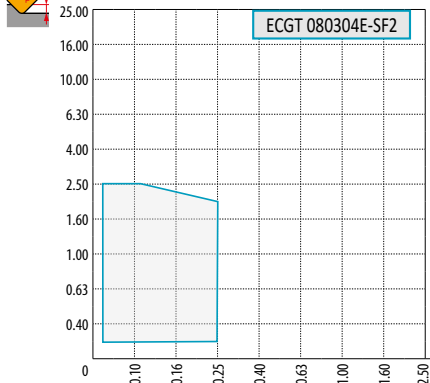
P	M	K	N	S	H
☐	■	■	☐	■	
f	0.02 – 0.28				
a_p	0.1 – 2.5				

? ECGT, VCGT

SF3

P	M	K	N	S	H
☐	■	☐	■	■	☐
f	0.02 – 0.35				
a_p	0.2 – 4.00				

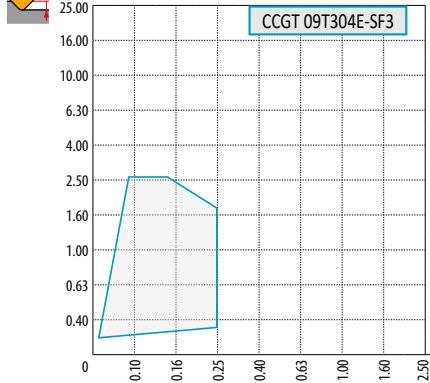
? CCGT, DCGT, ECGT, SCGT, TCGT, VCGT

SI

P	M	K	N	S	H
■	■	☐		■	
f	0.08 – 0.45				
a_p	0.4 – 4.0				

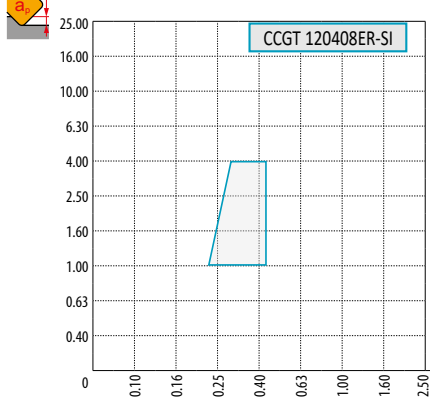
? CCGT, TCGT

SR (SCMT)

P	M	K	N	S	H
■	■	■			
f	0.60 – 2.0				
a_p	3.0 – 24.0				

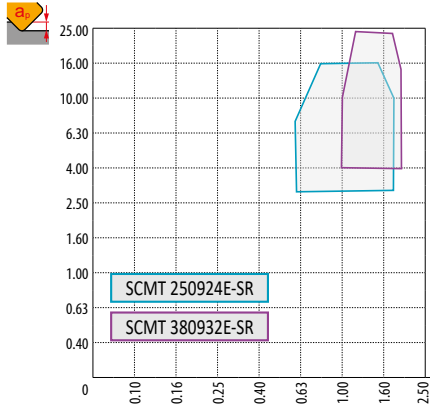
? SCMT

GEOMETRY OF CUTTING POSITIVE INSERTS – CLAMPING DESIGNATION ISO S

UR (RCMT)

RCMT 10T3MOE-UR

P	M	K	N	S	H
■	▣	■	■	■	■
f	0.15 – 1.00				
a_p	0.5 – 5.0				

UR

CCMT 120408E-UR

P	M	K	N	S	H
■	▣	■	■	■	■
f	0.10 – 0.40				
a_p	1.0 – 4.0				

W-FM

CCMT 09T304W-FM

P	M	K	N	S	H
■	■	■	■	■	■
f	0.1 – 0.4				
a_p	0.3 – 3.0				

W-UR

CCMT 09T308W-UR

P	M	K	N	S	H
■	▣	■	■	■	■
f	0.08 – 0.5				
a_p	0.4 – 3.0				



GEOMETRY OF CUTTING POSITIVE INSERTS – CLAMPING DESIGNATION ISO C

46

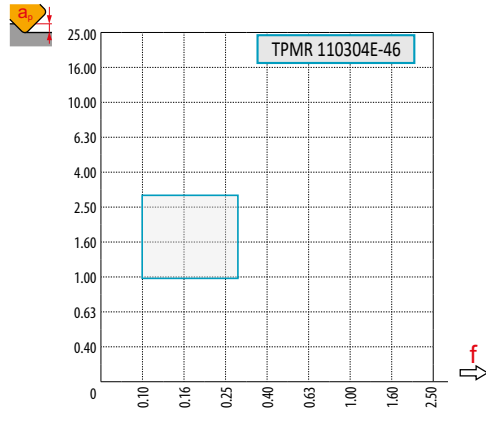

TPMR 110304E-46





P	M	K	N	S	H
■	▣	■	■	■	■
f	0.10 – 0.30				
a_p	1.0 – 3.0				
					
					
?	SPMR, TPMR				

47

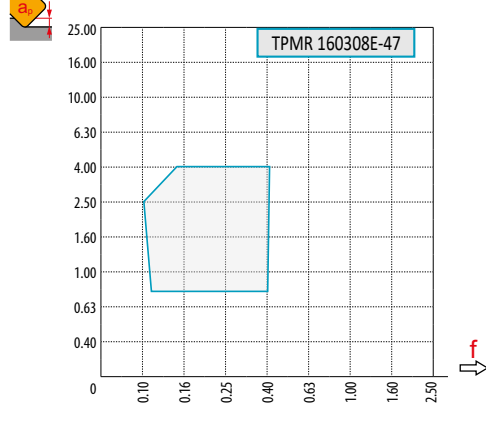

TPMR 160308E-47





P	M	K	N	S	H
■	▣	■	■	■	■
f	0.10 – 0.40				
a_p	0.8 – 4.0				
					
					
?	TPMR				

48

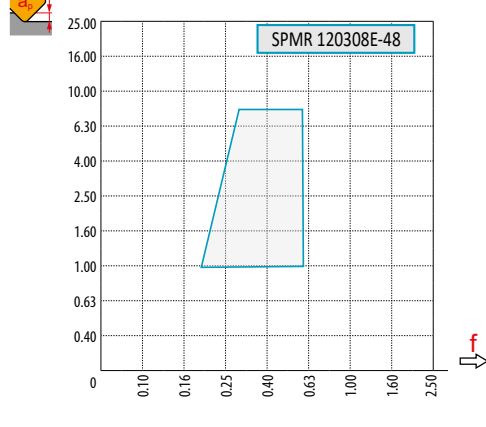

SPMR 120308E-48





P	M	K	N	S	H
■	▣	■	■	■	■
f	0.20 – 0.60				
a_p	1.0 – 8.0				
					
					
?	SPMR				

61

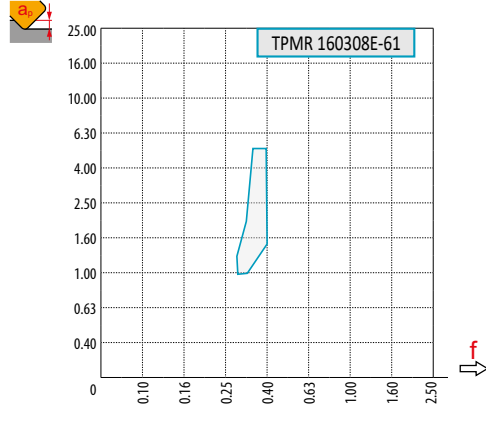

TPMR 160308E-61



P	M	K	N	S	H
■	▣	■	■	■	■
f	0.30 – 0.40				
a_p	1.0 – 5.3				
					
					
?	TPMR				



GEOMETRY OF CUTTING POSITIVE INSERTS – CLAMPING DESIGNATION ISO C

.PUN

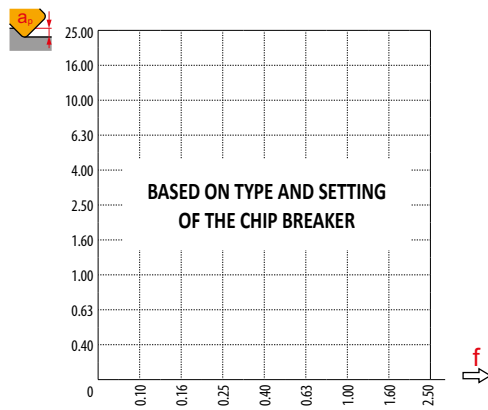
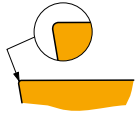

P	M	K	N	S	H
<input type="checkbox"/>		<input checked="" type="checkbox"/>			<input checked="" type="checkbox"/>
f	0.10 – 0.60				
a_p	0.4 – 17.5				
	TPUN, SPUN				



GEOMETRY OF CUTTING POSITIVE INSERTS – CLAMPING DESIGNATION ISO P, M, D

31 (RCMX)

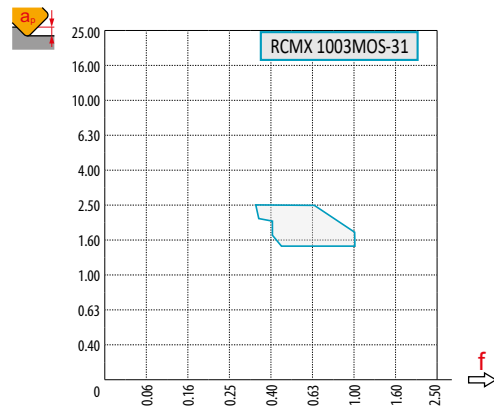
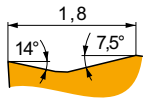

P	M	K	N	S	H
■	■	■	■	■	■
f	0.40 – 1.00				
a _p	1.5 – 2.5				
?	RCMX				

321 (RCMX)

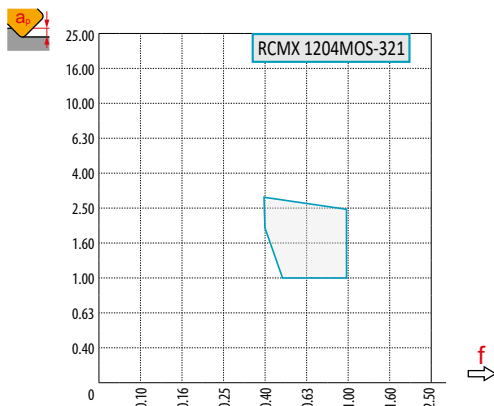
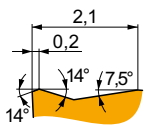

P	M	K	N	S	H
■	■	■	■	■	■
f	0.40 – 1.00				
a _p	1.0 – 3.0				
?	RCMX				

331 (RCMX)

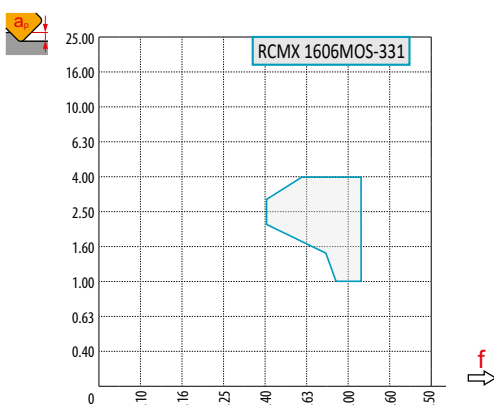
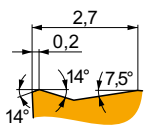

P	M	K	N	S	H
■	■	■	■	■	■
f	0.40 – 1.20				
a _p	1.0 – 4.0				
?	RCMX				

361 (RCMX)

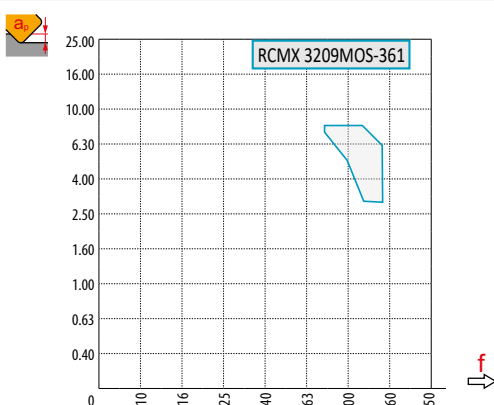
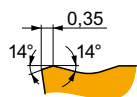

P	M	K	N	S	H
■	■	■	■	■	■
f	0.80 – 1.50				
a _p	3.0 – 8.0				
?	RCMX				



GEOMETRY OF CUTTING POSITIVE INSERTS – CLAMPING DESIGNATION ISO P, M, D

RF1 (RCMX)			<table border="1"> <thead> <tr> <th>P</th> <th>M</th> <th>K</th> <th>N</th> <th>S</th> <th>H</th> </tr> </thead> <tbody> <tr> <td>■</td> <td></td> <td>▣</td> <td></td> <td></td> <td></td> </tr> <tr> <td>f</td> <td colspan="5">0.45 (0.60) – 1.20 (1.25)</td> </tr> <tr> <td>a_p</td> <td colspan="5">1.0 (1.5) – 5.0 (7.0)</td> </tr> <tr> <td colspan="6" style="text-align: center;"> </td> </tr> <tr> <td colspan="6" style="text-align: center;"> </td> </tr> <tr> <td colspan="6" style="text-align: center;"> RCMX 20, RCMX 25 </td> </tr> </tbody> </table>	P	M	K	N	S	H	■		▣				f	0.45 (0.60) – 1.20 (1.25)					a_p	1.0 (1.5) – 5.0 (7.0)																	RCMX 20, RCMX 25					
P	M	K	N	S	H																																								
■		▣																																											
f	0.45 (0.60) – 1.20 (1.25)																																												
a_p	1.0 (1.5) – 5.0 (7.0)																																												
RCMX 20, RCMX 25																																													
RM1 (RCMX)			<table border="1"> <thead> <tr> <th>P</th> <th>M</th> <th>K</th> <th>N</th> <th>S</th> <th>H</th> </tr> </thead> <tbody> <tr> <td>■</td> <td></td> <td>▣</td> <td></td> <td></td> <td></td> </tr> <tr> <td>f</td> <td colspan="5">0.50 (0.70) – 1.30 (1.40)</td> </tr> <tr> <td>a_p</td> <td colspan="5">1.5 (2.0) – 5.0 (8.0)</td> </tr> <tr> <td colspan="6" style="text-align: center;"> </td> </tr> <tr> <td colspan="6" style="text-align: center;"> </td> </tr> <tr> <td colspan="6" style="text-align: center;"> RCMX 20, RCMX 25 </td> </tr> </tbody> </table>	P	M	K	N	S	H	■		▣				f	0.50 (0.70) – 1.30 (1.40)					a_p	1.5 (2.0) – 5.0 (8.0)																	RCMX 20, RCMX 25					
P	M	K	N	S	H																																								
■		▣																																											
f	0.50 (0.70) – 1.30 (1.40)																																												
a_p	1.5 (2.0) – 5.0 (8.0)																																												
RCMX 20, RCMX 25																																													
RM2 (RCM.)			<table border="1"> <thead> <tr> <th>P</th> <th>M</th> <th>K</th> <th>N</th> <th>S</th> <th>H</th> </tr> </thead> <tbody> <tr> <td>■</td> <td></td> <td>▣</td> <td></td> <td></td> <td></td> </tr> <tr> <td>f</td> <td colspan="5">0.70 (0.80) – 1.30 (1.50)</td> </tr> <tr> <td>a_p</td> <td colspan="5">2.0 – 7.0 (8.0)</td> </tr> <tr> <td colspan="6" style="text-align: center;"> </td> </tr> <tr> <td colspan="6" style="text-align: center;"> </td> </tr> <tr> <td colspan="6" style="text-align: center;"> RCMX 25, RCMX 32 </td> </tr> </tbody> </table>	P	M	K	N	S	H	■		▣				f	0.70 (0.80) – 1.30 (1.50)					a_p	2.0 – 7.0 (8.0)																	RCMX 25, RCMX 32					
P	M	K	N	S	H																																								
■		▣																																											
f	0.70 (0.80) – 1.30 (1.50)																																												
a_p	2.0 – 7.0 (8.0)																																												
RCMX 25, RCMX 32																																													
RR2 (RCM.)			<table border="1"> <thead> <tr> <th>P</th> <th>M</th> <th>K</th> <th>N</th> <th>S</th> <th>H</th> </tr> </thead> <tbody> <tr> <td>■</td> <td></td> <td>■</td> <td></td> <td></td> <td>▣</td> </tr> <tr> <td>f</td> <td colspan="5">0.80 – 1.60</td> </tr> <tr> <td>a_p</td> <td colspan="5">4.0 – 8.0</td> </tr> <tr> <td colspan="6" style="text-align: center;"> </td> </tr> <tr> <td colspan="6" style="text-align: center;"> </td> </tr> <tr> <td colspan="6" style="text-align: center;"> RCMX 32 </td> </tr> </tbody> </table>	P	M	K	N	S	H	■		■			▣	f	0.80 – 1.60					a_p	4.0 – 8.0																	RCMX 32					
P	M	K	N	S	H																																								
■		■			▣																																								
f	0.80 – 1.60																																												
a_p	4.0 – 8.0																																												
RCMX 32																																													

GEOMETRY OF CUTTING NEGATIVE INSERTS – CLAMPING DESIGNATION ISO P, M, D

000 (LNUX)

P	M	K	N	S	H
■		■			
f	1.20 – 2.50				
a _p	10.0 – 36.0				
?	LNUX 50				

002 (LNUX)

P	M	K	N	S	H
■		■			
f	1.30 – 2.60				
a _p	10.0 – 27.0				
?	LNUX 40				

003 (LNUX)

P	M	K	N	S	H
■		■			
f	1.20 – 2.50				
a _p	10.0 – 27.0				
?	LNUX 40				

08 (RNMG)

P	M	K	N	S	H
▣		▣			▣
f	0.30 – 0.80				
a _p	1.0 – 4.0				
?	RNMG				





GEOMETRY OF CUTTING NEGATIVE INSERTS – CLAMPING DESIGNATION ISO P, M, D

81 (RNMG)		<p>RNMG 250900E-081</p>	<table border="1"> <thead> <tr> <th>P</th> <th>M</th> <th>K</th> <th>N</th> <th>S</th> <th>H</th> </tr> </thead> <tbody> <tr> <td><input checked="" type="checkbox"/></td> <td></td> <td><input checked="" type="checkbox"/></td> <td></td> <td></td> <td><input checked="" type="checkbox"/></td> </tr> <tr> <td>f</td> <td colspan="5">0.80 – 1.20</td> </tr> <tr> <td>a_p</td> <td colspan="5">3.0 – 7.0</td> </tr> <tr> <td colspan="6" style="text-align: center;"> </td> </tr> <tr> <td colspan="6" style="text-align: center;"> </td> </tr> <tr> <td>?</td> <td colspan="5">RNMG</td> </tr> </tbody> </table>	P	M	K	N	S	H	<input checked="" type="checkbox"/>		<input checked="" type="checkbox"/>			<input checked="" type="checkbox"/>	f	0.80 – 1.20					a_p	3.0 – 7.0																	?	RNMG				
P	M	K	N	S	H																																								
<input checked="" type="checkbox"/>		<input checked="" type="checkbox"/>			<input checked="" type="checkbox"/>																																								
f	0.80 – 1.20																																												
a_p	3.0 – 7.0																																												
?	RNMG																																												
432 (LNMX)		<p>LNMX 501432E</p>	<table border="1"> <thead> <tr> <th>P</th> <th>M</th> <th>K</th> <th>N</th> <th>S</th> <th>H</th> </tr> </thead> <tbody> <tr> <td><input checked="" type="checkbox"/></td> <td></td> <td><input checked="" type="checkbox"/></td> <td></td> <td></td> <td></td> </tr> <tr> <td>f</td> <td colspan="5">1.50 – 2.60</td> </tr> <tr> <td>a_p</td> <td colspan="5">10.0 – 35.0</td> </tr> <tr> <td colspan="6" style="text-align: center;"> </td> </tr> <tr> <td colspan="6" style="text-align: center;"> </td> </tr> <tr> <td>?</td> <td colspan="5">LNMX 50</td> </tr> </tbody> </table>	P	M	K	N	S	H	<input checked="" type="checkbox"/>		<input checked="" type="checkbox"/>				f	1.50 – 2.60					a_p	10.0 – 35.0																	?	LNMX 50				
P	M	K	N	S	H																																								
<input checked="" type="checkbox"/>		<input checked="" type="checkbox"/>																																											
f	1.50 – 2.60																																												
a_p	10.0 – 35.0																																												
?	LNMX 50																																												
923		<p>SNMM 190616S-923</p>	<table border="1"> <thead> <tr> <th>P</th> <th>M</th> <th>K</th> <th>N</th> <th>S</th> <th>H</th> </tr> </thead> <tbody> <tr> <td><input checked="" type="checkbox"/></td> <td><input checked="" type="checkbox"/></td> <td><input checked="" type="checkbox"/></td> <td></td> <td><input checked="" type="checkbox"/></td> <td></td> </tr> <tr> <td>f</td> <td colspan="5">0.45 – 1.50</td> </tr> <tr> <td>a_p</td> <td colspan="5">3.0 – 16.0</td> </tr> <tr> <td colspan="6" style="text-align: center;"> </td> </tr> <tr> <td colspan="6" style="text-align: center;"> </td> </tr> <tr> <td>?</td> <td colspan="5">CNMM, SNMM</td> </tr> </tbody> </table>	P	M	K	N	S	H	<input checked="" type="checkbox"/>	<input checked="" type="checkbox"/>	<input checked="" type="checkbox"/>		<input checked="" type="checkbox"/>		f	0.45 – 1.50					a_p	3.0 – 16.0																	?	CNMM, SNMM				
P	M	K	N	S	H																																								
<input checked="" type="checkbox"/>	<input checked="" type="checkbox"/>	<input checked="" type="checkbox"/>		<input checked="" type="checkbox"/>																																									
f	0.45 – 1.50																																												
a_p	3.0 – 16.0																																												
?	CNMM, SNMM																																												
...A		<p>CNMA 190612</p> <p>CAST IRON</p> <p>HARDENED STEEL</p>	<table border="1"> <thead> <tr> <th>P</th> <th>M</th> <th>K</th> <th>N</th> <th>S</th> <th>H</th> </tr> </thead> <tbody> <tr> <td></td> <td></td> <td><input checked="" type="checkbox"/></td> <td></td> <td></td> <td><input checked="" type="checkbox"/></td> </tr> <tr> <td>f</td> <td colspan="5">0.10 – 1.10</td> </tr> <tr> <td>a_p</td> <td colspan="5">0.8 – 12.7</td> </tr> <tr> <td colspan="6" style="text-align: center;"> </td> </tr> <tr> <td colspan="6" style="text-align: center;"> </td> </tr> <tr> <td>?</td> <td colspan="5">CNMA, DNMA, SNMA, TNMA, WNMA</td> </tr> </tbody> </table>	P	M	K	N	S	H			<input checked="" type="checkbox"/>			<input checked="" type="checkbox"/>	f	0.10 – 1.10					a_p	0.8 – 12.7																	?	CNMA, DNMA, SNMA, TNMA, WNMA				
P	M	K	N	S	H																																								
		<input checked="" type="checkbox"/>			<input checked="" type="checkbox"/>																																								
f	0.10 – 1.10																																												
a_p	0.8 – 12.7																																												
?	CNMA, DNMA, SNMA, TNMA, WNMA																																												

GEOMETRY OF CUTTING NEGATIVE INSERTS – CLAMPING DESIGNATION ISO P, M, D

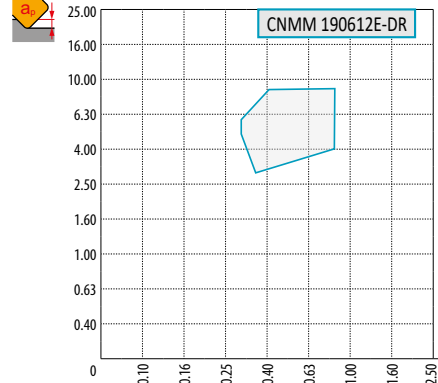

DR

P	M	K	N	S	H
■	▣	▣	■	■	■
f	0.30 – 0.85				
a_p	2.5 – 9.0				
					
					
?	CNMM, DNMM, SNMM, TNMM, WNMM				

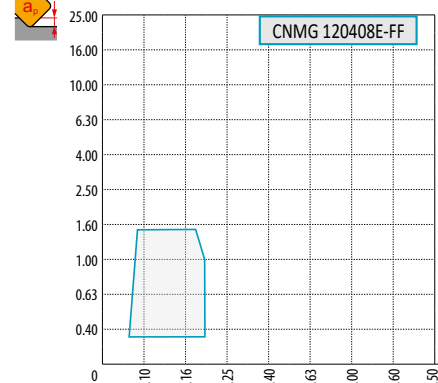

FF

P	M	K	N	S	H
■	■	▣	■	■	■
f	0.06 – 0.25				
a_p	0.2 – 1.6				
					
					
?	CNMG, DNMG, TNMG, VNMG, WNMG				

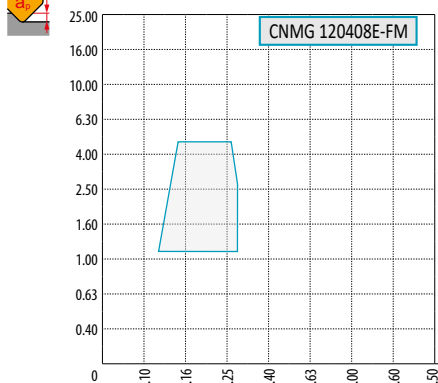

FM

P	M	K	N	S	H
■	▣	■	■	▣	■
f	0.1 – 0.5				
a_p	0.4 – 5.0				
					
					
?	CNMG, DNMG, SNMG, TNMG, VNMG, WNMG				

HR

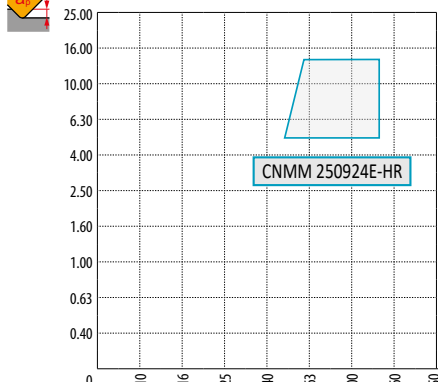





P	M	K	N	S	H
■	▣	■	■	■	■
f	0.50 – 1.40				
a_p	5.0 – 14.0				
					
					
?	CNMM, SNMM, TNMM				

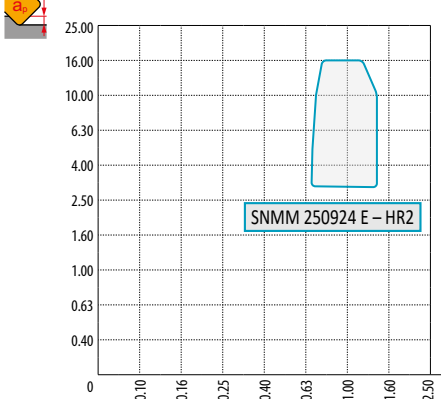

GEOMETRY OF CUTTING NEGATIVE INSERTS – CLAMPING DESIGNATION ISO P, M, D



HR2

P	M	K	N	S	H
■	■	■			
f	0.5 – 1.4				
a_p	3.0 – 16.0				
					
					
 CNMM, SNMM					

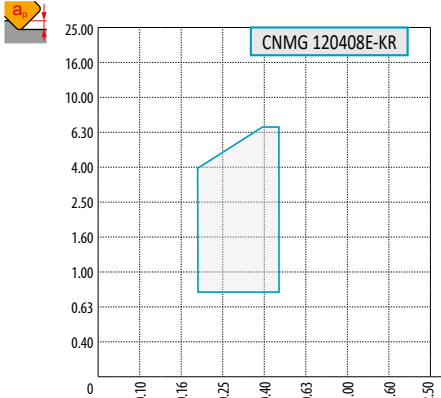

KR

P	M	K	N	S	H
■		■			■
f	0.2 – 0.7				
a_p	0.4 – 7				
					
					
 CNMG, SNMG, TNMG, WNMG					

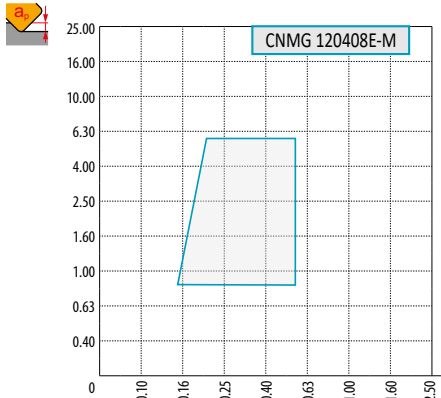

M

P	M	K	N	S	H
■		■			■
f	0.17 – 0.80				
a_p	0.8 – 8.0				
					
					
 CNMG, DNMG, SNMG, TNMG, VNMG, WNMG					

NF

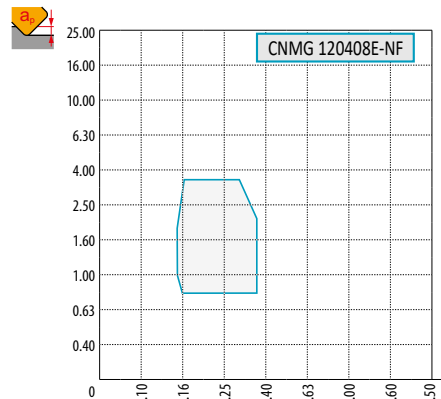
P	M	K	N	S	H
■	■	■	■	■	
f	0.1 – 0.35				
a_p	0.4 – 4.0				
					
					
 CNMG, DNMG, SNMG, TNMG, VNMG, WNMG					



GEOMETRY OF CUTTING NEGATIVE INSERTS – CLAMPING DESIGNATION ISO P, M, D

NM

P	M	K	N	S	H
■	■	■	■	■	■
f	0.15 – 0.55				
a_p	0.5 – 8.0				

? CNMG, DNMG, TNMG, VNMG, WNMG

NMR

P	M	K	N	S	H
■	■	■	■	■	■
f	0.18 – 0.70				
a_p	0.4 – 8.0				

? CNMG, DNMG, SNMG, TNMG, VNMG, WNMG

NR

P	M	K	N	S	H
■	■	■	■	■	■
f	0.25 – 0.80				
a_p	1.0 – 9.0				

? CNMM, DNMM, SNMM, TNMM, WNMM

NRM



P	M	K	N	S	H
■	■	■	■	■	■
f	0.23 – 1.0				
a_p	0.8 – 16.0				

? CNMG, CNMM, SNMG, SNMM

GEOMETRY OF CUTTING NEGATIVE INSERTS – CLAMPING DESIGNATION ISO P, M, K, N, S, H

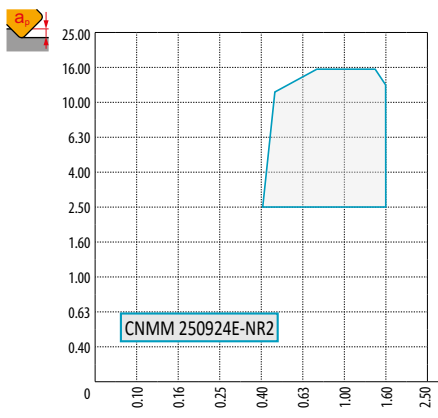

NR2

P	M	K	N	S	H
■	■	▣	■	▣	■
f	0.2 – 1.6				
a_p	1.0 – 16.0				
					
					
?	CNMM, DNMM, SNMM, TNMM, WNMM				

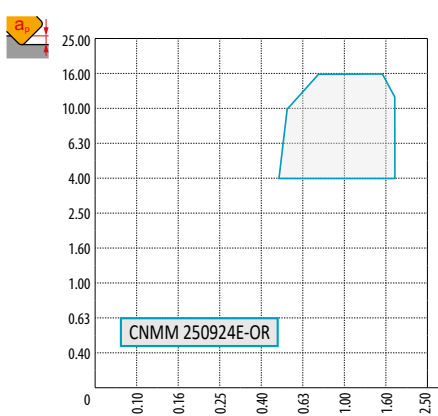

OR

P	M	K	N	S	H
■	▣	■	■	▣	■
f	0.25 – 1.70				
a_p	2.0 – 16.0				
					
					
?	CNMM, DNMM, SNMM, TNMM, WNMM, SCMT				

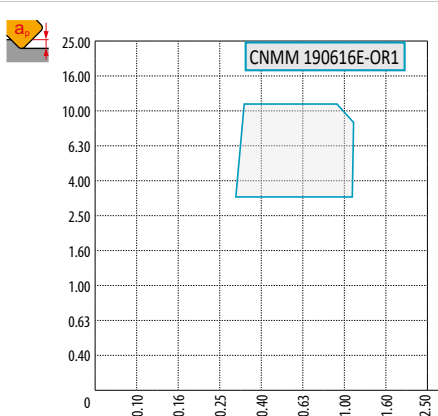

OR1

P	M	K	N	S	H
■	▣	▣	■	▣	■
f	0.3 – 1.0				
a_p	3.0 – 11.0				
					
					
?	CNMM, SNMM				

R

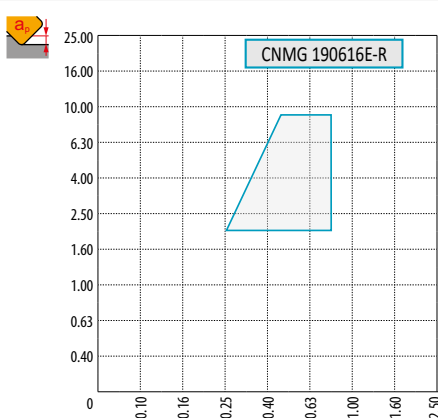



P	M	K	N	S	H
■	■	■	■	■	▣
f	0.25 – 0.80				
a_p	2.0 – 9.0				
					
					
?	CNMG, DNMG, SNMG, TNMG, WNMG				

GEOMETRY OF CUTTING NEGATIVE INSERTS – CLAMPING DESIGNATION ISO P, M, D

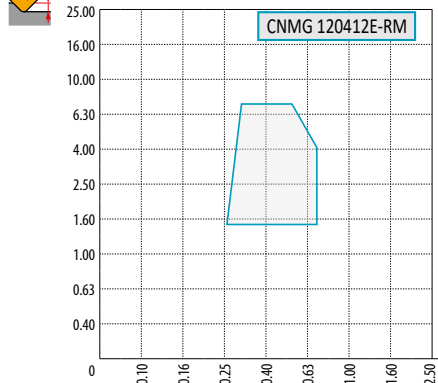

RM

P	M	K	N	S	H
■	■	■	□	□	□
f	0.20 – 1.20				
a_p	1.0 – 15.0				
					
					
?	CNMG, DNMG, SNMG, TNMG, WNMG				

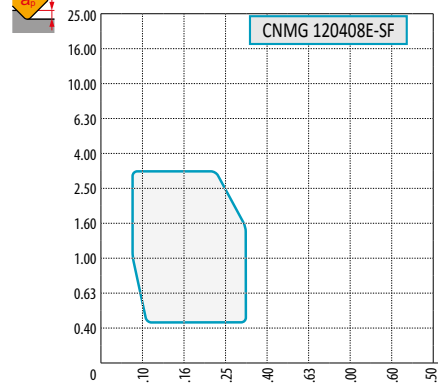

SF

P	M	K	N	S	H
■	■	■	□	■	■
f	0.08 – 0.35				
a_p	0.2 – 3.5				
					
					
?	CNMG, DNMG, SNMG, TNMG, VNMG, WNMG				

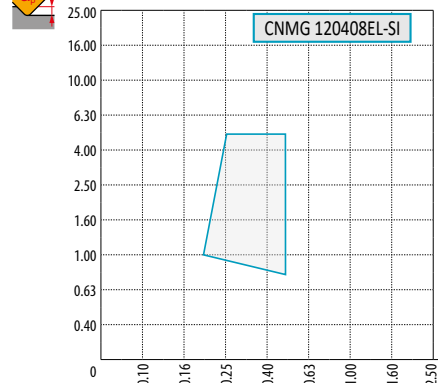

SI

P	M	K	N	S	H
■	■	□	□	□	□
f	0.20 – 0.50				
a_p	0.4 – 5.0				
					
					
?	CNMG, DNMG, TNMG, WNMG				

SM

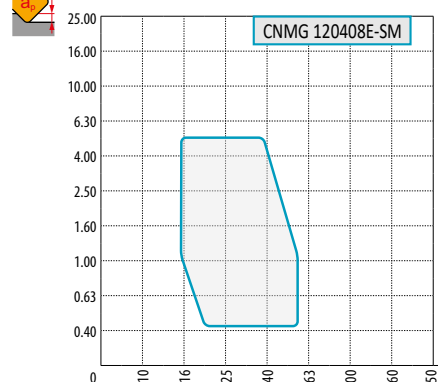





P	M	K	N	S	H
■	■	■	□	■	□
f	0.15 – 0.55				
a_p	0.4 – 6.0				
					
					
?	CNMG, DNMG, SNMG, TNMG, VNMG, WNMG				

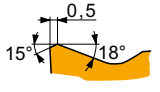
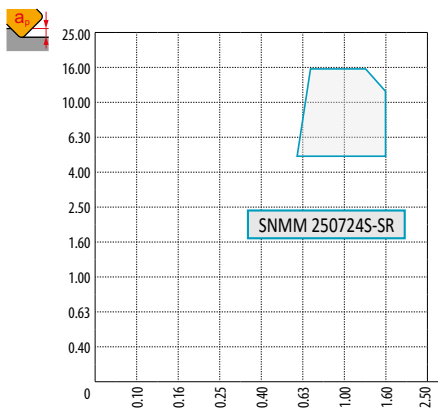

GEOMETRY OF CUTTING NEGATIVE INSERTS – CLAMPING DESIGNATION ISO P, M, D



SR

P	M	K	N	S	H
■	▣	■	■	■	■
f	0.70 – 1.60				
a_p	5.0 – 16.0				
					
					
?	SNMM, SNMX				

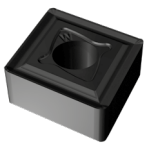
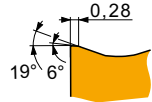
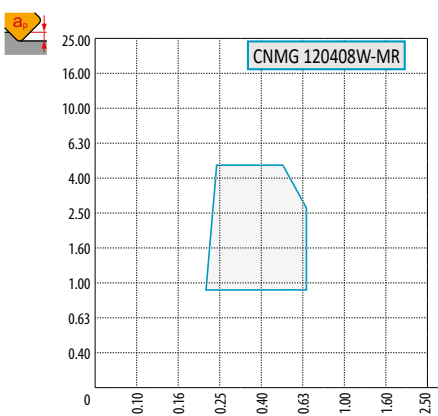

W-MR

P	M	K	N	S	H
■	▣	▣	■	■	■
f	0.2 – 0.75				
a_p	0.5 – 5.0				
					
					
?	CNMG, WNMG, DNMG				

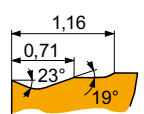
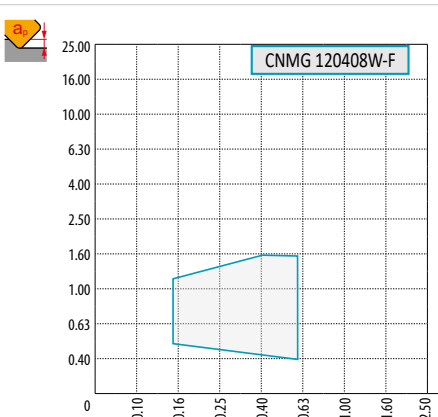

W-F

P	M	K	N	S	H
■	■	■	■	■	■
f	0.10 – 0.60				
a_p	0.4 – 1.6				
					
					
?	CNMG, WNMG				

W-M

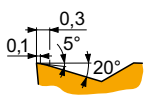
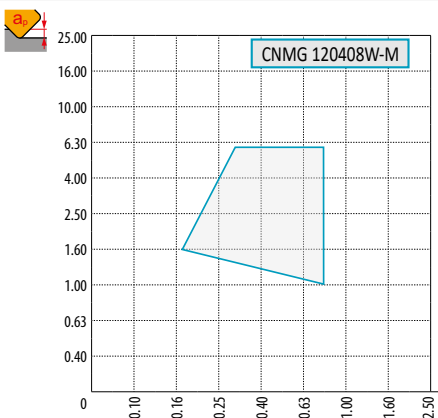



P	M	K	N	S	H
■	■	▣	■	■	■
f	0.15 – 1.00				
a_p	0.8 – 4.0				
					
					
?	CNMG, WNMG				

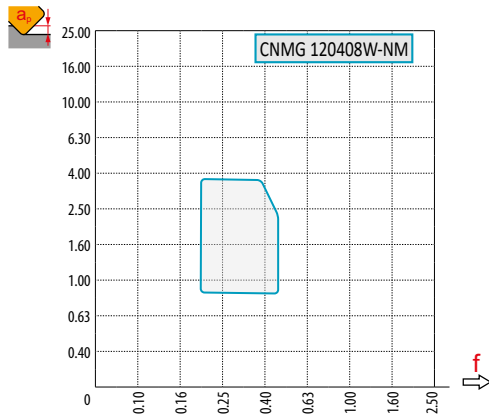
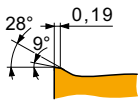

GEOMETRY OF CUTTING NEGATIVE INSERTS – CLAMPING DESIGNATION ISO P, M, D

W-NM



P	M	K	N	S	H
<input type="checkbox"/>	<input checked="" type="checkbox"/>	<input checked="" type="checkbox"/>	<input type="checkbox"/>	<input checked="" type="checkbox"/>	<input type="checkbox"/>
f	0.15 – 0.55				
a_p	0.5 – 3.5				
?	CNMG, DNMX, WNMG				



GEOMETRY OF CUTTING NEGATIVE INSERTS – CLAMPING DESIGNATION ISO C

22

0,45
15°

KNUX 160405L-22

P	M	K	N	S	H
■	▣	▣	■	■	■
f	0.23 – 0.55				
a_p	0.50 – 4.80				

? KNUX

32

0,36
15°

KNUX 160405L-32

P	M	K	N	S	H
■	▣	▣	■	■	■
f	0.25 – 0.6				
a_p	0.50 – 4.80				

? KNUX

72

3,07
1,2
12°

KNUX 160405ER-72

P	M	K	N	S	H
■	▣	■	■	▣	■
f	0.15 – 0.23				
a_p	1.0 – 4.0				

? KNUX

73

2,3
1,2
12,5°

KNUX 160405SR-73

P	M	K	N	S	H
■	▣	■	■	▣	■
f	0.20 – 0.60				
a_p	0.5 – 4.8				

? KNUX



GEOMETRY OF CUTTING NEGATIVE INSERTS – CLAMPING DESIGNATION ISO C

74

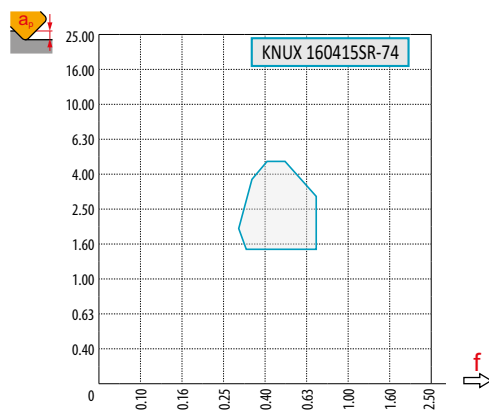
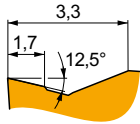

P	M	K	N	S	H
<input type="checkbox"/>	<input checked="" type="checkbox"/>	<input type="checkbox"/>	<input type="checkbox"/>	<input checked="" type="checkbox"/>	<input type="checkbox"/>
	0.30 – 0.7				
	1.5 – 4.8				
	KNUX				



GEOMETRY OF CUTTING GROOVING INSERTS – CLAMPING DESIGNATION ISO X AND G

GM (GL.D)



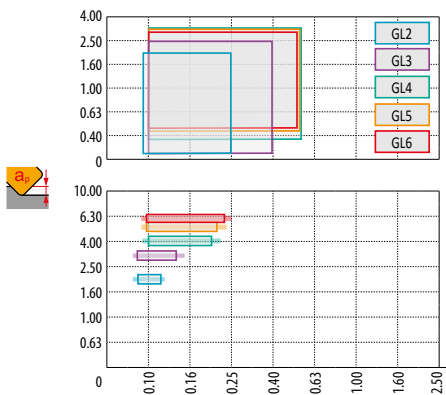

20°



Grade	Depth of cut a_p (mm)	Feed f (mm)
GL2	0.10 - 0.40	0.10 - 0.40
GL3	0.10 - 0.40	0.10 - 0.40
GL4	0.10 - 0.40	0.10 - 0.40
GL5	0.10 - 0.40	0.10 - 0.40
GL6	0.10 - 0.40	0.10 - 0.40

Material	Symbol
P	■
M	■
K	▣
N	■
S	▣
H	■

See diagram





? GL.D

MM (GL.D)



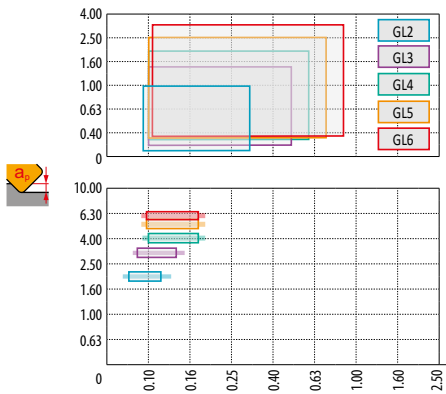

16° 4°



Grade	Depth of cut a_p (mm)	Feed f (mm)
GL2	0.10 - 0.40	0.10 - 0.40
GL3	0.10 - 0.40	0.10 - 0.40
GL4	0.10 - 0.40	0.10 - 0.40
GL5	0.10 - 0.40	0.10 - 0.40
GL6	0.10 - 0.40	0.10 - 0.40

Material	Symbol
P	■
M	■
K	▣
N	■
S	▣
H	■

See diagram





? GL.D

PM (GL.D)



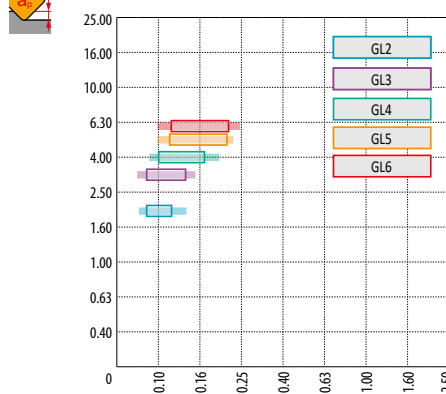

27° 3°



Grade	Depth of cut a_p (mm)	Feed f (mm)
GL2	0.10 - 0.40	0.10 - 0.40
GL3	0.10 - 0.40	0.10 - 0.40
GL4	0.10 - 0.40	0.10 - 0.40
GL5	0.10 - 0.40	0.10 - 0.40
GL6	0.10 - 0.40	0.10 - 0.40

Material	Symbol
P	■
M	■
K	▣
N	■
S	▣
H	■

See diagram





? GL.D

PR (GL.D)



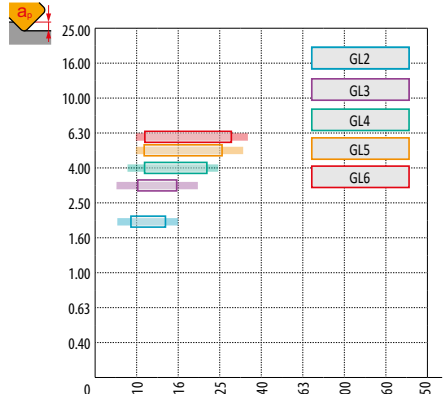

30° 12°



Grade	Depth of cut a_p (mm)	Feed f (mm)
GL2	0.10 - 0.40	0.10 - 0.40
GL3	0.10 - 0.40	0.10 - 0.40
GL4	0.10 - 0.40	0.10 - 0.40
GL5	0.10 - 0.40	0.10 - 0.40
GL6	0.10 - 0.40	0.10 - 0.40

Material	Symbol
P	■
M	▣
K	■
N	■
S	■
H	■

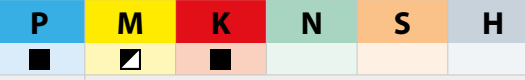
See diagram





? GL.D

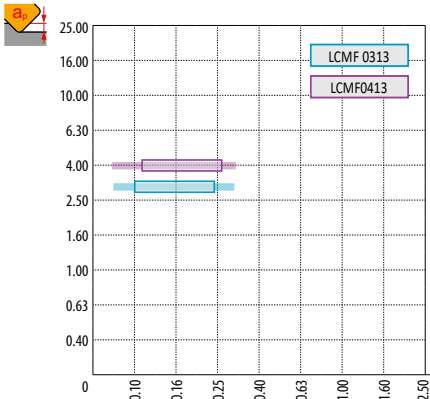

GEOMETRY OF CUTTING GROOVING INSERTS – CLAMPING DESIGNATION ISO X AND G

13 CM (LCMF)

P	M	K	N	S	H
■		▣			

See diagram



? LCMF 13 CM

13 F (LCM.)

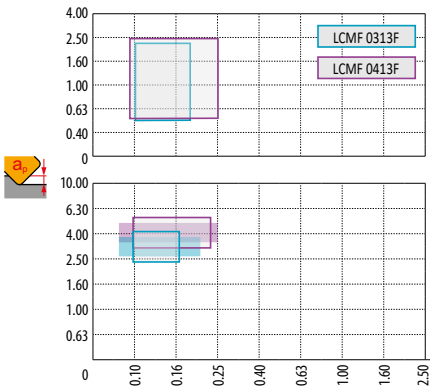
P	M	K	N	S	H
■		▣			

See diagram



? LCMF 13 F, LCMR 13 F

13 MP (LCM.)

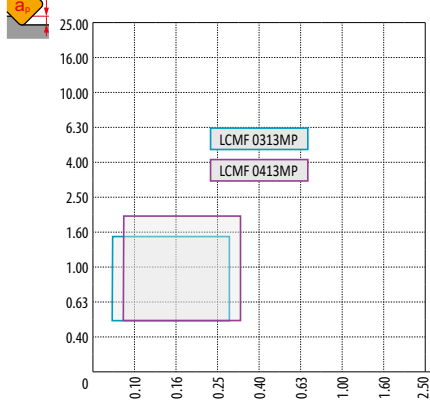
P	M	K	N	S	H
■		■			

See diagram



? LCMF 13 MP, LCMR 13 MP

16 CM (LCM.)

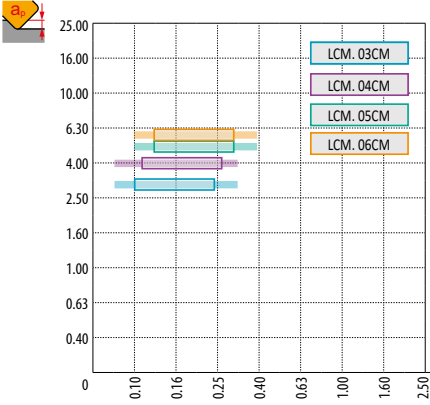
P	M	K	N	S	H
■		▣			

See diagram



? LCMF 16 CM, LCMR 16 CM



GEOMETRY OF CUTTING GROOVING INSERTS – CLAMPING DESIGNATION ISO X AND G

16 F (LCM.)

P	M	K	N	S	H
■		▣			

See diagram

? LCMF 16 F, LCMR 16 F

16 M (LCM.)

P	M	K	N	S	H
■		■			▣

See diagram

? LCMF 16 M, LCMR 16 M

16 MP (LCM.)

P	M	K	N	S	H
■		■			

See diagram

? LCMF 16 MP, LCMR 16 MP

20 F1 (LCMF)

P	M	K	N	S	H
■	▣	▣			

See diagram

? LCMF



GEOMETRY OF CUTTING GROOVING INSERTS – CLAMPING DESIGNATION ISO X AND G

20 M2 (LCMF)

P	M	K	N	S	H
■	▣	▣	■	■	■
f	0.09 – 0.23				
a_p	0.3 – 1.5				

? LCMF

30 F (LCMF)

P	M	K	N	S	H
■	■	▣	■	■	■
f	0.1 – 0.5				
a_p	0.8 – 6.0				

? LCMF 30 F, LCMR 30 F

F1 (LFMX)

P	M	K	N	S	H
■	▣	■	■	■	■
f	See diagram				
a_p	See diagram				

? LFMX

F2 (LFMX)

P	M	K	N	S	H
■	▣	■	■	■	■
f	See diagram				
a_p	See diagram				

? LFMX



GEOMETRY OF CUTTING GROOVING INSERTS – CLAMPING DESIGNATION ISO X AND G

M2 (LFMX)

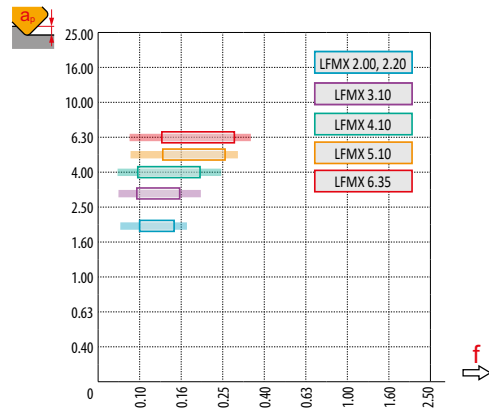
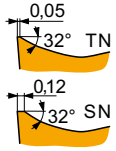
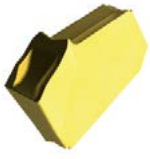

P	M	K	N	S	H
<input type="checkbox"/>	<input checked="" type="checkbox"/>	<input checked="" type="checkbox"/>	<input type="checkbox"/>	<input type="checkbox"/>	<input type="checkbox"/>
See diagram					
LFMX					

LFUX

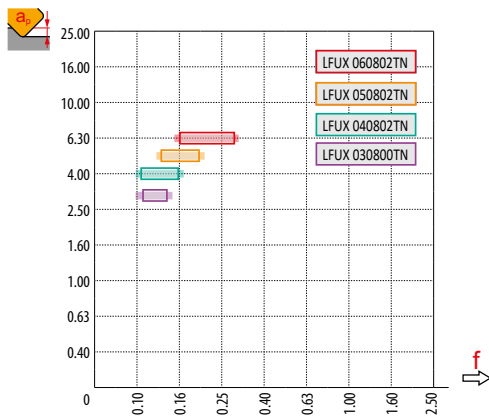
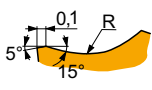
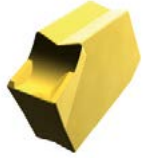

P	M	K	N	S	H
<input type="checkbox"/>	<input type="checkbox"/>	<input checked="" type="checkbox"/>	<input type="checkbox"/>	<input type="checkbox"/>	<input type="checkbox"/>
See diagram					
LFUX					

GEOMETRY OF CUTTING GROOVING INSERTS – CLAMPING DESIGNATION ISO S

TN. EXT

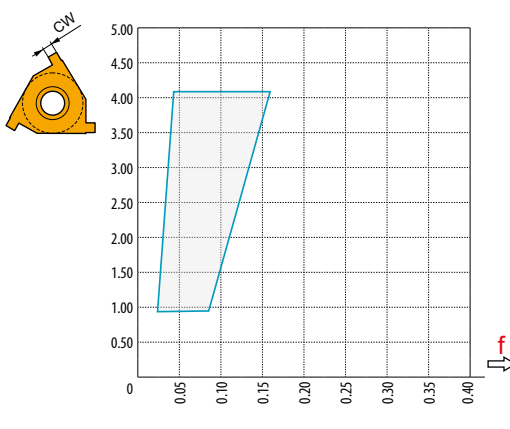
P	M	K	N	S	H
■	▣	▣	■	■	■

f → See diagram

CW → See diagram



? TN R EXT; TN ZZ EXT

TN. INT

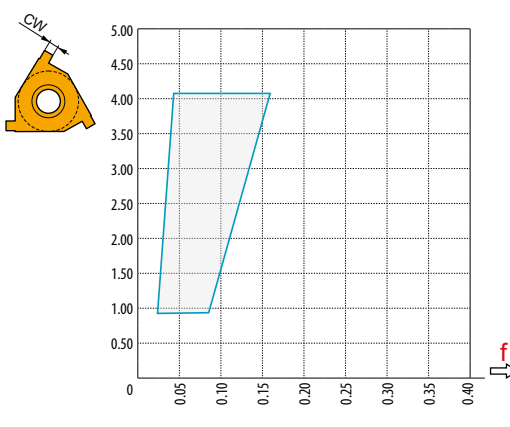
P	M	K	N	S	H
■	▣	▣	■	■	■

f → See diagram

CW → See diagram



? TN R INT; TN ZZ INT

X61

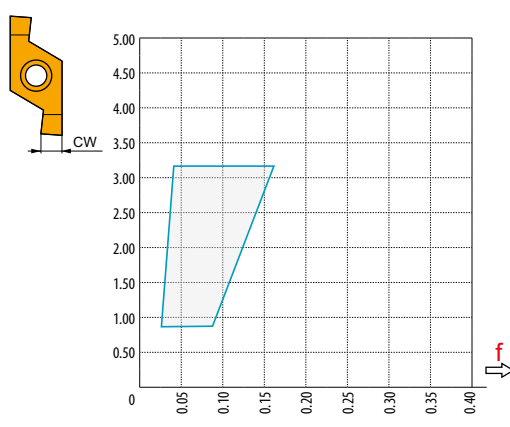
P	M	K	N	S	H
■	▣	▣	■	■	■

f → See diagram

CW → See diagram



? X61; X61-1

X61 R

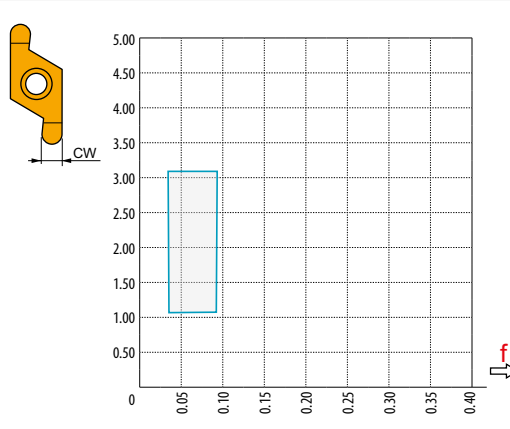
P	M	K	N	S	H
■	▣	▣	■	■	■

f → See diagram

CW → See diagram



? X61 R; X61 R-1

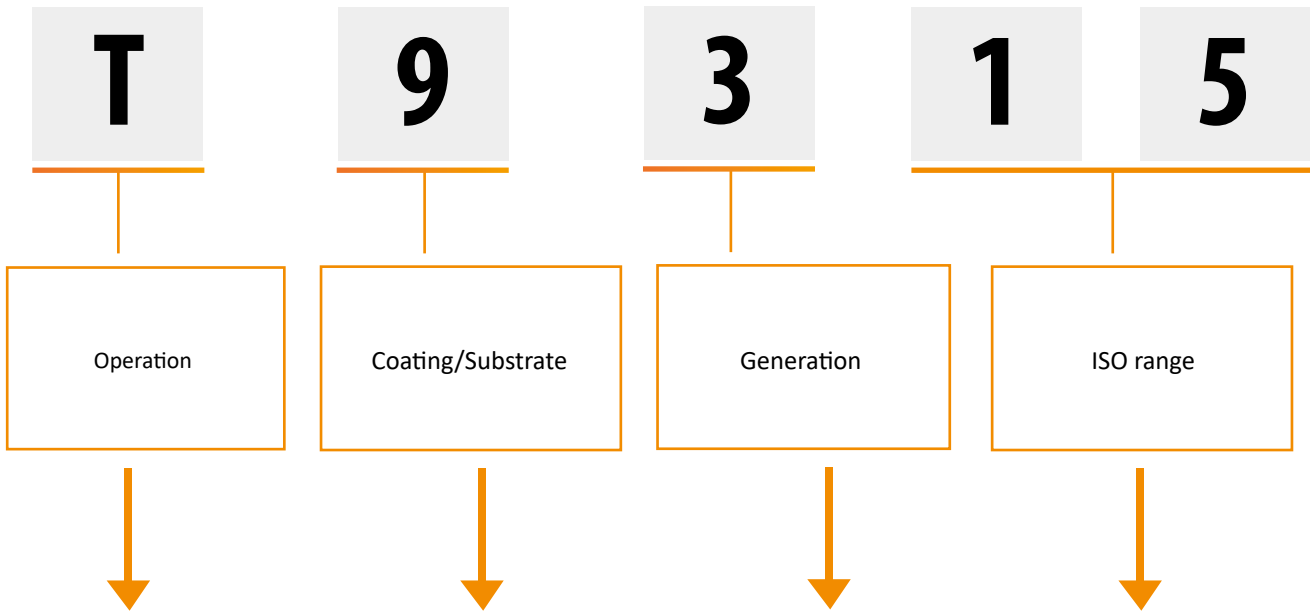

D	Drilling
M	Milling
T	Turning
G	Grooving and Parting off

0 PVD 1 CVD	Special application
2 PVD 3 CVD	Free
4 PVD 5 CVD	Group K, H
6 PVD 7 CVD	Group M, S
8 PVD 9 CVD	Universal
B	CBN
C	Ceramic
D	PCD
T	Cermet

1 – 9

01 – 50	
	01 – 05
	05 – 10
	10 – 20
	20 – 30
	30 – 40
	40 – 50



TURNING GRADES

Grade Identification	Area of Application	Application	Feed	Cutting speed	Resistance to adverse Working Conditions	Coating	Colour	Substrate	Coolant benefit	Grade description
T9226	P15 - P35	<input checked="" type="checkbox"/>				MT-CVD	FGM	FGM	+++	Grade designed for heavy roughing applications. A versatile grade with high resistance to mechanical damage and retains very good wear resistance. Usable at lower cutting speeds.
	M10 - M30	<input checked="" type="checkbox"/>								
	K15 - K35	<input checked="" type="checkbox"/>								
	S15 - S25	<input type="checkbox"/>								
T9310	P01 - P15	<input checked="" type="checkbox"/>				MT-CVD	FGM	FGM	++	Grade with high abrasion resistance which can be used for slightly interrupted cutting. It will be used for finishing or semi-roughing operations. This material can also be used for roughing operations provided the machine-tool-workpiece configuration is sufficiently rigid.
	K05 - K20	<input checked="" type="checkbox"/>								
	H10 - H20	<input checked="" type="checkbox"/>								
T9315	P05 - P25	<input checked="" type="checkbox"/>				MT-CVD	FGM	FGM	++	A versatile grade with excellent wear resistance properties even under intense cutting conditions. It can also be used for operations with interrupted cuts. With its well balanced properties this grade can be first choice for a wide range of turning operations. Not suited to low cutting speeds.
	K05 - K25	<input checked="" type="checkbox"/>								
	H10 - H20	<input checked="" type="checkbox"/>								
T9316	P10 - P20	<input checked="" type="checkbox"/>				MT-CVD	FGM	FGM	+++	Grade designed for railway applications. A versatile grade with excellent wear resistance properties. Usable at lower and high cutting speeds.
	M05 - M15	<input checked="" type="checkbox"/>								
	K10 - K30	<input checked="" type="checkbox"/>								
	H15 - H25	<input checked="" type="checkbox"/>								
T9325	P15 - P35	<input checked="" type="checkbox"/>				MT-CVD	FGM	FGM	++	From a technological perspective this is an extremely versatile grade with high resistance to mechanical damage in adverse cutting conditions and retains excellent wear resistance. The correct application of this material requires high cutting speeds.
	M10 - M30	<input checked="" type="checkbox"/>								
	K15 - K35	<input checked="" type="checkbox"/>								
T9335	P20 - P45	<input checked="" type="checkbox"/>				MT-CVD	FGM	FGM	+++	One of the toughest grades which is especially suitable for adverse cutting conditions at medium to high feed rates and medium cutting speeds. Compared to its predecessors, M15 – M40 it is not only tougher, but also more abrasion resistant which will be useful when using intensive cutting conditions.
	M15 - M40	<input checked="" type="checkbox"/>								
	S15 - S25	<input checked="" type="checkbox"/>								
T7325	P15 - P35	<input checked="" type="checkbox"/>				MT-CVD	FGM	FGM	+++	One of the most universal turning grades. Especially designed for stainless steel machining. Optimal balance between wear resistance and performance reliability. Suitable for broad variety of application in turning operations.
	M10 - M25	<input checked="" type="checkbox"/>								
	S10 - S25	<input checked="" type="checkbox"/>								
T7335	P20 - P40	<input checked="" type="checkbox"/>				MT-CVD	FGM	FGM	+++	Grade with functionally graded substrate, featuring very high operational reliability and very good wear-resistance. It is best suited to use in the machining of very tough M20 – M40 materials.
	M20 - M40	<input checked="" type="checkbox"/>								
	S15 - S25	<input checked="" type="checkbox"/>								
T5305	P05 - P15	<input checked="" type="checkbox"/>				MT-CVD	H	H	+	Grade with very high resistance to chemical wear; suitable for finishing operations using high cutting speeds. With its high abrasion resistance, it is also suitable for productive K01 – K15, machining of hardened and treated materials.
	K01 - K15	<input checked="" type="checkbox"/>								
	H05 - H15	<input checked="" type="checkbox"/>								
T5315	P10 - P25	<input checked="" type="checkbox"/>				MT-CVD	H	H	+	Grade intended primarily for productive machining which has high abrasion resistance and good operational reliability. Due to its properties, this material is particularly suitable for roughing and finishing operations for good or slightly adverse cutting conditions.
	K10 - K25	<input checked="" type="checkbox"/>								
	H15 - H25	<input checked="" type="checkbox"/>								
6640	P20 - P40	<input checked="" type="checkbox"/>				MT-CVD	H	H	+++	One of the toughest turning materials which can be used especially in roughing operations, or where operational reliability under adverse cutting conditions is a priority. Another ideal choice for machines working with low to medium cutting speeds and medium to high feed rates.
	M20 - M35	<input checked="" type="checkbox"/>								
	K25 - K40	<input checked="" type="checkbox"/>								



TURNING GRADES

Grade Identification	Area of Application	Application	Feed	Cutting speed	Resistance to adverse Working Conditions	Coating	Colour	Substrate	Coolant benefit	Grade description
G8330	P25 - P40	■				PVD	Yellow	submicron H	+++	Universal cutting grade for grooving and parting-off applications. This grade is characterized by its exceptional reliability and versatility. Developed to fit machining conditions for most workpiece materials.
	M20 - M35	■								
	K20 - K40	■								
	S15 - S25	■								
T0315	N05 - N20	■				PVD		++	Submicron grade for turning non-ferrous metals and their alloys with a balance of wear resistance and toughness. It is provided with a unique coating with excellent friction properties.	
T6310	P01 - P15	■				PVD	Grey	ultra submicron H	+++	High wear resistant turning grade with top PVD coating. Suitable for finishing operation and applications, where sharp cutting edge together with high flank wear resistance is of high importance
	M01 - M15	■								
	K05 - K20	■								
	N05 - N20	■								
	S01 - S15	■								
	H01 - H15	■								
T8010	P05 - P15	■				PVD	Yellow	submicron H	+++	This grade is suitable for continuous high precision thread turning of steels, stainless steel, cast iron and super alloys. Offering excellent wear resistance while ensuring operational reliability
	M05 - M15	■								
	K10 - K20	■								
	S10 - S15	■								
T8030	P25 - P40	■				PVD	Yellow	submicron H	+++	Undoubtedly the most versatile grade it is suitable for machining all types of materials and can be applied in almost all turning operations. It's main benefits are high operational reliability and excellent frictional properties; it is therefore suited to applications at medium to low cutting speeds.
	M20 - M35	■								
	K20 - K40	■								
	N15 - N30	■								
	S15 - S25	■								
T8315	P05 - P20	■				PVD	Yellow	submicron H	++	Grade featuring excellent abrasion resistance while maintaining above average operational reliability, it is suitable for machining at medium to high cutting speeds in short chipping harder materials.
	M05 - M20	■								
	K05 - K25	■								
	N05 - N25	■								
	S05 - S15	■								
T8330	P25 - P40	■				PVD	Yellow	submicron H	+++	Undoubtedly the most versatile cutting material, this is useful for machining of all types of machined materials and is practically applicable in almost all types of turning operations. Its main benefits are its high operational reliability and very good frictional properties; it is therefore suitable for applications at medium and lower cutting speeds.
	M20 - M35	■								
	K20 - K40	■								
	N15 - N30	■								
	S15 - S25	■								
T8430	P20 - P40	■				PVD	Brown	submicron H	+++	Undoubtedly the most versatile cutting material, this is useful for machining of all types of machined materials and is practically applicable in almost all types of turning operations. Its main benefits are its high operational reliability and very good frictional properties; it is therefore suitable for applications at medium and lower cutting speeds.
	M20 - M35	■								
	K25 - K40	■								
	N15 - N30	■								
	S15 - S25	■								
T8345	P30 - P50	■				PVD	Yellow	submicron H	+++	This is the toughest turning grade, which is intended mainly for machining under the worst cutting conditions and in applications with the highest requirements for operating reliability. Because of these properties, this material is recommended for lower cutting speeds.
	M20 - M40	■								
	K30 - K40	■								
	S20 - S30	■								
HF7	M10 - M20	■				×	Grey	submicron H	++	Uncoated grade which is primarily designed for machining non-ferrous metals; but can also be used for other machined materials (except steel). This material can be used in turning, milling, and even boring.
	K10 - K25	■								
	N10 - N25	■								



TURNING GRADES

Grade Identification	Area of Application	Application	Feed	Cutting speed	Resistance to adverse Working Conditions	Coating	Colour	Substrate	Coolant benefit	Grade description
H07	M05 - M15	<input type="checkbox"/>				×		submicron H	++	Uncoated turning grade suitable for machining applications where oxidation resistance is not dominating criterion of tool life. Designed for machining of Ti-based alloys. Grade exhibits high strength of cutting edge together with good wear resistance.
	K10 - K25	<input type="checkbox"/>								
	N10 - N30	<input type="checkbox"/>								
	S01 - S20	<input type="checkbox"/>								
TT310	P10 - P25	<input type="checkbox"/>				PVD		cermet	+ / -	Coated cermet used for fine and finish turning of carbon and alloy steels (including stainless). Its excellent friction properties are further improved by the coating applied using the PVD technique.
	M15 - M25	<input type="checkbox"/>								
TT010	P01 - P10	<input type="checkbox"/>				×		cermet	+ / -	Uncoated cermet, which is suitable for fine machining of all types of steel (including stainless) at very low feed rates. Its main advantage is the minimal radius of the cutting edge and its high resistance to physical and chemical wear mechanisms.
	M01 - M10	<input type="checkbox"/>								
TC100	K01 - K15	<input type="checkbox"/>				×		ceramics	--	Ceramic grade for cast iron machining. Suitable for machining with high cutting speed at stable conditions.
TB310	K01 - K10	<input type="checkbox"/>				×		CBN	--	CBN grade for machining of hardened materials. Suitable for machining with high cutting speed and small feeds at stable conditions.
	S05 - S10	<input type="checkbox"/>								
	H01 - H10	<input type="checkbox"/>								
PD1	N05 - N25	<input type="checkbox"/>				×		PKD	-	PKD grade for turning non-ferrous materials. Ideal choice for working with high cutting speed and small feeds at stable conditions.
333TN	P45 - P50	<input type="checkbox"/>				PVD		HSS	+++	Special grade composed of HSS substrate and thin hard PVD coating. The most tough cutting grade in the portfolio. Inserts with this grade are one and only used for slotting of key groove.
	M35 - M40	<input type="checkbox"/>								
	K35 - K40	<input type="checkbox"/>								

Substrat	
H	WC-Co based substrate
submicron H	WC-Co based substrate fine grained (< 1 µm)
ultra submicron H	WC-Co based substrate very fine grained (< 0,5 µm)
FGM	Functionally graded substrate
Cermet	Cemented carbide without WC
ceramics	Cutting ceramics
PCD	Polycrystalline Diamond
CBN	Cubic Boron Nitride
HSS	High speed steel

Coating	
MT-CVD	Medium-temperature chemical method of coating
PVD	Low-temperature physical method of coating
×	Uncoated grade

Benefits of cutting fluid	
+++	Use of coolant is essential
++	Highly recommended
+	Recommended
+ / -	Optional
--	Do not use coolant

CERAMICS AND THEIR PRACTICAL APPLICATION

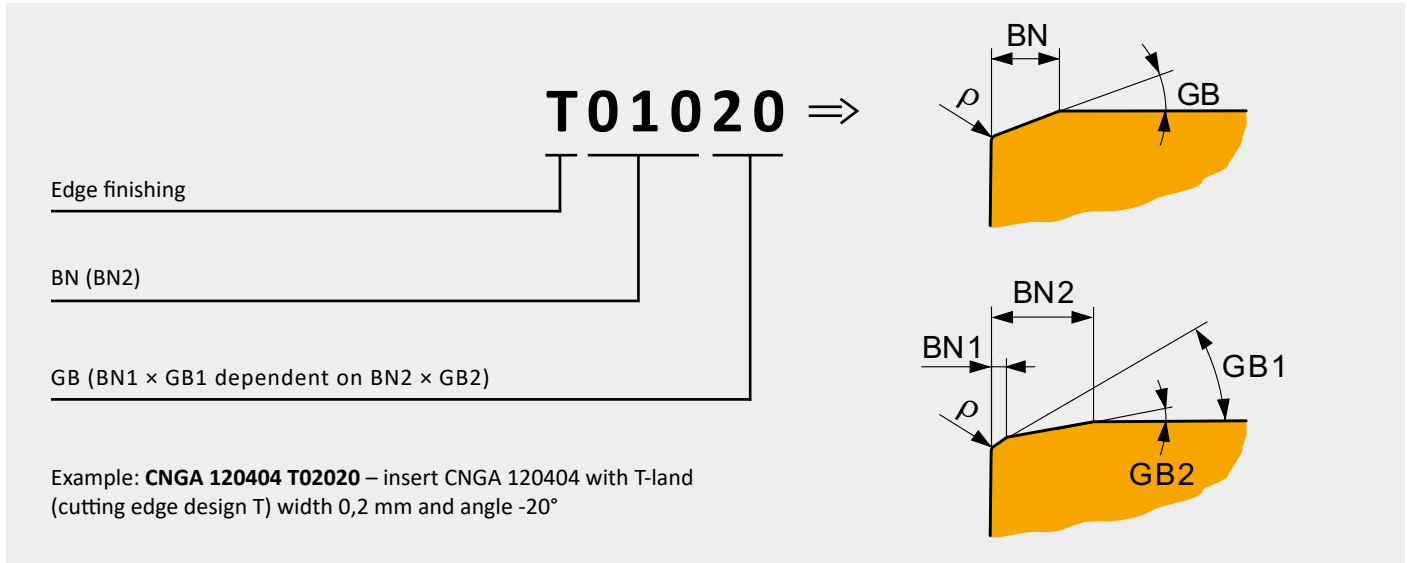

Ceramics are materials that have one of the highest levels of thermal stability. During their practical application, however, it is necessary to reduce

the cutting speed with regard to the hardness of the machined material and its other characteristics. For illustration purposes, we have provided a concrete example of a round insert used for finishing.

Cutting speed for RNGN ($a_p = 1.5$ mm)

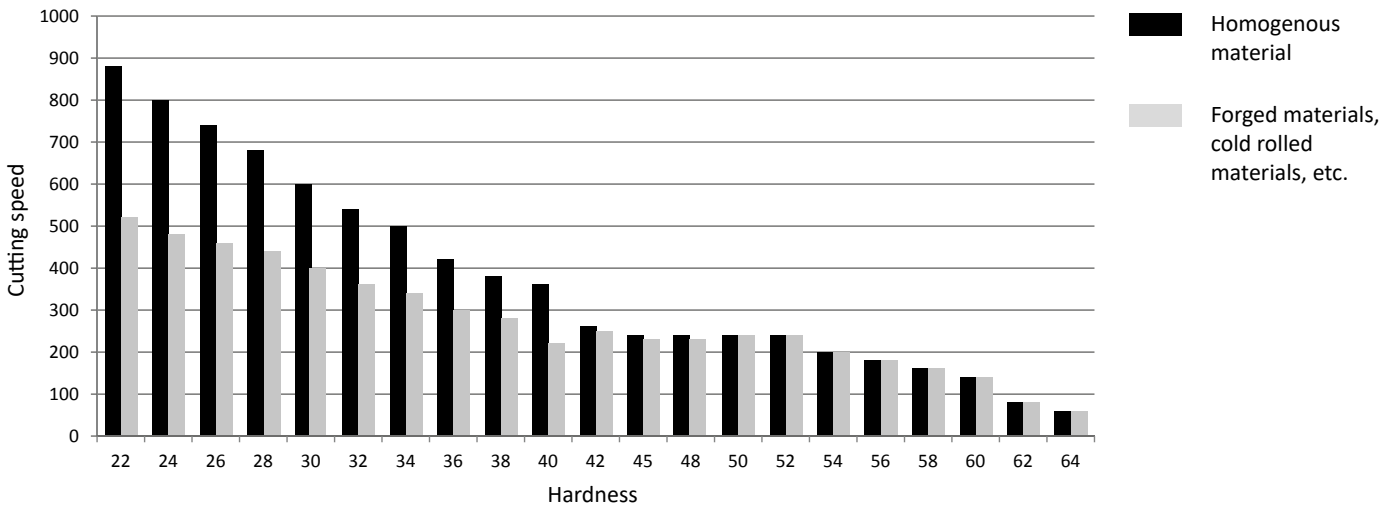

The following table provides further parameters that need to be taken into account when selecting the cutting speed to use.

Corner radius RE [mm]	0,4	0,8	1,2	1,6	2,4	3
Reduction v_c by	20 %	16 %	12 %	10 %	5 %	2 %
Main cutting edge angle	90°	75°	60°	45°	30°	< 15°
Reduction v_c by	0 %	5 %	8 %	12 %	15 %	18 %
Insert shape	V	D	T	C, W	S	R
Corner angle	35°	55°	60°	80°	90°	–
Reduction v_c by	17 %	12 %	10 %	6 %	4 %	0 %
Depth of cut a_p [mm]	<1.4	3	6	10	13	20
Reduction v_c by	5 %	8 %	13 %	16 %	18 %	20 %



CERAMICS AND THEIR PRACTICAL APPLICATION

As previously stated, ceramics are materials that have one of the highest levels of abrasion resistance, yet they also have one of the lowest levels of strength.

With regard to rigidity, it is therefore also necessary to take into account other limiting criteria when selecting the right insert.

Rigidity in relation to insert shape

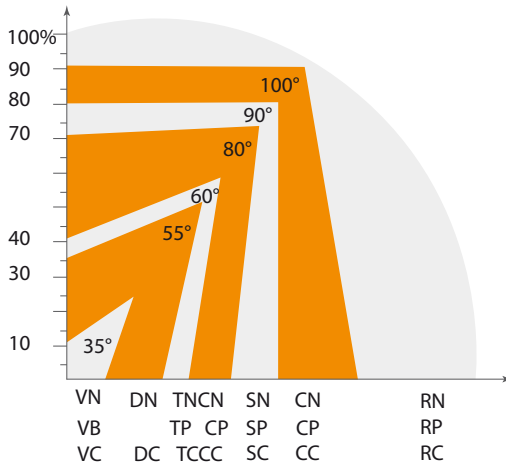

Rigidity in relation to insert thickness

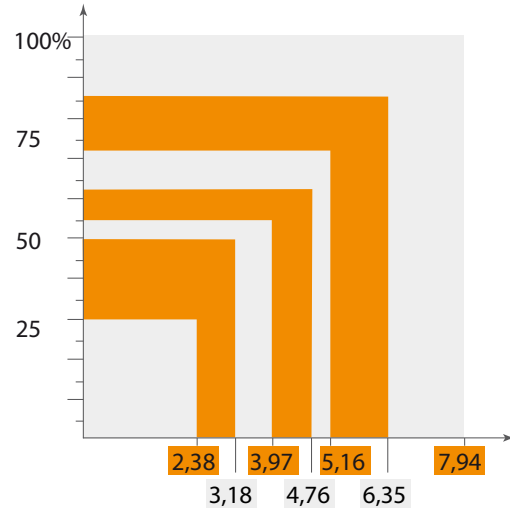

Rigidity in relation to insert radius

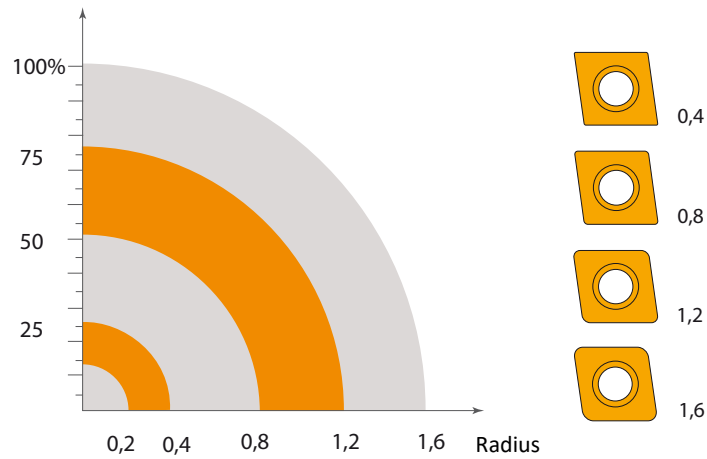

CERAMICS AND THEIR PRACTICAL APPLICATION

Finally, we would like to give some recommendations regarding practical application:

- 1) Burrs at the output of the tool can result in chipped edges and damage the whole insert. It is therefore necessary to bevel the edge to eliminate the burrs first.

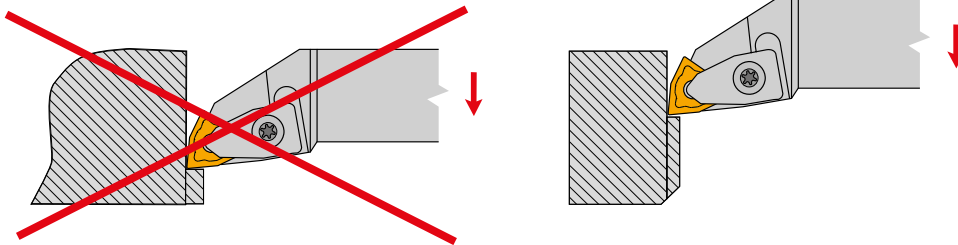

- 2) It is advisable to modify the standard program (adding the material) as this slows down the creation of burrs on the edge, which increases the durability of the edge and also eliminates the need to bevel the edge.

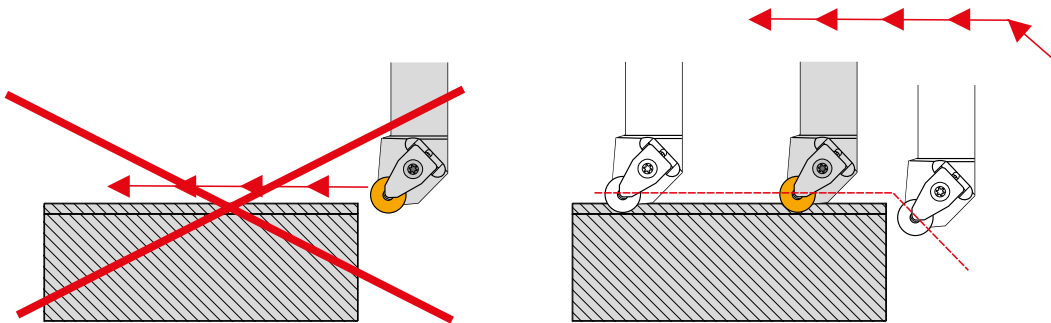

- 3) If there is a risk of problems occurring as a result of tool vibration, it is better to use inserts with a smaller radius to eliminate radial forces.

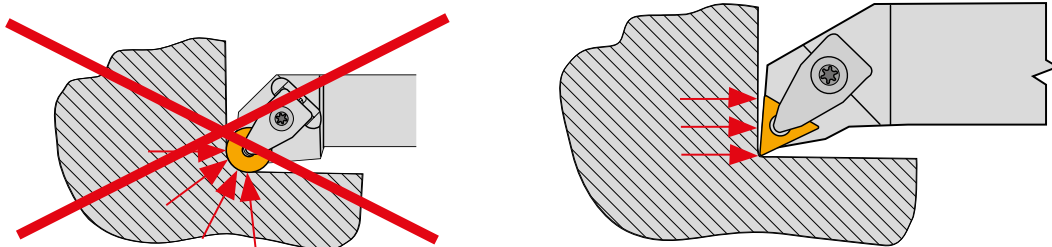



CORRECTION OF X AND Z COORDINATES BY RADIUS AND HOLDER

Correction of X and Z coordinates by radius and holder:

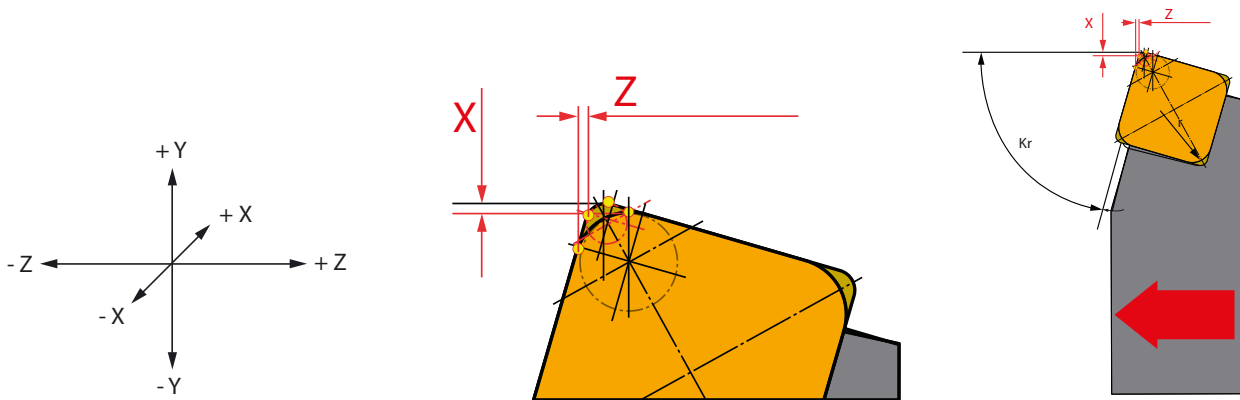

ATTENTION – the data is valid for right-hand holders oriented as shown in picture 19. For internal holders, left-hand holders or other orientations it is necessary to correct or mark +/- (to substitute values X/Z)

Holder		Coordinates	Radius 0,5	Radius 1,0	Radius 1,5				
External holder	CKJNR/L	x	0.443	0.000	-0.433				
		z	-0.050	0.000	0.050				

Holder		Coordinates	Radius 02	Radius 04	Radius 08	Radius 12	Radius 16	Radius 24	Radius 32
External holder	DCLNR/L	x	0.060	0.040	0.000	-0.040	-0.080	-0.160	-0.240
		z	-0.062	-0.042	0.000	0.042	0.083	0.166	0.249
	DDJNR/L	x	0.516	0.347	0.000	-0.329	-0.667	-1.343	-2.019
		z	-0.056	-0.041	0.000	0.022	0.054	0.117	0.180
	DSBNR/L	x	0.252	0.170	0.000	-0.158	-0.322	-0.649	-0.977
		z	0.422	0.280	0.000	-0.285	-0.568	-1.134	-1.700
	DSDNN	x	0.000	0.000	0.000	0.000	0.000	0.000	0.000
		z	0.247	0.165	0.000	-0.165	-0.33	-0.659	-0.989
	DSKNR/L	x	0.134	0.089	0.000	-0.089	-0.178	-0.358	-0.537
		z	-0.167	-0.111	0.000	0.111	0.222	0.444	0.667
	DSSNR/L	x	0.000	0.000	0.000	0.000	0.000	0.000	0.000
		z	0.245	0.162	0.000	-0.167	-0.322	-0.662	-0.992
	DTFNR/L	x	0.426	0.284	0.000	-0.284	-0.569	-1.137	-1.705
		z	0.029	0.019	0.000	-0.019	-0.04	-0.078	-0.117
	DTGNR/L	x	0.437	0.294	0.000	-0.277	-0.562	-1.133	-1.703
		z	0.000	0.000	0.000	0.000	0.000	0.000	0.000
	DVJNR/L	x	0.063	0.042	0.000	-0.042	-0.084	-0.169	-0.253
		z	1.234	0.823	0.000	-0.823	-1.646	-3.291	-4.937
	DVPNR/L	x	0.79	0.527	0.000	-0.527	-1.054	-2.108	-3.161
		z	0.834	0.554	0.000	-0.554	-1.109	-2.217	-3.326
DWLNR/L	x	0.061	0.044	0.000	-0.026	-0.061	-0.131	-0.200	
	z	-0.063	-0.045	0.000	0.027	0.062	0.134	0.206	



CORRECTION OF X AND Z COORDINATES BY RADIUS AND HOLDER

Holder		Coordinates	Radius 02	Radius 04	Radius 08	Radius 12	Radius 16	Radius 24	Radius 32	
Internal holder	DCLNR/L	x	-0.053	-0.035	0.000	0.035	0.070	0.140	0.210	
		z	-0.060	-0.040	0.000	0.040	0.080	0.159	0.239	
	DDUNR/L	x	-0.512	-0.341	0.000	0.0341	0.683	1.365	2.047	
		z	-0.073	-0.049	0.000	0.049	0.097	0.195	0.292	
	DTFNR/L	x	-0.425	-0.289	0.000	0.254	0.526	1.069	1.613	
		z	0.000	0.000	0.000	0.000	0.000	0.000	0.000	
	DVUNR/L	x	1.254	-0.836	0.000	0.836	1.671	3.343	5.014	
		z	-0.129	-0.086	0.000	0.086	0.172	0.344	0.516	
	DWLNR/L	x	-0.053	-0.035	0.000	0.035	0.07	0.14	0.21	
		z	-0.06	-0.04	0.000	0.04	0.08	0.159	0.239	
	External holder	MTJNR/L	x	0.437	0.294	0.000	-0.277	-0.562	-1.133	-1.703
			z	0.000	0.000	0.000	0.000	0.000	0.000	0.000
MVJNR/L		x	1.263	0.847	0.000	-0.819	-1.651	-3.317	-4.982	
		z	-0.075	-0.055	0.000	0.025	0.065	0.146	0.226	
MWLNR/L		x	0.609	0.044	0.000	-0.026	-0.061	-0.131	-0.200	
		z	-0.063	-0.045	0.000	0.027	0.062	0.134	0.206	
PCBNR/L		x	0.045	0.033	0.000	-0.016	-0.040	-0.088	-0.137	
		z	0.128	0.083	0.000	-0.096	-0.185	-0.364	-0.543	
PCKNR/L		x	0.171	0.115	0.000	-0.110	-0.223	-0.448	-0.672	
		z	0.685	0.457	0.000	-0.457	-0.914	-1.827	-2.741	
PCLNR/L		x	0.061	0.044	0.000	-0.026	-0.061	-0.131	-0.200	
		z	-0.063	-0.045	0.000	0.027	0.062	0.134	0.206	
PDJNR/L		x	0.516	0.347	0.000	-0.329	-0.667	-1.343	-2.019	
		z	-0.056	-0.041	0.000	0.022	0.054	0.117	0.180	
PDNNR/L		x	0.699	0.469	0.000	-0.453	-0.915	-1.837	-2.759	
		z	0.524	0.348	0.000	-0.357	-0.710	-1.415	-2.120	
PDXNR/L		x	0.453	0.305	0.000	-0.288	-0.584	-1.177	-1.770	
		z	-0.156	-0.107	0.000	0.088	0.185	0.380	0.575	
PLBNR/L		x	0.137	0.094	0.000	-0.078	-0.163	-0.335	-0.507	
		z	0.153	0.100	0.000	-0.110	-0.220	-0.433	-0.646	
PSBNR/L		x	0.137	0.094	0.000	-0.078	-0.163	-0.335	-0.507	
		z	0.153	0.100	0.000	-0.110	-0.220	-0.433	-0.646	
PSDNN		x	0.252	0.170	0.000	-0.158	-0.322	-0.649	-0.977	
		z	0.422	0.280	0.000	-0.285	-0.568	-1.134	-1.699	
PSKNR/L		x	0.140	0.094	0.000	-0.090	-0.152	-0.366	-0.550	
		z	0.574	0.383	0.000	-0.384	-0.767	-1.533	-2.300	
PSSNR/L		x	0.246	0.164	0.000	-0.164	-0.328	-0.656	-0.983	
		z	0.424	0.283	0.000	-0.283	-0.566	-1.131	-1.697	
PTFNR/L		x	0.000	0.000	0.000	0.000	0.000	0.000	0.000	
		z	-0.411	-0.243	0.000	0.429	0.765	1.437	2.110	
PTGNR/L		x	0.437	0.294	0.000	-0.277	-0.562	-1.133	-1.703	
		z	0.000	0.000	0.000	0.000	0.000	0.000	0.000	
PTTNR/L		x	0.601	0.403	0.000	-0.389	-0.784	-1.575	-2.367	
		z	0.519	0.345	0.000	-0.354	-0.703	-1.401	-2.099	
PWLNR/L		x	0.609	0.044	0.000	-0.026	-0.061	-0.131	-0.200	
		z	-0.063	-0.045	0.000	0.027	0.062	0.134	0.206	
Internal holder	PCLNR/L	x	-0.061	-0.046	0.000	0.012	0.040	0.098	0.156	
		z	-0.062	-0.047	0.000	0.015	0.046	0.160	0.169	
	PDUNR/L	x	-0.500	-0.339	0.000	0.305	0.627	1.271	1.915	
		z	-0.052	-0.040	0.000	0.006	0.029	0.076	0.122	
	PSKNR/L	x	-0.153	-0.097	0.000	0.063	0.143	0.303	0.463	
		z	0.137	0.098	0.000	-0.124	-0.234	-0.456	-0.677	
	PTFNR/L	x	-0.425	-0.289	0.000	0.254	0.526	1.069	1.613	
		z	0.000	0.000	0.000	0.000	0.000	0.000	0.000	
	PWLNR/L	x	-0.060	-0.046	0.000	0.012	0.043	0.098	0.156	
		z	-0.065	-0.049	0.000	0.012	0.040	0.105	0.166	



CORRECTION OF X AND Z COORDINATES BY RADIUS AND HOLDER

Holder		Coordinates	Radius 02	Radius 04	Radius 08	Radius 12	Radius 16	Radius 24	Radius 32
External holder	SCACR/L	x	0.115	0.077	0.000	-0.077	-0.153	-0.307	-0.460
		z	0.000	0.000	0.000	0.000	0.000	0.000	0.000
	SCBCR/L	x	0.042	0.028	0.000	-0.028	-0.055	-0.111	-0.166
		z	0.130	0.087	0.000	-0.087	-0.174	-0.347	-0.521
	SCDCR/L	x	0.000	0.000	0.000	0.000	0.000	0.000	0.000
		z	-0.279	-0.186	0.000	0.186	0.372	0.745	1.117
	SCFCR/L	x	0.000	0.000	0.000	0.000	0.000	0.000	0.000
		z	-0.124	-0.083	0.000	0.083	0.166	0.331	0.497
	SCLCR/L	x	0.060	0.040	0.000	-0.040	-0.080	-0.160	-0.240
		z	-0.062	-0.042	0.000	0.042	0.083	0.166	0.249
	SDJCR/L	x	0.520	0.346	0.000	-0.346	-0.693	-1.386	-2.078
		z	-0.060	-0.040	0.000	0.040	0.080	0.161	0.241
	SDNCN	x	0.699	0.466	0.000	-0.466	-0.933	-1.865	-2.798
		z	0.000	0.000	0.000	0.000	0.000	0.000	0.000
	SEGCR/L	x	0.000	0.000	0.000	0.000	0.000	0.000	0.000
		z	-0.182	-0.121	0.000	0.121	0.243	0.485	0.728
	SSBCR/L	x	0.135	0.090	0.000	-0.090	-0.180	-0.360	-0.539
		z	0.155	0.104	0.000	-0.104	-0.207	-0.414	-0.621
	SSDCN	x	0.249	0.166	0.000	-0.166	-0.331	-0.663	-0.994
		z	0.000	0.000	0.000	0.000	0.000	0.000	0.000
	SSKCR/L	x	-0.376	-0.517	0.000	-1.083	-1.366	-1.931	-2.497
		z	-0.135	-0.090	0.000	0.090	0.180	0.360	0.539
	STCFR/L	x	0.000	0.000	0.000	0.000	0.000	0.000	0.000
		z	-	-	0.000	-	-	-	-
	STJCR/L	x	0.406	0.271	0.000	-0.271	-0.542	-1.084	-1.626
		z	-0.054	-0.036	0.000	0.036	0.071	0.143	-0.214
	SVACR/L	x	00 / 0	01 / -0.107	-	-	-	-	-
		z	00 / 0	01 / -0.107	-	-	-	-	-
	SVGCR/L	x	0.000	0.000	0.000	0.000	0.000	0.000	0.000
		z	-1.303	-0.869	0.000	0.869	1.737	3.475	5.212
	SVHBR/L	x	1.034	0.690	0.000	-0.690	-1.379	-2.759	-4.138
		z	-0.544	-0.363	0.000	0.363	0.726	1.452	2.178
	SVHCR/L	x	1.034	0.690	0.000	-0.690	-1.379	-2.759	-4.138
		z	-0.544	-0.363	0.000	0.363	0.726	1.452	2.178
	SVJBR/L	x	1.269	0.846	0.000	-0.846	-1.692	-3.384	-5.076
		z	-0.099	-0.066	0.000	0.066	0.132	0.263	0.395
	SVJCR/L	x	1.269	0.846	0.000	-0.846	-1.692	-3.384	-5.076
		z	-0.099	-0.066	0.000	0.066	0.132	0.263	0.395
	SVPBR/L	x	0.811	0.541	0.000	-0.541	-1.081	-2.162	-3.244
		z	-0.811	-0.541	0.000	0.541	1.081	2.162	3.244
	SVPBR/L	x	0.811	0.541	0.000	-0.541	-1.081	-2.162	-3.244
		z	-0.811	-0.541	0.000	0.541	1.081	2.162	3.244
	SVVBN	x	1.395	0.930	0.000	-0.930	-1.860	-3.721	-5.581
		z	0.000	0.000	0.000	0.000	0.000	0.000	0.000
	SVVCN	x	1.395	0.930	0.000	-0.930	-1.860	-3.721	-5.581
		z	0.000	0.000	0.000	0.000	0.000	0.000	0.000
	SVXBR/L	x	1.201	0.801	0.000	-0.801	-1.601	-3.202	-4.804
		z	-0.259	-0.173	0.000	0.173	0.345	0.691	1.036
SVXCR/L	x	1.201	0.801	0.000	-0.801	-1.601	-3.202	-4.804	
	z	-0.259	-0.173	0.000	0.173	0.345	0.691	1.036	
SWLCR/L	x	0.060	0.040	0.000	-0.040	-0.080	-0.160	-0.240	
	z	-0.060	-0.040	0.000	0.040	0.080	0.160	0.240	



CORRECTION OF X AND Z COORDINATES BY RADIUS AND HOLDER

Holder	Coordinates	Radius 02	Radius 04	Radius 08	Radius 12	Radius 16	Radius 24	Radius 32	
Internal holder	SCFCR/L	x	-0.420	-0.280	0.000	0.280	0.560	1.121	1.681
		z	0.000	0.000	0.000	0.000	0.000	0.000	0.000
	SCKCR/L	x	-0.040	-0.027	0.000	0.027	0.054	0.108	0.161
		z	0.130	0.087	0.000	-0.087	-0.174	-0.348	0.521
	SCLCR/L	x	-0.058	-0.039	0.000	0.039	0.078	0.155	0.233
		z	-0.062	-0.042	0.000	0.042	0.083	0.166	0.249
	SCXCR/L	x	-0.178	-0.119	0.000	0.119	0.237	0.474	0.711
		z	0.000	0.000	0.000	0.000	0.000	0.000	0.000
	SDQCR/L	x	-0.309	-0.194	0.000	0.206	0.412	0.825	1.237
		z	-0.310	-0.206	0.000	0.268	0.499	0.961	1.423
	SDUCR/L	x	-0.504	-0.336	0.000	0.336	0.672	1.344	2.016
		z	-0.059	-0.039	0.000	0.041	0.082	0.162	0.242
	SDZCR/L	x	-0.520	-0.346	0.000	0.346	0.693	0.139	2.078
		z	0.059	0.039	0.000	-0.041	-0.082	-0.162	-0.242
	SELPR/L	x	-0.126	-0.084	0.000	0.084	0.168	0.337	0.051
		z	-0.066	-0.044	0.000	0.044	0.088	0.176	0.264
	SEUCR/L	x	-0.149	-0.099	0.000	0.099	0.199	0.397	0.596
		z	-0.041	-0.027	0.000	0.027	0.053	0.107	0.160
	SEUPR/L	x	-0.148	-0.099	0.000	0.099	0.198	0.396	0.593
		z	-0.040	-0.027	0.000	0.027	0.053	0.107	0.160
	SEXPR/L	x	-0.384	-0.256	0.000	0.256	0.512	1.024	1.537
		z	0.000	0.000	0.000	0.000	0.000	0.000	0.000
	SSSCR/L	x	-0.249	-0.166	0.000	0.166	0.331	0.663	0.994
		z	0.000	0.000	0.000	0.000	0.000	0.000	0.000
	STFCR/L	x	-0.433	-0.289	0.000	0.289	0.577	1.154	1.731
		z	0.000	0.000	0.000	0.000	0.000	0.000	0.000
	SVLCR/L	x	-1.243	-0.828	0.000	0.828	1.657	3.314	4.971
		z	0.239	0.692	0.000	-0.108	-0.215	-0.430	-0.645
	SVQBR/L	x	-1.027	-0.684	0.000	0.690	1.369	2.738	4.106
		z	-0.545	-0.363	0.000	0.363	0.726	1.452	2.178
	SVQCR/L	x	-1.027	-0.684	0.000	0.690	1.369	2.738	4.106
		z	-0.545	-0.363	0.000	0.363	0.726	1.452	2.178
	SVUBR/L	x	-1.259	-0.840	0.000	0.840	1.679	3.358	5.037
		z	0.099	-0.066	0.000	0.066	0.132	0.263	0.395
	SVUCR/L	x	-1.259	-0.840	0.000	0.840	1.679	3.358	5.037
		z	0.099	-0.066	0.000	0.066	0.132	0.263	0.395
	SVXCR/L	x	-0.917	-0.611	0.000	0.611	1.222	2.445	3.667
		z	-0.696	-0.464	0.000	0.464	0.928	1.856	2.783
	SWLCR/L	x	-0.060	-0.039	0.000	0.039	0.079	0.158	0.237
		z	-0.060	-0.040	0.000	0.040	0.080	0.160	0.240
SWUCR/L	x	-0.080	-0.053	0.000	0.053	0.107	0.213	0.319	
	z	-0.034	-0.024	0.000	0.024	0.049	0.098	0.146	

ATTENTION – the data is valid for right-hand holders oriented as shown in picture 19. For internal holders, left-hand holders or other orientations it is necessary to correct or mark +/- (to substitute values X/Z).

THREADING

The choice of production method is influenced by the workpiece and the machine. Workpiece – external or internal thread, right – or left-hand thread. Machine – right – or left-hand tool. For guidance, you can use table below.

EXTERNAL THREAD, RIGHT-HAND

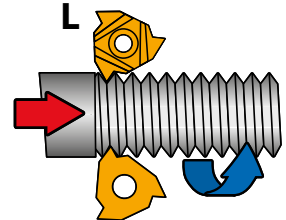
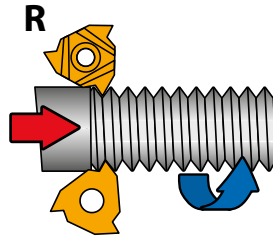
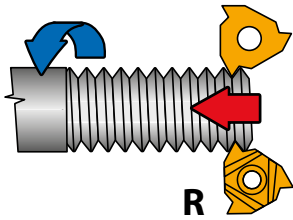

EXTERNAL THREAD, LEFT-HAND

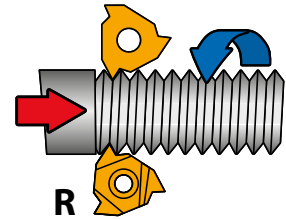
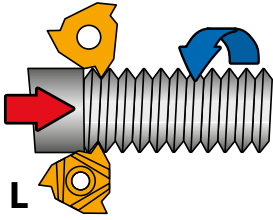
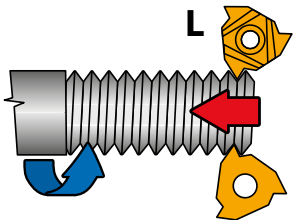

INTERNAL THREAD, RIGHT-HAND

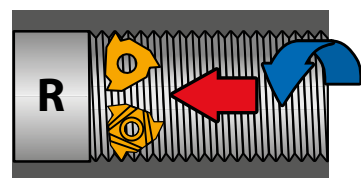
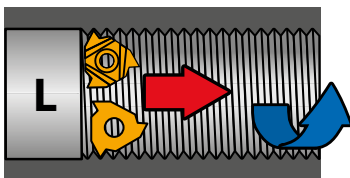

INTERNAL THREAD, LEFT-HAND

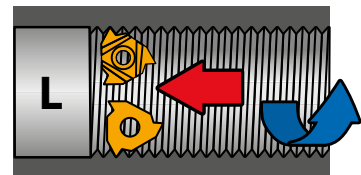
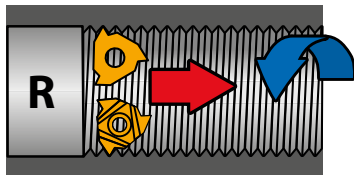

■ Movement of the workpiece

■ Tool movement

L / R Insert design



The following formula can be used to calculate the helix angle:

$$\text{tg } \omega = \frac{p}{d_s \cdot \pi}$$

- ω helix angle [°]
- p pitch [mm]
- d_s pitch diameter [mm]

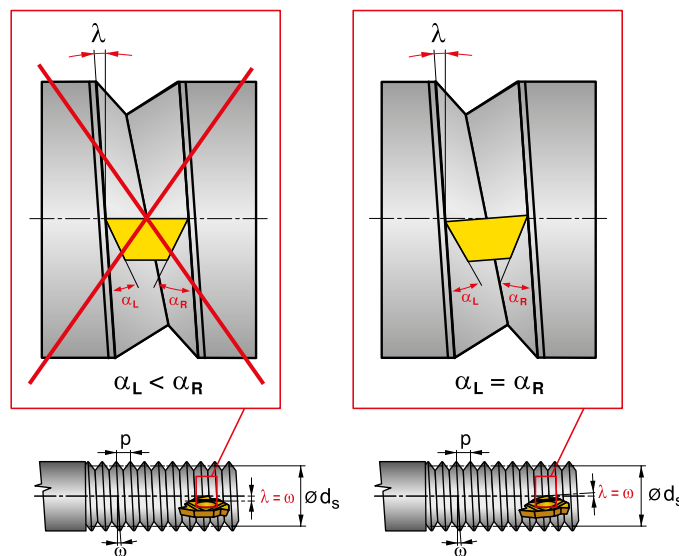

To generate the correct shape on the thread and uniform wear on the insert, the cutting edge helix angle should be equal to the thread lead angle.

Tool holders are usually supplied with a helix angle $\lambda = 1.5^\circ$. A different helix angle can be selected by changing the anvil. Use the following graph (picture 21) or table (table 16) to choose the correct anvil.

Choice of shim

Helix angle λ	Positive					Negative		for grooving inserts TN16... ZZ, TN22... ZZ
	4,5°	3,5°	2,5°	1,5°	0,5°	-0,5°	-1,5°	
Tool holder	Anvil specification							
SER16; SIL16	PE16+4,5	PE16+3,5	PE16+2,5	PE16+1,5	PE16+0,5	PE16-0,5	PE16-1,5	PE16ZZ
SEL16; SIR16	PI16+4,5	PI16+3,5	PI16+2,5	PI16+1,5	PI16+0,5	PI16-0,5	PI16-1,5	PI16ZZ
SER22; SIL22	PE22+4,5	PE22+3,5	PE22+2,5	PE22+1,5	PE22+0,5	PE22-0,5	PE22-1,5	PE22ZZ
SEL22; SIR22	PI22+4,5	PI22+3,5	PI22+2,5	PI22+1,5	PI22+0,5	PI22-0,5	PI22-1,5	PI22ZZ
SER-S22; SIL-S22	PE22S+4,5	PE22S+3,5	PE22S+2,5	PE22S+1,5	PE22S+0,5	PE22S-0,5	PE22S-1,5	-
SEL-S22; SIR-S22	PI22S+4,5	PI22S+3,5	PI22S+2,5	PI22S+1,5	PI22S+0,5	PI22S-0,5	PI22S-1,5	-

Tool holders are usually supplied with a helix angle $\lambda = 1.5^\circ$. A different helix angle can be selected by changing the anvil. Shims for holders SER-S, SIR-S are marked with „S“



Graph for shim selection

Thread pitch TP [mm]

No. of threads / 1"

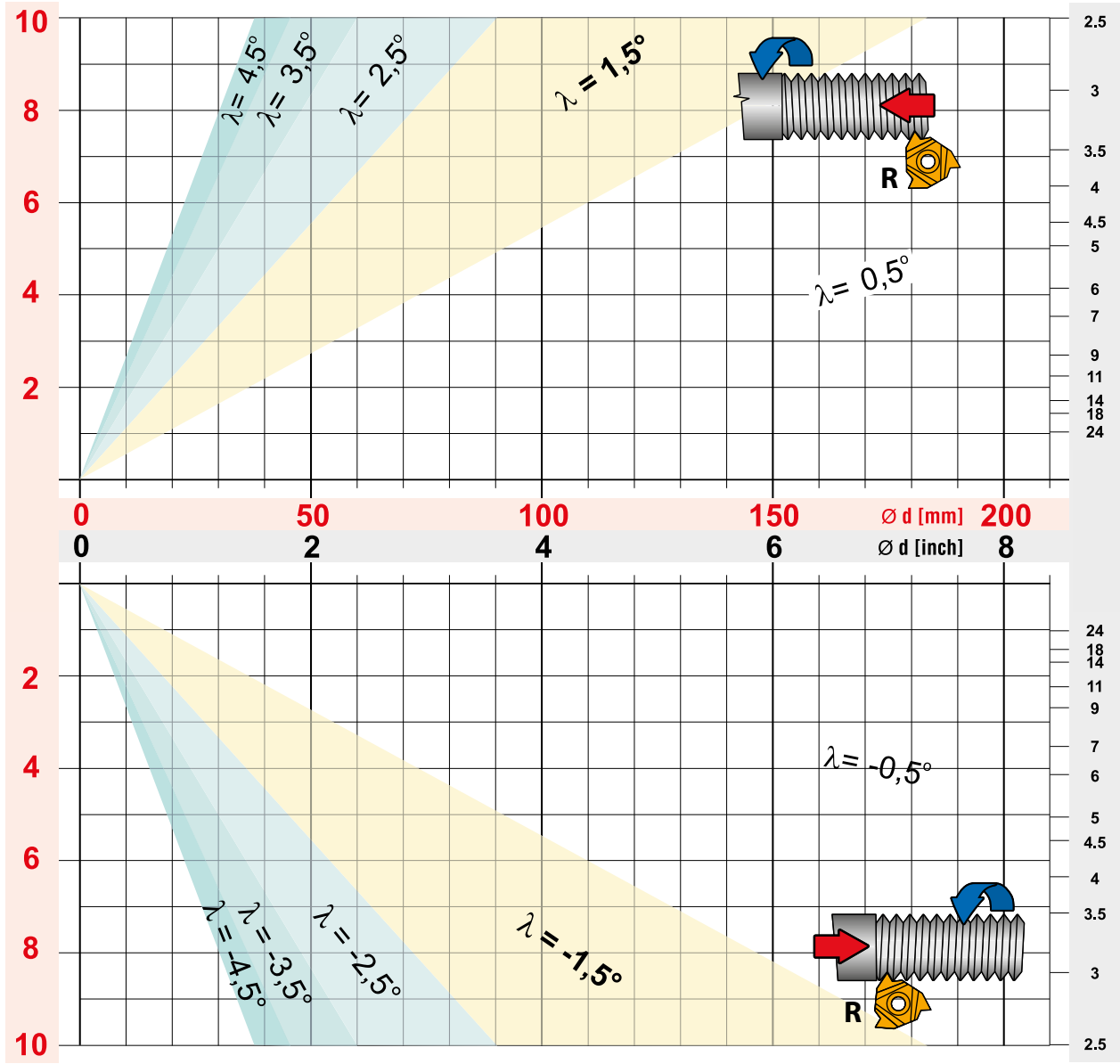

■ Movement of the workpiece

■ Tool movement

L / R Insert design

Infeed method and depth

The choice of infed method is most important for long chipping materials to ensure good chip control.

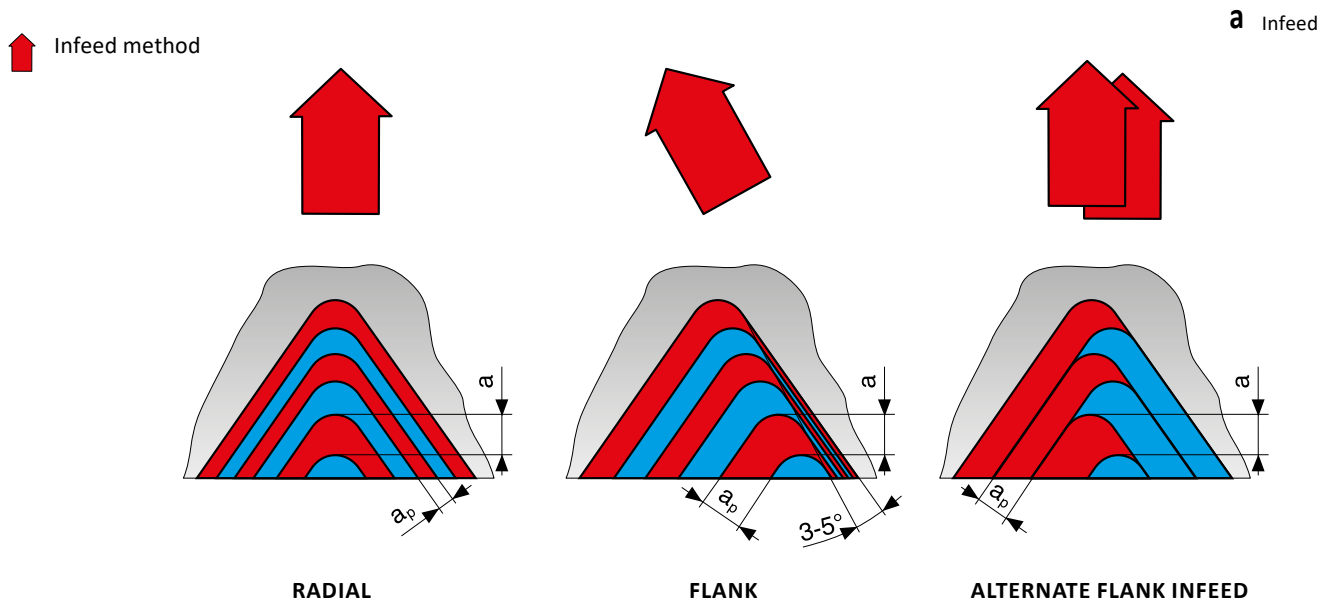

The choice depends on the machine type, the machined material and the pitch.

Radial infed – the most simple and the most used. The infed is perpendicular to the axis of rotation of the workpiece. It contributes to good chip formation and uniform wear on the cutting edge. Suitable for threads with a small pitch ($p < 1.5$ mm). There is a risk of vibration at higher feeds. First choice for working on hard materials (e.g. austenitic stainless steels, steels with low carbon content).

Flank infed – reduces thermal stress on the cutting edge and thereby wear. Good chip control. Suitable for threads with a pitch of $p > 1.5$ mm for TR threads. Flank infed with deviation 3 – 5° eliminates friction on the thread flank.

Alternate flank infed – recommended for coarse threads and materials with poor chip formation. Long tool life. For CNC machines, higher demand on CNC programming.

Infeed method and number of passes depend on the thread pitch. The tables give basic recommendations and apply to all geometries. If the insert fractures, the infed value should be decreased and the number of passes should be increased. The infed depth should not be less than 0.05 mm/pass. On austenitic and soft steels the infed depth per pass should be greater than 0.08 mm.



INFEEED DEPTH

TUBULAR CYLINDRICAL THREAD PROFILE CORRESPONDS WITH W (WHITWORTH 55°)

Thread marking	No. of threads / 1"	Thread pitch P [mm]	Nominal diameter of thread [mm]	Small diameter of thread [mm]	Thread insert marking
G 1/16"	28	0,907	7.723	6.561	TN xxxx280W
G 1/8"			9.728	8.566	
G 1/4"	19	1,337	13.157	11.445	TN xxxx190W
G 3/8"			16.662	14.950	
G 1/2"	14	1,814	20.955	18.631	TN xxxx140W
G 5/8"			22.911	20.587	
G 3/4"			26.441	24.117	
G 7/8"			30.201	27.877	
G 1"	11	2,309	33.249	30.291	TN xxxx110W
G1 1/8"			37.897	34.939	
G1 1/4"			41.910	38.952	
G1 1/2"			47.803	44.845	
G1 3/4"			53.746	50.788	
G 2"			59.614	56.656	
G2 1/4"			65.710	62.752	
G2 1/2"			75.184	72.226	
G2 3/4"			81.534	78.576	
G3"			87.884	84.926	
G3 1/2"			100.330	97.372	
G4"			113.030	110.072	
G4 1/2"			125.730	122.772	
G5"			138.430	135.472	
G5 1/2"			151.130	148.172	
G6"			163.830	160.872	

Example: for right-hand external thread on 1 1/2" tube use thread insert TN 16ER110W; 8030



INFEEED DEPTH

M – metric 60° – external

Number of passes	REDUCE THE CUTTING SPEED PROPORTIONALLY TO INCREASING THE THREAD PITCH														
	Pitch [mm]														
	6.0	5.5	5.0	4.5	4.0	3.5	3.0	2.5	2.0	1.75	1.5	1.25	1.0	0.75	0.50
1	0.46	0.43	0.41	0.37	0.34	0.34	0.28	0.27	0.24	0.22	0.22	0.21	0.18	0.16	0.11
2	0.43	0.40	0.39	0.34	0.32	0.31	0.26	0.24	0.22	0.20	0.20	0.17	0.16	0.14	0.09
3	0.35	0.32	0.32	0.28	0.25	0.25	0.21	0.20	0.18	0.17	0.17	0.14	0.12	0.11	0.07
4	0.30	0.28	0.27	0.24	0.22	0.21	0.18	0.17	0.16	0.14	0.14	0.11	0.11	0.07	0.06
5	0.29	0.26	0.24	0.22	0.20	0.18	0.16	0.15	0.14	0.12	0.12	0.10	0.08		
6	0.26	0.24	0.24	0.22	0.18	0.18	0.15	0.15	0.12	0.10	0.08	0.08			
7	0.24	0.21	0.22	0.20	0.17	0.16	0.14	0.12	0.11	0.10					
8	0.23	0.20	0.20	0.18	0.15	0.15	0.13	0.11	0.08	0.08					
9	0.22	0.19	0.19	0.17	0.14	0.14	0.12	0.11							
10	0.19	0.18	0.18	0.16	0.13	0.12	0.11	0.08							
11	0.18	0.17	0.16	0.14	0.12	0.11	0.10								
12	0.16	0.15	0.15	0.13	0.12	0.08	0.08								
13	0.15	0.14	0.12	0.12	0.11										
14	0.13	0.13	0.10	0.10	0.08										
15	0.13	0.12													
16	0.10	0.10													
Total infeed depth	3.83	3.52	3.19	2.87	2.53	2.23	1.92	1.60	1.25	1.13	0.93	0.81	0.65	0.48	0.33

M – Metric 60° – internal

Number of passes	REDUCE THE CUTTING SPEED PROPORTIONALLY TO INCREASING THE THREAD PITCH														
	Pitch [mm]														
	6.0	5.5	5.0	4.5	4.0	3.5	3.0	2.5	2.0	1.75	1.5	1.25	1.0	0.75	0.50
1	0.46	0.43	0.42	0.37	0.34	0.32	0.28	0.26	0.23	0.22	0.20	0.17	0.17	0.16	0.10
2	0.43	0.40	0.40	0.34	0.31	0.30	0.26	0.25	0.21	0.20	0.18	0.17	0.15	0.13	0.08
3	0.35	0.33	0.32	0.28	0.24	0.24	0.21	0.18	0.17	0.15	0.15	0.14	0.11	0.10	0.07
4	0.30	0.26	0.26	0.23	0.21	0.19	0.16	0.15	0.15	0.13	0.13	0.10	0.09	0.07	0.06
5	0.26	0.22	0.22	0.21	0.18	0.17	0.14	0.13	0.12	0.10	0.11	0.09	0.08		
6	0.22	0.20	0.20	0.19	0.15	0.15	0.13	0.12	0.11	0.09	0.08	0.08			
7	0.20	0.18	0.17	0.16	0.14	0.14	0.12	0.11	0.10	0.08					
8	0.19	0.17	0.16	0.15	0.13	0.13	0.11	0.10	0.08	0.08					
9	0.18	0.16	0.16	0.14	0.12	0.12	0.10	0.10							
10	0.16	0.15	0.15	0.13	0.12	0.11	0.10	0.08							
11	0.15	0.14	0.14	0.12	0.11	0.10	0.09								
12	0.15	0.14	0.14	0.12	0.10	0.08	0.08								
13	0.14	0.13	0.12	0.11	0.10										
14	0.13	0.12	0.10	0.10	0.08										
15	0.12	0.12													
16	0.10	0.10													
Total infeed depth	3.54	3.25	2.96	2.65	2.33	2.05	1.78	1.48	1.17	1.05	0.85	0.75	0.60	0.46	0.31



INFEEED DEPTH

W – Whitworth 55° – external and internal

Number of passes	REDUCE THE CUTTING SPEED PROPORTIONALLY TO INCREASING THE THREAD PITCH																
	Pitch [no of thread/inch]																
	4	4.5	5	6	7	8	9	10	11	12	14	16	18	19	20	26	28
1	0.49	0.46	0.45	0.38	0.37	0.32	0.30	0.29	0.28	0.28	0.24	0.24	0.23	0.22	0.21	0.19	0.18
2	0.46	0.43	0.43	0.36	0.35	0.30	0.28	0.27	0.26	0.26	0.22	0.22	0.22	0.22	0.21	0.18	0.17
3	0.38	0.38	0.38	0.30	0.29	0.24	0.23	0.22	0.22	0.22	0.18	0.19	0.19	0.18	0.17	0.15	0.14
4	0.36	0.33	0.32	0.26	0.25	0.21	0.20	0.19	0.19	0.18	0.15	0.16	0.16	0.14	0.14	0.12	0.12
5	0.34	0.29	0.28	0.22	0.22	0.19	0.18	0.17	0.16	0.16	0.13	0.13	0.13	0.12	0.11	0.08	0.08
6	0.31	0.25	0.25	0.21	0.19	0.17	0.15	0.15	0.14	0.14	0.11	0.11	0.08	0.08	0.08		
7	0.29	0.24	0.22	0.19	0.18	0.15	0.14	0.14	0.13	0.13	0.09	0.08					
8	0.27	0.22	0.20	0.17	0.16	0.14	0.13	0.13	0.12	0.08	0.08						
9	0.24	0.20	0.19	0.16	0.15	0.13	0.12	0.12	0.08								
10	0.22	0.18	0.18	0.15	0.14	0.12	0.12	0.08									
11	0.20	0.17	0.17	0.14	0.12	0.12	0.08										
12	0.19	0.16	0.15	0.14	0.08	0.08											
13	0.17	0.15	0.12	0.12													
14	0.15	0.14	0.10	0.10													
15	0.12	0.12															
16	0.10	0.10															
Total infeed depth	4.29	3.82	3.44	2.90	2.50	2.17	1.93	1.76	1.58	1.45	1.20	1.13	1.01	0.96	0.92	0.72	0.69

UN – UN 60° – external

Number of passes	REDUCE THE CUTTING SPEED PROPORTIONALLY TO INCREASING THE THREAD PITCH																	
	Pitch [no of thread/inch]																	
	4	4.5	5	6	7	8	9	10	11	12	13	14	16	18	20	24	28	32
1	0.47	0.45	0.43	0.36	0.35	0.30	0.28	0.27	0.27	0.27	0.25	0.23	0.22	0.23	0.20	0.19	0.17	0.17
2	0.44	0.41	0.40	0.34	0.33	0.28	0.26	0.26	0.25	0.26	0.24	0.22	0.21	0.21	0.19	0.17	0.15	0.15
3	0.40	0.39	0.36	0.27	0.26	0.25	0.21	0.20	0.20	0.20	0.18	0.17	0.16	0.16	0.15	0.14	0.11	0.13
4	0.36	0.31	0.31	0.23	0.22	0.21	0.20	0.17	0.19	0.18	0.17	0.15	0.14	0.14	0.12	0.12	0.09	0.08
5	0.32	0.26	0.26	0.22	0.21	0.18	0.17	0.16	0.16	0.15	0.14	0.13	0.13	0.12	0.10	0.08	0.08	
6	0.27	0.23	0.23	0.20	0.19	0.16	0.15	0.15	0.14	0.13	0.12	0.11	0.11	0.08	0.08			
7	0.25	0.21	0.20	0.18	0.17	0.14	0.14	0.14	0.12	0.12	0.11	0.10	0.08					
8	0.23	0.20	0.19	0.16	0.15	0.13	0.12	0.12	0.11	0.08	0.08	0.08						
9	0.22	0.18	0.19	0.15	0.14	0.12	0.12	0.11	0.08									
10	0.21	0.17	0.18	0.14	0.12	0.12	0.11	0.08										
11	0.19	0.16	0.17	0.13	0.11	0.11	0.08											
12	0.18	0.15	0.15	0.12	0.08	0.08												
13	0.16	0.14	0.12	0.11														
14	0.15	0.14	0.10	0.10														
15	0.12	0.12																
16	0.10	0.10																
Total infeed depth	4.07	3.62	3.29	2.71	2.33	2.08	1.84	1.66	1.52	1.39	1.29	1.19	1.05	0.94	0.84	0.70	0.60	0.53



INFEEED DEPTH

UN – UN 60° – internal

Number of passes	REDUCE THE CUTTING SPEED PROPORTIONALLY TO INCREASING THE THREAD PITCH																	
	Pitch [no of thread/inch]																	
	4	4.5	5	6	7	8	9	10	11	12	13	14	16	18	20	24	28	32
1	0.44	0.41	0.42	0.35	0.34	0.30	0.28	0.27	0.27	0.27	0.25	0.23	0.22	0.23	0.20	0.18	0.17	0.17
2	0.41	0.38	0.38	0.33	0.32	0.28	0.26	0.25	0.23	0.23	0.20	0.18	0.18	0.17	0.16	0.15	0.14	0.14
3	0.39	0.34	0.33	0.25	0.24	0.22	0.19	0.18	0.18	0.18	0.15	0.14	0.14	0.14	0.13	0.13	0.09	0.10
4	0.33	0.28	0.27	0.21	0.21	0.18	0.16	0.15	0.15	0.15	0.13	0.13	0.12	0.12	0.10	0.10	0.08	0.08
5	0.28	0.23	0.23	0.18	0.17	0.15	0.14	0.13	0.13	0.13	0.12	0.11	0.10	0.10	0.09	0.08	0.08	
6	0.24	0.20	0.20	0.16	0.15	0.13	0.13	0.12	0.11	0.11	0.11	0.10	0.09	0.08	0.08			
7	0.22	0.19	0.18	0.15	0.14	0.12	0.12	0.11	0.11	0.10	0.10	0.09	0.08					
8	0.21	0.18	0.17	0.14	0.13	0.11	0.11	0.10	0.10	0.08	0.08	0.08						
9	0.20	0.17	0.16	0.13	0.12	0.11	0.10	0.10	0.08									
10	0.18	0.16	0.15	0.12	0.12	0.10	0.09	0.08										
11	0.17	0.15	0.14	0.12	0.11	0.10	0.08											
12	0.16	0.14	0.14	0.11	0.08	0.08												
13	0.15	0.14	0.12	0.11														
14	0.14	0.13	0.10	0.10														
15	0.12	0.12																
16	0.10	0.10																
Total infeed depth	3.74	3.32	2.99	2.46	2.13	1.88	1.66	1.49	1.36	1.25	1.14	1.06	0.93	0.84	0.76	0.64	0.56	0.49

NPT 60° – internal and external

Number of passes	REDUCE THE CUTTING SPEED PROPORTIONALLY TO INCREASING THE THREAD PITCH				
	Pitch [no of thread/inch]				
	8	11.5	14	18	27
1	0.28	0.25	0.24	0.22	0.19
2	0.25	0.22	0.22	0.18	0.15
3	0.22	0.18	0.17	0.15	0.13
4	0.19	0.16	0.15	0.14	0.11
5	0.18	0.16	0.14	0.13	0.09
6	0.18	0.14	0.13	0.12	0.08
7	0.17	0.14	0.12	0.10	
8	0.17	0.12	0.10	0.08	
9	0.16	0.12	0.10		
10	0.16	0.10	0.08		
11	0.14	0.09			
12	0.13	0.08			
13	0.12				
14	0.11				
15	0.08				
Total infeed depth	2.54	1.76	1.45	1.12	0.75



INFEEED DEPTH

RD – RD 30° – external

Number of passes	REDUCE THE CUTTING SPEED PROPORTIONALLY TO INCREASING THE THREAD PITCH			
	Pitch [no of thread/inch]			
	4	6	8	10
1	0.44	0.33	0.29	0.26
2	0.40	0.29	0.26	0.25
3	0.34	0.25	0.21	0.23
4	0.32	0.23	0.19	0.20
5	0.28	0.20	0.18	0.16
6	0.26	0.18	0.16	0.12
7	0.24	0.16	0.14	0.10
8	0.22	0.15	0.12	0.08
9	0.20	0.14	0.10	
10	0.19	0.12	0.08	
11	0.17	0.10		
12	0.15	0.08		
13	0.12			
14	0.10			
Total infeed depth	3.43	2.23	1.73	1.40

RD – RD 30° – internal

Number of passes	REDUCE THE CUTTING SPEED PROPORTIONALLY TO INCREASING THE THREAD PITCH			
	Pitch [no of thread/inch]			
	4	6	8	10
1	0.46	0.38	0.26	0.27
2	0.43	0.34	0.22	0.26
3	0.40	0.30	0.21	0.25
4	0.35	0.25	0.19	0.22
5	0.30	0.21	0.18	0.18
6	0.26	0.19	0.16	0.13
7	0.24	0.17	0.14	0.10
8	0.22	0.16	0.12	0.08
9	0.20	0.14	0.10	
10	0.19	0.12	0.08	
11	0.17	0.10		
12	0.15	0.08		
13	0.12			
14	0.10			
Total infeed depth	3.59	2.44	1.66	1.49



INFEEED DEPTH

TR 30° internal

Number of passes	REDUCE THE CUTTING SPEED PROPORTIONALLY TO INCREASING THE THREAD PITCH											
	Pitch [mm]											
	14,0	12,0	10,0	9,0	8,0	7,0	6,0	5,0	4,0	3,0	2,0	1,5
1	0.40	0.38	0.38	0.38	0.37	0.37	0.37	0.34	0.31	0.27	0.25	0.23
2	0.37	0.36	0.36	0.35	0.35	0.34	0.35	0.33	0.28	0.25	0.24	0.22
3	0.36	0.34	0.34	0.34	0.34	0.33	0.32	0.27	0.24	0.21	0.20	0.18
4	0.36	0.34	0.34	0.33	0.33	0.31	0.29	0.25	0.20	0.17	0.17	0.14
5	0.35	0.32	0.32	0.31	0.31	0.29	0.27	0.23	0.19	0.15	0.14	0.12
6	0.35	0.32	0.32	0.30	0.29	0.26	0.25	0.21	0.18	0.13	0.13	0.08
7	0.34	0.30	0.31	0.29	0.28	0.26	0.23	0.20	0.16	0.13	0.11	
8	0.34	0.30	0.29	0.28	0.27	0.26	0.22	0.20	0.15	0.12	0.09	
9	0.34	0.30	0.28	0.26	0.25	0.24	0.22	0.18	0.15	0.12		
10	0.33	0.29	0.27	0.25	0.24	0.23	0.20	0.16	0.15	0.10		
11	0.33	0.29	0.25	0.24	0.23	0.22	0.18	0.15	0.14	0.10		
12	0.32	0.29	0.24	0.23	0.21	0.22	0.17	0.14	0.13	0.08		
13	0.32	0.28	0.23	0.22	0.20	0.20	0.17	0.13	0.10			
14	0.31	0.27	0.22	0.21	0.19	0.19	0.16	0.10				
15	0.31	0.25	0.22	0.21	0.19	0.17	0.14					
16	0.30	0.25	0.20	0.19	0.18	0.16	0.12					
17	0.30	0.24	0.19	0.18	0.17	0.12						
18	0.29	0.22	0.18	0.16	0.15							
19	0.28	0.20	0.17	0.15	0.13							
20	0.27	0.20	0.16	0.15								
21	0.23	0.19	0.15	0.13								
22	0.23	0.18	0.15									
23	0.21	0.17	0.13									
24	0.19	0.16										
25	0.17	0.15										
26	0.16	0.13										
27	0.16											
28	0.15											
29	0.13											
Total infeed depth	8.2	6.72	5.7	5.16	4.68	4.17	3.66	2.89	2.38	1.83	1.33	0.97



INFEEED DEPTH

TR – TR 30° – internal

Number of passes	REDUCE THE CUTTING SPEED PROPORTIONALLY TO INCREASING THE THREAD PITCH											
	Pitch [mm]											
	14,0	12,0	10,0	9,0	8,0	7,0	6,0	5,0	4,0	3,0	2,0	1,5
1	0.40	0.38	0.38	0.38	0.37	0.37	0.37	0.34	0.31	0.27	0.25	0.23
2	0.37	0.36	0.36	0.35	0.35	0.34	0.34	0.33	0.28	0.25	0.24	0.22
3	0.36	0.34	0.34	0.34	0.34	0.33	0.32	0.27	0.24	0.22	0.21	0.19
4	0.36	0.34	0.34	0.33	0.33	0.31	0.29	0.25	0.20	0.17	0.17	0.14
5	0.35	0.32	0.32	0.31	0.31	0.29	0.27	0.23	0.19	0.15	0.14	0.12
6	0.35	0.32	0.32	0.31	0.29	0.26	0.25	0.21	0.18	0.14	0.13	0.08
7	0.34	0.30	0.31	0.29	0.28	0.26	0.23	0.20	0.16	0.13	0.11	
8	0.34	0.30	0.29	0.29	0.27	0.26	0.22	0.20	0.15	0.12	0.09	
9	0.34	0.30	0.28	0.26	0.25	0.24	0.22	0.18	0.15	0.12		
10	0.33	0.29	0.27	0.25	0.24	0.23	0.20	0.16	0.15	0.10		
11	0.33	0.29	0.25	0.24	0.23	0.22	0.18	0.15	0.14	0.10		
12	0.32	0.28	0.24	0.23	0.21	0.22	0.17	0.14	0.13	0.08		
13	0.32	0.28	0.23	0.22	0.20	0.20	0.17	0.13	0.10			
14	0.31	0.27	0.22	0.21	0.19	0.19	0.16	0.10				
15	0.31	0.25	0.22	0.21	0.19	0.17	0.14					
16	0.30	0.25	0.20	0.20	0.18	0.16	0.12					
17	0.30	0.24	0.19	0.18	0.17	0.12						
18	0.29	0.22	0.18	0.16	0.15							
19	0.28	0.20	0.17	0.15	0.13							
20	0.27	0.20	0.16	0.15								
21	0.27	0.19	0.15	0.13								
22	0.23	0.18	0.15									
23	0.23	0.17	0.13									
24	0.21	0.16										
25	0.19	0.15										
26	0.17	0.13										
27	0.16											
28	0.16											
29	0.15											
30	0.13											
Total infeed depth	8.47	6.71	5.7	5.19	4.68	4.17	3.65	2.89	2.38	1.85	1.34	0.98

BSPT 55° – internal and external

Number of passes	REDUCE THE CUTTING SPEED PROPORTIONALLY TO INCREASING THE THREAD PITCH			
	Pitch [no of thread/inch]			
	11	14	19	28
1	0.22	0.19	0.19	0.15
2	0.21	0.18	0.18	0.14
3	0.20	0.17	0.17	0.13
4	0.19	0.16	0.15	0.12
5	0.18	0.15	0.13	0.08
6	0.16	0.14	0.08	
7	0.15	0.12		
8	0.13	0.08		
9	0.08			
Total infeed depth	1.52	1.19	0.90	0.62



INFEEED DEPTH

ACME – ACME 29° – external

Number of passes	REDUCE THE CUTTING SPEED PROPORTIONALLY TO INCREASING THE THREAD PITCH							
	Pitch [no of thread/inch]							
	4	5	6	8	10	12	14	16
1	0.37	0.34	0.32	0.29	0.27	0.25	0.22	0.23
2	0.34	0.32	0.28	0.25	0.23	0.22	0.20	0.21
3	0.30	0.25	0.23	0.21	0.20	0.17	0.18	0.18
4	0.27	0.23	0.21	0.17	0.18	0.14	0.15	0.14
5	0.25	0.22	0.18	0.15	0.14	0.13	0.13	0.12
6	0.24	0.20	0.18	0.13	0.12	0.12	0.11	0.08
7	0.21	0.19	0.16	0.13	0.12	0.10	0.08	
8	0.20	0.19	0.16	0.12	0.11	0.09		
9	0.20	0.18	0.16	0.12	0.11			
10	0.18	0.16	0.15	0.11	0.09			
11	0.17	0.15	0.14	0.11				
12	0.16	0.14	0.13	0.09				
13	0.16	0.13	0.11					
14	0.15	0.11						
15	0.14							
16	0.12							
Total infeed depth	3.46	2.83	2.41	1.88	1.57	1.22	1.07	0.96

ACME – ACME 29° – internal

Number of passes	REDUCE THE CUTTING SPEED PROPORTIONALLY TO INCREASING THE THREAD PITCH							
	Pitch [no of thread/inch]							
	4	5	6	8	10	12	14	16
1	0.37	0.34	0.32	0.29	0.27	0.25	0.22	0.23
2	0.33	0.31	0.27	0.25	0.23	0.22	0.20	0.21
3	0.30	0.25	0.23	0.21	0.20	0.17	0.18	0.17
4	0.27	0.23	0.20	0.17	0.18	0.15	0.15	0.14
5	0.25	0.22	0.18	0.15	0.15	0.13	0.13	0.12
6	0.23	0.20	0.18	0.14	0.12	0.12	0.11	0.08
7	0.21	0.19	0.16	0.13	0.12	0.10	0.08	
8	0.20	0.19	0.15	0.12	0.11	0.09		
9	0.20	0.17	0.15	0.12	0.11			
10	0.18	0.16	0.15	0.12	0.09			
11	0.17	0.15	0.14	0.11				
12	0.16	0.14	0.13	0.09				
13	0.16	0.13	0.11					
14	0.15	0.11						
15	0.14							
16	0.12							
Total infeed dept	3.44	2.78	2.38	1.90	1.59	1.23	1.07	0.95



RECESSES, PARTING AND COPY TURNING

Recesses, parting and copy turning.

Pramet offers a comprehensive range of tools for turning shallow and deep recesses, both radially and axially (face grooving). Circular/copy profile turning can also be performed through side cutting.

Recommendation for practical usage:

The procedure for turning a recess (deepening and widening) is shown in the following illustration.

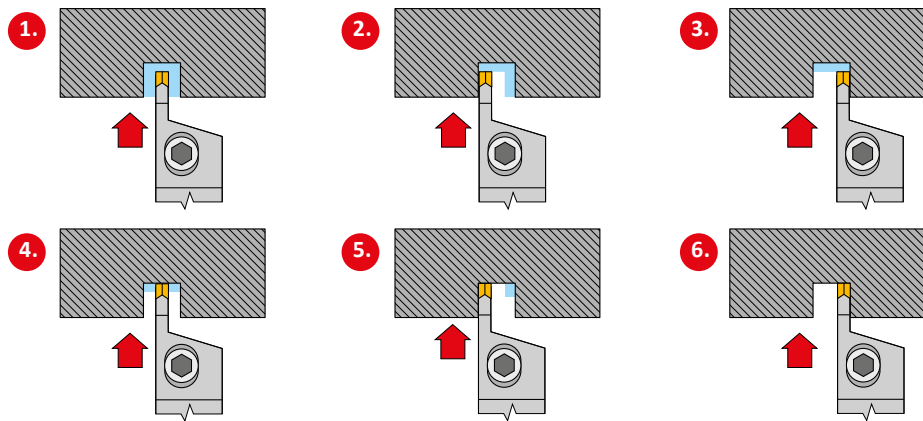

Note: To create a flat seating surface, use insert type **GL** with chip breaker **GM** or **LCMF** with chipbreaker **F**. The outboard radial grooving passes should overlap the central pass by two times the insert corner radius.

When machining a wide recess, follow the procedure shown in the following illustration.

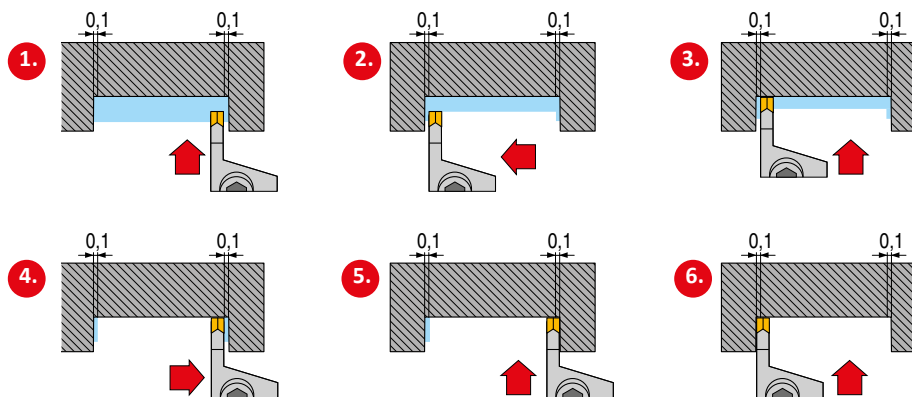

Note: Use the cutting insert **LCMF** with chip breaker **M**. You must consider the tool's deformation "y":

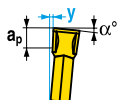

– for $f=0,15$ mm/rev;	$a_p = 3$ mm	$y = 0,07$ mm
– for $f=0,25$ mm/rev;	$a_p = 3$ mm	$y = 0,08$ mm
– for $f=0,35$ mm/rev;	$a_p = 3$ mm	$y = 0,10$ mm



RECESSES, PARTING AND COPY TURNING

When opening up or deepening a contour using side turning, use the procedure shown in the following illustration.

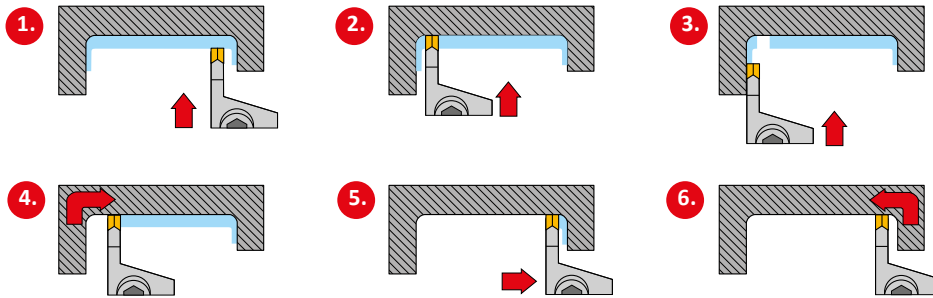

Roughing of contour (insert with round cutting edge)



Finishing of contour (insert with round cutting edge)

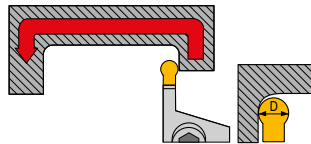

D [mm]	a_p [mm]
3	0.15
4	0.20
5	0.22
6	0.25
8	0.40



TURNING OF SLENDER SHAFTS AND INTERNAL TURNING (BORING) OF DEEP HOLES

When copy turning using indexable inserts with a round cutting edge, the maximum depth of cut is 50% of the diameter of the insert. Choose the tool holder with the maximum cross-section and minimum tool overhang to eliminate vibrations.

The longitudinal axis of the cutting insert must be perpendicular to the axis of rotation of the workpiece (at radial recesses).

The cutting edge must be on centerline within a tolerance of $\pm 0,1$ mm

Coolant must be applied directly onto the cutting edge, and onto the support area of the tool holder under the insert cutting edge, in sufficient quantities to guarantee effective cooling of the insert.

When face grooving it is necessary to select a tool holder with the correct range of diameters for the groove to be machined. The tool must be set parallel to the axis of rotation of the workpiece (perpendicular to the face of the groove). Otherwise there is a risk of rubbing against the wall(s) of the groove during machining.

In the event of the tool rubbing against the outer wall of the groove, it may be necessary to raise the cutting edge above centre (see example A in picture 29).

When face grooving, the tool must be set to be perpendicular to the face of the workpiece with high accuracy, otherwise the side of the tool will rub against the groove being created.

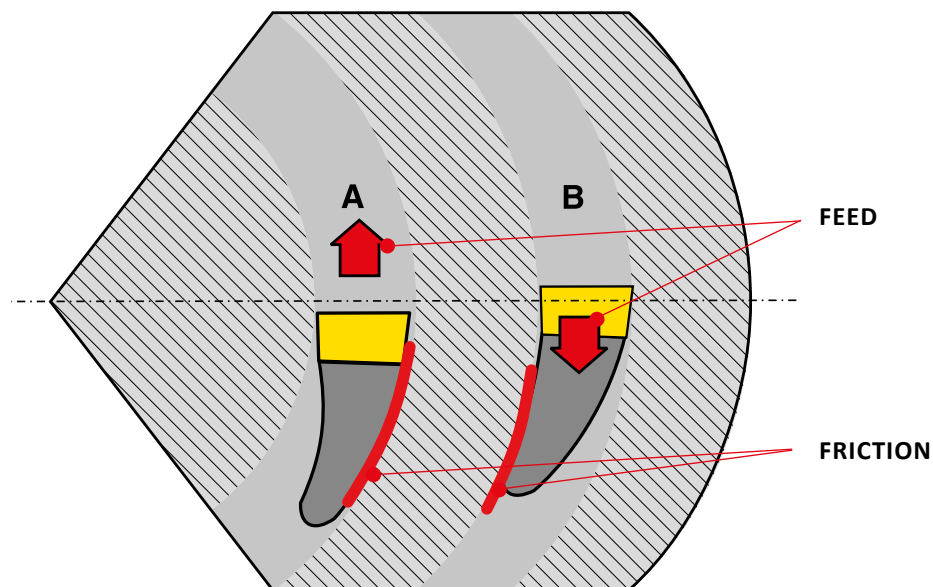







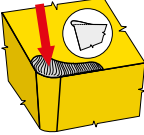
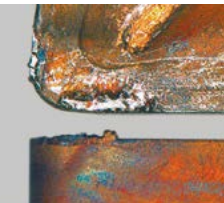

Using effective coolant, applied directly to the cutting edge in sufficient quantities, is very important. Cooling reduces the temperature of the cutting edge and also the lower part of the tool holder, in which the cutting insert is seated.









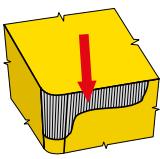
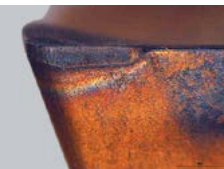

TYPES OF WEAR ON TURNING INSERTS







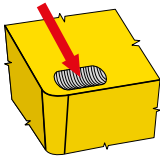
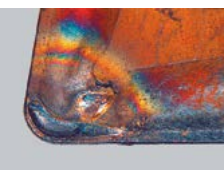

BUILT-UP EDGE

 		It has no influence
		++ Any coating (decisive factor is anti-adhesion effect)
		↑ The higher the feed rate the less probability of built-up edge creation.
		↓ ↑ Change (generally increase) the cutting speed.
		It has no influence
		↓ ↑ Use more positive geometry (built up edge is not created when the rake angle is more than 40°)
		- Use a coolant with more effective anti-sticking properties (or no coolant at all)

FLANK WEAR

 		↑ Use a more wear resistant substrate (s)
		++ Any coating (decisive factor is oxidation resistance – $\alpha \text{Al}_2\text{O}_3$)
		↑ Feed has influence on shape and position of groove
		↓ Decrease cutting speed
		↑ Minimal effect
		+ Use another (more positive) cutting geometry
		Use coolant or increase its intensity

CRATERING

 		↑ Use a more wear resistant substrate (s)
		++ Any coating (decisive factor is thermal resistance – $\alpha \text{Al}_2\text{O}_3$)
		↑ Feed has influence on shape and position of crater
		↓ Decrease cutting speed
		↓ Minimal effect
		↑ Use more positive cutting geometry
		++ Use coolant or increase its intensity



TYPES OF WEAR ON TURNING INSERTS

OXIDATION GROOVE ON THE MINOR EDGE

		↑	Use a more wear resistant substrate (h)
		++	Any coating (decisive factor is hardness – tic, ticn)
		↓	Increase feed (especially if it is under 0.1 Mm)
		↓	Decrease cutting speed
		↓	It has no influence
		↑	Increase the clearance angle
		++	Use a coolant or increase its intensity

PLASTIC DEFORMATION

		↑	Use a more wear resistant grade (decisive factor is content of co)
		+	Any coating (decisive factor is friction)
		↓	Decrease feed rate
		↓	Decrease cutting speed
		↓	Minimal effect
		↑	Use another (more positive) cutting geometry
		++	Use coolant or increase its intensity







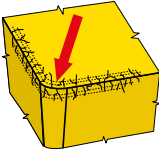

SIDE FLANK NOTCH – REMEDY

		↑ ↓	It depends on the character of the damage (abrasive – use more wear resistant substrate; breaking – use tougher substrate)
		++	Cvd coating (decisive factor is oxidation resistance – α al ₂ o ₃)
		↓	Feed has influence on intensity, but less than the cutting speed
		↓	Decrease cutting speed
		↑ ↓	Use unequal depth of cut
		↓	Use less positive cutting geometry
		+	Use coolant or increase its intensity





TYPES OF WEAR ON TURNING INSERTS

CREATION OF RACK CRACKS

 		↓ (H) grain has a great influence
		++ Pvd coating recommended
		↓ Feed has influence on intensity, but less than the cutting speed
		↓ Lower speed means lower temperature
		It has no influence
		↓ Use less positive cutting geometry
		- - - No coolant (it is possible to use air to remove chips from cutting area)

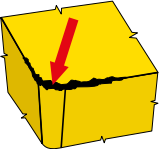
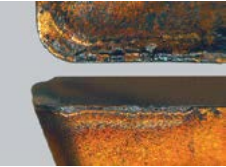
BRITTLE CRACKS AT THE CUTTING EDGE

 		↓ (H) grain has a great influence
		+ Pvd coating recommended
		↓ Good swarf control is very important
		↑ ↓ It is about swarf control and vibration
		↓ Reduces the force load (important for machining with long overhangs)
		↓ Use less positive cutting geometry
		It has no influence
		Use better working conditions, reduce feed rate until insert is in cut







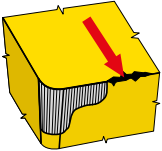

INSERT FRACTURE

 		↓ (H) grain has a great influence
		+ Pvd coating recommended
		↓ Reduces the force load
		↑ ↓ It is about swarf control and vibration
		↓ Reduces the force load
		↓ Use less positive cutting geometry
		It has no influence
		Use better working conditions



TYPES OF WEAR ON TURNING INSERTS

FAILURE OF CUTTING EDGE

 		↓	(H) grain has a great influence
		+	Pvd coating recommended
		↑ ↓	Good swarf control is very important
		↑ ↓	It is about swarf control and vibration
		↑ ↓	Good swarf control is very important
		↓	Use less positive cutting geometry
			It has no influence
			Problem is poor swarf control or evacuation of chips



POOR SURFACE QUALITY

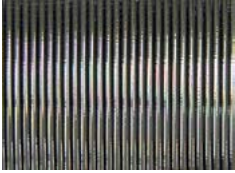

Description and cause:

Numerous causes depending on the workpiece material, cutting conditions (feed rate and cutting speed), the condition of the cutting edge, the extent and type of wear, and the condition and rigidity of the machine–tool–workpiece assembly.

- incorrect tool chosen
- incorrect chip thickness
- incorrect cutting speed
- coolant is needed
- high feed rate

Corrective measures:

- use a wiper insert
- use a cutting insert with the right geometry
- reduce the feed rate
- change (usually increase) the cutting speed
- use a coolant
- improve the stability of the tool and workpiece
- change the chip cross section
- select a more easy–cutting chip breaker
- increase the nose radius

VIBRATIONS



Description and cause:

This is a very common problem, which is mainly caused by an unbalanced workpiece or tool, unstable fixing of the workpiece, high cutting forces or tool overhang.

Corrective measures:

- improve the stability of the tool and workpiece
- reduce the depth of cut
- minimize tool overhang
- reduce the cutting speed
- use a tool with smaller setting angle
- reduce the chip cross section
- use a tool with a low cutting resistance
- increase the feed rate
- select a more easy–cutting chip breaker
- increase the nose radius

BURRS



Description and cause:

This usually occurs on soft steels and plastic materials.

Corrective measures:

- use a cutting insert with a sharp cutting edge
- use a cutting insert with positive geometry
- use a tool with a smaller setting angle



ERRORS IN DIMENSIONS AND SHAPE OF WORKPIECE



Description and cause:

Depends on a number of factors.

Corrective measures:

- use a wear-resistant cutting insert
- improve the stability of the cutter and workpiece
- minimize tool overhang
- use a workpiece with a suitable machining allowance

INADEQUATE CHIP FORMATION



Description and cause:

Producing a chip with a suitable shape is very important to insert durability and service life of the tool. The workpiece material, the feed rate, the depth of cut and the cutting geometry all have an effect on chip forming. A chip that is too long is unacceptable for various reasons, while a chip that is too short is undesirable as it overloads the cutting edge and causes vibrations.

Corrective measures:

- change the feed rate and depth of cut
- use a more suitable cutting geometry
- change the cutting conditions

CHECK THE SEAT CONDITION OF THE CUTTING INSERT

Before clamping a new cutting insert or changing the edge, it is necessary to clean the seat and check its condition or the condition of the anvil and wedge (especially the damage under the corner of the cutting insert).

CHECK AND SERVICE THE CLAMPING PARTS

It is also important to check the clamping parts, including clamping levers, screws, wedges and clamps. Only use original, undamaged parts (found in the catalogue). Regularly lubricate the threads and the binding surface of screws, for example using heat-resistant lubricant (Molykote G.). For assembly and disassembly, only use screwdrivers and wrenches specified in our catalogue or recommended by the tool manufacturer. Pay attention to the correct tightening (proportional) – it is advisable to use a torque wrench.

CHECK THE TIGHTENING

Before tightening, check the fit of the cutting insert on the whole of the binding surface and in the radial and axial directions. Cutting inserts and tools must always be clean and undamaged.



Machined material – the influence of the cutting environment increases with worsening machinability of the workpiece material.

Cutting grade – the influence of the cutting environment increases with increasing toughness (Co content). Cooling is not only recommended for high-speed machining, i.e. for the application of CBN and ceramics.

Feed – the increasing feed increases the contribution of the cutting fluid to the tool life.

Cutting speed (typical for the machined material) – the higher the cutting speed, the more important the cooling effect of the cutting fluid and, conversely, the lower the cutting speed, the more important the lubricating effect of the cutting fluid.

Fluid supply is also one of the criteria that strongly affects the economy and productivity of the cutting process. In an ideal case, the liquid can be supplied to both the face and the flank of the tool. The supply of cutting fluid from the flank only affects the tool life. While the supply of fluid from the face of the tool can in some cases help you to form chips (especially in the case of high-pressure cooling). If only one of the alternatives is possible, the type of wear will indicate the right direction. If the inserts are worn on the flank, try to bring the liquid from below, i.e. to the flank of the insert. If a crater is formed, the fluid should be directed to the face of the tool (under the chip, not to its root).

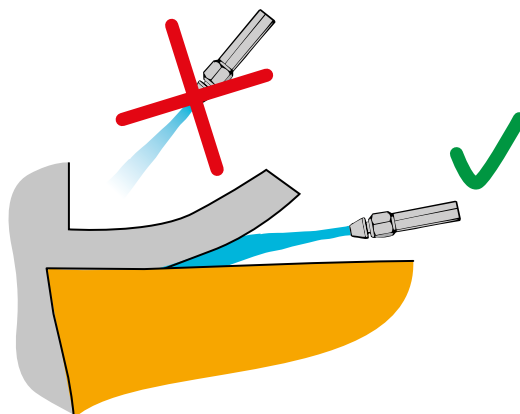



FORMULA FOR CALCULATING CUTTING DATA

Value	Formula	Unit	Note															
Number of revolutions	$n = \frac{v_c \cdot 1000}{D \cdot \pi}$	[1/min] [rpm]	<table style="width: 100%; border-collapse: collapse;"> <tr> <td style="width: 10%;">n</td> <td>Number of revolutions</td> <td>[1/min]</td> </tr> <tr> <td>D</td> <td>Diameter (of tool or workpiece)</td> <td>[mm]</td> </tr> </table>	n	Number of revolutions	[1/min]	D	Diameter (of tool or workpiece)	[mm]									
n	Number of revolutions	[1/min]																
D	Diameter (of tool or workpiece)	[mm]																
Cutting speed	$v_c = \frac{\pi \cdot D \cdot n}{1000}$	[m/min]	<table style="width: 100%; border-collapse: collapse;"> <tr> <td>v_c</td> <td>Cutting speed</td> <td>[m/min]</td> </tr> <tr> <td>f_{rev}</td> <td>Feed per revolution</td> <td>[mm/rev]</td> </tr> <tr> <td>f_{min}</td> <td>Feed per minute (Linear Feedrate)</td> <td>[mm/min]</td> </tr> </table>	v_c	Cutting speed	[m/min]	f_{rev}	Feed per revolution	[mm/rev]	f_{min}	Feed per minute (Linear Feedrate)	[mm/min]						
v_c	Cutting speed	[m/min]																
f_{rev}	Feed per revolution	[mm/rev]																
f_{min}	Feed per minute (Linear Feedrate)	[mm/min]																
Feed per revolution	$f_{rev} = \frac{f_{min}}{n}$	[mm/rev]																
Feed per minute (Linear Feedrate)	$f_{min} = v_f = f_{rev} \cdot n$	[mm/min]																
Max. height of profile R_{max}	$R_{max} = \frac{125 \cdot f_{rev}^2}{RE}$	[μ m]	<table style="width: 100%; border-collapse: collapse;"> <tr> <td>R_{max}</td> <td>max. height of profile</td> <td>[mm]</td> </tr> <tr> <td>R_a</td> <td>surface finish</td> <td>[mm]</td> </tr> <tr> <td>f_{rev}</td> <td>feed per revolution</td> <td>[mm/rev]</td> </tr> <tr> <td>RE</td> <td>nose radius</td> <td>[mm]</td> </tr> </table>	R_{max}	max. height of profile	[mm]	R_a	surface finish	[mm]	f_{rev}	feed per revolution	[mm/rev]	RE	nose radius	[mm]			
R_{max}	max. height of profile	[mm]																
R_a	surface finish	[mm]																
f_{rev}	feed per revolution	[mm/rev]																
RE	nose radius	[mm]																
Surface finish R_a	$R_a = \frac{43,9 \cdot f_{rev}^{1,88}}{RE^{0,97}}$	[μ m]																
Chip cross section	$A = f_{rev} \cdot a_p$	[mm ²]	<table style="width: 100%; border-collapse: collapse;"> <tr> <td>A</td> <td>Chip cross section</td> <td>[mm²]</td> </tr> <tr> <td>f_{rev}</td> <td>Feed per revolution</td> <td>[mm/rev]</td> </tr> <tr> <td>a_p</td> <td>Axial depth of cut</td> <td>[mm]</td> </tr> </table>	A	Chip cross section	[mm ²]	f_{rev}	Feed per revolution	[mm/rev]	a_p	Axial depth of cut	[mm]						
A	Chip cross section	[mm ²]																
f_{rev}	Feed per revolution	[mm/rev]																
a_p	Axial depth of cut	[mm]																
Chip thickness (For insert with straight edge)	$h = f_{rev} \cdot \sin \kappa_r$	[mm]	<table style="width: 100%; border-collapse: collapse;"> <tr> <td>κ_r</td> <td>Primary edge setting angle</td> <td>[°]</td> </tr> <tr> <td>h</td> <td>Chip thickness</td> <td>[mm]</td> </tr> </table>	κ_r	Primary edge setting angle	[°]	h	Chip thickness	[mm]									
κ_r	Primary edge setting angle	[°]																
h	Chip thickness	[mm]																
Chip thickness (For round cutting insert)	$h = f_{rev} \cdot \sqrt{\frac{a_p}{INSD}}$	[mm]	<table style="width: 100%; border-collapse: collapse;"> <tr> <td>v_c</td> <td>Cutting speed</td> <td>[m/min]</td> </tr> <tr> <td>f_{min}</td> <td>Feed per minute (Linear Feedrate)</td> <td>[mm/min]</td> </tr> <tr> <td>Q</td> <td>Material removal rate per minute</td> <td>[cm³/min]</td> </tr> <tr> <td>$INSD$</td> <td>Insert diameter [mm]</td> <td></td> </tr> </table>	v_c	Cutting speed	[m/min]	f_{min}	Feed per minute (Linear Feedrate)	[mm/min]	Q	Material removal rate per minute	[cm ³ /min]	$INSD$	Insert diameter [mm]				
v_c	Cutting speed	[m/min]																
f_{min}	Feed per minute (Linear Feedrate)	[mm/min]																
Q	Material removal rate per minute	[cm ³ /min]																
$INSD$	Insert diameter [mm]																	
Metal removal rate	$Q = a_p \cdot f_{rev} \cdot v_c$	[cm ³ /min]																
Power demand	$P_c = \frac{a_p \cdot f_{rev}^{1-c} \cdot k_{cl} \cdot v_c \cdot k\kappa_r}{6 \cdot 10^4 \cdot \eta}$	[kW]	<table style="width: 100%; border-collapse: collapse;"> <tr> <td>P_c</td> <td>Power demand</td> <td>[kW]</td> </tr> <tr> <td>a_p</td> <td>Depth of cut</td> <td>[mm]</td> </tr> <tr> <td>f_{rev}</td> <td>Feed</td> <td>[mm/rev]</td> </tr> </table>	P_c	Power demand	[kW]	a_p	Depth of cut	[mm]	f_{rev}	Feed	[mm/rev]						
P_c	Power demand	[kW]																
a_p	Depth of cut	[mm]																
f_{rev}	Feed	[mm/rev]																
Approximate power demand	$P_c = \frac{a_p \cdot f_{rev} \cdot v_c}{x}$	[kW]	<table style="width: 100%; border-collapse: collapse;"> <tr> <td>c</td> <td>Constant KTV</td> <td>[1]</td> </tr> <tr> <td>k_c</td> <td>Specific cutting force</td> <td>[MPa]</td> </tr> <tr> <td>k_{κ_r}</td> <td>κ_r angle constant</td> <td>[1]</td> </tr> <tr> <td>η</td> <td>Efficiency (usually $\eta = 0,75$)</td> <td>[1]</td> </tr> <tr> <td>x</td> <td>Machined material constant</td> <td>[1]</td> </tr> </table>	c	Constant KTV	[1]	k_c	Specific cutting force	[MPa]	k_{κ_r}	κ_r angle constant	[1]	η	Efficiency (usually $\eta = 0,75$)	[1]	x	Machined material constant	[1]
c	Constant KTV	[1]																
k_c	Specific cutting force	[MPa]																
k_{κ_r}	κ_r angle constant	[1]																
η	Efficiency (usually $\eta = 0,75$)	[1]																
x	Machined material constant	[1]																

Material	Steel	Cast iron	Al
Coefficient x	20	25	100



RECOMMENDED SCREW TORQUES

Clamping screw		
Screw designation	Screwdriver	Torque [Nm]
28588	MA2-8304	0.8
28992	MA2-8304	0.8
416.1-832	PT-8002	3.6
5513 020-01	PT-8004	3.6
5513 020-03	PT-8001	0.8
5513 020-04	PT-8003	1.5
5513 020-05	PT-8001	0.8
5513 020-14	TX 225PLUS	8.5
5513 020-24	PT-8002	1.5
5513 020-27	PT-8000	0.6
5513 020-28	PT-8000	0.6
5513 021-03	DMN 3124	13
CS 8601-T09P	SDR T09P	1.7
CS 8601-T15P	SDR T15P	3.9
CS 8601-T20P	SDR T20P	6.4
CS 8601-T25P	SDR T25P	9.5
DVF 0573	PT-8002	1.5
DVF 2260	TX 215PLUS	3.6
DVF 3584	DMD 1650	0.6
DVF 3593	TX 207PLUS	0.8
HS 0408	HXX 3	5
HS 0520C	HXX 4	5
HS 0616C	HXX 5	8
HS 0620	HXX 5	6
HS 0620C	HXX 5	6
HS 0625	HXX 5	6
HS 0625C	HXX 5	6
HS 0630	HXX 5	6
HS 0825	HXX 6	10
HS 0830	HXX 6	10
HS 0835	HXX 6	10
HS 0840	HXX 8	11
HS 1030	HXX 8	8
HS 1060	HXX 6	10
HS 93	HXX 5	8
HS 94	HXX 5	8
HSI 1020	HXX 6	8
PS 0512	HXX 2	2
PS 0512-A	HXX 2	2
PS 0616	HXX 2,5	4
PS 12040	HXX 5	8
PS 6026-709P	SRD T09P	2

TORQUE SCREWDRIVERS		
Torque handle	Torque [Nm]	Clamping screw thread
MR-0,8-2,0 vario	0.5 – 2.0	M 2 – M 3
MR-1,0-5,0 vario	0.8 – 5.0	M 2,5 – M 5
MR-0,9 fix	0.9	M 2
MR-2,0 fix	2.0	M 3
MR-3,0 fix	3.0	M 3,5
MR-3,5 fix	3.5	M 4
MR-5,0 fix	5.0	M 5

Clamping screw		
Screw designation	Screwdriver	Torque [Nm]
PS 8290	HXX 2	2
SR 14	HXX 10	10
SR 85011-T15P	SDR T15P	5
SR 85017-T09P	SDR T09P	2
SR 85020-T15P	SDR T15P	3
SR 86025-T20P	SRD T20P	5
T20.037	DMD 1650	0.6
UP 0909-T09P	SRD T09P	2
UP 1515-T15P	SDR T15P	8
US 2505-T07P	SDR T07P	0.9
US 2506-T07P	SDR T07P	0.9
US 3007-T09P	SDR T09P	2
US 34	HXX 3	5
US 35	HXX 4	6
US 3508-T15P	SDR T15P	3
US 3510A-T15P	SDR T15P	3
US 3510-T15P	SDR T15P	3
US 3512A-T15P	SDR T15P	3
US 3512-T15P	SDR T15P	3
US 36	HXX 4	6
US 38	HXX 5	8
US 39	HXX 5	8
US 40	HXX 4	6
US 4008-T15P	SDR T15P	3.5
US 4011-T15P	SDR T15P	3.5
US 41	HXX 4	6
US 42	HXX 4	6
US 45013-T20P	SDR T20P	5
US 4512-T15P	SDR T15P	5
US 4514A-T20	SDR T20	5
US 46	HXX 3	5
US 46017-T20P	SDR T20P	5
US 47	HXX 5	8
US 5012-T15P	SDR T15P	5
US 5015-T20P	SDR T20P	5
US 5018-T20P	SDR T20P	5
US 6020-T25P	SDR T25P	6
US 64518-T15P	SDR T15P	5
US 8025-T30P	SDR T20P	13
US 83	HXX 4	6
US 95	HXX 4	10

Replaceable shanks		
Replaceable shanks		
D-T6	D-T8	D-T15
D-T6P	D-T8P	D-T15P
D-T7	D-T9	D-T20
D-T7P	D-T9P	D-T20P

SCREW LUBRICATION

Insert clamping screws are subject to high thermal stresses. It is recommended that all screws be lubricated with a high quality paste such as MOLYKOTE 1000.



COMPLETE CLAMP SET

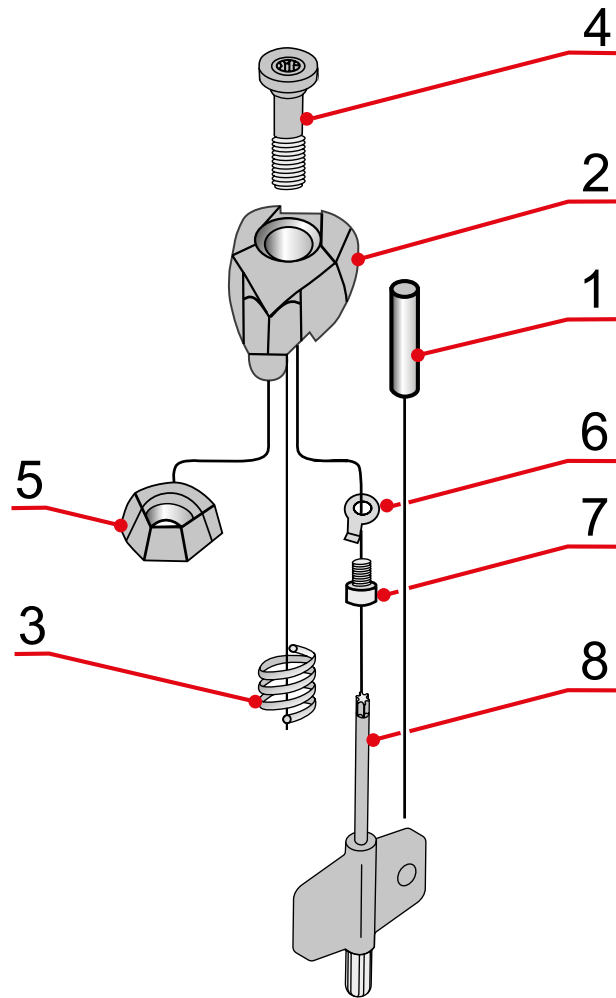

	1	2	3	4		5	6	7	8
DCS 09	CP 2655	CD 09	PR 0157	CS 8601-T09P	1.7	-	-	-	-
DCS 12	CP 2607	CD 12	PR 0158	CS 8602-T15P	3.9	-	-	-	-
DCS 16	CP 2607	CD 16	PR 0159	CS 8603-T20P	6.4	-	-	-	-
DCS 19	CP 2607	CD 19	PR 0159	CS 8603-T20P	6.4	-	-	-	-
DCS 25	CP 2607	CD 25	PR 0101	CS 8604-T25P	9.5	-	-	-	-
DCS 16V	CP 2607	CD 16V	PR 0158	CS 8602-T15P	3.9	-	-	-	-
DCS 12C2	CP 2607	CD 12C2	PR 0158	CS 8602-T15P	3.9	PP 3002	H 1201	CS 9701-T07P	FLAG T07P
DCS 16C2	CP 2607	CD 16C2	PR 0159	CS 8603-T20P	6.4	PP 3003	H 1201	CS 9701-T07P	FLAG T07P
DCS 12C4	CP 2607	CD 12C4	PR 0158	CS 8602-T15P	3.9	PP 3002	H 1201	CS 9701-T07P	FLAG T07P
DCS 16C4	CP 2607	CD 16C4	PR 0159	CS 8603-T20P	6.4	PP 3003	H 1201	CS 9701-T07P	FLAG T07P

SIMPLY RELIABLE

As a professional you can judge the quality of work by just looking at the chip. Our chip is a clean and uncomplicated shape that in itself tells a story. It is a clear and consistent signal and that's why we use it as a symbol for being **Simply Reliable**.

DORMER PRAMET

Austria

T: +31 10 2080 240
info.at@dormerpramet.com

Belgium & Luxembourg

T: +32 3 440 59 01
info.be@dormerpramet.com

Brazil

T: +55 11 5660 3000
info.br@dormerpramet.com

Canada

T: (888) 336 7637
En Français: (888) 368 8457
cs.canada@dormerpramet.com

China

T: +86 21 2416 0508
info.cn@dormerpramet.com

Croatia

T: +385 98 407 489
info.hr@dormerpramet.com

Czech Republic

T: +420 583 381 111
info.cz@dormerpramet.com

Denmark

T: 808 82106
info.se@dormerpramet.com

Finland

T: 0205 44 7003
info.fi@dormerpramet.com

France

T: +33 (0)2 47 62 57 01
info.fr@dormerpramet.com

Germany

T: +49 9131 933 08 70
info.de@dormerpramet.com

Hungary

T: +36-96 / 522-846
info.hu@dormerpramet.com

India

T: +91 11 4601 5686
info.in@dormerpramet.com

Italy

T: +39 02 30 70 54 44
info.it@dormerpramet.com

Kazakhstan

T: +7 771 305 11 45
info.kz@dormerpramet.com

Mexico

T: +52 (555) 7293981
cs.mexico@dormerpramet.com

Netherlands

T: +31 10 2080 240
info.nl@dormerpramet.com

Norway

T: 800 10 113
info.se@dormerpramet.com

Poland

T: +48 32 78-15-890
info.pl@dormerpramet.com

Portugal

T: +351 21 424 54 21
info.pt@dormerpramet.com

Romania

T: +4(0)730 015 885
info.ro@dormerpramet.com

Russia

T: +7 (495) 775 10 28
info.ru@dormerpramet.com

Slovakia

T: +421 (41) 764 54 60
info.sk@dormerpramet.com

Slovenia

T: +385 98 407 489
info.si@dormerpramet.com

Spain

T: +34 935717722
info.es@dormerpramet.com

Sweden

responsible for Iceland
T: +46 35 16 52 96
info.se@dormerpramet.com

Switzerland

T: +31 10 2080 240
info.ch@dormerpramet.com

Turkey

T: +90 533 212 45 47
info.tr@dormerpramet.com

Ukraine

T: +38 067 566 38 80
T: +38 067 566 81 51
info.ua@dormerpramet.com

United Kingdom

responsible for Ireland
T: 0870 850 4466
info.uk@dormerpramet.com

United States of America

T: (800) 877-3745
cs@dormerpramet.com

Other countries

South America

T: +55 11 5660 3000
info.br@dormerpramet.com

Adria

T: +420 583 381 527
info.rcee@dormerpramet.com

Rest of the World

Dormer Pramet International UK
T: +44 1246 571338
info.int@dormerpramet.com

Dormer Pramet International CZ
T: +420 583 381 520
info.int.cz@dormerpramet.com

DP-CAT-TURNING-2021-EN

FOLLOW US...



www.dormerpramet.com



youtube.com/dormerpramet



facebook.com/dormerprametsocial



linkedin.com/company/dormerpramet



instagram.com/dormerprametsocial



twitter.com/dormerpramet