

13~17 A Compatible, Position Misalignment Absorption Type Power Supply Connector for PCB Connections

FX30B Series

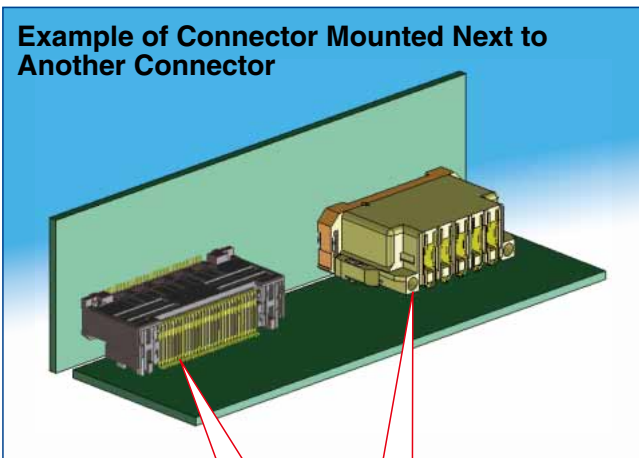

FX18 Series
(without position misalignment absorption function)

FX30B Series
(with position misalignment absorption function)

■ Features

1. **Contact Pitch: 3.81 mm**
2. **Current Capacity: 13~17 A/pin (Page 2.)**
*For details, see the derating curve.(Described on page 4.)
3. **Connection Type: Coplanar / Vertical / Parallel**
4. **Number of Pos.: 2 / 3 / 4 / 5 Pos.**
5. **Position Misalignment Absorption Movable Amount: ±0.3 mm**
 - (1) Reliable to mounting misalignment when using multiple connectors.
 - (2) Other products without position misalignment absorption can be used together.
6. **Effective Mating Length: 2 mm**
The effective mating length is 2 mm long, so it has an enough margin for the mating stroke. (3.0 mm for longer contacts)
7. **Multi-point Contact Structure**
It has superior contact reliability by employing an independent four-point contact spring structure.
8. **Low Insertion / Extraction Force**
It offers low insertion/extraction force by employing a two-step contact timing sequence.
9. **Robustness**
Reinforcement metal fittings that securely fix the connector to the PCB are added on both sides of the connector, providing excellent deformation resistance for up, down, left and right directions.
10. **Large Guide Form Leads Superior Mating Ability**
A large induction form has been provided, allowing easy mating operations. (Induction amount: ±1.3 mm, with position misalignment absorption amount: ±1.6 mm)
11. **Protected structure**
Our proprietary protective wall prevents foreign materials from contacting the sensitive areas. (Compatible to JIS C 0922 Probes for verification B)
12. **UL, C-UL and TÜV certifications have been achieved.**

■ Mating variations

Coplanar connection type

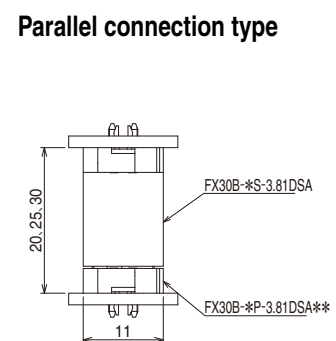
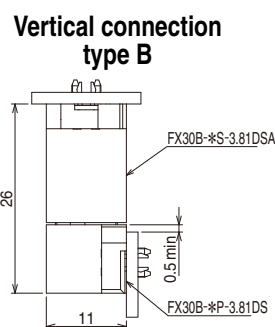
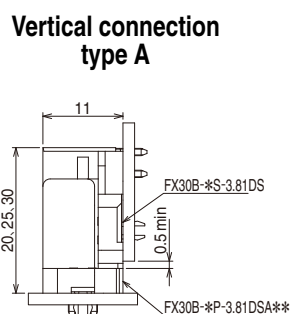
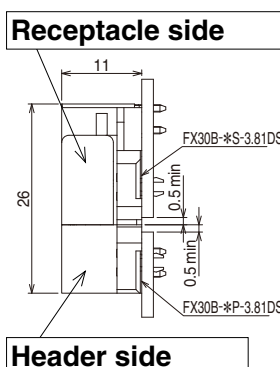

Product Specifications

		2 pos.	3 pos.	4 pos.	5 pos.	Operating temperature range: -55 to 105°C (Note 1)
Ratings	Current rating (Note 3)	UL/C-UL	16A	15A	13A	Operating humidity range: Relative humidity 85% max. (Not dewed)
		TÜV	17A	16A	15A	
	Voltage rating	UL/C-UL	250V AC/DC			Storage temperature range: -10 to 60°C (Note 2)
		TÜV	150V AC/DC			Storage humidity range: 40% to 70%(Note 2)
UL/C-UL/TÜV		UL/C-UL	E52653		(Acc. to UL1977 / CSA C22.2 No.182.3-M1987)	
File No. and Confirmation No.		TÜV	R50275872		(Acc. to EN61984:2009)	

Item	Specification	Conditions
1. Contact resistance	2 mΩ or less	Measured at 10 mA
2. Insulation resistance	1000 MΩ or more	Measured at 250 V DC
3. Withstanding voltage	No flashover or breakdown	Conduct electricity by applying a voltage of 750 V AC for 1 minute
4. Insertion/extraction lifespan	Contact resistance: 5 mΩ or less	Insert/extract 100 times
5. Vibration resistance	No electric outage of 1μs or greater	Frequency: 10 to 55 Hz, half amplitude: 0.75 mm, 10 cycles in each of 3 axis directions for 5 minutes/cycle
6. Shock resistance	No electric outage of 1μs or greater	Acceleration of 490 m/s ² , duration 11 ms, sine half-wave, 3 cycles in each of the 3 axes each in both directions
7. Humidity resistance	Contact resistance: 5 mΩ or less Insulation resistance: 1000 MΩ or more	Temperature: 40°C, humidity: 90 to 95%, left for 96 hours
8. Temperature cycle	Contact resistance: 5 mΩ or less Insulation resistance: 1000 MΩ or more	Temperature: -55 → 105°C Time: 30 → 30 min., 5 cycles
9. Solder heat resistance	No melting of resin part, which affects the product performance	Solder tank: solder tank temperature: 260°C, 10 seconds Manual soldering: soldering iron temperature: 380°C, 10 seconds

(Note 1) Includes temperature rise caused by current flow.

(Note 2) The term “storage” refers to the long-term storage condition of unused products before PCB mounting.

(Note 3) Current rating per 1 contact is used.

Materials

●Receptacle/Header Common

Part	Material	Color/Treatment	Specification
Insulator	Polyamide resin	Black	UL94V-0
Power supply contact	Copper alloy	Contact area: Gold plating Mounting area: Pure tin plating	—
Reinforcement metal fitting	Phosphorous bronze	Whole body: Pure tin plating	—

Product Number Structure

Refer to this page when judging product specifications by model types. When making an order, please select a model type described in this catalog.

●Receptacle

FX30B - 5 S - 3.81 DS

① ② ③ ④ ⑤

●Header

FX30B - 5 P - 3.81 DSA 20

① ② ③ ④ ⑤ ⑥

① Series Name	FX30B
② Number of Contacts	2 to 5
③ Connector Type	S: Receptacle type P: Header type
④ Contact Pitch	3.81mm
⑤ Product Type	DS: Right angle type DSA: Straight type
⑥ Stacking Height Type	

Functional diagram

● Right angle receptacle

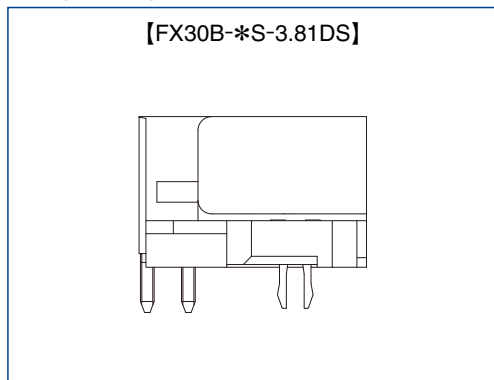

● Right angle header

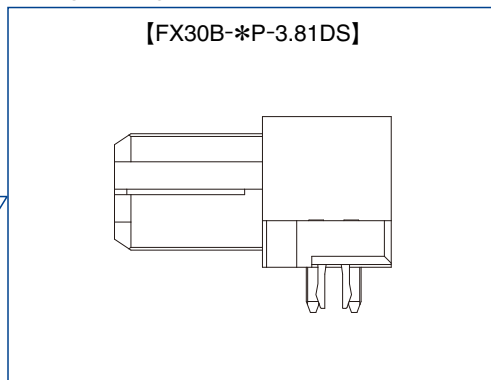

Coplanar connection

Vertical connection

● Straight receptacle

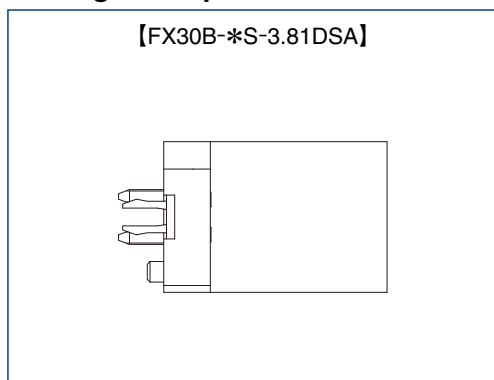

● Straight header

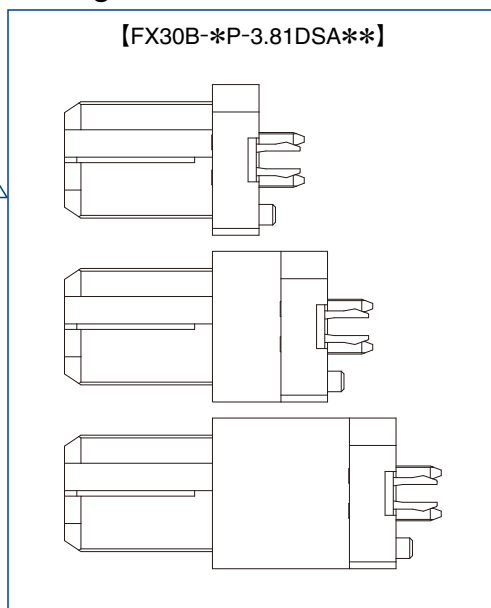

Parallel connection

Note !
 The FX30A and FX30B series connectors are two independent series and are not compatible. Do not try to cross mate them as they do NOT have mating compatibilities.

Stacking height dimensions for parallel connection type

Stacking height combinations table

	FX30B-*P-3.81DSA20	FX30B-*P-3.81DSA25	FX30B-*P-3.81DSA30
FX30B-*S-3.81DSA	20mm	25mm	30mm

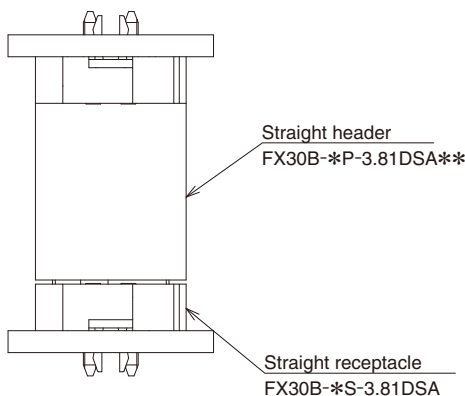

Derating curve

(Electricity conducted through the 5 pins of 5-pin coplanar connection type connector)

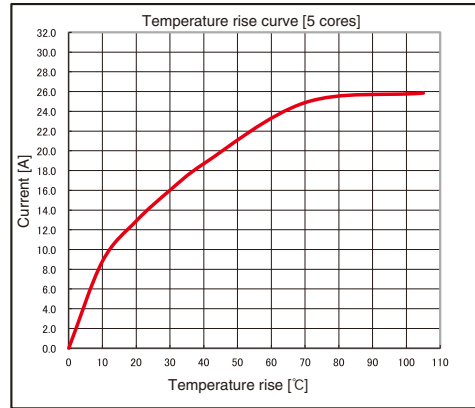
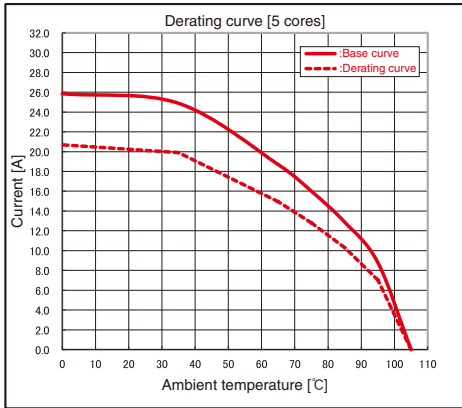

(Electricity conducted through the 4 pins of 4-pin coplanar connection type connector)

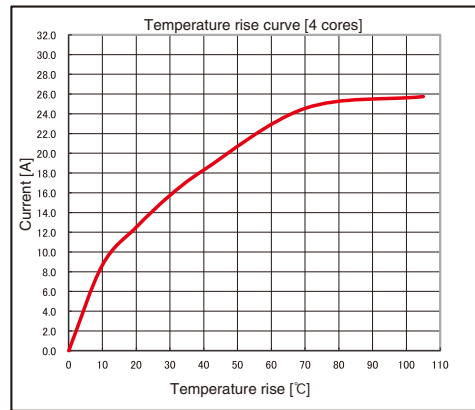
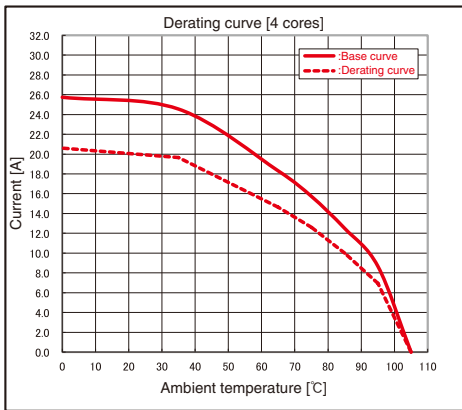

(Electricity conducted through the 3 pins of 3-pin coplanar connection type connector)

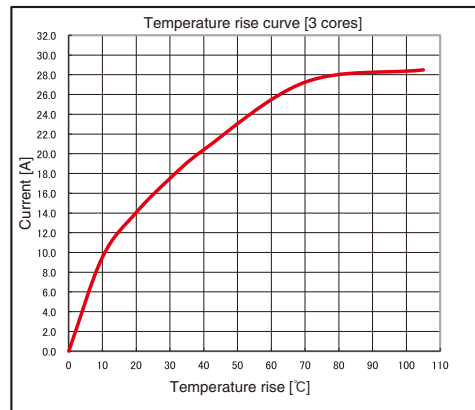
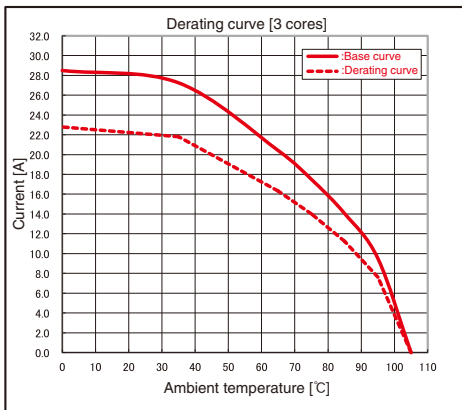

(Electricity conducted through the 2 pins of 2-pin coplanar connection type connector)

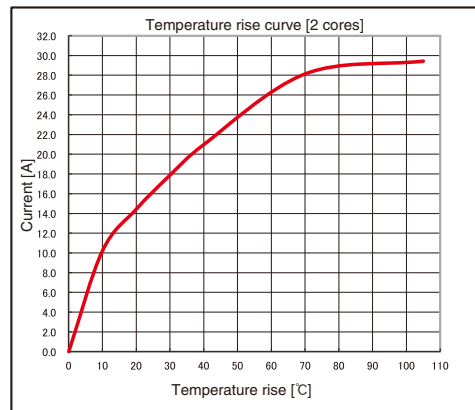
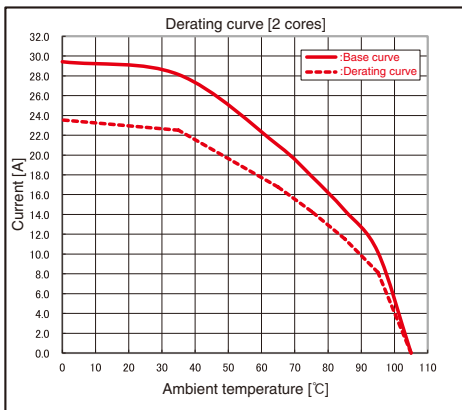

Note: The derating curve is created by multiplying a derating factor of 0.8 to the current value of the base curve.

●Right angle receptacle (S-DS type)

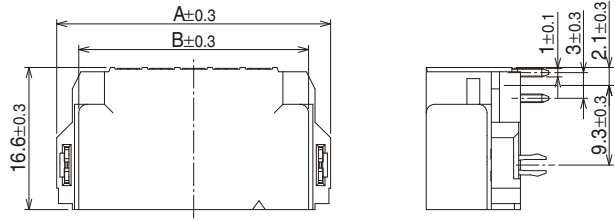

◆Diagram of recommended PCB layout dimensions
(Note) PCB thickness: t= 1.6 mm

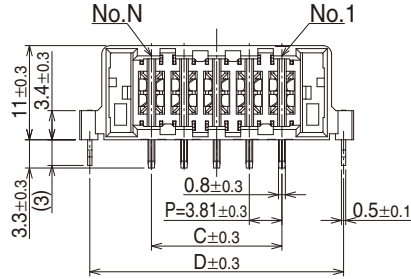
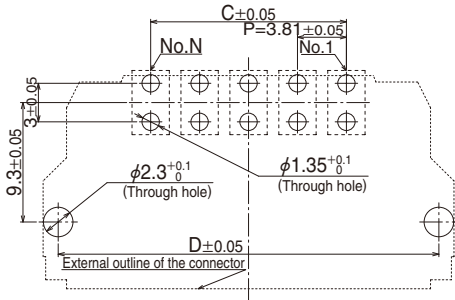

Unit: mm

Product No.	HRS No.	A	B	C	D	N (No. of Contacts)
FX30B-2S-3.81DS	CL0570-3600-6-00	20.56	15.41	3.81	18.21	2
FX30B-3S-3.81DS	CL0570-3601-9-00	24.37	19.22	7.62	22.02	3
FX30B-4S-3.81DS	CL0570-3602-1-00	28.18	23.03	11.43	25.83	4
FX30B-5S-3.81DS	CL0570-3603-4-00	31.99	26.84	15.24	29.64	5

●Straight receptacle (S-DSA type)

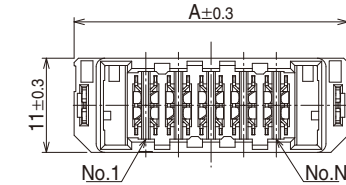

◆Diagram of recommended PCB layout dimensions
(Note) PCB thickness: t= 1.6 mm

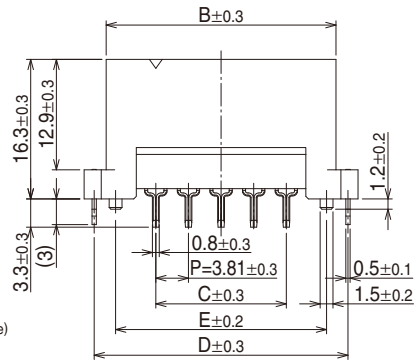
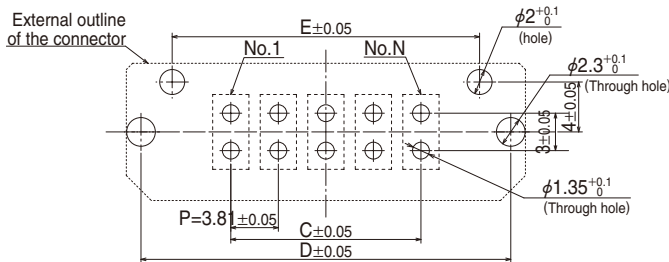

Unit: mm

Product No.	HRS No.	A	B	C	D	E	N (No. of Contacts)
FX30B-2S-3.81DSA	CL0570-3500-1-00	20.56	15.41	3.81	18.21	13.21	2
FX30B-3S-3.81DSA	CL0570-3501-4-00	24.37	19.22	7.62	22.02	17.02	3
FX30B-4S-3.81DSA	CL0570-3502-7-00	28.18	23.03	11.43	25.83	20.83	4
FX30B-5S-3.81DSA	CL0570-3503-0-00	31.99	26.84	15.24	29.64	24.64	5

●Right angle header (P-DS type)

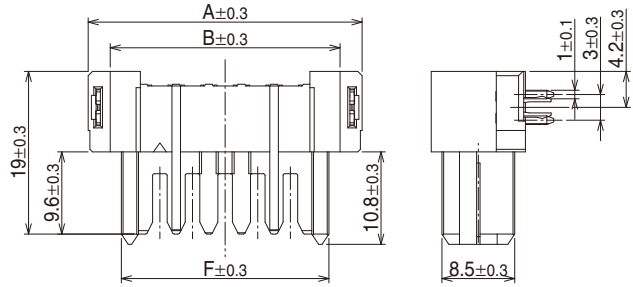

◆Diagram of recommended PCB layout dimensions

(Note) PCB thickness: t= 1.6 mm

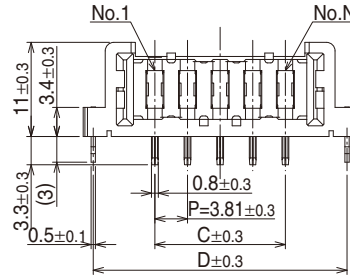
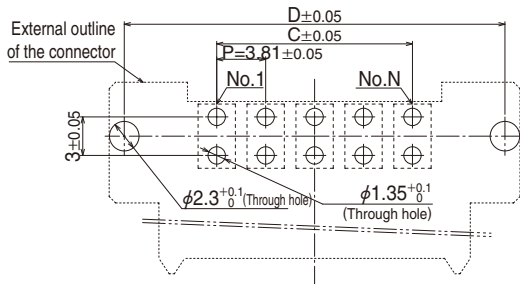

Unit: mm

Product No.	HRS No.	A	B	C	D	F	N (No. of Contacts)
FX30B-2P-3.81DS	CL0570-3400-7-00	20.56	15.41	3.81	18.21	12.81	2
FX30B-3P-3.81DS	CL0570-3401-0-00	24.37	19.22	7.62	22.02	16.62	3
FX30B-4P-3.81DS	CL0570-3402-2-00	28.18	23.03	11.43	25.83	20.43	4
FX30B-5P-3.81DS	CL0570-3403-5-00	31.99	26.84	15.24	29.64	24.24	5

●Straight header - 20 (P-DSA20 type)

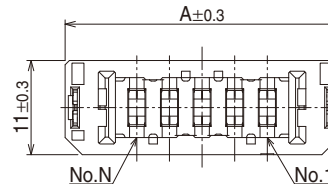

◆Diagram of recommended PCB layout dimensions

(Note) PCB thickness: t= 1.6 mm

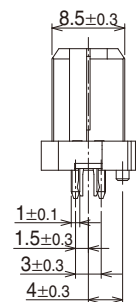
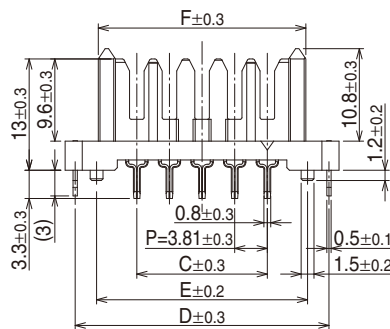
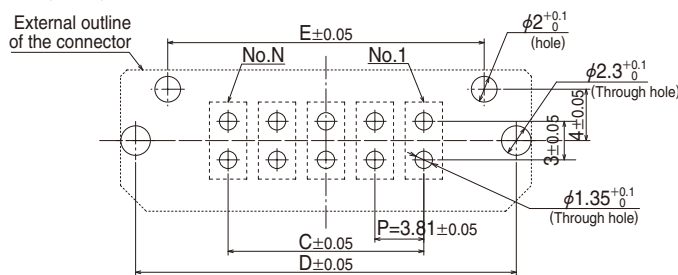

Unit: mm

Product No.	HRS No.	A	C	D	E	F	N (No. of Contacts)
FX30B-2P-3.81DSA20	CL0570-3100-3-00	20.56	3.81	18.21	13.21	12.81	2
FX30B-3P-3.81DSA20	CL0570-3101-6-00	24.37	7.62	22.02	17.02	16.62	3
FX30B-4P-3.81DSA20	CL0570-3102-9-00	28.18	11.43	25.83	20.83	20.43	4
FX30B-5P-3.81DSA20	CL0570-3103-1-00	31.99	15.24	29.64	24.64	24.24	5

●Straight header - 25 (P-DSA25 type)

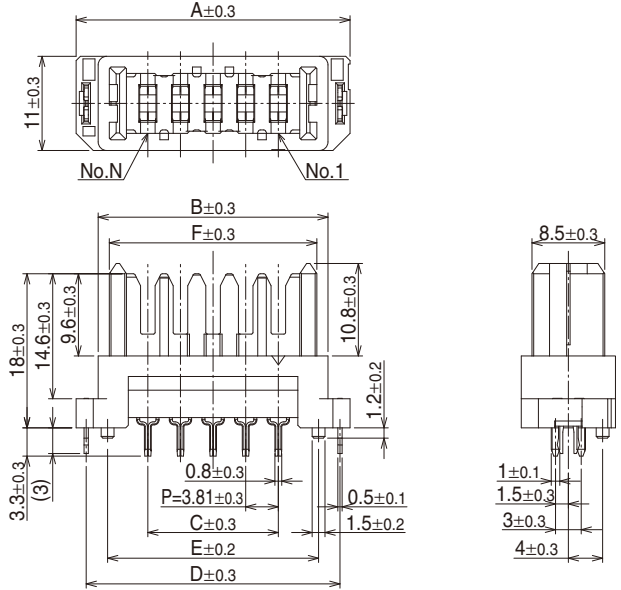

◆Diagram of recommended PCB layout dimensions

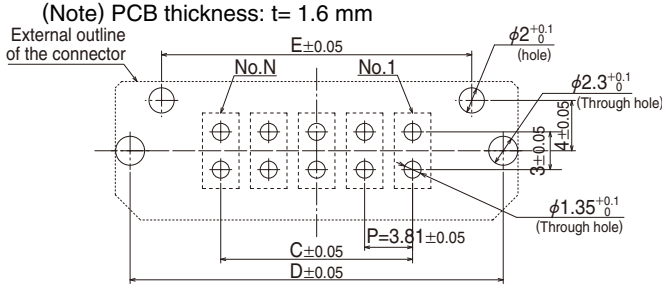

Unit: mm

Product No.	HRS No.	A	B	C	D	E	F	N (No. of Contacts)
FX30B-2P-3.81DSA25	CL0570-3200-8-00	20.56	15.41	3.81	18.21	13.21	12.81	2
FX30B-3P-3.81DSA25	CL0570-3201-0-00	24.37	19.22	7.62	22.02	17.02	16.62	3
FX30B-4P-3.81DSA25	CL0570-3202-3-00	28.18	23.03	11.43	25.83	20.83	20.43	4
FX30B-5P-3.81DSA25	CL0570-3203-6-00	31.99	26.84	15.24	29.64	24.64	24.24	5

●Straight header - 30 (P-DSA30 type)

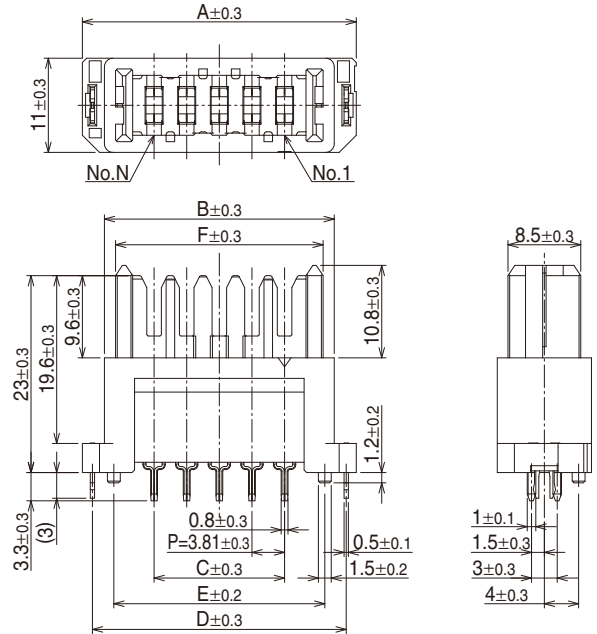

◆Diagram of recommended PCB layout dimensions

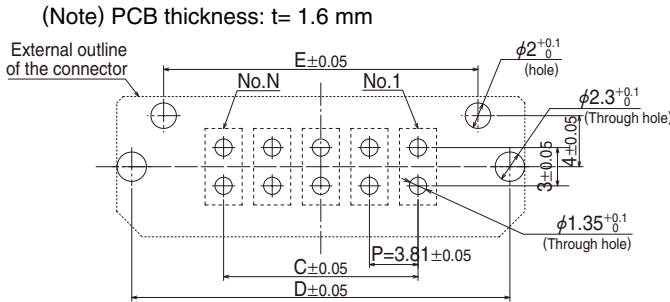

Unit: mm

Product No.	HRS No.	A	B	C	D	E	F	N (No. of Contacts)
FX30B-2P-3.81DSA30	CL0570-3300-2-00	20.56	15.41	3.81	18.21	13.21	12.81	2
FX30B-3P-3.81DSA30	CL0570-3301-5-00	24.37	19.22	7.62	22.02	17.02	16.62	3
FX30B-4P-3.81DSA30	CL0570-3302-8-00	28.18	23.03	11.43	25.83	20.83	20.43	4
FX30B-5P-3.81DSA30	CL0570-3303-0-00	31.99	26.84	15.24	29.64	24.64	24.24	5

◆Tray Packaging State Diagram

●Right angle receptacle (S-DS type)

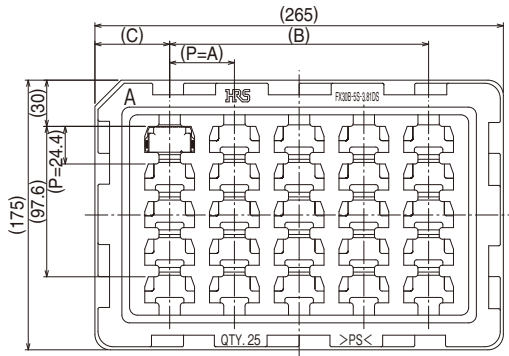

Unit: mm

Product No.	A	B	C	Quantity
FX30B-2S-3.81DS	30	180	42.5	35
FX30B-3S-3.81DS	35.5	177.5	43.75	30
FX30B-4S-3.81DS				
FX30B-5S-3.81DS	42	168	48.5	25

●Straight receptacle (S-DSA type)

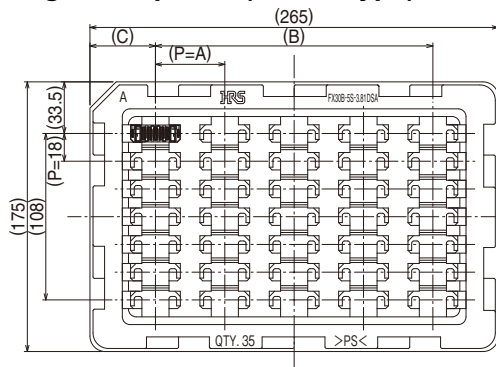

Unit: mm

Product No.	A	B	C	Quantity
FX30B-2S-3.81DSA	31.5	189	38	49
FX30B-3S-3.81DSA	38	190	37.5	42
FX30B-4S-3.81DSA				
FX30B-5S-3.81DSA	45	180	42.5	35

●Right angle header (P-DS type)

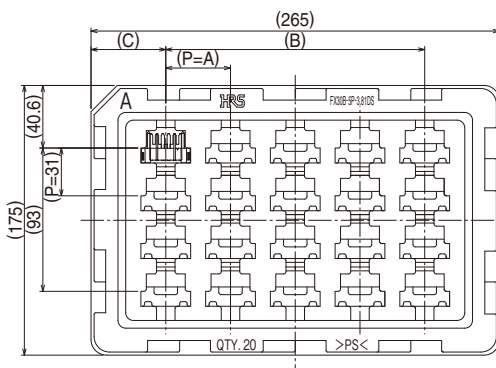

Unit: mm

Product No.	A	B	C	Quantity
FX30B-2P-3.81DS	30	180	42.5	28
FX30B-3P-3.81DS	35.5	177.5	43.75	24
FX30B-4P-3.81DS				
FX30B-5P-3.81DS	42	168	48.5	20

●Straight header - ** (P-DSA** type)

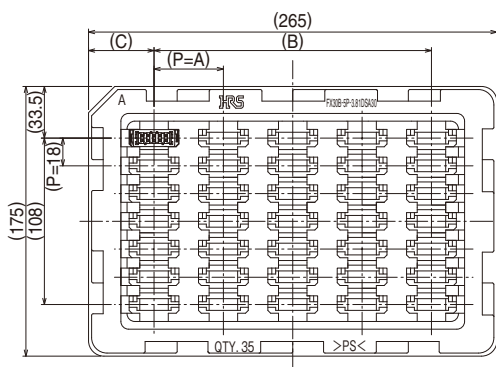

Unit: mm

Product No.	A	B	C	Quantity
FX30B-2P-3.81DSA**	31.5	189	38	49
FX30B-3P-3.81DSA**	38	190	37.5	42
FX30B-4P-3.81DSA**				
FX30B-5P-3.81DSA**	45	180	42.5	35

(Note) The above illustration shows a tray form example. Please refer to “delivery specifications” for official individual forms.

◆ Cleaning conditions

● Organic Solvent Cleaning

Solvent	Room temperature cleaning	Heated cleaning
IPA (Isopropyl alcohol)	○	○

● Water Cleaning

When using water cleaner (terpene, alkali saponifier, etc.), please select a cleaner according to the chart of effects to metal and resin issued by each cleaner manufacture. In addition, please make sure that the connectors are not left behind without removing moisture.

● Precautions for Cleaning

If flux or cleaner remains in the connector after it was cleaned using organic solvent or water cleaner, the performance of the connector may deteriorate. Make sure that the connectors are cleaned thoroughly.

◆ Usage precautions

● A position misalignment absorption function is provided in this product. Please use this product within the dimensions shown in the below diagram, while taking into account the connector mounting position misalignments and PCB mating position misalignments.

● The purpose of the position misalignment absorption function provided on this product is to absorb the misalignments between the connector mounting positions and between the PCB mating positions. **This function cannot be used for the purpose to absorb mating position misalignments due to vibrations.** Please use the connectors after the PCBs have been fixed so that the connector positions are fixed securely. Avoid supporting PCBs by connectors only, and be sure to fix the PCBs using methods other than the connectors.

● This connector is designed to correct minor mating misalignments. This ability creates a structure that allows more for more movement and shifting between its pieces than with other similar connectors. The PCB boards need to be secured as well. If they are not, vibration or other external forces will cause the connectors to become unmated.

● This product has a structure to absorb position misalignments by the spring displacement of the contacts in pitch directions. Therefore, **a spring reaction force will be generated in the pitch directions when absorbing the position misalignments** (Approximately 4 N per 1 core) Please make sure that the structure bodies (positioning pins, screws, guiding rails, and other connectors, etc.) that will be used as the positioning base have enough strength against the spring reaction force.

● Allowable Mating Gap

The effective mating length of this product is 2 mm.

Use the connectors so that the gap between the header and receptacle when they are mated is within 1.0 or 1.3 mm. Particularly make sure the gap does not exceed the limits due to warping of PCB, etc.

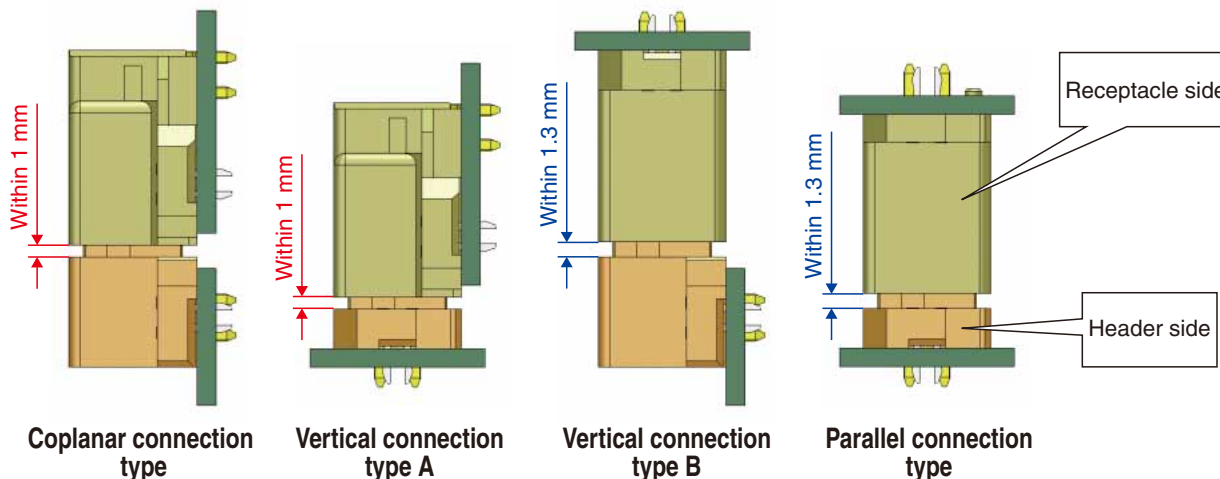
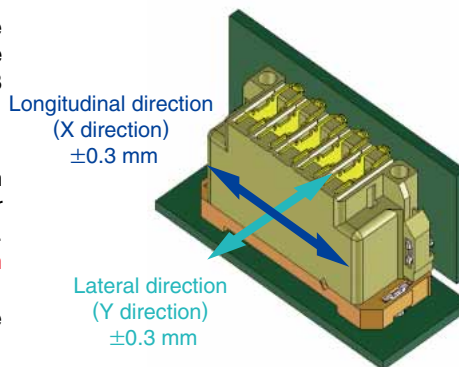

● A reverse insertion prevention structure and an abnormal mating position prevention structure have been provided in this connector, however, if the connectors are mated with an excessive force, connector breakage may result. Avoid improper mating of connectors by applying an excessive force and connect them correctly while confirming the connector polarities shown below. ~~shown below.tors by~~ applying an excessive force and connect them correctly while confirming the connector polarities shown below.

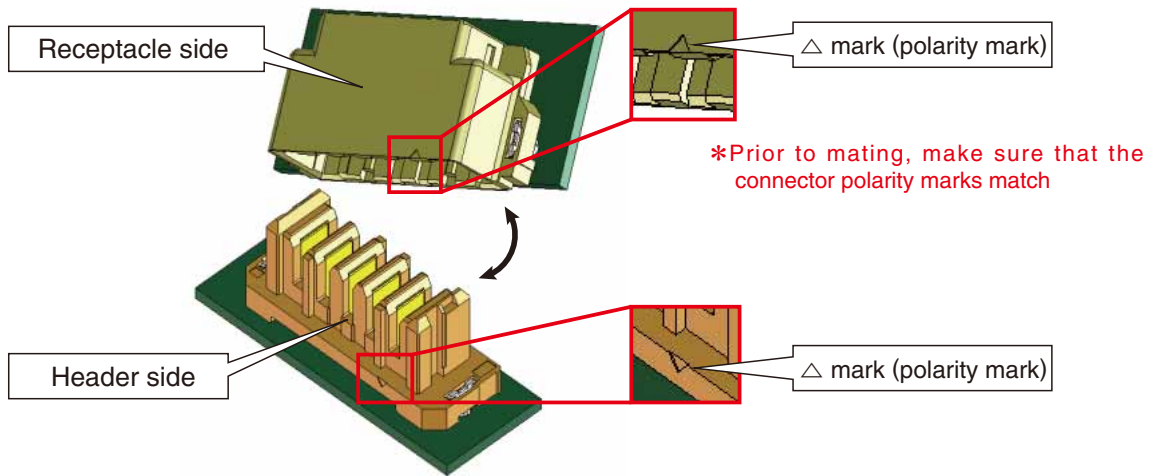

● A structure in which the contact deformation does not occur under normal mating operations has been provided on this connector, however, please make sure of the following; connector edge does not come to contact with the opening for mating, connectors are not mated diagonally in an abnormal manner, and foreign substances or hard objects, etc. do not touch the contacts. Pay attention so that contact deformation which causes a contact defect does not occur.

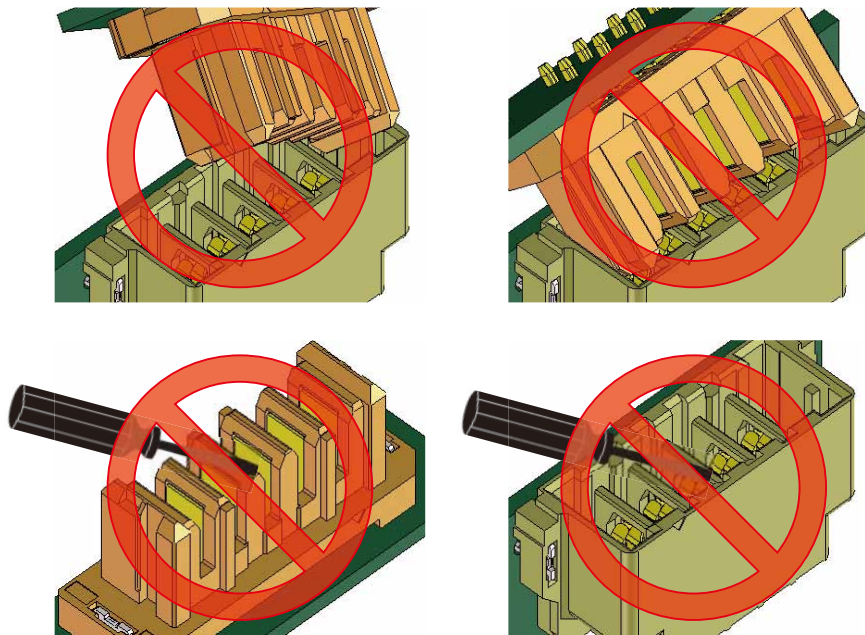

● If the connector is inserted/extracted forcibly in a wrong direction or it is rotated when inserting/extracting, a connector breakdown or contact defect may result. Please be careful.



● This product cannot be used for the purpose of current interruption application. (Prohibition of hot-swapping)

10 A Compatible, Position Misalignment Absorption Type Power Supply Connector for PCB Connections

FX30A Series

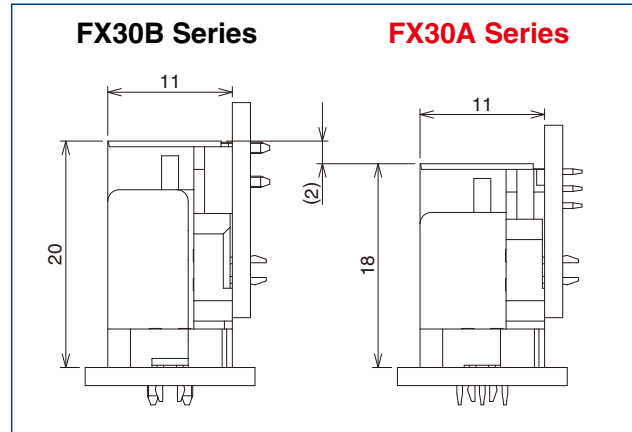

Features

The FX30A series is 2mm smaller type than FX30B series in mating axis direction. **The FX30A and FX30B series connectors are two independent series and are not compatible.** Do not try to mate them together as they do NOT have mating compatibilities.

1. **Contact pitch: 3.81 mm**
2. **Current capacity: 10 A/pin (Page 12.)**
*For details, see the derating curve.(Described on page 13.)
3. **Connection type: Vertical**
4. **Number of Pos.: 2 / 3 / 4 / 5 Pos.**
5. **Position Misalignment Absorption Movable Amount: ±0.3 mm**
 - (1)Reliable to mounting misalignment when using multiple connectors.
 - (2)Other products without position misalignment absorption can be used together.
6. **Effective Mating Length: 2 mm**
The effective mating length is 2 mm long, so it has an enough margin for the mating stroke. (3.0 mm for longer contacts)

7. Multi-point Contact Structure

It has superior contact reliability by employing an independent four-point contact spring structure.

8. Low Insertion/Extraction Force

It offers low insertion/extraction force by employing a two-step contact timing sequence.

9. Robustness

Reinforcement metal fittings that securely fix the connector to the PCB are added on both sides of the connector, providing excellent deformation resistance for up, down, left and right directions.

10. Large Guide Form Leads Superior Mating Ability

A large induction form has been provided, allowing easy mating operations. (Induction amount: ±1.3 mm, with position misalignment absorption amount: ±1.6 mm)

Mating variations

Vertical connection type A

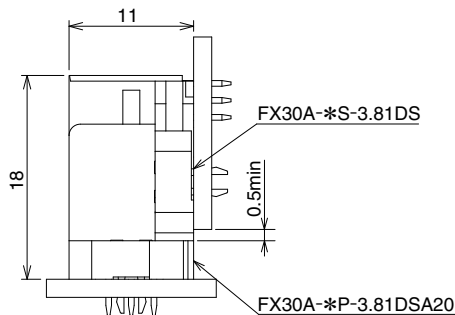

Note !

The FX30A and FX30B series connectors are two independent series and are not compatible. Do not try to cross mate them as they do NOT have mating compatibilities.

Functional Diagram

●Right angle receptacle

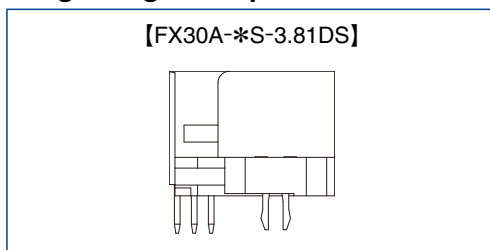

●Straight header

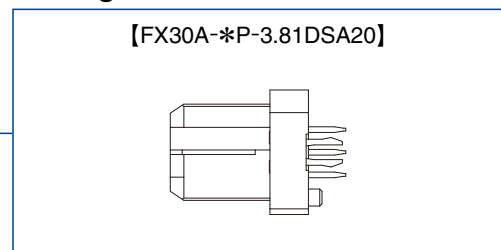

Vertical connection

Product Specifications

Ratings	Current rating: 10 A (Note 3) (See the derating curve on page 13) Voltage rating: 250 V AC/DC	Operating temperature range: -55 to 105°C (Note 1) Operating humidity range : Relative humidity 85% max. (Not dewed) Storage temperature range : -10 to 60°C (Note 2) Storage humidity range : 40% to 70%
---------	---	--

Items	Specifications	Conditions
1. Contact resistance	2 mΩ or less	Measured at 10 mA
2. Insulation resistance	1000 MΩ or more	Measured at 250 V DC
3. Withstanding voltage	No flashover or breakdown	Conduct electricity by applying a voltage of 750 V AC for 1 minute
4. Insertion/extraction lifespan	Contact resistance: 5 mΩ or less	Insert/extract 100 times
5. Vibration resistance	No electric outage of 1μs or greater	Frequency: 10 to 55 Hz, half amplitude: 0.75 mm, 10 cycles in each of 3 axis directions for 5 minutes/cycle
6. Shock resistance	No electric outage of 1μs or greater	Acceleration of 490 m/s ² , duration 11 ms, sine half-wave, 3 cycles in each of the 3 axes each in both directions
7. Humidity resistance	Contact resistance: 5 mΩ or less Insulation resistance: 1000 MΩ or more	Temperature: 40°C, humidity: 90 to 95%, left for 96 hours
8. Temperature cycle	Contact resistance: 5 mΩ or less Insulation resistance: 1000 MΩ or more	Temperature: -55 → 105°C Time: 30 → 30 min., 5 cycles
9. Solder heat resistance	No melting of resin part, which affects the product performance	Solder tank: solder tank temperature: 260°C, 10 seconds Manual soldering: soldering iron temperature: 360°C, 5 seconds

(Note 1) Includes temperature rise caused by current flow.

(Note 2) The term “storage” refers to the long-term storage condition of unused products before PCB mounting.

(Note 3) Current rating per 1 contact is used.

Materials

● Receptacle/Header Common

Part	Material	Color/Treatment	Specification
Insulator	Polyamide resin	Black	UL94V-0
Power supply contact	Copper alloy	Contact area: Gold plating Mounting area: Pure tin plating	—
Reinforcement metal fitting	Phosphorous bronze	Whole body: Pure tin plating	—

Product Number Structure

Refer to this page when judging product specifications by model types. When making an order, please select a model type described in this catalog.

● Right angle receptacle

FX30A – **5** **S** – **3.81** **DS**

①
②
③
④
⑤

● Straight header

FX30A – **5** **P** – **3.81** **DSA** **20**

①
②
③
④
⑤
⑥

① Series name	FX30A
② Number of Contacts	2 to 5
③ Connector type	S: Receptacle type P: Header type
④ Contact pitch	3.81 mm
⑤ Product type	DS: Right angle type DSA: Straight type
⑥ Stacking height Type	

Derating curve

(Electricity conducted through the 5 pins of 5-pin vertical connection type connector)

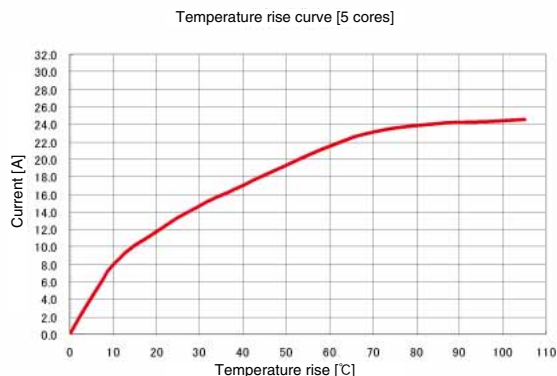
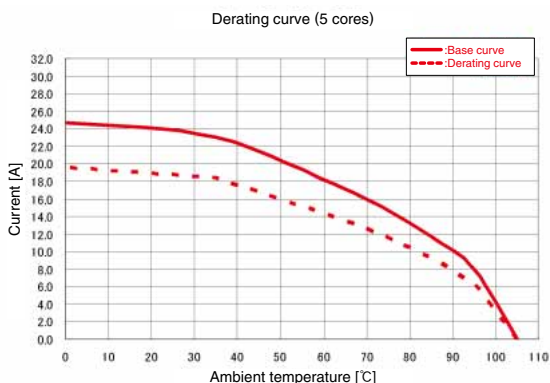

(Electricity conducted through the 4 pins of 4-pin vertical connection type connector)

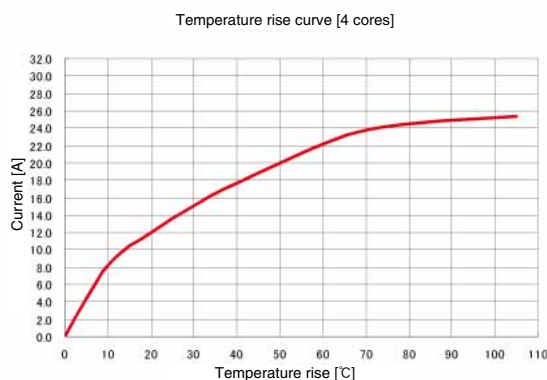
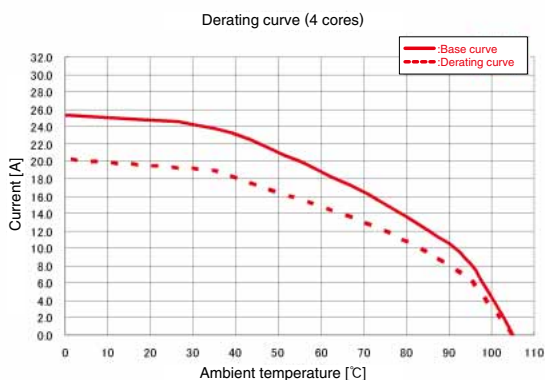

(Electricity conducted through the 3 pins of 3-pin vertical connection type connector)

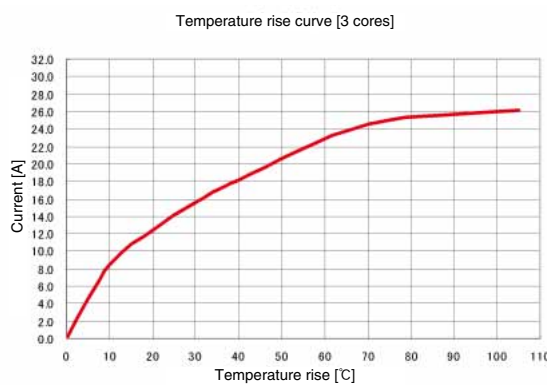
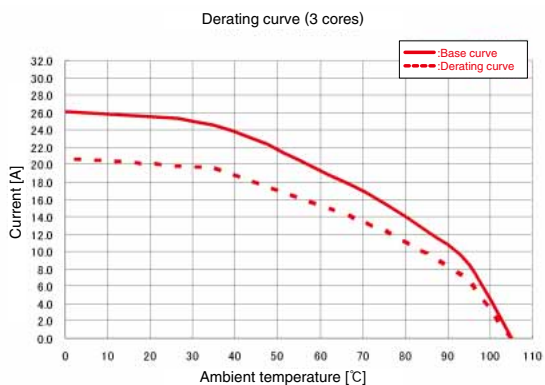

(Electricity conducted through the 2 pins of 2-pin vertical connection type connector)

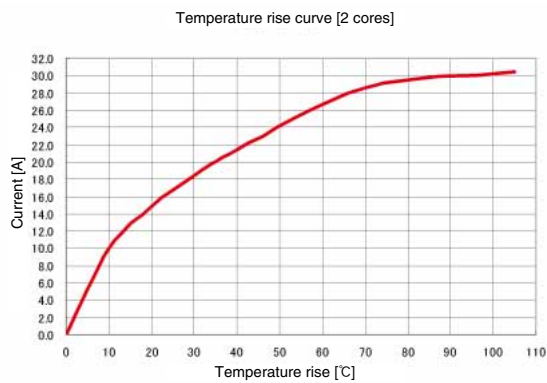
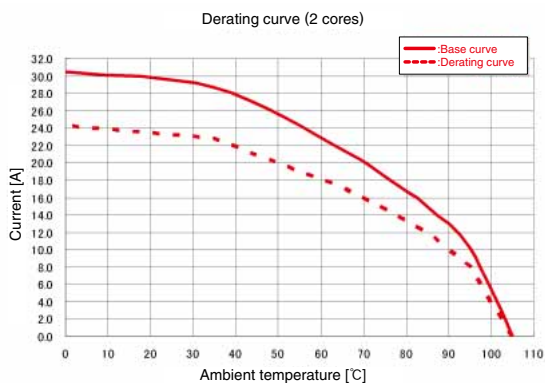

Note: The derating curve is created by multiplying a derating factor of 0.8 to the current value of the base curve.

● Right angle receptacle (S-DS type)

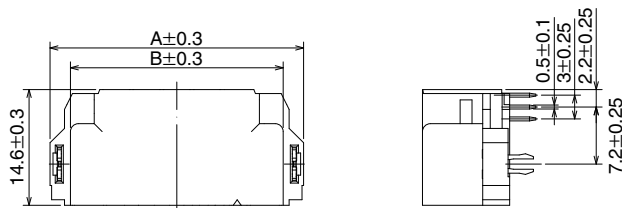

◆ Diagram of recommended PCB Layout dimensions

(Note) PCB thickness: t= 1.6 mm

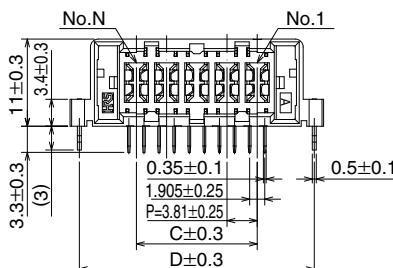
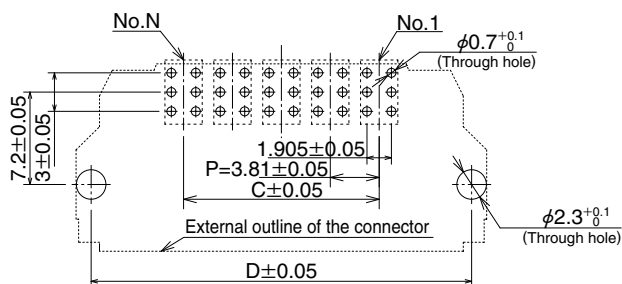

Unit: mm

Product No.	HRS No.	A	B	C	D	N (No. of Contacts)
FX30A-2S-3.81DS	CL0570-2500-6-00	20.56	15.41	3.81	18.21	2
FX30A-3S-3.81DS	CL0570-2501-9-00	24.37	19.22	7.62	22.02	3
FX30A-4S-3.81DS	CL0570-2502-1-00	28.18	23.03	11.43	25.83	4
FX30A-5S-3.81DS	CL0570-2503-4-00	31.99	26.84	15.24	29.64	5

● Straight header (P-DSA20 type)

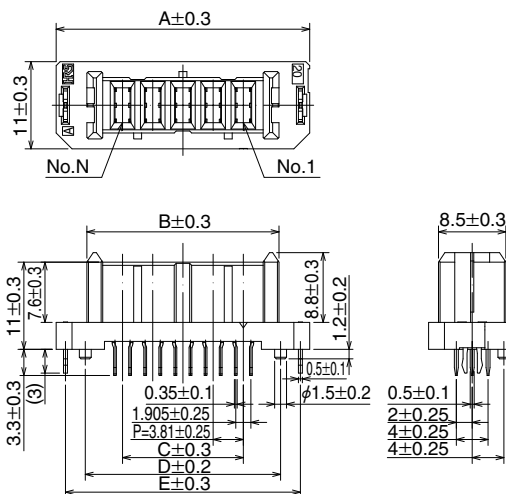

◆ Diagram of recommended PCB layout dimensions

(Note) PCB thickness: t= 1.6 mm

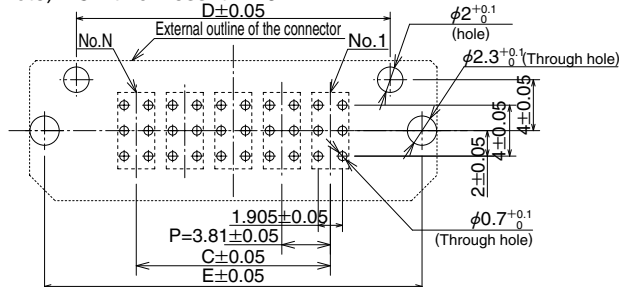

Unit: mm

Product No.	HRS No.	A	B	C	D	E	N (No. of Contacts)
FX30A-2P-3.81DSA20	CL0570-2100-8-00	20.56	12.81	3.81	13.21	18.21	2
FX30A-3P-3.81DSA20	CL0570-2101-0-00	24.37	16.62	7.62	17.02	22.02	3
FX30A-4P-3.81DSA20	CL0570-2102-3-00	28.18	20.43	11.43	20.83	25.83	4
FX30A-5P-3.81DSA20	CL0570-2103-6-00	31.99	24.24	15.24	24.64	29.64	5

◆ Tray Packaging State Diagram

● Right angle receptacle (S-DS type)

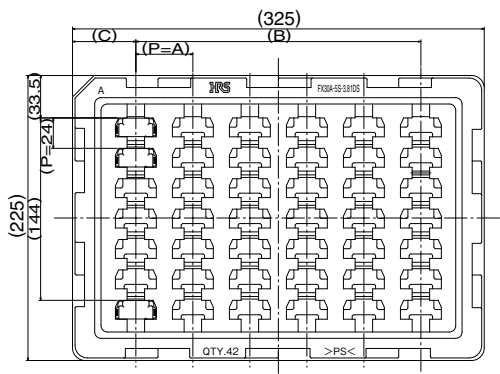

Unit: mm

Product No.	A	B	C	Quantity
FX30A-2S-3.81DS	33	231	47	56
FX30A-3S-3.81DS	37.5	225	50	49
FX30A-4S-3.81DS	45	225	50	42
FX30A-5S-3.81DS				

● Straight header (P-DSA20 type)

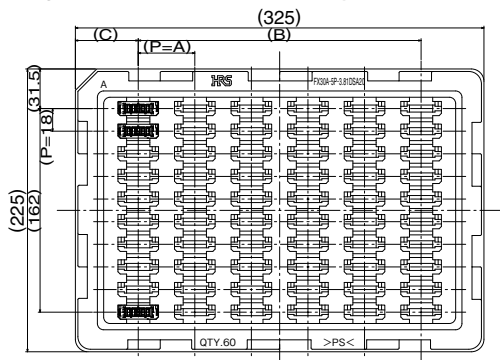

Unit: mm

Product No.	A	B	C	Quantity
FX30A-2P-3.81DSA20	33	231	47	80
FX30A-3P-3.81DSA20	37.5	225	50	70
FX30A-4P-3.81DSA20	45	225	50	60
FX30A-5P-3.81DSA20				

(Note) The tray shape depicted above is just an example. Please check “Delivery Specifications” for the official tray shapes.

◆ Cleaning conditions

● Organic solvent cleaning

Solvent	Room temperature cleaning	Heated cleaning
IPA (isopropyl alcohol)	○	○

● Water Cleaning

When using water cleaner (terpene, alkali saponifier, etc.), please select a cleaner according to the chart of effects to metal and resin issued by each cleaner manufacture. In addition, please make sure that the connectors are not left behind without removing moisture.

● Precautions for Cleaning

If flux or cleaner remains in the connector after it was cleaned using organic solvent or water cleaner, the performance of the connector may deteriorate. Make sure that the connectors are cleaned thoroughly.

◆ Usage precautions

● A position misalignment absorption function is provided in this product. Please use this product within the dimensions shown in the below diagram, while taking into account the connector mounting position misalignments and PCB mating position misalignments.

● The purpose of the position misalignment absorption function provided on this product is to absorb the misalignments between the connector mounting positions and between the PCB mating positions.

This function cannot be used for the purpose to absorb mating position misalignments due to vibrations.

Please use the connectors after the PCBs have been fixed so that the connector positions are fixed securely.

Avoid supporting PCBs by connectors only, and be sure to fix the PCBs using methods other than the connectors.

● This connector is designed to correct minor mating misalignments. This ability creates a structure that allows more for more movement and shifting between its pieces than with other similar connectors. The PCB boards need to be secured as well. If they are not, vibration or other external forces will cause the connectors to become unmated.

● This product has a structure to absorb position misalignments by the spring displacement of the contacts in pitch directions. Therefore, **a spring reaction force will be generated in the pitch directions when absorbing the position misalignments** (Approximately 4 N per 1 core) Please make sure that the structure bodies (positioning pins, screws, guiding rails, and other connectors, etc.) that will be used as the positioning base have enough strength against the spring reaction force.

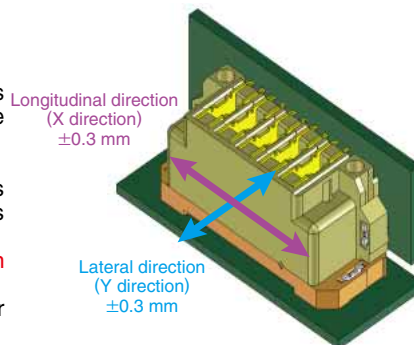

● **Allowable Mating Gap**

The effective mating length of this product is 2 mm. Use the connectors so that the gap between the header and receptacle when they are mated is within 1 mm. Particularly make sure the gap does not exceed 1 mm due to warping of PCB, etc.

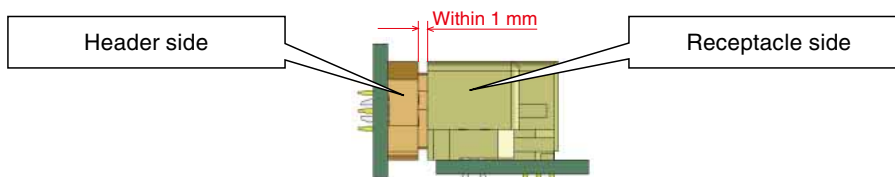

Vertical connection type

● A reverse insertion prevention structure and an abnormal mating position prevention structure have been provided in this connector, however, if the connectors are mated with an excessive force, connector breakage may result. Avoid improper mating of connectors by applying an excessive force and connect them correctly while confirming the connector polarities shown below. shown below. tors by applying an excessive force and connect them correctly while confirming the connector polarities shown below.

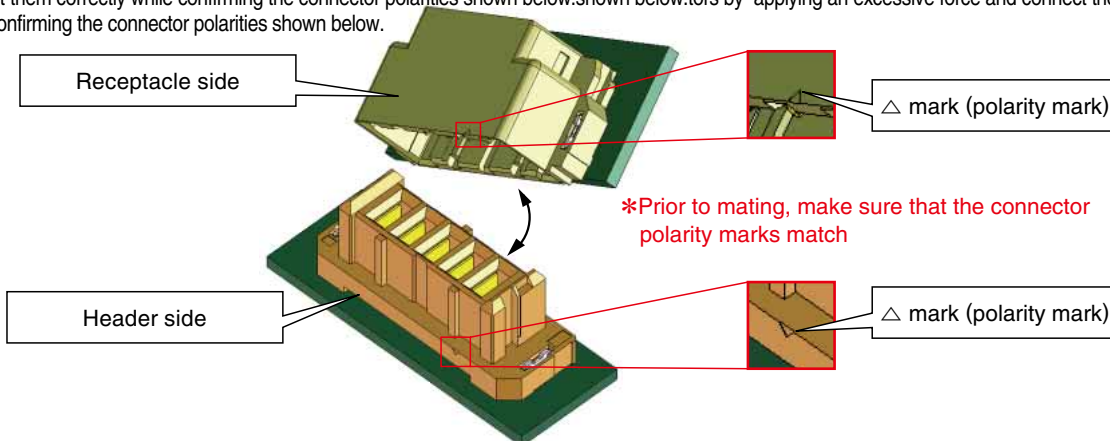

● A structure in which the contact deformation does not occur under normal mating operations has been provided on this connector, however, please make sure of the following; connector edge does not come to contact with the opening for mating, connectors are not mated diagonally in an abnormal manner, and foreign substances or hard objects, etc. do not touch the contacts. Pay attention so that contact deformation which causes a contact defect does not occur.

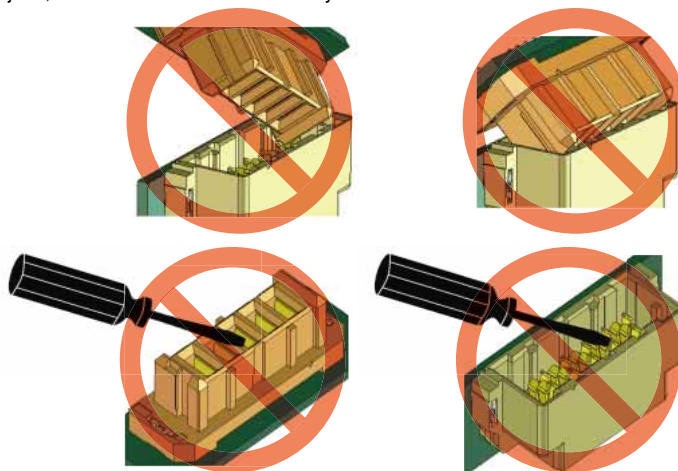

● If the connector is inserted/extracted forcibly in a wrong direction or it is rotated when inserting/extracting, a connector breakdown or contact defect may result. Please be careful.



● This product **cannot be used for the purpose of current interruption application.** (Prohibition of hot-swapping)



HIROSE ELECTRIC CO.,LTD.

6-3,Nakagawa Chuoh-2-Chome,Tsuzuki-Ku,Yokohama-Shi 224-8540,JAPAN
 TEL: +81-45-620-3526 Fax: +81-45-591-3726
<http://www.hirose.com>
<http://www.hirose-connectors.com>