

# Product datasheet

Specifications



inductive sensor XS2 M12 - L44mm  
- brass - Sn4mm - 12..24VDC -  
cable 5m

XS212BLPAL5

## Main

Range of product	Telemecanique Inductive proximity sensors XS
Series name	General purpose
Sensor type	Inductive proximity sensor
Sensor name	XS2
Sensor design	Cylindrical M12
Size	44 mm
Body type	Fixed
Enclosure material	Nickel plated brass
Type of output signal	Discrete
Wiring technique	3-wire
[Sn] nominal sensing distance	4 mm
Discrete output function	1 NO
Discrete output type	PNP
Electrical connection	Cable
Cable length	5 m
[Us] rated supply voltage	12...24 V DC with reverse polarity protection
Switching capacity in mA	<= 200 mA with overload and short-circuit protection
IP degree of protection	IP67 conforming to IEC 60529

## Complementary

ISO thread	M12 x 1
Detection face	Frontal
Detector flush mounting acceptance	Non flush mountable
Material	Metal
Front material	PBT
Operating zone	0...3.2 mm
Differential travel	1...15% of Sr
Output circuit type	DC

Cable composition	3 x 0.14 mm <sup>2</sup>
Wire insulation material	PVC
Status LED	Output state: 1 LED (yellow)
Supply voltage limits	10...36 V DC
Switching frequency	<= 1200 Hz
Maximum voltage drop	<2 V (closed)
Current consumption	<= 10 mA no-load
Maximum delay first up	15 ms
Maximum delay response	0.15 ms
Maximum delay recovery	0.4 ms
Marking	CE
Threaded length	26 mm
Length	44 mm
Net weight	0.19 kg

## Environment

Product certifications	UL CSA
Ambient air temperature for operation	-25...70 °C
Ambient air temperature for storage	-40...85 °C
Vibration resistance	25 gn amplitude = +/- 2 mm (f = 10...55 Hz) conforming to IEC 60068-2-6
Shock resistance	50 gn for 11 ms conforming to IEC 60068-2-27

## Packing Units

Unit Type of Package 1	PCE
Number of Units in Package 1	1
Package 1 Weight	140.0 g
Package 1 Height	3 cm
Package 1 width	10.5 cm
Package 1 Length	12.5 cm
Unit Type of Package 2	S02
Number of Units in Package 2	24
Package 2 Weight	3.858 kg
Package 2 Height	15 cm
Package 2 width	30 cm
Package 2 Length	40 cm

## Offer Sustainability

Sustainable offer status	Green Premium product
REACH Regulation	<a href="#">REACH Declaration</a>
EU RoHS Directive	Pro-active compliance (Product out of EU RoHS legal scope) <a href="#">EU RoHS Declaration</a>
Mercury free	Yes

---

<b>RoHS exemption information</b>	<a href="#">Yes</a>
<b>Environmental Disclosure</b>	<a href="#">Product Environmental Profile</a>
<b>Circularity Profile</b>	<a href="#">End of Life Information</a>

---

### **Contractual warranty**

---

<b>Warranty</b>	18 months
-----------------	-----------

---

Dimensions

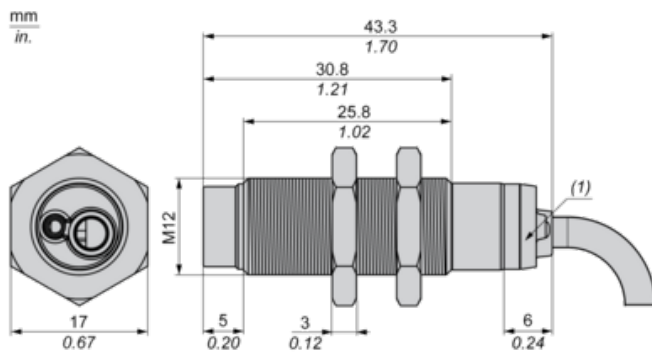

(1) LED

**Minimum Mounting Distances**

---

Side by side

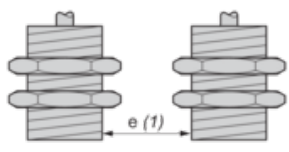

$e (1) \geq 16 \text{ mm}/0.63 \text{ in.}$

Face to face

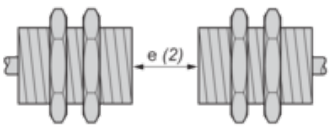

$e (2) \geq 48 \text{ mm}/1.89 \text{ in.}$

Facing a metal object

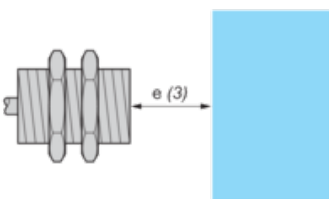

$e (3) \geq 12 \text{ mm}/0.47 \text{ in.}$

Mounted in a metal support

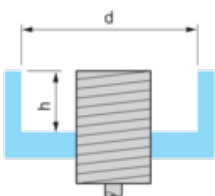

$d \geq 36 \text{ mm}/1.42 \text{ in.}$

$h \geq 8 \text{ mm}/0.31 \text{ in.}$

**Wiring Schemes**

---

**PNP**

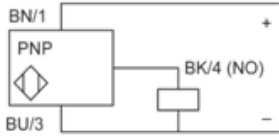

- BU** : Blue
- BN** : Brown
- BK** : Black

Performance Curves

---

Standard Steel Target : 12x12x1 mm

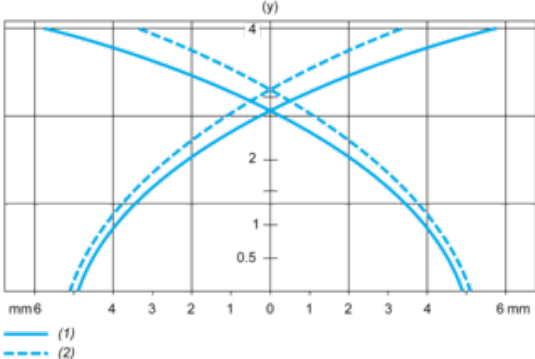

- (1) Pick-up points
- (2) Drop-out points (object approaching from the side)
- (y) Sensing distance in mm