

COMPACT SETS

D 20 EMU-3

SOCKET SET 1/4" 17 pieces

- With forged, tempered UD profile sockets, hand-operated
- With accessories made from GEDORE vanadium steel 31CrV3
- With fine toothed, dial change ratchet
- In plastic case
- Dimensions: 200 x 120 x 38 mm



mm

Code	No.	Ratchet	Sockets	Accessories	↕	📦	£
1815652	D 20 EMU-3	U-3 2093 U-3	D 20 4 4,5 5 5,5 6 7 8 9 10 11 13	2087 2090-4 2095 676 673 6,3	625	1	

D 20 KMU-20

SOCKET SET 1/4" 37 pieces

- With forged, tempered UD profile sockets, hand-operated
- With accessories made from GEDORE vanadium steel 31CrV3
- With robust lever-change reversible ratchet with push-button release
- In plastic case
- Dimensions: 200 x 120 x 38 mm
- TORX® = reg. trademark of Acument Intellectual Properties, LLC. USA



mm

Code	No.	Ratchet	Sockets	Accessories	↕	📦	£
1822373	D 20 KMU-20	U-20 2093	D 20 4 5 6 7 8 9 10 11 12 13 680 4 5,5 6,5 685 3 4 5 6 685 X 5 6 8 687 TX T10 T15 T20 T25 T27 T30 T40 690 1 2 690 PZD 1 2 3	2090-4 620 676 699	712	1	

D 20 KAU-20

SOCKET SET 1/4" 37 pieces

- With forged, tempered UD profile sockets, hand-operated
- With accessories made from GEDORE vanadium steel 31CrV3
- With robust lever-change reversible ratchet with push-button release
- In plastic case
- Dimensions: 200 x 120 x 38 mm
- TORX® = reg. trademark of Acument Intellectual Properties, LLC. USA



"AF"

Code	No.	Ratchet	Sockets	Accessories	↕	📦	£
2010348	D 20 KAU-20	U-20 2093 U-20	D 20 3/16 7/32 1/4 9/32 5/16 11/32 3/8 13/32 7/16 1/2" 680 4 5,5 6,5 685 1/8 5/32 3/16 1/4" 685 X 5 6 8 687 TX T10 T15 T20 T25 T27 T30 T40 690 1 2 690 PZD 1 2 3	2090-4 620 676 699	656	1	

D 20 MOT

BASIC TOOL SET 1/4" FOR MOTORBIKES 30 pieces

- Packed with a basic assortment of tools for emergencies on motorbikes
- In plastic case
- Dimensions: 160 x 95 x 38 mm



mm

Code	No.	Ratchet	Sockets	Accessories	↕	📦	£
2190281	D 20 MOT	U-3 T 2093	D 20 8 9 10 11 12 13 14 685 3 4 5 6 8 10 687 TX T10 T15 T20 T25 T27 T30 T40 690 1 2 3 680 4 6,5	2090 KR-4 2090-6 2095 620	572	1	

D 20 MOT-A

BASIC TOOL SET 1/4" FOR MOTORBIKES 30 pieces

- Packed with a basic assortment of tools for emergencies on motorbikes
- In plastic case
- Dimensions: 160 x 95 x 38 mm



"AF"

Code	No.	Ratchet	Sockets	Accessories	↕	📦	£
2193159	D 20 MOT-A	U-3 T 2093	D 20 1/4 5/16 3/8 13/32 7/16 1/2 9/16" 685 1/8 5/32 3/16 1/4 5/16 3/8" 687 TX T10 T15 T20 T25 T27 T30 T40 690 1 2 3 680 4 6,5	2090 KR-4 2090-6 2095 620	572	1	













D 20 TMU-10

SOCKET SET 1/4" 40 pieces

- ✔ With forged, tempered UD profile sockets, hand-operated
- ✔ With accessories made from GEDORE vanadium steel 31CrV3
- ✔ With robust lever change reversible ratchet
- ✔ In plastic case
- ✔ Dimensions: 200 x 120 x 38 mm
- ✔ TORX® = reg. trademark of Acument Intellectual Properties, LLC. USA



 mm

Code	No.	Ratchet	Sockets	Accessories			£
1815660	D 20 TMU-10	 U-10 2093 U-10	 D 20 4 5 6 7 8 9 10 11 12 13  680 4 6,5  685 3 4 5 6 8  685 X 5 6 8  687 TX T10 T15 T20 T25 T27 T30 T40  690 1 2  690 PZD 1 2 3	620 639 673 6,3  676 699  2095  2090-4	767	1	







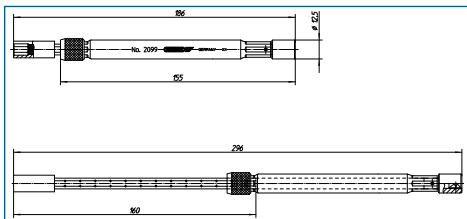
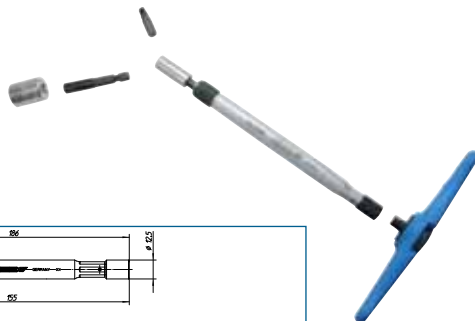



20 XLU-3 T

SOCKET SET 1/4" 37 pieces

- ✔ With forged, tempered hexagon sockets, hand-operated, made from GEDORE vanadium steel 31CrV3
- ✔ Screwdriver bits made from GEDORE vanadium special steel
- ✔ With T-handle ratchet and telescopic extension no. 2099, adjustable from 186-296 mm
- ✔ In plastic case
- ✔ Dimensions: 200 x 120 x 38 mm
- ✔ With "Check-Tool-System": 2-colour foam insert to check that the set is complete
- ✔ TORX® = reg. trademark of Acument Intellectual Properties, LLC. USA



 mm

Code	No.	Ratchet	Sockets	Accessories			£
1888447	20 XLU-3 T	2093 U-3 T	 20 4 5 6 7 8 9 10 11 12 13  680 4 6,5  685 3 4 5 6  685 X 5 6 8  687 TX T8 T9 T10 T15 T20 T25 T27 T30 T40  690 1 2  690 PZD 1 2 3	673 6,3 2099  2095	800	1	

VOLUME SETS

D 20 FMU-20

SET FOR PRECISION MECHANICS 1/4" + 4 MM 52 pieces

- Practical tool set for precision mechanical work
- Includes practical pickup tool for bits, no. 635, for easy replacement of the bits in the socket
- Two ratchets for different applications:
- Fine-toothed reversible lever ratchet no. 2093 U-20 for high-torque
- Bit ratchet no. 471, combined with socket holder no. 673, allows the use of sockets in extremely confined spaces
- With GEDORE Check-Tool-System: 2-colour foam insert to check that the set is complete



Code	No.	Ratchet	Sockets	Accessories	Stk	Box	£
2000237	D 20 FMU-20	471 U-20 2093 U-20	⊖ 480 0,8 1,2 1,5 1,8 ⊙ 485 0,7,0,9 1,3 1,5 ⊕ 490 PH 000 00 0 ⊕ 490 PZD 000 00 0 ⊗ 487 TX T3 T4 T5 T6 T7 T8 ⊖ D 20 4 4,5 5 5,5 6 7 8 ⊙ 685 2 2,5 3 4 5 ⊗ 687 TX T9 T10 T15 T20 T25 ⊕ 690 1 2 ⊕ 690 PZD 1 2 ⊖ ⊕ 6 4x4,5 5x5,5 7x8	← 1090 KR-5 -10 ← 810	810	1	

D 20 WMU-3

SOCKET SET 1/4" 29 pieces

- With forged, tempered UD profile sockets, hand-operated
- Accessories in GEDORE vanadium steel 31CrV3
- With fine toothed, dial change ratchet
- In plastic case
- Dimensions: 275 x 150 x 42 mm



Code	No.	Ratchet	Sockets	Accessories	Stk	Box	£
1815679	D 20 WMU-3	U-3 2093 U-3	⊖ D 20 4 4,5 5 5,5 6 7 8 9 10 11 12 13 ⊖ ⊕ 8 4 5 5,5 6 7 8 9 10 11 13	← 639 673 6,3 ← 676 ⊕ 2095 ← 2090-2 -4	995	1	

20 LMU-10

SOCKET SET 1/4" 49 pieces

- With forged, tempered long hexagon and short UD profile sockets, hand-operated
- Accessories in GEDORE vanadium steel 31CrV3
- With robust lever change reversible ratchet
- In plastic case
- Dimensions: 275 x 150 x 42 mm
- With GEDORE Check-Tool-System: 2-colour foam insert to check that the set is complete
- TORX* = reg. trademark of Acument Intellectual Properties, LLC. USA

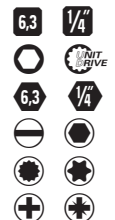

Code	No.	Ratchet	Sockets	Accessories	Stk	Box	£
1815687	20 LMU-10	U-10 2093 U-10	⊖ D 20 4 5 6 7 8 9 10 11 12 13 ⊙ 20 L 4 4,5 5 6 7 8 9 10 12 13 ⊖ 680 4 6,5 ⊙ 685 3 4 5 6 8 ⊙ 685 X 5 6 8 ⊗ 687 TX T10 T15 T20 T25 T27 T30 T40 ⊕ 690 1 2 ⊕ 690 PZD 1 2 3	← 620 ← 676 ← 699 ← 2090-2 -6 ⊕ 2095	1262	1	

STANDARD SETS

20 EM



















SOCKET SET 1/4" 16 pieces

- ✔ With forged, tempered hexagon sockets, hand-operated
- ✔ With accessories made from GEDORE vanadium steel 31CrV3
- ✔ Set U-10 with reversible with lever change ratchet
- ✔ Set U-3 with fine toothed, dial change ratchet
- ✔ Set Z-94 with ratchet with square coupler
- ✔ In plastic case
- ✔ Dimensions: 200 x 120 x 38 mm



6,3
1/4" 

 mm

Code	No.	Ratchet	Sockets	Accessories	WT	PK	£
6172100	20 EMZ	 Z-94 2093 Z-94	 20 4 4,5 5 5,5 6 7 8 9 10 11 13	 2087  2090-4  2095  2098	761	1	
6172290	20 EMU-3	 U-3 2093 U-3	 20 4 4,5 5 5,5 6 7 8 9 10 11 13	 2087  2090-4  2095  2098	776	1	
6162220	20 EMU-10	 U-10 2093 U-10	 20 4 4,5 5 5,5 6 7 8 9 10 11 13	 2087  2090-4  2095  2098	790	1	

20 EAU-3

SOCKET SET 1/4" 14 pieces

- ✔ With forged, tempered hexagon sockets, hand-operated
- ✔ With accessories made from GEDORE vanadium steel 31CrV3
- ✔ With extra fine toothed, dial change ratchet
- ✔ In plastic case
- ✔ Dimensions: 200 x 120 x 38 mm



6,3
1/4" 

 "AF

Code	No.	Ratchet	Sockets	Accessories	WT	PK	£
6172450	20 EAU-3	 U-3 2093 U-3	 20 3/16 7/32 1/4 9/32 5/16 11/32 3/8 7/16 1/2"	 2087  2090-4  2095  2098	767	1	

20 IMU-3

SOCKET SET 1/4" 32 pieces

- ✔ With forged, tempered hexagon sockets, hand-operated
- ✔ With accessories made from GEDORE vanadium steel 31CrV3
- ✔ With fine toothed, dial change ratchet
- ✔ In plastic case
- ✔ Dimensions: 275 x 150 x 42 mm













6,3
1/4" 





 mm

Code	No.	Ratchet	Sockets	Accessories	WT	PK	£
6174150	20 IMU-3	 U-3 2093 U-3	 20 4 5 6 7 8 9 10 11 12 13 14  IS 20 4 5,5 6,5 8  IN 20 3 4 5 6 8  IKS 20 1 2 3  IKS 20 PZD 1 2 3	 2087  2090-2 -6  2095  2098	1298	1	