



Junction Box

NEMA 1 Sheet Metal Junction Box With Lift-off Screw Cover



This heavy duty steel **junction box** is well suited for a variety of junction and pull box electrical applications.

Design Features

- Heavy duty 16 GA welded steel construction
- Screwed on flat cover with key holes for easy assembly
- Boxes with knockouts have easily removable concentric knockouts on all four sides for industry standard conduit sizes
- Four wall mounting holes in back
- Embossed grounding hole in bottom allows easy access and flush wall mounting.
- Durable ANSI 65 Grey Powder coating
- Complies with NEMA and UL Type 1 rating
- UL listing pending

PART NAME

JUNCTION BOX

PART No.

JB-3954

REVISION DATE

7-18-11

MATERIAL - 16 GA. [1.5mm] STEEL
FINISH - SMOOTH GRAY POWDERCOAT

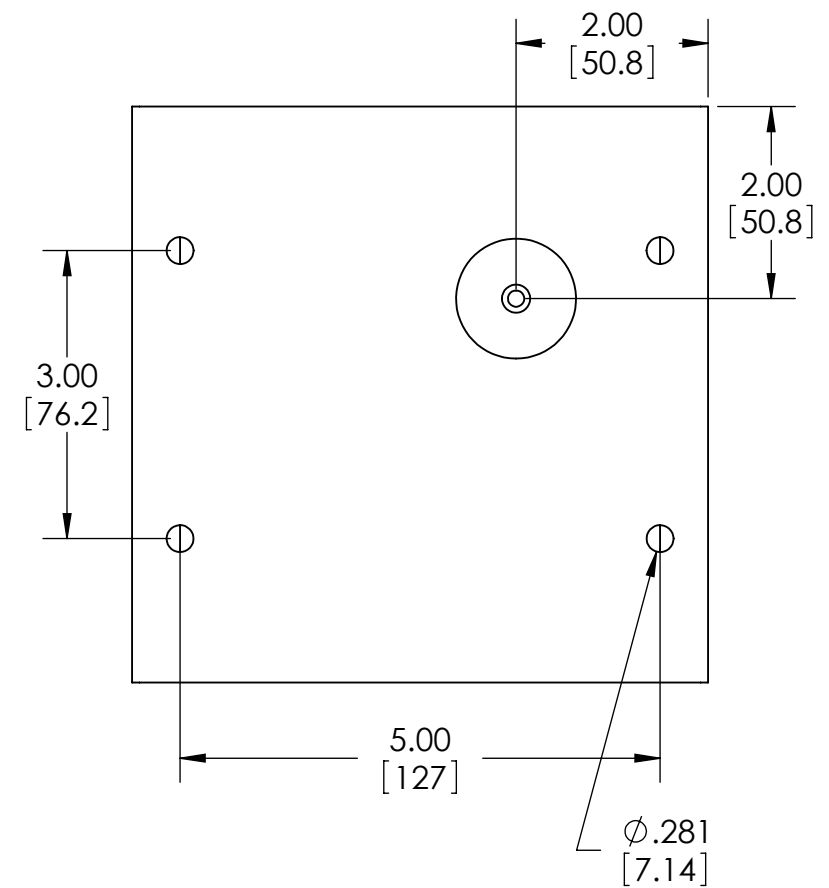
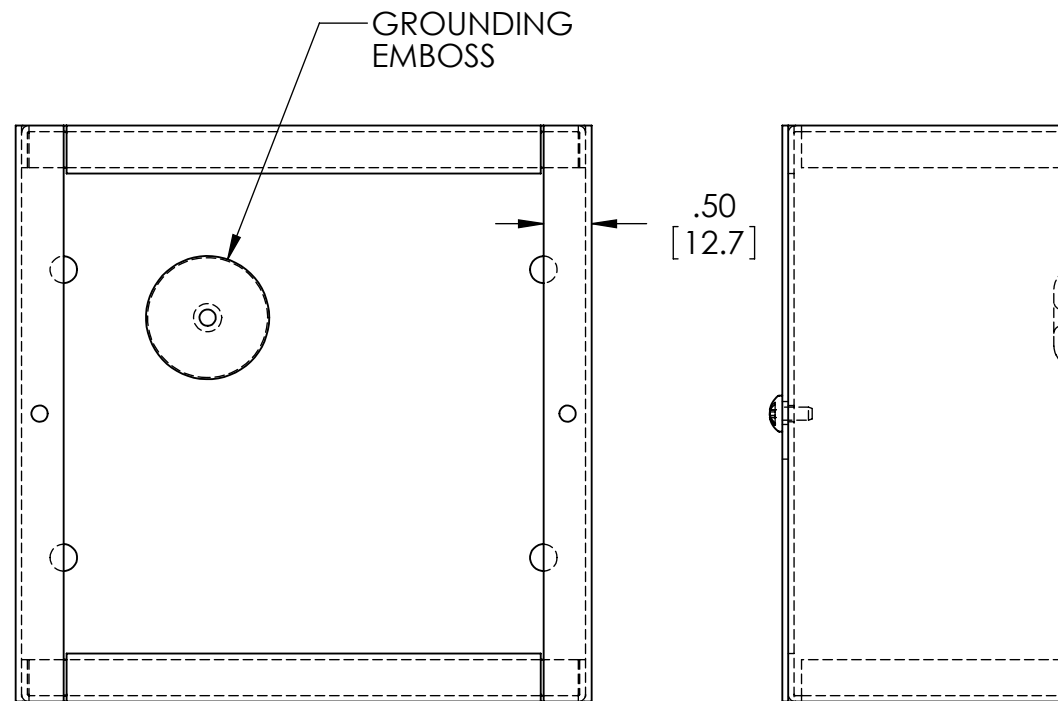
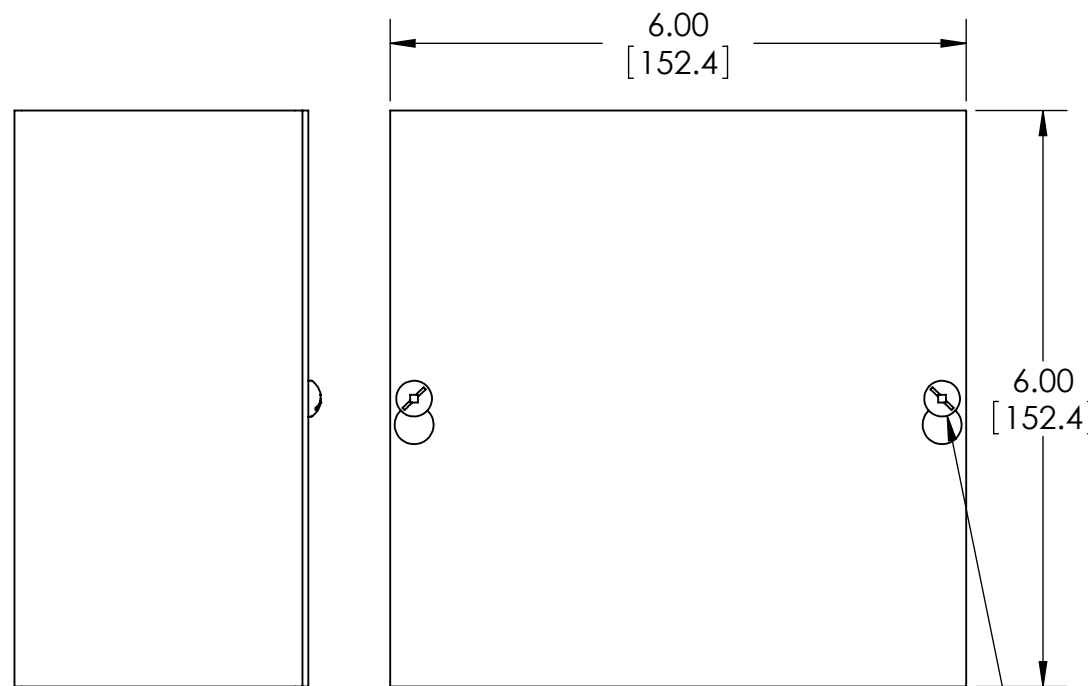
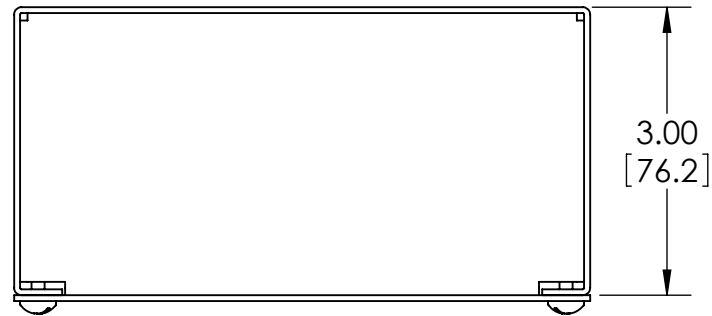
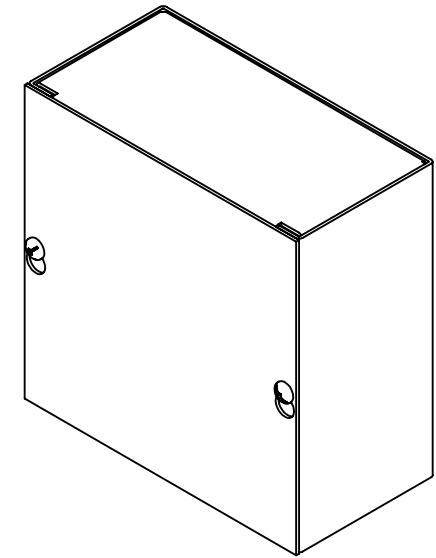

COVER REMOVED

SCREWS: #10-32 x .31" [8mm] LG.
MACHINE, PAN HEAD, SLOTTED/SQUARE
COMBINATION STYLE DRIVE, STEEL, ZINC PLATED.
(SUPPLIED FOR COVER MOUNTING AND
FOR GROUND POINT).

