

# SQUARE NUT 30 M 04 WITH POSITION-FIXING, ESD CONDUCTIVE

Article Nr. 21.2340/2

[See the product on the website →](#)

[Download CAD Files →](#)

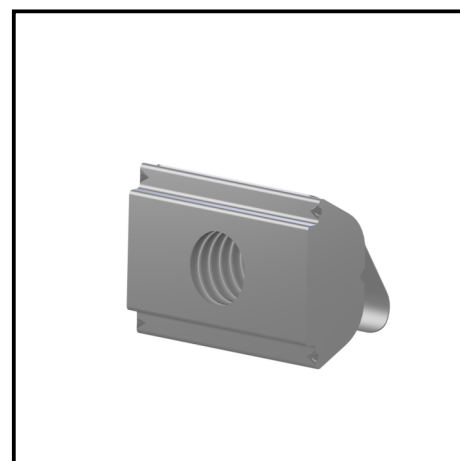
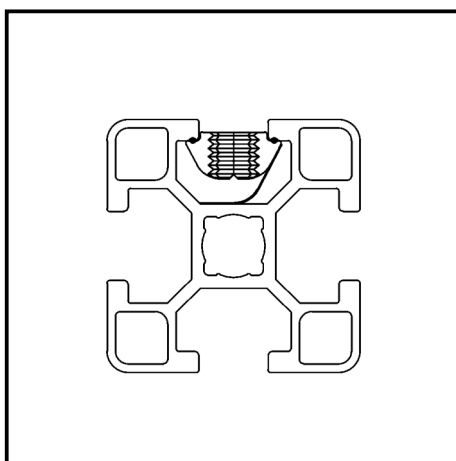
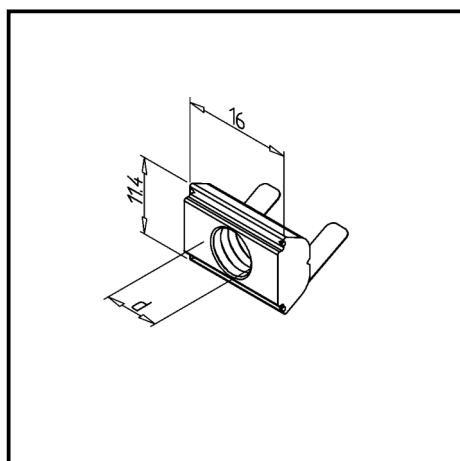

## TECHN. DATA / ITEMS SUPPLIED

- Steel, galvanized
- Thread (d) : M 4
- Conductive, also suitable for ESD applications
- Weight = 0.005 kg/piece

## APPLICATIONS

- The spring plate holds the nut in the desired position
- Sliding nuts can be swiveled into the profile (series 45) at any point

## ASSEMBLY

- Mounting by swiveling into the groove