







power contactor AC-1 1050 A / 690 V / 40 °C 3-pole, U_c: 110-127 V AC(50-60 Hz) / 100-110 V DC, drive: conventional auxiliary contacts 2 NO + 2 NC main circuit: busbar control and auxiliary circuit: screw terminal

product brand name	SIRIUS
product designation	Contacteur
product type designation	3RT14
General technical data	
product extension	
• function module for communication	No
• auxiliary switch	Yes
power loss [W] for rated value of the current	
• at AC in hot operating state	510 W
• at AC in hot operating state per pole	170 W
• without load current share typical	6 W
type of calculation of power loss depending on pole	quadratic
insulation voltage	
• of main circuit with degree of pollution 3 rated value	1 000 V
• of auxiliary circuit with degree of pollution 3 rated value	600 V
surge voltage resistance	
• of main circuit rated value	8 kV
• of auxiliary circuit rated value	6 kV
shock resistance with sine pulse	
• at AC	8g / 11 ms
• at DC	8g / 11 ms
mechanical service life (operating cycles)	
• of contactor typical	1 000 000
Substance Prohibition (Date)	03/27/2020
SVHC substance name	Lead - 7439-92-1
Net Weight	20.1 kg
Ambient conditions	
installation altitude at height above sea level maximum	2 000 m
ambient temperature	
• during operation	-25 ... +55 °C
• during storage	-40 ... +80 °C
relative humidity minimum	10 %
relative humidity at 55 °C according to IEC 60068-2-30 maximum	95 %
Main circuit	
number of poles for main current circuit	3
number of NO contacts for main contacts	3
number of NC contacts for main contacts	0
type of voltage for main current circuit	AC

operational current	
<ul style="list-style-type: none"> ● at AC-1 <ul style="list-style-type: none"> — up to 690 V at ambient temperature 40 °C rated value — up to 690 V at ambient temperature 55 °C rated value — up to 1000 V at ambient temperature 40 °C rated value — up to 1000 V at ambient temperature 55 °C rated value 	<p>1 050 A</p> <p>1 050 A</p> <p>1 050 A</p> <p>1 050 A</p>
minimum cross-section in main circuit at maximum AC-1 rated value	800 mm ²
no-load switching frequency	
<ul style="list-style-type: none"> ● at AC ● at DC 	<p>600 1/h</p> <p>600 1/h</p>
operating frequency at AC-1 maximum	600 1/h
Control circuit/ Control	
type of voltage of the control supply voltage	AC/DC
control supply voltage at AC	
<ul style="list-style-type: none"> ● at 50 Hz rated value ● at 60 Hz rated value 	<p>100 ... 127 V</p> <p>100 ... 127 V</p>
control supply voltage at DC rated value	100 ... 110 V
operating range factor control supply voltage rated value of magnet coil at DC	
<ul style="list-style-type: none"> ● initial value ● full-scale value 	<p>0.85</p> <p>1.1</p>
operating range factor control supply voltage rated value of magnet coil at AC	
<ul style="list-style-type: none"> ● at 50 Hz ● at 60 Hz 	<p>0.85 ... 1.1</p> <p>0.85 ... 1.1</p>
design of the surge suppressor	with varistor
apparent pick-up power of magnet coil at AC	
<ul style="list-style-type: none"> ● at 50 Hz ● at 60 Hz 	<p>1 000 VA</p> <p>1 000 VA</p>
apparent holding power of magnet coil at AC	
<ul style="list-style-type: none"> ● at 50 Hz ● at 60 Hz 	<p>18 VA</p> <p>18 VA</p>
closing power of magnet coil at DC	1 400 W
holding power of magnet coil at DC	6 W
closing delay	
<ul style="list-style-type: none"> ● at AC ● at DC 	<p>80 ms</p> <p>80 ms</p>
opening delay	
<ul style="list-style-type: none"> ● at AC ● at DC 	<p>70 ms</p> <p>70 ms</p>
control version of the switch operating mechanism	Standard A1 - A2
Auxiliary circuit	
number of NC contacts for auxiliary contacts	2
<ul style="list-style-type: none"> ● attachable ● instantaneous contact 	<p>4</p> <p>2</p>
number of NO contacts for auxiliary contacts	2
<ul style="list-style-type: none"> ● attachable ● instantaneous contact 	<p>4</p> <p>2</p>
operational current at AC-12 maximum	16 A
operational current at AC-15	
<ul style="list-style-type: none"> ● at 230 V rated value ● at 400 V rated value ● at 500 V rated value 	<p>3 A</p> <p>1.5 A</p> <p>1.4 A</p>
operational current at DC-13	
<ul style="list-style-type: none"> ● at 48 V rated value ● at 60 V rated value 	<p>2 A</p> <p>2 A</p>

<ul style="list-style-type: none"> • at 110 V rated value • at 125 V rated value • at 220 V rated value • at 600 V rated value 	1 A 0.55 A 0.27 A 0.1 A	
Short-circuit protection		
design of the fuse link <ul style="list-style-type: none"> • for short-circuit protection of the main circuit <ul style="list-style-type: none"> — with type of coordination 2 required • for short-circuit protection of the auxiliary switch required 	aR: 1100 A (1000 V, 42 kA) gG: 16 A (600 V, 1 kA)	
Installation/ mounting/ dimensions		
mounting position	+/-30° rotation possible on vertical mounting surface; can be tilted forward and backward by +/- 30° on vertical mounting surface	
fastening method side-by-side mounting	No	
fastening method	screw fixing	
height	352 mm	
width	285 mm	
depth	250 mm	
required spacing <ul style="list-style-type: none"> • for grounded parts <ul style="list-style-type: none"> — forwards — at the side 	125 mm 75 mm	
net weight	22 kg	
Connections/ Terminals		
type of electrical connection <ul style="list-style-type: none"> • for main current circuit • for auxiliary and control circuit • at contactor for auxiliary contacts • of magnet coil 	busbar connection screw-type terminals Screw-type terminals Screw-type terminals	
width of connection bar	40 mm	
thickness of connection bar	10 mm	
diameter of holes	17 mm	
connectable conductor cross-section for auxiliary contacts <ul style="list-style-type: none"> • solid or stranded • finely stranded with core end processing 	1 ... 2.5 mm ² 1 ... 2.5 mm ²	
type of connectable conductor cross-sections <ul style="list-style-type: none"> • for auxiliary contacts <ul style="list-style-type: none"> — solid — solid or stranded — finely stranded with core end processing • for AWG cables for auxiliary contacts 	2x (1 ... 2,5 mm ²) 2x (1 ... 2.5 mm ²) 2x (1 ... 2,5 mm ²) 2x (16 ... 14)	
AWG number as coded connectable conductor cross section for auxiliary contacts	16 ... 14	
Safety related data		
product function <ul style="list-style-type: none"> • mirror contact according to IEC 60947-4-1 • positively driven operation according to IEC 60947-5-1 	Yes No	
service life maximum	20 a	
Electrical Safety		
protection class IP on the front according to IEC 60529	IP00	
Approvals Certificates		
Environment	General Product Approval	
Environmental Conformations	    	
EMV	other	Railway



[Confirmation](#)

[Miscellaneous](#)

[Special Test Certificate](#)

Further information

Information on the packaging

<https://support.industry.siemens.com/cs/ww/en/view/109813875>

Information for data generation and storage

<https://support.industry.siemens.com/cs/ww/en/view/109995012>

Information- and Downloadcenter (Catalogs, Brochures,...)

<https://www.siemens.com/ic10>

Industry Mall (Online ordering system)

<https://mall.industry.siemens.com/mall/en/en/Catalog/product?mlfb=3RT1482-6AF36>

Service&Support (Manuals, Certificates, Characteristics, FAQs,...)

<https://support.industry.siemens.com/cs/ww/en/ps/3RT1482-6AF36>

Image database (product images, 2D dimension drawings, 3D models, device circuit diagrams, EPLAN macros, ...)

https://www.automation.siemens.com/bilddb/cax_de.aspx?mlfb=3RT1482-6AF36&lang=en

Cax online generator

<https://support.automation.siemens.com/WW/CAXorder/default.aspx?lang=en&mlfb=3RT1482-6AF36>

Characteristic curves

[https://curves.simaris.siemens.com/curves/<mmp_prod_noCOMP="HAUPT"></mmp_prod_no>](https://curves.simaris.siemens.com/curves/<mmp_prod_noCOMP=)

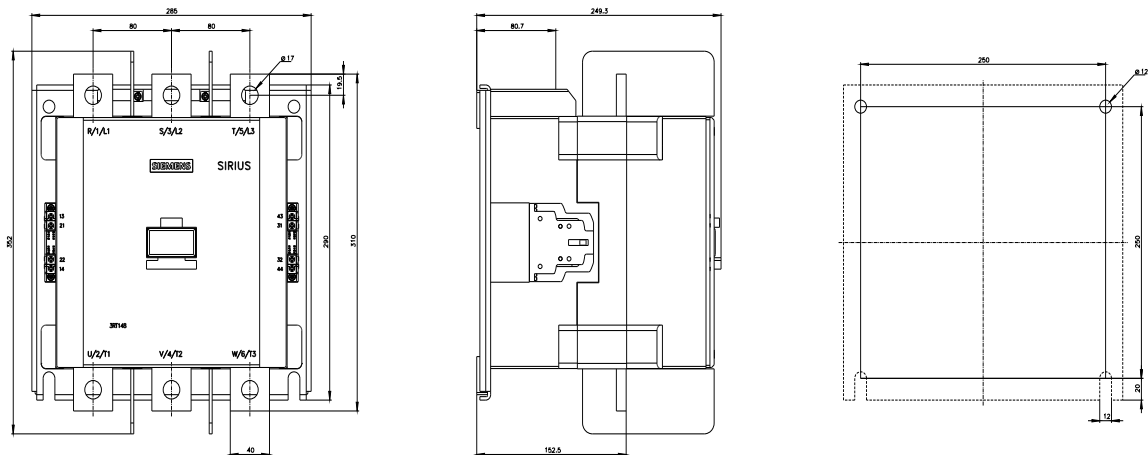

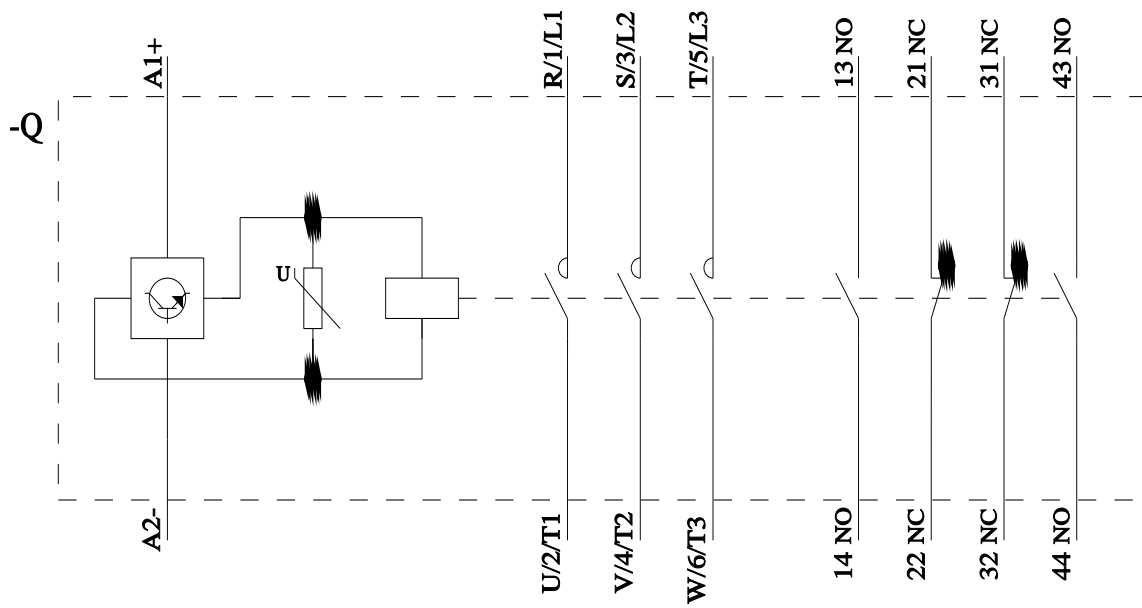

last modified:

12/16/2025