

## Isolation 3/2-way valves - Series MX

Product code: MX2-3/4-V01

Datasheet creation date: 11/12/2025 08:35

Check the most updated document online [click here](#)



### TECHNICAL DATA

<b>Series</b>	MX
<b>Size</b>	2
<b>Ports (IN - OUT)</b>	3/4 = G3/4
<b>3/2-way valve</b>	V
<b>Design type</b>	01 = lockable manual control
<b>Flow direction</b>	= from left to right (standard)

## Isolation 3/2-way valves - Series MX

Product code: MX2-3/4-V01

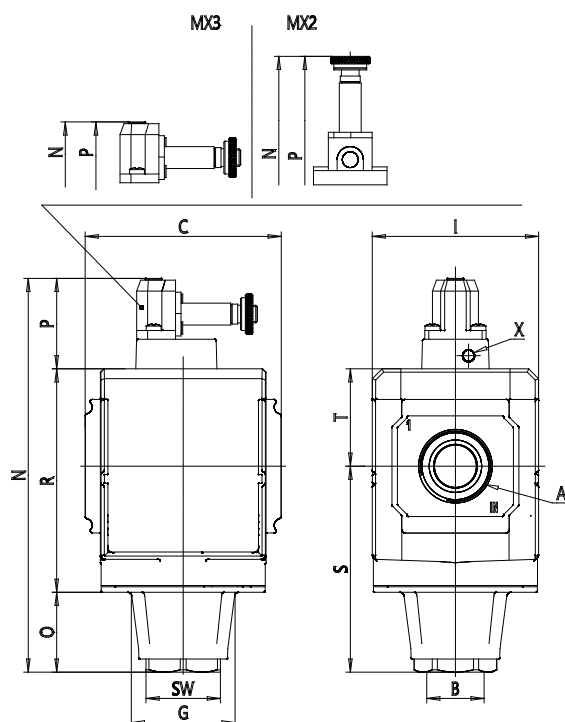

### DIMENSIONS

	G3/4
(mm)	G 1/2
(mm)	70.0
(mm)	26
(mm)	34.5
(mm)	68
(mm)	9
(mm)	8
(mm)	152.0
(mm)	13
(mm)	51.0
(mm)	31
(mm)	88
(mm)	63.5
(mm)	27
(mm)	37.5
	-
Y (piloting)	-
Weight (kg)	0.5