

P	LTR	DESCRIPTION	DATE	DWN	APVD
	BA	INITIAL DRAWING RELEASE	29NOV2023	DM	AP

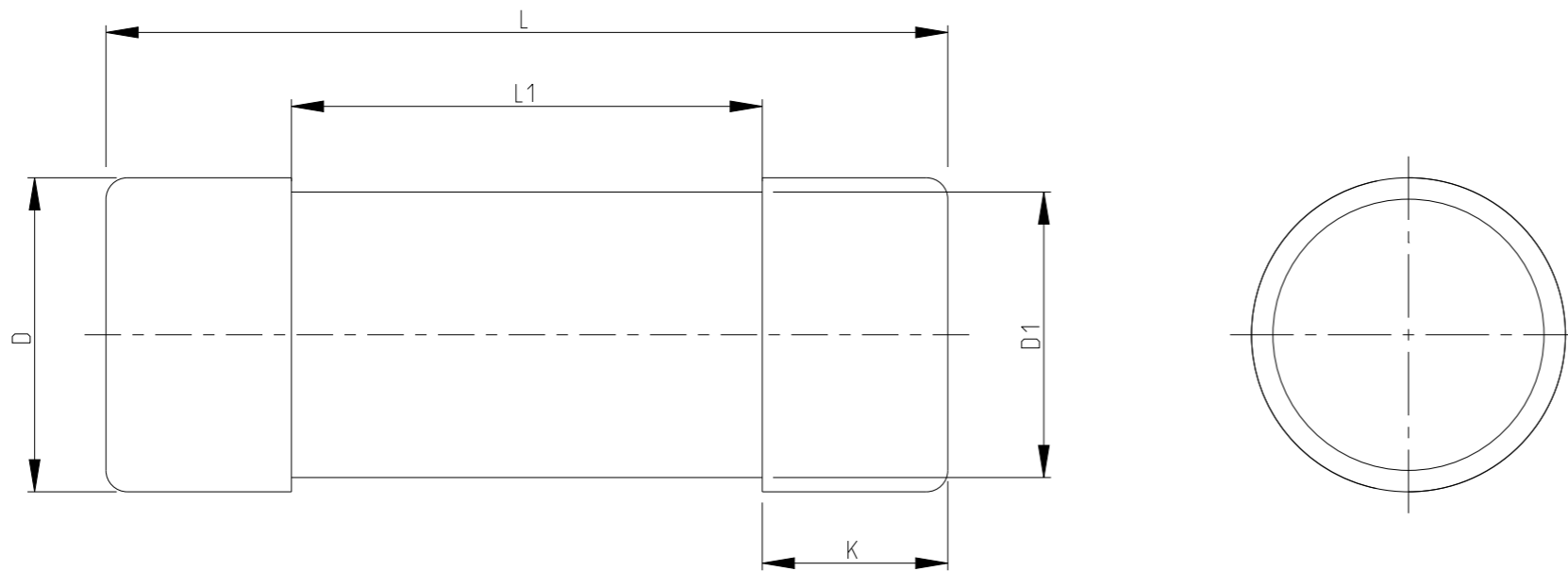

FOR FURTHER INFORMATION SEE DATA SHEET OF METAL FILM PRECISION MELF RESISTOR AEC-Q200 QUALIFIED TYPE SMA-Q SERIES

RECOMMENDED LAND PATTERN

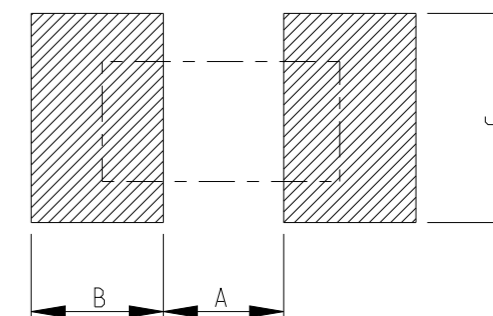

TYPE	L (mm)	L1 min. (mm)	$\varnothing D$ (mm)	$\varnothing D1$ (mm)	K (mm)	WEIGHT MG EA
SMA-Q 0207	5.9 ± 0.2	2.9	2.2 ± 0.2	$D +0/-0.2$	1.3 ± 0.1	80.9

SIZE	A (mm)	B (mm)	C (mm)
SMA-Q 0207	3.0	1.7	2.4

RoHS Compliant

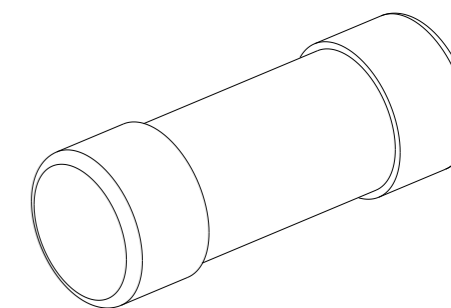

THIS DRAWING IS A CONTROLLED DOCUMENT.		DWN DHEERAJ M 29NOV2023	 TE Connectivity	
DIMENSIONS: mm		CHK TRACY G 29NOV2023		
TOLERANCES UNLESS OTHERWISE SPECIFIED:		APVD ALLAN P 29NOV2023	NAME METAL FILM PRECISION MELF RESISTORS AEC-Q200 QUALIFIED TYPE SMA-Q 0207 SERIES	
0 PLC ± 0.2 1 PLC ± 0.1 2 PLC \pm 3 PLC \pm 4 PLC \pm ANGLES $\pm 5^\circ$		PRODUCT SPEC -	RESTRICTED TO -	
MATERIAL -		FINISH -	APPLICATION SPEC -	SIZE A3
		WEIGHT -	CAGE CODE 00779	DRAWING NO C=2176666
		CUSTOMER DRAWING	SCALE 20:1	SHEET 1 OF 3
				REV BA

REVISIONS

P	LTR	DESCRIPTION	DATE	DWN	APVD
	-	SEE SHEET 1	-	-	-

SCHEDULE

TCPN	CATALOGUE NUMBER	PART DESCRIPTION	PART STATUS
2176666-1	SMA-Q0207BTCT105R	MELF SMA-Q 105R 0.1% 25PPM 0207 1W	PRODUCTION
2176666-2	SMA-Q0207BTCT107R	MELF SMA-Q 107R 0.1% 25PPM 0207 1W	PRODUCTION
2176666-3	SMA-Q0207BTCT110R	MELF SMA-Q 110R 0.1% 25PPM 0207 1W	PRODUCTION
2176666-4	SMA-Q0207BTCT113R	MELF SMA-Q 113R 0.1% 25PPM 0207 1W	PRODUCTION
2176666-5	SMA-Q0207BTCT115R	MELF SMA-Q 115R 0.1% 25PPM 0207 1W	PRODUCTION
2176666-6	SMA-Q0207BTCT118R	MELF SMA-Q 118R 0.1% 25PPM 0207 1W	PRODUCTION
2176666-7	SMA-Q0207BTCT121R	MELF SMA-Q 121R 0.1% 25PPM 0207 1W	PRODUCTION
2176666-8	SMA-Q0207BTCT124R	MELF SMA-Q 124R 0.1% 25PPM 0207 1W	PRODUCTION
2176666-9	SMA-Q0207BTCT127R	MELF SMA-Q 127R 0.1% 25PPM 0207 1W	PRODUCTION
1-2176666-0	SMA-Q0207BTCT130R	MELF SMA-Q 130R 0.1% 25PPM 0207 1W	PRODUCTION
1-2176666-1	SMA-Q0207BTCT133R	MELF SMA-Q 133R 0.1% 25PPM 0207 1W	PRODUCTION
1-2176666-2	SMA-Q0207BTCT137R	MELF SMA-Q 137R 0.1% 25PPM 0207 1W	PRODUCTION
1-2176666-3	SMA-Q0207BTCT140R	MELF SMA-Q 140R 0.1% 25PPM 0207 1W	PRODUCTION
1-2176666-4	SMA-Q0207BTCT143R	MELF SMA-Q 143R 0.1% 25PPM 0207 1W	PRODUCTION
1-2176666-5	SMA-Q0207BTCT147R	MELF SMA-Q 147R 0.1% 25PPM 0207 1W	PRODUCTION
1-2176666-6	SMA-Q0207BTCT150R	MELF SMA-Q 150R 0.1% 25PPM 0207 1W	PRODUCTION
1-2176666-7	SMA-Q0207BTCT154R	MELF SMA-Q 154R 0.1% 25PPM 0207 1W	PRODUCTION
1-2176666-8	SMA-Q0207BTCT158R	MELF SMA-Q 158R 0.1% 25PPM 0207 1W	PRODUCTION
1-2176666-9	SMA-Q0207BTCT162R	MELF SMA-Q 162R 0.1% 25PPM 0207 1W	PRODUCTION
2-2176666-0	SMA-Q0207BTCT165R	MELF SMA-Q 165R 0.1% 25PPM 0207 1W	PRODUCTION
2-2176666-1	SMA-Q0207BTCT169R	MELF SMA-Q 169R 0.1% 25PPM 0207 1W	PRODUCTION
2-2176666-2	SMA-Q0207BTCT174R	MELF SMA-Q 174R 0.1% 25PPM 0207 1W	PRODUCTION
2-2176666-3	SMA-Q0207BTCT178R	MELF SMA-Q 178R 0.1% 25PPM 0207 1W	PRODUCTION
2-2176666-4	SMA-Q0207BTCT182R	MELF SMA-Q 182R 0.1% 25PPM 0207 1W	PRODUCTION
2-2176666-5	SMA-Q0207BTCT187R	MELF SMA-Q 187R 0.1% 25PPM 0207 1W	PRODUCTION
2-2176666-6	SMA-Q0207BTCT191R	MELF SMA-Q 191R 0.1% 25PPM 0207 1W	PRODUCTION
2-2176666-7	SMA-Q0207BTCT196R	MELF SMA-Q 196R 0.1% 25PPM 0207 1W	PRODUCTION
2-2176666-8	SMA-Q0207BTCT200R	MELF SMA-Q 200R 0.1% 25PPM 0207 1W	PRODUCTION
2-2176666-9	SMA-Q0207BTCT205R	MELF SMA-Q 205R 0.1% 25PPM 0207 1W	PRODUCTION
3-2176666-0	SMA-Q0207BTCT210R	MELF SMA-Q 210R 0.1% 25PPM 0207 1W	PRODUCTION
3-2176666-1	SMA-Q0207BTCT215R	MELF SMA-Q 215R 0.1% 25PPM 0207 1W	PRODUCTION
3-2176666-2	SMA-Q0207BTCT221R	MELF SMA-Q 221R 0.1% 25PPM 0207 1W	PRODUCTION
3-2176666-3	SMA-Q0207BTCT226R	MELF SMA-Q 226R 0.1% 25PPM 0207 1W	PRODUCTION

SCHEDULE

TCPN	CATALOGUE NUMBER	PART DESCRIPTION	PART STATUS
3-2176666-4	SMA-Q0207BTCT232R	MELF SMA-Q 232R 0.1% 25PPM 0207 1W	PRODUCTION
3-2176666-5	SMA-Q0207BTCT237R	MELF SMA-Q 237R 0.1% 25PPM 0207 1W	PRODUCTION
3-2176666-6	SMA-Q0207BTCT243R	MELF SMA-Q 243R 0.1% 25PPM 0207 1W	PRODUCTION
3-2176666-7	SMA-Q0207BTCT249R	MELF SMA-Q 249R 0.1% 25PPM 0207 1W	PRODUCTION
3-2176666-8	SMA-Q0207BTCT255R	MELF SMA-Q 255R 0.1% 25PPM 0207 1W	PRODUCTION
3-2176666-9	SMA-Q0207BTCT261R	MELF SMA-Q 261R 0.1% 25PPM 0207 1W	PRODUCTION
4-2176666-0	SMA-Q0207BTCT267R	MELF SMA-Q 267R 0.1% 25PPM 0207 1W	PRODUCTION
4-2176666-1	SMA-Q0207BTCT274R	MELF SMA-Q 274R 0.1% 25PPM 0207 1W	PRODUCTION
4-2176666-2	SMA-Q0207BTCT280R	MELF SMA-Q 280R 0.1% 25PPM 0207 1W	PRODUCTION
4-2176666-3	SMA-Q0207BTCT287R	MELF SMA-Q 287R 0.1% 25PPM 0207 1W	PRODUCTION
4-2176666-4	SMA-Q0207BTCT294R	MELF SMA-Q 294R 0.1% 25PPM 0207 1W	PRODUCTION
4-2176666-5	SMA-Q0207BTCT301R	MELF SMA-Q 301R 0.1% 25PPM 0207 1W	PRODUCTION
4-2176666-6	SMA-Q0207BTCT309R	MELF SMA-Q 309R 0.1% 25PPM 0207 1W	PRODUCTION
4-2176666-7	SMA-Q0207BTCT316R	MELF SMA-Q 316R 0.1% 25PPM 0207 1W	PRODUCTION
4-2176666-8	SMA-Q0207BTCT324R	MELF SMA-Q 324R 0.1% 25PPM 0207 1W	PRODUCTION
4-2176666-9	SMA-Q0207BTCT332R	MELF SMA-Q 332R 0.1% 25PPM 0207 1W	PRODUCTION
5-2176666-0	SMA-Q0207BTCT340R	MELF SMA-Q 340R 0.1% 25PPM 0207 1W	PRODUCTION
5-2176666-1	SMA-Q0207BTCT348R	MELF SMA-Q 348R 0.1% 25PPM 0207 1W	PRODUCTION
5-2176666-2	SMA-Q0207BTCT357R	MELF SMA-Q 357R 0.1% 25PPM 0207 1W	PRODUCTION
5-2176666-3	SMA-Q0207BTCT365R	MELF SMA-Q 365R 0.1% 25PPM 0207 1W	PRODUCTION
5-2176666-4	SMA-Q0207BTCT374R	MELF SMA-Q 374R 0.1% 25PPM 0207 1W	PRODUCTION
5-2176666-5	SMA-Q0207BTCT383R	MELF SMA-Q 383R 0.1% 25PPM 0207 1W	PRODUCTION
5-2176666-6	SMA-Q0207BTCT392R	MELF SMA-Q 392R 0.1% 25PPM 0207 1W	PRODUCTION
5-2176666-7	SMA-Q0207BTCT402R	MELF SMA-Q 402R 0.1% 25PPM 0207 1W	PRODUCTION
5-2176666-8	SMA-Q0207BTCT412R	MELF SMA-Q 412R 0.1% 25PPM 0207 1W	PRODUCTION
5-2176666-9	SMA-Q0207BTCT422R	MELF SMA-Q 422R 0.1% 25PPM 0207 1W	PRODUCTION
6-2176666-0	SMA-Q0207BTCT432R	MELF SMA-Q 432R 0.1% 25PPM 0207 1W	PRODUCTION
6-2176666-1	SMA-Q0207BTCT442R	MELF SMA-Q 442R 0.1% 25PPM 0207 1W	PRODUCTION
6-2176666-2	SMA-Q0207BTCT453R	MELF SMA-Q 453R 0.1% 25PPM 0207 1W	PRODUCTION
6-2176666-3	SMA-Q0207BTCT464R	MELF SMA-Q 464R 0.1% 25PPM 0207 1W	PRODUCTION
6-2176666-4	SMA-Q0207BTCT475R	MELF SMA-Q 475R 0.1% 25PPM 0207 1W	PRODUCTION
6-2176666-5	SMA-Q0207BTCT487R	MELF SMA-Q 487R 0.1% 25PPM 0207 1W	PRODUCTION
6-2176666-6	SMA-Q0207BTCT499R	MELF SMA-Q 499R 0.1% 25PPM 0207 1W	PRODUCTION

THIS DRAWING IS A CONTROLLED DOCUMENT.

DWN DHEERAJ M 29NOV2023

CHK TRACY G 29NOV2023

APVD ALLAN P 29NOV2023

PRODUCT SPEC

APPLICATION SPEC

WEIGHT

CUSTOMER DRAWING



TE Connectivity

METAL FILM PRECISION MELF RESISTORS
AEC-Q200 QUALIFIED TYPE
SMA-Q 0207 SERIES

SIZE CAGE CODE DRAWING NO RESTRICTED TO

A3 00779 C-2176666

SCALE 20:1 SHEET 2 OF 3 REV BA

DIMENSIONS:

mm

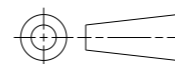

TOLERANCES UNLESS OTHERWISE SPECIFIED:

0 PLC	±0.2
1 PLC	±0.1
2 PLC	±
3 PLC	±
4 PLC	±
ANGLES	±5°

MATERIAL

FINISH

REVISIONS

P	LTR	DESCRIPTION	DATE	DWN	APVD
-		SEE SHEET 1	-	-	-

SCHEDULE			
TCPN	CATALOGUE NUMBER	PART DESCRIPTION	PART STATUS
6-2176666-7	SMA-Q0207BTCT511R	MELF SMA-Q 511R 0.1% 25PPM 0207 1W	PRODUCTION
6-2176666-8	SMA-Q0207BTCT523R	MELF SMA-Q 523R 0.1% 25PPM 0207 1W	PRODUCTION
6-2176666-9	SMA-Q0207BTCT536R	MELF SMA-Q 536R 0.1% 25PPM 0207 1W	PRODUCTION
7-2176666-0	SMA-Q0207BTCT549R	MELF SMA-Q 549R 0.1% 25PPM 0207 1W	PRODUCTION
7-2176666-1	SMA-Q0207BTCT562R	MELF SMA-Q 562R 0.1% 25PPM 0207 1W	PRODUCTION
7-2176666-2	SMA-Q0207BTCT576R	MELF SMA-Q 576R 0.1% 25PPM 0207 1W	PRODUCTION
7-2176666-3	SMA-Q0207BTCT590R	MELF SMA-Q 590R 0.1% 25PPM 0207 1W	PRODUCTION
7-2176666-4	SMA-Q0207BTCT604R	MELF SMA-Q 604R 0.1% 25PPM 0207 1W	PRODUCTION
7-2176666-5	SMA-Q0207BTCT619R	MELF SMA-Q 619R 0.1% 25PPM 0207 1W	PRODUCTION
7-2176666-6	SMA-Q0207BTCT634R	MELF SMA-Q 634R 0.1% 25PPM 0207 1W	PRODUCTION
7-2176666-7	SMA-Q0207BTCT649R	MELF SMA-Q 649R 0.1% 25PPM 0207 1W	PRODUCTION
7-2176666-8	SMA-Q0207BTCT665R	MELF SMA-Q 665R 0.1% 25PPM 0207 1W	PRODUCTION
7-2176666-9	SMA-Q0207BTCT681R	MELF SMA-Q 681R 0.1% 25PPM 0207 1W	PRODUCTION
8-2176666-0	SMA-Q0207BTCT698R	MELF SMA-Q 698R 0.1% 25PPM 0207 1W	PRODUCTION
8-2176666-1	SMA-Q0207BTCT715R	MELF SMA-Q 715R 0.1% 25PPM 0207 1W	PRODUCTION
8-2176666-2	SMA-Q0207BTCT732R	MELF SMA-Q 732R 0.1% 25PPM 0207 1W	PRODUCTION
8-2176666-3	SMA-Q0207BTCT750R	MELF SMA-Q 750R 0.1% 25PPM 0207 1W	PRODUCTION
8-2176666-4	SMA-Q0207BTCT768R	MELF SMA-Q 768R 0.1% 25PPM 0207 1W	PRODUCTION
8-2176666-5	SMA-Q0207BTCT787R	MELF SMA-Q 787R 0.1% 25PPM 0207 1W	PRODUCTION
8-2176666-6	SMA-Q0207BTCT806R	MELF SMA-Q 806R 0.1% 25PPM 0207 1W	PRODUCTION
8-2176666-7	SMA-Q0207BTCT825R	MELF SMA-Q 825R 0.1% 25PPM 0207 1W	PRODUCTION
8-2176666-8	SMA-Q0207BTCT845R	MELF SMA-Q 845R 0.1% 25PPM 0207 1W	PRODUCTION
8-2176666-9	SMA-Q0207BTCT866R	MELF SMA-Q 866R 0.1% 25PPM 0207 1W	PRODUCTION
9-2176666-0	SMA-Q0207BTCT887R	MELF SMA-Q 887R 0.1% 25PPM 0207 1W	PRODUCTION
9-2176666-1	SMA-Q0207BTCT909R	MELF SMA-Q 909R 0.1% 25PPM 0207 1W	PRODUCTION
9-2176666-2	SMA-Q0207BTCT931R	MELF SMA-Q 931R 0.1% 25PPM 0207 1W	PRODUCTION
9-2176666-3	SMA-Q0207BTCT953R	MELF SMA-Q 953R 0.1% 25PPM 0207 1W	PRODUCTION
9-2176666-4	SMA-Q0207BTCT976R	MELF SMA-Q 976R 0.1% 25PPM 0207 1W	PRODUCTION
9-2176666-5	SMA-Q0207BTCT1K0	MELF SMA-Q 1K0 0.1% 25PPM 0207 1W	PRODUCTION
9-2176666-6	SMA-Q0207BTCT1K02	MELF SMA-Q 1K02 0.1% 25PPM 0207 1W	PRODUCTION
9-2176666-7	SMA-Q0207BTCT1K05	MELF SMA-Q 1K05 0.1% 25PPM 0207 1W	PRODUCTION
9-2176666-8	SMA-Q0207BTCT1K07	MELF SMA-Q 1K07 0.1% 25PPM 0207 1W	PRODUCTION
9-2176666-9	SMA-Q0207BTCT1K1	MELF SMA-Q 1K1 0.1% 25PPM 0207 1W	PRODUCTION

THIS DRAWING IS A CONTROLLED DOCUMENT.		DWN DHEERAJ M	29NOV2023	 TE Connectivity	
		CHK TRACY G	29NOV2023		
		APVD ALLAN P	29NOV2023		
		PRODUCT SPEC		NAME METAL FILM PRECISION MELF RESISTORS AEC-Q200 QUALIFIED TYPE SMA-Q 0207 SERIES	
		APPLICATION SPEC		SIZE A3	
		WEIGHT		CAGE CODE 00779	
		CUSTOMER DRAWING		DRAWING NO C=2176666	
		SCALE		RESTRICTED TO	
		20:1		-	
		SHEET		REV	
		3 OF 3		BA	

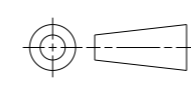
DIMENSIONS:		TOLERANCES UNLESS OTHERWISE SPECIFIED:	
mm			
		0 PLC	±0.2
		1 PLC	±0.1
		2 PLC	±-
		3 PLC	±-
		4 PLC	±-
MATERIAL		ANGLES	±5°
		FINISH	-
			-