

Automation and Control Guides

September 2016

A word cloud graphic on a grey background. The words are arranged in a roughly rectangular shape and include: Control (orange), Signaling (orange), TeSys (blue), Relays (pink), Altivar (green), Soft starters (green), Motor control and protection (blue), Advanced panels (yellow), Altistart (green), Magelis (yellow), Zelio (pink), Harmony (orange), and Drives (green).



Access our catalogs in just 3 clicks!

Digi-Cat available on USB flash drive or as free download

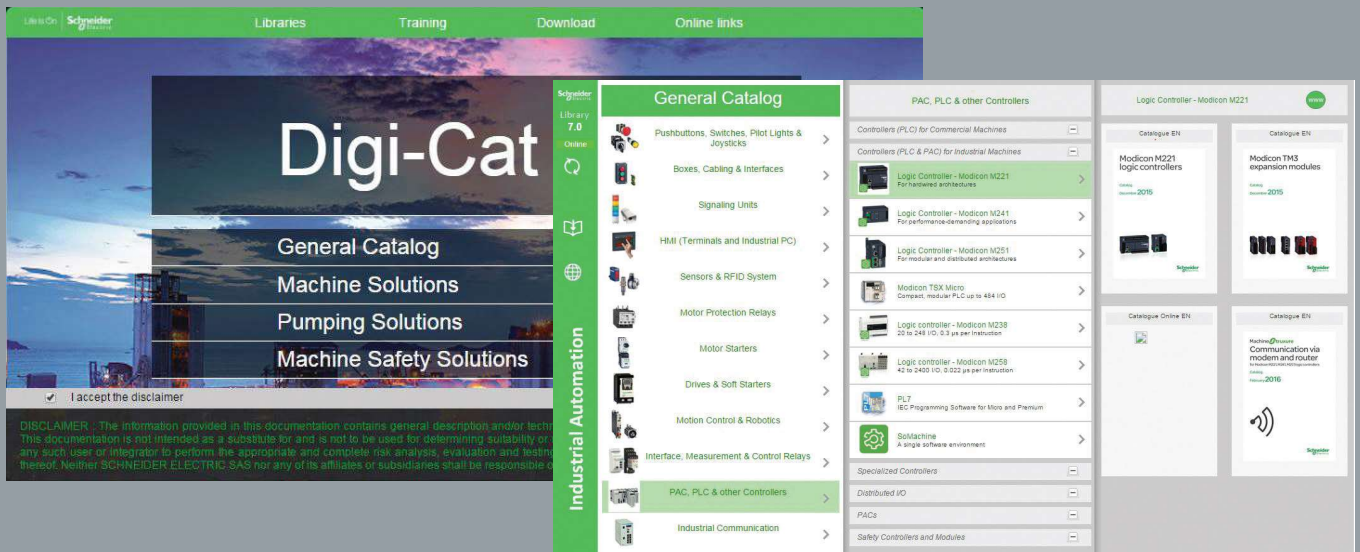

Access any of the 7,000 pages from our Industrial Automation and Control offer catalogs (English or French versions) quickly and easily.

Digi-Cat is available on USB flash drive (for PC).



To request a USB flash drive, simply contact your local Schneider representative.

Digi-Cat is also available to download at the following address:



<http://digi-cat.schneider-electric.com/download.html>



General contents

Your Harmony control & signaling guide . . .

Magelis Small and Advanced panels . . .

TeSys motor control and protection solutions

Altistart soft starters and Altivar variable speed drives

Your Zelio relays guide

Detection components - Panorama
Telemecanique Sensors



1

Your Harmony control and signaling guide



Harmony XVU and XVSV signaling solutions

Harmony XVU components for Ø 60 modular tower lights



1 IP 65 light modules (for association)								
Voltage	24 V							
LED unit type	High brightness							Pulse signal
Color	● Green	● Red	● Orange	● Blue	○ White	● Yellow	Multi-color	Multi-color
Reference	XVUC23	XVUC24	XVUC25	XVUC26	XVUC27	XVUC28	XVUC29	XVUC29P
2 IP 54 audible units (for association)								
Voltage	24 V							
Unit type	Buzzer		Sound	Pulse signal				
Color	● Black	○ Silver	● Black	● Black				
Reference	XVUC9S	XVUC9SQ	XVUC9V	XVUC9VP				
3 IP 65 body units with top cover (for association)								
Voltage	24 VAC/VDC			100...240 VAC				
Color	● Black	○ Silver	● Black	● Black	○ Silver			
Type	–	–	NPN	PNP	PNP			
Reference	XVUC21B	XVUC21BQ	XVUC21M	XVUC21MP	XVUC21MQP			
4 Mounting bases (for association)								
Base type	Adjustment pole	Fixing plate 100 mm/3.937 in		Fixing plate 400 mm/ 15.748 in	Fixing plate 800 mm/ 31.496 in	Direct mounting plates		
Color	● Black	● Black	○ Silver	● Black	● Black	● Black	○ Silver	
Reference	XVUZ05 (1)	XVUZ02	XVUZ02Q	XVUZ400	XVUZ800	XVUZ01	XVUZ01Q	
	–	–	–	–	–	XVUZ03 (2)	–	
	–	–	–	–	–	XVUZ04 (3)	–	
Accessories (for association)								
Unit type	Body extender		Flexible element (for horizontal or vertical support)					
Color	● Black	○ Silver	● Black					
Reference	XVUC020	XVUC020Q	XVUZ06					

(1) For use with DC body unit only

(2) 2-pin mounting

(3) 4-pin mounting

Harmony XVSV complete units

XVSV sound modules								
Size	DIN 72			DIN 96				
Voltage	12 - 24 VDC			12 - 24 VDC		100 - 230 VAC		
Color	● Dark gray		○ White	● Dark gray		○ White	● Dark gray	○ White
Wiring	NPN	PNP	NPN	NPN	PNP	NPN	NPN	NPN
Reference	XVS7BBN	XVS7BBP	XVS7BWN	XVS9BBN	XVS9BBP	XVS9BWN	XVS9MBN	XVS9MWN
Wall mounting plate (option)	XVSZ016							

Harmony XB4 Ø 22 metal pushbuttons



1 Flush mounting pushbuttons, unmarked

Color	○ White	● Black	● Green	● Red	● Yellow	● Blue
Contact	NO		NC		NO	
Connection	Screw clamp terminals					
Complete product	XB4BA11	XB4BA21	XB4BA31	XB4BA42	XB4BA51	XB4BA61
Body	ZB4BZ101			ZB4BZ101		
Head	ZB4BA1	ZB4BA2	ZB4BA3	ZB4BA4	ZB4BA5	ZB4BA6

2 Booted flush mounting pushbuttons, unmarked

Complete product	–	XB4BP21	XB4BP31	XB4BP42	XB4BP51	XB4BP61
Body	ZB4BZ101			ZB4BZ101		
Head	ZB4BP1	ZB4BP2	ZB4BP3	ZB4BP4	ZB4BP5	ZB4BP6

3 Flush mounting pushbuttons, marked

Color	○ White	● Black	● Green	● Red	● Green	● Red
Marking	↑	↓	"I" (white)	NC (white)	"START" (white)	"STOP" (white)
Contact	NO		NO + NC		NO	NO + NC
Connection	Screw clamp terminals					
Complete product	XB4BA3341	XB4BA3351	XB4BA3311	XB4BL4325 (1)	–	–
Body	ZB4BZ101			ZB4BZ105	ZB4BZ101	ZB4BZ105
Head	ZB4BA334	ZB4BA335	ZB4BA331	ZB4BL432	ZB4BL433	ZB4BA434

(1) With projecting push



4 Ø 40 trigger action Emergency stop mushroom head pushbuttons

Color	● Red			
Contact	NO + NC Push-pull	2 NC Turn to release	NO + NC Turn to release	NO + NC Key release
Connection	Screw clamp terminals			
Complete product	XB4BT845	XB4BS8444	XB4BS8445	XB4BS9445
Body	ZB4BZ105	ZB4BZ104	ZB4BZ105	
Head	ZB4BT84	ZB4BS844		ZB4BS944

5 Ø 40 mushroom head pushbutton, spring return

Color	● Black	● Green	● Blue	● Yellow
Contact	NO Push-pull			
Connection	Screw clamp terminals			
Complete product	XB4BC21	–	–	–
Body	ZB4BZ101			
Head	ZB4BC2	ZB4BC3	ZB4BC6	ZB4BC5



6 Pilot lights with integral LED

Color	○ White	● Green	● Red	● Orange	● Blue	
Connection	Screw clamp terminals					
Complete product	24 VAC/VDC	XB4BVB1	XB4BVB3	XB4BVB4	XB4BVB5	XB4BVB6
	110...120 VAC	XB4BVG1	XB4BVG3	XB4BVG4	XB4BVG5	XB4BVG6
	230...240 VAC	XB4BVM1	XB4BVM3	XB4BVM4	XB4BVM5	XB4BVM6

7 Flush mounting illuminated pushbuttons with integral LED

Color	○ White	● Green	● Red	● Orange	● Blue	
Contact	NO + NC					
Connection	Screw clamp terminals					
Complete product	24 VAC/VDC	XB4BW31B5	XB4BW33B5	XB4BW34B5	XB4BW35B5	XB4BW36B5

Harmony XB4 Ø 22 metal pushbuttons



1 Selector switches and key switches

Positions (number and type)		2 √ Stay put	2 √ Spring return	2 √ Stay put	3 √ Stay put	3 √ Spring return
Contact		NO		NO + NC	2 NO	
Connection		Screw clamp terminals				
Complete product	Black handle	XB4BD21	XB4BD41	XB4BD25	XB4BD33	XB4BD53
	Long black handle	XB4BJ21	–	–	XB4BJ33	XB4BJ53
	Key switch (No. 455)	XB4BG21	XB4BG61	–	XB4BG33	–

2 Illuminated selector switches with integral LED and colored handle

Stay put positions		2 √			3 √		
Color		● Green	● Red	● Orange	● Green	● Red	● Orange
Contact		NO + NC					
Connection		Screw clamp terminals					
Complete product	24 VAC/VDC	XB4BK123B5	XB4BK124B5	XB4BK125B5	XB4BK133B5	XB4BK134B5	XB4BK135B5
	110...120 VAC	XB4BK123G5	XB4BK124G5	XB4BK125G5	XB4BK133G5	XB4BK134G5	XB4BK135G5
	230...240 VAC	XB4BK123M5	XB4BK124M5	XB4BK125M5	XB4BK133M5	XB4BK134M5	XB4BK135M5

3 Double and triple-headed pushbuttons

Type		1 flush 1 projecting	2 flush	1 flush 1 projecting	2 flush	2 flush + 1 red central projecting
Contact		NO + NC		NO + NC with 24 V pilot light		2 NO + NC
Connection		Screw clamp terminals				
Complete product		XB4BL73415	–	XB4BW73731B5	–	XB4BA731327
Body		ZB4BZ105		ZB4BZ105 + ZBVB1		ZB4BZ103 + ZBE102
Head		ZB4BL7341	ZB4BA7121	ZB4BW7L3741	ZB4BW7A1721	ZB4BA73132

Accessories for Harmony pushbuttons



4 Contact blocks (for XB4 and XB5 pushbuttons)

Type		Electrical blocks				Body fixing collar for XB4 only
Contact		NO	NC	NO	NC	–
Connection		Screw clamp terminals		Spring clamp terminals		–
Sold in lots of		5	5	4	4	10
Reference		ZBE101	ZBE102	ZBE1015	ZBE1025	ZB4BZ009

5 Light blocks with integral LED (for XB4 and XB5 pushbuttons)

Color		○ White	● Green	● Red	● Orange	● Blue
Connection		Screw clamp terminals				
Reference	24 VAC/VDC	ZBVB1	ZBVB3	ZBVB4	ZBVB5	ZBVB6
	110...120 VAC	ZBVG1	ZBVG3	ZBVG4	ZBVG5	ZBVG6
	230...240 VAC	ZBVM1	ZBVM3	ZBVM4	ZBVM5	ZBVM6

6 Legend holders 30 x 40 mm for 8 X 27 mm legends

White marking/Red or black background				Ø 60 legends for Emergency stop			
O		ZBY2931	I	ZBY2147	AUTO	ZBY2115	Black marking/Yellow background
OFF		ZBY2312	ON	ZBY2311	START	ZBY2303	ARRET D'URGENCE
							EMERGENCY STOP
							ZBY9120
							ZBY9130T (1)
							ZBY9320
							ZBY9330T (1)
Without marking/Red or black background				Without marking/Yellow background			
Red		ZBY2101	Black	ZBY2101			ZBY9121

7 Transparent boots for pushbuttons (sold in lots of 10)

For pushbuttons		Circular projecting	Circular flush	Circular flush or projecting	Rectangular double head	Rectangular triple head	Rectangular triple head
Reference		ZBP0	ZBPA	ZBP0A	ZBA708	ZBA709	ZBA710

8 Flush mounting kits

Harmony XB5 Ø 22 plastic pushbuttons



1



2



3

1 Flush mounting pushbuttons, unmarked

Color	○ White	● Black	● Green	● Red	● Yellow	● Blue
Contact	NO		NC		NO	
Connection	Screw clamp terminals					
Complete product	XB5AA11	XB5AA21	XB5AA31	XB5AA42	XB5AA51	XB5AA61
Body	ZB5AZ101			ZB5AZ102	ZB5AZ101	
Head	ZB5AA1	ZB5AA2	ZB5AA3	ZB5AA4	ZB5AA5	ZB5AA6

2 Booted flush mounting pushbuttons, unmarked

Complete product	–	XB5AP21	XB5AP31	XB5AP42	XB5AP51	XB5AP61
Body	–	ZB5AZ101		ZB5AZ102	ZB5AZ101	
Head	–	ZB5AP2	ZB5AP3	ZB5AP4	ZB5AP5	ZB5AP6

3 Flush mounting pushbuttons, marked

Color	○ White	● Black	● Green	● Red	● Green	● Red
Marking	↑	↓	“I” (white)	NC (white)	“START” (white)	“STOP” (white)
Contact	NO			NC	NO	NC
Connection	Screw clamp terminals					
Complete product	XB5AA3341	XB5AA3351	XB5AA3311	XB5AA4322	–	–
Body	ZB5AZ101			ZB5AZ102	ZB5AZ101	ZB5AZ102
Head	ZB5AA334	ZB5AA335	ZB5AA331	ZB5AA432	ZB5AA433	ZB5AA434



4



5



5

4 Ø 40 trigger action Emergency stop mushroom head pushbuttons

Color	● Red					
Contact	NO + NC Push-pull	2 NC Turn to release	NO + NC Turn to release	NO + NC Key release		
Connection	Screw clamp terminals					
Complete product	XB5AT845	XB5AS8444	XB5AS8445	XB5AS9445		
Body	ZB5AZ105	ZB5AZ104	ZB5AZ105			
Head	ZB5AT84	ZB5AS844		ZB5AS944		

5 Ø 40 mushroom head pushbuttons, spring return

Color	● Black	● Green	● Blue	● Yellow
Contact	NO Push-pull			
Connection	Screw clamp terminals			
Complete product	XB5AC21	–	–	–
Body	ZB5AZ101			
Head	ZB5AC2	ZB5AC3	ZB5AC6	ZB5AC5



6



7

6 Pilot lights with integral LED

Color	○ White	● Green	● Red	● Orange	● Blue	● Yellow	
Connection	Screw clamp terminals						
Complete product	24 VAC/VDC	XB5AVB1	XB5AVB3	XB5AVB4	XB5AVB5	XB5AVB6	–
	110...120 VAC	XB5AVG1	XB5AVG3	XB5AVG4	XB5AVG5	XB5AVG6	–
	230...240 VAC	XB5AVM1	XB5AVM3	XB5AVM4	XB5AVM5	XB5AVM6	–
	24 VAC/VDC	XB5EVB1	XB5EVB3	XB5EVB4	XB5EVB5	XB5EVB6	XB5EVB8
	110...120 VAC	XB5EVG1	XB5EVG3	XB5EVG4	XB5EVG5	XB5EVG6	XB5EVG8
	230...240 VAC	XB5EVM1	XB5EVM3	XB5EVM4	XB5EVM5	XB5EVM6	XB5EVM8

7 Flush mounting illuminated pushbuttons with integral LED

Color	○ White	● Green	● Red	● Orange	● Blue
Contact	NO + NC				

Harmony XB5 Ø 22 plastic pushbuttons



1 Selector switches and key switches

Positions	2 √ Stay put	2 √ Spring return	2 √ Stay put	3 √ Stay put	3 √ Spring return	
Contact	NO		NO + NC	2 NO		
Connection	Screw clamp terminals					
Complete product	Black handle	XB5AD21	XB5AD41	XB5AD25	XB5AD33	XB5AD53
	Long black handle	XB5AJ21	–	–	XB5AJ33	XB5AJ53
	Key switch (No. 455)	XB5AG21	XB5AG61	–	XB5AG33	–

2 Illuminated selector switches with integral LED and colored handle

Stay put positions	2 √	3 √					
Color	● Green	● Red	● Orange	● Green	● Red	● Orange	
Contact	NO + NC						
Connection	Screw clamp terminals						
Complete product	24 VAC/VDC	XB5AK123B5	XB5AK124B5	XB5AK125B5	XB5AK133B5	XB5AK134B5	XB5AK135B5
	110...120 VAC	XB5AK123G5	XB5AK124G5	XB5AK125G5	XB5AK133G5	XB5AK134G5	XB5AK135G5
	230...240 VAC	XB5AK123M5	XB5AK124M5	XB5AK125M5	XB5AK133M5	XB5AK134M5	XB5AK135M5

3 Double and triple-headed pushbuttons

Type	1 flush 1 projecting	2 flush	1 flush 1 projecting	2 flush	2 flush + 1 red central projecting	
Contact	NO + NC		NO + NC with 24V pilot light		2 NO + NC	
Connection	Screw clamp terminals					
Complete product	XB5AL73415	–	XB5AW73731B5	–	XB5AA731327	–
	ZB5AZ105		ZB5AZ105 + ZBVB1		ZB5AZ103 + ZBE102	
Body						
Head	ZB5AL7341	ZB5AA7121	ZB5AW7L3741	ZB5AW7A1721	ZB5AA73132	ZB5AA71124

Harmony XAL plastic control stations



Number and type of pushbuttons	1 start or stop			1 start and stop	
Color or type	● Green	● Green	● Red	● Handle	● Key
Marking	"I" (white)	"START" (white)	NC (white)	"O-I" (white)	"O-I" (white)
Contact	NO		NC	NO	
Connection	Screw clamp terminals				
Complete product	Flush pushbutton	XALD102	XALD103	XALD112	–
	Projecting pushbutton	–	–	XALD115	–
	Selector switch	–	–	–	XALD134



Number and type of pushbuttons	Ø 40 trigger action Emergency stop mushroom head pushbutton					
Color	● Red					
Type	Turn to release			Key release		
Contact	NC	2 NC	2 NC + NO	NC	2 NC + NO	
Connection	Screw clamp terminals					
Complete product	XALK178	XALK178F	XALK178G	XALK188	XALK188F	XALK188G



Number and type of pushbuttons	2 start and stop flush mounting			2 up/down flush mounting		
Color/Marking	1 "I" green	1 "Start green"	1 pilot light 24 VDC	1 "Up" white		
	1 NC red	1 "Stop" red	1 "I" green	1 "Down" black	1 NC red	1 E-stop red



Harmony XB7 Ø 22 monolithic pushbuttons



1

Flush mounting spring return pushbuttons, unmarked

Color	○ White	● Black	● Green	● Red	● Yellow	● Blue
Contact	NO			NO + NC		
Connection	Screw clamp terminals					
Complete product	XB7NA11	XB7NA21	XB7NA31	XB7NA45	XB7NA85	XB7NA65



Flush mounting spring return pushbuttons, marked

Color	○ White	● Black	● Green	● Red	● Green	● Red
Marking	↑	↓	"I" (white)	"O" (white)	"START" (white)	"STOP" (white)
Contact	NO			NC	NO	NC
Connection	Screw clamp terminals					
Complete product	XB7NA11341	XB7NA21343	XB7NA3131	XB7NA4232	XB7NA3133	XB7NA4234



Ø 40 trigger action Emergency stop mushroom head pushbuttons

Color	● Red					
Contact	NO + NC Push-pull	NO + NC Turn to release	2 NC Key release			
Connection	Screw clamp terminals					
Complete product	XB7NT845	XB7NS8445	XB7NS9444			



Pilot lights with integral LED

Color	● Green	● Red	● Yellow	● Blue	○ Clear	● Orange	
Connection	Screw clamp terminals						
Complete product	24 VAC/VDC	XB7EV03BP	XB7EV04BP	XB7EV05BP	XB7EV06BP	XB7EV07BP	XB7EV08BP
	120 VAC	XB7EV03GP	XB7EV04GP	XB7EV05GP	XB7EV06GP	XB7EV07GP	XB7EV08GP
	230 VAC	XB7EV03MP	XB7EV04MP	XB7EV05MP	XB7EV06MP	XB7EV07MP	XB7EV08MP



Flush mounting illuminated pushbuttons with integral LED

Color	● Green	● Red	● Orange	● Blue	○ Clear	● Yellow	
Contact	NO + NC						
Connection	Screw clamp terminals						
Complete product	24 VAC/VDC	XB7NW33B1	XB7NW34B1	XB7NW35B1	XB7NW36B1	XB7NW37B1	XB7NW38B1
	120 VAC	XB7NW33G1	XB7NW34G1	XB7NW35G1	XB7NW36G1	XB7NW37G1	XB7NW38G1
	230 VAC	XB7NW33M1	XB7NW34M1	XB7NW35M1	XB7NW36M1	XB7NW37M1	XB7NW38M1



Selector switches with black handle

Positions	2 ∨	2 ∨	3 ∨	2 ∨	3 ∨
Type	Stay put	Stay put	Stay put	Key withdrawal	Key withdrawal in centre





Other control components



Harmony XD4 joystick controllers

Number of directions	2	4	2	4
Contact	1 NO per direction			
Position	Stay put		Spring return	
Reference	XD4PA12	XD4PA14	XD4PA22	XD4PA24



Harmony cam switches

Function	Ammeter	Voltmeter	Changeover	ON-OFF switches	Stepping
Thermal current	12 Amps				
Number of poles	6	6	4	1	3
Multi-screw fixing	K1F003MLH	K1F027MLH	K1D002ULH	K1A001ALH	K1C003ALH
Ø 22 fixing	K1F003MCH	K1F027MCH	K1D002UCH	K1A001ACH	K1C003QCH



Harmony XPE foot switches

Material-Color	Metal blue	Plastic black	Metal blue		
Cover	No		Yes		
Contact	1 NC + 1 NO		1 NC + 1 NO	2 NC + 2 NO	
Reference	XPEM110	XPEA110	XPEM510	XPEM511	



Harmony XB4R/XB5R wireless and batteryless pushbuttons

Receiver	Non-programmable + 1 black cap			
Power supply	24 VDC			
Pushbutton	1 plastic	1 metal	1 plastic in handy box	
Reference	XB5RFB01	XB4RFA02	XB5RMB03	



Harmony XB5S biometric switches

Receiver	Monostable	Bistable
Power supply	24 VDC/PNP output	
Cable 2 m	XB5S2B2L2	XB5S1B2L2
M12 connector	XB5S2B2M12	XB5S1B2M12

Harmony remote control system and pendant control stations for hoisting



Harmony eXLhoist wireless remote control system (control devices)

Motion pushbutton	6		6
Auxiliary pushbuttons	2		6
LED or display	LED	Display	Display
Emergency stop mushroom head	Yes	Yes	Yes
Reference	ZART8L	ZART8D	ZART12D

Harmony eXLhoist wireless remote control system (base stations)

Standard output	12		18
Safety output	2		2
Inputs	-		18
Connection	Cable gland	Harting connector	Cable gland Harting connector
Reference	ZARB12W	ZARB12H	ZARB18W ZARB18H



Harmony XACA pendant control stations for Ø 22 plastic signaling units

Number of pushbuttons	2	3	4	6	8
Type	Pistol grip			Standard	
Color	Yellow			Yellow	
Pushbutton 1: Raise (1)	Yes	Yes	Yes	Yes	Yes
Pushbutton 2: Lower (1)	Yes	Yes	Yes	Yes	Yes
Emergency stop (2)	-	Yes	-	-	-
Pushbutton 3: Left (1)	-	-	Yes	Yes	Yes
Pushbutton 4: Right (1)	-	-	Yes	Yes	Yes
Pushbutton 5: Forward (1)	-	-	-	Yes	Yes



Magelis STO and STU Small Panels



Magelis STO touch panels - most compact panels

Screen size		4.3"	
Screen resolution (pixels)		480 x 272	
Touch screen or keypad		Touch screen	
Software		Vijeo XD (1)	
Memory capacity	Application memory	26 MB	
	Backup memory	128 KB	
	Expansion memory	No	
Communication	Ethernet port	No	1 LAN port
	Serial line	RS-232C (9-way terminal block)	RS-232C/RS-485 (RJ45 8-way) No
	USB connection	1 type A host connector + 1 mini-B connector	
Operating temperature		0...50 °C	
Industrial certifications		CE, RCM, EAC, KC, CUL, UL, ATEX Zone 2/22 (2)	
Cut-out (mm) (3)		112.5 x 77.5	
Dimensions (mm)		124.9 x 90.4 x 38.8	
Reference		HMISTO705	HMISTO715 HMISTO735

(1) Available Q2 2016.

(2) ATEX Zone 2/22 certification pending.

(3) An accessory adapter is available to fit in monochrome STO cut-out.



Magelis STU touch panels - no cut-out required

Screen size		3.5"	5.7"
Screen resolution (pixels)		320 x 240	
Touch screen or keypad		Touch screen	
Software		Vijeo Designer	
Memory capacity	Application memory	32 MB	
	Backup memory	64 KB	
	Expansion memory	No	
Communication	Ethernet port	1 LAN	
	Serial line	RS-232C/RS-485	
	USB connection	1 type A host connector + 1 mini-B connector	
Operating temperature		0...50 °C	
Industrial certifications		CE, C-Tick, CULus, UL class 1 Div 2 T4A or T5, ATEX Zone 2/22, Marine	
Cut-out (mm)		Ø 22	
Dimensions (mm)		98 x 118 x 55	129 x 163 x 56.5
Reference		HMISTU655	HMISTU855





Magelis GTO Optimum Advanced Panels



2

Magelis GTO advanced panels with standard front and IP 65 degree of protection				
Screen size		3.5"		5.7"
Screen resolution (pixels)		320 x 240		
Touch screen or keypad		Touch screen + 6 function keys		Touch screen
Software		Vijeo Designer/Vijeo XD (1)		
Memory capacity	Application memory	64 MB/128 MB	96 MB/128 MB	64 MB/128 MB
	Backup memory	128 KB	512 KB	128 KB
	Expansion memory	No		SD card (2)
Communication	Ethernet port	No	1 LAN port	No
	Serial line	RS-232C (COM1) and RS-485 (COM2)	RS-232C/485 (COM1)	RS-232C (COM1) and RS-485 (COM2)
	USB connection	1 type A host connector + 1 mini-B connector		
Operating temperature		0...50 °C		
Industrial certifications		CE, RCM, EAC, KC, CULus, UL class 1 Div2, ATEX Zone 2/22, Marine		
Cut-out (mm)		118.5 x 92.5		156 x 123.5
Dimensions (mm)		132 x 106 x 42		169.5 x 137 x 59.5
Reference	With IP 65 degree of protection	HMIGTO1300	HMIGTO1310	HMIGTO2300 HMIGTO2310

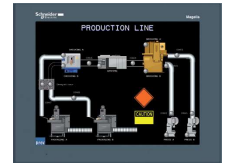

Magelis GTO advanced panels with standard front and IP 65 degree of protection (continued)				
Screen size		7.0"	7.5"	10.4"
Screen resolution (pixels)		800 x 480	640 x 480	800 x 600
Touch screen or keypad		Touch screen + 8 function keys		Touch screen
Software		Vijeo Designer/Vijeo XD (1)		
Memory capacity	Application memory	96 MB/128 MB		
	Backup memory	128 KB	512 KB	
	Expansion memory	SD card (2)		
Communication	Ethernet port	1 LAN port		
	Serial line	RS-232C (COM1) and RS-485 (COM2)		
	USB connection	1 type A host connector + 1 mini-B connector		
Operating temperature		0...50 °C	0...55 °C	
Industrial certifications		CE, RCM, EAC, KC, CULus, UL class 1 Div2, ATEX Zone 2/22, Marine		
Cut-out (mm)		204.5 x 159.5	259 x 201	301.5 x 227.5
Dimensions (mm)		218 x 173 x 60	272.5 x 214.5 x 57	315 x 241 X 56
Reference	With IP 65 degree of protection	HMIGTO3510	HMIGTO4310	HMIGTO5310 HMIGTO6310

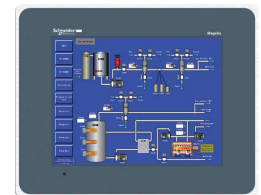
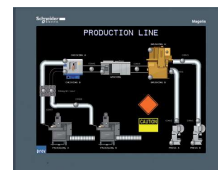
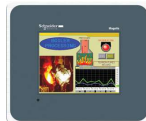

Magelis GTO advanced panels with stainless steel frame and IP 66K degree of protection				
Screen size		5.7"	10.4"	12.1"
Screen resolution (pixels)		320 x 240	640 x 480	800 x 600
Touch screen or keypad		Touch screen		
Software		Vijeo Designer/Vijeo XD (1)		
Memory capacity	Application memory	64 MB/128 MB	96 MB/128 MB	
	Backup memory	512 KB		
	Expansion memory	SD card (2)		
Communication	Ethernet port	1 LAN port		
	Serial line	RS-232C (COM1) and RS-485 (COM2)		
	USB connection	1 type A host connector + 1 mini-B connector		
Operating temperature		0...55 °C		
Industrial certifications		CE, RCM, EAC, KC, CULus, UL class 1 Div2, ATEX Zone 2/22		



Programming Software and USB Accessories



Vijeo Designer, programming software for Magelis STU small panels and Magelis GTO advanced panels

Compatibility	All Magelis STU small panels and Magelis GTO Optimum advanced panels			
Type of Vijeo Designer license	Single-station Build Time	Multi-station Build Time		
Number of stations	1	3 (team)	10 (group)	Unlimited on 1 site
Type of support	DVD			
License duration	Unlimited			
Reference	VJDSNDTGSV62M	VJDTNDTGSV62M	VJDGNDTGSV62M	VJDFNDTGSV62M



Vijeo XD, programming software for Magelis STO small panels and Magelis GTO advanced panels

Compatibility	All Magelis STO small panels and Magelis GTO Optimum advanced panels (1)			
Type of Vijeo XD license (2)	Vijeo XD DVD (4)	Professional License	Profess. i-License (5)	Express License
Number of stations	1			
Type of support	DVD	Paper	Electronic	Paper
License duration	25 days	Unlimited		
Reference (3)	HMIPEDCZ22	HMIPELCZLSPM●●	HMIPELCZSPA●●	HMIELCZLSPM●●



USB accessories for Magelis STU small panels and Magelis GTO advanced panels

USB accessories (programmable with Vijeo Designer)	Monolithic USB tower lights	Illuminated USB switch	USB keyboard	Biometric USB switch
Degree of protection	IP 54	IP 65		
Description	- 3 multi-color LEDs - clear lens - 2-tone buzzer (up to 85 dB at 1 m) - pre-assembled USB cable for easy connection - USB cable clamp to help ensure firm connection	5 customizable soft/static function keys with multi-color LED backlight or alarm acknowledgment	USB keyboard with 12 keys with integrated LEDs that can be used as user customizable function keys or alphanumeric input keys	- Manages access to HMI data via USB port - Levels of authorization through fingerprint recognition - Traceability of users and operations - Database management from PC
Type of mounting	Base for direct mounting	100 mm aluminum support tube mounted on a plate	-	-
Compatibility with Magelis	HMI GTO	HMI STU, GTO	HMI STU, GTO	HMI GTO
Reference	XVGU3SWV	XVGU3SHAV	HMIZRA1	HMIZKB1
				XB5S5B2L2

(1) For GTO applications, please check with your local Schneider Electric contact.

(2) Available Q2 2016. (3) The dots at the end of the reference represent the version number.

(4) Vijeo XD DVD contains a trial version of the software, active for 25 days. To obtain the unlimited version, a license needs to be purchased.

(5) Please check the availability of the i-License with your local Schneider Electric contact.



3

TeSys®

Panorama of motor control and protection solutions

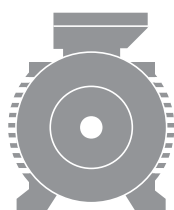

Flexible

Safety M



Smart

Connected



Protection

Compliant

Energy efficiency



Reliable

Available

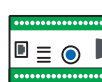

TeSys Universal

Build your motor starter!

	Contactor	Thermal-magnetic circuit breaker	Magnetic circuit breaker	Switch disconnector fuse	Thermal overload relay	Compact starter controller	Main / Emergency stop switch disconnecter	Fuse carrier	Ultra compact motor starter
Range name	TeSys B, K, D, F	TeSys GV	TeSys GV.L	TeSys GS	TeSys K, D, F	TeSys U	TeSys Vario	TeSys DF	TeSys H
Product reference prefix	LC	GV	GV.L	GS	LR	LU	V	DF	LZ
Motor starter structure - 4 functions to be covered:									
Disconnection and breaking	■	■	■	■	■	■	■	■	■
Short-circuit protection	■	■	■	■	■	■	■	■	■
Overload protection	■	■	■	■	■	■	■	■	■
Control	■	■	■	■	■	■	■	■	■

Voltage coil code

	■ ■	■ ■	■ ■	● ●	★ ★	□ □	□	★ ★	★ ★
	AC	DC	DC < 2.4W	DC	AC/DC	AC/DC	AC 40/400	AC	DC
24 V	B7	BD	BL	BW	B/BL				
48 V	E7	ED	EL	EW	ES				
72 V		SD	SL	SW	ES				
110 V	F7	FD		FW	FU	FW	F	F7	FD
220 V	M7				FU	MW	M	M7	MD
230 V	P7				FU	MW	M	P7	
400 V	V7					QW	V	V7	

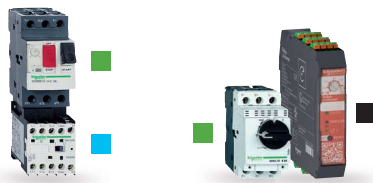

Motor power AC3 380/400 V	0.37...0.55 kW	0.75 kW	1.1...1.5 kW	2.2 kW	3 kW	4 kW	5.5 kW
TeSys K mini contactor							
Ie max. AC3 (Ue ≤ 440 V)	6 A	6 A	6 A	6 A	9 A	9 A	12 A
Ie AC1 (T < 60°C)	20 A	20 A	20 A	20 A	20 A	20 A	20 A
Contactor (*)	LC1K06 ■ ■	LC1K06 ■ ■	LC1K06 ■ ■	LC1K06 ■ ■	LC1K09 ■ ■	LC1K09 ■ ■	LC1K12 ■ ■
Breaking capacity Icu/400 V	100 KA	100 KA	100 KA	100 KA	100 KA	100 KA	100 KA
Thermal-magnetic circuit breaker	GV2P06	GV2P07	GV2P08	GV2P10	GV2P14	GV2P14	GV2P16
Rotary handle							
Breaking capacity Icu/400 V	100 KA	100 KA	100 KA	100 KA	100 KA	100 KA	15 KA
Thermal-magnetic circuit breaker	GV2ME06	GV2ME07	GV2ME08	GV2ME10	GV2ME14	GV2ME14	GV2ME16
Pushbutton control							
Breaking capacity Icu/400 V	100 KA	100 KA	100 KA	100 KA	100 KA	100 KA	15 KA
Magnetic circuit breaker	GV2LE06	GV2LE07	GV2LE08	GV2LE10	GV2LE14	GV2LE14	GV2LE16
Tumbler control							
Breaking capacity Icu/400 V	100 KA	100 KA	100 KA	100 KA	100 KA	100 KA	100 KA
Magnetic circuit breaker	GV2L06	GV2L07	GV2L08	GV2L10	GV2L14	GV2L14	GV2L16
Rotary handle							
Switch disconnector fuse	GS1DD	GS1DD	GS1DD	GS1DD	GS1DD	GS1DD	GS1DD
Fuse type	10 x 38	10 x 38	10 x 38	10 x 38	10 x 38	10 x 38	10 x 38
Operational current Ie/400 V	2 A	4 A	4 A	6 A	8 A	12 A	16 A
Thermal overload relay cI10A	LR2K0306	LR2K0308	LR2K0310	LR2K0312	LR2K0314	LR2K0316	LR2K0321

TeSys H Ultra-compact motor starter					
Breaking capacity Icu/400 V	> 100 KA	> 100 KA	> 100 KA	> 100 KA	> 100 KA
Magnetic circuit breaker	GV2L06	GV2L07	GV2L08	GV2L10	GV2L14
Rotary handle					
Breaking capacity Icu/400 V	> 100 KA	> 100 KA	> 100 KA	> 100 KA	> 100 KA
Magnetic circuit breaker	GV2LE06	GV2LE07	GV2LE08	GV2LE10	GV2LE14
Tumbler control					

TeSys Universal

Build your motor starter!

	Contactor	Thermal-magnetic circuit breaker	Magnetic circuit breaker	Switch disconnector fuse	Thermal overload relay	Compact starter controller	Main / Emergency stop switch disconnecter	Fuse carrier	Ultra compact motor starter
Range name	TeSys B, K, D, F	TeSys GV	TeSys GV.L	TeSys GS	TeSys K, D, F	TeSys U	TeSys Vario	TeSys DF	TeSys H
Product reference prefix	LC	GV	GV.L	GS	LR	LU	V	DF	LZ
Motor starter structure - 4 functions to be covered:									
Disconnection and breaking	■	■	■	■	■	■	■	■	■
Short-circuit protection	■	■	■	■	■	■	■	■	■
Overload protection	■	■	■	■	■	■	■	■	■
Control	■	■	■	■	■	■	■	■	■

Voltage coil code

	■ ■	■ ■	■ ■	● ●	★ ★	□ □	□	★ ★	★ ★
	AC	DC	DC < 2.4 W	DC	AC/DC	AC/DC	AC 40/400	AC	DC
24 V	B7	BD	BL	BW	B/BL				
48 V	E7	ED	EL	EW	ES				
72 V		SD	SL	SW	ES				
110 V	F7	FD		FW	FU	FW	F	F7	FD
220 V	M7				FU	MW	M	M7	MD
230 V	P7				FU	MW	M	P7	
400 V	V7					QW	V	V7	

3



Motor power AC3 380/400 V	0.37...0.55 kW	0.75 kW	1.1...1.5 kW	2.2 kW	3 kW	4 kW
TeSys D contactor						
le max. AC3 (Ue ≤ 440 V)	9 A	9 A	9 A	9 A	9 A	9 A
le AC1 (T < 60°C)	25 A	25 A	25 A	25 A	25 A	25 A
Contactor (*)	LC1D09 ■■	LC1D09 ■■	LC1D09 ■■	LC1D09 ■■	LC1D09 ■■	LC1D09 ■■
Breaking capacity Icu/400 V	100 KA	100 KA	100 KA	100 KA	100 KA	100 KA
Thermal-magnetic circuit breaker	GV2P06	GV2P07	GV2P08	GV2P10	GV2P14	GV2P14
Rotary handle						
Breaking capacity Icu/400 V	100 KA	100 KA	100 KA	100 KA	100 KA	100 KA
Thermal-magnetic circuit breaker	GV2ME06	GV2ME07	GV2ME08	GV2ME10	GV2ME14	GV2ME14
Pushbutton control						
Breaking capacity Icu/400 V	100 KA	100 KA	100 KA	100 KA	100 KA	100 KA
Magnetic circuit breaker	GV2LE06	GV2LE07	GV2LE08	GV2LE10	GV2LE14	GV2LE14
Tumbler control						
Breaking capacity Icu/400 V	100 KA	100 KA	100 KA	100 KA	100 KA	100 KA
Magnetic circuit breaker	GV2L06	GV2L07	GV2L08	GV2L10	GV2L14	GV2L14
Rotary handle						
Switch disconnector fuse	GS1DD	GS1DD	GS1DD	GS1DD	GS1DD	GS1DD
Fuse type	10 x 38	10 x 38	10 x 38	10 x 38	10 x 38	10 x 38
Operational current Ie/400 V	2 A	4 A	4 A	6 A	8 A	12 A
Thermal overload relay cI10A	LRD06	LRD07	LRD08	LRD10	LRD12	LRD14
Thermal overload relay cI20	-	-	LRD1508	LRD1510	LRD1512	LRD1514

TeSys U compact motor starter

Breaking capacity Icu/400 V	50 kA	50 kA	50 kA	50 kA	50 kA	50 kA
Power base	LUB12	LUB12	LUB12	LUB12	LUB12	LUB12
Control unit	LHCA1X ★★	LHCA05 ★★	LHCA05 ★★	LHCA12 ★★	LHCA12 ★★	LHCA12 ★★

TeSys Universal

Build your motor starter!

	Contactor	Thermal-magnetic circuit breaker	Magnetic circuit breaker	Switch disconnector fuse	Thermal overload relay	Compact starter controller	Main / Emergency stop switch disconnecter	Fuse carrier	Ultra compact motor starter
Range name	TeSys B, K, D, F	TeSys GV	TeSys GV.L	TeSys GS	TeSys K, D, F	TeSys U	TeSys Vario	TeSys DF	TeSys H
Product reference prefix	LC	GV	GV.L	GS	LR	LU	V	DF	LZ
Motor starter structure - 4 functions to be covered:									
Disconnection and breaking	■	■	■	■	■	■	■	■	■
Short-circuit protection	■	■	■	■	■	■	■	■	■
Overload protection	■	■	■	■	■	■	■	■	■
Control	■	■	■	■	■	■	■	■	■

Voltage coil code



	■ ■	■ ■	■ ■	● ●	★ ★	□ □	□	★ ★	★ ★
	AC	DC	DC < 2,4 W	DC	AC/DC	AC/DC	AC 40/400	AC	DC
24 V	B7	BD	BL	BW	B/BL				
48 V	E7	ED	EL	EW	ES				
72 V		SD	SL	SW	ES				
110 V	F7	FD		FW	FU	FW	F	F7	FD
220 V	M7				FU	MW	M	M7	MD
230 V	P7				FU	MW	M	P7	
400 V	V7					QW	V	V7	

Motor power AC3 380/400 V	5,5 kW	7,5 kW	9 kW	11 kW	15 kW
TeSys D contactor					
Ie max. AC3 (Ue ≤ 440 V)	12 A	18 A	25 A	25 A	32 A
Ie AC1 (T < 60°C)	25 A	32 A	40 A	40 A	50 A
Contactor (*)	LC1D12 ■■	LC1D18 ■■	LC1D25 ■■	LC1D25 ■■	LC1D32 ■■
Breaking capacity Icu/400 V	100 KA	100 KA	100 KA	100 KA	100 KA
Thermal-magnetic circuit breaker	GV2P16	GV3P18	GV3P25	GV3P25	GV3P32
Rotary handle					
Breaking capacity Icu/400 V	15 KA	15 KA	15 KA	15 KA	15 KA
Thermal-magnetic circuit breaker	GV2ME16	GV2ME20	GV2ME21	GV2ME22	GV2ME32
Pushbutton control					
Breaking capacity Icu/400 V	15 KA	15 KA	15 KA	15 KA	15 KA
Magnetic circuit breaker	GV2LE16	GV2LE20	GV2LE22	GV2LE22	GV2LE32
Tumbler control					
Breaking capacity Icu/400 V	100 KA	100 KA	100 KA	100 KA	100 KA
Magnetic circuit breaker	GV2L16	GV2L20	GV2L22	GV3L25	GV3L32
Rotary handle					
Switch disconnector fuse	GS1DD	GS1DD	GS1DD	GS1DD	GS1DD
Fuse type	10 x 38	10 x 38	10 x 38	10 x 38	10 x 38
Operational current Ie/400 V	16 A	16 A	25 A	25 A	32 A
Thermal overload relay cI10A	LRD16	LRD21	LRD22	LRD22	LRD32
	-	-	-	LRD325 (1)	LRD332 (1)
Thermal overload relay cI20	LRD1516	LRD1521	LRD1522	LRD1522	LRD1532
	-	-	-	LRD325L (1)	LRD332L (1)
TeSys U compact motor starter					
Breaking capacity Icu/400 V	50 KA	50 KA	50 KA	50 KA	50 KA
Power base	LU1B12	LU1B32	LU1B32	LU1B32	LU1B32

TeSys Universal

Build your motor starter!

	Contactor	Thermal-magnetic circuit breaker	Magnetic circuit breaker	Switch disconnector fuse	Thermal overload relay	Compact starter controller	Main / Emergency stop switch disconnector	Fuse carrier	Ultra compact motor starter
Range name	TeSys B, K, D, F	TeSys GV	TeSys GV.L	TeSys GS	TeSys K, D, F	TeSys U	TeSys Vario	TeSys DF	TeSys H
Product reference prefix	LC	GV	GV.L	GS	LR	LU	V	DF	LZ
Motor starter structure - 4 functions to be covered:									
Disconnection and breaking	■	■	■	■	■	■	■	■	■
Short-circuit protection	■	■	■	■	■	■	■	■	■
Overload protection	■	■	■	■	■	■	■	■	■
Control	■	■	■	■	■	■	■	■	■

3



Voltage coil code





	■ ■	■ ■	■ ■	● ●	★ ★	□ □	□	★ ★	★ ★
	AC	DC	DC < 2.4 W	DC	AC/DC	AC/DC	AC 40/400	AC	DC
24 V	B7	BD	BL	BW	B/BL				
48 V	E7	ED	EL	EW	ES				
72 V		SD	SL	SW	ES				
110 V	F7	FD		FW	FU	FW	F	F7	FD
220 V	M7				FU	MW	M	M7	MD
230 V	P7				FU	MW	M	P7	
400 V	V7					QW	V	V7	

Motor power AC3 380/400 V	18,5 kW	22 kW	30 kW	37 kW	45 kW	55 kW	75 kW
TeSys D contactor							
Ie max. AC3 (Ue ≤ 440 V)	40 A	50 A	65 A	80 A	95 A	115 A	150 A
Ie AC1 (T < 60°C)	60 A	80 A	80 A	125 A	125 A	200 A	200 A
Contactor (*)	LC1D40A ■■	LC1D50A ■■	LC1D65A ■■	LC1D80 ●●	LC1D95 ●●	LC1D115 ■■	LC1D150 ■■
Breaking capacity Icu/400 V	50 KA	50 KA	50 KA	70 KA	70 KA	70 KA	70 KA
Thermal-magnetic circuit breaker	GV3P40	GV3P50	GV3P65	GV7RS80	GV7RS100	GV7RS150	GV7RS150
	Rotary handle			Tumbler control			
Breaking capacity Icu/400 V	50 KA	50 KA	50 KA	15 KA	35 KA	35 KA	35 KA
Thermal-magnetic circuit breaker	GV3P40	GV3P50	GV3P65	GV3ME80	GV7RE100	GV7RE150	GV7RE150
	Rotary handle		Pushbutton control		Tumbler control		
Breaking capacity Icu/400 V	50 KA	50 KA	50 KA	70 KA	70 KA	70 KA	70 KA
Magnetic circuit breaker	GV3L40	GV3L50	GV3L65	NS80HMA	NSX100HMA	NSX160HMA	NSX160HMA
	Rotary handle			Tumbler control			
Breaking capacity Icu/400 V	50 KA	50 KA	50 KA	70 KA	50 KA	50 KA	50 KA
Magnetic circuit breaker	GV3L40	GV3L50	GV3L65	NS80HMA	NSX100NMA	NSX160NMA	NSX160NMA
	Rotary handle			Tumbler control			
Switch disconnector fuse	GS2F	GS2F	GS2J	GS2J	GS2J	GS2K	GS2LL GS2L
Fuse type	14 x 51	14 x 51	22 x 58	22 x 58	22 x 58	22 x 58	T00 T0
Operational current Ie/400 V	40 A	50 A	80 A	100 A	100 A	125 A	160 A
Thermal overload relay c10A	-	-	-	LRD3363	LRD3365	LRD4367	LRD4369
	LRD340	LRD350	LRD365	-	-	LR9D5369 (1)	LR9D5369 (1)
Thermal overload relay c120	LRD340L	LRD350L	LRD365L	LR2D3563	-	LR9D5569 (1)	LR9D5569 (1)

(*) The end of the product references must be replaced by a coil voltage code as indicated above (eg.: "P7" for 230 V AC, "BD" for 24 V DC). For more details, please refer to TeSys catalogue
 (1) Electronic products

TeSys Universal

Build your motor starter!

	Contactor	Thermal-magnetic circuit breaker	Magnetic circuit breaker	Switch disconnecter fuse	Thermal overload relay	Compact starter controller	Main / Emergency stop switch disconnecter	Fuse carrier	Ultra compact motor starter
Range name	TeSys B, K, D, F	TeSys GV	TeSys GV.L	TeSys GS	TeSys K, D, F	TeSys U	TeSys Vario	TeSys DF	TeSys H
Product reference prefix	LC	GV	GV.L	GS	LR	LU	V	DF	LZ
Motor starter structure - 4 functions to be covered:									
 Disconnection and breaking	■	■	■	■	■	■	■	■	■
 Short-circuit protection	■	■	■	■	■	■	■	■	■
 Overload protection	■	■	■	■	■	■	■	■	■
 Control	■	■	■	■	■	■	■	■	■

Voltage coil code

	■ ■	■ ■	■ ■	□ □	★ ★	★ ★
	AC	DC	DC < 2.4 W	AC/DC	AC	DC
24 V	B7	BD	BL			
48 V	E7	ED	EL			
72 V		SD	SL			
110 V	F7	FD		FW	F7	FD
220 V	M7			MW	M7	MD
230 V	P7			MW	P7	
400 V	V7			QW	V7	



Motor power AC3 380/400 V	90 kW	110 kW	132 kW	160 kW	200 kW	250 kW	315 kW	400 kW	560 kW
TeSys F contactor									
Ie max. AC3 (Ue ≤ 440 V)	185 A	225 A	265 A	330 A	400 A	500 A	630 A	800 A	1000 A
Ie AC1 (T < 60°C)	275 A	315 A	350 A	400 A	500 A	700 A	1000 A	1000 A	1250 A
Contactor (*)	LC1F185 ■■	LC1F225 ■■	LC1F265 ■■	LC1F330 ■■	LC1F400 ■■	LC1F500 ■■	LC1F630 ■■	LC1F800 □□	LC1F1000 ★★
Breaking capacity Icu/400 V	70 KA	70 KA	70 KA	70 KA	70 KA	70 KA	70 KA	70 KA	70 KA
Thermal-magnetic circuit breaker	GV7RS220	GV7RS220	NSX400H	NSX400H	NSX630H	NSX630H	NS800H	NS800H	NS1000L
	Tumbler control		(1)	(1)	(1)	(1)	Micrologic 5.0	Micrologic 5.0	Micrologic 5.0
Breaking capacity Icu/400 V	35 KA	35 KA	45 KA	45 KA	45 KA	45 KA	50 KA	50 KA	42 KA
Thermal-magnetic circuit breaker	GV7RE220	GV7RE220	NSX400N	NSX400N	NSX630N	NSX630N	NS800N	NS800N	NS1000L
	Tumbler control		(1)	(1)	(1)	(1)	Micrologic 5.0	Micrologic 5.0	Micrologic 5.0
Breaking capacity Icu/400 V	70 KA	70 KA	70 KA	70 KA	70 KA	70 KA	70 KA	70 KA	70 KA
Magnetic circuit breaker	NSX250HMA	NSX250HMA	NSX400H	NSX400H	NSX630H	NSX630H	NS800H	NS800H	NS1000L
	Tumbler control		Micrologic 1.3-M	Micrologic 1.3-M	Micrologic 1.3-M	Micrologic 1.3-M	(2)	(2)	(2)
Breaking capacity Icu/400 V	50 KA	50 KA	50 KA	50 KA	50 KA	50 KA	50 KA	50 KA	42 KA
Magnetic circuit breaker	NSX250NMA	NSX250NMA	NSX400N	NSX400N	NSX630N	NSX630N	NS800N	NS800N	NS1000L
	Tumbler control		Micrologic 1.3-M	Micrologic 1.3-M	Micrologic 1.3-M	Micrologic 1.3-M	(2)	(2)	(2)
Switch disconnecter fuse	GS2N	GS2N	GS2N	GS2QQ	GS2QQ	GS2S	GS2S	GS2V	GS2V
Fuse type	T1	T1	T1	T2	T2	T3	T3	T4	T4
Operational current Ie/400 V	200 A	250 A	315 A	400 A	500 A	500 A	630 A	800 A	1000 A
Thermal overload relay cI10A	-	-	-	-	-	-	LRD10 + current transformer 5A/5VA (3)		
	LR9F5371	LR9F5371	LR9F7375	LR9F7375	LR9F7379	LR9F7379	LR9F7381	-	-
Thermal overload relay cI20	LR9F5571	LR9F5571	LR9F7575	LR9F7575	LR9F7579	LR9F7579	LR9F7579	-	-

(*) The end of the product references must be replaced by a coil voltage code as indicated above (eg.: "P7" for 230 V AC, "BD" for 24 V DC). For more details, please refer to TeSys catalogue





(1) Micrologic 2.3-M or Micrologic 6.3-M for advanced motor protection

(2) Micrologic 5.0 + Plug LR Off

(3) Electromechanical product

TeSys Universal

Build your motor starter!

	Contactor	Thermal-magnetic circuit breaker	Magnetic circuit breaker	Switch disconnector fuse	Thermal overload relay	Compact starter controller	Main / Emergency stop switch disconnecter	Fuse carrier	Ultra compact motor starter
Range name	TeSys B, K, D, F	TeSys GV	TeSys GV,L	TeSys GS	TeSys K, D, F	TeSys U	TeSys Vario	TeSys DF	TeSys H
Product reference prefix	LC	GV	GV,L	GS	LR	LU	V	DF	LZ
Motor starter structure - 4 functions to be covered:									
 Disconnection and breaking	■	■	■	■	■	■	■	■	■
 Short-circuit protection	■	■	■	■	■	■	■	■	■
 Overload protection	■	■	■	■	■	■	■	■	■
 Control	■	■	■	■	■	■	■	■	■

3

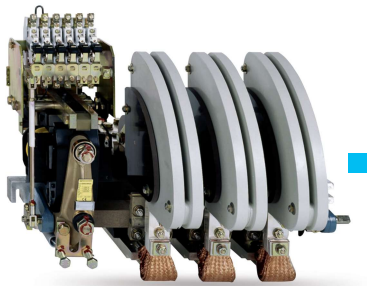

Voltage coil code

	■ ■	■ ■	■ ■	● ●	★ ★	□ □	□	★ ★	★ ★
	AC	DC	DC < 2.4 W	DC	AC/DC	AC/DC	AC 40/400	AC	DC
24 V	B7	BD	BL	BW	B/BL				
48 V	E7	ED	EL	EW	ES				
72 V		SD	SL	SW	ES				
110 V	F7	FD		FW	FU	FW	F	F7	FD
220 V	M7				FU	MW	M	M7	MD
230 V	P7				FU	MW	M	P7	
400 V	V7					QW	V	V7	

Motor power AC3 380/400 V	400 kW	500 kW	630 kW	800 kW	900 kW
TeSys B contactor (3)					
le max. AC3 (Ue ≤ 440 V)	800 A	1000 A	1500 A	1500 A	1800 A
le AC1 (T < 60°C)	800 A	1250 A	2000 A	2000 A	2750 A
Contactor (*)	LC1BL33 □	LC1BM33 □	LC1BP33 □	LC1BP33 □	LC1BR33 □
Breaking capacity Icu/400 V	70 KA	70 KA	70 KA	85 KA	85 KA
Thermal-magnetic circuit breaker	NS800H	NS1000H	NS1250H	NS1600H	NS2000H
	Micrologic 5.0	Micrologic 5.0	Micrologic 5.0	Micrologic 5.0	Micrologic 5.0
Breaking capacity Icu/400 V	50 KA	50 KA	50 KA	70 KA	70 KA
Thermal-magnetic circuit breaker	NS800N	NS1000N	NS1250N	NS1600N	NS2000N
	Micrologic 5.0	Micrologic 5.0	Micrologic 5.0	Micrologic 5.0	Micrologic 5.0
Breaking capacity Icu/400 V	70 KA	70 KA	70 KA	85 KA	85 KA
Magnetic circuit breaker	NS800H	NS1000H	NS1250H	NS1600H	NS2000H
	(2)	(2)	(2)	(2)	(2)
Breaking capacity Icu/400 V	50 KA	50 KA	50 KA	70 KA	70 KA
Magnetic circuit breaker	NS800N	NS1000N	NS1250N	NS1600N	NS2000N
	(2)	(2)	(2)	(2)	(2)
Switch disconnector fuse	GS2V	GS2V	GS2V	GS2V	GS2V
Fuse type	T4	T4	T4	T4	T4
Operational current Ie/400 V	800 A	1000 A	1250 A	2 x 800 A	2 x 1000 A





(*) The end of the product references must be replaced by a coil voltage code as indicated above (eg.: "P7" for 230 V AC, "BD" for 24 V DC). For more details, please refer to TeSys catalogue

(2) Micrologic 5.0 + Plug LR Off

(3) For further information, see TeSys B application notes available on www.schneider-electric.com

TeSys Universal

Build your motor starter!

	Contactor	Thermal-magnetic circuit breaker	Magnetic circuit breaker	Switch disconnector fuse	Thermal overload relay	Compact starter controller	Main / Emergency stop switch disconnector	Fuse carrier	Ultra compact motor starter
Range name	TeSys B, K, D, F	TeSys GV	TeSys GV,L	TeSys GS	TeSys K, D, F	TeSys U	TeSys Vario	TeSys DF	TeSys H
Product reference prefix	LC	GV	GV,L	GS	LR	LU	V	DF	LZ
Motor starter structure - 4 functions to be covered:									
	Disconnection and breaking	■	■	■	■	■	■	■	■
	Short-circuit protection	■	■	■	■	■	■	■	■
	Overload protection	■	■	■	■	■	■	■	■
	Control	■	■	■	■	■	■	■	■



TeSys Mini-Vario for standard applications				
Main switch disconnector	Door mounting	Ø 22.5 fixing	VBDN12	VBDN20
		4 screw fixing	-	-
Switch disconnector Emergency stop	Mounting at back of enclosure	Ø 22.5 fixing	VCCDN12	VCCDN20
		4 screw fixing	-	-
	Door mounting	Ø 22.5 fixing	VCDN12	VCDN20
		4 screw fixing	-	-
		Thermal current I _{th} (A)	12	20

TeSys Vario for high performance applications							
Main switch disconnector	Door mounting	Ø 22.5 fixing	VBD02	VBD01	VBD0	VBD1	VBD2
		4 screw fixing	VBF02	VBF01	VBF0	VBF1	VBF2
Switch disconnector Emergency stop	Mounting at back of enclosure	Ø 22.5 fixing	VCCD02	VCCD01	VCCD0	VCCD1	VCCD2
		4 screw fixing	VCCF02	VCCF01	VCCF0	VCCF1	VCCF2
	Door mounting	Ø 22.5 fixing	VCD02	VCD01	VCD0	VCD1	VCD2
		4 screw fixing	VCF02	VCF01	VCF0	VCF1	VCF2
		Thermal current I _{th} (A)	12	20	25	32	40

TeSys Vario for high performance applications						
Main switch disconnector	Door mounting	Ø 22.5 fixing	-	-	-	-
		4 screw fixing	VBF3	VBF4	VBF5	VBF6
Switch disconnector Emergency stop	Mounting at back of enclosure	Ø 22.5 fixing	-	-	-	-
		4 screw fixing	VCCF3	VCCF4	VCCF5	VCCF6
	Door mounting	Ø 22.5 fixing	-	-	-	-
		4 screw fixing	VCF3	VCF4	VCF5	VCF6
		Thermal current I _{th} (A)	63	80	125	175



TeSys DF fuse carrier				
Fuse type	8x32	10x38	14x51	22x58



Altistart soft starters

Altivar variable speed drives

4



Altistart 01 soft starters for 0.37 to 15 kW/0.5 to 20 HP motors



1 Altistart 01 soft starters for 0.37 to 11 kW motors and single or 3-phase supply voltage 110...480 V 50/60 Hz (1)

Power for single-phase motor (2)	Under 230 V (kW)	0.37	0.75	1.1	1.5	2.2				
Power for 3-phase motor (2)	Under 110 V (HP)	–	–	0.5	–	1	1.5	2	3	
	Under 230 V (kW)	0.37	0.55	0.75	1.1	1.5	2.2	3	4	5.5
	Under 230 V (HP)	0.5	–	1	1.5	2	3	5	7.5	
	Under 400 V (KW)	1.1	–	2.2	3	4	5.5	7.5	9	11
	Under 460 V (HP)	0.5	1.5	2	3	5	7.5	10	15	
Nominal current I _{cL} (A) (3)		3	6	9	12	25				
Dimensions: W x D x H (mm)		22.5 x 100.4 x 100				45 x 130.7 x 124				
Reference		ATS01N103FT	ATS01N106FT	ATS01N109FT	ATS01N112FT	ATS01N125FT				

2 Altistart 01 soft start/soft stop units for 0.75 to 15 kW motors (4) and 3-phase supply voltage 220...240 V 50/60 Hz (5)

Power for 3-phase motor 220...240 V 50/60 Hz (kW) (2)	0.75/1.1	1.5	2.2/3	4/5.5	7.5				
Power in HP (2)	1/1.5	2	3/-	5/7.5	10				
Nominal current I _{cL} (A) (3)	6	9	12	22	32				
Dimensions: W x D x H (mm)	45 x 130.7 x 124				45 x 130.7 x 154				
Reference	ATS01N206LU	ATS01N209LU	ATS01N212LU	ATS01N222LU	ATS01N232LU				

Altistart 01 soft start/soft stop units for 0.75 to 15 kW motors (4) and 3-phase supply voltage 380...415 V 50/60 Hz (5)

Power for 3-phase motor 380...415 V 50/60 Hz (kW) (2)	1.5/2.2/3	4	5.5	7.5/11	15				
Power in HP (2)	–	–	–	–	–				
Nominal current I _{cL} (A) (3)	6	9	12	22	32				
Dimensions: W x D x H (mm)	45 x 130.7 x 124				45 x 130.7 x 154				
Reference	ATS01N206QN	ATS01N209QN	ATS01N212QN	ATS01N222QN	ATS01N232QN				

Altistart 01 start/soft stop units for 0.75 to 15 kW motors (4) and 3-phase supply voltage 440...480 V 50/60 Hz (5)

Power for 3-phase motor 440...480 V 50/60 Hz (kW) (2)	–	–	–	–	–				
Power in HP (2)	2/3	5	7.5	10/15	20				
Nominal current I _{cL} (A) (3)	6	9	12	22	32				
Dimensions: W x D x H (mm)	45 x 130.7 x 124				45 x 130.7 x 154				
Reference	ATS01N206RT	ATS01N209RT	ATS01N212RT	ATS01N222RT	ATS01N232RT				

(1) Number of possible start-stops/hour: 100 for starting time of 1 s maximum, 20 for starting time of 5 s maximum.

(2) Standard motor power ratings, HP power ratings indicated according to standard UL508. (3) I_{cL} corresponds to the starter rating. (4) Control power supply built into the starter.

(5) Number of possible start-stops/hour: 100 for starting time of 1 s maximum, 20 for starting time of 5 s maximum, 10 for starting time of 10 s maximum.

Altistart 22 soft starters for 3 to 500 HP motors

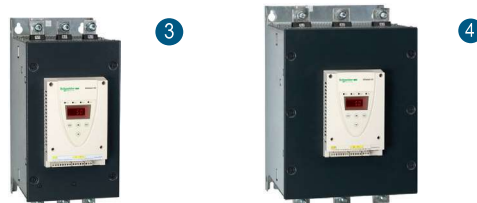

Altistart 22 soft start/soft stop units for 3-phase power supply voltage 208...600 V and 110 V control power supply Connection in the motor power supply line

Motor power in HP	208 V	3	7.5	–	15	20	25	30	40
	230 V	5	10	15	20	25	30	40	50
	460 V	10	10	30	40	50	60	75	100
	575 V	15	25	40	50	60	75	100	125
	Nominal current I _{cL} (A) (3)	17	32	47	62	75	88	110	140
Number of starts/hour	Without fan	6	6	6	6	6	6	4	4
	With fan (6)	10	10	10	10	10	10	10	10
Dimensions: W x D x H (mm)	130 x 265 x 169				145 x 295 x 207			150 x 356 x 229	
Reference	ATS22D17S6U	ATS22D32S6U	ATS22D47S6U	ATS22D62S6U	ATS22D75S6U	ATS22D88S6U	ATS22C11S6U	ATS22C14S6U	

3

Motor power in HP	208 V	50	60	75	100	125	150	–
	230 V	60	75	100	125	150	–	200
	460 V	125	150	200	250	300	350	400
	575 V	150	200	250	300	350	400	500
	Nominal current I _{cL} (A) (3)	170	210	250	320	410	480	590
Number of	Without fan	4	–	–	–	–	–	–



Altistart 22 soft starters for 4 to 500 kW motors



1 Altistart 22 soft start/soft stop units for 3-phase power supply voltage 230...440 V and 220 V 50-60 Hz control power supply Connection in the motor power supply line or in the motor delta connection (1)

Motor power in kW (motor power supply line)	230 V	4	7.5	11	15	18.5	22	30	37	
	400 V	7.5	15	22	30	37	45	55	75	
	440 V	7.5	15	22	30	37	45	55	75	
Motor power in kW (motor delta connection) (1)	230 V	5.5	11	18.5	22	30	37	45	55	
	400 V	11	22	45	55	55	75	90	110	
	440 V	15	22	45	55	75	75	90	110	
Nominal current I _{CL} (A) (2)		17	32	47	62	75	88	110	140	
Number of starts/hour	Without fan	6	6	6	6	6	6	4	4	
	With fan (3)	10	10	10	10	10	10	10	10	
Dimensions: W x D x H (mm)		130 x 265 x 169				145 x 295 x 207		150 x 356 x 229		
Reference		ATS22D17Q	ATS22D32Q	ATS22D47Q	ATS22D62Q	ATS22D75Q	ATS22D88Q	ATS22C11Q	ATS22C14Q	

Motor power in kW (motor power supply line)	230 V	45	55	75	90	110	132	160
	400 V	90	110	132	160	220	250	315
	440 V	90	110	132	160	220	250	355
Motor power in kW (motor delta connection) (1)	230 V	75	90	110	132	160	220	250
	400 V	132	160	220	250	315	355	400
	440 V	132	160	220	250	355	400	500
Nominal current I _{CL} (A) (2)		170	210	250	320	410	480	590
Number of starts/hour	Without fan	4	–	–	–	–	–	–
	With fan (3)	10	4	4	4	4	4	4
Dimensions: W x D x H (mm)		150 x 356 x 229	206 X 425 X 299			304 x 455 x 340		
Reference		ATS22C17Q	ATS22C21Q	ATS22C25Q	ATS22C32Q	ATS22C41Q	ATS22C48Q	ATS22C59Q

4

2 Altistart 22 soft start/soft stop units for 3-phase power supply voltage 230...500 V and 220 V 50-60 Hz control power supply Connection in the motor power supply line

Motor power in kW	230 V	4	7.5	11	15	18.5	22	30	37	
	400 V	7.5	15	22	30	37	45	55	75	
	440 V	7.5	15	22	30	37	45	55	75	
	500 V	9	18.5	30	37	45	55	75	90	
Nominal current I _{CL} (A) (2)		17	32	47	62	75	88	110	140	
Number of starts/hour	Without fan	–	–	–	–	–	–	–	–	
	With fan (3)	4	4	4	4	4	4	4	4	
Dimensions: W x D x H (mm)		130 x 265 x 169				145 x 295 x 207		150 x 356 x 229		
References		ATS22D17S6	ATS22D32S6	ATS22D47S6	ATS22D62S6	ATS22D75S6	ATS22D88S6	ATS22C11S6	ATS22C14S6	

Motor power in kW	230 V	45	55	75	90	110	132	160
	400 V	90	110	132	160	220	250	315
	440 V	90	110	132	160	220	250	355
	500 V	110	132	160	220	250	315	400
Nominal current I _{CL} (A) (2)		170	210	250	320	410	480	590
Number of starts/hour	Without fan	4	–	–	–	–	–	–
	With fan (3)	10	4	4	4	4	4	4
Dimensions: W x D x H (mm)		206 X 425 X 299	206 X 425 X 299		304 x 455 x 340		304 x 455 x 340	
Reference		ATS22C17S6	ATS22C21S6	ATS22C25S6	ATS22C32S6	ATS22C41S6	ATS22C48S6	ATS22C59S6

Note: All values given for Altistart 22 starters are defined for $3.5 \times I_n$ and 20s starting time, with motors with thermal protection class 10. These values are for an ambient temperature of 40 °C.
 (1) When connected in the delta configuration, starters allow the use of motors of a larger rating relative to that of the starter. In this configuration, the nominal motor current should not exceed 1.5 I_{CL}.
 (2) I_{CL} corresponds to the starter rating.
 (3) All soft starters from motor power 55 kW to 160 kW (ATS22C21.. to ATS22C59..) are equipped with a fan as standard.
 For soft starters under 55 kW (ATS22D17.. to ATS22C17..), the number of starts per hour can be increased by adding a fan. For more details, please refer to the product datasheets on our website www.schneider-electric.com



Altivar 12 ultra-compact variable speed drives for simple machine requirements



Altivar 12 drives with heatsink and single-phase supply voltage: 100...120 V 50/60 Hz (1) (2)

Motor	Power indicated on plate in kW (3)	0.18	0.37	0.75
	Power indicated on plate in HP (3)	0.25	0.5	1
Altivar 12	Max. continuous output current (3)	1.4	2.4	4.2
	Embedded communication	Modbus Serial Line		
	Application intelligence	Embedded functions		
	Withstand to harsh environment	Up to 60 °C with derating		
Dimensions: W x H x D (mm) (4)		72 x 143 x 102	72 x 143 x 121	105 x 142 x 156
Reference		ATV12 H018F1 (4)	ATV12 H037F1	ATV12 H075F1



Altivar 12 drives with heatsink and single-phase supply voltage: 200...240 V 50/60 Hz (1) (2)

Motor	Power indicated on plate in kW (3)	0.18	0.37	0.55	0.75	1.5	2.2
	Power indicated on plate in HP (3)	0.25	0.55	0.75	1	2	3
Altivar 12	Max. continuous output current (3)	1.4	2.4	3.5	4.2	7.5	10
	Dimensions: W x H x D (mm) (4)	72 x 143 x 102	72 x 143 x 121	72 x 143 x 131		105 x 142 x 156	
Reference		ATV12 H018M2 (4) (6)	ATV12 H037M2 (6)	ATV12 H055M2 (6)	ATV12 H075M2 (6)	ATV12 HU15M2 (7)	ATV12 HU22M2 (7)



Altivar 12 drives with heatsink and three-phase supply voltage: 200...240 V 50/60 Hz (1) (2)

Motor	Power indicated on plate in kW (3)	0.18	0.37	0.75	1.5	2.2	3	4
	Power indicated on plate in HP (3)	0.25	0.55	1	2	3	–	5
Altivar 12	Max. continuous output current (3)	1.4	2.4	4.2	7.5	10	12.2	16.7
	Dimensions: W x H x D (mm) (4)	72 x 143 x 102	72 x 143 x 121	72 x 143 x 131	105 x 143 x 131		140 x 184 x 141	
Reference		ATV12 H018M3 (4)	ATV12 H037M3	ATV12 H075M3	ATV12 HU15M3	ATV12 HU22M3	ATV12 HU30M3	ATV12 HU40M3



Accessories for Altivar 12 drives

Accessory	Simple Loader configuration tool (5)	Multi-Loader configuration tool (5)	USB/RJ45 cable for PC-drive connection
Compatibility	All Altivar 12 variable speed drives		
Reference	VW3A8120	VW3A8121	TCSMCNAM3M002P

Note: Altivar 12 variable speed drives are designed for 3-phase asynchronous motors.

(1) Min. (U1) and max. (U2) nominal supply voltage: 100 (U1)...120 V (U2), 200 (U1)...240 V (U2).

(2) Altivar 12 variable speed drives are supplied with built-in EMC filters and comply with standard IEC/EN 61800-3. For more information, please refer to the product datasheet on our website www.schneider-electric.com.

(3) These values are given for a nominal switching frequency of 4 kHz, for continuous operation. For derated operation, please refer to the product catalog.

ATV12 variable speed drives can supply transient output current of 1.5 x In for 60 s for every 10 min. cycle.

(4) All dimensions provided are without EMC plate installed.

(5) For more information about this tool, please refer to the product datasheet on our website www.schneider-electric.com.





Altivar Machine ATV320 variable speed drives for simple machine requirements



ATV320 drives with compact control block and single-phase supply voltage 200...240 V 50/60 Hz (1) (2)

Motor	Power indicated on plate in kW	0.18	0.37	0.55	0.75	1.1	1.5	2.2
	Power indicated on plate in HP	0.25	0.5	0.75	1	1.5	2	3
Altivar 320	Max. continuous output current (3)	1.5	3.3	3.7	4.8	6.9	8	11
Dimensions: W x H x D (mm) (4)		72 x 143 x 109	72 x 143 x 128	72 x 143 x 138			105 x 142 x 158	
Reference		ATV320 U02M2C	ATV320 U04M2C	ATV320 U06M2C	ATV320 U07M2C	ATV320 U11M2C	ATV320 U15M2C	ATV320 U22M2C

ATV320 drives with compact control block and three-phase supply voltage 380...500 V 50/60 Hz (1) (2)

Motor	Power indicated on plate in kW	0.37	0.55	0.75	1.1	1.5	2.2	3	4
	Power indicated on plate in HP	0.5	0.75	1	1.5	2	3	4	5
Altivar 320	Max. continuous output current (3)	1.5	1.9	2.3	3	4.1	5.5	7.1	9.5
Dimensions: W x H x D (mm) (4)		105 x 143 x 158						140 x 184 x 158	
Reference		ATV320 U04N4C	ATV320 U06N4C	ATV320 U07N4C	ATV320 U11N4C	ATV320 U15N4C	ATV320 U22N4C	ATV320 U30N4C	ATV320 U40N4C

4



ATV320 drives with book control block and single-phase supply voltage 200...240 V 50/60 Hz (1) (2)

Motor	Power indicated on plate in kW	0.18	0.37	0.55	0.75	1.1	1.5	2.2
	Power indicated on plate in HP	0.25	0.5	0.75	1	1.5	2	3
Altivar 320	Max. continuous output current (3)	1.5	3.3	3.7	4.8	6.9	8	11
Dimensions: W x H x D (mm) (5)		45 x 325 x 245				60 x 325 x 245		
Reference		ATV320 U02M2B	ATV320 U04M2B	ATV320 U06M2B	ATV320 U07M2B	ATV320 U11M2B	ATV320 U15M2B	ATV320 U22M2B

ATV320 drives with book control block and three-phase supply voltage 380...500 V 50/60 Hz (1) (2)

Motor	Power indicated on plate in kW	0.37	0.55	0.75	1.1	1.5	2.2	3	4
	Power indicated on plate in HP	0.5	0.75	1	1.5	2	3	4	5
Altivar 320	Max. continuous output current (3)	1.5	1.9	2.3	3	4.1	5.5	7.1	9.5
Dimensions: W x H x D (mm) (5)		45 x 325 x 245				60 x 325 x 245			
Reference		ATV320 U04N4B	ATV320 U06N4B	ATV320 U07N4B	ATV320 U11N4B	ATV320 U15N4B	ATV320 U22N4B	ATV320 U30N4B	ATV320 U40N4B

Motor	Power indicated on plate in kW	5.5	7.5	11	15
	Power indicated on plate in HP	7.5	10	15	20
Altivar 320	Max. continuous output current (3)	14.3	17	27.7	33
Dimensions: W x H x D (mm) (5)		150 x 232 x 232		180 x 330 x 232	
Reference		ATV320 U55N4B	ATV320 U75N4B	ATV320 D11N4B	ATV320 D15N4B

Note: Altivar Machine ATV320 variable speed drives are designed for 3-phase synchronous and asynchronous motors. ATV320 drives are supplied with braking chopper as standard. For braking resistor selection, please refer to the product catalog on our website www.schneider-electric.com.

(1) Altivar Machine ATV320 variable speed drives are compliant with Machinery Directive 2006/42/EC. Compliant safety functions are Safe Torque Off (STO), Safe Stop 1 (SS1), Safe Limited Speed (SLS), Safe Maximum Speed (SMS), and Guard Door Lock (GDL).

(2) Altivar Machine ATV320 variable speed drives are supplied with built-in EMC filters and comply with standard IEC/EN 61800-3. For more information, please refer to the product datasheet on our website www.schneider-electric.com.

(3) Altivar Machine ATV320 variable speed drives can supply transient output current of 1.5 x In for 60 s for every 10 min. cycle.

(4) For ATV320 drives with compact control block and ATV320 drives with book control > 5.5 kW, EMC plate (or UL type 1 kit) dimensions are not applicable.

(5) For ATV320 drives with book control ≤ 4kW, EMC plate dimensions are applicable.

For more information, please refer to the "Variable speed drives - Altivar Machine ATV320" catalog on our website www.schneider-electric.com.





Communication modules and accessories for ATV320 variable speed drives



Communication buses and networks

Type of communication module (1)	CANopen daisy chain (2) (3) (4)	CANopen SUB-D9 (2) (3) (4)	CANopen open style (2) (3) (4)
Compatibility	All Altivar Machine ATV320 variable speed drives		
Type of ports	2 RJ45 connectors	1 x 9-way male SUB-D connector	1 x 5-way screw terminal block
Reference	VW3A3608	VW3A3618	VW3A3628

Type of communication module (1)	Modbus TCP and Ethernet/IP network module (3)	PROFIBUS DP V1 communication module (3)	DeviceNet communication module (3)
Compatibility	All Altivar Machine ATV320 variable speed drives		
Type of ports	2 RJ45 connectors	1 x 9-way female SUB-D connector	1 removable 5-way screw connector
Reference	VW3A3616	VW3A3607	VW3A3609

Type of communication module (1)	EtherCat communication module (3)	ProfiNet communication module (3)
Compatibility	All Altivar Machine ATV320 variable speed drives	
Type of ports	2 RJ45 connectors	
Reference	VW3A3601	VW3A3627



Accessories

Type of accessory	Communication adapter module (1)		
Compatibility	All Altivar Machine ATV320 variable speed drives with compact control block		
Reference (3)	VW3A3600		

Type of accessory	Simple Loader configuration tool (5)	Multi-Loader configuration tool (5)	USB/RJ45 cable for PC-drive connection
Compatibility	All Altivar Machine ATV320 variable speed drives		
Reference	VW3A8120	VW3A8121	TCSMCNAM3M002P

- (1) Altivar Machine ATV320 products with a compact control block require the VW3A3600 option adapter module in order to use any optional communication module.
 (2) The Modbus serial link always uses the RJ45 communication port. If simultaneous use of the Modbus serial link and the CANopen machine bus is required, a CANopen communication module is needed.
 (3) The Altivar Machine ATV320 drive can only take one communication module.
 (4) When one of the CANopen communication modules is inserted in the Altivar Machine ATV320 drive, CANopen communication via the RJ45 communication port is disabled.
 (5) For more information about this tool, please refer to the product datasheet on our website www.schneider-electric.com.





Your Zelio relays guide



5





Zelio Relay RXG, RSL, and RXM electromechanical relays

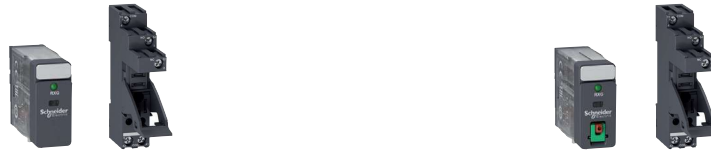

RXG interface relays

Type		RXG relays without test button				RXG relays with test button			
Contact		1 CO		2 CO		1 CO		2 CO	
Current		10 A		5 A		10 A		5 A	
Connection		Flat pins (Faston type)				Flat pins (Faston type)			
LED display		Without LED	With LED	Without LED	With LED	Without LED	With LED	Without LED	With LED
Complete product	6 VDC	RXG15RD	RXG13RD	RXG25RD	RXG23RD	RXG11RD	RXG12RD	RXG21RD	RXG22RD
	12 VDC	RXG15JD	RXG13JD	RXG25JD	RXG23JD	RXG11JD	RXG12JD	RXG21JD	RXG22JD
	24 VDC	RXG15BD	RXG13BD	RXG25BD	RXG23BD	RXG11BD	RXG12BD	RXG21BD	RXG22BD
	48 VDC	RXG15ED	RXG13ED	RXG25ED	RXG23ED	RXG11ED	RXG12ED	RXG21ED	RXG22ED
	60 VDC	RXG15ND	RXG13ND	RXG25ND	RXG23ND	RXG11ND	RXG12ND	RXG21ND	RXG22ND
	110 VDC	RXG15FD	RXG13FD	RXG25FD	RXG23FD	RXG11FD	RXG12FD	RXG21FD	RXG22FD
	24 VAC	RXG15B7	RXG13B7	RXG25B7	RXG23B7	RXG11B7	RXG12B7	RXG21B7	RXG22B7
	48 VAC	RXG15E7	RXG13E7	RXG25E7	RXG23E7	RXG11E7	RXG12E7	RXG21E7	RXG22E7
	120 VAC	RXG15F7	RXG13F7	RXG25F7	RXG23F7	RXG11F7	RXG12F7	RXG21F7	RXG22F7
	220 VAC	RXG15M7	RXG13M7	RXG25M7	RXG23M7	RXG11M7	RXG12M7	RXG21M7	RXG22M7
230 VAC	RXG15P7	RXG13P7	RXG25P7	RXG23P7	RXG11P7	RXG12P7	RXG21P7	RXG22P7	
Screw connector socket		RGZE1S35M		RGZE1S48M		RGZE1S35M		RGZE1S48M	



RSL interface relays

Type		RSL relays		Sockets for RSL relays		Pre-assembled relays/sockets	
Contact		1 CO		-		1 CO	
Current		6 A - standard	6 A - low level	-		6 A	
Connection		PCB pins		Screw connector	Spring terminal	Screw connector	Spring terminal
LED display		Without LED		-		With LED	
Complete product	12 VAC/VDC	RSL1AB4JD	RSL1GB4JD	RSLZVA1	RSLZRA1	RSL1PVJU	RSL1PRJU
	24 VAC/VDC	RSL1AB4BD	RSL1GB4BD	RSLZVA1	RSLZRA1	RSL1PVBU	RSL1PRBU
	48 VAC/VDC	RSL1AB4ED	RSL1GB4ED	RSLZVA2	RSLZRA2	RSL1PVEU	RSL1PREU
	60 VAC/VDC	RSL1AB4ND	RSL1GB4ND	RSLZVA2	RSLZRA2	-	-
	110 VAC/VDC	-	-	-	-	RSL1PVFU	RSL1PRFU
	230 VAC/VDC	-	-	-	-	RSL1PVPU	RSL1PRPU



RXM●AB miniature relays

Type		RXM●AB relays with test button					
Contact		2 CO		3 CO		4 CO	
Current		12 A		10 A		6 A	
Connection		Flat pins (Faston type)					
LED display		Without LED	With LED	Without LED	With LED	Without LED	With LED
Complete product	12 VDC	RXM2AB1JD	RXM2AB2JD	RXM3AB1JD	RXM3AB2JD	RXM4AB1JD	RXM4AB2JD
	24 VDC	RXM2AB1BD	RXM2AB2BD	RXM3AB1BD	RXM3AB2BD	RXM4AB1BD	RXM4AB2BD
	48 VDC	RXM2AB1ED	RXM2AB2ED	RXM3AB1ED	RXM3AB2ED	RXM4AB1ED	RXM4AB2ED
	110 VDC	RXM2AB1FD	RXM2AB2FD	RXM3AB1FD	RXM3AB2FD	RXM4AB1FD	RXM4AB2FD
	24 VAC	RXM2AB1B7	RXM2AB2B7	RXM3AB1B7	RXM3AB2B7	RXM4AB1B7	RXM4AB2B7
	48 VAC	RXM2AB1E7	RXM2AB2E7	RXM3AB1E7	RXM3AB2E7	RXM4AB1E7	RXM4AB2E7
	120 VAC	RXM2AB1F7	RXM2AB2F7	RXM3AB1F7	RXM3AB2F7	RXM4AB1F7	RXM4AB2F7
	230 VAC	RXM2AB1P7	RXM2AB2P7	RXM3AB1P7	RXM3AB2P7	RXM4AB1P7	RXM4AB2P7
	220 VDC	-	-	-	-	RXM4AB1MD	-
	240 VDC	-	-	-	-	RXM4AB1U7	-



Zelio Relay RPM and RPF electromechanical relays



1 RPM power relays (15 A)

Type		RPM relays with test button							
Contact		1 CO		2 CO		3 CO		4 CO	
Current		15 A							
Connection		Flat pins (Faston type)							
LED display		Without LED	With LED	Without LED	With LED	Without LED	With LED	Without LED	With LED
Complete product	12 VDC	RPM11JD	RPM12JD	RPM21JD	RPM22JD	RPM31JD	RPM32JD	RPM41JD	RPM42JD
	24 VDC	RPM11BD	RPM12BD	RPM21BD	RPM22BD	RPM31BD	RPM32BD	RPM41BD	RPM42BD
	48 VDC	RPM11ED	RPM12ED	RPM21ED	RPM22ED	RPM31ED	RPM32ED	RPM41ED	RPM42ED
	110 VDC	RPM11FD	RPM12FD	RPM21FD	RPM22FD	RPM31FD	RPM32FD	RPM41FD	RPM42FD
	24 VAC	RPM11B7	RPM12B7	RPM21B7	RPM22B7	RPM31B7	RPM32B7	RPM41B7	RPM42B7
	48 VAC	RPM11E7	RPM12E7	RPM21E7	RPM22E7	RPM31E7	RPM32E7	RPM41E7	RPM42E7
	120 VAC	RPM11F7	RPM12F7	RPM21F7	RPM22F7	RPM31F7	RPM32F7	RPM41F7	RPM42F7
	230 VAC	RPM11P7	RPM12P7	RPM21P7	RPM22P7	RPM31P7	RPM32P7	RPM41P7	RPM42P7
Screw connector socket		RPZF1		RPZF2		RPZF3		RPZF4	

2 RPF power relays (30 A)

Type		RPF relays without test button									
Contact		2 NO		2 CO		Contact		2 NO		2 CO	
Current		30 A		30 A on NO / 3 A on NC		Current		30 A		30 A on NO / 3 A on NC	
Connection		Flat pins (Faston type)									
LED display		Without LED									
Complete product	12 VDC	RPF2AJD	RPF2BJD	Complete product		24 VAC	RPF2AB7	RPF2BB7			
	24 VDC	RPF2ABD	RPF2BBD	Complete product		120 VAC	RPF2AF7	RPF2BF7			
	110 VDC	RPF2AFD	RPF2BFD	Complete product		230 VAC	RPF2AP7	RPF2BP7			

5

Zelio Relay SSL solid state relays



SSL1 slim interface solid state relays (DC switching)

Type		SSL1 relays (6 mm)		Screw connector sockets	Spring terminal sockets
Contact		1 NO		–	–
Switching type		DC switching		–	–
Load current		0.1 A	3.5 A	–	–
Load voltage		1...48 VDC	1...24 VDC	–	–
Complete product	3...12 VDC	SSL1D101JD	SSL1D03JD	SSLZVA1	SSLZRA1
	24 VDC	SSL1D101BD	SSL1D03BD	SSLZVA1	SSLZRA1
	60 VDC	SSL1D101ND	SSL1D03ND	SSLZVA2	SSLZRA2

SSL1 slim interface solid state relays (random switching)

Type		SSL1 relays (6 mm)		Screw connector sockets	Spring terminal sockets
Contact		1 NO		–	–
Switching type		Random switching		–	–
Load current		2 A		–	–
Load voltage		24...280 VAC		–	–
Complete product	3...12 VDC	SSL1A12JDR	SSL1A12BDR	SSLZVA1	SSLZRA1
	24 VDC	SSL1A12JDR	SSL1A12BDR	SSLZVA1	SSLZRA1
	60 VDC	SSL1A12NDR	SSL1A12BDR	SSLZVA2	SSLZRA2
	110 VAC/VDC	SSL1A12NDR	SSL1A12BDR	SSLZVA3	SSLZRA3
	230 VAC/VDC	SSL1A12NDR	SSL1A12BDR	SSLZVA4	SSLZRA4

SSL1 slim interface solid state relays (zero voltage switching)

Type		SSL1 relays (6 mm)		Screw connector sockets	Spring terminal sockets
Contact		1 NO		–	–
Switching type		Zero voltage switching		–	–
Load current		2 A		–	–
Load voltage		24...280 VAC		–	–
Complete product	3...12 VDC	SSL1A12JD	SSL1A12BDR	SSLZVA1	SSLZRA1



Zelio Relay SSM and SSP solid state relays



1 SSM modular DIN rail solid state relays (DC switching)

Contact	1 NO				
Switching type	DC switching				
Load current	6 A		12 A		
Load voltage	1...60 VDC	1...100 VDC	1...60 VDC	1...100 VDC	
Frontal width	12 mm		18 mm		
Complete product	4...32 VDC	SSM1D26BD	SSM1D36BD	SSM1D212BD	SSM1D312BD

2 SSM modular DIN rail solid state relays (random switching)

Contact	1 NO				2 NO		
Switching type	Random switching						
Load current	6 A		12 A		6 A		
Load voltage	24...280 VAC	48...600 VAC	24...280 VAC	48...600 VAC	24...280 VAC	48...600 VAC	
Frontal width	12 mm		18 mm				
Complete product	4...32 VDC	SSM1A16BDR	SSM1A36BDR	SSM1A112BDR	SSM1A312BDR	SSM2A16BDR	SSM2A36BDR
	18...36 VAC	SSM1A16B7R	–	SSM1A112B7R	SSM1A312B7R	–	–
	90...140 VAC	SSM1A16F7R	–	SSM1A112F7R	SSM1A312F7R	–	–
	200...265 VAC	SSM1A16P7R	–	SSM1A112P7R	SSM1A312P7R	–	–

3 SSM modular DIN rail solid state relays (zero voltage switching)

Contact	1 NO				2 NO		
Switching type	Zero voltage switching						
Load current	6 A		12 A		6 A		
Load voltage	24...280 VAC	48...600 VAC	24...280 VAC	48...600 VAC	24...280 VAC	48...600 VAC	
Frontal width	12 mm		18 mm				
Complete product	4...32 VDC	SSM1A16BD	SSM1A36BD	SSM1A112BD	SSM1A312BD	SSM2A16BD	SSM2A36BD
	90...140 VAC	SSM1A16F7	–	SSM1A112F7	SSM1A312F7	–	–
	200...265 VAC	SSM1A16P7	–	SSM1A112P7	SSM1A312P7	–	–



4 SSP1 1-phase panel mount solid state relays (DC switching)

Contact	1 NO			
Switching type	DC switching			
Load current (1)	12 A	25 A	40 A	
Load voltage	3...150 VDC			
Complete product	3...12 VDC	SSP1D412BDT	SSP1D425BDT	SSP1D440BDT

5 SSP1 1-phase panel mount solid state relays (zero voltage switching)

Contact	1 NO								
Switching type	Zero voltage switching								
Load current (1)	10 A	25 A	50 A	50 A	75 A	75 A	90 A	125 A	
Load voltage	24...300 VAC	24...300 VAC	24...300 VAC	48...660 VAC	24...300 VAC	48...660 VAC	48...660 VAC	48...660 VAC	
Complete product	4...32 VDC	SSP1A110BDT	SSP1A125BDT	SSP1A150BDT	SSP1A450BDT	SSP1A175BDT	SSP1A475BDT	SSP1A490BDT	SSP1A4125BDT
	90...280 VAC	SSP1A110M7T	SSP1A125M7T	SSP1A150M7T	SSP1A450M7T	SSP1A175M7T	SSP1A475M7T	SSP1A490M7T	SSP1A4125M7T

6 SSP3 3-phase panel mount solid state relays (random and zero voltage switching)

Contact	3 NO				
Switching type	Random switching		Zero voltage switching		
Load current (1)	25 A		50 A		
Load voltage	48...530 VAC				
Complete product	4...32 VDC	SSP3A225BDRT	SSP3A250BDRT	SSP3A225BDT	SSP3A250BDT
	18...36 VAC	SSP3A225B7RT	SSP3A250B7RT	SSP3A225B7T	SSP3A250B7T
	90...140 VAC	SSP3A225F7RT	SSP3A250F7RT	SSP3A225F7T	SSP3A250F7T
	180...280 VAC	SSP3A225P7RT	SSP3A250P7RT	SSP3A225P7T	SSP3A250P7T



Zelio Control RM17, RM22, and RM35 control relays



1 3-phase monitoring relays for DIN rail mounting

Phase loss and sequence	Yes						
Assymetry	–	Yes	–	Yes	–	–	
Undervoltage	–	–	Yes	–	–	–	
> U > window mode	–	–	–	–	Yes	–	
Measuring range	183...528 VAC	183...484 VAC	183...528 VAC	183...528 VAC	160...288 VAC	183...528 VAC	304...576 VAC
Output contacts/Current	1 CO / 5 A	2 CO / 5 A	1 CO / 5 A		2 CO / 8 A	1 CO / 5 A	2 CO / 8 A
Power supply	Self-powered						
Frontal width	17.5 mm				22.5 mm	17.5 mm	22.5 mm
Complete product	RM17TG00	RM17TG20	RM17TA00	RM17TU00	RM22TU21	RM17TE00	RM22TR33

2 3-phase voltage monitoring relays for DIN rail mounting

Detected loss of one or more phases	Yes		
Absence of neutral	–	Yes	–
Overvoltage and undervoltage	Yes		
Measuring range	183...528 VAC	114...329 VAC	194...528 VAC
Output contacts/Current	1 CO / 5 A	1 CO 5A for > U threshold + 1 CO 5A for < U threshold	
Power supply	Self-powered		
Frontal width	17.5 mm	35 mm	
Complete product	RM17UB310	RM35UB3N30	RM35UB330

3 Phase or DC voltage monitoring relays for DIN rail mounting

> U > window mode	Yes						
Overvoltage	Yes						–
Undervoltage	Yes						–
Measuring range	20...80 VAC/VDC	65...260 VAC/VDC	0.05...5 VAC/VDC	1...100 VAC/VDC	15...500 VAC/VDC	15...500 VAC/VDC	80...300 VAC/VDC
Output contacts/Current	1 CO / 5 A			2 CO / 8 A			
Power supply	Self-powered			24...240 VAC		380...415 VAC	110...240 VAC
Frontal width	17.5 mm				22.5 mm		
Complete product	RM17UBE15	RM17UBE16	RM22UA31MR	RM22UA32MR	RM22UA33MR	RM22UA33MT	RM22UB34



4 Current monitoring relays for DIN rail mounting

Monitoring characteristics	Overcurrent	> I > window mode with/without memory					
Integrated current transformer	Yes	–					
Measuring range	2...20 A	4...1,000 mA	2...500 mA	0.15...15 A			
Output contacts/Current	1 CO / 5 A	2 CO / 8 A	2 CO / 5 A		2 CO / 8 A		
Power supply	24...240 VAC/VDC						380...415 VAC
Frontal width	17.5 mm	22.5 mm	35 mm				
Complete product	RM17JC00MW	RM22JA31MR	RM35JA31MW	RM35JA32MW	RM35JA32MR	RM35JA32MT	

5 Level monitoring relays for DIN rail mounting

Level monitoring by	Resistive probe					Discrete sensor	
Measuring range	5...100 kΩ		25 Ω...1 MΩ			–	
Output contacts/Current	1 CO / 8 A		2 CO / 8 A		2 CO / 5 A	1 CO / 5 A	
Power supply	24...240 VAC/VDC	380...415 VAC	24...240 VAC/VDC	380...415 VAC	24...240 VAC/VDC	24...240 VAC/VDC	
Frontal width	22.5 mm				35 mm		
Complete product	RM22LG11MR	RM22LG11MT	RM22LA32MR	RM22LA32MT	RM35LM33MW	RM35LV14MW	

Note: Please consult our general catalog for other application relays available for motor temperature monitoring and pump, frequency, speed or temperature control.





Zelio Time electronic timing relays



1 Timing relays with screw terminals for DIN rail mounting, 1 contact

Type	1 function	2 functions	2 functions	1 function	Multifunction	Multifunction
Functions (1)	A	A, At	L, Li	C	A, At, B, C, H, Ht, D, Di, Ac, Bw	Ad, Ah, N, O, P, Pt, T, Tt, W
Timing range	0.1 s...100 h					
Type of output/current	1 solid state 0.7 A	1 relay output 1 CO / 8 A				
Power supply	24...240 VAC/VDC	24 VDC, 24...240 VAC			12...240 VAC/VDC	24 VDC, 24...240 VAC
Frontal width	17.5 mm					
Complete product	RE17LAMW	RE17RAMU	RE17RLMU	RE17RCMU	RE17RMMW (2)	RE17RMXMU

2 Timing relays with screw terminals for DIN rail mounting, 2 contacts

Type	3 functions	2 functions	Multifunction
Functions (1)	A, At, Aw	C, Ct	A, At, Aw, C, Ct, D, Dt, Dw, Di, Dit, Diw, H, Ht, Hw, Qg, Qgt, Qgw, Qt, Qtt, Qtw, W, Wt
Timing range	0.05 s...300 h		
Type of output/current	2 CO / 8 A		
Power supply	24 VDC, 24...240 VAC		
Frontal width	22.5 mm		
Complete product	RE22R1MAMR	RE22R2CMR	RE22R2MYMR

3 Miniature plug-in timing relays for DIN rail mounting

Function (1)	A (Delay on energization)					
Timing range	0.1 s...100 h					
Type of output/current	2 CO / 5 A			4 CO / 5 A		
Power supply	24 VDC	120 VAC	230 VAC	24 VDC	120 VAC	230 VAC
Dimension	21 x 27 mm miniature plug-in					
Complete product	REXL2TMBD	REXL2TMF7	REXL2TMP7	REXL4TMBD	REXL4TMF7	REXL4TMP7
Screw connector socket (3)	RXZE2S108M			RXZE2S114M		

4 48 x 48 mm analog plug-in (8-pins) timing relays for DIN rail or front panel mounting

Type	1 function	4 functions	2 functions	4 functions
Functions (1)	A	A1, A2, H1, H2	L, Li	A, B, C, Di
Timing range	0.02 s...300 h			
Type of output/current	1 CO / 5 A	1 + 1 (instant.) / 5 A	2 CO / 5 A	
Power supply	24...240 VAC/VDC			
Dimension	48 x 48 mm analog panel-mounted or plug-in			
Complete product	RE48ATM12MW	RE48AMH13MW	RE48ACV12MW	RE48AML12MW
Screw connector socket (4)	RUZC2M		RUZC3M	

A: power on-delay relay	D: symmetrical flashing relay (starting pulse-off)	L: asymmetrical flashing relay (starting pulse-off)
Ac: on-delay & off-delay relay (5)	Di: symmetrical flashing relay (starting pulse-on)	Li: symmetrical flashing relay (starting pulse-on)
Act: on-delay & off-delay relay (5) (6)	Dit: symmetrical flashing relay (starting pulse-on) (6)	Lt: symmetrical flashing relay (6)
Ad: pulse delayed relay (5)	Diw: symmetrical flashing relay (starting pulse-on) with retrigger/restart control signal	N: safe guard relay O: delayed safe guard relay
Ah: pulse delayed relay (single cycle) (5)	Dt: symmetrical flashing relay (starting pulse-off) (6)	P: pulse delayed relay with fixed pulse length
Ak: asymmetrical on-delay & off-delay relay (5)	Dw: symmetrical flashing relay (starting pulse-off) with retrigger/restart control signal	Pt: pulse delayed relay with fixed pulse length (6)
Akt: asymmetrical on-delay & off-delay relay (5) (6)	H: interval relay	Qc: star-delta timing relay, 1C/O output
At: power on-delay relay (6)	He: pulse on de-energization relay	Qe: star-delta timing relay, 1 NC + 1 NO output & split common
Aw: power on-delay relay with retrigger/restart control signal	Ht: interval relay (6)	Qg: star-delta timing relay, 2 C/O outputs & same common
A1: power on-delay relay (R1 instantaneous, R2 timed)	Hw: interval relay with retrigger/restart control signal	Qgt: star-delta timing relay, 2 C/O outputs & same common (6)
A2: power on-delay relay (both R1/R2 timed)	H1: interval relay (R1 instantaneous, R2 timed)	Qt: star-delta timing relay, 2 C/O outputs & split common
B: interval relay (5)	H2: interval relay (both R1/R2 timed)	Qtt: star-delta timing relay, 2 C/O outputs & split common (6)
Bw: double interval relay (5)	K: delay on de-energization relay (without auxiliary supply)	Tt: retriggerable bistable relay with control signal on
C: off-delay relay (5)		W: interval relay with control signal off
Ct: off-delay relay (6)		Wt: interval relay with control signal off (6)

(1) For more details about functions, please refer to the technical descriptions and schemes on our website www.schneider-electric.com.
 (2) For spring terminal version, order RE17RMMWS (3) With separate contacts (4) With mixed contacts (5) With control signal (6) With pause-summation control signal



Detection components Panorama



6

Simply easy!™

Pressure switches: OsiSense XM

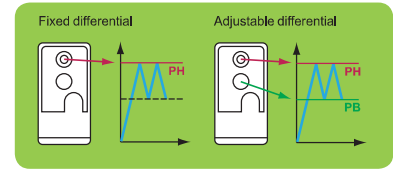
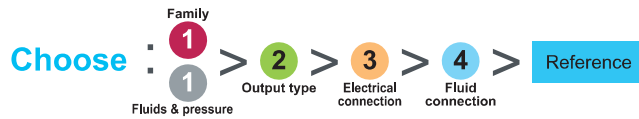

XMLA / XMLB Electromechanical	Hydraulic oils, air, fresh water, sea water / Temp: up to 70°C							
			1 C/O single pole contact fixed differential			1 C/O single pole contact adjustable differential		
	Bar	psi	ISO M20	Pg13	DIN connector	ISO M20	Pg13	DIN connector
Screw terminal 1 C/O	-1	-14.5	XMLAM01V2S12	XMLAM01V2S11	XMLAM01V2C11	XMLBM02V2S12	XMLBM02V2S11	XMLBM02V2C11
	2.5	36.3	XMLA002A2S12	XMLA002A2S11	XMLA002A2C11	XMLB002A2S12	XMLB002A2S11	XMLB002A2C11
	4	58	XMLA004A2S12	XMLA004A2S11	XMLA004A2C11	XMLB004A2S12	XMLB004A2S11	XMLB004A2C11
	10	145	XMLA010A2S12	XMLA010A2S11	XMLA010A2C11	XMLB010A2S12	XMLB010A2S11	XMLB010A2C11
	20	290	XMLA020A2S12	XMLA020A2S11	XMLA020A2C11	XMLB020A2S12	XMLB020A2S11	XMLB020A2C11
	35	508	XMLA035A2S12	XMLA035A2S11	XMLA035A2C11	XMLB035A2S12	XMLB035A2S11	XMLB035A2C11
G 1/4 (female)	Hydraulic oils / Temp: up to 160°C							
	1	14.5	XMLA001R2S12	XMLA001R2S11	XMLA001R2C11	XMLB001R2S12	XMLB001R2S11	XMLB001R2C11
	70	1015	XMLA070D2S12	XMLA070D2S11	XMLA070D2C11	XMLB070D2S12	XMLB070D2S11	XMLB070D2C11
	160	2320	XMLA160D2S12	XMLA160D2S11	XMLA160D2C11	XMLB160D2S12	XMLB160D2S11	XMLB160D2C11
	300	4350	XMLA300D2S12	XMLA300D2S11	XMLA300D2C11	XMLB300D2S12	XMLB300D2S11	XMLB300D2C11
	500	7250	XMLA500D2S12	XMLA500D2S11	XMLA500D2C11	XMLB500D2S12	XMLB500D2S11	XMLB500D2C11

XMLR Electronic + Display	Hydraulic oils, air, fresh water, refrigerant fluids							
			Analogue output		Analogue + switching output		2 switching outputs	Analogue + 2 switching outputs
	Bar	psi	4...20 mA	0...10 V	PNP - NO/NC programmable		PNP - NO/NC prog.	PNP - NO/NC prog.
M12 4 pin or 5 pin G 1/4A (female)	-1	-14.5	XMLRM01G0T25	XMLRM01G0T75	XMLRM01G1P25	XMLRM01G1P75	XMLRM01G2P05	XMLRM01G2P25
	1	14.5	XMLR001G0T25	XMLR001G0T75	XMLR001G1P25	XMLR001G1P75	XMLR001G2P05	
	2.5	35.2	XMLR2D5G0T25	XMLR2D5G0T75	XMLR2D5G1P25	XMLR2D5G1P75	XMLR2D5G2P05	
	10	145	XMLR010G0T25	XMLR010G0T75	XMLR010G1P25	XMLR010G1P75	XMLR010G2P05	XMLR010G2P25
	16	232	XMLR016G0T25	XMLR016G0T75	XMLR016G1P25	XMLR016G1P75	XMLR016G2P05	
	25	362	XMLR025G0T25	XMLR025G0T75	XMLR025G1P25	XMLR025G1P75	XMLR025G2P05	
	40	580	XMLR040G0T25	XMLR040G0T75	XMLR040G1P25	XMLR040G1P75	XMLR040G2P05	XMLR040G2P25
	100	1450	XMLR100G0T25	XMLR100G0T75	XMLR100G1P25	XMLR100G1P75	XMLR100G2P05	
	160	2320	XMLR160G0T25	XMLR160G0T75	XMLR160G1P25	XMLR160G1P75	XMLR160G2P05	
	250	3625	XMLR250G0T25	XMLR250G0T75	XMLR250G1P25	XMLR250G1P75	XMLR250G2P05	XMLR250G2P25
400	5800	XMLR400G0T25	XMLR400G0T75	XMLR400G1P25	XMLR400G1P75	XMLR400G2P05	XMLR400G2P25	
600	8700	XMLR600G0T25	XMLR600G0T75	XMLR600G1P25	XMLR600G1P75	XMLR600G2P05		

XMLG/XMLP Electronic transmitter	Hydraulic oils, air, fresh water, refrigerant fluids								
			Analogue output			ZMLP Display & switch	4-20mA analogue + switching output		2 switching outputs
	Bar	psi	4...20 mA	0...10 V	0.5...4.5 V		NO/NC Prog.		NO/NC Prog.
M12 4 pin (male) G 1/4A (male)	-1	-14.5	XMLGM01D21	XMLGM01D71		M12 4 pin (female)	Window	Hysteresis	Fixed hysteresis
	1	14.5	XMLG001D21	XMLG001D71					
	6	87	XMLG006D21	XMLG006D71			ZMLPA1P2SW	ZMLPA1P2SH	ZMLPA2P0SH
	10	145	XMLP010BD21V	XMLP010BD71V	XMLP010BD11V				
	16	232	XMLP016BD21V	XMLP016BD71V	XMLP016BD11V				
	25	362	XMLP025BD21V	XMLP025BD71V	XMLP025BD11V				
	40	580	XMLP040BD21V	XMLP040BD71V	XMLP040BD11V				
	60	870	XMLP060BD21V	XMLP060BD71V	XMLP060BD11V				
	100	1450	XMLP100BD22	XMLP100BD72	XMLP100BD12				
	160	2320	XMLP160BD22	XMLP160BD72	XMLP160BD12				
	250	3625	XMLP250BD22	XMLP250BD72	XMLP250BD12				
	400	5800	XMLP400BD22	XMLP400BD72	XMLP400BD12				
600	8700	XMLP600BD22	XMLP600BD72	XMLP600BD12					

Only usable with 4-20mA analogue output electronic transmitter (e.g.: XMLG, XMLP)

Quick fixing bracket	Horizontal plan	Vertical plan or pipe
	XMLPZLH01	XMLPZLV01

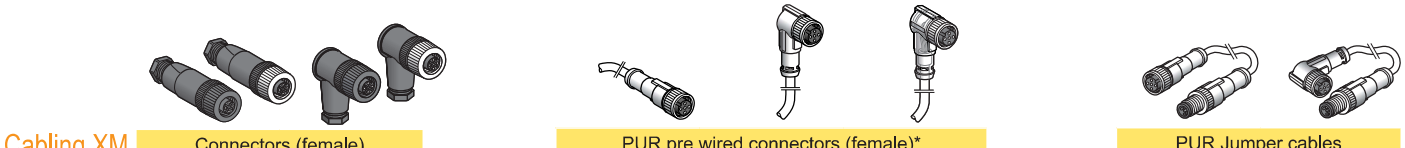

Cabling XM Connectors (female) PUR pre-wired connectors (female)* PUR Jumper cables

Limit switches: OsiSense XC

Choose: **1** > **2** > **3** > **4** > Reference
 Body Head Contact Connection

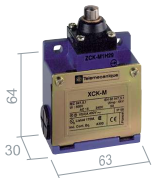
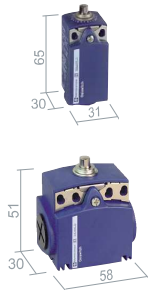

Model	Material	Contact	Connection	1	2	3	4	5	6	7	8									
XCKD	Metal	NO+NC Snap	M16	XCKD2110P16	XCKD2102P16	XCKD2121P16	XCKD2106P16	XCKD2118P16	XCKD2145P16											
			Pg11	XCKD2110G11	XCKD2102G11	XCKD2121G11	XCKD2106G11	XCKD2118G11	XCKD2145G11											
			M12 5P	XCKD2110M12	XCKD2102M12	XCKD2121M12	XCKD2106M12	XCKD2118M12	XCKD2145M12											
XCKP	Plastic	NO+NC Snap	M16	XCKP2110P16	XCKP2102P16	XCKP2121P16	XCKP2106P16	XCKP2118P16	XCKP2145P16											
			Pg11	XCKP2110G11	XCKP2102G11	XCKP2121G11	XCKP2106G11	XCKP2118G11	XCKP2145G11											
			M12 4P	XCKP2110M12	XCKP2102M12	XCKP2121M12	XCKP2106M12	XCKP2118M12	XCKP2145M12											
XCKT	Plastic	NO+NC Snap	M16	XCKT2110P16	XCKT2102P16	XCKT2121P16	XCKT2106P16	XCKT2118P16	XCKT2145P16											
			Pg11	XCKT2110G11	XCKT2102G11	XCKT2121G11	XCKT2106G11	XCKT2118G11	XCKT2145G11											
XCMD	Metal	NO+NC Snap	1 m	XCMD2110L1	XCMD2102L1	XCMD2124L1	XCMD21F0L1	XCMD212F1L1	XCMD2115L1	XCMD2116L1										
		NO+NC Slow	1 m	XCMD2510L1	XCMD2502L1	XCMD2524L1	XCMD25F0L1	XCMD252F1L1	XCMD2515L1	XCMD2516L1										
		NO+NC Snap	M12 5P	XCMD2110C12	XCMD2102C12	XCMD2124C12	XCMD21F0C12	XCMD212F2C12	XCMD2115C12	XCMD2116C12										
		1 C/O Snap	M12 4P	XCMD2110M12	XCMD2102M12	XCMD2124M12	XCMD21F0M12	XCMD212F2M12	XCMD2115M12	XCMD2116M12										
XCKM	Metal	NO+NC Snap	M20	XCKM110H29	XCKM102H29	XCKM121H29	XCKM115H29	XCKM106H29												
			Pg11	XCKM110	XCKM102	XCKM121	XCKM115	XCKM106												
XCKL	Metal	NO+NC Snap	CG	XCKL110	XCKL102	XCKL121	XCKL115	XCKL106												
XCKJ	Metal	NO+NC Snap	M20	XCKJ161H29	XCKJ167H29	XCKJ10511H29	XCKJ10513H29	XCKJ10541H29	XCKJ10559H29											
			Pg13	XCKJ161	XCKJ167	XCKJ10511	XCKJ10513	XCKJ10541	XCKJ10559											
			1/2NPT	XCKJ161H7	XCKJ167H7	XCKJ10511H7	XCKJ10513H7	XCKJ10541H7	XCKJ10559H7											
			M12 5P	XCKJ161D	XCKJ167D	XCKJ10511D	XCKJ10513D	XCKJ10541D	XCKJ10559D											
				(1) Plastic roller	(2) Steel roller															
XCSA	Metal		M20		NC+2NO Slow	2NC+NO Slow	3NC Slow	Accessories												
			Pg13	XCSA502	XCSA501	XCSA503	XCSA702	XCSA701	XCSA703	XCSA802	XCSA801	XCSA803	XCSZ01	XCSZ03						
			1/2NPT																	
XCSPA	Plastic		M16		NC+NO Slow	2NC Slow	2NO+NC Slow	2NC+NO Slow	2NC+NO Snap	Accessories										
			Pg11	XCSPA592	XCSPA591	XCSPA593	XCSPA792	XCSPA791	XCSPA793	XCSPA892	XCSPA891	XCSPA893	XCSPA992	XCSPA991	XCSPA993	XCSPA492	XCSPA491	XCSPA493	XCSZ11	XCSZ13
			1/2NPT																	

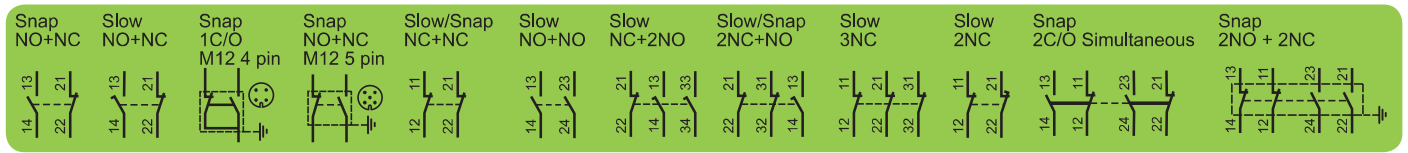

- M16 Tapped M16x1.5 for ISO cable gland
- M20 Tapped M20x1.5 for ISO cable gland
- Pg11 Tapped for a N°11 cable gland
- Pg13 Tapped for a N°13 cable gland

Cabling XC

Connection	Configuration	Reference
M12	straight	PUR pre wired connectors (female)*
	elbowed	
	elbowed PNP LED	
M12	straight	Connectors (female)
	elbowed	

Limit switches: OsiSense XC

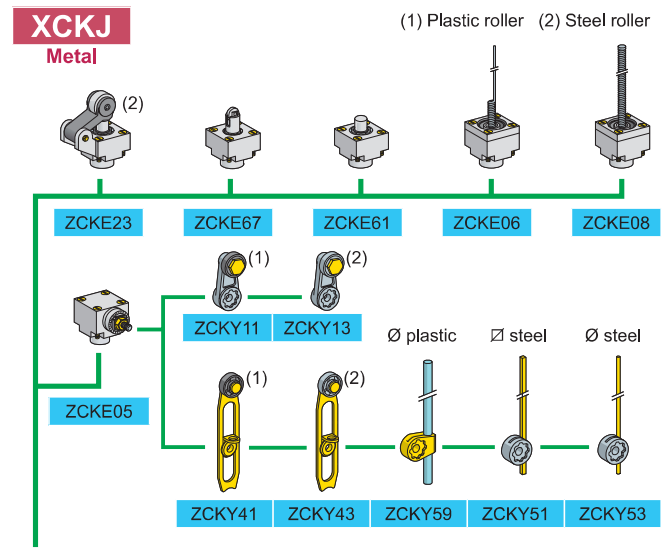
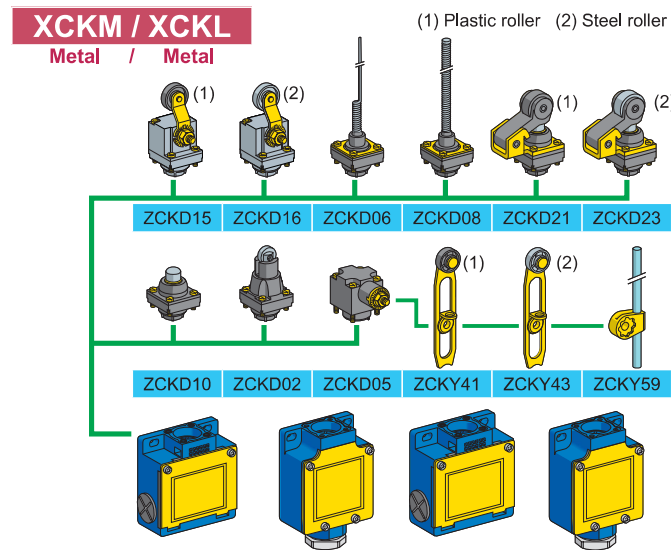
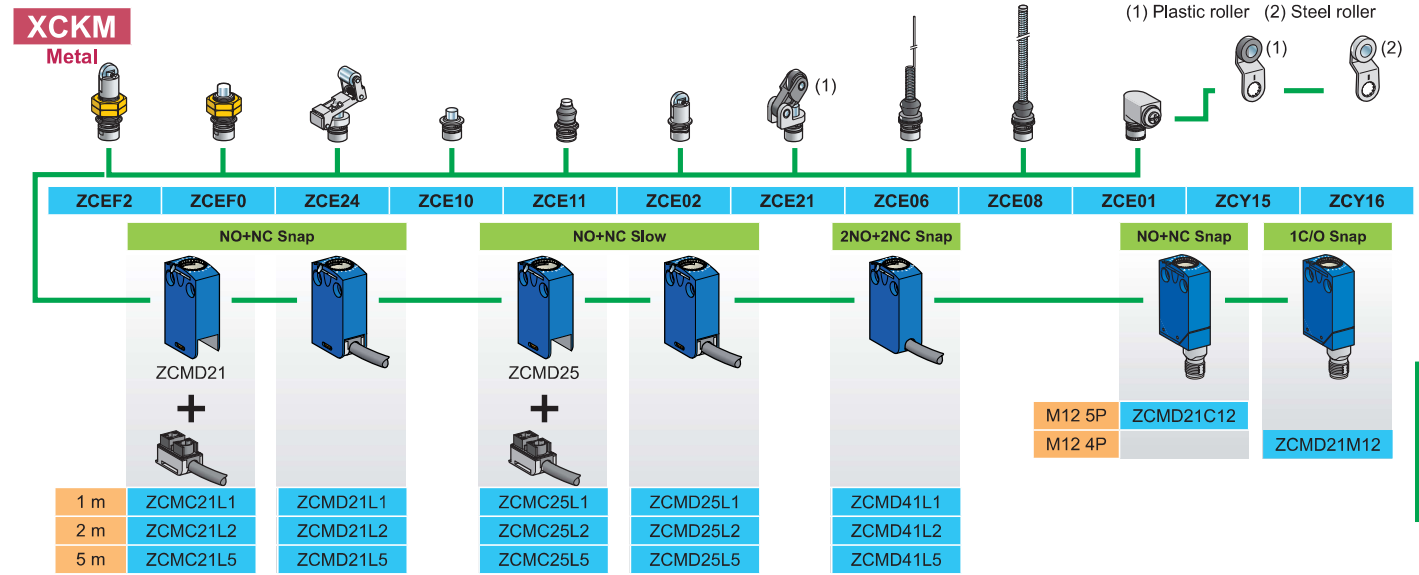
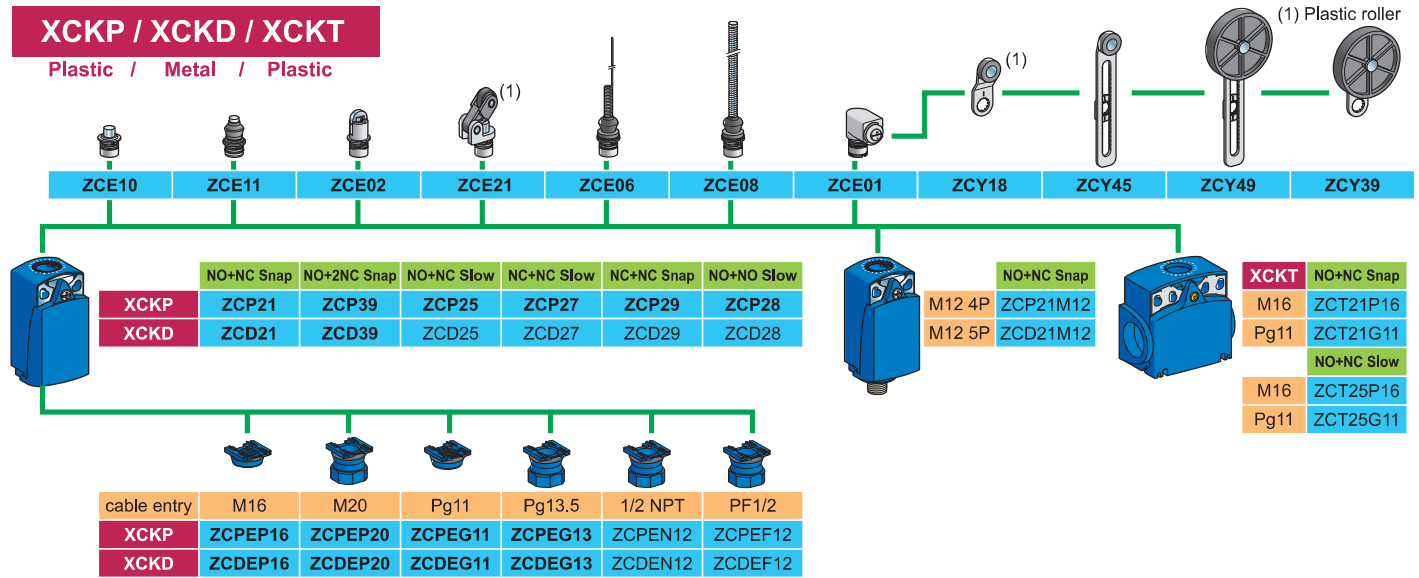

Inductives: OsiSense XS

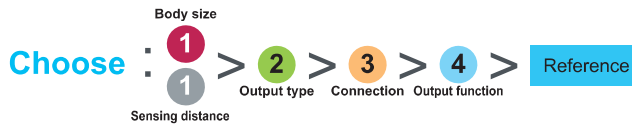

Sensing distance			M8				M12			
			1.5 mm		2.5 mm		2 mm		4 mm	
Flush mountable Short	DC3	PNP	cable	XS508B1P A L2	XS108B3P A L2	XS512B1P A L2	XS112B3P A L2			
			connector	XS508B1P A M8	XS108 B3P A M8	XS512B1P A M12	XS112B3P A M12			
	NPN	cable	XS508B1N A L2	XS108B3N A L2	XS512B1N A L2	XS112B3N A L2				
		connector	XS508B1N A M8	XS108B3N A M8	XS512B1N A M12	XS112B3N A M12				
DC2		cable	XS508BSC A L2	XS608B3C A L2	XS512BSD A L2	XS612B3D A L2				
		connector	XS508BSC A L01M12	XS608B3C A L01M12	XS512BSD A M12	XS612B3D A M12				
Long	DC3	PNP	cable	XS508BLP A L2	XS608B1P A L2	XS512BLP A L2	XS612B1P A L2			
			connector	XS508BLP A M12	XS608B1P A M12	XS512BLP A M12	XS612B1P A M12			
	NPN	cable	XS508BLN A L2	XS608B1N A L2	XS512BLN A L2	XS612B1N A L2				
		connector	XS508BLN A M12	XS608B1N A M12	XS512BLN A M12	XS612B1N A M12				
DC2		cable	XS508B1D A L2	XS608B1D A L2	XS512B1D A L2	XS612B1D A L2				
		connector	XS508B1D A M12	XS608B1D A M12	XS512B1D A M12	XS612B1D A M12				
AC/DC		cable			XS512B1M A L2	XS612B1M A L2				
		connector			XS512B1M A U20	XS612B1M A U20				
Output function		NO		A		A				
		NC		B		B				



Sensing distance			8x22x8 mm	15x32x8 mm	26x26x13 mm	40x40x15 mm	
			2.5 mm	5 mm	10 mm	15 mm	
Flush mountable 6	DC3	PNP	cable	XS7J1A1P A L2	XS7F1A1P A L2	XS7E1A1P A L2	XS7C1A1P A L2
			connector	XS7J1A1P A L01M8	XS7F1A1P A L01M8	XS7E1A1P A M8	XS7C1A1P A M8
	NPN	cable	XS7J1A1N A L2	XS7F1A1N A L2	XS7E1A1N A L2	XS7C1A1N A L2	
		connector	XS7J1A1N A L01M8	XS7F1A1N A L01M8	XS7E1A1N A M8	XS7C1A1N A M8	
DC2		cable	XS7J1A1D A L2	XS7F1A1D A L2	XS7E1A1D A L2	XS7C1A1D A L2	
		connector	XS7J1A1D A L01M8	XS7F1A1D A L01M8	XS7E1A1D A M8	XS7C1A1D A M8	

Sensing distance			26x26x13 mm		40x40x15 mm		
			15 mm		25 mm		
Flush adaptable mountable	DC3	PNP	cable	XS8E1A1P A L2	XS8C1A1P A L2		
			connector	XS8E1A1P A M8	XS8C1A1P A M8		
	NPN	cable	XS8E1A1N A L2	XS8C1A1N A L2			
		connector	XS8E1A1N A M8	XS8C1A1N A M8			
AC/DC		cable	XS8E1A1M A L2	XS8C1A1M A L2			
		connector	XS8E1A1M A L01U20	XS8C1A1M A L01U20			
Output function		NO		A		A	
		NC		B		B	



XS.....M8:
Connector M8 3 pin

Cabling XS

M8	PUR pre wired connectors (female)*	
	straight	elbowed
3 pin	YZCP0566L 2	YZCP0666L 2
2 m		

Inductives: OsiSense XS



			M18		M30		
			5 mm	8 mm	10 mm	15 mm	
Short 	DC3	PNP	cable	XS518B1P A L2	XS118B3P A L2	XS530B1P A L2	XS130B3P A L2
			connector	XS518B1P A M12	XS118B3P A M12	XS530B1P A M12	XS130B3P A M12
	NPN	cable	XS518B1N A L2	XS118B3N A L2	XS530B1N A L2	XS130B3N A L2	
		connector	XS518B1N A M12	XS118B3N A M12	XS530B1N A M12	XS130B3N A M12	
DC2		cable	XS518BSD A L2	XS618B3D A L2	XS530BSD A L2	XS630B3D A L2	
		connector	XS518BSD A M12	XS618B3D A M12	XS530BSD A M12	XS630B3D A M12	
Long 	DC3	PNP	cable	XS518BLP A L2	XS618B1P A L2	XS530BLP A L2	XS630B1P A L2
			connector	XS518BLP A M12	XS618B1P A M12	XS530BLP A M12	XS630B1P A M12
	NPN	cable	XS518BLN A L2	XS618B1N A L2	XS530BLN A L2	XS630B1N A L2	
		connector	XS518BLN A M12	XS618B1N A M12	XS530BLN A M12	XS630B1N A M12	
DC2		cable	XS518B1D A L2	XS618B1D A L2	XS530B1D A L2	XS630B1D A L2	
		connector	XS518B1D A M12	XS618B1D A M12	XS530B1D A M12	XS630B1D A M12	
AC/DC		cable	XS518B1M A L2	XS618B1M A L2	XS530B1M A L2	XS630B1M A L2	
		connector	XS518B1M A U20	XS618B1M A U20	XS530B1M A U20	XS630B1M A U20	
Output function		NO		A	A	A	A
		NC		B	B	B	B

Accessories

M8	XSZB108
M12	XSZB112
M18	XSZB118
M30	XSZB130

Screw terminal M20

Connector M12, 4 pin

			80x80x26 mm	Cubic	40x40x117 mm	Flush mountable	Non flush mountable
			40 mm			20 mm	40 mm
DC3	PNP	cable	XS7D1A1P A L2		NO+NC	XS8C2A1PCM12	XS8C2A4PCM12
		connector	XS7D1A1P A M12			XS8C2A1NCM12	XS8C2A4NCM12
	NPN	cable	XS7D1A1N A L2		NO	XS8C2A1DAM12	XS8C2A4DAM12
		connector	XS7D1A1N A M12		NO	XS8C2A1MAU20	XS8C2A4MAU20
DC2		cable	XS7D1A1D A L2		PNP	XS8C4A1PCP20	XS8C4A4PCP20
		connector	XS7D1A1D A M12		NPN	XS8C4A1NCP20	XS8C4A4NCP20
AC/DC		cable	XS7D1A1M A L2		NO or NC	XS8C4A1DPP20	XS8C4A4DPP20
		connector	XS7D1A1M A M12		NO or NC	XS8C4A1MPP20	XS8C4A4MPP20

DC3 24 V

DC4 24 V

Accessories

For 26x26 XSZBE00 XSZBE90

For 40x40 XSZBC00 XSZBC90

AC/DC 24...240 V DC2 24 V

Cabling XS

		PUR pre wired connectors (female)*					Connectors (female)	
M12		straight	elbowed	elbowed PNP LED	M12	straight	elbowed	
4 pin	2 m	YZCP1141L2	YZCP1241L2	YZCP1340L2	4 pin (1)	YZCC12FDM0B	YZCC12FCM0B	

Photo-electrics: OsiSense XU

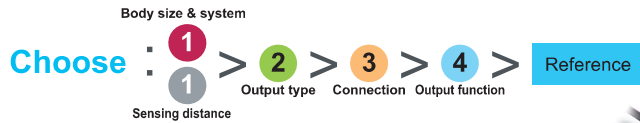

		Sensing distance			M18 metal		M18 plastic		Miniature					
	Diffuse	0.6 m	DC3	PNP	cable	XUB5BP A NL2	XUB5AP A NL2	1 m	XUM5AP C NL2					
					connector 4P	XUB5BP A NM12	XUB5AP A NM12		XUM5AP C NM8					
					NPN	cable	XUB5BN A NL2		XUB5AN A NL2	XUM5AN C NL2				
		connector 4P	XUB5BN A NM12	XUB5AN A NM12	XUM5AN C NM8									
		0.1 m	DC3	PNP	cable	XUB4BP A NL2	XUB4AP A NL2							
					connector 4P	XUB4BP A NM12	XUB4AP A NM12							
NPN	cable				XUB4BN A NL2	XUB4AN A NL2								
connector 4P	XUB4BN A NM12	XUB4AN A NM12												
	Polarized Reflex	2 m	DC3	PNP	cable	XUB9BP A NL2	XUB9AP A NL2	5 m	XUM9AP C NL2					
					connector 4P	XUB9BP A NM12	XUB9AP A NM12		XUM9AP C NM8					
					NPN	cable	XUB9BN A NL2		XUB9AN A NL2	XUM9AN C NL2				
				connector 4P	XUB9BN A NM12	XUB9AN A NM12	XUM9AN C NM8							
				Accessory: Reflector					XUZC50	XUZC50		XUZC50		
	Reflex	4 m	DC3	PNP	cable	XUB1BP A NL2	XUB1AP A NL2							
					connector 4P	XUB1BP A NM12	XUB1AP A NM12							
					NPN	cable	XUB1BN A NL2		XUB1AN A NL2					
				connector 4P	XUB1BN A NM12	XUB1AN A NM12								
				Accessory: Reflector					XUZC50	XUZC50				
	Thru-beam	15 m	DC3	PNP	cable	XUB2BP A NL2R	XUB2AP A NL2R	15 m	XUM2AP C NL2R					
					connector 4P	XUB2BP A NM12R	XUB2AP A NM12R		XUM2AP C NM8R					
					NPN	cable	XUB2BN A NL2R		XUB2AN A NL2R	XUM2AN C NL2R				
				connector 4P	XUB2BN A NM12R	XUB2AN A NM12R	XUM2AN C NM8R							
				Accessory: Transmitter					XUB2BKSNL2T	XUB2AKSNL2T		XUM2AK C NL2T		
									XUB2BKSNM12T	XUB2AKSNM12T		XUM2AK C NM8T		
				Output function					NO	A	A	NO or NC	C	
									NC	B	B			

6

		Sensing distance			M18 metal		M18 plastic		Miniature								
	Multimode	DC3	PNP	cable	XUB0BPSNL2	XUB0APSNL2	Background Sup: 0.12 m	Diffuse: 0.3 m	P: 3 m	TB: 10 m							
					connector 4P	XUB0BPSNM12					XUB0APSNM12	XUM0APSAL2					
					NPN	cable					XUB0BNSNL2	XUB0ANSNL2	XUM0APSAM8				
				connector 4P	XUB0BNSNM12	XUB0ANSNM12					XUM0ANSAL2						
				Accessory: Transmitter							XUB0BKSNL2T	XUB0AKSNL2T		XUM0AKSAL2T			
											XUB0BKSNM12T	XUB0AKSNM12T		XUM0AKSAM8T			

Reflectors

XUZC24 XUZC80 XUZC50 XUZC100

3D fixings with ball joint

Bracket with ball joint for sensors and reflector XUZC50

XUB	XUZB2003
XUM0	XUZM2003
XUK...	XUZK2003
XUX...	XUZX2003

Protective housing with ball joint

XUZK2004 XUZX2004

M12 rod for ball joint

XUZ2001

Fixing support for M12 rod

XUZ2003

Photo-electrics: OsiSense XU



		Sensing distance		Compact 50x50 mm				Compact 92x71 mm					
	Diffuse	1 m	DC3	PNP	cable	XUK5AP A NL2	2.1 m	DC3	PNP	terminals	XUX5AP A NT16		
					connector 4P	XUK5AP A NM12				connector 4P	XUX5AP A NM12		
				NPN	cable	XUK5AN A NL2			NPN	terminals	XUX5AN A NT16		
					connector 4P	XUK5AN A NM12				connector 4P	XUX5AN A NM12		
				AC/DC	Relay	cable			XUK5ARCNL2	AC/DC	Relay	terminals	XUX5ARCNT16
				Output function		NO			A		A		
		NC		B		B							
	Polarized Reflex	5 m	DC3	PNP	cable	XUK9AP A NL2	11 m	DC3	PNP	terminals	XUX9AP A NT16		
					connector 4P	XUK9AP A NM12				connector 4P	XUX9AP A NM12		
				NPN	cable	XUK9AN A NL2			NPN	terminals	XUX9AN A NT16		
					connector 4P	XUK9AN A NM12				connector 4P	XUX9AN A NM12		
				AC/DC	Relay	cable			XUK9ARCNL2	AC/DC	Relay	terminals	XUX9ARCNT16
				Accessory: Reflector		XUZC50			XUZC50				
	Reflex	7 m	DC3	PNP	cable	XUK1AP A NL2	14 m	DC3	PNP	terminals	XUX1AP A NT16		
					connector 4P	XUK1AP A NM12				connector 4P	XUX1AP A NM12		
				NPN	cable	XUK1AN A NL2			NPN	terminals	XUX1AN A NT16		
					connector 4P	XUK1AN A NM12				connector 4P	XUX1AN A NM12		
				AC/DC	Relay	cable			XUK1ARCNL2	AC/DC	Relay	terminals	XUX1ARCNT16
				Accessory: Reflector		XUZC50			XUZC50				
	Thru-beam	30 m	DC3	PNP	cable	XUK2AP A NL2R	40 m	DC3	PNP	terminals	XUX2AP A NT16R		
					connector 4P	XUK2AP A N M12R				connector 4P	XUX2AP A NM12R		
				NPN	cable	XUK2AN A NL2R			NPN	terminals	XUX2AN A NT16R		
					connector 4P	XUK2AN A NM12R				connector 4P	XUX2AN A NM12R		
				Accessory: Transmitter		cable			XUK2AKSNL2T	terminals	XUX0AKSAT16T		
						connector 4P			XUK2AKSNM12T	connector 4P	XUX0AKSAM12T		
AC/DC	Relay	cable	XUK2ARCNL2R	AC/DC	Relay	terminals	XUX2ARCNT16R						
		cable	XUK2ARCNL2T	terminals	XUX0ARCTT16T								

Multimode		DC3 PNP/NPN		cable		XUK0AKSAL2		DC3 PNP/NPN		terminals		XUX0AKSAT16			
	Background suppression (BGS) Diffuse (D) Polarised reflex (P) Thru-beam (TB)	AC/DC	Relay	cable	XUK0ARCTL2		AC/DC	Relay	terminals	XUX0ARCTT16					
					Background Suppression: 0.28 m					Diffuse: 0.8 m		Background Suppression: 1.3 m		Diffuse: 2 m	
					Polarized reflex: 4 m					Thru-beam: 30 m		Polarized reflex: 11 m		Thru-beam: 40 m	
Accessory: Transmitter		DC		cable	XUK0AKSAL2T		DC		terminals	XUX0AKSAT16T					
				connector 4P	XUK0AKSAM12T				connector 4P	XUX0AKSAM12T					
				AC/DC	cable	XUK0ARCTL2T			AC/DC	terminals	XUX0ARCTT16T				

Other fixings

	standard	with ball joint
XUB	XUZA118 (stainless steel)	XUZA218 (plastic)
XUM	XUZAM02	-
XUK	XUZA51	-
XUX	XUXZ2000	-

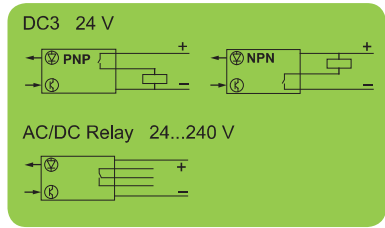

PUR pre wired connectors (female)*

Connectors (female)

Ultrasonic: OsiSense XX

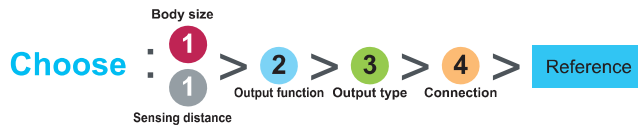

		M12		M18		M18 metal	M30		M30 stainless
Sensing distance		0.05 m	0.1 m	0.15 m	0.5 m Adjust.	0.05 m fixed	1 m Adjust.	8 m Adjust.	1 m Adjust.
Connectors/Cables		M8 4 pin	M8 3 pin	M12 4 pin	M12 4 pin	M12 4 pin	M12 4 pin	M12 4 pin	M12 4 pin
NO	DC4	PNP/NPN		XX512A1KAM8		XX518A1KAM12		XX630A1KAM12	
	DC3	PNP		XX512A2PAM8		XX518A3PAM12 (1)		XX630A3PAM12 (1)	
		NPN		XX512A2NAM8		XX518A3NAM12 (1)		XX630A3NAM12 (1)	
NO+NC	DC4	PNP				XX630A1PCM12		XX630A3PCM12	XX630S1PCM12
		NPN				XX630A1NCM12		XX630A3NCM12	XX630S1NCM12
Analogue	4...20 mA			XX918A3C2M12 (1)		XX930A3A2M12		XX930S1A2M12	
		0...10 V		XX918A3F1M12 (1)		XX930A3A1M12		XX930S1A1M12	

(1) Adjustable with XXZPB100

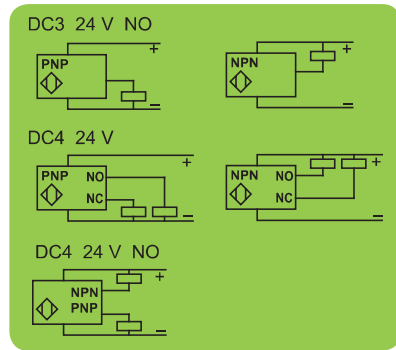

		Flat 7.6x19x33		Flat 16x30x74		Flat 60x30x18 + M18	
Sensing distance		0.1 m		0.25 m		0.5 m Adjust.	0.5 m Adjust.
Connectors		M12 4 pin		M12 4 pin		M12 4 pin	M12 4 pin
NO	DC3	PNP		XX7F1A2PAL01M12	XX7K1A2PAM12	XX7V1A1PAM12 (1)	
		NPN		XX7F1A2NAL01M12	XX7K1A2NAM12	XX7V1A1NAM12 (1)	
Analogue	4...20 mA					XX9V1A1C2M12 (1)	
		0...10 V				XX9V1A1F1M12 (1)	

(1) Adjustable with XXZPB100

XUZ 2001	M12	XUZB2012
XUZ 2003	M18	XUZB2003
	M30	XUZB2030

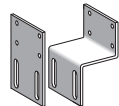

For XX7K	Flat	XXZ3074F
	Cranked	XXZ3074S

M12	XXZ12
M18	XUZA118
M30	XXZ30
XX7F	XXZ1933

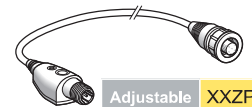

Adjustable XXZPB100

6

Forks: OsiSense XUV

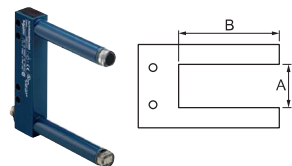

		A: 50 mm / B: 60 mm		A: 80 mm / B: 60 mm		A: 120 mm / B: 120 mm		A: 180 mm / B: 120 mm		
DC3	PNP	M8 3 pin	XUVR0605P	A NM8	XUVR0608P	A NM8	XUVR1212P	A NM8	XUVR1218P	A NM8
	NPN	M8 3 pin	XUVR0605N	A NM8	XUVR0608N	A NM8	XUVR1212N	A NM8	XUVR1218N	A NM8
Output function	NO			A		A		A		A
	NC			B		B		B		B

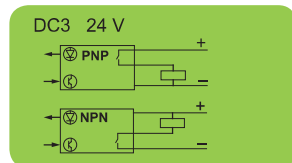

Cabling XX & XUV

		PUR pre wired connectors (female)*			Connectors (female)			
M8		straight	elbowed	elbowed PNP LED	M12	straight	elbowed	
3 pin	2 m	XZCP0566L2	XZCP0666L2		(1)	4 pin	XZCC12FDM40B	XZCC12FCM40B
	5 m	XZCP0566L5	XZCP0666L5		(2)	4 pin	XZCC12FDP40B	XZCC12FCP40B
	10 m	XZCP0566L10	XZCP0666L10		(1) Steel ring (2) Plastic ring			
4 pin	2 m	XZCP0941L2	XZCP1041L2					
	5 m	XZCP0941L5	XZCP1041L5					
	10 m	XZCP0941L10	XZCP1041L10					
M12	4 pin	XZCP1411L2	XZCP1411L5	XZCP1411L10				
	8 pin	XZCP1411L2	XZCP1411L5	XZCP1411L10				

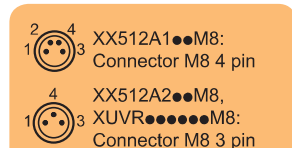

Connectors (male)





Schneider Electric Industries SAS

www.schneider-electric.com

Head Office
35, rue Joseph Monier
F-92500 Rueil-Malmaison
France

The information provided in this documentation contains general descriptions and/or technical characteristics of the performance of the products contained herein. This documentation is not intended as a substitute for and is not to be used for determining suitability or reliability of these products for specific user applications. It is the duty of any such user or integrator to perform the appropriate and complete risk analysis, evaluation and testing of the products with respect to the relevant specific application or use thereof. Neither Schneider Electric nor any of its affiliates or subsidiaries shall be responsible or liable for misuse of the information contained herein.

Design: Schneider Electric

ED2160802EN