

This is a sample photo.

ORDER SYMBOL: PCT 081206

EL.number **EAN:** 6418074003744

Sweden:
Denmark: 8212002636
Finland: 3423528

INCLUDING:

Enclosure body, cover with PUR gasket, cover screws, and mounting screws.

APPROVALS:

USA: UL Type 1, 4, 4X, 12, 13 (E75645 Vol.1 Sec.6); IK 08 (front) IK 07 (side) (IK-code EN50102); UL 94-V2

EURO: IP 67/IP 66; IK 08 (front) IK 07 (side) (IK-code EN50102); UL 94-V2

OTHERS: IEC 529, CE, EEI, FIMKO 189830-01

FIBOX EURONORM II PC

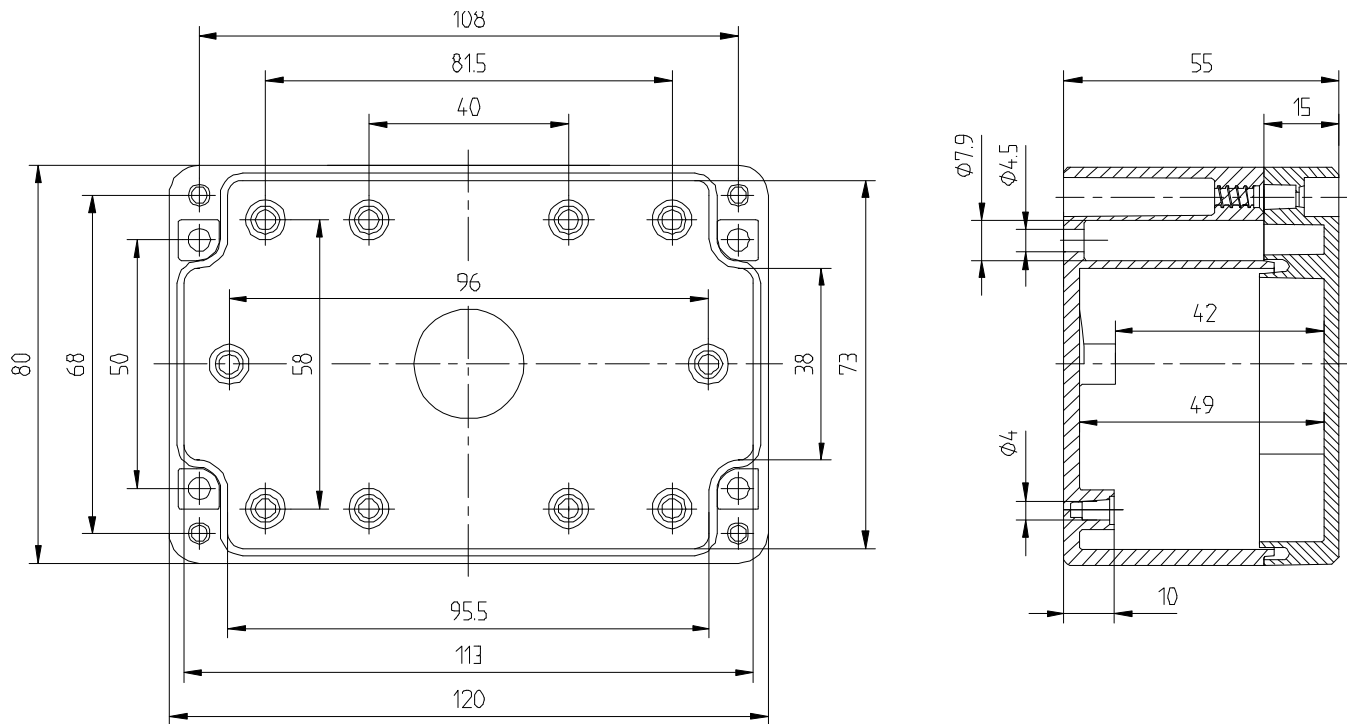

TECHNICAL INFORMATION:

Standard colour: RAL 7035
Ingress protection: IP 67 (IEC 529)
Flame resistance: UL 94-V2

Temp.range in cont. use: Max. +80 °C
Temp. range of material: - 40 °C - + 120 °C

ACCESSORIES

Fastening lug	TF 28037	DIN-Rail	TRM 0812
DIN-Rail	TRH 1212	DIN-Rail	TRM 0816
DIN-Rail	TRH 1216	DIN-Rail	TRM 1212
DIN-Rail	TRH 1220		
DIN-Rail	TRH 1520		
DIN-Rail	TRH 2330		
DIN-Rail	TRH 24		
DIN-Rail	TRM 0507		
DIN-Rail	TRM 0808		