

Mecmesin

testing to perfection

Compact Force Gauge⁺

Operating Manual



Contents

The Compact Force Gauge (CFG⁺)

Powering the Gauge	3
Using the Gauge	4
Basic Functions	6
RS232 Commands	11
CFG ⁺ Specifications	14
Dimensions	15

The Compact Force Gauge (CFG⁺)

Introduction

Thank you for choosing Mecmesin's Compact Force Gauge⁺ (CFG⁺). With correct use and regular re-calibration it will give many years of accurate and reliable service.

The CFG⁺ is the elementary member of a series of highly versatile display units. Specifically designed for performing basic tension and compression tests, the CFG⁺ can be used handheld or fixed to a manual or motorised test stand.

Before Use

Upon receiving the unit please check that no physical damage has occurred to the packaging material or the instrument itself. If any damage is evident please notify Mecmesin or your local distributor immediately.

Operation

The most commonly used features, such as displaying force, peak hold, zero and changing of displayed units of measurement can all be done by pressing a single dedicated key on the front panel - see page 6, Basic Functions.

Powering the Gauge

The CFG⁺ is supplied with a set of 4 x 1.5V AA batteries. To fit the batteries you must first remove the battery cover on the upper part of the rear of the gauge. To release the battery cover press the battery cover as indicated by the arrow and slide the cover upwards. Fit the batteries in the battery holder ensuring that you observe polarity. Incorrect insertion of batteries can cause damage to the gauge. To replace the battery cover slide it from the top edge of the gauge until it clicks into place.

If the gauge is not going to be used for 3 months or more the batteries should be removed and stored separately. (Settings and calibration data will not be lost if the batteries are removed).

Replacing batteries

Low battery symbol

If the low battery symbol appears on the display the gauge will power-off unconditionally at intervals of one minute. The gauge may be repowered but will power-off every one minute as long as the low battery symbol remains on the display.

This feature has been designed into the gauge to protect the integrity of displayed readings because when the low battery symbol appears the accuracy of the loadcell reading may be compromised.

When the low battery symbol appears on the display, fit four new 1.5V AA batteries in the gauge. **Rechargeable batteries should not be used in the CFG⁺.**

Mains operation

The CFG⁺ can also be powered directly from the mains using an AC Power Adaptor plugged into the right hand side of the gauge (available as an optional extra). Using an incorrect power adaptor can damage the gauge.

Powering up

Fig. 1

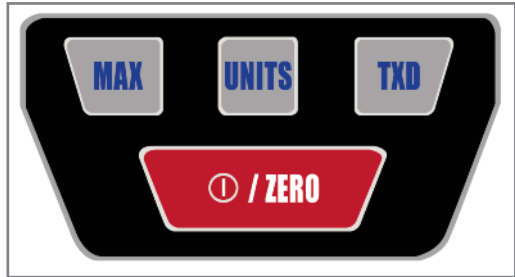

As shown in Fig. 1, the control panel has 4 keys. To power up the gauge press the red and white  key. A short self test will run during which the software version number, the currently selected baud rate and the loadcell capacity in newtons are shown. The gauge will then enter the main display mode.

After the self test, providing no load has been applied to the instrument, the display will show all zero's. This is because the gauge zero's itself during the self test routine.

If a compressive or tensile force is applied via the extension rod to the loadcell, the reading on the display will register the applied force if not in **MAX** Mode.

Turning off

To turn off the gauge press the  key for at least 2 seconds.

Basic Functions

Display of Tension/Compression

Tensile forces \blacklozenge are displayed on the CFG+ and recognised by the symbol (See Fig. 2).

Fig. 2

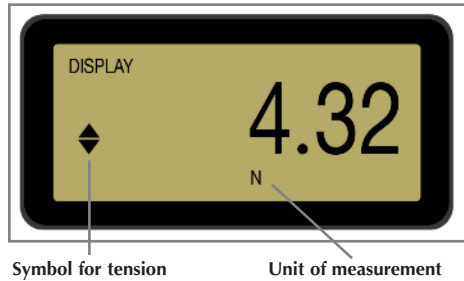

Compressive forces \blacktriangledown are displayed on the CFG+ and recognised by the symbol (See Fig. 3).

Fig. 3

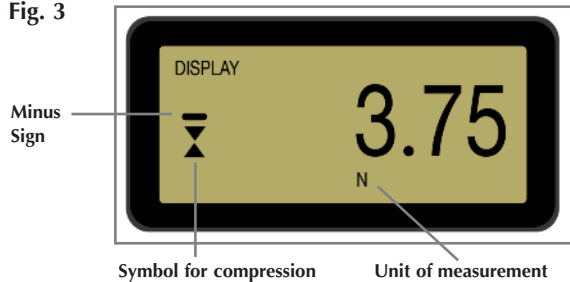

Zeroing the gauge

During the operation of the gauge it is often necessary to zero the display - e.g. when you wish to tare out the weight of an accessory that you do not want to become part of the measured reading. Press and release the **ZERO** key. When the gauge is in the process of zeroing itself a row of segments on the top and bottom of the display will be seen to alternately blink once. When this is completed the display will read zero. This function will not be performed if the gauge is in an overloaded state.

Changing the unit of measurement

Max (peak) readings

Peak capture rate is 500Hz

Max Tension

Max Compression

You can choose from the following units of measurement depending on the capacity of the gauge: newtons (N), kilogram-force (kg), millinewtons (mN), gram-force (g), ounce-force (oz), pound-force (lb) or kilonewtons (kN).

To change the display units press and release the **UNITS** key. Each successive key press will select the next available units until the gauge returns to its original setting. The CFG+ automatically converts readings as new units of measurement are selected.

The gauge detects and stores maximum (peak) force in both compressive and tensile directions.

Press the **MAX** key. The display will show the word **MAX** together with the highest tensile \blacklozenge force (See Fig. 4).

Fig. 4

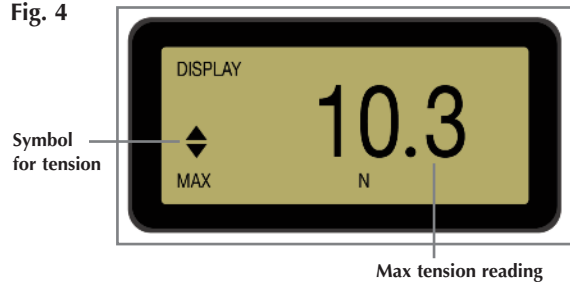

Press the **MAX** key. The display will show the word **MAX** together with the highest compressive \blacktriangledown force (See Fig. 5).

Fig. 5

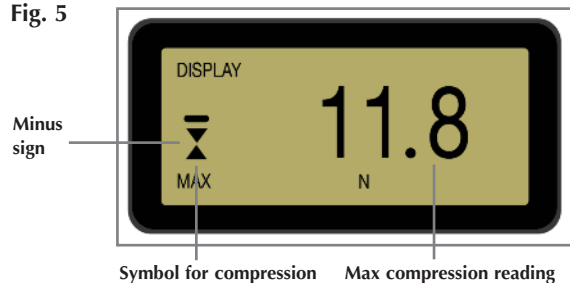

Data Output

CFG+ uses

9600 or 115200 Baud

8 data bits

1 start bit

1 stop bit

no parity

A data cable is available as an optional extra to connect your gauge to peripheral devices

The continuous data stream rate is 100Hz at 9600 Baud and 250Hz at 115200 Baud

Remote key press from PC

The CFG+ has RS232 output. It is possible to transmit the displayed reading to peripheral devices (e.g. PC, printer) by pressing and releasing the **TXD** key.

Displayed readings can also be requested individually from a PC via the RS232 interface by sending a "?" (ascii D63 [3fh]) character.

For sending a continuous data stream to a PC, press and hold the **TXD** key for 2 seconds and release. A '1' will now appear in the display to indicate that data can now be sent (See Fig. 6). To stop sending data, simply press and release the **TXD** key, at which point a '1' will disappear from the display.

Fig. 6

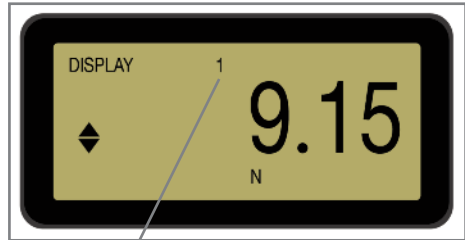

Symbol indicates data can be sent

Please note that the continuous data stream only starts when approximately 2% of the rated capacity of the gauge is reached.

Hold down the Ctrl key on the keyboard and press:

- a** to simulate pressing the **TXD** key*
- b** to simulate pressing the **UNITS** key
- c** to simulate pressing the **MAX** key
- e** to simulate pressing the **ZERO** key

* **Note** that the continuous transmission mode cannot be entered via this method.

See page 11 for full table.

Optional Settings through Dual Function keys

Baud Rate

Holding down the **TXD** key whilst turning on the gauge will toggle between baud rates of 9600 and 115200. If the baud rate is being toggled, when powered up the gauge will display either 9600 or 115.2 between displaying the software version number and the loadcell capacity. The baud rate setting will be stored in memory and remembered when the gauge is turned off.

Removing the minus sign during data transmission

Holding down the **MAX** key while turning the gauge on will enable or disable sending a minus sign with RS232 transmission. If the 'transmit sign' function is enabled then '2' is displayed in the top row of the display (See Fig. 7). This setting is stored in the memory and is remembered when the gauge is powered down.

Fig. 7

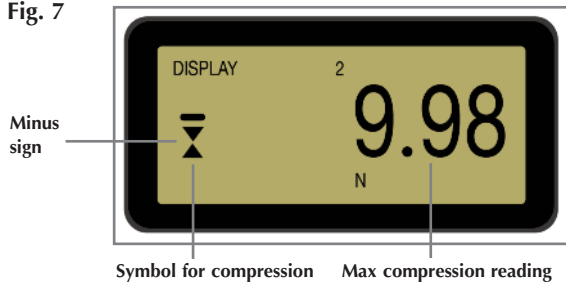

Auto-off

To conserve battery power the gauge constantly keeps a record of time elapsed since the last key press. If this function is not disabled and the low battery symbol is not showing, the gauge will power down after approximately five minutes has elapsed since the last key press, the last load change greater than 2% or the last recurrence of RS-232 communication.

If the gauge is being used for a long test the user may wish to disable the auto-off function. The auto-off function can be disabled when powering up the gauge by holding down the  until the display shows 'No Ao'.

Overload

An instrument showing an overload condition cannot be relied upon to provide accurate, repeatable measurement – consult your supplier.

Overload counters

Display messages

Do not overload the loadcell, as this can cause irreparable damage.

Forces greater than 120% of full-scale will show an '-OL-' symbol and the corresponding tension or compression symbols on the display. If the display shows 'OL' (without dashes) in either of the two max modes, the loadcell is not currently in overloaded state but has been overloaded at least once since the last **ZERO** operation.

If you suspect that the gauge has been subjected to overloading this can be verified by pressing the **UNITS** key while turning on the gauge. This will first display the number of overloads in tension, press **UNITS** key again to see the number of overloads in compression. Press **UNITS** key once more to allow the gauge to resume powering up.

Removing recorded overloads can only be undertaken by Mecmesin or an approved distributor.

Should the instrument have sustained a catastrophic overload the symbol 'OL' will be permanently displayed and the instrument must be returned to Mecmesin or an approved Mecmesin distributor for repair.

- '-OL-' Overload – More than 120% of full scale load is currently being applied to the transducer
- 'OL' Overload – The peak force reading was applied to the loadcell in excess of 120% of full-scale
- 't-ERR' Tare Error – The zero function was performed while the transducer was in an overloaded state
- 'No Ao' No Auto off – Automatic power-off is disabled
- 'C-DEF' Calibration default – Invalid calibration data; please notify Mecmesin or an authorised representative for calibration

RS232 Commands Table: Configuration

It is possible to remotely read/configure the settings of your CFG⁺ by sending the following RS232 command characters:

Character in ASCII	Decimal	Hexadecimal	Function
M	77	0x4D	Current mode
U	85	0x55	Current units
C	67	0x43	Loadcell capacity in newtons
?	63	0x3F	Transmit the current reading
@	64	0x40	Configuration Status Request
*	42	0x2A	Toggle Continuous Transmit Mode
r	114	0x72	Normal Screen (Non max)
t	116	0x74	Max Tension Screen
u	117	0x75	Max Compression Screen
a	97	0x61	Change Units to mN
b	98	0x62	Change Units to N
c	99	0x63	Change Units to kN
d	100	0x64	Change Units to gf
e	101	0x65	Change Units to kgf
f	102	0x66	Change Units to ozf
g	103	0x67	Change Units to lbf
CTRL a	1	0x01	Simulates the TXD key
CTRL b	2	0x02	Simulates the UNITS key
CTRL c	3	0x03	Simulates the MAX key
CTRL e	5	0x05	Simulates the ZERO key (to ZERO a load reading, not turn the gauge off)
CTRL o	15	0x0F	Turns the gauge off

RS232 Command Responses: Information

It is possible to remotely interrogate your CFG+ by sending the following RS232 commands. This will inform you which settings are currently configured.

Command: M

Response	CFG+ Display Mode
Normal	Normal Mode
MaxC	Max Compression
MaxT	Max Tension

Command: U

Response
mN
kN
N
gf
kgf
ozf
lbf

RS232 Command Responses: Information

Command: C

The loadcell size in N

Note: 'xxxx' will be transmitted if the loadcell is not calibrated, or has a serious fault. Contact Mecmesin or your supplier.

Command: @

You will receive the following information listing:

Response	Explanation of Response
Compact+	Gauge Type
50, 100, 200, 500 or 'xxxx' if the gauge is uncalibrated	Loadcell size in N
V01	Version number
Normal, MaxT or MaxC	Mode of operation
mN, kN, N, gf, kgf, ozf or lbf	Units of operation

CFG+ Specifications

Range & Resolution

Model no:	N	kgf	lbf
CFG+ 50	50 x 0.05	5 x 0.005	11 x 0.01
CFG+ 100	100 x 0.1	10 x 0.01	22 x 0.02
CFG+ 200	200 x 0.2	20 x 0.02	44 x 0.05
CFG+ 500	500 x 0.5	50 x 0.05	110 x 0.1

Accuracy

±0.5% of full-scale

Calibration temperature: 20°C ±2°C

Operating temperature: 10°C - 35°C

Temperature shift at zero load: ±0.09% of full-scale/°C

Output

RS232-C 9600 or 115200 Baud
8 data bits, 1 start bit, 1 stop bit, no parity

Optional Extras

AC Power Adaptor	A 6V - 9V AC-DC power adaptor (fitted with a 1.3mm DC power plug with +6V - +9V DC on the centre conductor), can be plugged into the right hand side of the gauge. Note: Using an incorrect power adaptor can damage the gauge.
CFG+ Mounting Plate	Enables the CFG+ to be mounted to a Mecmesin test stand.
Cable CFG+ to RS232	An interface cable for connecting your CFG+ to peripheral devices
Emperor™ Lite	Expand the functionality of the CFG+ with Emperor™ Lite data acquisition and plotting software. Analyse test results and view data in graphical format.

Consult your local distributor to buy any of the above items or please see the website: www.mecmesin.com

Dimensions (in Millimetres)

Front View

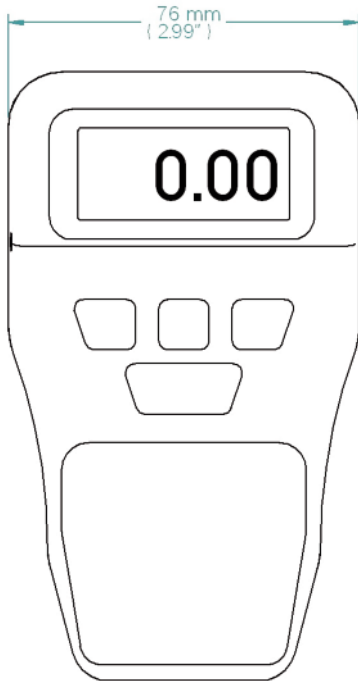

Rear View

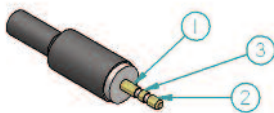
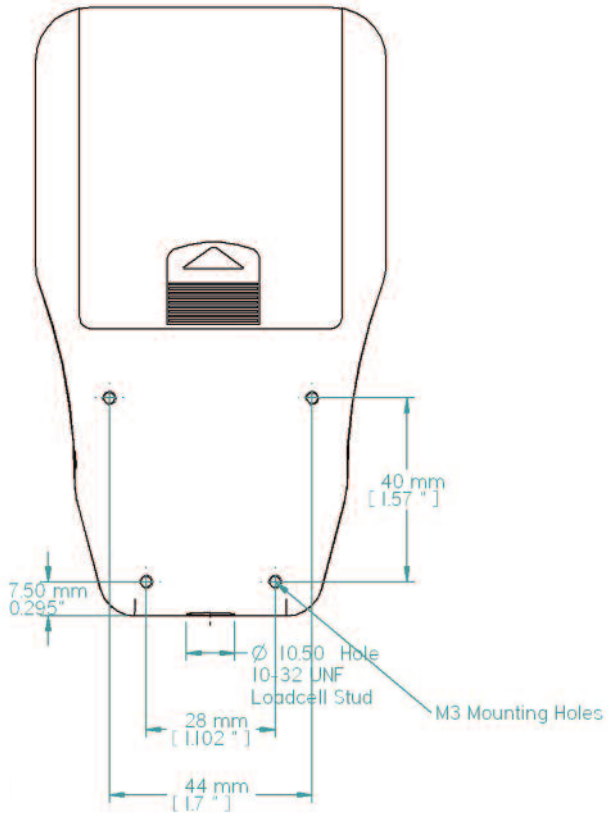

Pin Out:	
1	Ground
2	RS-232 Transmit
3	RS-232 Receive

Allocation for the pins on the 3-pin connector for RS-232 communication.

Dimensions (in Millimetres)

Side Views

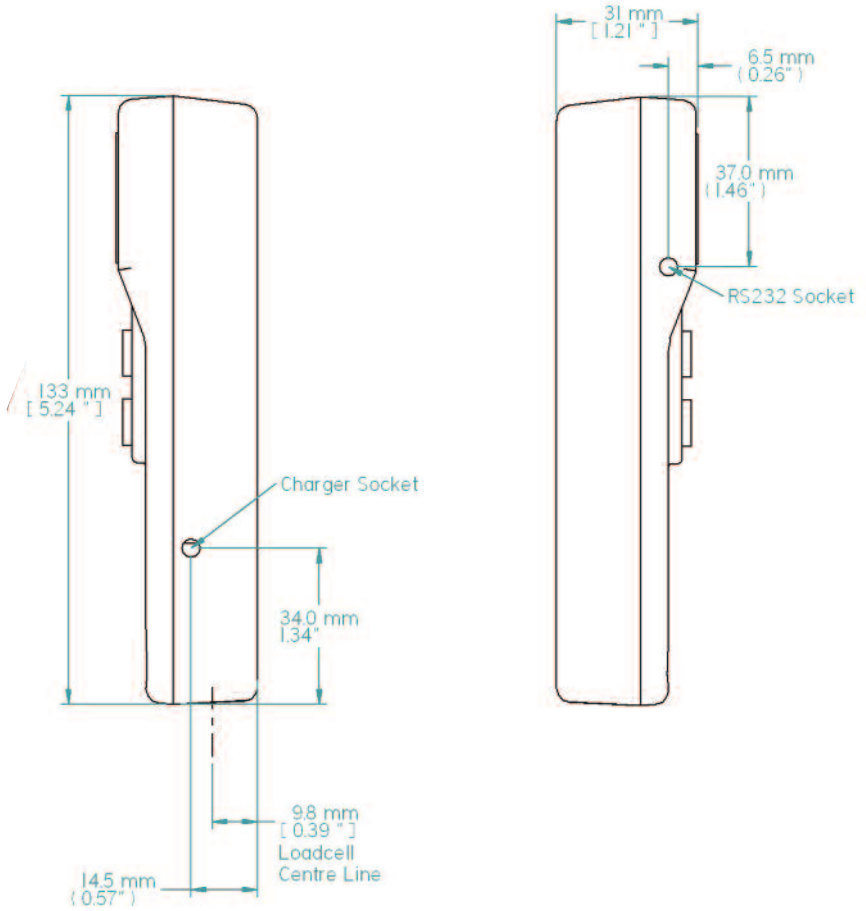

Also Available from Mecmesin...

MultiTest-d

The MultiTest-d systems are motorised test frames, which when combined with a force gauge and fixtures, are ideal for straight forward force testing applications. Features below:

- Cost-effective: affordable, suitable for businesses with limited resources
- User-friendly: easy-to-learn and operate even for infrequent users
- Precise: improved digital speed control
- Easy-to-read LCD screen: digital display of displacement speed
- Output capability: create load/displacement graphs
- Capacities: 2 capacities available - 1kN (220lbf) or 2.5kN (550lbf)
- Robust: rugged enough for the factory floor and sensitive enough for the laboratory



LCP/S

The LCP/S lever-operated test stand is ideal for testing on a repetitive basis up to 500N (110lbf) capacity. The MDD has 1000N (220lbf) capacity and handwheel operation to allow fine positional control of the crosshead.



- Easy-to-use
- Robust
- Lightweight
- Portable
- Economical for simple tests

Also Available from Mecmesin...

Emperor™ Lite

Emperor™ Lite is Mecmesin's powerful data-acquisition software, for use with its extensive range of force & torque measurement instruments. The software quickly and easily enables operators to perform in-depth analysis of measurements using a graphical trace of the test.

User-selectable calculations provide instant results for key test parameters, allowing you to gain valuable quantitative information about the test samples

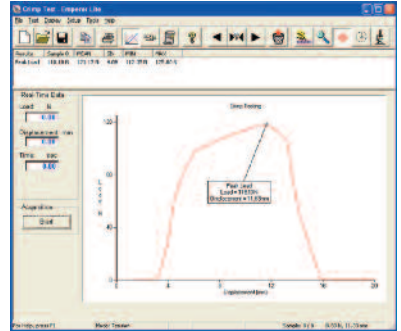

- Control: perform multiple calculations e.g. peak, minimum and average
- Visual: view test 'live' in real time on PC screen
- In-depth analysis: easily identify and label critical measurement values and pass/fail points during the test
- Flexible: summary test report with graphical traces

Orbis

The Orbis digital torque tester offers a simple, cost effective alternative to the Tornado. Featuring the same highly accurate digital torque capture, but without the Tornado's advanced programming functions, the Orbis is suitable for a broad range of basic torque applications.



- 6N.m
- Clear, intuitive controls
- Compact, portable & affordable
- Mains or battery powered

To find out about our broad range of grips and accessories, please call us on +44 (0) 1403 799979, or visit us at www.mecmesin.com.

Mecmesin

testing to perfection

Over 30 years experience in force & torque technology

Formed in 1977, Mecmesin Ltd is today widely regarded as a leader in force and torque technology for quality control testing in design and production. The Mecmesin brand stands for excellent levels of performance and reliability, guaranteeing high quality results. Quality control managers, designers and engineers working on production lines and in research laboratories worldwide rely upon Mecmesin force & torque measurement systems for a range of quality control testing applications, which is almost limitless.

Visit us on the web at
www.mecmesin.com

Head Office

Mecmesin Limited

Newton House,
Spring Copse Business Park,
Slinfold, West Sussex,
RH13 0SZ, United Kingdom.
e. sales@mecmesin.com
t. +44 (0) 1403 799979
f. +44 (0) 1403 799975

North America

Mecmesin Corporation

45921 Maries Road,
Suite 120, Sterling,
Virginia 20166, U.S.A.
e. info@mecmesincorp.com
t. +1 703 433 9247
f. +1 703 444 9860

Asia

Mecmesin Asia Co. Ltd

9/1 Chaiyo Building, 11th Floor,
Room 1106, Rama 9 Road, Huaykwang,
Bangkok, 10310, Thailand.
e. sales@mecmesinasia.com
t. +66 2 247 46 81
f. +66 2 247 46 82

China

Mecmesin (Shanghai) Pte Ltd

Room 302, No. 172,
Daxue Lu - University Avenue,
Yangpu District, Shanghai, 200433,
People's Republic of China.
e. sales@mecmesin-china.com
t. +86 21 5566 1037 / 3377 1733
f. +86 21 5566 1036



431-373-02

DISTRIBUTOR STAMP