

THIS IS A C.A.D. GENERATED DRAWING
DO NOT MAKE MANUAL REVISIONS TO MASTER.

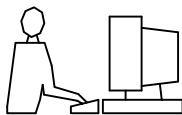

* UNLESS OTHERWISE SPECIFIED TOLERANCES
ON DECIMAL IS:

X.X
X.XX
X.XXX

ISSUE NUMBER

ORIGINAL ①

DIM 1.6 WAS 1.3 ②
R.STA.MONICA SEPT.24/2012

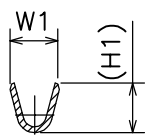
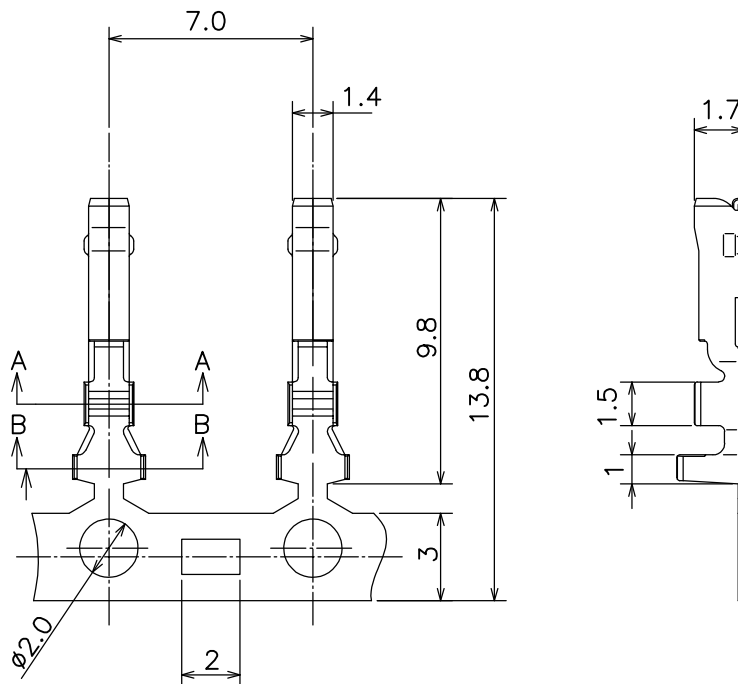

SECTION A-A

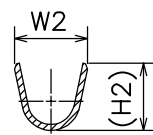

SECTION B-B

NOTES

MATERIAL: PHOSPHOR BRONZE
0.2mm THICK
TIN PLATED ALL OVER

PART NO	W1	H1	W2	H2	WIRE RANGE	INSULATION DIA
565-290-721	1.7	1.7	2.6	2.4	AWG # 22~28	MAXIMUM ϕ 1.6
565-290-741	1.9	1.9	3.0	2.7	AWG # 20~22	MAXIMUM ϕ 1.7

②

SOCKET CONTACT

ACAD REFERENCE NO. 565-290-721 & 741

DRAWN: N.SONDH

DATE: SEP 10/12

CHECKED:

DATE:

SCALE: (IN C.A.D.1:1)

SHEET 1 OF 3

DRAWING NUMBER

565-290-721 & 741

ISSUE

2



EDAC INC
TORONTO, ONTARIO
CANADA

YOUR CONNECTION TO QUALITY & SERVICE

THESE DRAWINGS AND SPECIFICATIONS
ARE THE PROPERTY OF EDAC INC., AND
SHALL NOT BE REPRODUCED, OR COPIED
OR USED AS THE BASIS FOR THE
MANUFACTURE OR SALE OF APPARATUS
WITHOUT WRITTEN PERMISSION.

THIS IS A C.A.D. GENERATED DRAWING
DO NOT MAKE MANUAL REVISIONS TO MASTER.

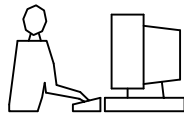

* UNLESS OTHERWISE SPECIFIED TOLERANCES
ON DECIMAL IS:

X.X
X.XX
X.XXX

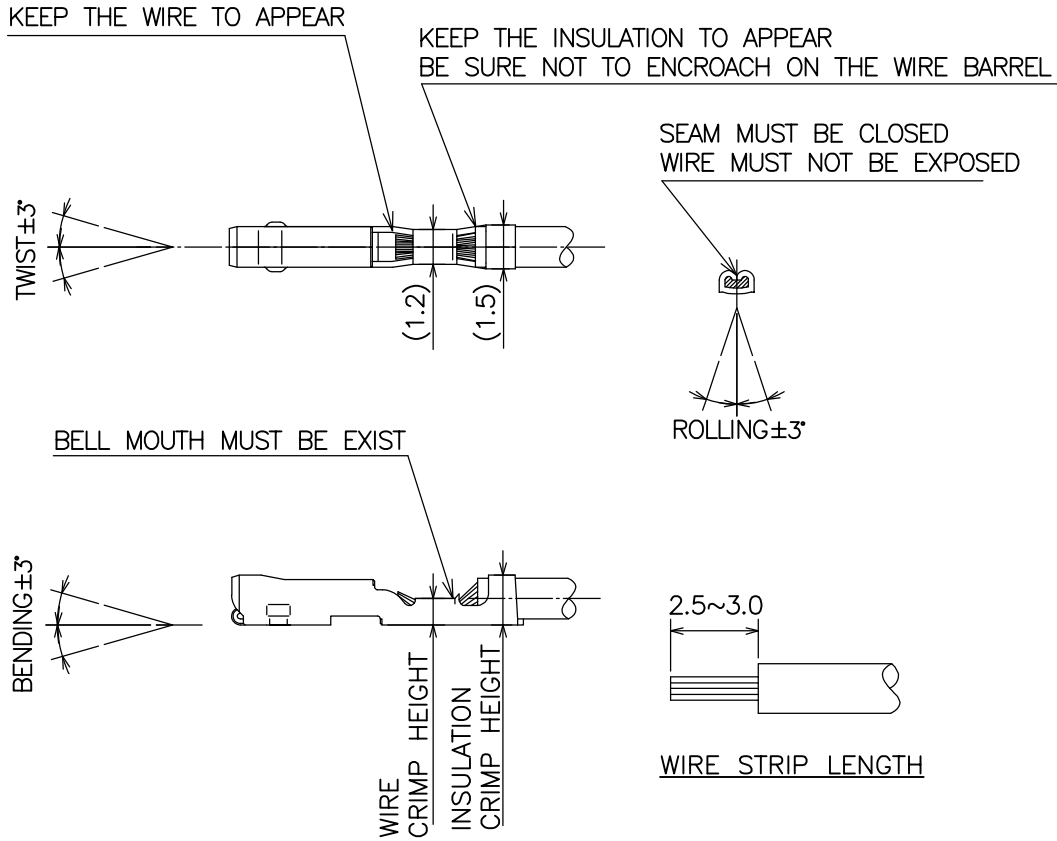

WIRE CRIMP INFORMATION FOR 565-290-721 CONTACT
WITH INSULATION DIA 1.0mm TO 1.3mm
(565-290-721 CONTACT TO BE CRIMPED WITH TOOL# 565-280-210)

WIRE SIZE	INSULATION DIA	WIRE CRIMP HEIGHT	INSULATION CRIMP HEIGHT	CRIMP STRENGTH
AWG # 22	-----	0.80±0.03	1.7 MAX	49.0 N(5.0Kgf)MIN
AWG # 24	-----	0.75±0.03	1.7 MAX	29.4 N(3.0Kgf)MIN
AWG # 26	-----	0.67±0.03	1.7 MAX	19.6 N(2.0Kgf)MIN
AWG # 28	-----	0.63±0.03	1.7 MAX	9.8 N(1.0Kgf)MIN

SOCKET CONTACT

WIRE CRIMP INFORMATION

ACAD REFERENCE NO. 565-290-721 & 741

DRAWN: N.SONDH

DATE: SEP 10/12

CHECKED:

DATE:

SCALE: (IN C.A.D.1:1)

SHEET 2 OF 3

DRAWING NUMBER

ISSUE

565-290-721 & 741

2



EDAC INC
TORONTO, ONTARIO
CANADA

YOUR CONNECTION TO QUALITY & SERVICE

THESE DRAWINGS AND SPECIFICATIONS
ARE THE PROPERTY OF EDAC INC., AND
SHALL NOT BE REPRODUCED, OR COPIED
OR USED AS THE BASIS FOR THE
MANUFACTURE OR SALE OF APPARATUS
WITHOUT WRITTEN PERMISSION.

THIS IS A C.A.D. GENERATED DRAWING
DO NOT MAKE MANUAL REVISIONS TO MASTER.

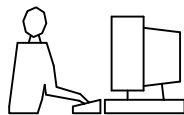

* UNLESS OTHERWISE SPECIFIED TOLERANCES
ON DECIMAL IS:

X.X
X.XX
X.XXX

KEEP THE WIRE TO APPEAR

KEEP THE INSULATION TO APPEAR
BE SURE NOT TO ENCROACH ON THE WIRE BARREL

SEAM MUST BE CLOSED
WIRE MUST NOT BE EXPOSED

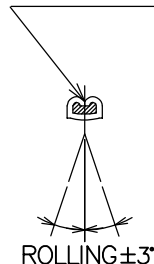
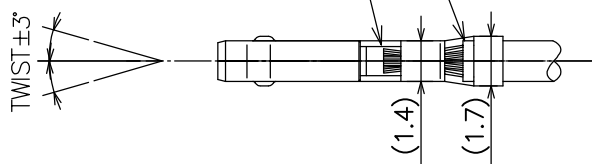

BELL MOUTH MUST BE EXIST

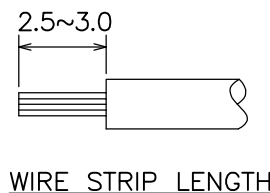
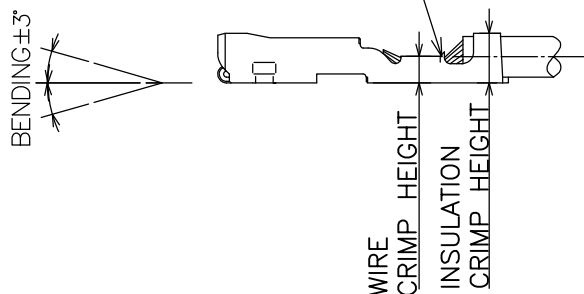

WIRE CRIMP INFORMATION FOR 565-290-741 CONTACT
WITH INSULATION DIA 1.3mm TO 1.7mm
(565-290-741 CONTACT TO BE CRIMPED WITH TOOL# 565-280-211)

WIRE SIZE	INSULATION DIA	WIRE CRIMP HEIGHT	INSULATION CRIMP HEIGHT	CRIMP STRENGTH
AWG # 20	-----	0.87±0.03	1.8 MAX	68.6 N(7.0Kgf)MIN
AWG # 22	-----	0.81±0.03	1.8 MAX	49.0 N(5.0Kgf)MIN

SOCKET CONTACT

WIRE CRIMP INFORMATION

ACAD REFERENCE NO. 565-290-721 & 741

DRAWN: N.SONDH

DATE: SEP 10/12

CHECKED:

DATE:

SCALE: (IN C.A.D.1:1)

SHEET 3 OF 3

DRAWING NUMBER

ISSUE

565-290-721 & 741

2



EDAC INC
TORONTO, ONTARIO
CANADA

YOUR CONNECTION TO QUALITY & SERVICE

THESE DRAWINGS AND SPECIFICATIONS
ARE THE PROPERTY OF EDAC INC., AND
SHALL NOT BE REPRODUCED, OR COPIED
OR USED AS THE BASIS FOR THE
MANUFACTURE OR SALE OF APPARATUS
WITHOUT WRITTEN PERMISSION.