

Operating Instructions

Indication and adjustment module PLICSCOM



Contents

1	About this document	4
1.1	Function	4
1.2	Target group	4
1.3	Symbolism used	4
2	For your safety	6
2.1	Authorised personnel	6
2.2	Appropriate use	6
2.3	Warning about misuse	6
2.4	General safety instructions	6
2.5	CE-conformity	7
2.6	Safety instructions for Ex areas	7
2.7	Environmental instructions	7
3	Product description	8
3.1	Configuration	8
3.2	Principle of operation	9
3.3	Adjustment	9
3.4	Storage and transport	9
4	Mounting	10
4.1	Mounting procedure	10

5 Set-up	11
5.1 Adjustment system	11
5.2 Menu schematic	12
5.3 General functions	16
5.4 Special functions, 4 ... 20 mA/HART®	25
5.5 Special functions, Profibus PA	27
6 Dismounting	32
6.1 Dismounting procedure	32
6.2 Disposal	32
Supplement	33
Technical data	33
Dimensions	34

1 About this document

1.1 Function

This operating instructions manual has all the information you need for quick set-up and safe operation of PLICSCOM. Please read this manual before you start set-up.

1.2 Target group

This operating instructions manual is directed to trained personnel. The contents of this manual should be made available to these personnel and put into practice by them.

1.3 Symbolism used



Information, tip, note

This symbol indicates helpful additional information.



Caution

This symbol informs you of a dangerous situation that could occur. Ignoring this cautionary note can impair the person and/or the instrument.



Ex applications

This symbol indicates special instructions for Ex applications.

- **List**
The dot set in front indicates a list with no implied sequence.

- > **Action**
This arrow indicates a single action.

- 1 **Sequence**
Numbers set in front indicate successive steps in a procedure.

2 For your safety

2.1 Authorised personnel

All operations described in this operating instructions manual must be carried out only by trained and authorised specialist personnel. For safety and warranty reasons, any internal work on the instruments must be carried out only by VEGA personnel.

2.2 Appropriate use

PLICSCOM is a pluggable indication and adjustment module for VEGA level and pressure sensors.

2.3 Warning about misuse



Inappropriate or incorrect use of the instrument can give rise to application-specific hazards, e.g. vessel overfill or damage to system components through incorrect mounting or adjustment.

2.4 General safety instructions

PLICSCOM is a high-tech instrument requiring the strict observance of standard regulations and guidelines. The user must take note of the safety instructions in this manual, the country-specific installation standards (e.g. the VDE regulations in Germany) as well as prevailing safety regulations and accident prevention rules.

2.5 CE-conformity

PLICSCOM is in CE conformity with EMC (89/336/EWG) and NSR (73/23/EWG).

The conformity has been evaluated acc. to the following standards:

- EMC
 - Emission EN 61326: 1997
 - Susceptibility EN 61326: 1997 + A1: 1998
- NSR EN 61010: 2001.

2.6 Safety instructions for Ex areas



In Ex applications, please observe the Ex specific safety instructions. These are part of the operating instructions manual of the respective instrument and are delivered with every instrument with Ex approval.

2.7 Environmental instructions

Protection of the environment is one of our most important duties. That is why we have introduced an environment management system with the goal of continuously improving company environmental protection. The environment management system is certified acc. to DIN EN ISO 14001.

Please help us fulfil this obligation by observing the environmental instructions in this manual:

- Chapter 3.4 „Storage and transport“
- Chapter 6.2 „Disposal“.

3 Product description

3.1 Configuration

Scope of delivery

The scope of delivery encompasses:

- indication and adjustment module PLICSCOM
- documentation
 - this operating instructions manual
- optional: cover with inspection glass.

Components

PLICSCOM is provided with a display with full dot matrix and four buttons for adjustment purposes.

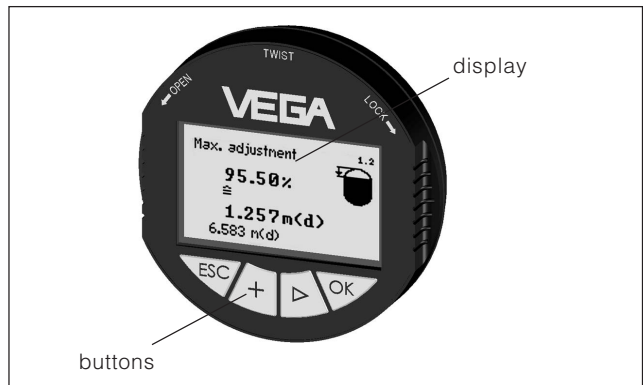

Fig. 1:
Indication and adjustment module PLICSCOM

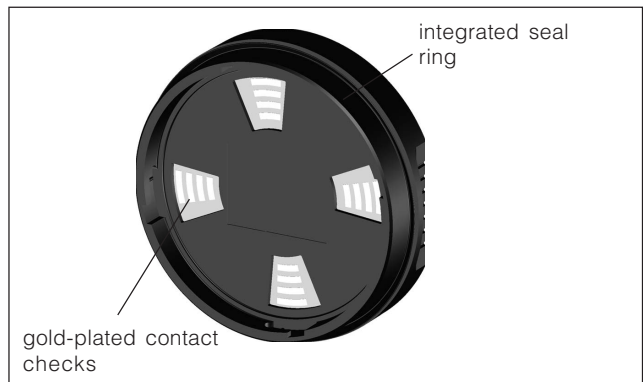

Fig. 2:
Back side of the indication and adjustment module PLICSCOM

3.2 Principle of operation

Area of application

The indication and adjustment module PLICSCOM is designed for indication of measured values, adjustment and diagnosis for VEGAPULS series 60, VEGAFLEX series 60 and VEGABAR series 50 and 60. It is installed in the sensor housing or in the external indication and adjustment unit VEGADIS 61.

The operation of two PLICSCOMs in parallel is not supported.

After installation, the sensor and PLICSCOM are splash-proof even without the housing cover.

Power supply

The power supply is provided by the sensor or VEGADIS 61. An additional connection is not necessary.

3.3 Adjustment

The adjustment is carried out via the integrated buttons.

3.4 Storage and transport

Packaging

Your instrument was protected by packaging during transport. Its capacity to handle normal loads during transport is assured by a test acc. to DIN 55439.

The packaging consists of environment-friendly, recyclable cardboard. Dispose of the packing material via specialised recycling companies.

Storage and transport temperature

- Storage and transport temperature -40 ... +80°C
- Relative humidity 20 ... 85 %.

4 Mounting

4.1 Mounting procedure

Insert/remove PLICSCOM

PLICSCOM can be inserted or removed at any time. An interruption of the power supply is not necessary.



To install, proceed as follows:

- 1 Unscrew housing cover
- 2 Place PLICSCOM in the desired position on the electronics (you can choose any one of four different positions - each displaced by 90°)

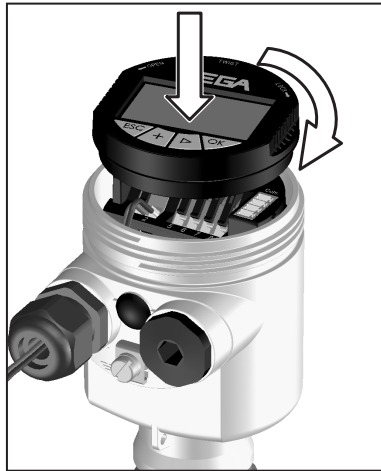

Fig. 3:
Insertion of PLICSCOM

- 3 Press PLICSCOM lightly onto the electronics and turn it to the right until it snaps in
- 4 Screw the housing cover with inspection glass tightly back on



The housing cover without inspection window cannot be screwed on if PLICSCOM is installed.

Removal is carried out in reverse order.

5 Set-up

5.1 Adjustment system

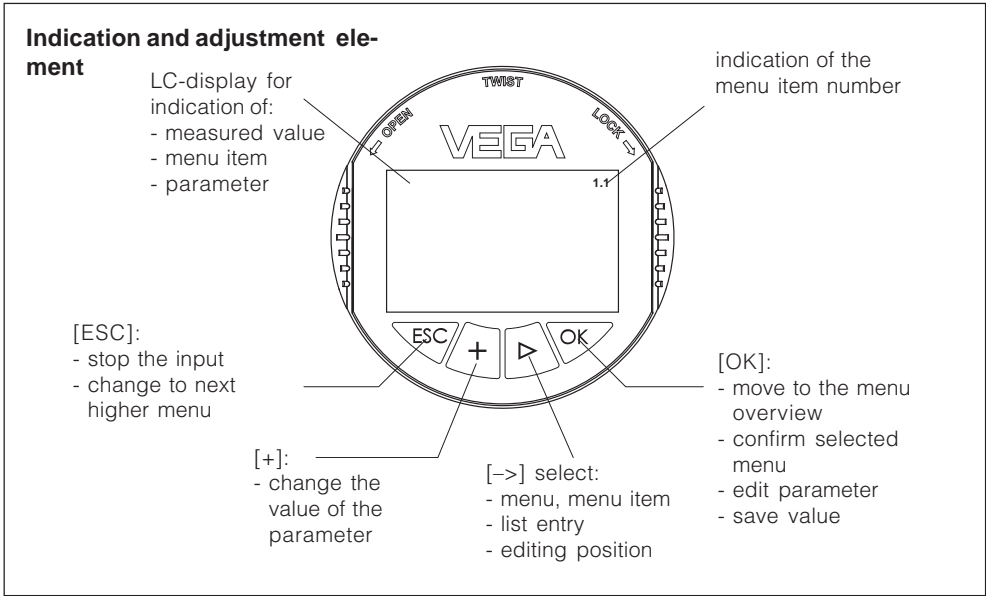

Adjustment system

The sensor is adjusted via the four keys of the indicating and adjustment module PLICSCOM. The LC display indicates the individual menu items. The functions are shown in the above illustration. Approx. 10 minutes after the last pressing of a key, an automatic reset to measured value display is triggered. Any values not confirmed with [OK] are not saved.

5.2 Menu schematic

Example of a 4 ... 20 mA/HART® instrument

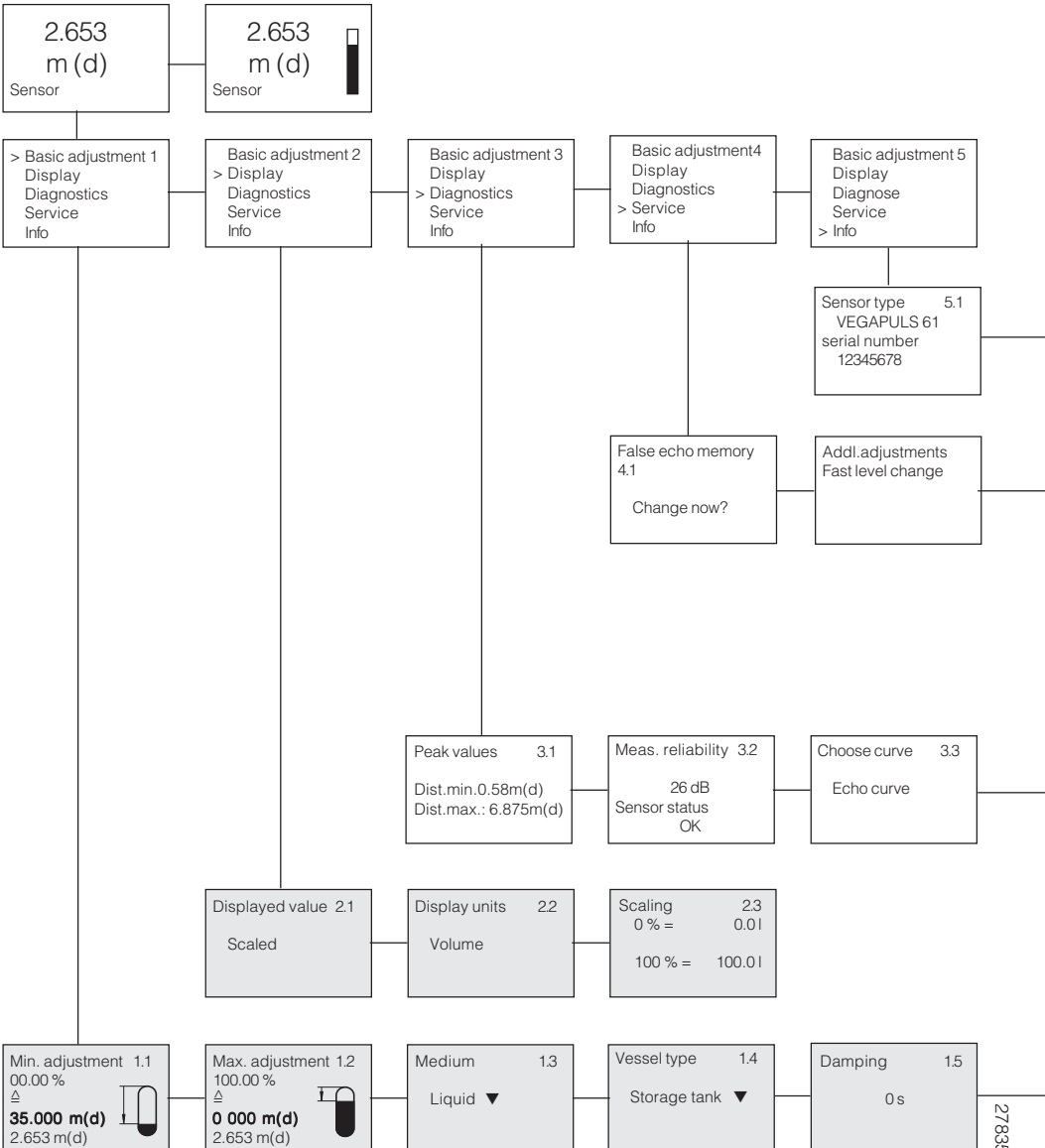

▼ Selection in menu item

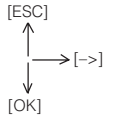

With these keys you move in the menu field

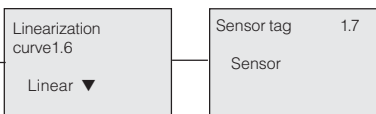
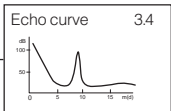
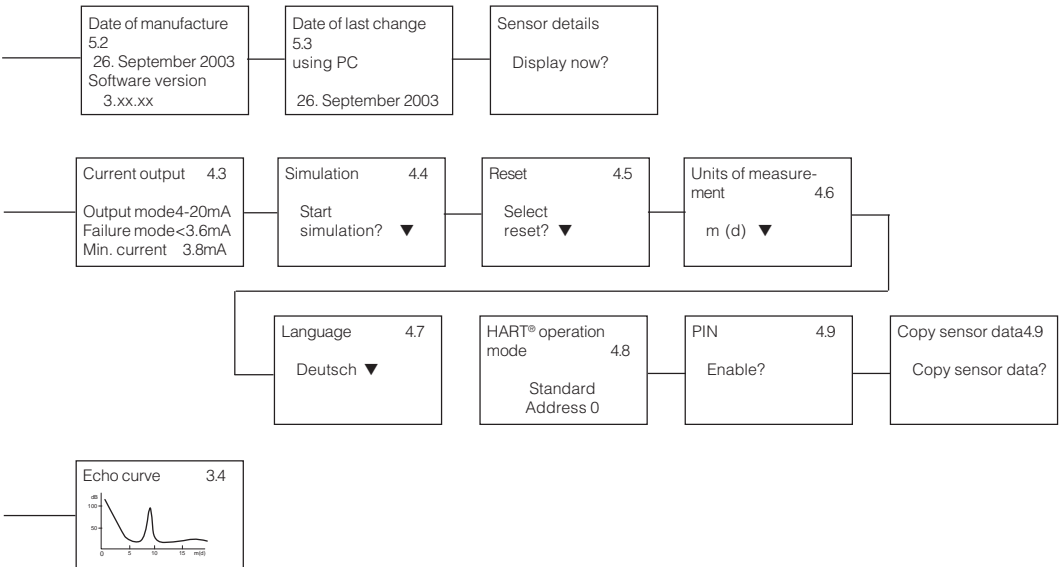

- This example refers to the VEGAPULS 61. You will find the instrument-specific menu schematic in the operating instructions manual of the respective instrument.
- The parameters in the menu items (highlighted in grey) are reset to default values with the reset function

Example of a Profibus PA instrument

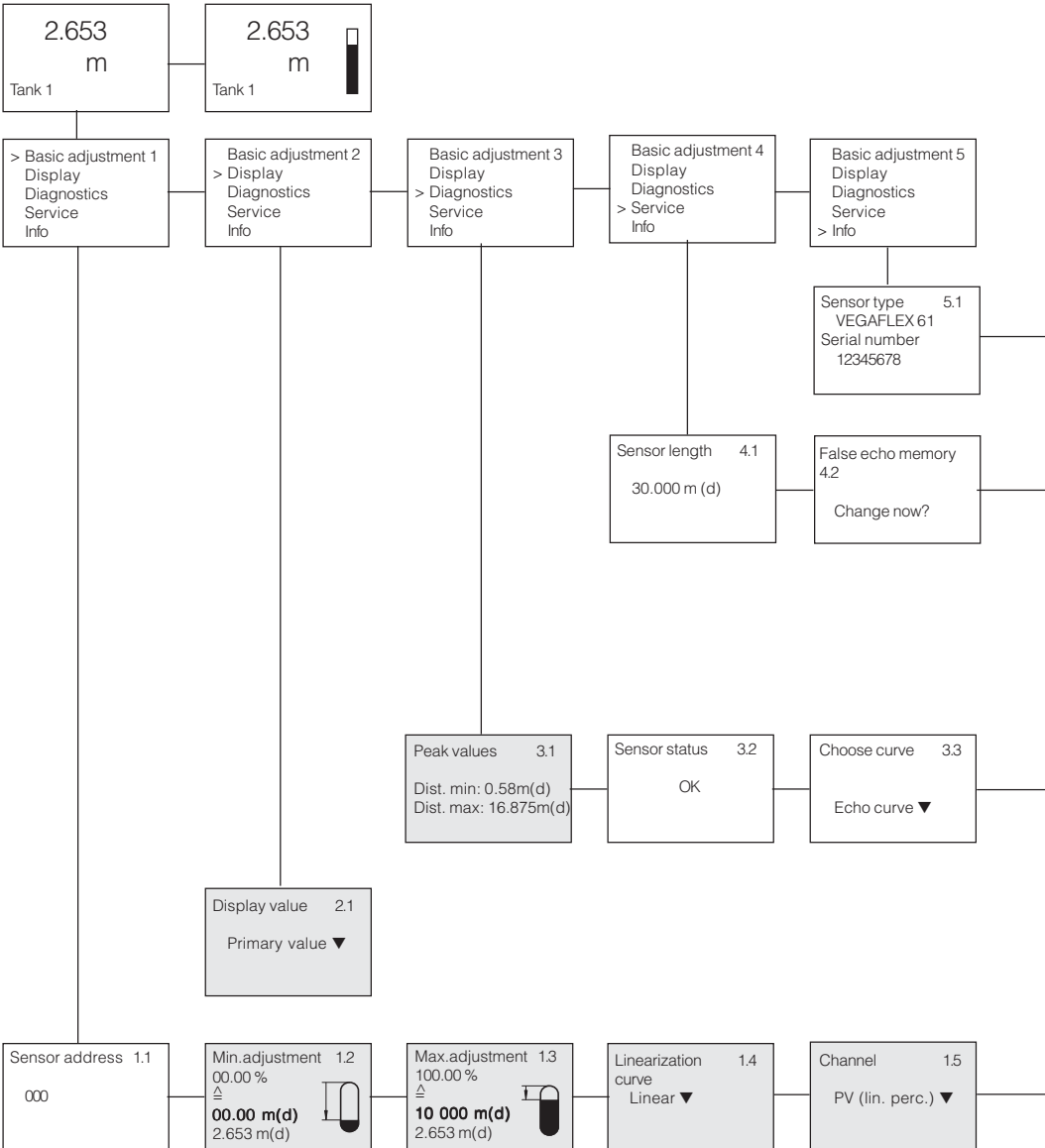

▼ Selection in menu item

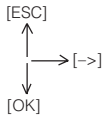

With these keys you move in the menu field

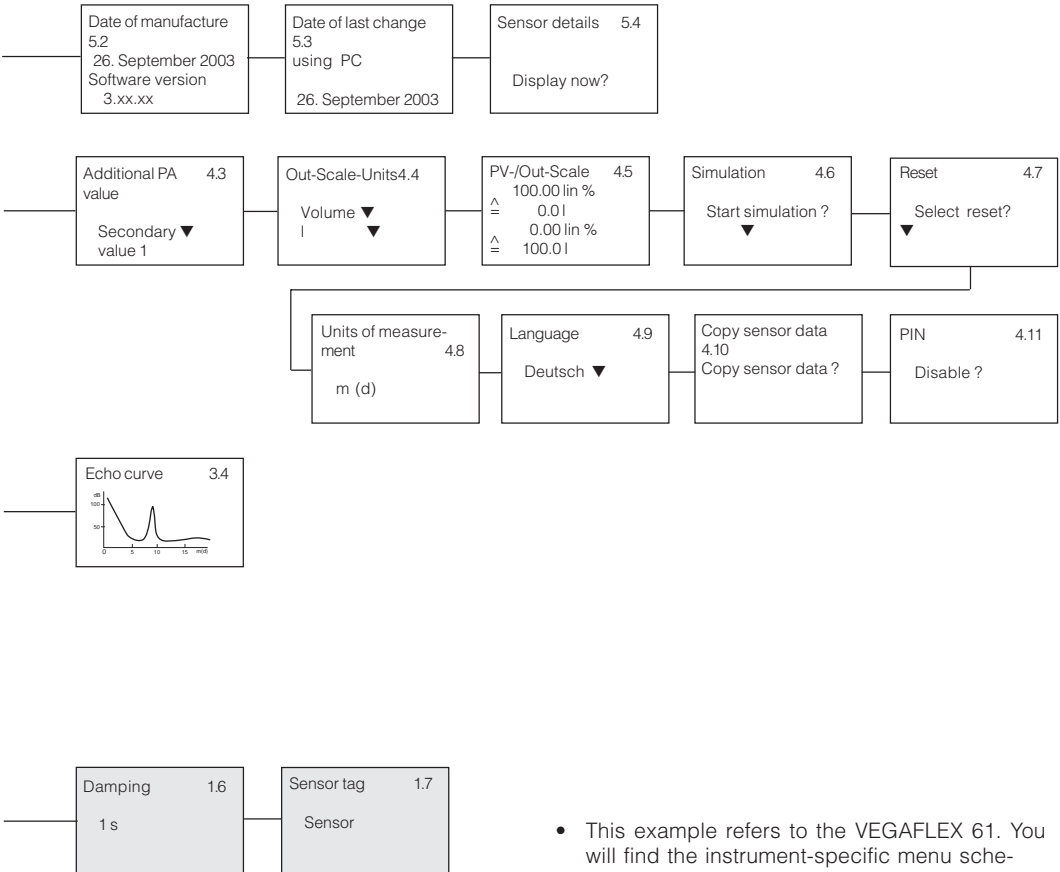

- This example refers to the VEGAFLEX 61. You will find the instrument-specific menu schematic in the operating instructions manual of the respective instrument.
- The parameters in the menu items (highlighted in grey) are reset to default values with the reset function

5.3 General functions

In the operating instructions manual of each instrument you will find the most important steps for quick set-up as well as a description of all sensor-specific functions.

The general functions are described in this section. The scope of the functions of PLICSCOM is determined by the sensor and corresponds to the actual software version of the sensor.



The menu item number will differ depending on the instrument type and signal output.

Measured value display

In the measured value display you can select different presentations of the measured value with [->]. From each of these presentations you reach the menu overview with [OK]. With [ESC] you move from the menu overview to the measured value presentation.

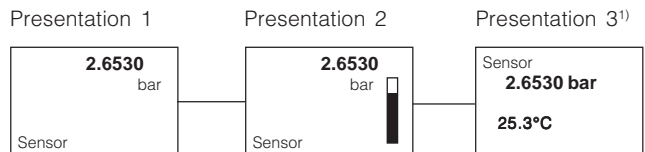

Indication of:

- level/pressure as digital value
- sensor tag
- level/pressure as digital value and analogue
- sensor tag
- sensor tag
- level/pressure as digital value
- temperature value

Menu overview

In the menu overview you select the requested menu with [->] and open it with [OK]. The individual menu items are then at your disposal.

```
> Basic adjustment 1
  Display
  Diagnostics
  Service
  Info
```

¹⁾ Only with VEGABAR.

Damping

To damp pressure shocks and level fluctuations, you can set in this menu item an integration time of 0 ... 999 s.

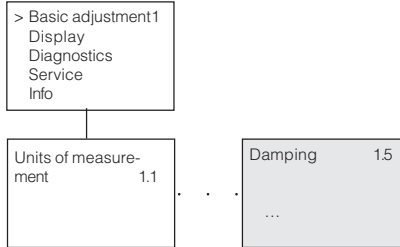

Linearisation curve

In this menu item you select the linearisation curve:

- linear
- cylindrical tank
- spherical tank
- user programmable.

User programmable means:

Switching on a linearisation curve created by the PC and PACTware™.

The linearisation curve establishes a correlation between height and volume. It takes the vessel geometry into account to provide correct measured value display and current output.

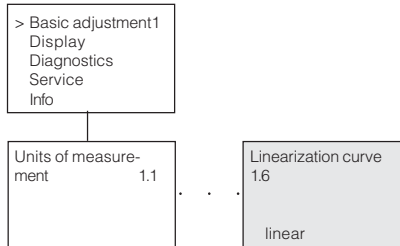

Edit sensor-TAG

In the menu item “Sensor-TAG” you can edit a twelve digit measurement loop name. The list of characters includes:

- letters A ... Z
- numbers 0 ... 9
- special characters , +, -, /, -.

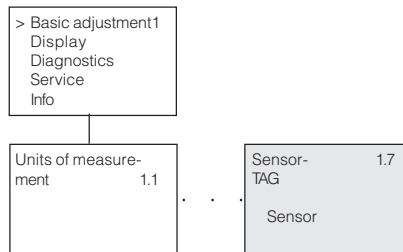

Peak values

Min. and max. measured values are stored in the sensor. The values are displayed in the menu item “Peak values“.

- Min. and max. distance in m (d): VEGAPULS, VEGASON, VEGAFLEX
- Min. and max. pressure: VEGABAR ¹⁾
- Min. and max. temperature: VEGABAR and VEGASON

Measuring accuracy

With VEGAPULS and VEGASON, the measurement can be affected by the prevailing process conditions. In this menu item, the measurement reliability of the level echo is displayed in dB. Measurement reliability is represented by signal intensity minus noise. The larger the value, the more reliable the measurement.

Instrument status

Display indicates „OK“ or flashing fault signal, e.g. „E013“. The error is also displayed in clear text in the measured value display.

Curve selection

With VEGAPULS, VEGASON and VEGAFLEX the following curves can be selected:

- echo curve
- false echo curve ²⁾
- trend curve.

¹⁾ Pressure: -50 ... +150 % of the nominal range; temperature -50 ... +150°C.

²⁾ Not with VEGAFLEX.

The echo curve represents the echoes with signal strength in dB (VEGAPULS) resp. in V (VEGAFLEX) above the scaled distance. This enables a rough evaluation of the measurement.

The false echo curve represents the stored false echoes (see menu „Service“) of the empty vessel with signal strength in dB above the measuring range.

Curve presentation

A comparison of both curves gives more precise information about measurement reliability. The selected curve is continuously updated. By pushing the „OK“ key, a submenu with zoom function is opened.

The echo and false echo curve enables:

- „X-Zoom“ zoom function for the distance
- „Y-Zoom“ 2, 5, and 10 fold increase of the signal in dB
- „Unzoom“ reset of the presentation to nominal range at normal magnification.

The trend echo curve enables:

- „X-Zoom“ resolution in minutes, hours or days
- „Stop/Start“ interruption of a running recording or beginning of a new recording
- „Unzoom“ reset of the resolution to minutes.

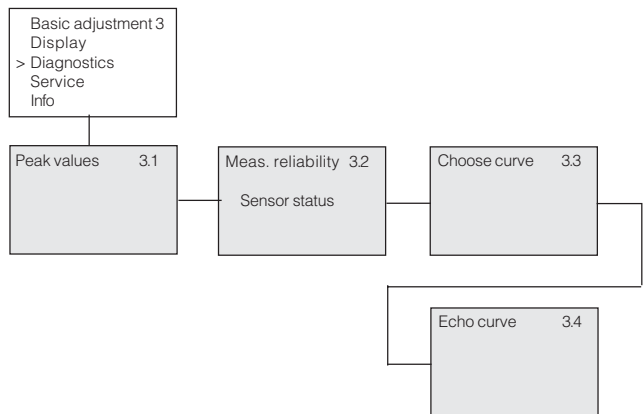

1) Not with VEGAFLEX.

Simulation of measured values

In this menu item you can simulate individual level or pressure values via the current output. By doing this, you can test, e.g. connected indicating instruments or the input card of the control system.

The following simulation units are available:

- percent
- current
- pressure (only with VEGABAR)
- distance (only with VEGAPULS and VEGAFLEX).

With Profibus PA sensors, the selection of the simulated value is carried out via the „channel“ in the menu item „Basic adjustment“.

This is how you start the simulation:

- 1 Push [OK]
- 2 Select the desired simulation unit with [->] and confirm with [OK]
- 3 Set the desired number value with [+] and [->]
- 4 Push [OK].



The simulation runs, i.e. the current 4 ... 20 mA is thus outputted acc. to the simulation value.

To terminate the simulation:

-> Push [ESC]



10 min. after the last pressing of a key, the simulation is automatically terminated.

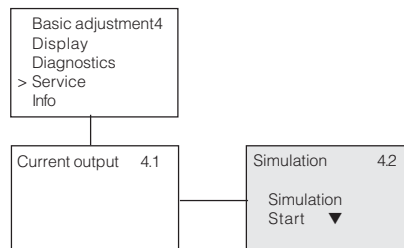

Reset

Basic adjustment:
Resets the adjusted and changed values.

Default setting:
Resets the service parameters which are changed with PACTware™.

Peak value of measurement and temperature ¹⁾:
Resets the min./max. values of pressure, level and temperature to the current values.

Reset values of the basic adjustment:

Menu	Menu point	VEGAPULS/VEGASON	VEGAFLEX	VEGABAR
Basic setting	Adjustment unit	deleted	deleted	Density unit kg/dm ³
		deleted	deleted	Density 1.0000 kg/dm ³
	zero, min. adjustment	upper dead zone depending on the instr.	50, 150, 300 mm (upper dead zone dep. on the instr.)	Beginning of nominal range
	span, max. adjustment	End of nominal range	30 m (d)	End of nominal range
	Damping	1 s	1 s	1 s
	Linearisation curve	linear	linear	linear
	Sensor-TAG	Sensor	Sensor	Sensor
Display	Indication value 1	Distance	Height	Dep. on adjustment unit pressure or height
		Scaling	0 % = 0.0, 100 % = 100.0	
Service	Current output	Characteristics: 4 ... 20 mA Failure mode: keep value min. current: 3.8 mA		

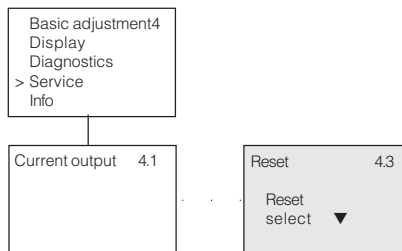

¹⁾ Temperature only with VEGABAR and VEGASON.

Adjustment unit ¹⁾

In this menu item you can select the system unit of the sensor in m (d) or ft (d).

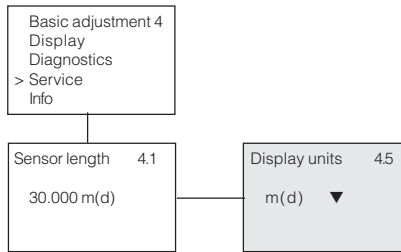
**Language**

The sensor is preset to the ordered language. In this menu item you can select the desired language:

- German
- English
- Français
- Español
- Pycckuu.

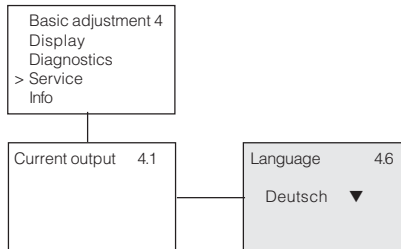

¹⁾ The description refers only to VEGAPULS, VEGASON and VEGAFLEX. For VEGABAR you will find the description in the sensor operating instructions manual under basic settings.

Copy sensor data

With this function you:

- copy data from the sensor
- copy data into the sensor.

The data are temporarily stored in PLICSCOM. They can be copied from there into several sensors of the same type or kept as a backup for a possible sensor exchange. When the data are copied into a sensor, the instrument type from which the data originate as well as the TAG no. of that sensor are displayed.

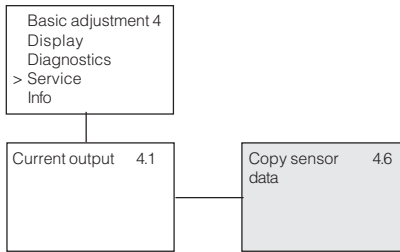

Activate/Deactivate PIN

Entering a 4-digit PIN protects the sensor data against unauthorised access and unintentional modifications. If the PIN is activated, only the following functions are available:

- select menu items and have data displayed
- copy data from the sensor into PLICSCOM.

In this menu item, the PIN is activated/deactivated permanently. If the PIN is activated permanently, it can be deactivated temporarily (i.e. for approx. 60 min.) in any menu item. The instrument is delivered with the PIN set to 0000.

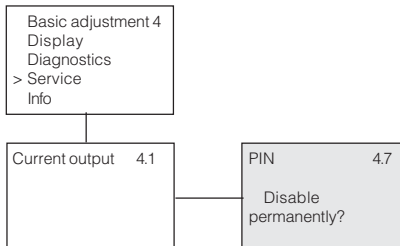

Info

In this menu, the most important sensor information can be displayed:

- Instrument type: e.g. VEGAPULS 61
- Serial no.: 8-digit figure, e.g. 12345678
- Calibration date: Date of the factory calibration e.g. 26. September 2003
- Software version: Edition of the sensor software, e.g. 3.03.00
- Last modification via PC: Date of the last modification of sensor parameters with the PC, e.g. 26. September 2003
- Sensor features, e.g. approval, sensor fittings, seal, meas. cell, meas. range, electronics, housing, cable entry, plug, length of the suspension cable.

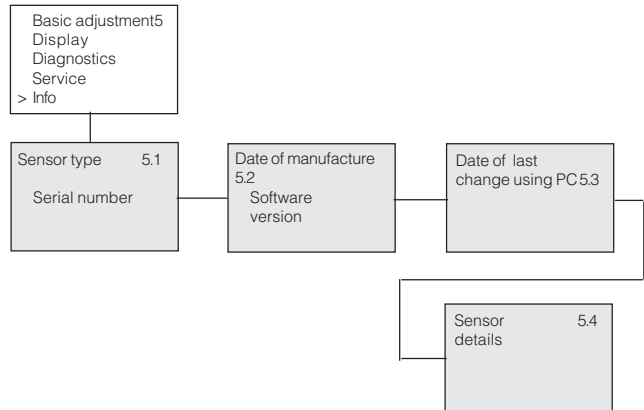

5.4 Special functions, 4 ... 20 mA/HART®

The 4 ... 20 mA/HART® specifications are briefly described in this paragraph. PLICSCOM's range of function is determined by the sensor and the sensor software version.

Display

In the menu item „Display“ you can define how the measured value should be presented on the display.

The following indication values are available:

- Height
- Pressure (only with VEGABAR)
- Distance (only with VEGAPULS, VEGASON and VEGAFLEX)
- Current
- Scaled
- Percentage
- Lin. percentage
- Temperature (only with VEGABAR).

The selection „scaled“ opens the menu items „Display unit“ and „Scaling“. In the menu item „Display unit“ there are the following options with the appropriate units:

- Height
- Mass
- Flow
- Volume
- Without unit.

The desired numerical value with decimal point for 0 % and 100 % is entered in the menu item “Scaling”.



There is the following connection between the indication value in the menu item „Display“ and the adjustment unit in the menu item „Basic adjustment“:

- When the indication value „Distance“ is selected on VEGAPULS, VEGASON and VEGAFLEX, the measured value is displayed in the selected adjustment unit, e.g. m (d).
- When the indication value „Pressure“ or „Height“ is selected on VEGABAR, the measured value is displayed in the selected adjustment unit, e.g. bar or m.

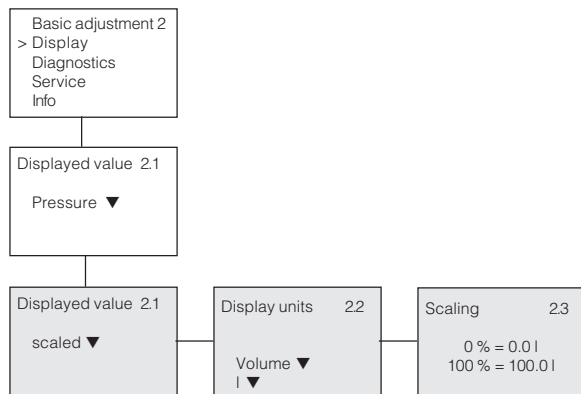

Current output

In the menu item „Current output“ you determine the behaviour of the current output during operation and in case of failure. The following options are available:

Current output	Characteristics	4 ... 20 mA 20 ... 4 mA
	Failure mode ¹⁾	Hold value 20.5 mA 22.0 mA < 3.6 mA
	Min. current ²⁾	3.8 mA 4 mA

¹⁾ Failure mode: value of the current output in case of failure, e.g. if no valid measured value is available.

²⁾ Min. current: the output current never falls below this value during operation

The fields highlighted in grey show the data of the default setting.

In HART® multidrop mode, the current is constantly 4 mA. This value does not change even in case of failure.

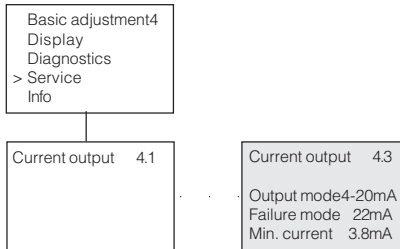

HART® mode

HART® offers the standard and multidrop¹⁾ modes. In multidrop mode, up to 15 sensors can be operated on one two-wire cable.

In this menu item you can set the HART® mode and, in case of multidrop, set the address.

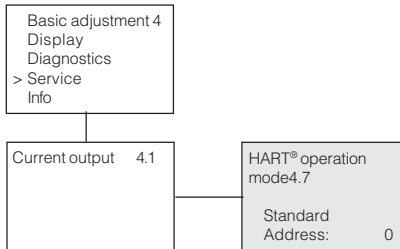

5.5 Special functions, Profibus PA

The Profibus PA specifications are briefly described in this paragraph. PLICSCOM's range of function is determined by the sensor and the sensor software version.

¹⁾ In multidrop mode the 4 ... 20 mA signal of the HART® sensor is switched off. The sensor consumes a constant current of 4 mA. The measuring signal is only transmitted as digital HART® signal.

Sensor address

Sensors operate as slaves on the Profibus PA. To be identified as a bus participant, each sensor must have a unique address. Each instrument is delivered with address 126. With this address, it can at first be connected to an existing bus. However, the address must be changed. This can be done in this menu item.

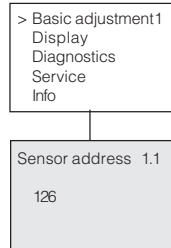

Channel

The channel is the input selector switch for the function block (FB) of the sensor. Within the function block, additional scalings (Out-Scale) are carried out. In this menu item, the value for the function block is selected:

- SV1 (Secondary Value 1):
 - Percent with VEGAPULS, VEGASON and VEGAFLEX
 - Pressure or height with VEGABAR
- SV2 (Secondary Value 2):
 - Distance with VEGAPULS, VEGASON and VEGAFLEX
 - Percent with VEGABAR
- PV (Primary Value): linearised percentage value.

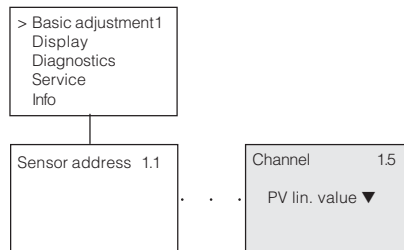

Define display

VEGAPULS, VEGASON and VEGAFLEX deliver the following measured values

- SV1 (Secondary Value 1): Percentage value after the adjustment
- SV2 (Secondary Value 2): Distance value before the adjustment
- PV (Primary Value): Linearised percentage value
- PA-Out (value after passing a function block): PA output.

VEGABAR delivers the following measured values:

- SV1 (Secondary Value 1): Pressure or height value before the adjustment
- SV2 (Secondary Value 2): Percentage value after the adjustment
- PV (Primary Value): Linearised percentage value
- PA-Out (value after passing a function block): PA output
- Temperature.

In the menu „Display“ you define which of these values should be presented on the display.

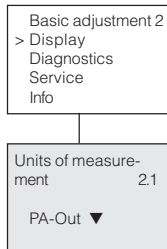

Additional PA value

The Profibus transmits two measured values cyclically. The first value is determined in the menu item „Channel“. The selection of the additional cyclical value is made in the menu item „additional PA value“.

With VEGAPULS, VEGASON and VEGAFLEX, the following values are available for selection:

- SV1 (Secondary Value 1): Percentage value after the adjustment
- SV2 (Secondary Value 2): Distance value before the adjustment
- PV (Primary Value): Linearised percentage value.

With VEGABAR, the following values are available for selection:

- SV1 (Secondary Value 1): Pressure or height value before the adjustment
- SV2 (Secondary Value 2): Percentage value after the adjustment
- PV (Primary Value): Linearised percentage value.

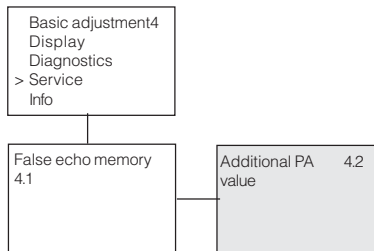

Determine Out-Scale

Here, you determine the unit and scaling for PA-Out. These settings also apply to the value displayed on PLICSCOM, if in the menu item „Indicated value“ PA-Out was selected.

The following indicated values are available in „Out-Scale unit“:

- Pressure (only with VEGABAR)
- Height
- Mass
- Flow
- Volume
- Others (no unit, %, mA).

In the menu item „PV-Out-Scale“, the requested number value (with decimal point, for 0 % and 100 %) of the measured value is entered.

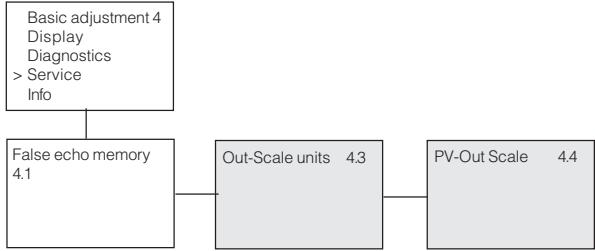

Simulation of measured values

In this menu item, you can simulate any level or pressure values via the Profibus PA output. The value set in „Channel“ is simulated as linearised percentage value.

This is how you start the simulation:

→ Push [OK]



The simulation runs, the PA value is outputted acc. to the simulation value.

To terminate the simulation:

→ Push [ESC]



10 min. after the last pressing of a key, the simulation is automatically terminated.

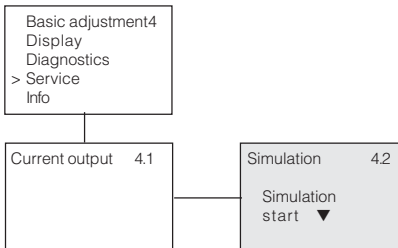

6 Dismounting

6.1 Dismounting procedure

Take note of chapter 4 „Mounting“ and carry out the listed steps in reverse order.

6.2 Disposal

PLICSCOM consists of materials which can be recycled by specialised recycling companies. We have purposely designed the electronics modules to be easily separable. Mark the instrument as scrap and dispose of it according to government regulations (electronic scrap ordinance, ...).

Materials: see technical data

If you cannot dispose of the instrument properly, please contact us about disposal methods or return.

Supplement

Technical data

Instrument name	Indication and adjustment module PLICSCOM
Power supply and data transmission	via the sensor through sliding contacts (I ² C-Bus)
Display	LC display in full dot matrix
Adjustment elements	4 keys
Automatic reset to measured value display	after approx. 10 min
Protection	IP 20 (mounted: IP 40)
Materials	
– housing	PE
– inspection window	Polyester foil
Weight	approx. 150 g
Ambient temperature	-15 ... +70°C
Storage and transport temperature	-40 ... +80°C

Dimensions

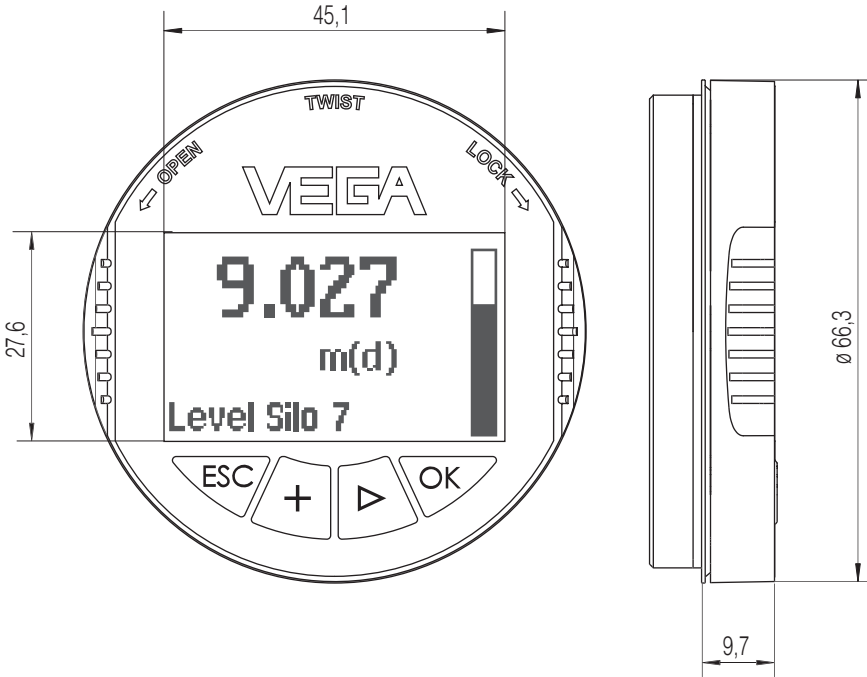



VEGA Grieshaber KG
Am Hohenstein 113
77761 Schiltach
Germany
Phone (07836) 50-0
Fax (07836) 50-201
E-Mail info@de.vega.com
www.vega.com



All statements concerning scope of delivery, application, practical use and operating conditions of the sensors and processing systems correspond to the information available at the time of printing.