

# SAC-3P-M 8MS/ 5,0-PUR/M12FR - Sensor/actuator cable



1500185

<https://www.phoenixcontact.com/gb/products/1500185>

Please be informed that the data shown in this PDF document is generated from our online catalog. Please find the complete data in the user documentation. Our general terms of use for downloads are valid.



Sensor/actuator cable, 3-position, PUR halogen-free, black-gray RAL 7021, Plug straight M8, coding: A, on Socket angled M12, coding: A, cable length: 5 m

## Commercial data

Item number	1500185
Packing unit	1 pc
Minimum order quantity	1 pc
Note	Made to order (non-returnable)
Sales key	AF1CBA
Product key	AF1CBA
GTIN	4017918584849
Weight per piece (including packing)	108.5 g
Weight per piece (excluding packing)	100.8 g
Customs tariff number	85444290
Country of origin	DE

# SAC-3P-M 8MS/ 5,0-PUR/M12FR - Sensor/actuator cable



1500185

<https://www.phoenixcontact.com/gb/products/1500185>

## Technical data

### Product properties

Product type	Sensor/actuator cable
Number of positions	3
No. of cable outlets	1
Shielded	no
Coding	A

### Insulation characteristics

Overvoltage category	II
Degree of pollution	3

### Material specifications

Flammability rating according to UL 94	HB
Seal material	NBR
Material of grip body	TPU, hardly inflammable, self-extinguishing
Contact material	CuSn
Contact surface material	Ni/Au
Contact carrier material	TPU GF
Material for screw connection	Zinc die-cast, nickel-plated

### Electrical properties

Insulation resistance	≥ 100 MΩ
Nominal voltage $U_N$	48 V AC
	60 V DC
Nominal current $I_N$	4 A

### Mechanical properties

#### Mechanical data

Insertion/withdrawal cycles	≥ 100
-----------------------------	-------

### Signaling

Status display	no
Status display present	no

### Connector

#### Connection 1

Type	Plug straight M8
Number of positions	3
Coding type	A

#### Connection 2

Type	Socket angled M12
------	-------------------

# SAC-3P-M 8MS/ 5,0-PUR/M12FR - Sensor/actuator cable

1500185

<https://www.phoenixcontact.com/gb/products/1500185>

Number of positions	3
Coding type	A

## Cable/line

Cable length	5 m
--------------	-----

PUR halogen-free black [PUR]

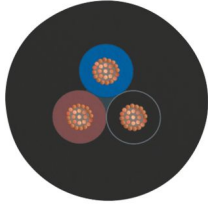
Dimensional drawing	
Cable weight	18 kg/km
UL AWM Style	20549 / 10493 (80°C/300 V)
Number of positions	3
Shielded	no
Cable type	PUR halogen-free black [PUR]
Conductor structure signal line	32x 0.10 mm
AWG signal line	24
Conductor cross section	3x 0.25 mm <sup>2</sup> (Signal line)
Wire diameter incl. insulation	1.17 mm ±0.02 mm
External cable diameter	3.60 mm ±0.15 mm
Outer sheath, material	PUR
External sheath, color	black-gray RAL 7021
Conductor material	Bare Cu litz wires
Material wire insulation	PP
Single wire, color	brown, blue, black
Thickness, insulation	≥ 0.21 mm (Core insulation)
Thickness, outer sheath	approx. 0.50 mm
Overall twist	3 wires, twisted
Length of twist, overall twist	40 mm
Max. conductor resistance	≤ 78 Ω/km (at 20 °C)
Insulation resistance	≥ 100 GΩ*km (at 20 °C)
Nominal voltage, cable	≤ 300 V
Test voltage	≥ 3000 V
Smallest bending radius, fixed installation	18 mm
Smallest bending radius, movable installation	36 mm
Dynamic load capacity (bending)	Max. bending cycles: 10000000, Bending radius: 44 mm, Traversing path: 10 m, Traversing rate: 3 m/s, Acceleration: 10 m/s <sup>2</sup>
Dynamic load capacity (torsion)	Torsion: ±180 °/m, Torsion cycles: ≥2000000, Torsional frequency: 35 cycles/min.

# SAC-3P-M 8MS/ 5,0-PUR/M12FR - Sensor/actuator cable



1500185

<https://www.phoenixcontact.com/gb/products/1500185>

Halogen-free	in accordance with DIN VDE 0472 part 815
Flame resistance	in accordance with UL 758/1581 FT2
	DIN EN 60332-2-2 (20 s)
Resistance to oil	in accordance with DIN EN 60811-2-1
Other resistance	hydrolysis and microbe resistant
	Highly resistant to acids, alkaline solutions and solvents
	Resistant to salt water
	partly UV-resistant (in accordance with DIN EN ISO 4892-2-A)
Special properties	Flexible cable conduit capable
	Silicone-free
	Free of substances which would hinder coating with paint or varnish
Ambient temperature (operation)	-40 °C ... 80 °C (cable, fixed installation)
	-25 °C ... 80 °C (Cable, flexible installation)

## Environmental and real-life conditions

### Ambient conditions

Degree of protection	IP65
	IP67
	IP68
Ambient temperature (operation)	-25 °C ... 90 °C (Plug / socket)
	-40 °C ... 80 °C (cable, fixed installation)
	-5 °C ... 80 °C (Cable, flexible installation)

# SAC-3P-M 8MS/ 5,0-PUR/M12FR - Sensor/actuator cable

1500185

<https://www.phoenixcontact.com/gb/products/1500185>

## Drawings

Dimensional drawing

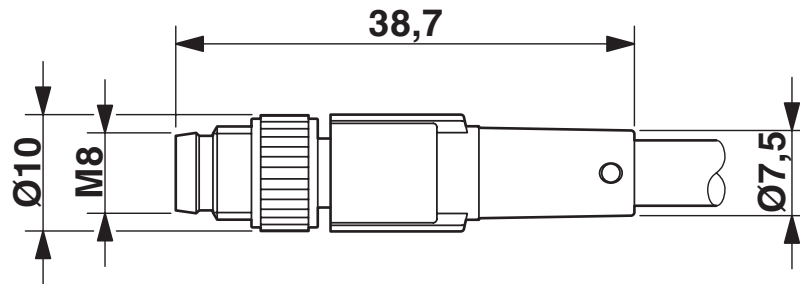

M8 x 1 male plug, straight version

Dimensional drawing

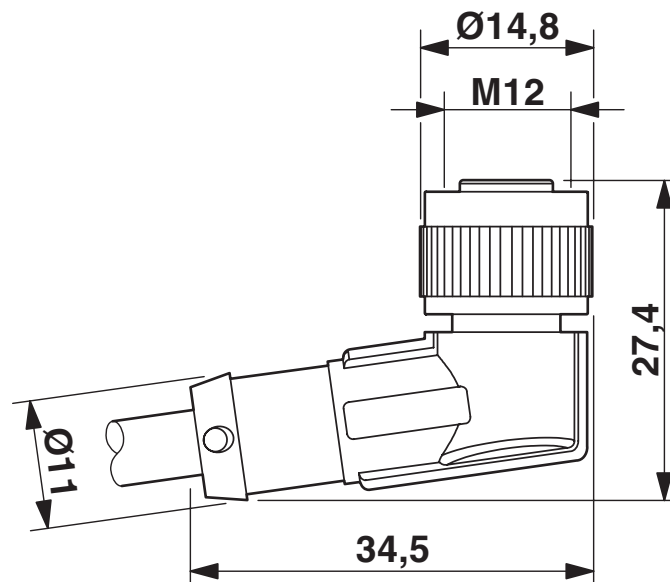

M12 x 1 socket, angled

# SAC-3P-M 8MS/ 5,0-PUR/M12FR - Sensor/actuator cable

1500185

<https://www.phoenixcontact.com/gb/products/1500185>

Schematic diagram

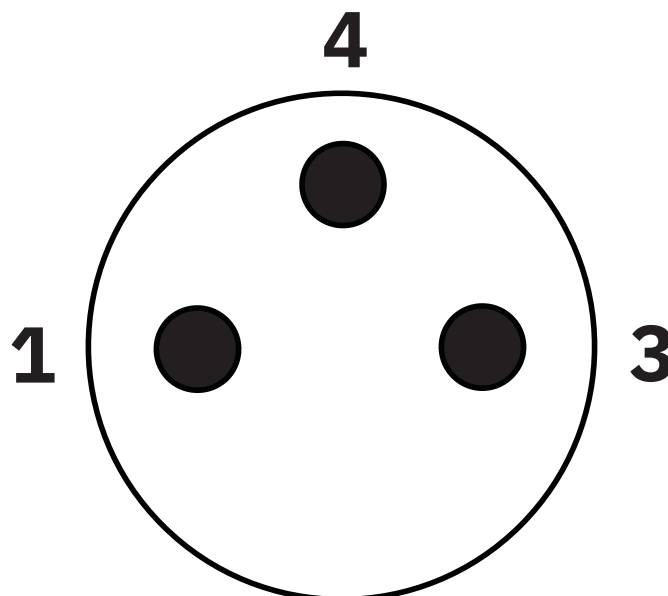

Pin assignment M8 plug, 3-pos., view male side

Schematic diagram

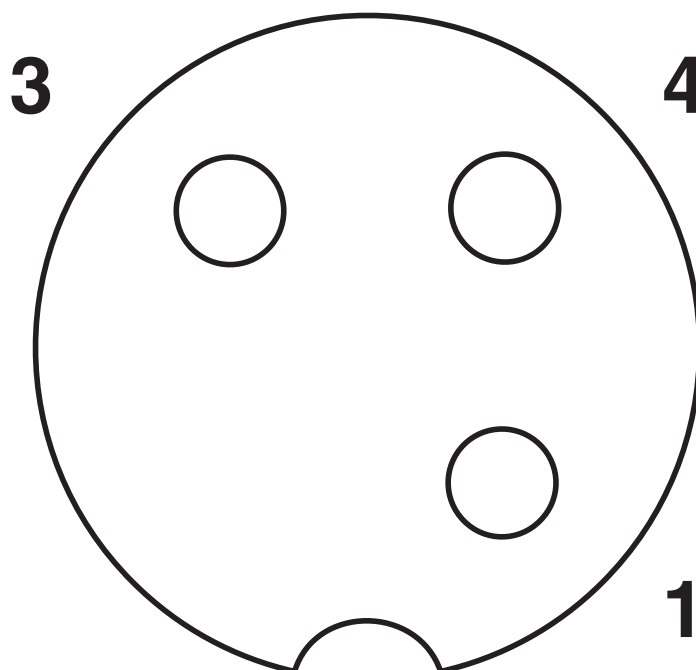

Pin assignment M12 socket, 3-pos., A-coded, view female side

# SAC-3P-M 8MS/ 5,0-PUR/M12FR - Sensor/actuator cable



1500185

<https://www.phoenixcontact.com/gb/products/1500185>

Circuit diagram

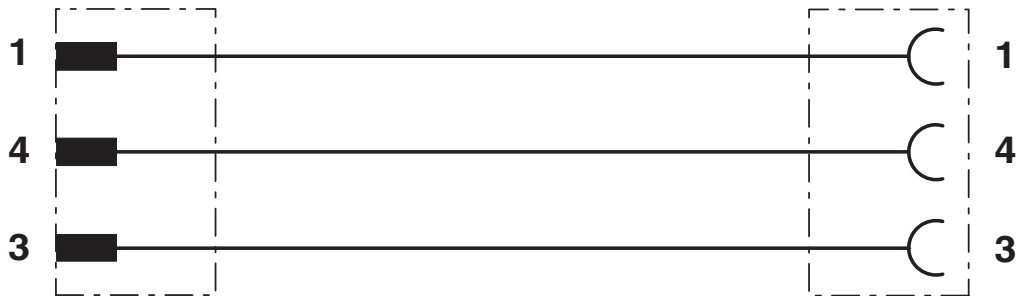

Contact assignment of M8 plugs / M12 sockets

# SAC-3P-M 8MS/ 5,0-PUR/M12FR - Sensor/actuator cable





1500185

<https://www.phoenixcontact.com/gb/products/1500185>

## Approvals

To download certificates, visit the product detail page: <https://www.phoenixcontact.com/gb/products/1500185>

 <b>UL Listed</b> Approval ID: FILE E 221474				
	Nominal voltage $U_N$	Nominal current $I_N$	Cross section AWG	Cross section $\text{mm}^2$
	60 V	4 A	-	-

 <b>cUL Listed</b> Approval ID: FILE E 221474				
	Nominal voltage $U_N$	Nominal current $I_N$	Cross section AWG	Cross section $\text{mm}^2$
	60 V	4 A	-	-



# SAC-3P-M 8MS/ 5,0-PUR/M12FR - Sensor/actuator cable



1500185

<https://www.phoenixcontact.com/gb/products/1500185>

## Classifications

### ECLASS

ECLASS-13.0

27060311

### ETIM

ETIM 9.0

EC001855

### UNSPSC

UNSPSC 21.0

26121600

# SAC-3P-M 8MS/ 5,0-PUR/M12FR - Sensor/actuator cable



1500185

<https://www.phoenixcontact.com/gb/products/1500185>

## Environmental product compliance

### EU RoHS

Fulfills EU RoHS substance requirements	Yes, No exemptions
---	--------------------

### China RoHS

Environment friendly use period (EFUP)	EFUP-E
	No hazardous substances above the limits

### EU REACH SVHC

REACH candidate substance (CAS No.)	No substance above 0.1 wt%
-------------------------------------	----------------------------

Phoenix Contact 2025 © - all rights reserved  
<https://www.phoenixcontact.com>

PHOENIX CONTACT Ltd  
Halesfield 13, Telford  
Shropshire, TF7 4PG  
01952 681700  
[info@phoenixcontact.co.uk](mailto:info@phoenixcontact.co.uk)