



DIGITAL HOUR METER & COUNTER

RS Stock No's: **896-6983**
896-6992

CONNECTION DIAGRAM:

For **896-6992**

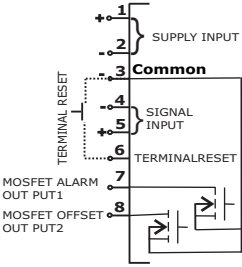

For **896-6983**

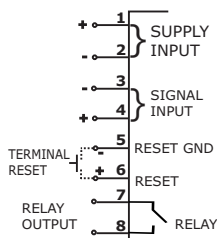

Proximity Switch Connection Diagram:

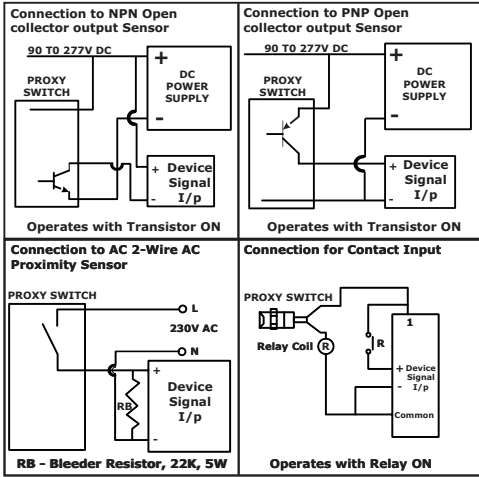

Using MOSFET O/P as signal I/P to External system

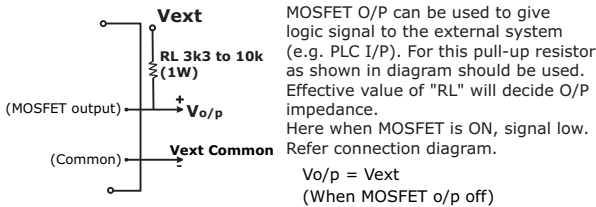

Overall Product Dimensions & Mounting Details (in mm)

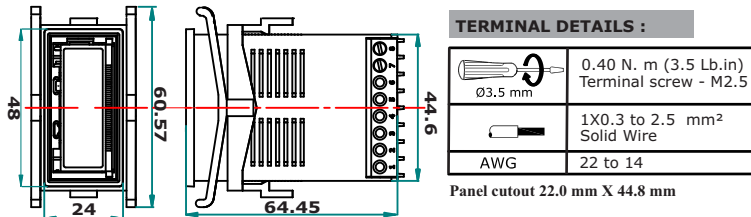

FRONT VIEW:

SYMBOL MEANING :

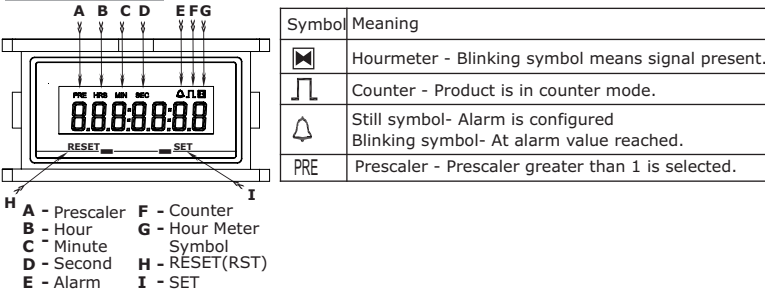

Hour Meter Flow :-

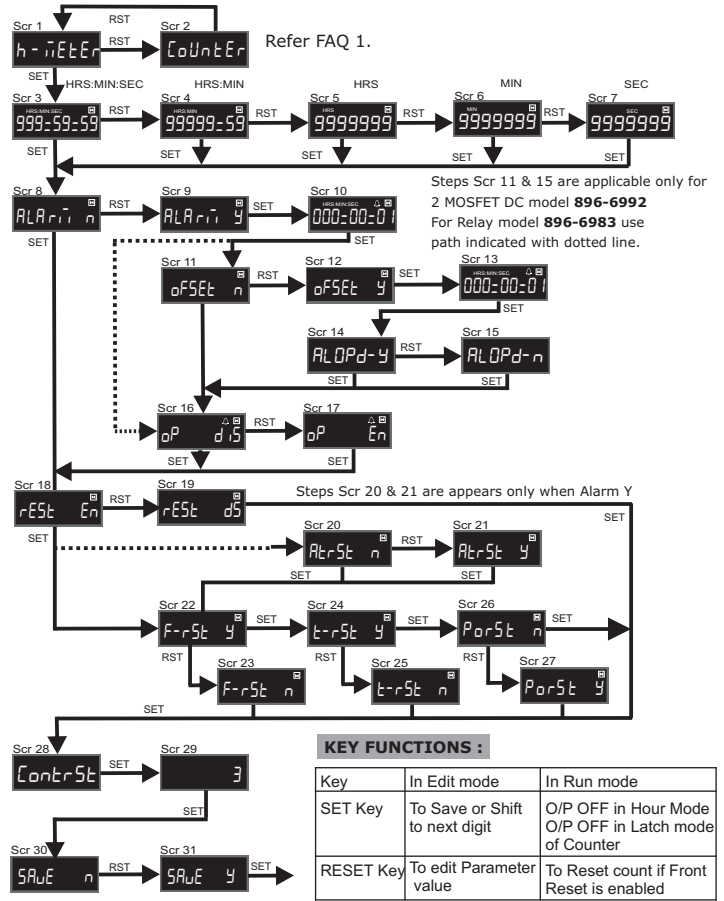

Counter Flow:- Auto reset is not applicable for Down counter.

