

New

Mechanically Jointed Rodless Cylinders

Basic short type (Rubber bumper)

Series **MY3A**

NEW

Bore sizes
ø20, ø32, ø50 added



Basic standard type (Air cushion)

Series **MY3B**

NEW

Bore sizes
ø20, ø32, ø50 added



Slide bearing guide type (Air cushion)

Series **MY3M**



Series Variations

★ are new additions

Series	Type	Piping type	Bore size (mm)							Rubber bumper	Air cushion	Stroke adjustment unit Shock absorber	Side support	Floating bracket	Made to Order	Page
			16	20	25	32	40	50	63							
MY3A	Basic short type	Centralized piping	●	★	●	★	●	★	●	●					Long stroke -XB11	P.1
MY3B	Basic standard type		●	★	●	★	●	★	●		●	●	●	●	Shock Absorber Soft Type (Note) -XB22	
MY3M	Slide bearing guide type		●	●	●	●	●	●	●		●	●	●	●	Helical insert threads -X168	
		Standard piping												Holder mounting bracket (Note) -X416, -X417	P.25	
														Copper Free 20-		

Note) Except the MY3A

Shock Absorber Soft Type Series RJ Installed Cylinder (-XB22 spec.) added

- Soft stopping enabled at stroke end.
- Two types of shock absorbers are selectable according to operating environment.



CAT.ES20-165C

High functionality with reduced height and length

Mechanically Jointed Rodless Cylinders

Series MY3

MY3A

Basic short type
(Rubber bumper)

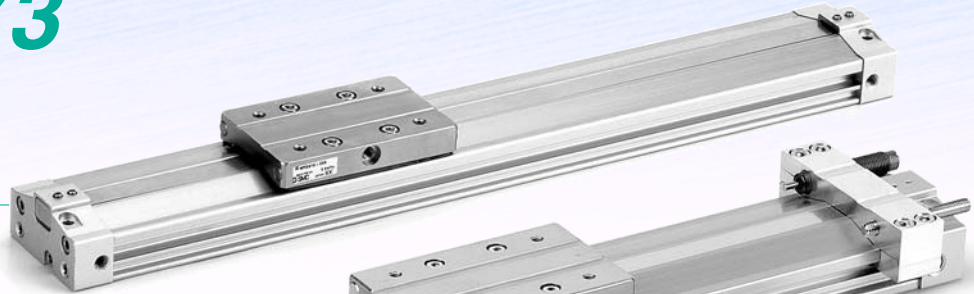

MY3B

Basic standard type
(Air cushion)

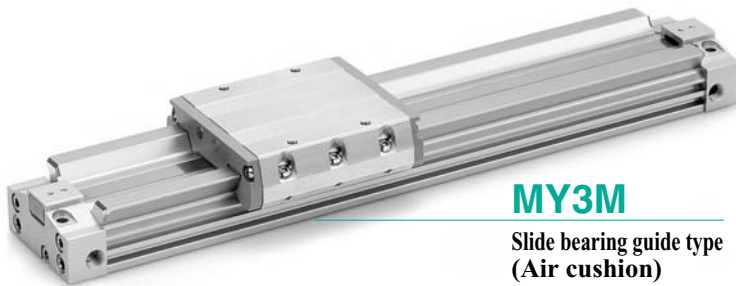

MY3M

Slide bearing guide type
(Air cushion)

Work pieces can be loaded directly on the work table due to the integrated guide.

Overall length (Z) reduced by **140 mm** at the maximum

MY3A (with rubber bumper)

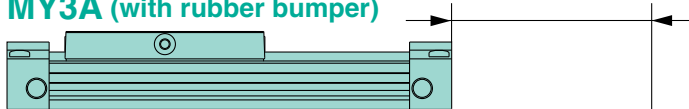

MY3B/MY3M (with air cushion)



MY1B/MY1M (with air cushion)

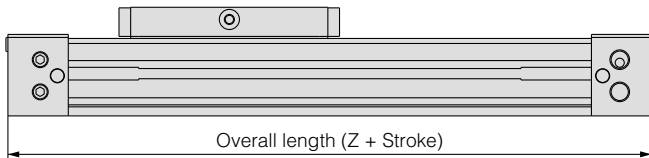

Overall Length (Z) (mm)

Series	ø16	ø20	ø25	ø32	ø40	ø50	ø63
MY3A	110	128	150	193	240	274	320
MY3B	122	148	178	225	276	310	356
MY3M	122	—	178	—	276	—	356
MY1B	160	200	220	280	340	400	460
MY1M	160	200	220	280	340	400	460

Loading Capacity

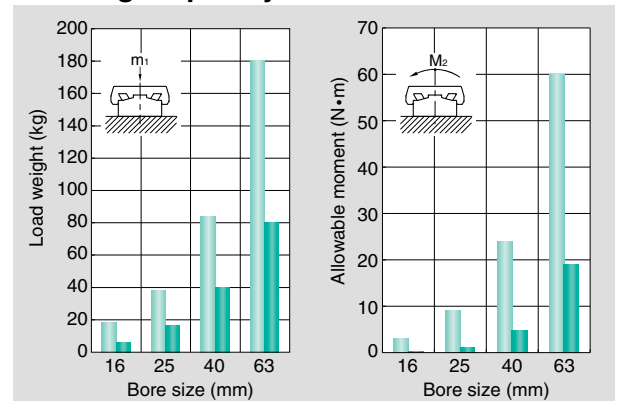

Height (H) reduced by **36%** at the maximum

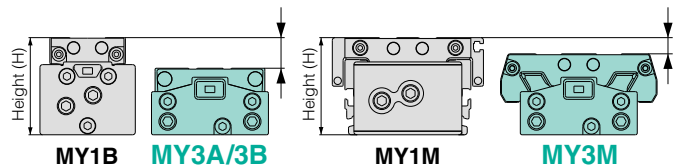

Height (H) (mm)

Series	ø16	ø20	ø25	ø32	ø40	ø50	ø63
MY3A	27	32	37	45	54	67	84
MY3B	27	32	37	45	54	67	84
MY1B	37	46	54	68	84	94	116
MY3M	33	—	45	—	63	—	93
MY1M	40	—	54	—	84	—	130

Weight reduced by **55%** at the maximum

Weight (kg)

Series	ø16	ø20	ø25	ø32	ø40	ø50	ø63
MY3A	0.34	0.57	0.99	1.61	2.95	4.52	8.26
MY3B	0.35	0.67	1.09	1.75	3.08	4.90	8.99
MY1B	0.73	1.26	1.57	3.01	4.41	8.66	14.5
MY3M	0.45	—	1.32	—	3.65	—	9.99
MY1M	0.91	—	2.12	—	7.00	—	18.8

* At 100 mm stroke

Stroke Adjustment Unit

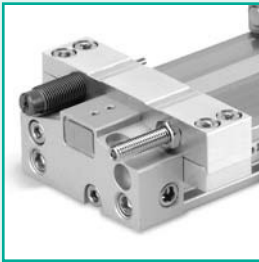

(MY3B/3M)

Floating Bracket

Easy connection with external guide. Vertical and lateral mounting is possible. (Page 24)

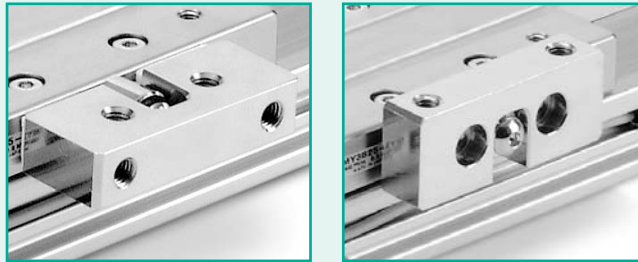

(MY3A/3B)

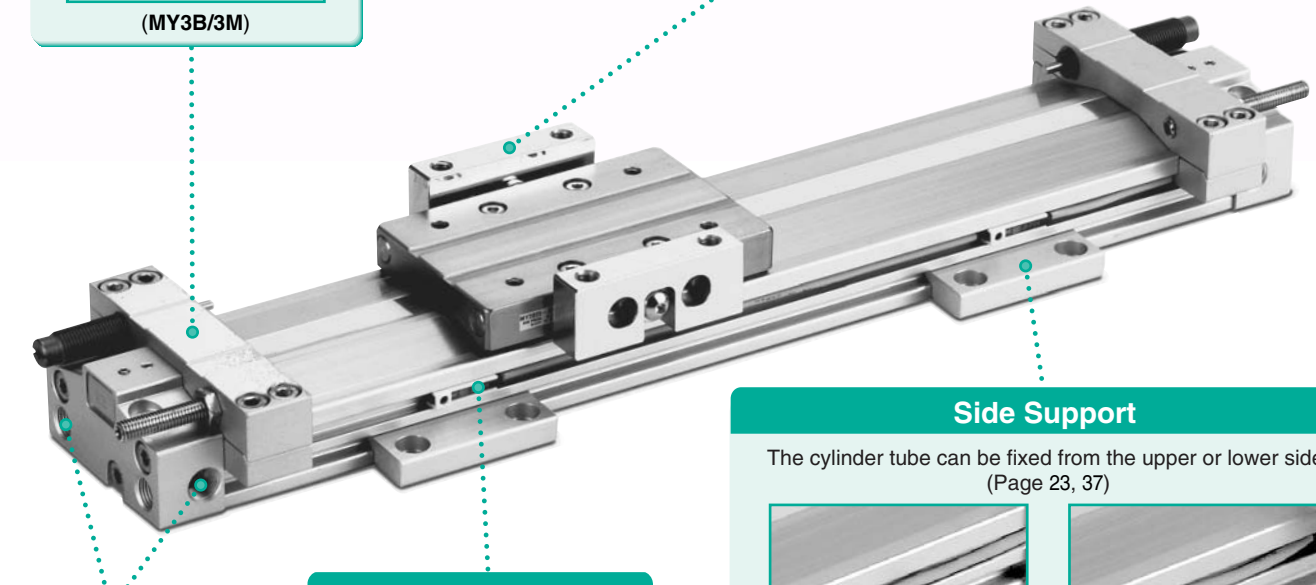

Centralized Piping

Integrated piping in the head cover is possible. (Page 20, 21, 35)

Auto Switch

Can be mounted on both sides from the front direction.

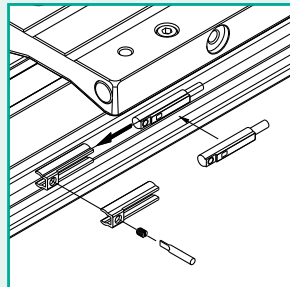

Side Support

The cylinder tube can be fixed from the upper or lower side. (Page 23, 37)

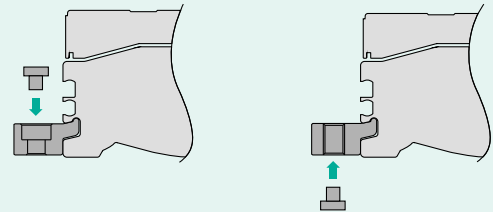
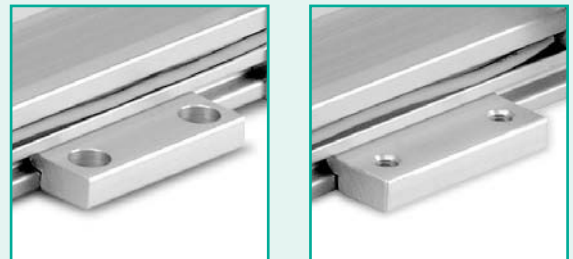

The uniquely designed piston shape enables reduction of the height and length as well as practical arrangement of the common piping passages, cushion mechanism and positioning mechanism. This has achieved drastic miniaturization and weight reduction.

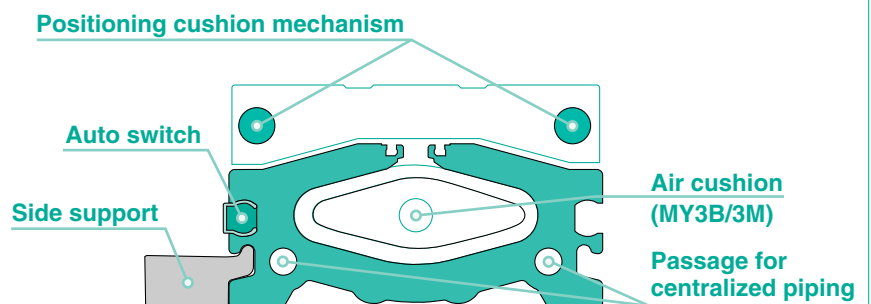

Series MY3

Model Selection

The following are steps for selecting the MY3 series which is best suited to your application.

Guideline for Tentative Model Selection

Series	Type	Guideline for tentative model selection				Note
		Stroke accuracy	Use of external guide	Direct loaded	Table accuracy	
MY3A	Basic short type	△	◎	△	△	Generally combined with a separate guide making it, by length, more compact.
MY3B	Basic standard type	◎	◎	○	△	Generally combined with a separate guide, when stroke accuracy is required.
MY3M	Slide bearing guide type	◎	×	◎	○	Mounting a work piece directly on the product, when stroke accuracy is required.

◎ Most suitable ○ Suitable △ Usable × Not recommended

Note 1) The table accuracy means the amount of table deflection when a moment is applied.

Note 2) Travelling parallelism is not guaranteed for this cylinder. Please consult with SMC if the travelling parallelism or stroke intermediate position needs to be precise.

Selection Flow Chart

When an external guide is used, the selection confirmation of the guide capacity should follow the selection procedure of the external guide.

The MY3 series allow direct load application within the allowable range for the built-in guide. The payload in this case will vary depending on the driving speed and the mounting orientation of the cylinder. Please refer to the flow below and confirm the selection. (For more detailed description of the selection flow, please refer to the instruction manual.)

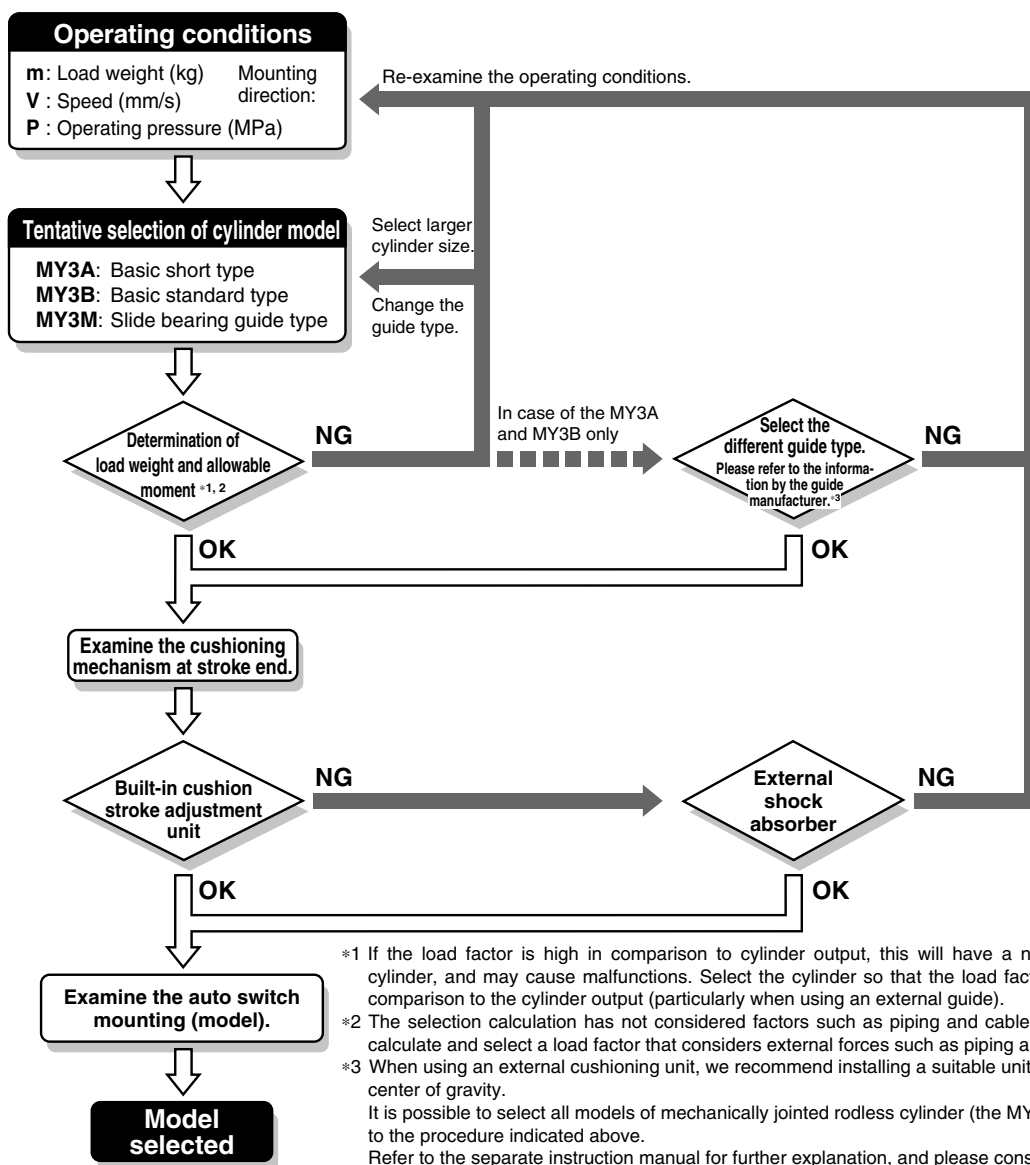



⚠ Warning

Reduction circuits or shock absorbers may be necessary.

If the driven object is fast, or the weight is large, the cylinder cushion alone may not be able to absorb the impact. In this case, install a reduction circuit before the cushion, or install an external shock absorber to reduce the impact. Please check the machine's rigidity as well.

* External shock absorbers must meet the characteristics listed on page 11. Cylinders may be damaged if shock absorbers that do not have the recommended characteristics are used.

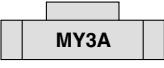
Maximum operating speed

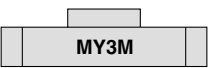
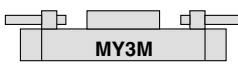
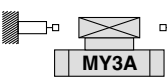
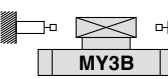
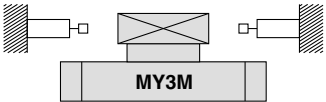
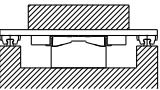
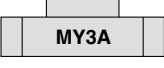
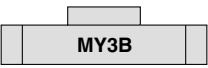
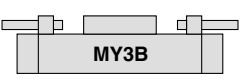
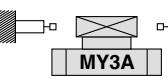
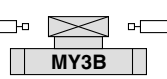
How to mount a load	Stroke positioning	Shock absorber	Maximum operating speed (mm/s)			
			500	1000	1500	
Direct loaded 	Cylinder stroke end	Rubber bumper 				
		Air cushion				
						
	Stroke adjustment unit (Option: L, H unit)	Shock absorber 	Note 5)			
External stopper	External shock absorber Note 2)			Note 3)		
			Note 3)			
Use of external guide Note 1) 	Cylinder stroke end	Rubber bumper 				
		Air cushion 				
	Stroke adjustment unit (Option: L, H unit)	Shock absorber 	Note 4) Note 5)			
	External stopper	External shock absorber Note 2)			Note 3)	

Note 1) Mechanically jointed rodless cylinders can be used with a direct load within the allowable range for each guide type, however, careful alignment is necessary for connection to a load which has an external guide mechanism. The mounting bracket for the external guide and the floating bracket must be mounted in a position that guarantees freedom of movement to the floating Y and Z axial. Ensure that the floating bracket is set so that the thrust transmission section has even contact.
* For details on the floating Y and Z axial, refer to the coordinates and moments in the selection method on page 24.

Note 2) The shock absorber must meet the conditions mentioned on page 10 and 11.

Note 3) As the external shock absorber, a unit with appropriate capacity and features should be installed close to the load center of gravity.

Note 4) Use the stroke adjustment unit of the MY3B series with an external guide.

Note 5) Shown below are the details of the maximum operating speed for the stroke adjustment unit.

MY3 Series, Maximum Operating Speed when Using the Stroke Adjustment Unit

Unit: mm/s

Series	Bore size (mm)	Stroke adjustment range	Inside the fine stroke adjustment range	Outside the fine stroke adjustment range
MY3B	16, 20	L unit	800	500
		H unit	1000	800
	25, 32, 40, 50, 63	L, H unit	1000	800
MY3M	16, 25, 40, 63	L, H unit	1500	800

Outside the fine stroke adjustment range means that when a holder mounting bracket (X416, X417) is used.

Holder mounting bracket → Refer to page 42, 43.

Types of Moment and Load Weight Applied to Rodless Cylinders

Multiple moments may be generated depending on the mounting orientation, load and position of the center of gravity.

Coordinates and Moments

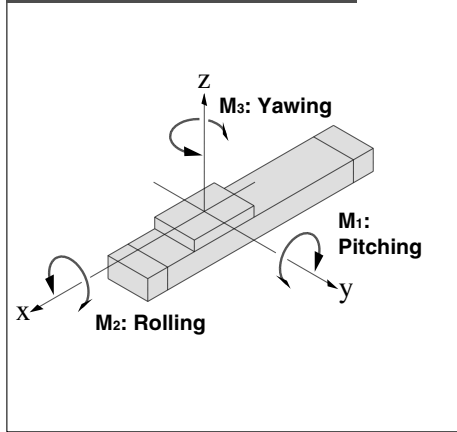

Load Weight and Static Moment

Horizontal mounting

Ceiling mounting

Wall mounting

Vertical mounting

Mounting direction	Horizontal	Ceiling	Wall	Vertical
Static load m	m₁	m₂	m₃	m₄ <small>(Note)</small>
Static moment	M₁	m₁ x g x X	m₂ x g x X	m₄ x g x Z
	M₂	m₁ x g x Y	m₂ x g x Y	—
	M₃	—	—	m₃ x g x X m₄ x g x Y

Note) m₄ is a weight movable by thrust. Use 0.3 to 0.7 times the thrust (differs depending on the operating speed) as a guide for actual use.

g: Gravitational acceleration

Dynamic Moment

Mounting direction	Horizontal	Ceiling	Wall	Vertical
Dynamic load F_E	1.4va x delta x m_n x g			
Dynamic moment	M_{1E}	1/3 x F_E x Z		
	M_{2E}	Dynamic moment M_{2E} will not be generated.		
	M_{3E}	1/3 x F_E x Y		

Note) Regardless of the mounting orientation, dynamic moment is calculated with the formulae above.

g: Gravitational acceleration
va: Average speed
delta: Bumper coefficient

Calculation of Guide Load Factor

- Maximum load weight (1), static moment (2), and dynamic moment (3) (at the time of impact with stopper) must be examined for the selection calculations.
 - * To evaluate, use va (average speed) for (1) and (2), and v (impact speed $v = 1.4va$) for (3). Calculate m_{max} for (1) from the maximum allowable load graph (m_1, m_2, m_3) and M_{max} for (2) and (3) from the maximum allowable moment graph (M_1, M_2, M_3).

$$\text{Sum of guide load factors } \Sigma \alpha = \frac{\text{Load weight [m]}}{\text{Maximum load weight [m max]}} + \frac{\text{Static moment [M]}^{\text{Note 1)}}}{\text{Allowable static moment [Mmax]}} + \frac{\text{Dynamic moment [ME]}^{\text{Note 2)}}}{\text{Allowable dynamic moment [MEmax]}} \leq 1$$

- Note 1) Moment caused by the load, etc., with cylinder in resting condition.
 Note 2) Moment caused by the impact load equivalent at the stroke end (at the time of impact with stopper).
 Note 3) Depending on the shape of the work piece, multiple moments may occur. When this happens, the sum of the load factors ($\Sigma \alpha$) is the total of all such moments.

- Reference formulas [Dynamic moment at impact]

Use the following formulas to calculate dynamic moment when taking stopper impact into consideration.

- m : Load weight (kg)
- F : Load (N)
- F_E : Load equivalent to impact (at impact with stopper) (N)
- va : Average speed (mm/s)
- M : Static moment (N·m)
- v : Impact speed (mm/s)
- L_1 : Distance to the load's center of gravity (m)
- M_E : Dynamic moment (N·m)
- δ : Bumper coefficient
 - With rubber bumper = 4/100
 - With air cushion = 1/100
 - With shock absorber = 1/100
- g : Gravitational acceleration (9.8 m/s²)

$$v = 1.4va \text{ (mm/s)} \quad F_E = 1.4va \times \delta \times m \cdot g$$

$$\therefore M_E = \frac{1}{3} \cdot F_E \cdot L_1 = 4.57va \delta m L_1 \text{ (N} \cdot \text{m)}$$

Note 4) $1.4va\delta$ is a dimensionless coefficient for calculating impact force.

Note 5) Average load coefficient = $\left(\frac{1}{3}\right)$:

This coefficient is for averaging the maximum load moment at the time of stopper impact according to service life calculations.

- For detailed selection procedure, please refer to pages 2, 3, 26, 27.

Front matter 3

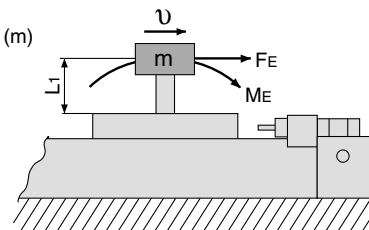

Calculation of Guide Load Factor

1 Operating Conditions

- Cylinder MY3A25-500
- Average operating speed v_a 300 mm/s
- Mounting direction Horizontal mounting
- Cushion Rubber bumper ($\delta = 4/100$)

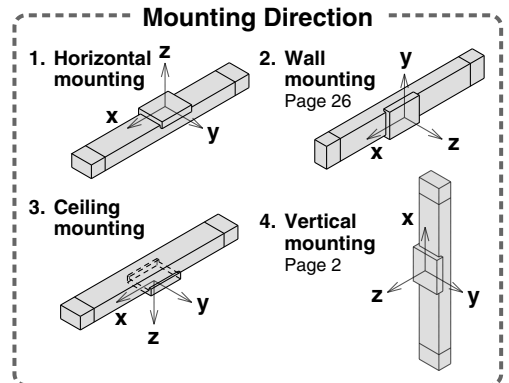
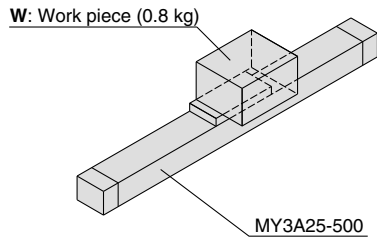

Refer to the pages mentioned above for actual examples of calculation for each orientation.
 * For ceiling mounting, refer to Best Pneumatics No. 2, page 998.

2 Load Blocking

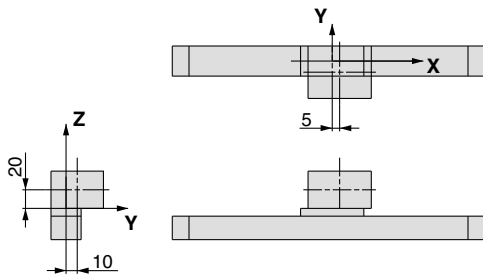

Work Piece Weight and Center of Gravity

Work piece no.	Weight (m)	Center of gravity		
		X-axis	Y-axis	Z-axis
W	0.8 kg	5 mm	10 mm	20 mm

3 Calculation of Load Factor for Static Load

m₁: Weight

m₁ max (from ① of graph MY3A/**m₁**) = 10.7 (kg)

Load factor $\alpha_1 = m_1 / m_1 \text{ max} = 0.8 / 10.7 = 0.08$

M₁: Moment

M₁ max (from ② of graph MY3A/**M₁**) = 4 (N·m)

M₁ = **m₁** x **g** x **X** = 0.8 x 9.8 x 5 x 10⁻³ = 0.04 (N·m)

Load factor $\alpha_2 = M_1 / M_1 \text{ max} = 0.04 / 4 = 0.01$

M₂: Moment

M₂ max (from ③ of graph MY3A/**M₂**) = 0.8 (N·m)

M₃ = **m₁** x **g** x **Y** = 0.8 x 9.8 x 10 x 10⁻³ = 0.08 (N·m)

Load factor $\alpha_3 = M_2 / M_2 \text{ max} = 0.08 / 0.8 = 0.1$

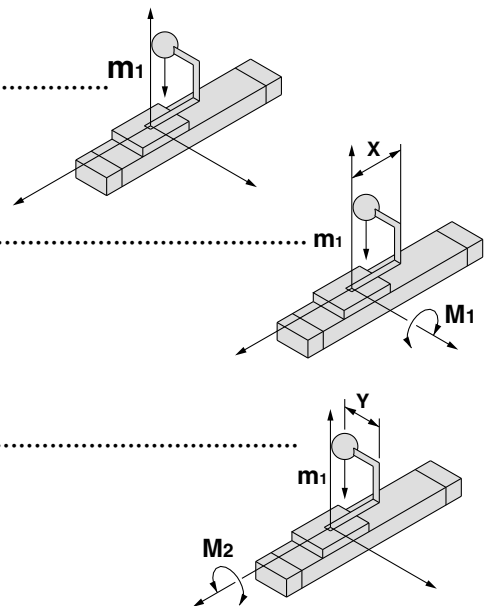

Calculation of Guide Load Factor

4 Calculation of Load Factor for Dynamic Moment

Equivalent load F_E at impact

$$F_E = 1.4 \nu a \times \delta \times m \times g = 1.4 \times 300 \times \frac{4}{100} \times 0.8 \times 9.8 = 131.7 \text{ (N)}$$

M_{1E} : Moment

$M_{1E \text{ max}}$ (from ④ of graph MY3A/ M_1 where $1.4 \nu a = 420 \text{ mm/s}$) = 2.85 (N·m)

$$M_{1E} = \frac{1}{3} \times F_E \times Z = \frac{1}{3} \times 131.7 \times 20 \times 10^{-3} = 0.88 \text{ (N·m)}$$

$$\text{Load factor } \alpha_4 = M_{1E} / M_{1E \text{ max}} = 0.88 / 2.85 = 0.31$$

M_{3E} : Moment

$M_{3E \text{ max}}$ (from ⑤ of graph MY3A/ M_3 where $1.4 \nu a = 420 \text{ mm/s}$) = 0.95 (N·m)

$$M_{3E} = \frac{1}{3} \times F_E \times Y = \frac{1}{3} \times 131.7 \times 10 \times 10^{-3} = 0.44 \text{ (N·m)}$$

$$\text{Load factor } \alpha_5 = M_{3E} / M_{3E \text{ max}} = 0.44 / 0.95 = 0.43$$

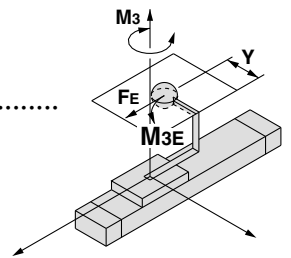
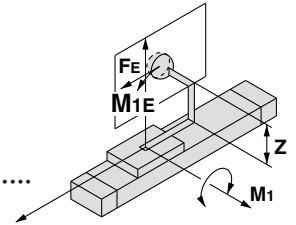

5 Sum and Examination of Guide Load Factors

$$\Sigma \alpha = \alpha_1 + \alpha_2 + \alpha_3 + \alpha_4 + \alpha_5 = 0.08 + 0.01 + 0.1 + 0.31 + 0.43 = 0.93 \leq 1$$

The above calculation is within the allowable value, and therefore the selected model can be used.

Select a shock absorber separately.

In an actual calculation, when the sum of guide load factors $\Sigma \alpha$ in the formula above is more than 1, consider decreasing the speed, increasing the bore size, or changing the product series.

Load Weight

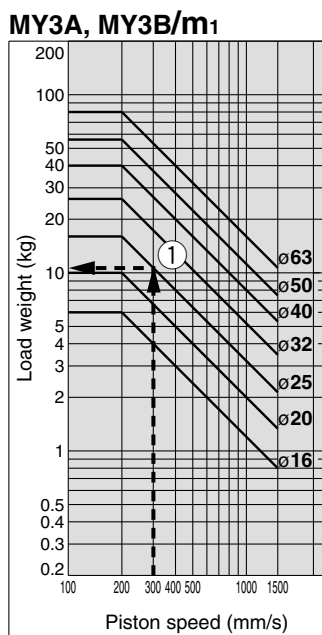

* Refer to page 27 for the MY3M.

Allowable Moment

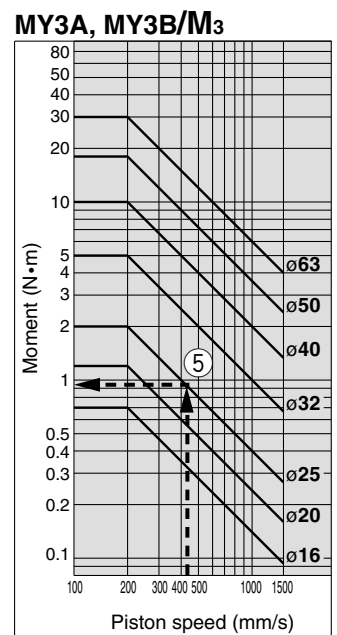
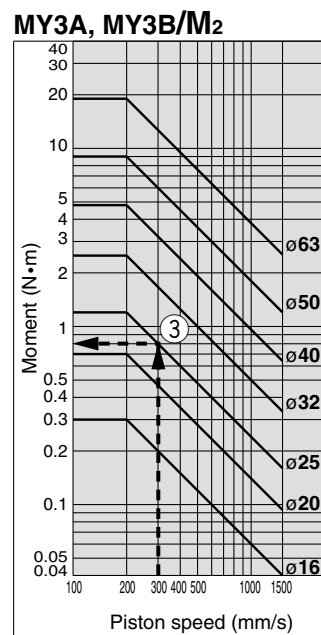
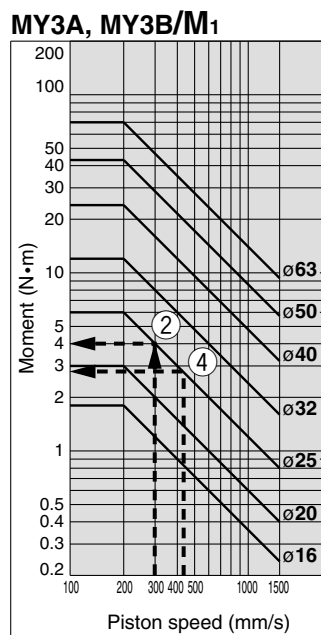

Mounting of Fitting and Speed Controller

When the stroke adjustment unit is used with MY3B and MY3M, the fittings mountable on the front or back port will be limited to those listed below.

In such cases, since **direct mount type speed controllers cannot be mounted**, use in-line type speed controllers. (Except MY3B40/50/63 and MY3M63)

Mounting (Mounting a male connector)

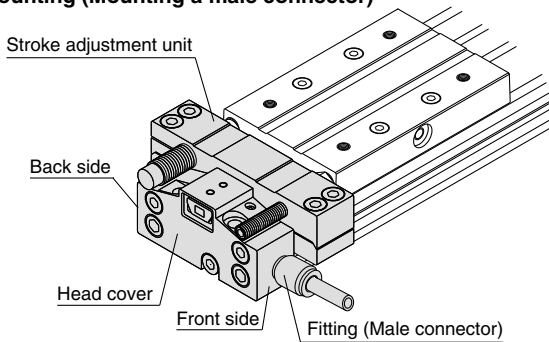

Refer to Best Pneumatics No. 6 for the details of fittings and speed controllers.

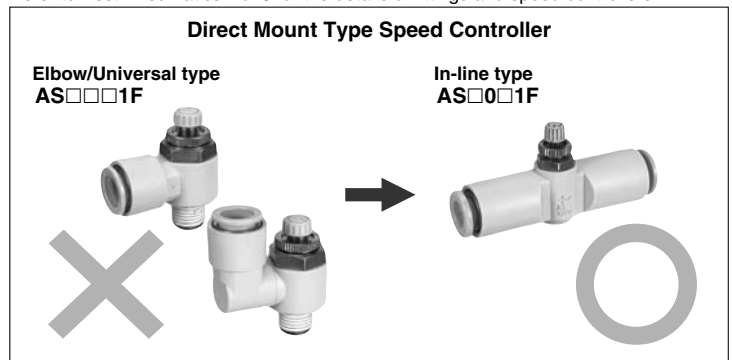

Cylinder model size	Connection thread	Applicable tubing O.D. (mm)	Fitting type	Fitting model		
MY3□16	M5	3.2	Male connector	KJH23-M5		
			Male elbow	KJL23-M5		
			Hexagon socket head male connector	KJS23-M5		
		4	Male connector	KQ2H23-M5		
			Male elbow	KQ2L23-M5		
			Male elbow	KJL04-M5		
			Male elbow	KQ2L04-M5		
			Hexagon socket head male connector	KQ2S04-M5		
			Hexagon socket head male connector	KQ2S04-M5		
6	Male elbow	KQ2L06-M5				
	3.2	Hexagon socket head male connector	KJS23-M5			
		Male connector	KQ2H23-M5			
Male elbow		KQ2L23-M5				
MY3□20	M5	4	Male connector	KQ2H04-M5		
			Male elbow	KQ2L04-M5		
			Hexagon socket head male connector	KQ2S04-M5		
		6	Male connector	KQ2H06-M5		
			Male elbow	KQ2L06-M5		
			Hexagon socket head male connector	KQ2S06-M5		
		MY3□25	Rc1/8	3.2	Male connector	KQ2H23-01S
					Male elbow	KQ2L23-01S
					Hexagon socket head male connector	KQ2S04-01S
4	Male connector			KJH04-01S		
	Male connector			KJS04-01S		
	Hexagon socket head male connector			KQ2H04-01S		
6	Male connector			KQ2L04-01S		
	Male elbow			KQ2L04-01S		
	Hexagon socket head male connector			KQ2S04-01S		
	Male connector			KJH06-01S		
	Male elbow			KJL06-01S		
	Hexagon socket head male connector			KJS06-01S		
8	Male connector	KQ2H06-01S				
	Male elbow	KQ2L06-01S				
	Hexagon socket head male connector	KQ2S06-01S				
	Male connector	KQ2H04-01S				
	Male elbow	KQ2L04-01S				
	Hexagon socket head male connector	KQ2S04-01S				
MY3□32	Rc1/8	4	Male connector	KQ2H04-01S		
			Male elbow	KQ2L04-01S		
			Hexagon socket head male connector	KQ2S04-01S		
		6	Male connector	KQ2H06-01S		
			Male elbow	KQ2L06-01S		
			Hexagon socket head male connector	KQ2S06-01S		
		8	Male connector	KQ2H08-01S		
			Male elbow	KQ2L08-01S		
			Hexagon socket head male connector	KQ2S08-01S		

Cylinder model size	Connection thread	Applicable tubing O.D. (mm)	Fitting type	Fitting model	
MY3□40	Rc1/4	4	Male connector	KQ2H04-02S	
			Male connector	KQ2H06-02S	
			Male elbow	KQ2L06-02S	
		8	Hexagon socket head male connector	KQ2S06-02S	
			Male connector	KQ2H08-02S	
			Male elbow	KQ2L08-02S	
			Hexagon socket head male connector	KQ2S08-02S	
			6	Male connector	KQ2H06-03S
				Male elbow	KQ2L06-03S
Hexagon socket head male connector	KQ2S06-03S				
MY3□50	Rc3/8	8	Male connector	KQ2H08-03S	
			Male elbow	KQ2L08-03S	
			Hexagon socket head male connector	KQ2S08-03S	
		10	Male connector	KQ2H10-03S	
			Male elbow	KQ2L10-03S	
			Hexagon socket head male connector	KQ2S10-03S	
		12	Male connector	KQ2H12-03S	
			Male elbow	KQ2L12-03S	
			Hexagon socket head male connector	KQ2S12-03S	
6	Male connector		KQ2H06-03S		
	Male elbow		KQ2L08-03S		
	Male connector		KQ2H10-03S		
MY3□63	Rc3/8	10	Male elbow	KQ2L10-03S	
			Hexagon socket head male connector	KQ2S10-03S	
			Male connector	KQ2H12-03S	
		12	Male elbow	KQ2L12-03S	
			Hexagon socket head male connector	KQ2S12-03S	
			Male elbow	KQ2L16-03S	



Series MY3

Specific Product Precautions

Be sure to read before handling.

Refer to back cover for the Safety Instructions, "Handling Precautions for SMC Products" (M-E03-3) and the Operation Manual for Actuators and Auto Switches Precautions.

Selection

⚠ Warning

1. When applying a load directly, set the design so that all the mounting threads on the slide table's upper surface are used.

Parts have been made smaller to achieve a compact size. If only some of the threads are used when mounting the load, the impact that results from the operation may cause extremely concentrated stress or disfiguration and may negatively affect operation. In worst cases the cylinder may be damaged, so please be careful.

⚠ Caution

1. Provide intermediate supports for long stroke cylinders.

Provide intermediate supports for cylinders with long strokes to prevent rod damage due to sagging of the rod, deflection of the tube, vibration and external loads. For detailed information, please refer to "Guide for Using Side Support" on pages 23 and 37.

2. For intermediate stops, use a dual-side pressure control circuit.

Since the mechanically jointed rodless cylinders have a unique seal structure, slight external leakage may occur. Controlling intermediate stops with a 3 position valve cannot hold the stopping position of the slide table (slider). The speed at the re-starting state also may not be controllable. Use the dual-side pressure control circuit with a PAB-connected 3 position valve for intermediate stops.

3. Cautions on less frequent operation

When the cylinder is used extremely infrequently, operation may be interrupted in order for anchoring and a change lubrication to be performed or service life may be reduced.

Mounting

⚠ Caution

1. At each end of the cylinder, secure a mounting surface with a 5 mm or longer area that contacts the lower side of the cylinder.

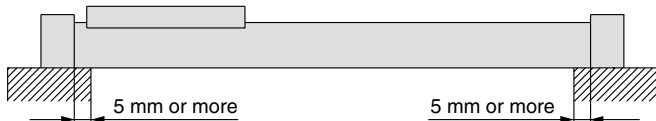

2. If the cylinder is mounted on the ceiling or wall under the condition where high load factors or impacts are expected, use side supports, in addition to the fixing bolts on the head cover, to support both ends of the cylinder tube.

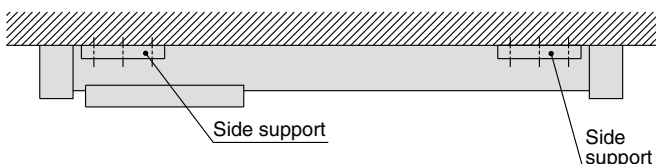

Mounting

⚠ Caution

3. Do not mount a slide table on the fixed equipment surface.

It may cause damage or malfunctions since an excessive load is applied to the bearing.

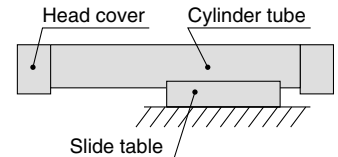

Mounting with a slide table (slider)

4. Consult with SMC when mounting in a cantilevered way.

Since the cylinder body deflects, it may cause malfunctions. Please consult with SMC when using it this way.

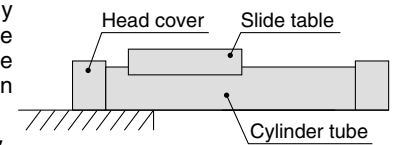

Mounting in a cantilevered way

5. Do not mount cylinders as they are twisted.

When mounting, be sure for a cylinder tube not to be twisted. The flatness of the mounting surface is not appropriate, the cylinder tube is twisted, which may cause air leakage due to the detachment of a seal belt, damage a dust seal band, and cause malfunctions.

6. Do not generate negative pressure in the cylinder tube.

Take precautions under operating conditions in which negative pressure is generated inside the cylinder by external forces or inertial forces. Air leakage may occur due to separation of the seal belt. Do not generate negative pressure in the cylinder by forcibly moving it with an external force during the trial operation or dropping it with self-weight under the non-pressure state, etc. When the negative pressure is generated, slowly move the cylinder by hand and move the stroke back and forth. After doing so, if air leakage still occurs, please consult with SMC.

Operating Environment

⚠ Warning

1. Avoid use in environments where a cylinder will come in contact with coolants, cutting oil, droplet of water, adhesive matter, or dust, etc. Also avoid operation with compressed air that contains drainage or foreign matter, etc.

- Foreign matter or liquids on the cylinder's interior or exterior can wash out the lubricating grease, which can lead to deterioration and damage of dust seal band and seal materials, causing a danger of malfunction.

When operating in locations with exposure to water and oil drops, or in dusty locations, provide protection such as a cover to prevent direct contact with the cylinder, or mount so that the dust seal band surface faces downward, and operate with clean compressed air.

2. The product is not designed for clean room usage.

If clean room usage is considered, please consult with SMC.

Series MY3A

**Basic, short type
(Rubber bumper)**

ø16, ø20, ø25, ø32, ø40, ø50, ø63



Series MY3B

**Basic, standard type
(Air cushion)**

ø16, ø20, ø25, ø32, ø40, ø50, ø63

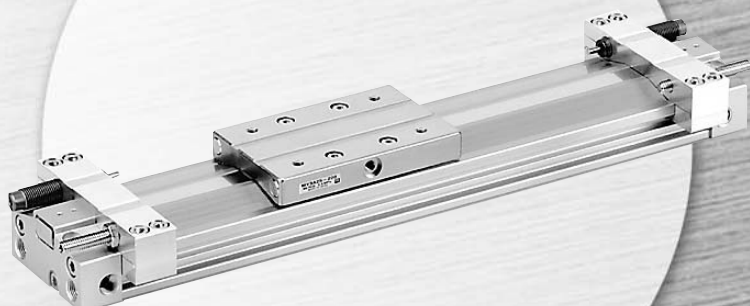

Series MY3A/3B Model Selection

The following are steps for selecting the MY3 series which is best suited to your application.

Calculation of Guide Load Factor

1 Operating Conditions

- Cylinder MY3B25-500
- Average operating speed v_a 300 mm/s
- Mounting direction Vertical mounting
- Cushion Shock absorber ($\delta=1/100$)

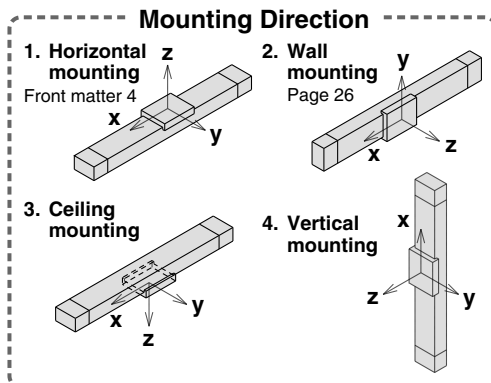
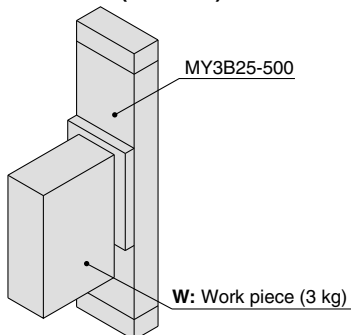

Refer to the pages mentioned above for actual examples of calculation for each orientation.
* For ceiling mounting, refer to Best Pneumatics No. 2, page 998.

2 Load Blocking

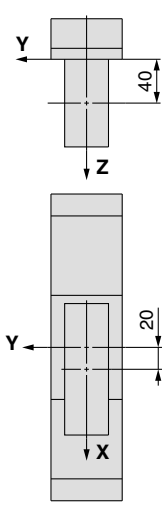

Work Piece Weight and Center of Gravity

Work piece no.	Weight (m)	Center of gravity		
		X-axis	Y-axis	Z-axis
W	3 kg	20 mm	0 mm	40 mm

3 Calculation of Load Factor for Static Load

m : Weight

m is a weight moveable by thrust. Use 0.3 to 0.7 times the thrust
(differs depending on the operating speed) as a guide for actual use.

M₁: Moment

M₁ max (from ① of graph MY3A/3B/M₁) = 4 (N·m)

M₁ = **m** X **g** x **Z** = 3 x 9.8 x 0.04 x 10⁻³ = 1.18 (N·m)

Load factor $\alpha_1 = M_1 / M_2 \text{ max} = 1.18 / 4 = 0.29$

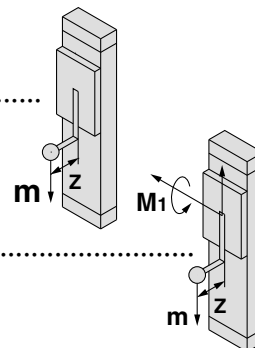

Calculation of Guide Load Factor

4 Calculation of Load Factor for Dynamic Moment

Equivalent load F_E at impact

$$F_E = 1.4 \nu a \times \delta \times m \times g = 1.4 \times 300 \times \frac{1}{100} \times 3 \times 9.8 = 123.56 \text{ (N)}$$

M_{1E} : Moment

$M_{1E \text{ max}}$ (from ② of graph MY3A/3B/ M_1 where $1.4 \nu a = 420 \text{ mm/s}$) = 2.86 (N·m)

$$M_{1E} = \frac{1}{3} \times F_E \times Z = \frac{1}{3} \times 123.56 \times 40 \times 10^{-3} = 1.65 \text{ (N·m)}$$

$$\text{Load factor } \alpha_2 = M_{1E} / M_{1E \text{ max}} = 1.65 / 2.86 = 0.58$$

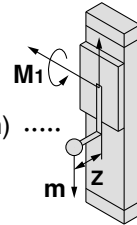

5 Sum and Examination of Guide Load Factors

$$\Sigma \alpha = \alpha_1 + \alpha_2 = 0.87 \leq 1$$

The above calculation is within the allowable value, and therefore the selected model can be used. Select a shock absorber separately.

In an actual calculation, when the sum of guide load factors $\Sigma \alpha$ in the formula above is more than 1, consider decreasing the speed, increasing the bore size, or changing the product series. Calculating the above formula is easy with the [SMC Pneumatics CAD System].

Allowable Moment

MY3A, MY3B/ M_1

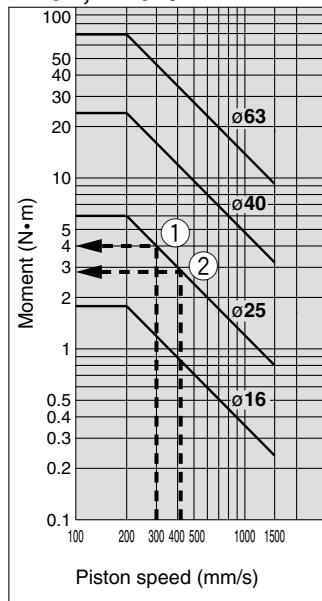

Series MY3A/3B

Maximum Allowable Moment / Maximum Allowable Load

Series	Bore size (mm)	Maximum Allowable Moment (N·m)			Maximum Allowable Load (kg)		
		M ₁	M ₂	M ₃	m ₁	m ₂	m ₃
MY3A MY3B	16	1.8	0.3	0.7	6	3	1.5
	20	3	0.7	1.2	10	4.3	2.4
	25	6	1.2	2	16	6	4
	32	12	2.5	5	26	8.5	6.7
	40	24	4.8	10	40	12	10
	50	43	9	18	56	17	14
	63	70	19	30	80	24	20

The above values are the maximum allowable values for moment and load. Refer to each graph regarding the maximum allowable moment and maximum allowable load for a particular piston speed.

Types of Moment and Load Weight Applied to Rodless Cylinders

Multiple moments may be generated depending on the mounting orientation, load and position of the center of gravity.

Coordinates and Moments

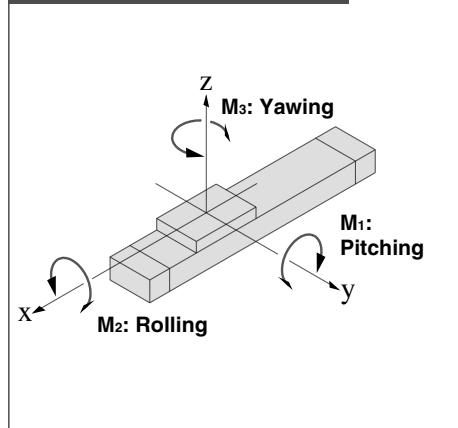

Load Weight and Static Moment

Mounting direction	Horizontal	Ceiling	Wall	Vertical
Static load m	m ₁	m ₂	m ₃	m ₄ (Note)
Static moment	M ₁	m ₁ × g × X	m ₂ × g × X	—
	M ₂	m ₁ × g × Y	m ₂ × g × Y	m ₃ × g × Z
	M ₃	—	—	m ₃ × g × X

Note) M₄ is a weight movable by thrust. Use 0.3 to 0.7 times the thrust (differs depending on the operating speed) as a guide for actual use.

g: Gravitational acceleration

Dynamic Moment

Mounting direction	Horizontal	Ceiling	Wall	Vertical
Dynamic load FE	1.4va × δ × m _n × g			
Dynamic moment	M _{1E}	$\frac{1}{3} \times FE \times Z$		
	M _{2E}	Dynamic moment M _{2E} will not be generated.		
	M _{3E}	$\frac{1}{3} \times FE \times Y$		

Note) Regardless of the mounting orientation, dynamic moment is calculated with the formulae above.

g: Gravitational acceleration
va: Average speed
δ: Bumper coefficient

Select the moment from within the range of operating limits shown in the graphs. Note that the maximum allowable load value may sometimes be exceeded even within the operating limits shown in the graphs. Therefore, also check the allowable load for the selected conditions.

Maximum Allowable Moment /

MY3A, MY3B/M₁

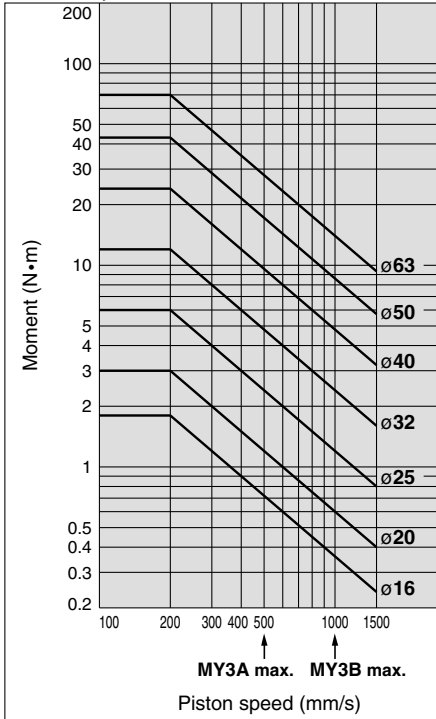

MY3A, MY3B/M₂

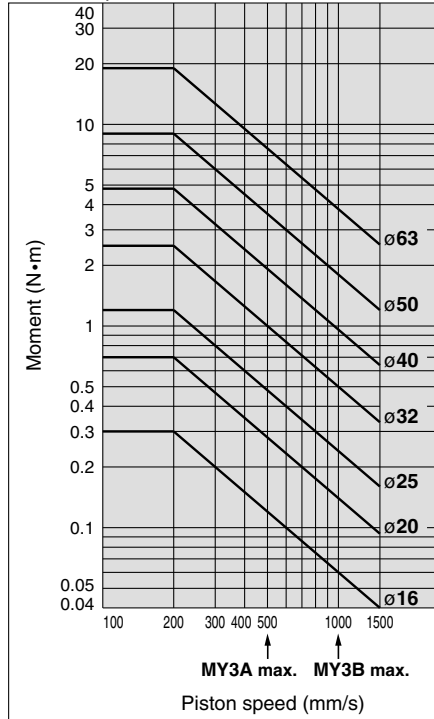

MY3A, MY3B/M₃

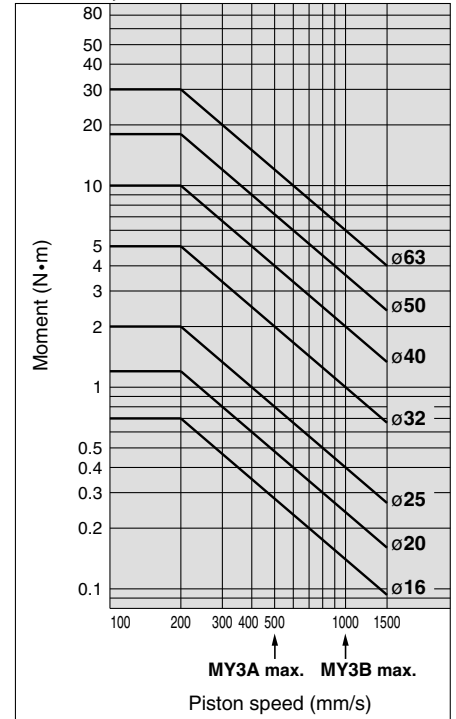

Select the moment from within the range of operating limits shown in the graphs. Note that the maximum allowable load value may sometimes be exceeded even within the operating limits shown in the graphs. Therefore, also check the allowable load for the selected conditions.

Maximum Allowable Load /

MY3A, MY3B/m₁

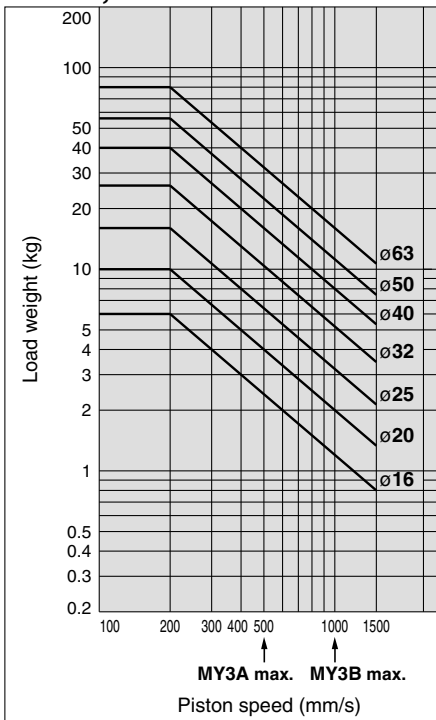

MY3A, MY3B/m₂

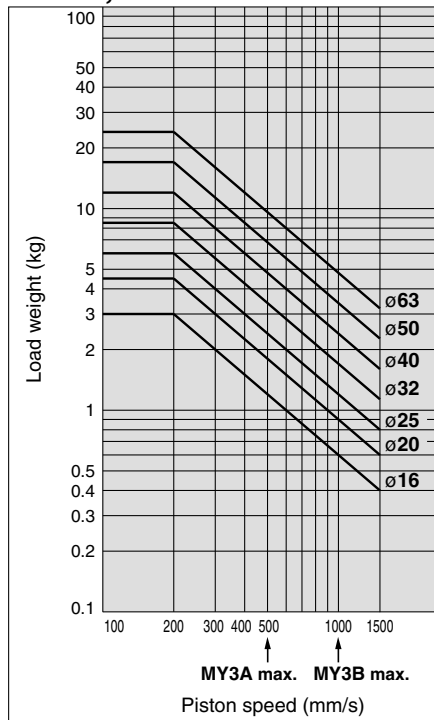

MY3A, MY3B/m₃

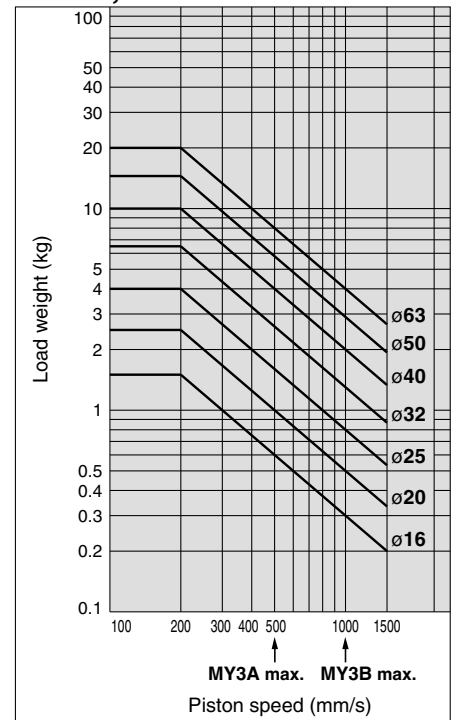

Series MY3A/3B

Cushion Capacity

Absorption Capacity of Rubber Bumper (MY3A)

MY3A16

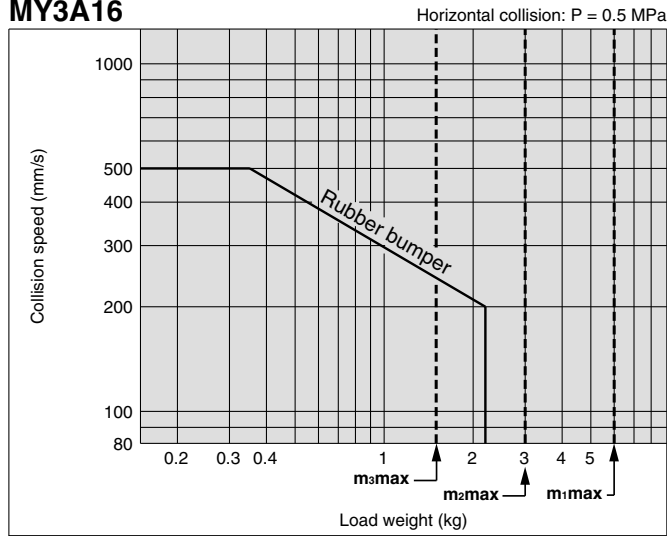

MY3A20

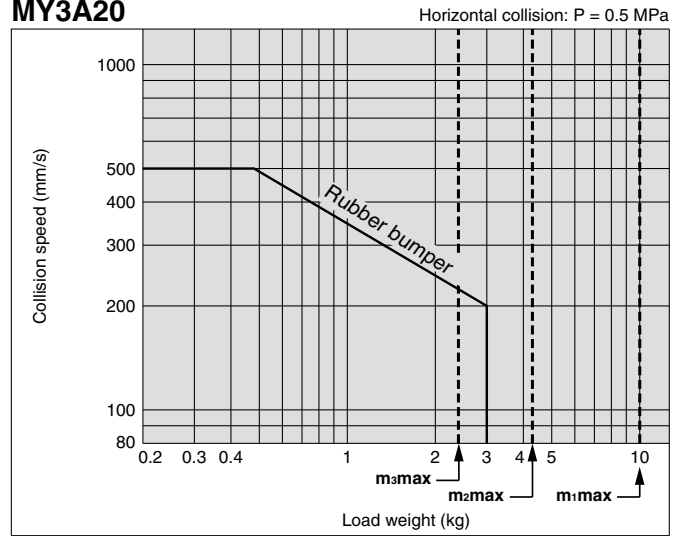

MY3A25

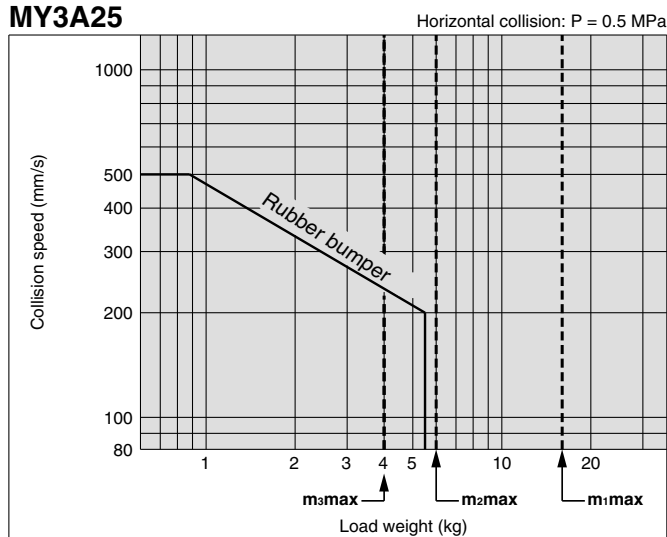

MY3A32

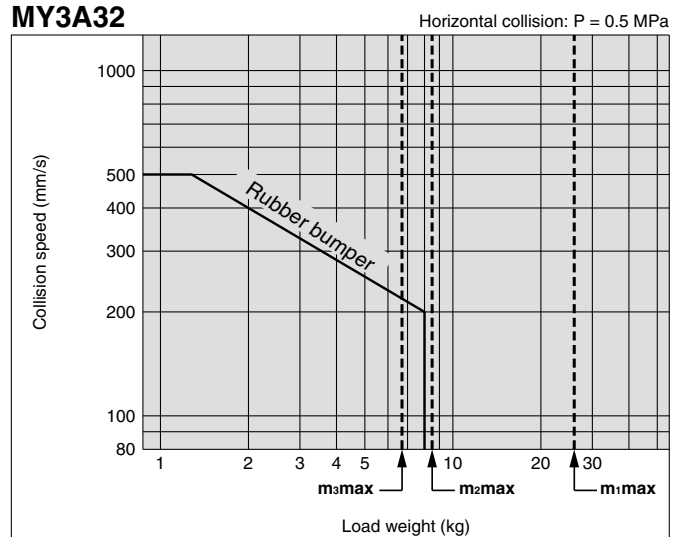

Rubber Bumper Displacement (Additional Stroke due to Pressure on Each Side)

The stop position of the built-in rubber bumper of the MY3A series varies depending on the operating pressure. For alignment at the stroke end, find the guideline for the stroke end position in operation as follows. Find the incremental displacement at the operating pressure in the graph and add it to the stroke end position at no pressurization. If positioning accuracy is required for the stop position at the stroke end, consider installing an external positioning mechanism or switching to the air cushion type (MY3B).

MY3A16

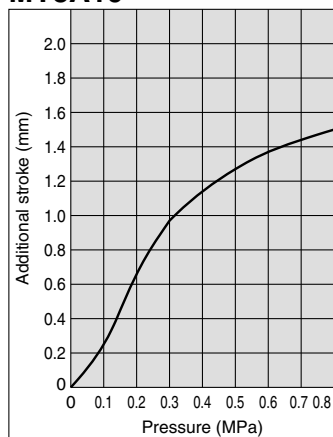

Additional Stroke due to Pressure on Each Side (MY3A16)

MY3A20

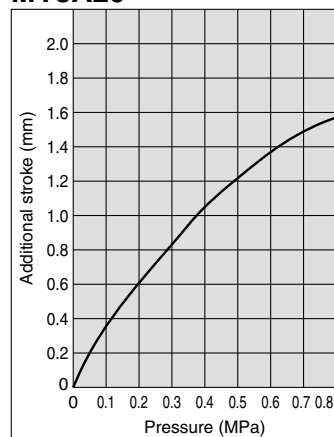

Additional Stroke due to Pressure on Each Side (MY3A20)

MY3A25

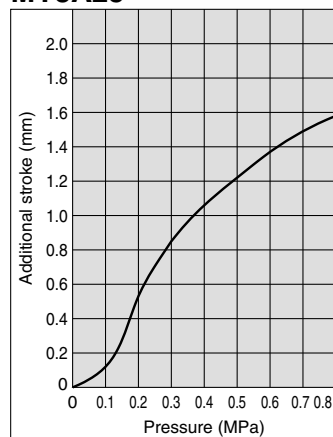

Additional Stroke due to Pressure on Each Side (MY3A25)

MY3A32

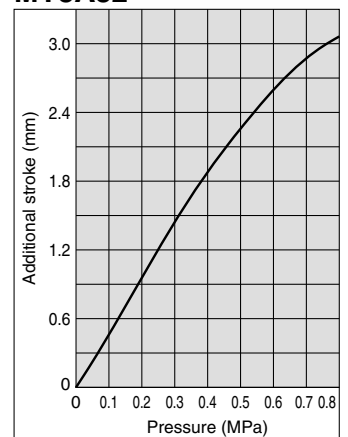

Additional Stroke due to Pressure on Each Side (MY3A32)

MY3A40

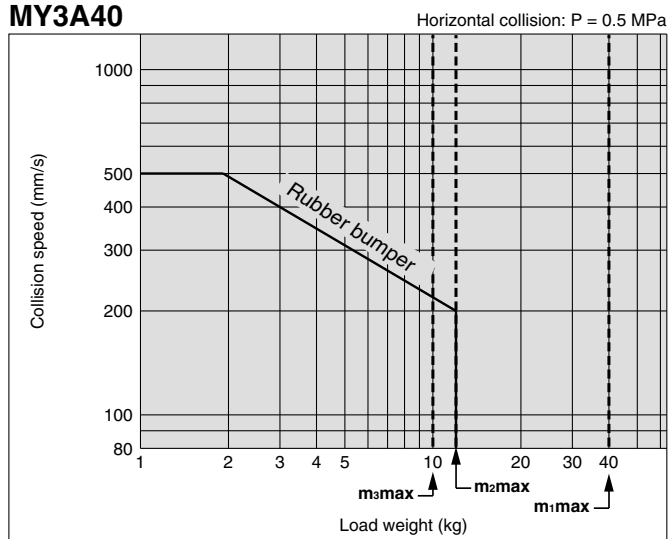

MY3A50

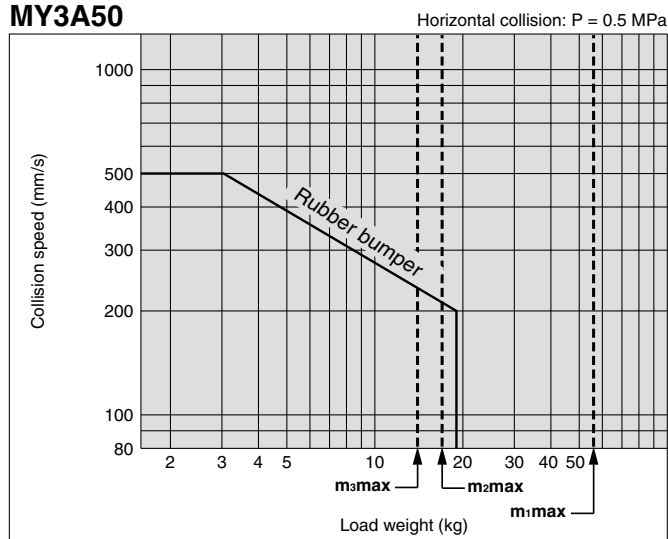

MY3A63

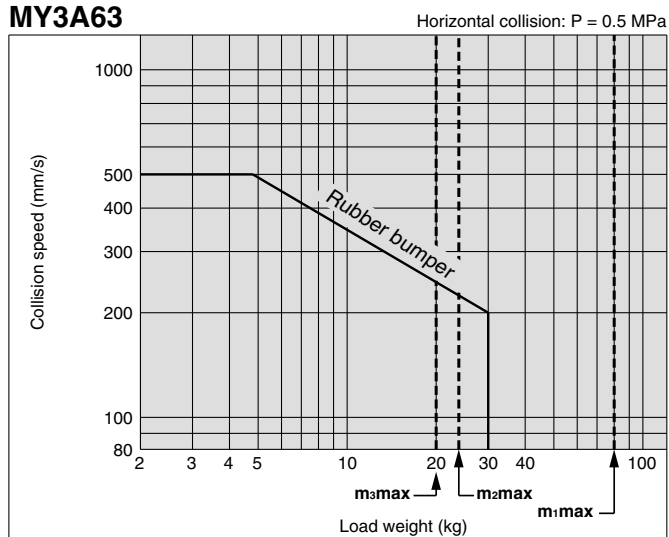

MY3A40

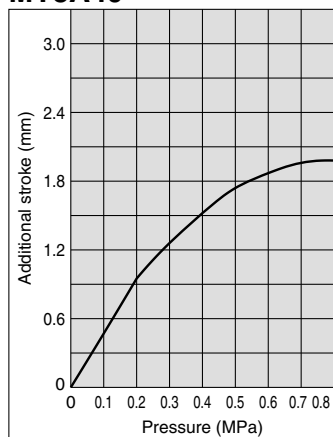

Additional Stroke due to Pressure on Each Side (MY3A40)

MY3A50

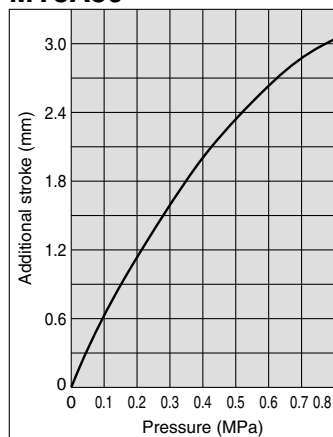

Additional Stroke due to Pressure on Each Side (MY3A50)

MY3A63

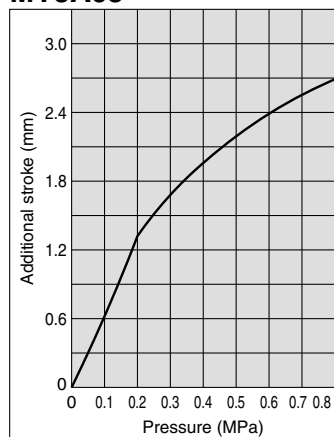

Additional Stroke due to Pressure on Each Side (MY3A63)

Series MY3A/3B

Cushion Capacity

Absorption Capacity of Air Cushion and Stroke Adjustment Unit (MY3B)

MY3B16

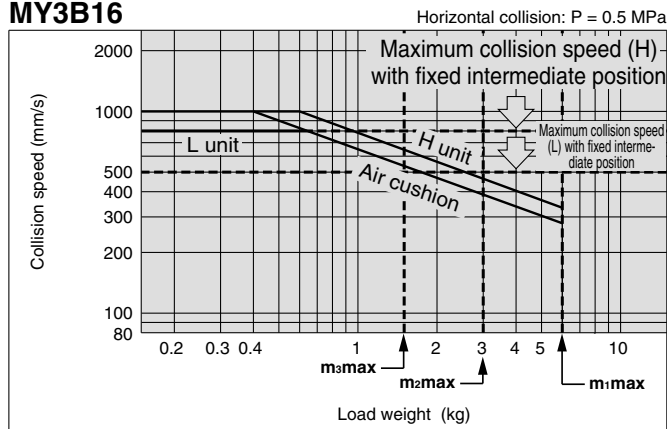

MY3B20

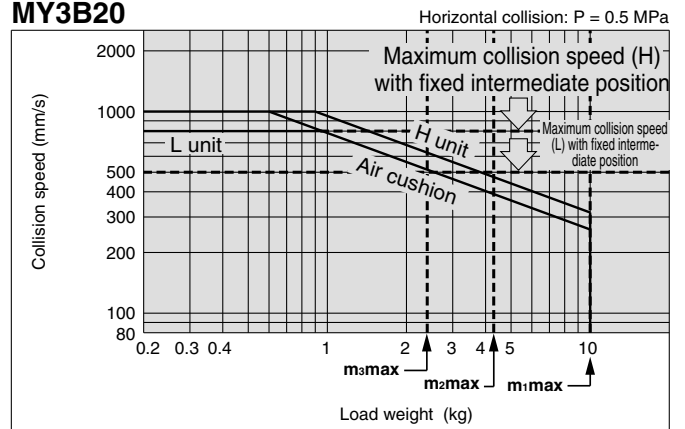

MY3B25

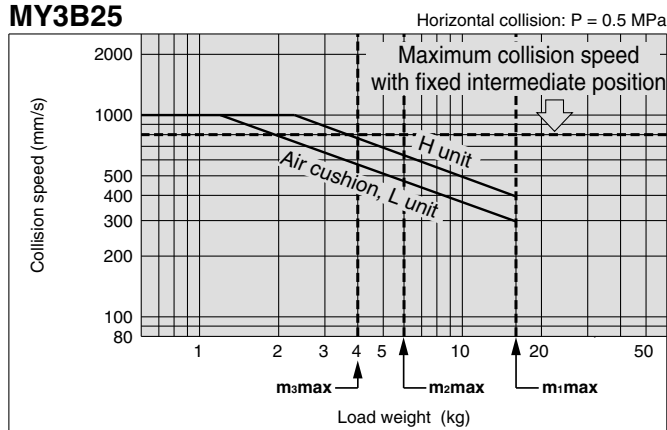

MY3B32

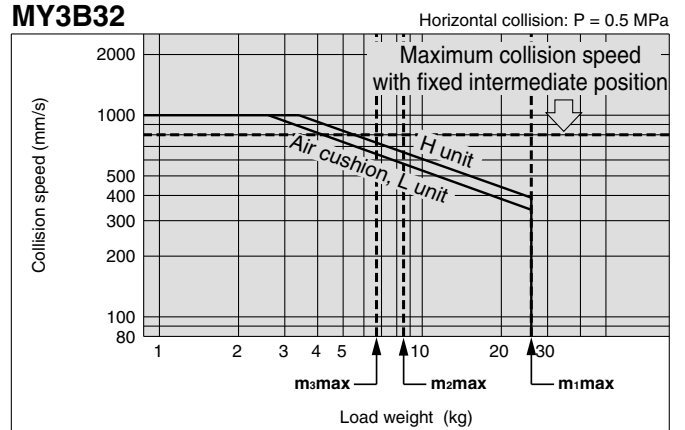

MY3B40

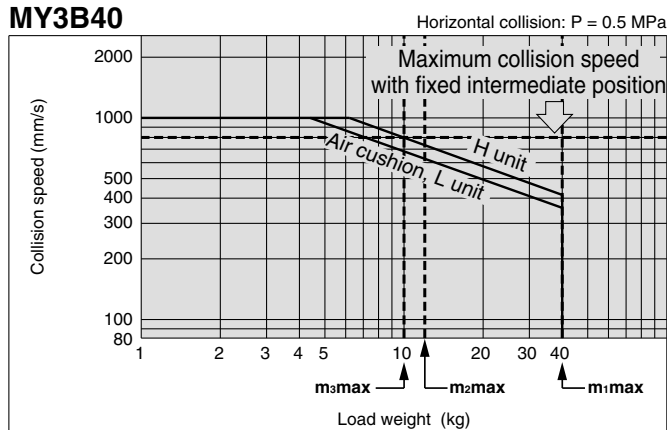

MY3B50

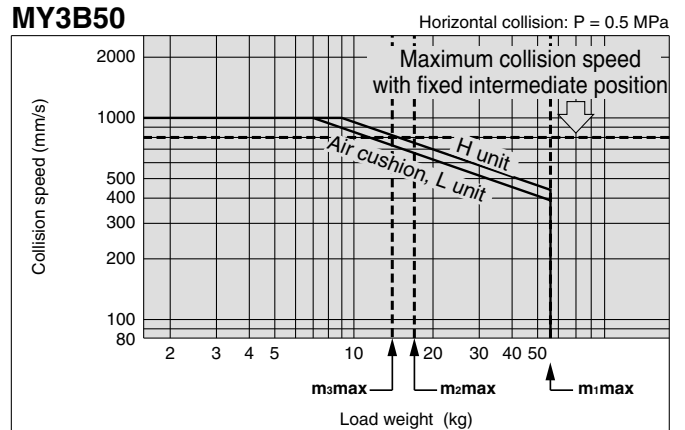

MY3B63

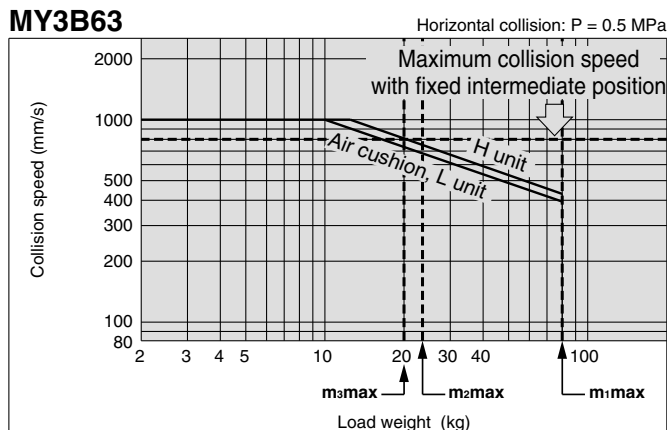

Air Cushion Stroke

Unit: mm

Bore size (mm)	Cushion stroke
16	13
20	16
25	18
32	22
40	25
50	28
63	30

Calculation of Absorbed Energy for Stroke Adjustment Unit with Built-in Shock Absorber Unit: N·m

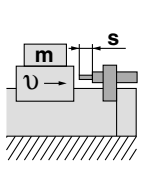
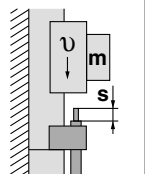
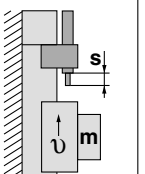
Type of collision	Horizontal	Vertical (downward)	Vertical (upward)
			
Kinetic energy E ₁	$\frac{1}{2} m \cdot v^2$		
Thrust energy E ₂	F·s	F·s + m·g·s	F·s - m·g·s
Absorbed energy E	E ₁ + E ₂		

Stroke Adjustment Unit Fine Stroke Adjustment Range Unit: mm

Bore size (mm)	Fine stroke adjustment range
16, 20	0 to -10
25, 32	0 to -12
40, 50	0 to -16
63	0 to -24

Note) The maximum operating speed will differ when the stroke adjustment unit is used outside the maximum fine stroke adjustment range (with reference to the fixed stroke end), such as at a fixed intermediate position (X416, X417). (Refer to the graph on page 8.)

Symbols

v : Speed of impacting object (m/s)

m : Weight of impacting object (kg)

F : Cylinder thrust (N)

g : Gravitational acceleration (9.8 m/s²)

s : Shock absorber stroke (m)

Note) The speed of the impacting object is measured at the time of collision with the shock absorber.

Note) With an operating pressure of 0.6 MPa or larger, the use of a cushion or an external shock absorber conforming to the conditions on pages 10 and 11 is recommended.

Stroke Adjustment

<Stroke adjustment of the adjustment bolt>

Loosen the lock nut for the adjustment bolt, adjust the stroke on the head cover side with a hexagon wrench, and secure with a lock nut.

<Stroke adjustment of the shock absorber: MY3B>

Loosen the two unit fixing bolts on the shock absorber side and rotate the shock absorber for stroke adjustment. Tighten the unit fixing bolts equally to secure the shock absorber. Use caution not to overtighten the fixing bolts.

(Refer to "MY3B Stroke Adjustment Unit Tightening Torque for Fixing Bolts.")

MY3B Stroke Adjustment Unit Tightening Torque for Fixing Bolts

Unit: N·m

Bore size (mm)	Unit	Tightening torque
16, 20	L	0.7
	H	
25, 32	L	3.5
	H	
40, 50	L	13.8
	H	
63	L	27.5
	H	

⚠ Caution

1. Use caution not to have your hands caught in the unit.

When using a cylinder with stroke adjustment unit, the space between the slide table (slider) and the stroke adjustment unit is very narrow. Care should be taken to avoid the danger of hands being caught in this small space. Install a protective cover to prevent the risk of accidents to the human body.

2. The stroke adjustment unit may interfere with the mounting bolt when mounting the cylinder on the equipment.

Loosen the unit fixing bolt and dislocate the stroke adjustment unit before mounting the cylinder. After fixing the cylinder, move the stroke adjustment unit back to the desired location and tighten the unit fixing bolt.

Use caution not to overtighten the fixing bolts.

(Refer to "MY3B Stroke Adjustment Unit Tightening Torque for Fixing Bolts".)

⚠ Caution

3. Use an external guide for the MY3B stroke adjustment unit.

If a stroke adjustment unit is used where a load is directly applied, the collision reaction may cause damage to the cylinder.

4. Conduct stroke adjustment with an adjustment bolt as follows:

The adjustment bolt should be secured on the same surface as the shock absorber after stroke adjustment.

If the stopper surface of the shock absorber and the end surface of the adjustment bolt are not on the same level, it may result in an unstable stop position of the slide table or reduced durability.

5. Securing the unit body

<MY3B>

Adjustment bolt lock nut

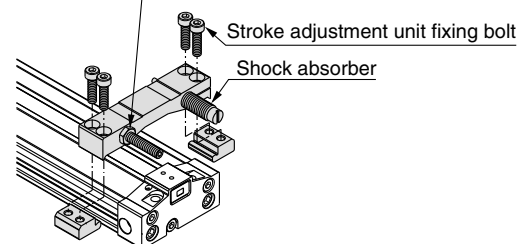

Tighten the four unit fixing bolts equally to secure the unit body.

6. Do not fix and use the stroke adjustment unit at an intermediate position (MY3B).

If the stroke adjustment unit is fixed at an intermediate position, an error may result depending on the collision energy. In that case, the use of the holder mounting bracket for adjustment is recommended. It is provided with the "-X416" or "-X417" made-to-order specification.

(Refer to "MY3B Stroke Adjustment Unit Tightening Torque for Fixing Bolts".)

If the stroke adjustment unit is fixed at an intermediate position, the energy absorption capacity may be different. For this reason, refer to the maximum absorbed energy listed above, and use the adjustment unit within the allowable absorption capacity.

Series MY3A/3B

External Shock Absorber Selection

When the positioning of the stop position is necessary or the absorption capacity of the built-in cushion is not sufficient, refer to the selection procedure below and consider the installation of an external shock absorber.

Selection Confirmation Items with Use of External Shock Absorber

① When the cylinder alone is used.

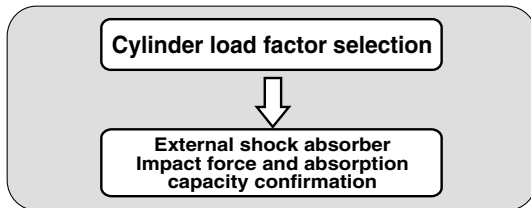

Allowable impact force with use of external shock absorber

MY3□16

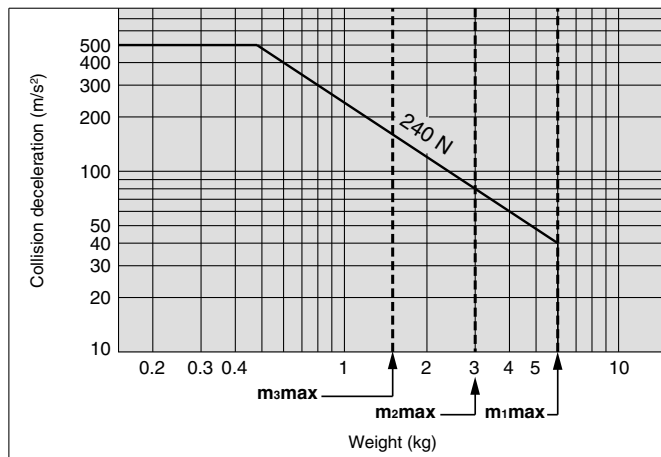

MY3□20

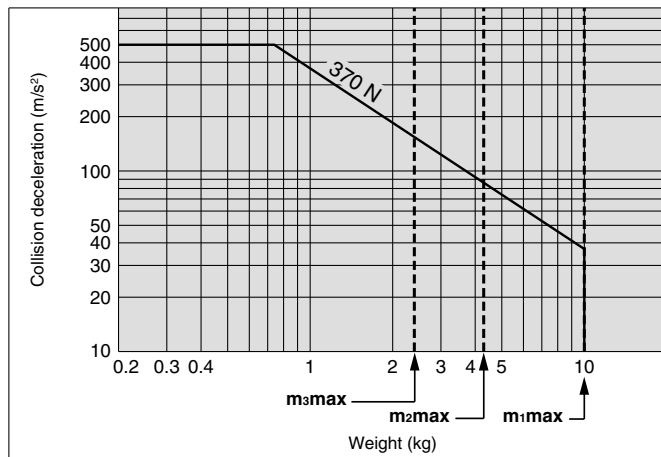

MY3□25

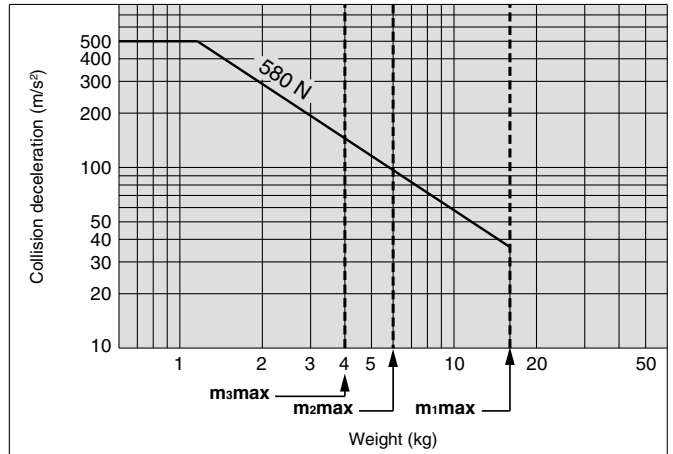

MY3□32

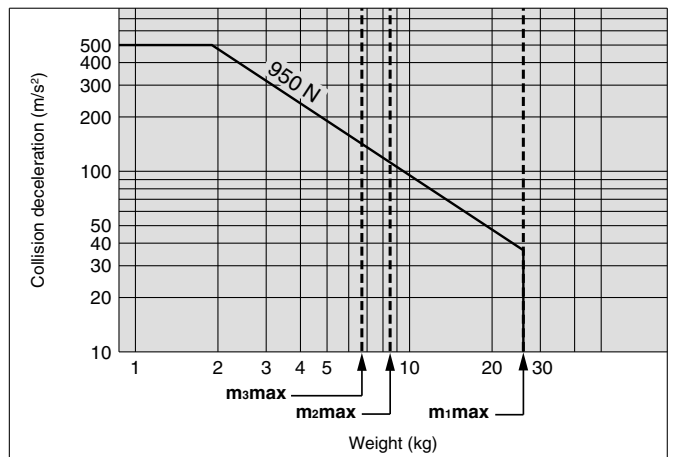

MY3□40

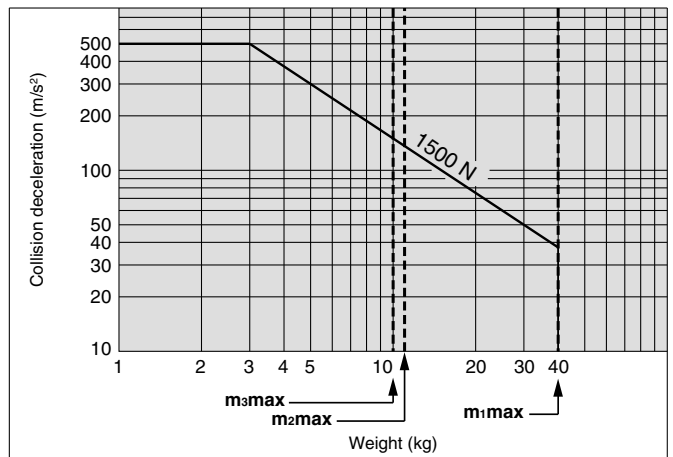

MY3□50

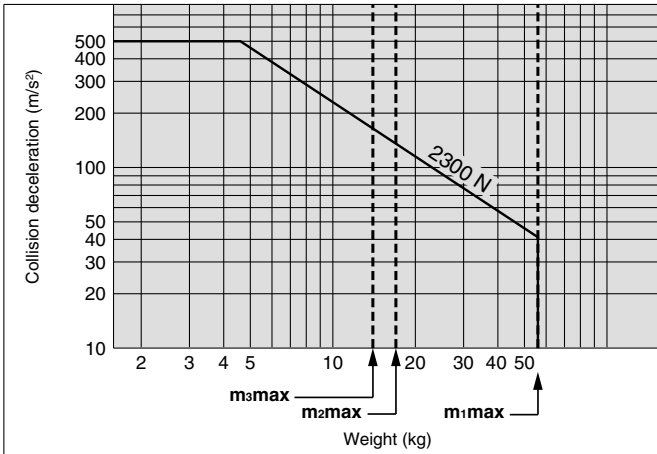

MY3□63

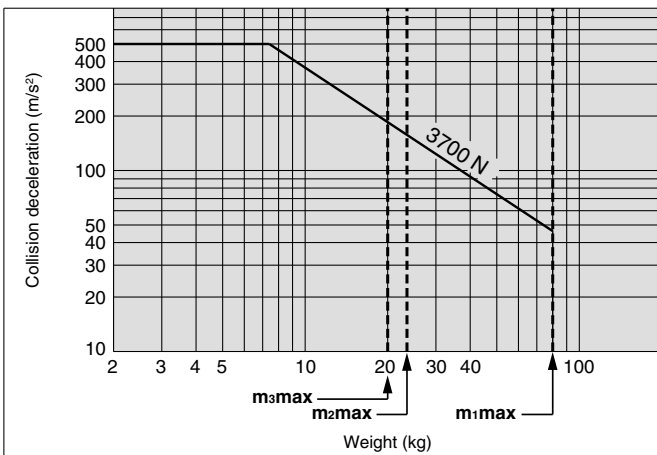

② When the external guide is used.

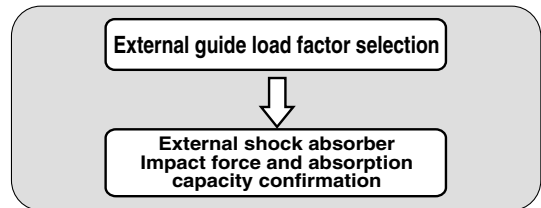

Piston Speed with Use of External Shock Absorber

Bore size (mm)	16	20	25	32	40	50	63
MY3A	80 to 1500 mm/s						
MY3B							

An external shock absorber can be used within the above piston speed range. In conjunction with the absorption capacity selection, however, also confirm the conditions which make the shock absorber collision impact force to stay within the allowable range in the graph.

Use of an external shock absorber with conditions exceeding the allowable range may damage the cylinder.

To confirm the collision impact force of the shock absorber, first find the impact force or acceleration under the operating conditions using the selection information or selection software provided by the manufacturer and then, refer to the graph.

(The selection should allow a sufficient margin because the value calculated by the selection software involves an error with reference to the actual value.)

Example of Recommended Use of the External Shock Absorber

MY3□	$\begin{pmatrix} 16 \\ 20 \end{pmatrix}$	⇒ RB-OEM0.25M
MY3□	$\begin{pmatrix} 25 \\ 32 \end{pmatrix}$	⇒ RB-OEM0.5M
MY3□	$\begin{pmatrix} 40 \\ 50 \end{pmatrix}$	⇒ RB-OEM1.0MF
MY3□	63	⇒ RB-OEM1.5M x 1

Mechanically Jointed Rodless Cylinder/Basic Type

Series MY3A/3B

∅16, ∅20, ∅25, ∅32, ∅40, ∅50, ∅63

How to Order

Basic MY3 **B** **16** - **300** **HL** - **M9BW** -

Type

A	Short type (Rubber bumper)
B	Standard type (Air cushion)

Cylinder bore size

16	16 mm
20	20 mm
25	25 mm
32	32 mm
40	40 mm
50	50 mm
63	63 mm

Port thread type

Symbol	Type	Bore size
Nil	M5	∅16, ∅20
	Rc	
TN	NPT	∅25, ∅32, ∅40
TF	G	∅50, ∅63

Number of auto switches

Nil	2 pcs.
S	1 pc.
n	"n" pcs.

Auto switch

Nil	Without auto switch (Built-in magnet)
-----	---------------------------------------

* Refer to the table below for auto switch model numbers.

Stroke adjustment unit

Symbol	Stroke adjustment unit	Applicable model
Nil	Without adjustment unit	MY3A, MY3B
L	With shock absorbers for low load on both sides	MY3B
H	With shock absorbers for high load on both sides	
LS	With a shock absorber for low load on left side	
SL	With a shock absorber for low load on right side	
HS	With a shock absorber for high load on left side	
SH	With a shock absorber for high load on right side	
LH	With L unit on left side and H unit on right side	
HL	With H unit on left side and L unit on right side	

Stroke

* Refer to "Standard Stroke" table on page 14 for further information.

Stroke adjustment unit appearance and mounting direction in case of the MY3B

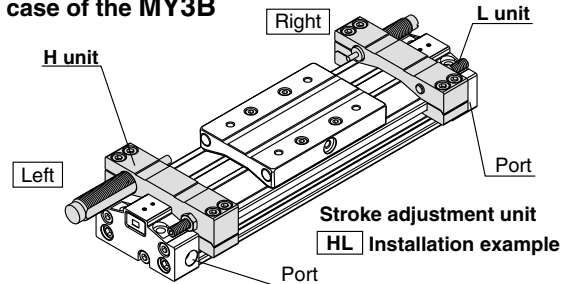

Applicable Auto Switches/ Refer to Best Pneumatics No. 2, pages 1263 to 1371 for further information on auto switches.

Type	Special function	Electrical entry	Indicator light	Wiring (Output)	Load voltage		Auto switch model		Lead wire length (m)				Pre-wired connector	Applicable load					
					DC	AC	Perpendicular	In-line	0.5 (Nil)	1 (M)	3 (L)	5 (Z)							
Solid state switch	—	Grommet	Yes	3-wire (NPN)	24 V	5 V, 12 V	—	M9NV	M9N	●	●	●	○	—	IC circuit	Relay, PLC			
				3-wire (PNP)				M9PV	M9P	●	●	●	○						
				2-wire				M9BV	M9B	●	●	●	○						
				3-wire (NPN)				M9NWV	M9NW	●	●	●	○						
				3-wire (PNP)				M9PWV	M9PW	●	●	●	○						
				2-wire				M9BWV	M9BW	●	●	●	○						
Reed switch	—	Grommet	Yes	3-wire (NPN equiv.)	24 V	5 V	—	A96V	A96	●	—	●	—	—	IC circuit	—			
				2-wire				100 V	A93V	A93	●	—	●				—	—	Relay, PLC
								100 V or less	A90V	A90	●	—	●				—		

* Lead wire length symbols: 0.5 m Nil (Example) M9NW
 1 m M (Example) M9NWM
 3 m L (Example) M9NWL
 5 m Z (Example) M9NWZ

* Solid state auto switches marked with a "○" symbol are produced upon receipt of order.

* In addition to the models in the above table, there are some other auto switches that are applicable. For more information, please refer to page 38.

* Refer to Best Pneumatics No. 2, pages 1328 to 1329 for the details of auto switches with a pre-wired connector.

* Auto switches are shipped together, but not assembled.

Series MY3A/3B

MY3A (Rubber bumper)



MY3B (Air cushion)

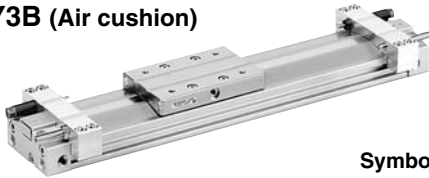

Symbol

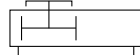

Specifications

Bore size (mm)	16, 20	25, 32	40	50, 63
Fluid	Air			
Action	Double acting			
Operating pressure range	0.15 to 0.8 MPa			
Proof pressure	1.2 MPa			
Ambient and fluid temperature	5 to 60°C			
Cushion	Rubber bumper (MY3A) / Air cushion (MY3B)			
Lubrication	Not required (Non-lube)			
Stroke length tolerance	1000 mm or less $^{+1.8}_0$, From 1001 mm $^{+2.8}_0$ (Note)			
Port size (Rc, NPT, G)	M5 x 0.8	1/8	1/4	3/8

Note) The tolerance of the MY3A is a value with no pressurization. When a rubber bumper is used, the stroke of the MY3A varies according to the operating pressure. To find the stroke length tolerance at each operating pressure, double the additional stroke due to pressure on each side (pages 6 and 7) and add it.

Piston Speed

Bore size (mm)	16	20	25	32	40	50	63
Without stroke adjustment unit (MY3A)	80 to 500 mm/s						
Without stroke adjustment unit (MY3B)	80 to 1000 mm/s						
Stroke adjustment unit (L and H unit/MY3B)	80 to 1000 mm/s ($\phi 16$, $\phi 20$ L unit: 80 to 800 mm/s)						
* External shock absorber (low reaction type)	80 to 1500 mm/s						

- * Refer to "External Shock Absorber Selection" on pages 10 and 11. When the RB series is used, operate at a piston speed that will not exceed the absorption capacity of the air cushion and stroke adjustment unit.
- * Because of its structure, the fluctuation of this cylinder's operating speed is greater than rod type cylinders. For applications that require constant speed, select an applicable equipment for the level of demand.

Standard Stroke

Bore size (mm)	Standard stroke (mm)*	Max. manufacturable stroke (mm)
16, 20, 25 32, 40, 50 63	100, 200, 300, 400, 500, 600 700, 800, 900, 1000, 1200 1400, 1600, 1800, 2000	3000

* Strokes are manufacturable in 1 mm increments, up to the maximum stroke. However, when exceeding 2000 mm stroke, add "-XB11" to the end of the model number. Refer to "Made to Order" on page 40.

Stroke Adjustment Unit Specifications

Bore size (mm)	16, 20		25, 32		40, 50		63	
Unit symbol	L	H	L	H	L	H	L	H
Shock absorber model	RB0806	RB1007	RB1007	RB1412	RB1412	RB2015	RB2015	RB2725
Shock absorber soft type Series RJ (-XB22) model	RJ0806H	RJ1007H	RJ1007H	RJ1412H	RJ1412H	—	—	—
Fine stroke adjustment range (mm)	0 to -10		0 to -12		0 to -16		0 to -24	



Made to Order
(For details, refer to pages 40 to 44.)

Symbol	Specifications
-XB11	Long stroke type
-XB22	Shock absorber soft type Series RJ type
-X168	Helical insert thread
-X416	Holder mounting bracket I
-X417	Holder mounting bracket II

Shock Absorber Specifications

Model	RB 0806	RB 1007	RB 1412	RB 2015	RB 2725	
Max. energy absorption (J)	0.84	2.4	10.1	29.8	46.6	
Stroke absorption (mm)	6	7	12	15	25	
Max. collision speed (mm/s)	1000					
Max. operating frequency (cycle/min)	80	70	45	25	10	
Spring force (N)	Extended	1.96	4.22	6.86	8.34	8.83
	Compressed	4.22	6.86	15.98	20.50	20.01
Operating temperature range (°C)	5 to 60					

Note) The shock absorber service life is different from that of the MY3A/3B cylinders depending on operating conditions. Allowable operating cycle under the specifications set in this catalog is shown below.

1.2 million times RB08□□
2 million times RB10□□ to RB2725

Note) Specified service life (suitable replacement period) is the value at room temperature (20 to 25°C). The period may vary depending on the temperature and other conditions. In some cases the absorber may need to be replaced before the allowable operating cycle above.

Theoretical Output

Bore size (mm)	Piston area (mm ²)	Operating pressure (MPa)						
		0.2	0.3	0.4	0.5	0.6	0.7	0.8
16	200	40	60	80	100	120	140	160
20	314	62	94	125	157	188	219	251
25	490	98	147	196	245	294	343	392
32	804	161	241	322	402	483	563	643
40	1256	251	377	502	628	754	879	1005
50	1962	392	588	784	981	1177	1373	1569
63	3115	623	934	1246	1557	1869	2180	2492

Note) Theoretical output (N) = Pressure (MPa) x Piston area (mm²)

Weight

Model	Bore size (mm)	Basic weight	Additional weight per 50 mm stroke	Stroke adjustment unit weight (per unit)	
				L unit weight	H unit weight
				/	
MY3A	16	0.22	0.06		
	20	0.39	0.09		
	25	0.65	0.17		
	32	1.25	0.18		
	40	2.45	0.25		
	50	3.72	0.40		
MY3B	16	0.23	0.06	0.04	0.05
	20	0.49	0.09	0.06	0.08
	25	0.75	0.17	0.10	0.15
	32	1.39	0.18	0.14	0.22
	40	2.58	0.25	0.26	0.30
	50	4.10	0.40	0.38	0.52
	63	7.78	0.56	0.57	0.92

Calculation method/Example: **MY3B25-300L**

Basic weight 0.75 kg Cylinder stroke 300 st
 Additional weight 0.17/50 st 0.75 + 0.17 x 300 ÷ 50 + 0.1 x 2 ≒ 1.97 kg
 L unit weight 0.1 kg

Option / Stroke Adjustment Unit Model

Model	Unit	Bore size (mm)	16	20	25	32	40	50	63
			MY3B	L unit	Left	MY3B-A16L1	MY3B-A20L1	MY3B-A25L1	MY3B-A32L1
Right	MY3B-A16L2	MY3B-A20L2			MY3B-A25L2	MY3B-A32L2	MY3B-A40L2	MY3B-A50L2	MY3B-A63L2
H unit	Left	MY3B-A16H1		MY3B-A20H1	MY3B-A25H1	MY3B-A32H1	MY3B-A40H1	MY3B-A50H1	MY3B-A63H1
	Right	MY3B-A16H2		MY3B-A20H2	MY3B-A25H2	MY3B-A32H2	MY3B-A40H2	MY3B-A50H2	MY3B-A63H2

Series MY3A/3B

Construction: Ø16, Ø25, Ø40, Ø63

MY3A

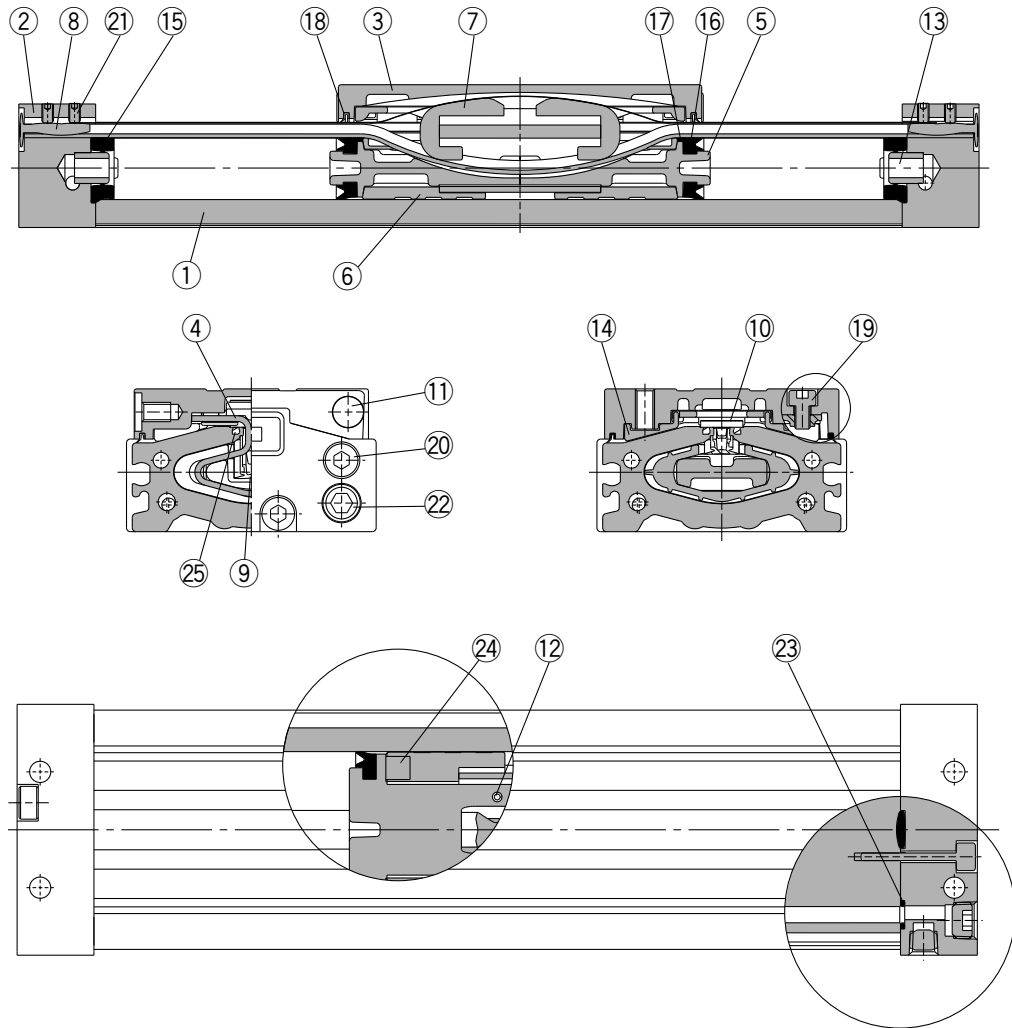

Component Parts

No.	Description	Material	Note
1	Cylinder tube	Aluminum alloy	Hard anodized
2	Head cover	Aluminum alloy	Hard anodized
3	Slide table	Aluminum alloy	Electroless nickel plated
4	Piston yoke	Stainless steel	
5	Piston	Aluminum alloy	Chromated
6	Wear ring	Polyacetal	
7	Belt separator	Polyacetal	
8	Belt clamp	Polybutylene terephthalate	
11	Stopper	Carbon steel	Nickel plated

No.	Description	Material	Note
12	Spring pin	Carbon tool steel	
13	Seal ring	Aluminum alloy	Anodized
14	Bearing	Polyacetal	
17	Inner wiper	Special resin	
19	Hexagon socket head cap screw	Chrome molybdenum steel	Nickel plated
20	Hexagon socket head cap screw	Chrome molybdenum steel	Nickel plated
21	Hexagon socket head set screw	Chrome molybdenum steel	Nickel plated
22	Hexagon socket head plug	Carbon steel	Nickel plated
24	Magnet	—	
25	Seal magnet	Rubber magnet	

Replacement Parts/Seal

No.	Description	Material	Qty.	MY3A16	MY3A25	MY3A40	MY3A63
9	Seal belt	Polyamide	1	MY3A16-16A-Stroke	MY3A25-16A-Stroke	MY3A40-16A-Stroke	MY3A63-16A-Stroke
10	Dust seal band	Stainless steel	1	MY3A16-16B-Stroke	MY3A25-16B-Stroke	MY3A40-16B-Stroke	MY3A63-16B-Stroke
15	Gasket bumper	NBR	2	RMA-16	RMA-25	RMA-40	RMA-63
16	Piston seal	NBR	2	RMY-16	RMY-25	RMY-40	RMY-63
18	Scraper	Polyamide	1	MYA16-15-R6656	MYA25-15-R6657	MYA40-15-R6658	MYA63-15-R6659
23	O-ring	NBR	4	ø6.2 x ø3 x ø1.6	C-5	ø10.5 x ø8.5 x ø1	C-14

* When ⑨ and ⑩ are shipped as single units, a grease pack is included (10 g per 1000 strokes).
Order with the following part number when only the grease pack is needed.

Grease pack part number: GR-S-010 (10 g), GR-S-020 (20 g)

* For instructions on how to replace replacement parts/seals, refer to the operation manual.

Construction: Ø20, Ø32, Ø50

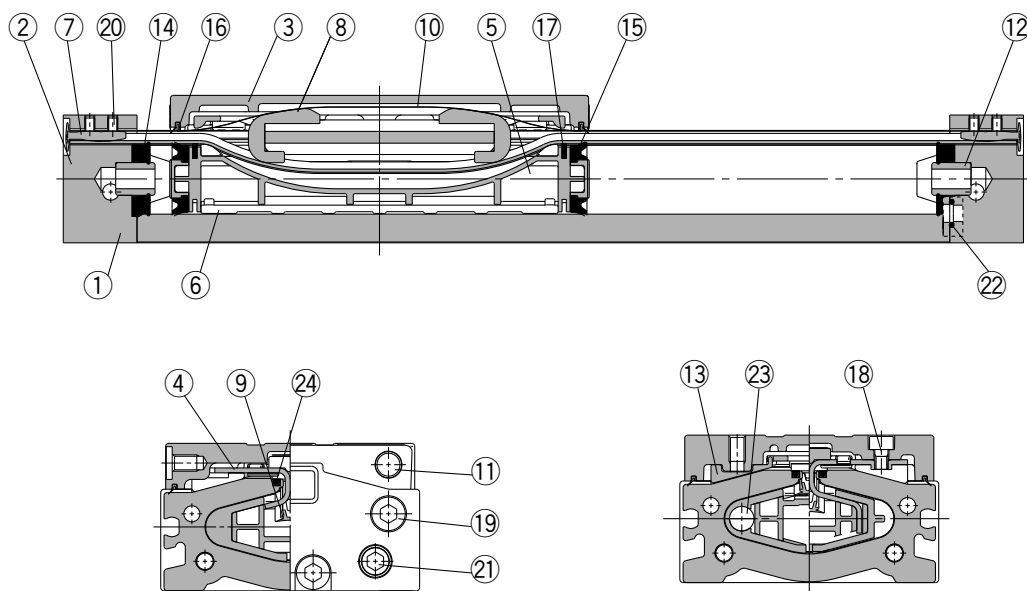

Component Parts

No.	Description	Material	Note
1	Cylinder tube	Aluminum alloy	Hard anodized
2	Head cover	Aluminum alloy	Hard anodized
3	Slide table	Aluminum alloy	Electroless nickel plated
4	Piston yoke	Stainless steel	
5	Piston	Polyamide	
6	Wear ring	Polyacetal	
7	Belt clamp	Polybutylene terephthalate	
8	Belt separator	Polyacetal	
11	Stopper	Carbon steel	Nickel plated

No.	Description	Material	Note
12	Seal ring	Aluminum alloy	Anodized
13	Bearing	Polyacetal	
17	Inner wiper	Special resin	
18	Hexagon socket head cap screw	Chrome molybdenum steel	Nickel plated
19	Hexagon socket head cap screw	Chrome molybdenum steel	Nickel plated
20	Hexagon socket head set screw	Chrome molybdenum steel	Nickel plated
21	Hexagon socket head plug	Carbon steel	Nickel plated
23	Magnet	—	
24	Seal magnet	Rubber magnet	

Replacement Parts/Seal

No.	Description	Material	Qty.	MY3A20	MY3A32	MY3A50
9	Seal belt	Polyamide	1	MY3A20-16A-Stroke	MY3A32-16A-Stroke	MY3A50-16A-Stroke
10	Dust seal band	Stainless steel	1	MY3A20-16B-Stroke	MY3A32-16B-Stroke	MY3A50-16B-Stroke
14	Gasket bumper	NBR	2	RMA-20	RMA-32	RMA-50
15	Piston seal	NBR	2	RMY-20	RMY-32	RMY-50
16	Scraper	Polyamide	2	MYA20-15-AC594	MYA32-15-AC595	MYA50-15-AC596
22	O-ring	NBR	4	C-5	C-6	C-12.5

* When ⑨ and ⑩ are shipped as single units, a grease pack is included (10 g per 1000 strokes).

Order with the following part number when only the grease pack is needed.

Grease pack part number: **GR-S-010** (10 g), **GR-S-020** (20 g)

* For instructions on how to replace replacement parts/seals, refer to the operation manual.

Series MY3A/3B

Construction: $\varnothing 16$, $\varnothing 25$, $\varnothing 40$, $\varnothing 63$

MY3B

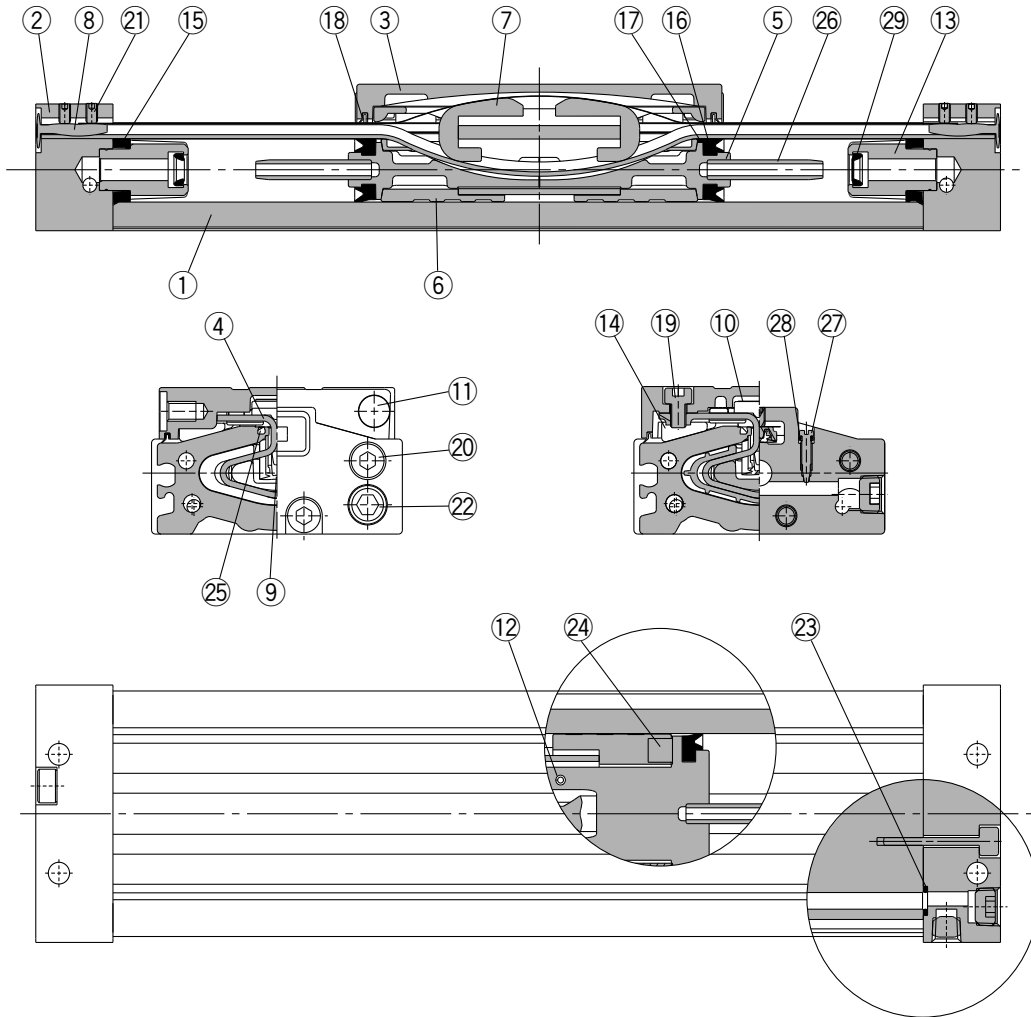

Component Parts

No.	Description	Material	Note
1	Cylinder tube	Aluminum alloy	Hard anodized
2	Head cover	Aluminum alloy	Hard anodized
3	Slide table	Aluminum alloy	Electroless nickel plated
4	Piston yoke	Stainless steel	
5	Piston	Aluminum alloy	Chromated
6	Wear ring	Polyacetal	
7	Belt separator	Polyacetal	
8	Belt clamp	Polybutylene terephthalate	
11	Stopper	Carbon steel	Nickel plated
12	Spring pin	Carbon tool steel	

No.	Description	Material	Note
13	Cushion boss	Aluminum alloy	Chromated
14	Bearing	Polyacetal	
17	Inner wiper	Special resin	
19	Hexagon socket head cap screw	Chrome molybdenum steel	Nickel plated
20	Hexagon socket head cap screw	Chrome molybdenum steel	Nickel plated
21	Hexagon socket head set screw	Chrome molybdenum steel	Nickel plated
22	Hexagon socket head plug	Carbon steel	Nickel plated
24	Magnet	—	
25	Seal magnet	Rubber magnet	
26	Cushion ring	Brass	
27	Cushion needle	Rolled steel	Nickel plated

Replacement Parts/Seal

No.	Description	Material	Qty.	MY3B16	MY3B25	MY3B40	MY3B63
9	Seal belt	Polyamide	1	MY3B16-16A-[Stroke]	MY3B25-16A-[Stroke]	MY3B40-16A-[Stroke]	MY3B63-16A-[Stroke]
10	Dust seal band	Stainless steel	1	MY3B16-16B-[Stroke]	MY3B25-16B-[Stroke]	MY3B40-16B-[Stroke]	MY3B63-16B-[Stroke]
15	Tube gasket	NBR	2	RMB-16	RMB-25	RMB-40	RMB-63
16	Piston seal	NBR	2	RMY-16	RMY-25	RMY-40	RMY-63
18	Scraper	Polyamide	1	MYA16-15-R6656	MYA25-15-R6657	MYA40-15-R6658	MYA63-15-R6659
23	O-ring	NBR	4	$\varnothing 6.2 \times \varnothing 3 \times \varnothing 1.6$	C-5	$\varnothing 10.5 \times \varnothing 8.5 \times \varnothing 1$	C-14
28	O-ring	NBR	2	$\varnothing 4 \times \varnothing 1.8 \times \varnothing 1.1$	$\varnothing 4 \times \varnothing 1.8 \times \varnothing 1.1$	$\varnothing 7.15 \times \varnothing 3.75 \times \varnothing 1.7$	$\varnothing 8.3 \times \varnothing 4.5 \times \varnothing 1.9$
29	Cushion seal	NBR	2	MCS-3	MCS-5	RCS-8	RCS-12

* When ⑨ and ⑩ are shipped as single units, a grease pack is included (10 g per 1000 strokes).

Order with the following part number when only the grease pack is needed.

Grease pack part number: GR-S-010 (10 g), GR-S-020 (20 g)

* For instructions on how to replace replacement parts/seals, refer to the operation manual.

Construction: Ø20, Ø32, Ø50

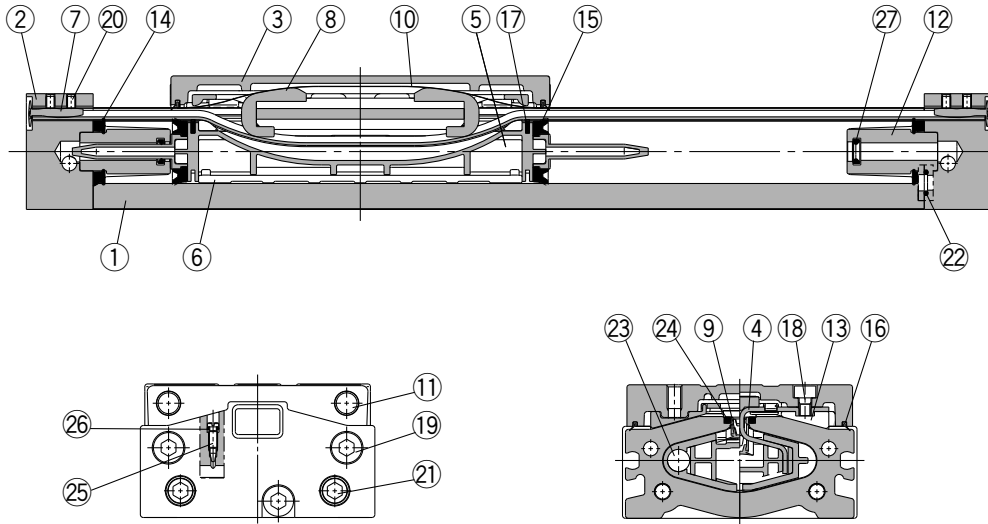

Component Parts

No.	Description	Material	Note
1	Cylinder tube	Aluminum alloy	Hard anodized
2	Head cover	Aluminum alloy	Hard anodized
3	Slide table	Aluminum alloy	Electroless nickel plated
4	Piston yoke	Stainless steel	
5	Piston	Polyamide	
6	Wear ring	Polyacetal	
7	Belt clamp	Polybutylene terephthalate	
8	Belt separator	Polyacetal	
11	Stopper	Carbon steel	Nickel plated
12	Cushion boss	Aluminum alloy	Chromated
13	Bearing	Polyacetal	

No.	Description	Material	Note
17	Inner wiper	Special resin	
18	Hexagon socket head cap screw	Chrome molybdenum steel	Nickel plated
19	Hexagon socket head cap screw	Chrome molybdenum steel	Nickel plated
20	Hexagon socket head set screw	Chrome molybdenum steel	Nickel plated
21	Hexagon socket head plug	Carbon steel	Nickel plated
23	Magnet	—	
24	Seal magnet	Rubber magnet	
25	Cushion needle	Rolled steel	Nickel plated

Replacement Parts/Seal

No.	Description	Material	Qty.	MY3B20	MY3B32	MY3B50
9	Seal belt	Polyamide	1	MY3B20-16A-[Stroke]	MY3B32-16A-[Stroke]	MY3B50-16A-[Stroke]
10	Dust seal band	Stainless steel	1	MY3B20-16B-[Stroke]	MY3B32-16B-[Stroke]	MY3B50-16B-[Stroke]
14	Tube gasket	NBR	2	RMB-20	RMB-32	RMB-50
15	Piston seal	NBR	2	RMY-20	RMY-32	RMY-50
16	Scraper	Polyamide	2	MYA20-15-AC594	MYA32-15-AC595	MYA50-15-AC596
22	O-ring	NBR	4	C-5	C-6	C-12.5
26	O-ring	NBR	2	ø4 x ø1.8 x ø1.1	ø4 x ø1.8 x ø1.1	ø7.15 x ø3.75 x ø1.7
27	Cushion seal	NBR	2	MCS-3	MCS-5	RCS-8

* When ⑨ and ⑩ are shipped as single units, a grease pack is included (10 g per 1000 strokes).

Order with the following part number when only the grease pack is needed.

Grease pack part number: GR-S-010 (10 g), GR-S-020 (20 g)

* For instructions on how to replace replacement parts/seals, refer to the operation manual.

Series MY3A/3B

Short Type: Ø16, Ø20, Ø25, Ø32, Ø40, Ø50, Ø63

MY3A Bore size – Stroke

* Refer to "Specific Product Precautions" on front matter 7 for mounting.

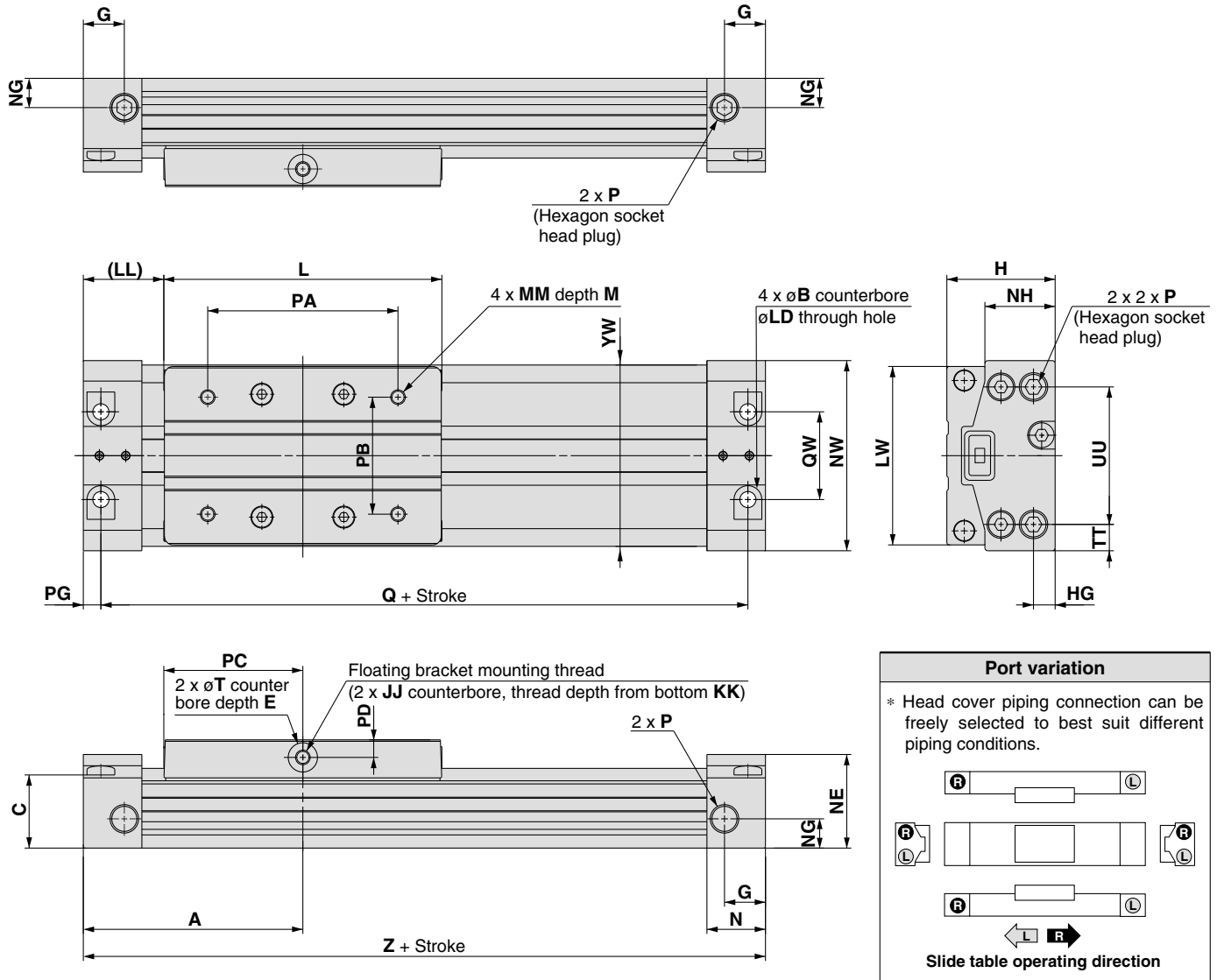

Model	A	B	C	E	G	H	HG	JJ	KK	L	LD	LL	LW	M	MM	N
MY3A16	55	6	18	2	9.5	27	5	M4 x 0.7	5	65	3.5	22.5	41	6	M4 x 0.7	13.5
MY3A20	64	7.5	22	2	9.5	32	6.5	M4 x 0.7	8.5	80	4.5	24	51	6	M4 x 0.7	15.5
MY3A25	75	9.5	25	2	14	37	7.4	M5 x 0.8	7.5	95	5.5	27.5	61	8	M5 x 0.8	20
MY3A32	96.5	11	32.5	2	14	45	9	M5 x 0.8	7.5	128	6.6	32.5	76	8	M5 x 0.8	22.5
MY3A40	120	14	38	2	18	54	12	M6 x 1	12	160	8.6	40	90	12	M6 x 1	27
MY3A50	137	14	49	3	16	67	14	M6 x 1	15.5	190	9	42	112	12	M6 x 1	27
MY3A63	160	17	60	3	20.5	84	16.5	M8 x 1.25	22	220	11	50	134	16	M8 x 1.25	31

Model	NE	NG	NH	NW	P	PA	PB	PC	PD	PG	Q	QW	T	TT	UU	YW	Z
MY3A16	22.5	8	17.2	43	M5 x 0.8	44	26	32.5	4	4	102	19	7	6.5	30	42	110
MY3A20	27.5	10	20.8	53	M5 x 0.8	54	30	40	5	4.5	119	23	8	9	35	52	128
MY3A25	32	10	24	65	Rc, NPT, G1/8	64	40	47.5	6	6	138	30	10	9	47	62	150
MY3A32	39	14	31	79	Rc, NPT, G1/8	92	44	64	6	7	179	33	10	13.5	52	77	193
MY3A40	46	15	37	94	Rc, NPT, G1/4	112	60	80	7.5	8.5	223	40	14	14	66	92	240
MY3A50	58	25	47.5	116	Rc, NPT, G3/8	142	66	95	8.5	8.5	257	44	15	21	74	114	274
MY3A63	70	29	58	139	Rc, NPT, G3/8	162	84	110	10	10	300	64	16	20	99	136	320

Standard Type: $\varnothing 16, \varnothing 20, \varnothing 25, \varnothing 32, \varnothing 40, \varnothing 50, \varnothing 63$

MY3B Bore size – Stroke

* Refer to "Specific Product Precautions" on front matter 7 for mounting.

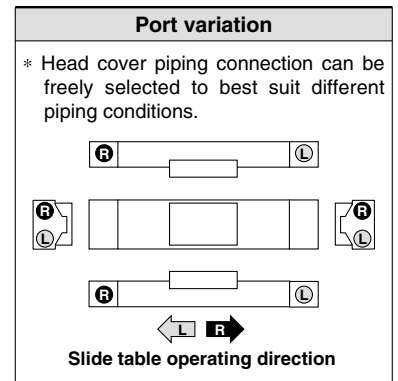
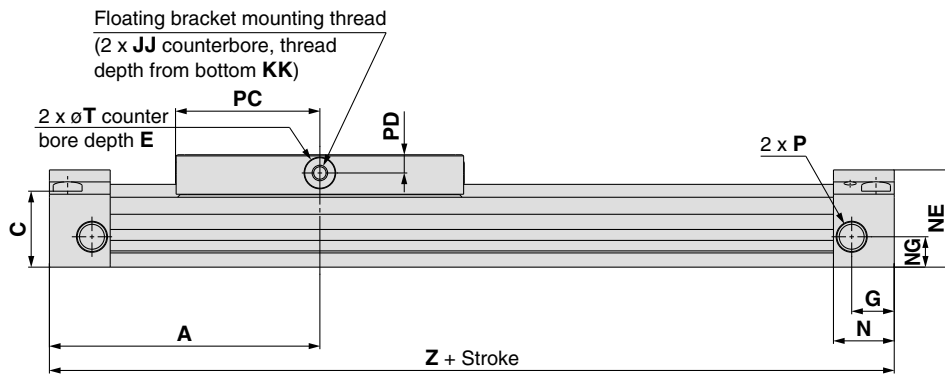
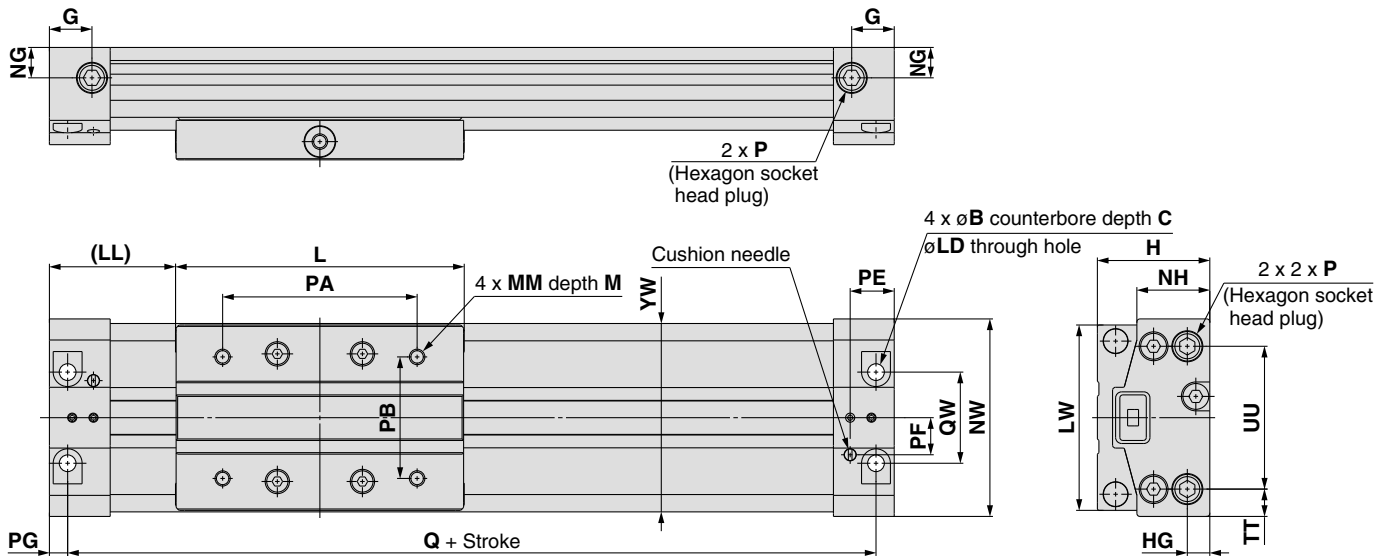

Model	A	B	C	E	G	H	HG	JJ	KK	L	LD	LL	LW	M	MM	N
MY3B16	61	6	18	2	9.5	27	5	M4 x 0.7	5	65	3.5	28.5	41	6	M4 x 0.7	13.5
MY3B20	74	7.5	22	2	9.5	32	6.5	M4 x 0.7	8.5	80	4.5	34	51	6	M4 x 0.7	15.5
MY3B25	89	9.5	25	2	14	37	7.4	M5 x 0.8	7.5	95	5.5	41.5	61	8	M5 x 0.8	20
MY3B32	112.5	11	32.5	2	14	45	9	M5 x 0.8	7.5	128	6.6	48.5	76	8	M5 x 0.8	22.5
MY3B40	138	14	38	2	18	54	12	M6 x 1	12	160	8.6	58	90	12	M6 x 1	27
MY3B50	155	14	49	3	16	67	14	M6 x 1	15.5	190	9	60	112	12	M6 x 1	27
MY3B63	178	17	60	3	20.5	84	16.5	M8 x 1.25	22	220	11	68	134	16	M8 x 1.25	31

Model	NE	NG	NH	NW	P	PA	PB	PC	PD	PE	PF	PG	Q	QW	T	TT	UU	YW	Z
MY3B16	22.5	8	17.2	43	M5 x 0.8	44	26	32.5	4	9.7	8.5	4	114	19	7	6.5	30	42	122
MY3B20	27.5	10	20.8	53	M5 x 0.8	54	30	40	5	11.2	10	4.5	139	23	8	9	35	52	148
MY3B25	32	10	24	65	Rc, NPT, G1/8	64	40	47.5	6	14.5	12.2	6	166	30	10	9	47	62	178
MY3B32	39	14	31	79	Rc, NPT, G1/8	92	44	64	6	16	15	7	211	33	10	13.5	52	77	225
MY3B40	46	15	37	94	Rc, NPT, G1/4	112	60	80	7.5	19.5	16.5	8.5	259	40	14	14	66	92	276
MY3B50	58	25	47.5	116	Rc, NPT, G3/8	142	66	95	8.5	20.5	20	8.5	293	44	15	21	74	114	310
MY3B63	70	29	58	139	Rc, NPT, G3/8	162	84	110	10	23.5	27.5	10	336	64	16	20	99	136	356

Series MY3A/3B

Standard Type: $\varnothing 16, \varnothing 20, \varnothing 25, \varnothing 32, \varnothing 40, \varnothing 50, \varnothing 63$

Stroke adjustment unit

Low load shock absorber + Adjustment bolt

MY3B – L

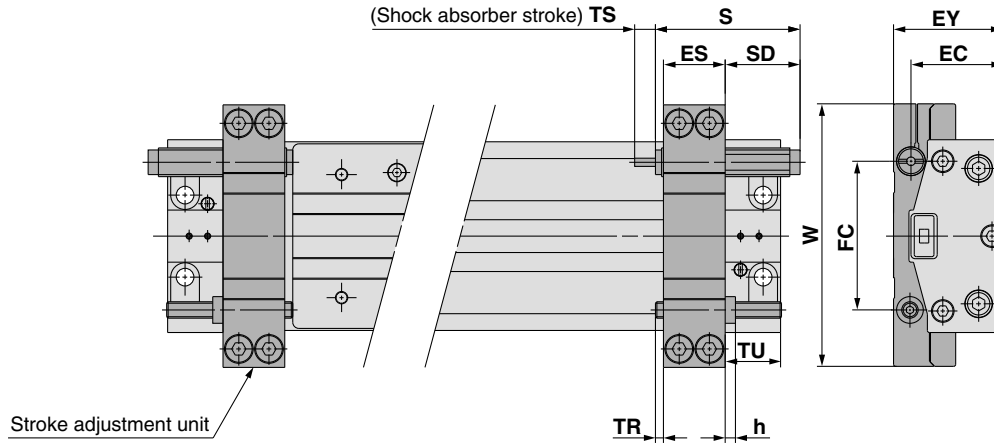

Applicable cylinder	ES	EC	EY	FC	h	S	SD	TS	TR	TU	W	Shock absorber model
MY3B16	14.1	21.5	26.5	34.5	2.4	40.8	25.8	6	0.9	25	62	RB0806
MY3B20	14.1	26.5	31.5	41	2.4	40.8	22.3	6	4.4	21.5	72	RB0806
MY3B25	20.1	29.8	36.5	51.5	3.6	46.7	25.2	7	1.4	28.5	90	RB1007
MY3B32	20.1	37.5	44.5	60	3.6	46.7	20.7	7	5.9	24	105	RB1007
MY3B40	30.1	45	53.5	72.5	5	67.3	36.3	12	0.9	39	128	RB1412
MY3B50	30.1	56.5	66.5	88	5	67.3	34.3	12	2.9	37	150	RB1412
MY3B63	36.1	70.5	83.5	108	6	73.2	36.2	15	0.9	43	178	RB2015

Note) When the stroke adjustment unit is used, the fitting type, which can be connected with the port on the body front and the back, will be limited. Refer to front matter 6 for details.

Heavy-loaded shock absorber + Adjustment bolt

MY3B – H

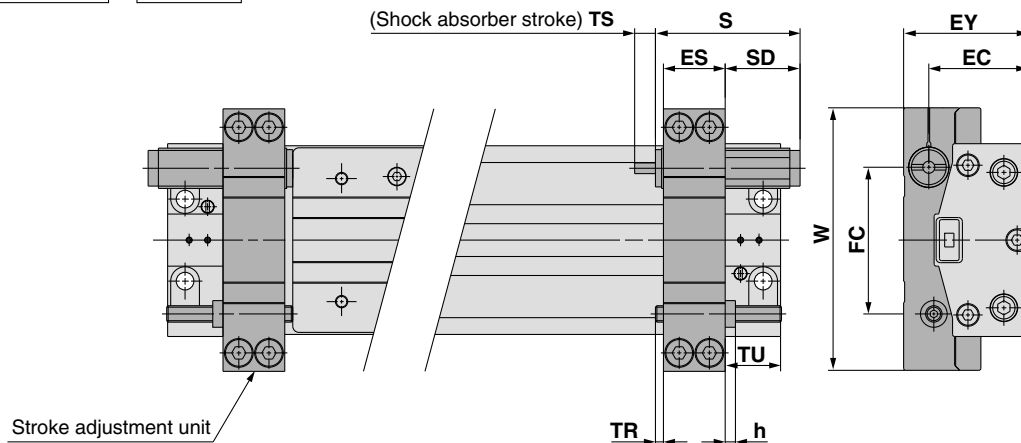

Applicable cylinder	ES	EC	EY	FC	h	S	SD	TS	TR	TU	W	Shock absorber model
MY3B16	14.1	23	29.5	34.5	2.4	46.7	31.7	7	0.9	25	62	RB1007
MY3B20	14.1	27.5	34	41	2.4	46.7	28.2	7	4.4	21.5	72	RB1007
MY3B25	20.1	31.8	41	52.2	3.6	67.3	45.8	12	1.4	28.5	90	RB1412
MY3B32	20.1	39.5	49	60.5	3.6	67.3	41.3	12	5.9	24	105	RB1412
MY3B40	30.1	48	60.5	73.5	5	73.2	42.2	15	0.9	39	128	RB2015
MY3B50	30.1	58.5	71	88.5	5	73.2	40.2	15	2.9	37	150	RB2015
MY3B63	36.1	74.5	91	108	6	99	62	25	0.9	43	178	RB2725

Note) When the stroke adjustment unit is used, the fitting type, which can be connected with the port on the body front and the back, will be limited. Refer to front matter 6 for details.

Side Support

Side support A MY-S□A

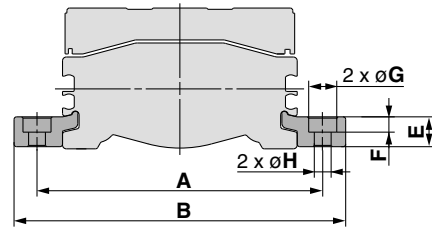
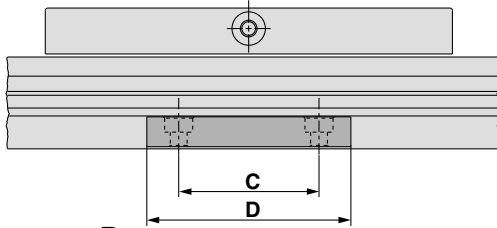

Side support B MY-S□B

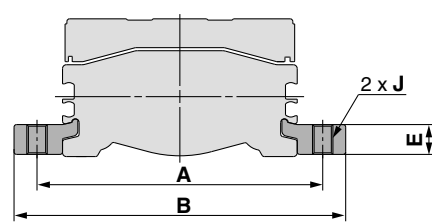
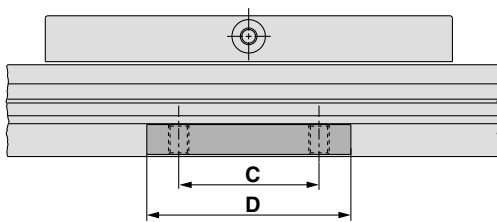

Model	Applicable cylinder	A	B	C	D	E	F	G	H	J
MY-S16 ^A _B	MY3A16-MY3B16	53	63.6	15	26	4.9	3	6.5	3.4	M4 x 0.7
MY-S20 ^A _B	MY3A20-MY3B20	65	77.6	25	38	6.4	4	8	4.5	M5 x 0.8
MY-S25 ^A _B	MY3A25-MY3B25	77	91	35	50	8	5	9.5	5.5	M6 x 1
MY-S32 ^A _B	MY3A32-MY3B32	97	115	45	64	11.7	6	11	6.6	M8 x 1.25
	MY3A40-MY3B40	112	130							
MY-S40 ^A _B	MY3A50-MY3B50	138	160	55	80	14.8	8.5	14	9	M10 x 1.5
	MY3A63-MY3B63	160	182							

Note) A set of side supports consists of a left support and a right support.

Guide for Using Side Support

For long stroke operation, the cylinder tube may be deflected depending on its own weight and the load weight. In such a case, use a side support in the middle section. The spacing (l) of the support must be no more than the values shown in the graph on the right.

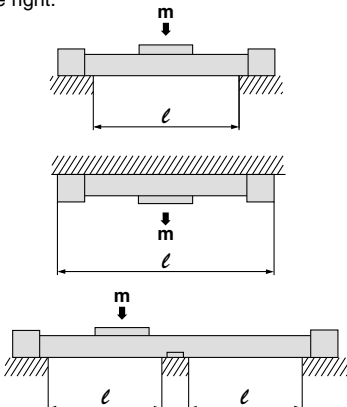

⚠ Caution

- ① If the cylinder mounting surfaces are not measured accurately, using a side support may cause poor operation. Therefore, be sure to level the cylinder tube when mounting. Also, for long stroke operation involving vibration and impact, use of a side support is recommended even if the spacing value is within the allowable limits shown in the graph.
- ② Support brackets are not for mounting; use them solely for providing support.

Guide for Using MY3A Side Support

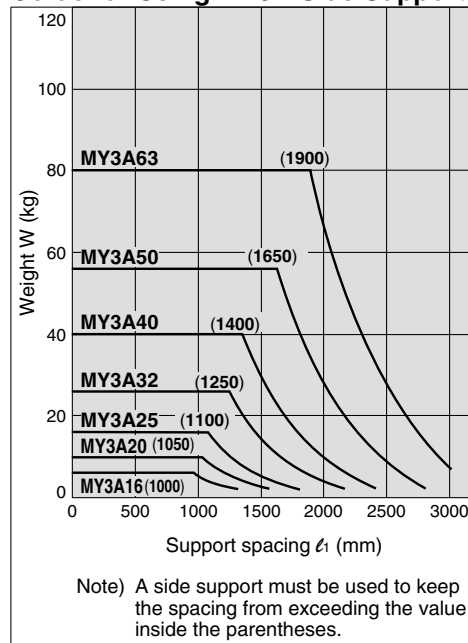

Guide for Using MY3B Side Support

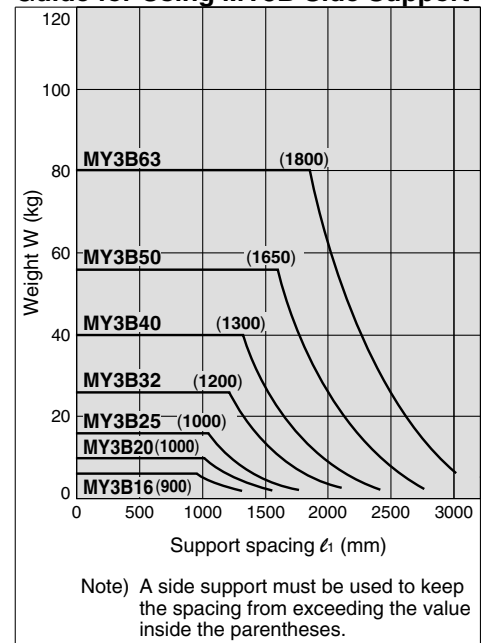

Series MY3A/3B

Floating Bracket

Facilitates connection to other guide systems.

Application

Mounting direction ① (to minimize the installation height)

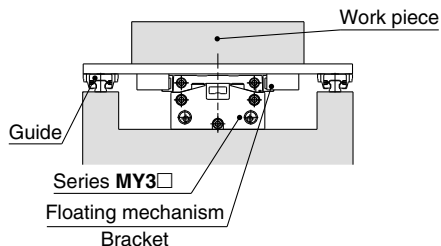

Mounting Example

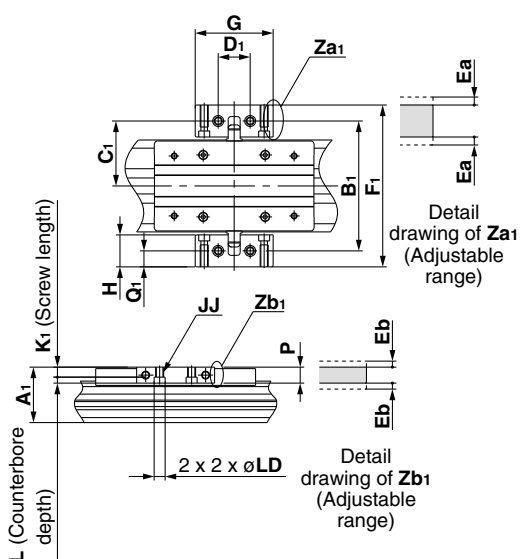

Application

Mounting direction ② (to minimize the installation width)

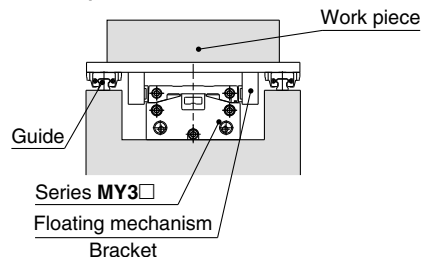

Mounting Example

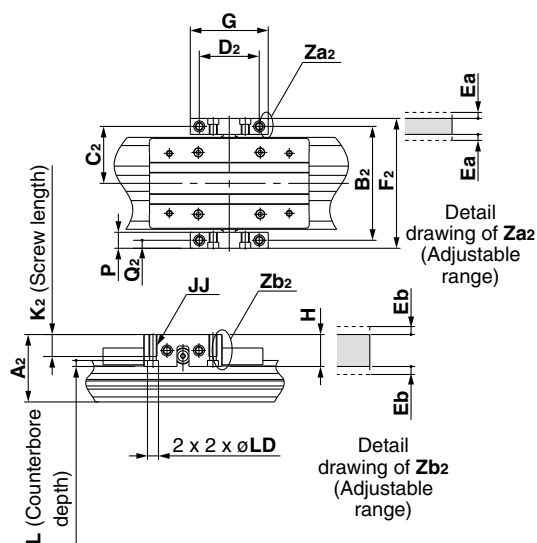

MY3□ Floating Bracket Mounting Dimensions

Model	Applicable cylinder	Common							Adjustment range	
		G	H	JJ	L	P	LD	Ea	Eb	
MYAJ16	MY3□16	38	20	M4 x 0.7	4.5	10	6	1	1	
MYAJ20	MY3□20	50	21	M4 x 0.7	4	10	6.5	1	1	
MYAJ25	MY3□25	55	22	M6 x 1	5.5	12	9.5	1	1	
MYAJ32	MY3□32	60	22	M6 x 1	5.5	12	9.5	1	1	

Model	Applicable cylinder	Mounting direction ①						
		A1	B1	C1	D1	F1	K1	Q1
MYAJ16	MY3□16	29	68	34	18	88	5.5	10
MYAJ20	MY3□20	34	81	40.5	20	102	6	10.5
MYAJ25	MY3□25	38.5	90	45	24	112	6.5	11
MYAJ32	MY3□32	47	106	53	30	128	6.5	11

Model	Applicable cylinder	Mounting direction ②						
		A2	B2	C2	D2	F2	K2	Q2
MYAJ16	MY3□16	36	58	29	30	68	10	5
MYAJ20	MY3□20	41	70	35	35	80	10	5
MYAJ25	MY3□25	46	80	40	40	92	14	6
MYAJ32	MY3□32	54	96	48	46	108	14	6

Model	Applicable cylinder	Common							Adjustment range	
		G	H	JJ	L	P	LD	Ea	Eb	
MYAJ40	MY3□40	72	32	M8 x 1.25	6.5	16	11	1	1	
MYAJ50	MY3□50	90	36	M8 x 1.25	6.5	16	11	1	1	
MYAJ63	MY3□63	100	40	M10 x 1.5	9	19	14	1	1	

Model	Applicable cylinder	Mounting direction ①						
		A1	B1	C1	D1	F1	K1	Q1
MYAJ40	MY3□40	56	130	65	32	162	9.5	16
MYAJ50	MY3□50	69	156	78	40	192	9.5	19
MYAJ63	MY3□63	86	186	93	50	226	10	20

Model	Applicable cylinder	Mounting direction ②						
		A2	B2	C2	D2	F2	K2	Q2
MYAJ40	MY3□40	68	114	57	55	130	19	8
MYAJ50	MY3□50	81	136	68	70	152	20	8
MYAJ63	MY3□63	100	166	83	80	185	23	9.5

Note) Floating brackets are shipped as a set of left and right brackets.

Installation of Holding Bolts

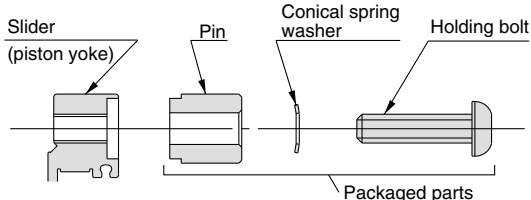

Tightening Torque for Holding Bolts

Model	Tightening torque	Model	Tightening torque
MYAJ16	1.5	MYAJ40	5
MYAJ20	1.5	MYAJ50	5
MYAJ25	3	MYAJ63	13
MYAJ32	3		

MYAJ□ (1 set) Component Parts

Description	Qty.
Bracket	2
Pin	2
Conical spring washer	2
Holding bolts	2

Series MY3M

**Slide bearing guide type
(Air cushion)**

ø16, ø25, ø40, ø63

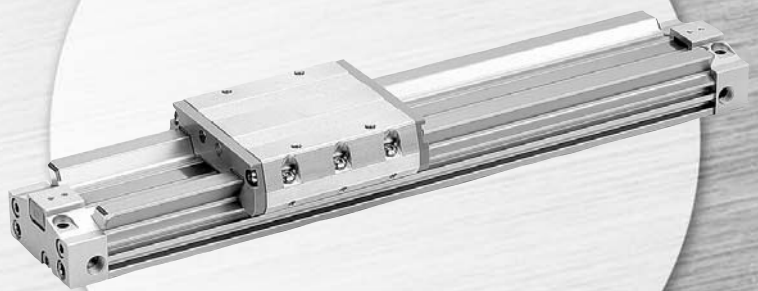

Series MY3M

Model Selection

The following are steps for selecting the MY3 series which is best suited to your application.

Calculation of Guide Load Factor

1 Operating Conditions

Cylinder MY3M25-500
 Average operating speed v_a 300 mm/s
 Mounting direction Wall mounting
 Cushion Air cushion ($\delta = 1/100$)

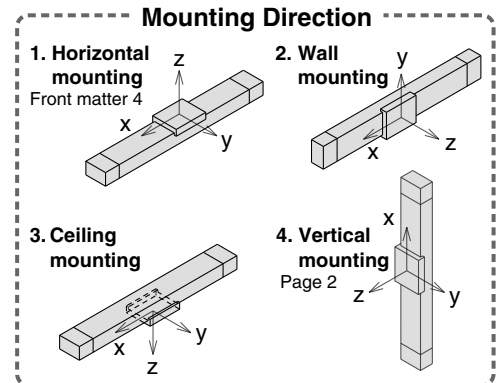
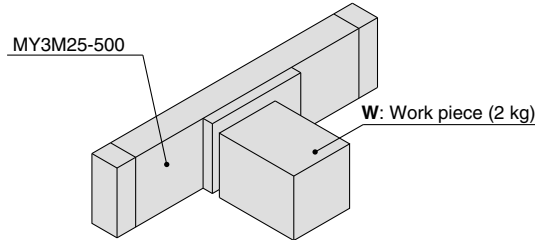

Refer to the pages mentioned above for actual examples of calculation for each orientation.

* For ceiling mounting, refer to Best Pneumatics No. 2, page 998.

2 Load Blocking

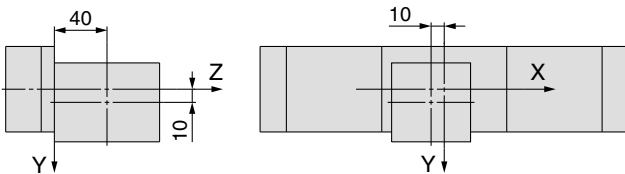

Work Piece Weight and Center of Gravity

Work piece no.	Weight (m)	Center of gravity		
		X-axis	Y-axis	Z-axis
W	2 kg	10 mm	10 mm	40 mm

3 Calculation of Load Factor for Static Load

m₃: Weight

m₃ max (from ① of graph MY3M/**m₃**) = 5.33 (kg)

Load factor $\alpha_1 = m_3 / m_3 \text{ max} = 2 / 5.33 = 0.38$

M₂: Moment

M₂ max (from ② of graph MY3M/**M₂**) = 6 (N·m).....

M₂ = **m₃** x **g** x **Z** = 2 x 9.8 x 40 x 10⁻³ = 0.78 (N·m)

Load factor $\alpha_2 = M_2 / M_2 \text{ max} = 0.78 / 6 = 0.13$

M₃: Moment

M₃ max (from ③ of graph MY3M/**M₃**) = 2.67 (N·m).....

M₃ = **m₃** x **g** x **X** = 2 x 9.8 x 10 x 10⁻³ = 0.2 (N·m)

Load factor $\alpha_3 = M_3 / M_3 \text{ max} = 0.2 / 2.67 = 0.07$

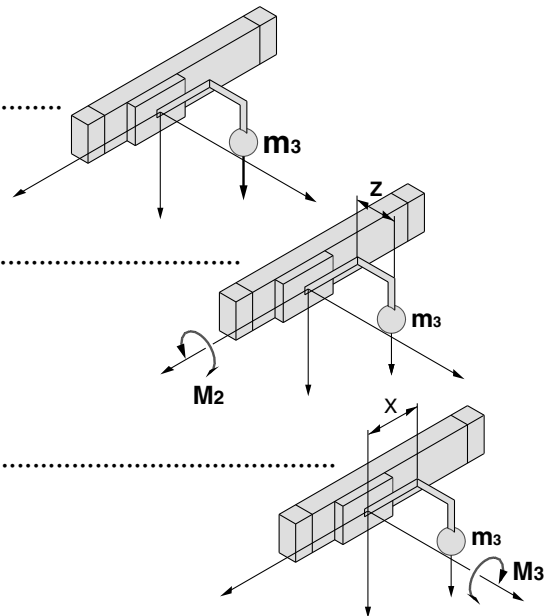

Calculation of Guide Load Factor

4 Calculation of Load Factor for Dynamic Moment

Equivalent load F_E at impact

$$F_E = 1.4Va \times \delta \times m \times g = 1.4 \times 300 \times \frac{1}{100} \times 2 \times 9.8 = 82.38 \text{ (N)}$$

M_{1E} : Moment

$M_{1E \text{ max}}$ (from ④ of graph MY3M/ M_1 where $1.4Va = 420 \text{ mm/s} = 7.62 \text{ (N}\cdot\text{m)}$

$$M_{1E} = \frac{1}{3} \times F_E \times Z = \frac{1}{3} \times 82.38 \times 40 \times 10^{-3} = 1.10 \text{ (N}\cdot\text{m)}$$

$$\text{Load factor } \alpha_4 = M_{1E} / M_{1E \text{ max}} = 1.10 / 7.62 = 0.14$$

M_{3E} : Moment

$M_{3E \text{ max}}$ (from ⑤ graph of MY3M/ M_3 where $1.4Va = 420 \text{ mm/s} = 1.90 \text{ (N}\cdot\text{m)}$

$$M_{3E} = \frac{1}{3} \times F_E \times Y = \frac{1}{3} \times 82.38 \times 10 \times 10^{-3} = 0.27 \text{ (N}\cdot\text{m)}$$

$$\text{Load factor } \alpha_5 = M_{3E} / M_{3E \text{ max}} = 0.27 / 1.90 = 0.14$$

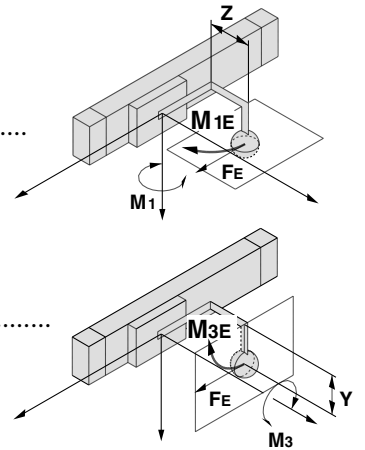

5 Sum and Examination of Guide Load Factors

$$\Sigma\alpha = \alpha_1 + \alpha_2 + \alpha_3 + \alpha_4 + \alpha_5 = 0.87 \leq 1$$

The above calculation is within the allowable value, and therefore the selected model can be used.

Select a shock absorber separately.

In an actual calculation, when the sum of guide load factors $\Sigma\alpha$ in the formula above is more than 1, consider decreasing the speed, increasing the bore size, or changing the product series. This calculation can be easily made using the “SMC Pneumatic CAD System”.

Load Weight

MY3M, m_3

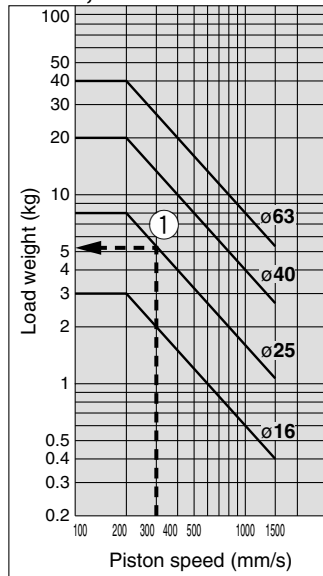

Allowable Moment

MY3M, M_1

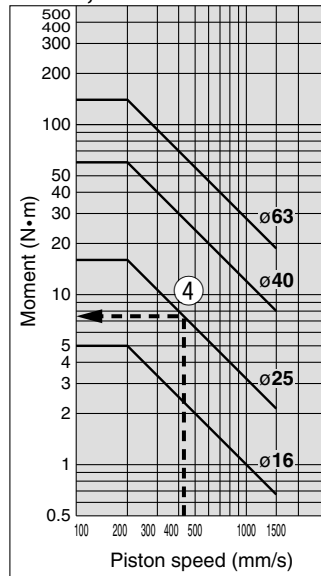

MY3M, M_2

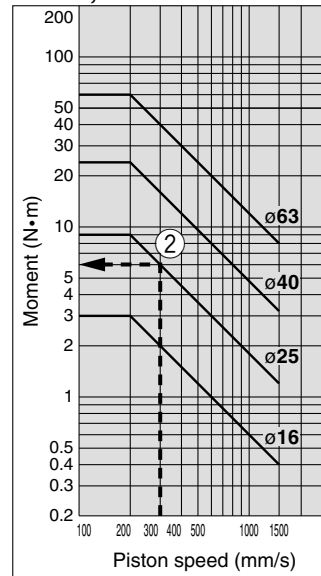

MY3M, M_3

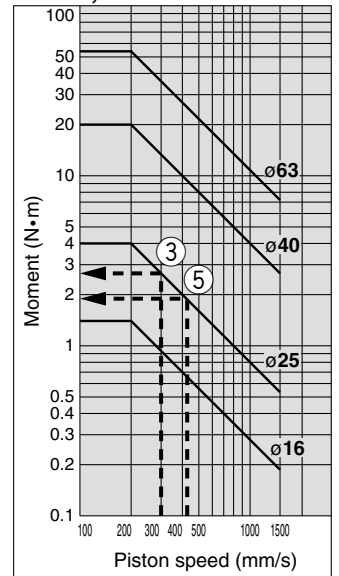

Series MY3M

Maximum Allowable Moment / Maximum Allowable Load

Model	Bore size (mm)	Maximum allowable moment (N·m)			Maximum allowable load (kg)		
		M ₁	M ₂	M ₃	m ₁	m ₂	m ₃
MY3M	16	5	3	1.4	18	14	3
	25	16	9	4	38	36	8
	40	60	24	20	84	81	20
	63	140	60	54	180	163	40

Recommended direction of applying M₂ moment

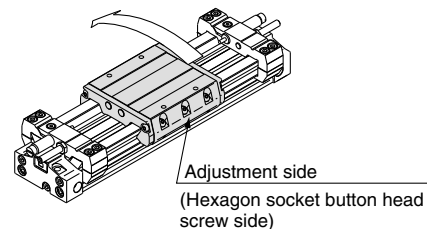

* We recommend that the static M₂ moment direction should be as illustrated.

Also, when using the product in a wall mount application (m₃ applied), we recommend that the mounting orientation of the adjustment side (hexagon socket head button bolt side) should be in the upper position.

Maximum Allowable Moment

Select the moment from within the range of operating limits shown in the graphs. Note that the maximum allowable load value may sometimes be exceeded even within the operating limits shown in the graphs. Therefore, also check the allowable load for the selected conditions.

MY3M, M₁

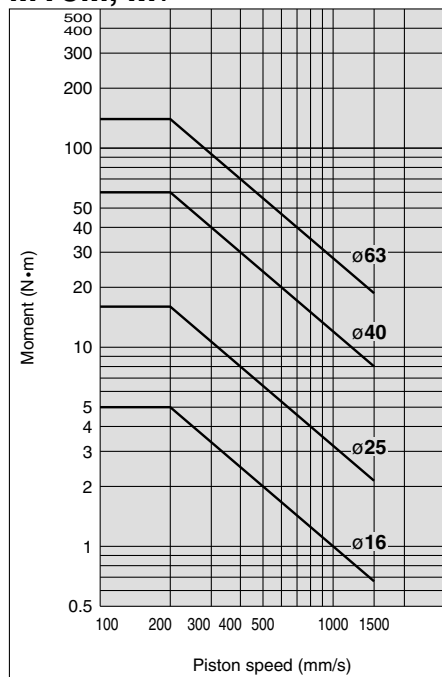

MY3M, M₂

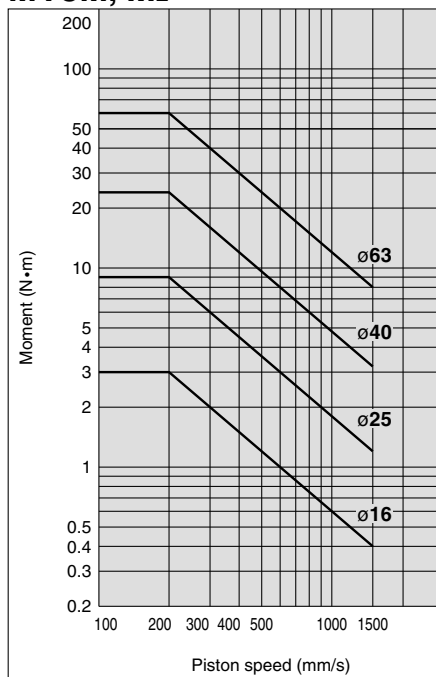

MY3M, M₃

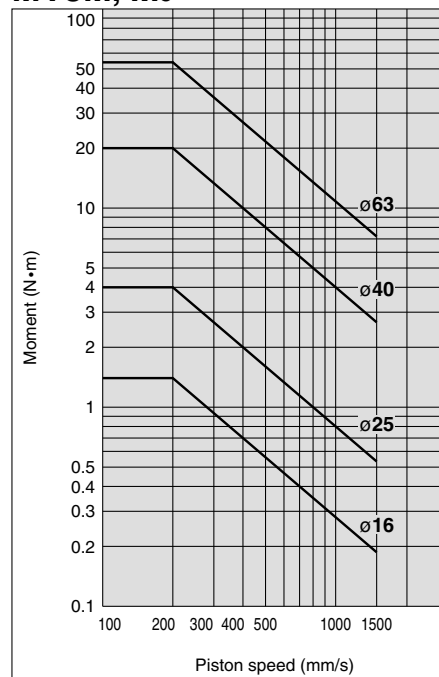

Maximum Allowable Load

Select the load from within the range of limits shown in the graphs. Note that the maximum allowable moment value may sometimes be exceeded even within the operating limits shown in the graphs. Therefore, also check the allowable moment for the selected conditions.

MY3M, m₁

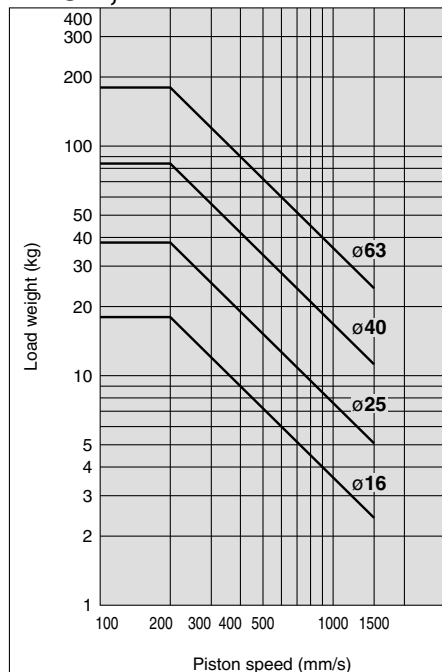

MY3M, m₂

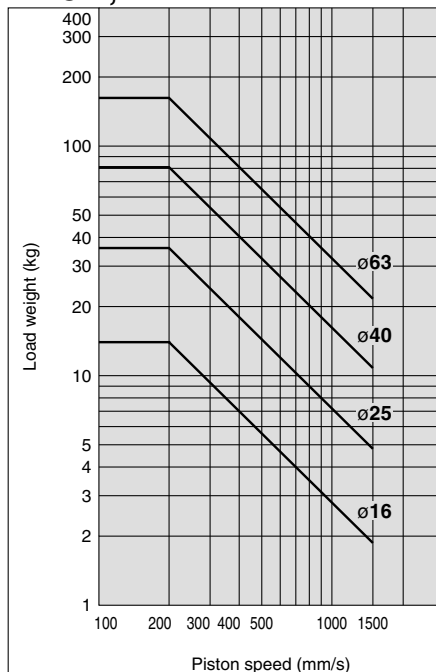

MY3M, m₃

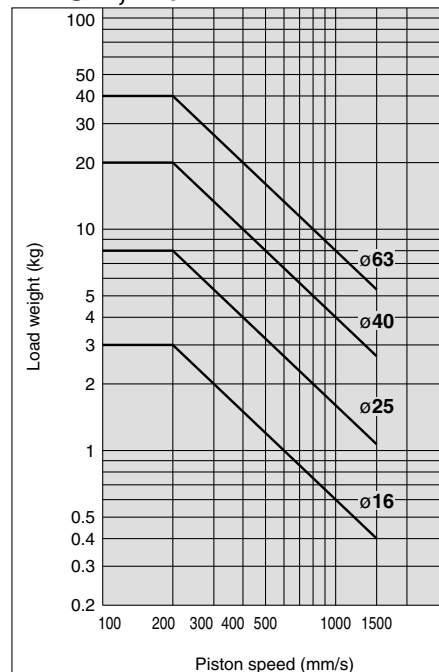

Cushion Capacity

Absorption Capacity of Air Cushion and Stroke Adjustment Unit

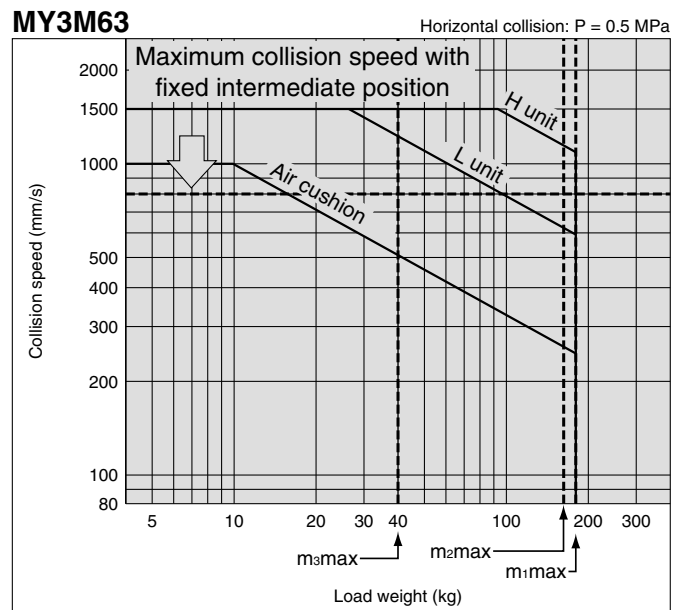
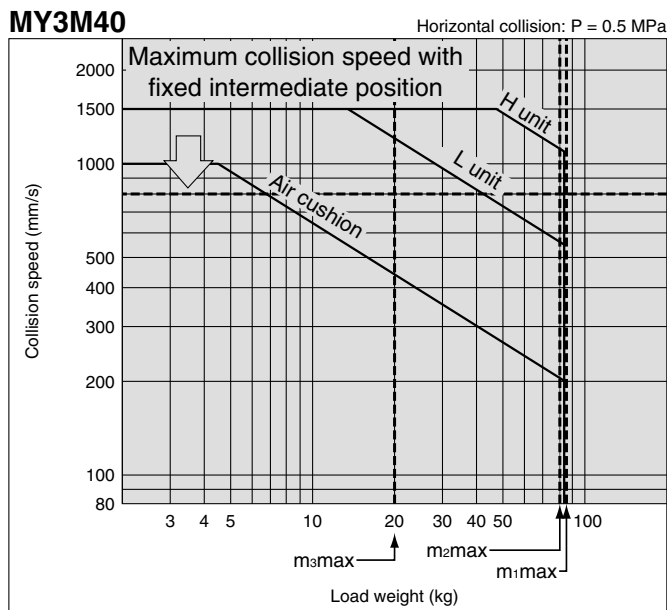
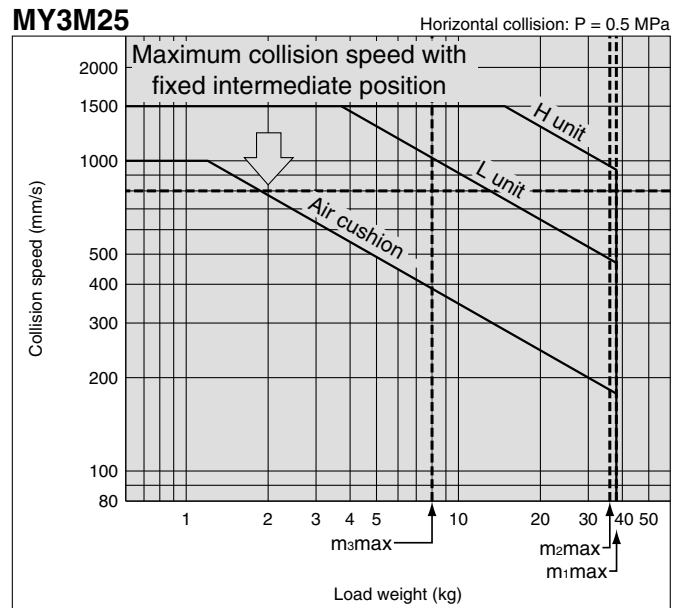
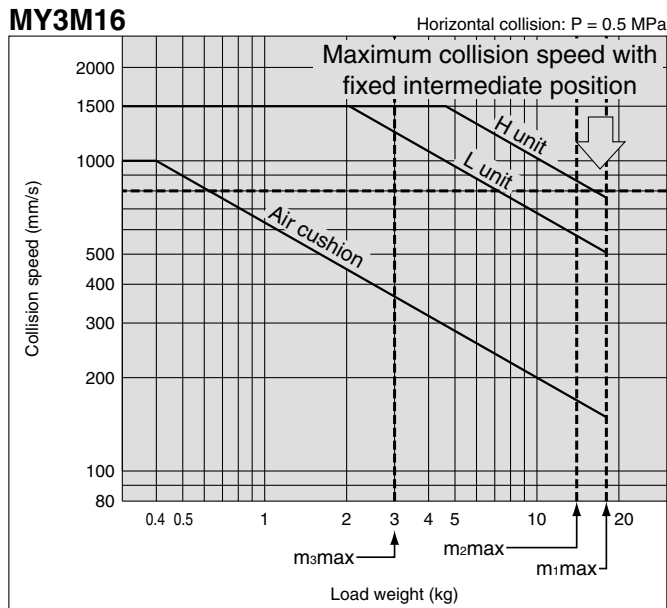

Air Cushion Stroke

Unit: mm

Bore size (mm)	Cushion stroke
16	13
25	18
40	25
63	30

Cushion Capacity

Absorption Capacity of Air Cushion and Stroke Adjustment Unit

Calculation of Absorbed Energy for Stroke Adjustment Unit with Built-in Shock Absorber Unit: N·m

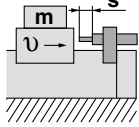
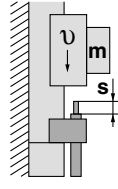
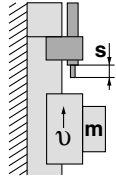
Type of collision	Horizontal	Vertical (Downward)	Vertical (Upward)
			
Kinetic energy E_1	$\frac{1}{2} m \cdot v^2$		
Thrust energy E_2	$F \cdot s$	$F \cdot s + m \cdot g \cdot s$	$F \cdot s - m \cdot g \cdot s$
Absorbed energy E	$E_1 + E_2$		

Stroke Adjustment Unit Fine Stroke Adjustment Range Unit: mm

Bore size (mm)	Fine stroke adjustment range
16	0 to -10
25	0 to -12
40	0 to -16
63	0 to -24

Note) The maximum operating speed will differ when the stroke adjustment unit is used outside the maximum fine stroke adjustment range (with reference to the fixed stroke end), such as at a fixed intermediate position (X416, X417). (Refer to the graph on page 29.)

Symbols

v : Speed of impacting object (m/s)

F : Cylinder thrust (N)

s : Shock absorber stroke (m)

Note) The speed of the impacting object is measured at the time of collision with the shock absorber.

m : Weight of impacting object (kg)

g : Gravitational acceleration (9.8 m/s²)

Stroke Adjustment

<Stroke adjustment of the adjustment bolt>

Loosen the lock nut for the adjustment bolt, adjust the stroke on the head cover side with a hexagon wrench, and secure with a lock nut.

<Stroke adjustment of the shock absorber>

Loosen the fixing bolts on the shock absorber side and rotate the shock absorber for stroke adjustment. Tighten the fixing bolts to secure the shock absorber. Use caution not to overtighten the fixing bolts.

(Refer to "Stroke Adjustment Unit Tightening Torque for Fixing Bolts.")

Stroke Adjustment Unit Tightening Torque for Fixing Bolts Unit: N·m

Bore size (mm)	Unit	Tightening torque
16	L	0.7
	H	
25	L	3.5
	H	
40	L	13.8
	H	
63	L	27.5
	H	

Shock Absorber Tightening Torque for Fixing Bolts Unit: N·m

Bore size (mm)	Unit	Tightening torque
16	L	0.6
	H	
25	L	1.5
	H	
40	L	3.0
	H	
63	L	5.0
	H	

⚠ Caution

1. Use caution not to have your hands caught in the unit.

When using a cylinder with stroke adjustment unit, the space between the slide table (slider) and the stroke adjustment unit is very narrow. Care should be taken to avoid the danger of hands being caught in this small space. Install a protective cover to prevent the risk of accidents to the human body.

⚠ Caution

2. The stroke adjustment unit may interfere with the mounting bolt when mounting the cylinder on the equipment.

Loosen the unit fixing bolt and dislocate the stroke adjustment unit before mounting the cylinder. After fixing the cylinder, move the stroke adjustment unit back to the desired location and tighten the unit fixing bolt.

Use caution not to overtighten the fixing bolts.

(Refer to "Stroke Adjustment Unit Tightening Torque for Fixing Bolts".)

3. When using the adjust bolt to perform stroke adjustment, fix the adjust bolt so that it is on the same side as the shock absorber.

Fix the adjust bolt on the same side as the shock absorber that was used for stroke adjustment.

If the shock absorber's stopper side and the front end of the adjust bolt are not on the same side, the slide table stopping position becomes unstable, and durability may drop.

4. Securing the unit body

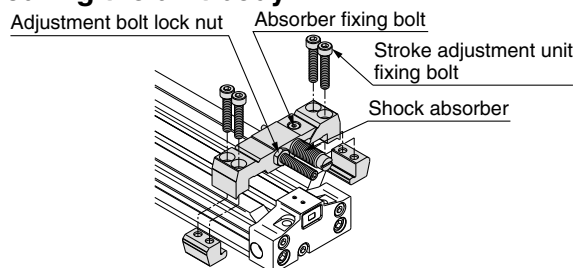

Tighten the four unit fixing bolts equally to secure the unit body.

5. Do not fix and use the stroke adjustment unit at an intermediate position.

If the stroke adjustment unit is fixed at an intermediate position, an error may result depending on the collision energy. In that case, the use of the holder mounting bracket for adjustment is recommended. It is provided with the "-X416" or "-X417" made-to-order specification. For other lengths, please consult with SMC.

(Refer to "Stroke Adjustment Unit Tightening Torque for Fixing Bolts".)

If the stroke adjustment unit is fixed at an intermediate position, the energy absorption capacity may be different. For this reason, refer to the maximum absorbed energy listed above, and use the adjustment unit within the allowable absorption capacity.

Mechanically Jointed Rodless Cylinder Slide bearing guide type

Series MY3M

∅16, ∅25, ∅40, ∅63

How to Order

Slide bearing guide type

MY3 M 16 [] - 300 HL - M9BW [] - []

Slide bearing guide type

Cylinder bore size

16	16 mm
25	25 mm
40	40 mm
63	63 mm

Port thread type

Symbol	Type	Bore size
Nil	M5	∅16
	Rc	
TN	NPT	∅25, ∅40, ∅63
TF	G	

Stroke

* Refer to "Standard Stroke" table on page 32 for further information.

Number of auto switches

Nil	2 pcs.
S	1 pc.
n	"n" pcs.

Made to Order
For details, refer to page 32.

Auto switch

Nil	Without auto switch (Built-in magnet)
-----	---------------------------------------

* Refer to the table below for auto switch model numbers.

Stroke adjustment unit

Nil	Without adjustment unit
L	With shock absorbers for low load on both sides
H	With shock absorbers for high load on both sides
LS	With a shock absorber for low load on left side
SL	With a shock absorber for low load on right side
HS	With a shock absorber for high load on left side
SH	With a shock absorber for high load on right side
LH	With L unit on left side and H unit on right side
HL	With H unit on left side and L unit on right side

Stroke adjustment unit appearance and mounting direction

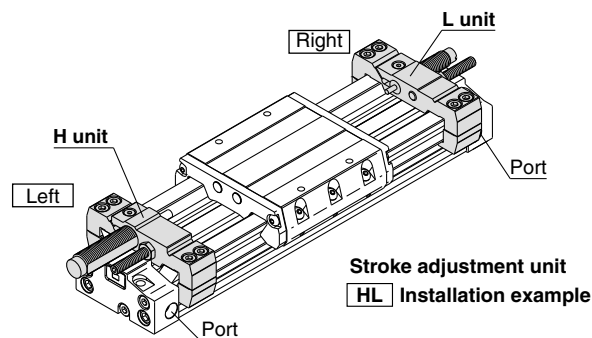

Applicable Auto Switches/ Refer to Best Pneumatics No. 2, pages 1263 to 1371 for further information on auto switches.

Type	Special function	Electrical entry	Indicator/light	Wiring (Output)	Load voltage		Auto switch model		Lead wire length (m)				Pre-wired connector	Applicable load			
					DC	AC	Perpendicular	In-line	0.5 (Nil)	1 (M)	3 (L)	5 (Z)					
Solid state switch	Diagnostic indication (2-color indication)	Grommet	Yes	3-wire (NPN)	24 V	5 V, 12 V	—	M9NV	M9N	●	●	●	○	○	IC circuit	Relay, PLC	
				3-wire (PNP)				M9PV	M9P	●	●	●	○	○			
				2-wire				M9BV	M9B	●	●	●	○	○			
				3-wire (NPN)				M9NWV	M9NW	●	●	●	○	○			
				3-wire (PNP)				M9PWV	M9PW	●	●	●	○	○			
				2-wire				M9BWV	M9BW	●	●	●	○	○			
Reed switch	—	Grommet	Yes	3-wire (NPN equiv.)	24 V	5 V	—	A96V	A96	●	—	●	—	—	IC circuit	—	
				2-wire				100 V	A93V	A93	●	—	●	—	—	—	Relay, PLC
								100 V or less	A90V	A90	●	—	●	—	—	—	IC circuit

* Lead wire length symbols: 0.5 m Nil (Example) M9NW
1 m M (Example) M9NWM
3 m L (Example) M9NWL
5 m Z (Example) M9NWZ

* Solid state auto switches marked with a "○" symbol are produced upon receipt of order.

* Refer to page 38 for further details on other applicable auto switches that are not listed above.

* Refer to Best Pneumatics No. 2, pages 1328 and 1329 for the details of auto switches with a pre-wired connector.

* Auto switches are shipped together, but not assembled.

Series MY3M

Specifications



Symbol

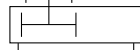

Bore size (mm)	16	25	40	63
Fluid	Air			
Action	Double acting			
Operating pressure range	0.15 to 0.7 MPa			
Proof pressure	1.05 MPa			
Ambient and fluid temperature	5 to 60°C			
Cushion	Air cushion			
Lubrication	Not required (Non-lube)			
Stroke length tolerance	1000 mm or less $+1.8$ ₀ , From 1001 mm $+2.8$ ₀			
Port size (Rc, NPT, G)	M5 x 0.8	1/8	1/4	3/8

Piston Speed

Bore size (mm)	16	25	40	63
Without stroke adjustment unit	80 to 1000 mm/s			
Stroke adjustment unit (L and H unit)	80 to 1500 mm/s			
* External shock absorber	80 to 1500 mm/s			

* When the RB series is used, operate at a piston speed that will not exceed the absorption capacity of the air cushion and stroke adjustment unit.

* Because of its structure, the fluctuation of this cylinder's operating speed is greater than rod type cylinders. For applications that require constant speed, select an applicable equipment for the level of demand.

Standard Stroke

Bore Size (mm)	Standard Stroke (mm)*	Max. manufacturable stroke (mm)
16, 25 40, 63	100, 200, 300, 400, 500, 600 700, 800, 900, 1000, 1200 1400, 1600, 1800, 2000	3000

* Strokes are manufacturable in 1 mm increments, up to the maximum stroke.

However, when exceeding 2000 mm stroke, add "-XB11" to the end of the model number. Refer to "Made to Order" on page 40.

Stroke Adjustment Unit Specifications

Bore size (mm)	16		25		40		63	
Unit symbol	L	H	L	H	L	H	L	H
Shock absorber model	RB0806	RB1007	RB1007	RB1412	RB1412	RB2015	RB2015	RB2725
Shock absorber soft type Series RJ (-XB22) model	RJ0806H	RJ1007H	RJ1007H	RJ1412H	RJ1412H	—	—	—
Fine stroke adjustment range (mm)	0 to -10		0 to -12		0 to -16		0 to -24	



Made to Order

(For details, refer to pages 40 to 44.)

Symbol	Specification
-XB11	Long stroke type
-XB22	Shock absorber soft type Series RJ type
-X168	Helical insert thread
-X416	Holder mounting bracket I
-X417	Holder mounting bracket II

Shock Absorber Specifications

Model	RB 0806	RB 1007	RB 1412	RB 2015	RB 2725	
Max. energy absorption (J)	2.9	5.9	19.6	58.8	147	
Stroke absorption (mm)	6	7	12	15	25	
Max. collision speed (mm/s)	1500					
Max. operating frequency (cycle/min)	80	70	45	25	10	
Spring force (N)	Extended	1.96	4.22	6.86	8.34	8.83
	Compressed	4.22	6.86	15.98	20.50	20.01
Operating temperature range (°C)	5 to 60					

Note) The shock absorber service life is different from that of the MY3M cylinders depending on operating conditions. Allowable operating cycle under the specifications set in this catalog is shown below.

1.2 million times RB08□□
2 million times RB10□□ to RB2725

Note) Specified service life (suitable replacement period) is the value at room temperature (20 to 25°C). The period may vary depending on the temperature and other conditions. In some cases the absorber may need to be replaced before the allowable operating cycle above.

Theoretical Output

Bore size (mm)	Piston area (mm ²)	Operating pressure (MPa)						
		0.2	0.3	0.4	0.5	0.6	0.7	0.8
16	200	40	60	80	100	120	140	160
25	490	98	147	196	245	294	343	392
40	1256	251	377	502	628	754	879	1005
63	3115	623	934	1246	1557	1869	2180	2492

Note) Theoretical output (N) = Pressure (MPa) x Piston area (mm²)

Weight

Model	Bore size (mm)	Basic weight	Additional weight per 50 mm stroke	Stroke adjustment unit weight (per unit)	
				L unit weight	H unit weight
MY3M	16	0.29	0.08	0.05	0.06
	25	0.90	0.21	0.12	0.17
	40	3.03	0.31	0.34	0.43
	63	8.63	0.68	0.69	0.91

Calculation method/Example: **MY3M25-400H**

Basic weight 0.90 kg Cylinder stroke 400 st

Additional weight 0.21/50 st $0.90 + 0.21 \times 400 \div 50 + 0.17 \times 2 \cong 2.92$ kg

H unit weight 0.17 kg

Option/Stroke Adjustment Unit Model

Model	Bore size (mm)		16	25	40	63
	Unit					
MY3M	L unit	Left	MY3M-A16L1	MY3M-A25L1	MY3M-A40L1	MY3M-A63L1
		Right	MY3M-A16L2	MY3M-A25L2	MY3M-A40L2	MY3M-A63L2
	H unit	Left	MY3M-A16H1	MY3M-A25H1	MY3M-A40H1	MY3M-A63H1
		Right	MY3M-A16H2	MY3M-A25H2	MY3M-A40H2	MY3M-A63H2

Series MY3M

Construction

MY3M

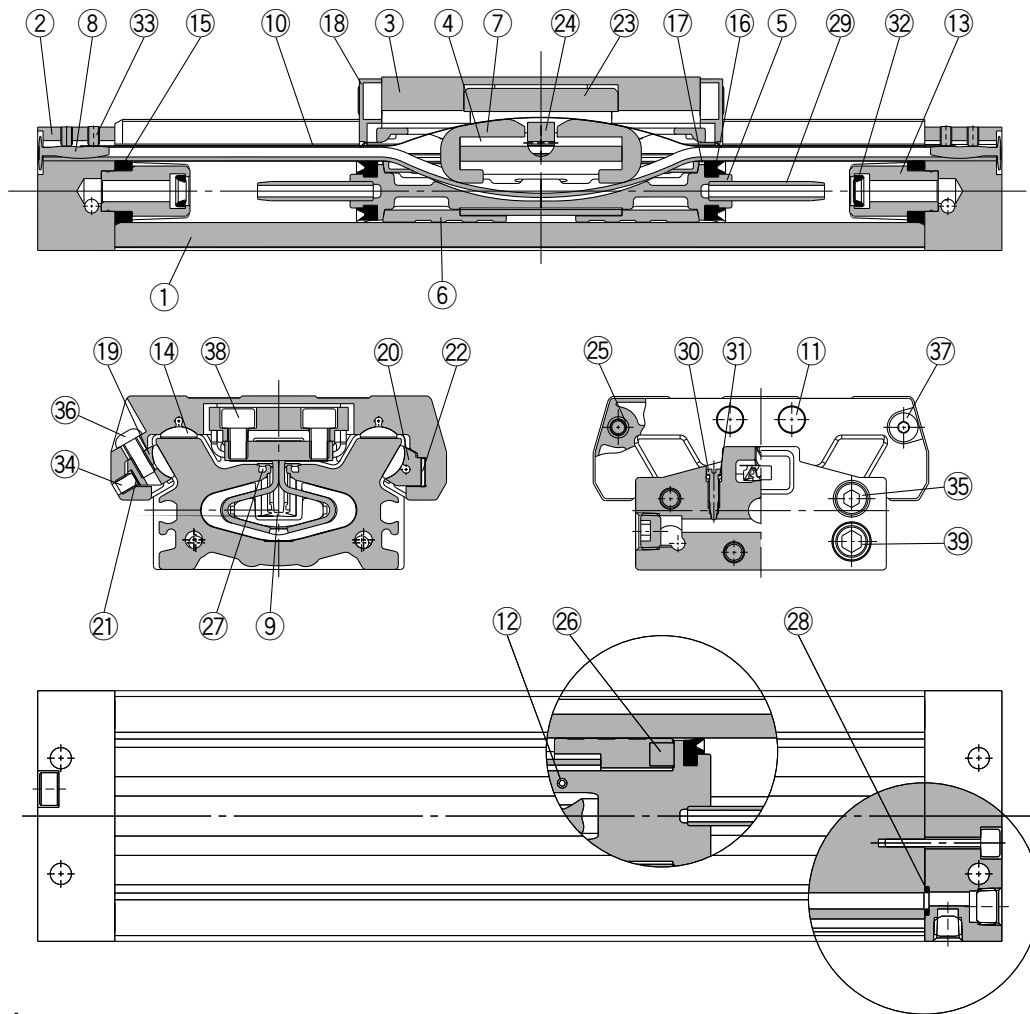

Component Parts

No.	Description	Material	Note
1	Cylinder tube	Aluminum alloy	Hard anodized
2	Head cover	Aluminum alloy	Hard anodized
3	Slide table	Aluminum alloy	Hard anodized
4	Piston yoke	Stainless steel	
5	Piston	Aluminum alloy	Chromated
6	Wear ring	Polyacetal	
7	Belt separator	Polyacetal	
8	Belt clamp	Polybutylene terephthalate	
11	Stopper	Carbon steel	Nickel plated
12	Spring pin	Carbon tool steel	
13	Cushion boss	Aluminum alloy	Chromated
14	Bearing	Polyacetal	
17	Inner wiper	Special resin	
18	End cover	Polyamide	
19	Adjust arm A	Aluminum alloy	Chromated
20	Adjust arm B	Aluminum alloy	Chromated

No.	Description	Material	Note
21	Backup spring	Stainless steel	
22	Bearing adjustment rubber	NBR	
23	Coupler body	Aluminum alloy	Hard anodized
24	Coupler pin	Carbon steel	Electroless nickel plated
25	Spacer	Stainless steel	
26	Magnet	—	
27	Seal magnet	Rubber magnet	
29	Cushion ring	Brass	
30	Cushion needle	Rolled steel	Nickel plated
33	Hexagon socket head set screw	Chrome molybdenum steel	Nickel plated
34	Hexagon socket head set screw	Chrome molybdenum steel	Nickel plated
35	Hexagon socket head cap screw	Chrome molybdenum steel	Nickel plated
36	Hexagon socket button head screw	Chrome molybdenum steel	Nickel plated
37	Hexagon socket button head screw	Chrome molybdenum steel	Nickel plated
38	Hexagon socket head cap screw	Chrome molybdenum steel	Nickel plated
39	Hexagon socket head plug	Carbon steel	Nickel plated

Replacement Parts/Seal

No.	Description	Material	Qty.	MY3M16	MY3M25	MY3M40	MY3M63
9	Seal belt	Polyamide	1	MY3B16-16A-Stroke	MY3B25-16A-Stroke	MY3B40-16A-Stroke	MY3B63-16A-Stroke
10	Dust seal band	Stainless steel	1	MY3B16-16B-Stroke	MY3B25-16B-Stroke	MY3B40-16B-Stroke	MY3B63-16B-Stroke
15	Tubing gasket	NBR	2	RMB-16	RMB-25	RMB-40	RMB-63
16	Piston seal	NBR	2	RMY-16	RMY-25	RMY-40	RMY-63
28	O-ring	NBR	4	ø6.2 x ø3 x ø1.6	C-5	ø10.5 x ø8.5 x ø1	C-14
31	O-ring	NBR	2	ø4 x ø1.8 x ø1.1	ø4 x ø1.8 x ø1.1	ø7.15 x ø3.75 x ø1.7	ø8.3 x ø4.5 x ø1.9
32	Cushion seal	NBR	2	MCS-3	MCS-5	RCS-8	RCS-12

* Since the seal kit does not include a grease pack, order it separately.

Grease pack part no.: GR-S-010 (10 g)

* For instructions on how to replace replacement parts/seals, refer to the operation manual.

Slide Bearing Guide Type: $\varnothing 16$, $\varnothing 25$, $\varnothing 40$, $\varnothing 63$

MY3M Bore size — Stroke

* Refer to "Specific Product Precautions" on front matter 7 for mounting.

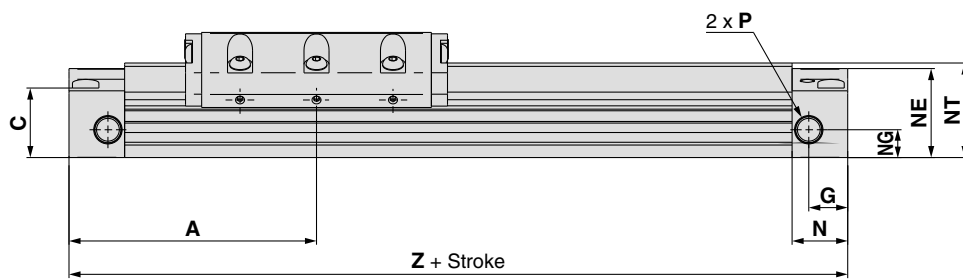
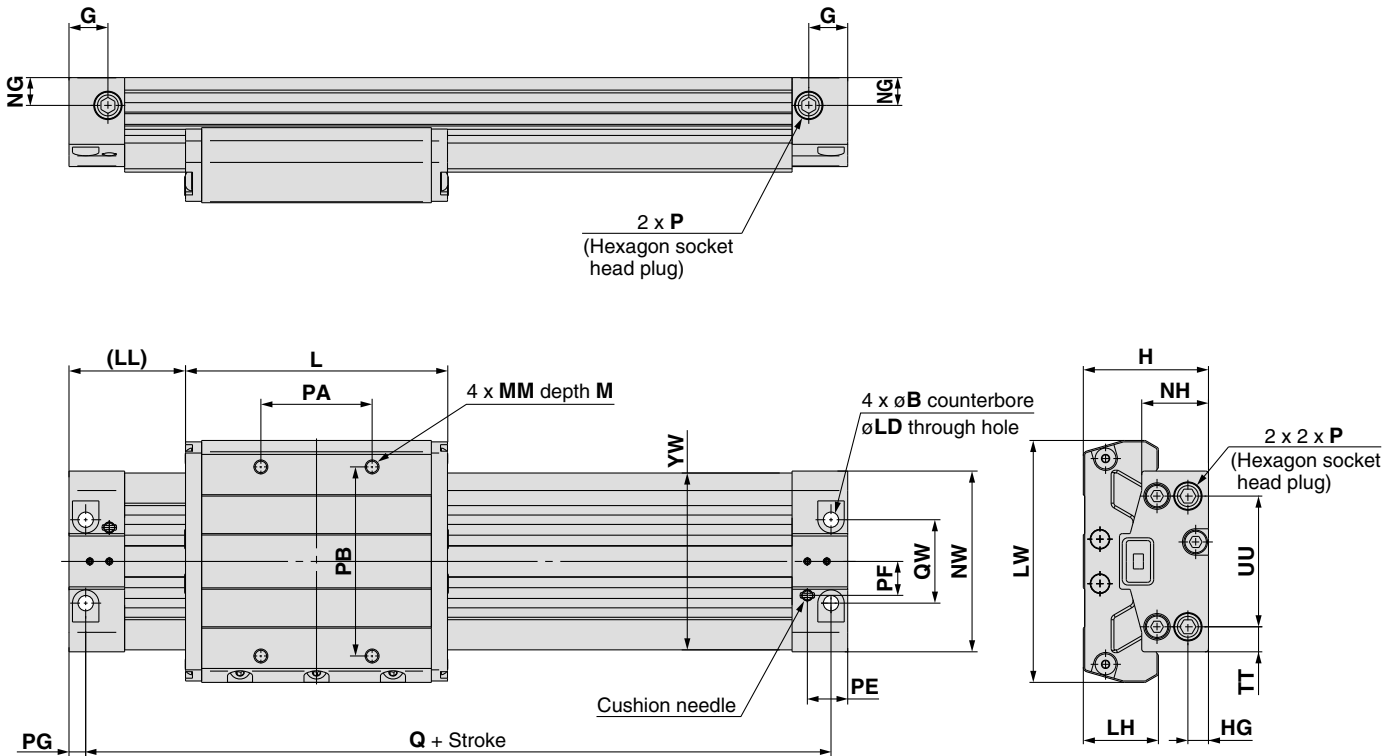

Port Variation

* Head cover piping connection can be freely selected to best suit different piping conditions.

Slide table operating direction

Model	A	B	C	G	H	HG	L	LD	LH	LL	LW	M	MM	N	NE	NG
MY3M16	61	6	18	9.5	33	5	65	3.5	20.5	28.5	64	6	M4 x 0.7	13.5	22.5	8
MY3M25	89	9.5	25	14	45	7.4	95	5.5	27	41.5	87	10	M5 x 0.8	20	32	10
MY3M40	138	14	38	18	63	12	160	8.6	35	58	124	13	M6 x 1.0	27	46	15
MY3M63	178	17	60	20.5	93	16.5	220	11	46	68	176	15	M10 x 1.5	31	70	29

Model	NH	NT	NW	P	PA	PB	PE	PF	PG	Q	QW	TT	UU	YW	Z
MY3M16	17.2	24	43	M5 x 0.8	28	48	9.7	8.5	4	114	19	6.5	30	44.6	122
MY3M25	24	34	65	Rc, NPT, G1/8	40	68	14.5	12.2	6	166	30	9	47	63.6	178
MY3M40	37	49	94	Rc, NPT, G1/4	100	100	19.5	16.5	8.5	259	40	14	66	93.6	276
MY3M63	58	76	139	Rc, NPT, G3/8	130	150	23.5	27.5	10	336	64	20	99	138	356

Series MY3M

Slide Bearing Guide Type: $\varnothing 16$, $\varnothing 25$, $\varnothing 40$, $\varnothing 63$

Stroke adjustment unit

Low load shock absorber + Adjustment bolt

MY3M Bore size – Stroke L

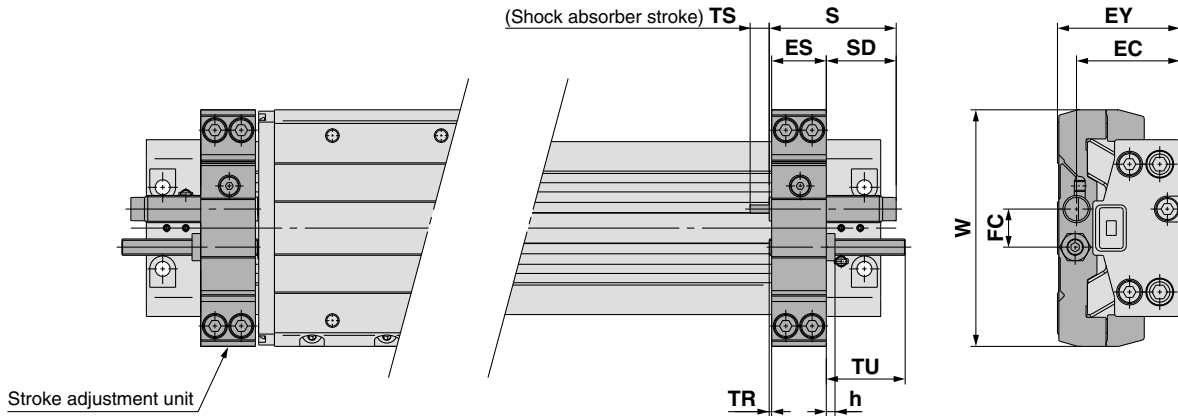

Applicable cylinder	ES	EC	EY	FC	h	S	SD	TS	TR	TU	W	Shock absorber model
MY3M16	14.1	27.5	32.5	9	2.4	40.8	25.8	6	0.9	25	64	RB0806
MY3M25	20.1	38	44.5	14	3.6	46.7	25.2	7	1.4	28.5	87	RB1007
MY3M40	30.1	54	62.5	24	5	67.3	36.3	12	0.9	39	124	RB1412
MY3M63	36.1	81	92.5	32	6	73.2	36.2	15	0.9	43	176	RB2015

Note) When the stroke adjustment unit is used, the fitting type, which can be connected with the port on the body front and the back, will be limited. Refer to front matter 6 for details.

Heavy-loaded shock absorber + Adjustment bolt

MY3M Bore size – Stroke H

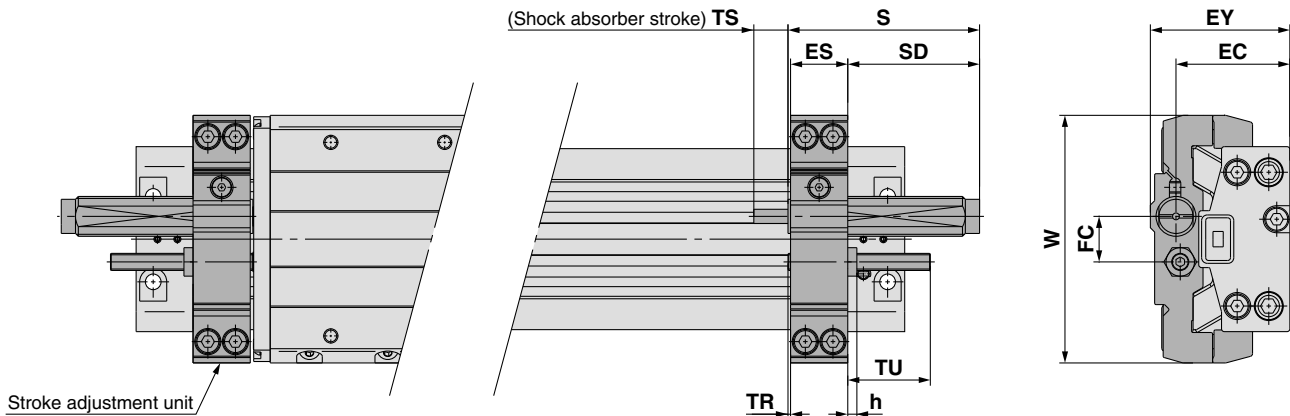

Applicable cylinder	ES	EC	EY	FC	h	S	SD	TS	TR	TU	W	Shock absorber model
MY3M16	14.1	28.5	34.5	11	2.4	46.7	31.7	7	0.9	25	64	RB1007
MY3M25	20.1	40	49	16	3.6	67.3	45.8	12	1.4	28.5	87	RB1412
MY3M40	30.1	57	69	26	5	73.2	42.2	15	0.9	39	124	RB2015
MY3M63	36.1	84.5	100	32	6	99	62	25	0.9	43	176	RB2725

Note) When the stroke adjustment unit is used, the fitting type, which can be connected with the port on the body front and the back, will be limited. Refer to front matter 6 for details.

Side Support

Side support A MY-S□A

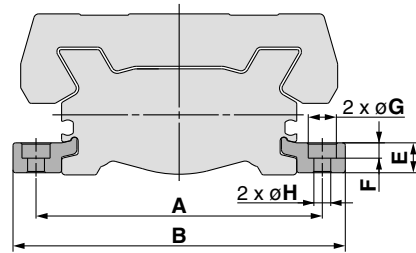
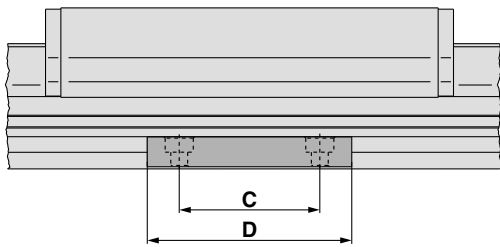

Side support B MY-S□B

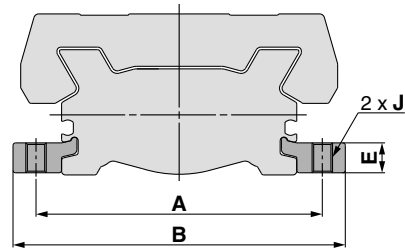
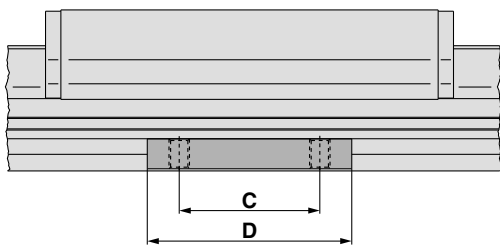

(mm)

Model	Applicable cylinder	A	B	C	D	E	F	G	H	J
MY-S16 ^{A/B}	MY3M16	53	63.6	15	26	4.9	3	6.5	3.4	M4 x 0.7
MY-S25 ^{A/B}	MY3M25	77	91	35	50	8	5	9.5	5.5	M6 x 1
MY-S32 ^{A/B}	MY3M40	112	130	45	64	11.7	6	11	6.6	M8 x 1.25
MY-S40 ^{A/B}	MY3M63	160	182	55	80	14.8	8.5	14	9	M10 x 1.5

Note) A set of side supports consists of a left support and a right support.

Guide for Using Side Support

For long stroke operation, the cylinder tube may be deflected depending on its own weight and the load weight. In such a case, use a side support in the middle section. The spacing (ℓ) of the support must be no more than the values shown in the graph on the right.

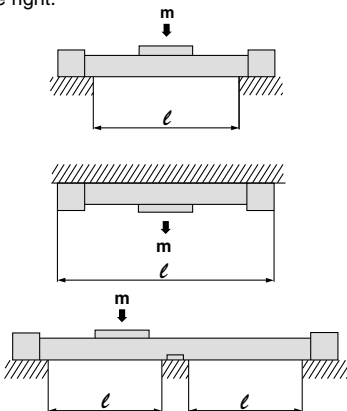

⚠ Caution

- ① If the cylinder mounting surfaces are not measured accurately, using a side support may cause poor operation. Therefore, be sure to level the cylinder tube when mounting. Also, for long stroke operation involving vibration and impact, use of a side support is recommended even if the spacing value is within the allowable limits shown in the graph.
- ② Support brackets are not for mounting; use them solely for providing support.

Guide for Using MY3M Side Support

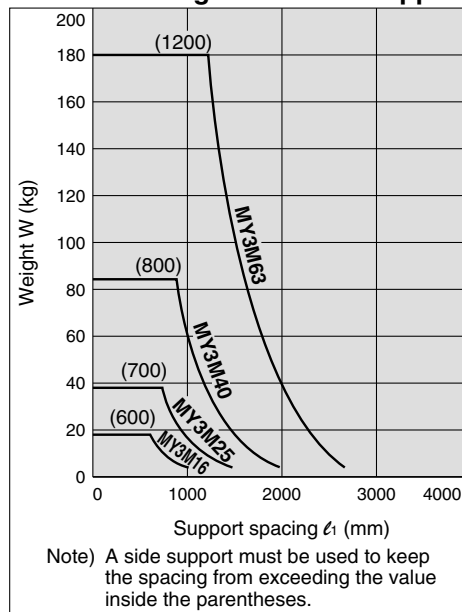

Series MY3

Auto Switch Specifications

Auto Switch Proper Mounting Position (at Stroke End Detection)

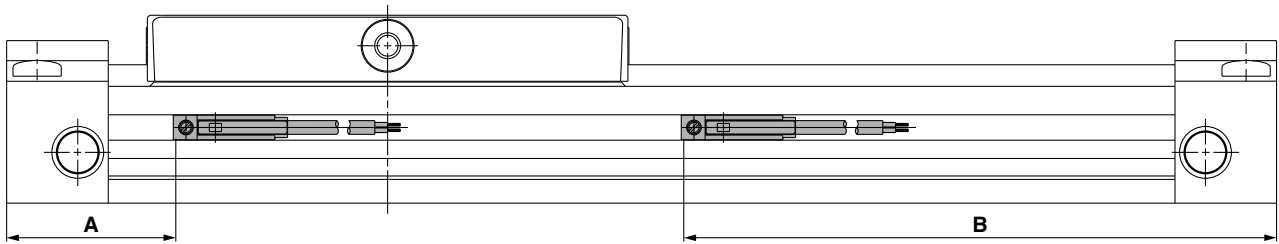

Auto Switch Proper Mounting Position MY3A

Auto switch model	D-M9□ D-M9□V D-M9□W D-M9□WV		D-A9□ D-A9□V	
	A	B	A	B
Bore size 16	26	84	22	88
20	26	102	22	106
25	33	117	29	121
32	40.5	152.5	36.5	156.5
40	46.5	193.5	42.5	197.5
50	47	227	43	231
63	57.5	262.5	53.5	266.5

Note) The values in the table indicate the position of the auto switch's front end. Adjust the auto switch after confirming the operating conditions in the actual setting.

MY3B/MY3M

Auto switch model	D-M9□ D-M9□V D-M9□W D-M9□WV		D-A9□ D-A9□V	
	A	B	A	B
Bore size 16	32	90	28	94
20	36	112	32	116
25	47	131	43	135
32	56.5	168.5	52.5	172.5
40	64.5	211.5	60.5	215.5
50	65	245	61	249
63	75.5	280.5	71.5	284.5

Operating Range

Auto switch model	Bore size (mm)						
	16	20	25	32	40	50	63
D-M9□/M9□V D-M9□W/M9□WV	3.5	5	6	6.5	8	8	8
D-A9□/A9□V	6.5	9.5	10.5	12	15	13.5	14

* Since the operating range is provided as a guideline including hysteresis, it cannot be guaranteed. (Assuming approximately ±30% dispersion.) It may vary substantially depending on an ambient environment.

Auto Switch Mounting

When mounting an auto switch, first hold the switch spacer with your fingers and push it into the groove. Confirm that it is aligned evenly within the groove and adjust the position if necessary. Then, insert the auto switch into the groove and slide it into the spacer.

After deciding on the mounting position within the groove, slip in the mounting screw, which is included, and tighten it, using a flat head watchmaker's screw driver.

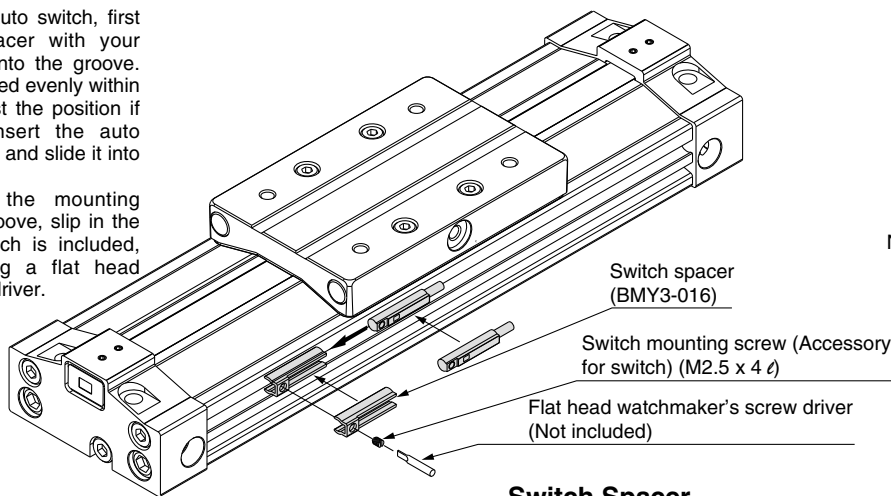

Note) Use a watchmaker's screw driver with a handle diameter of 5 to 6 mm to fasten the auto switch mounting screws.

The tightening torque should be approximately 0.1 to 0.15 N·m. The guideline is a 90° rotation after the fastening is felt.

Switch Spacer

Applicable bore size (mm)	16	20	25	32	40	50	63
Switch spacer	BM Y3-016						

Besides the models listed in How to Order, the following auto switches are applicable.

- * For solid state auto switches, auto switches with a pre-wired connector are also available. Refer to Best Pneumatics No. 2, pages 1328 and 1329 for details.
- * Normally closed (NC = b contact) solid state auto switches (D-F9G/F9H types) are also available. Refer to Best Pneumatics No. 2, page 1290 for details.

Prior to Use

Auto Switch Connections and Examples

Basic Wiring

Solid state 3-wire, NPN

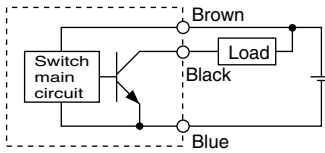

Solid state 3-wire, PNP

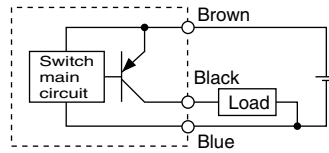

2-wire (Solid state)

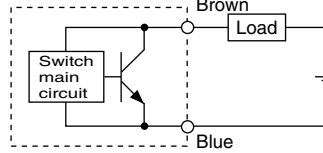

2-wire (Reed)

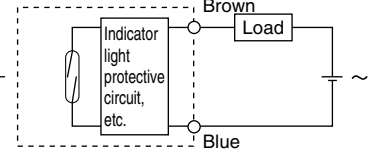

(Power supplies for switch and load are separate.)

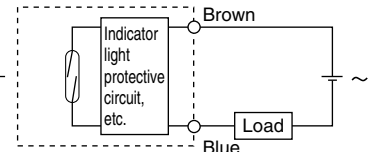
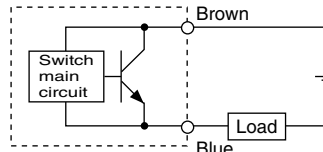
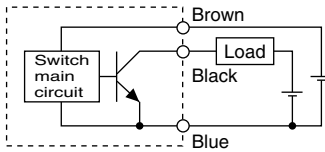

Examples of Connection to PLC (Programmable Logic Controller)

• Sink input specifications 3-wire, NPN

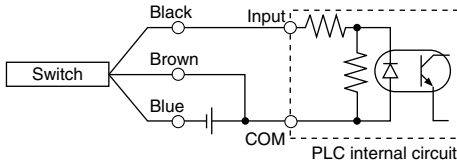

• Source input specifications 3-wire, PNP

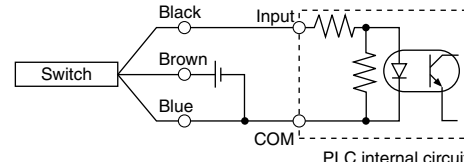

Connect according to the applicable PLC input specifications, as the connection method will vary depending on the PLC input specifications.

2-wire

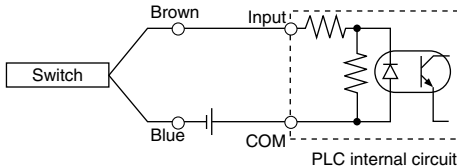

2-wire

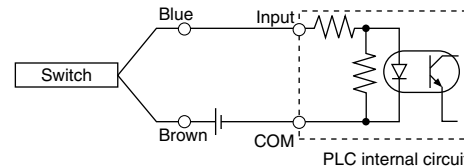

Examples of AND (Series) and OR (Parallel) Connection

• 3-wire (using relays)

AND connection for NPN output (using relays)

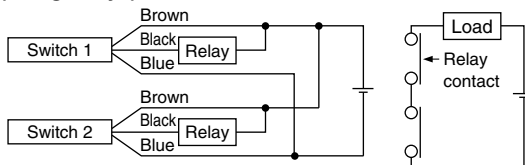

AND connection for NPN output (performed with switches only)

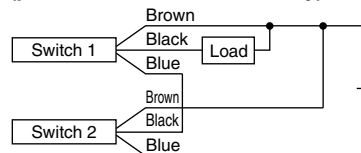

OR connection for NPN output

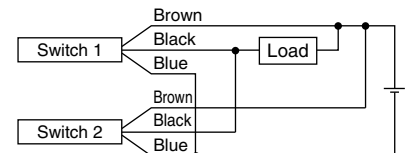

The indicator light illuminates when the two switches are in the ON state.

2-wire with 2-switch AND connection

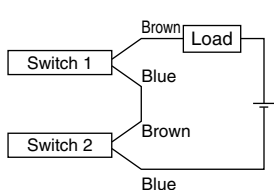

When two switches are connected in series, a load may malfunction because the load voltage will decline when in the ON state. The indicator lights will light when both switches are in the ON state.

$$\begin{aligned} \text{Load voltage at ON} &= \text{Power supply voltage} - \\ &\quad \text{Internal voltage drop} \times 2 \text{ pcs.} \\ &= 24 \text{ V} - 4 \text{ V} \times 2 \text{ pcs.} \\ &= 16 \text{ V} \end{aligned}$$

Example: Power supply is 24 VDC
Internal voltage drop in switch is 4 V.

2-wire with 2-switch OR connection

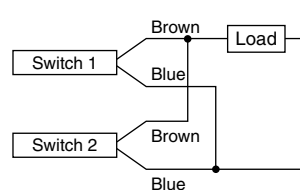

(Solid state)

When two switches are connected in parallel, malfunction may occur because the load voltage will increase when in the OFF state.

$$\begin{aligned} \text{Load voltage at OFF} &= \text{Leakage current} \times 2 \text{ pcs.} \times \\ &\quad \text{Load impedance} \\ &= 1 \text{ mA} \times 2 \text{ pcs.} \times 3 \text{ k}\Omega \\ &= 6 \text{ V} \end{aligned}$$

Example: Load impedance is 3 kΩ.
Leakage current from switch is 1 mA.

(Reed)

Because there is no current leakage, the load voltage will not increase when turned OFF. However, depending on the number of switches in the ON state, the indicator lights may sometimes glow dim or not light up because of the dispersion and reduction of the current flowing to the switches.

Series MY3 Made to Order Specifications 1



Please contact SMC for detailed dimensions, specifications and delivery lead times.

Applicable type

Cylinder model	Category/Type	Long stroke	Shock absorber soft type installed	Helical insert thread	Holder mounting bracket	Copper-free
		XB11	XB22	X168	X416-X417	20-
MY3A	Basic short type	●	—	●	—	●
MY3B	Basic standard type	●	●	●	●	●
MY3M	Slide bearing type	●	●	●	●	●

1 Long Stroke -XB11

Available with long strokes exceeding the standard strokes.
The stroke can be set in 1 mm increments.

■ Stroke range: 2001 to 3000 mm

MY3 **A** **Bore size** - **Stroke** - **Auto switch** **Symbol** - XB11

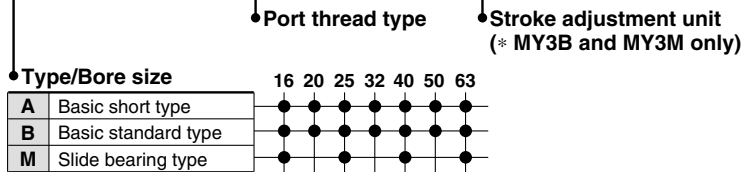

Example) MY3A40-2700-M9B-XB11

2 Shock Absorber Soft Type Series RJ Type -XB22

The standard cylinder has been equipped with shock absorber soft type Series RJ type to enable soft stopping at the stroke end.

MY3 **B** **16** - **200** **L** - XB22

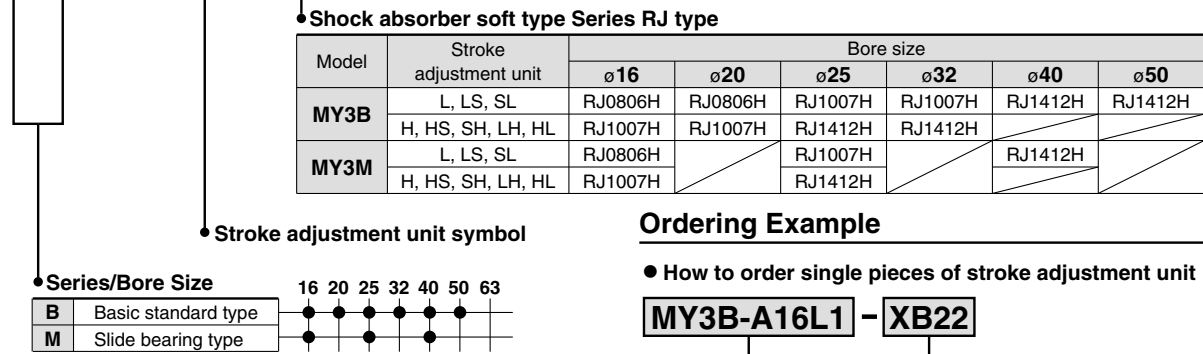

Ordering Example

• How to order single pieces of stroke adjustment unit

MY3B-A16L1 - **XB22**

• Shock absorber soft type Series RJ type

• Stroke adjustment unit model
Refer to the options table of "How to Order".
MY3B → page 15, MY3M → page 33

* For details on shock absorber soft type Series RJ, refer to the catalog (CAT.ES20-200).

Absorption Capacity of Stroke Adjustment Unit

MY3B16

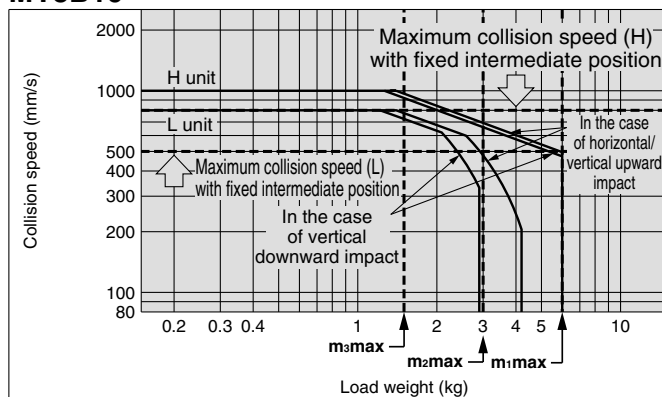

MY3B20

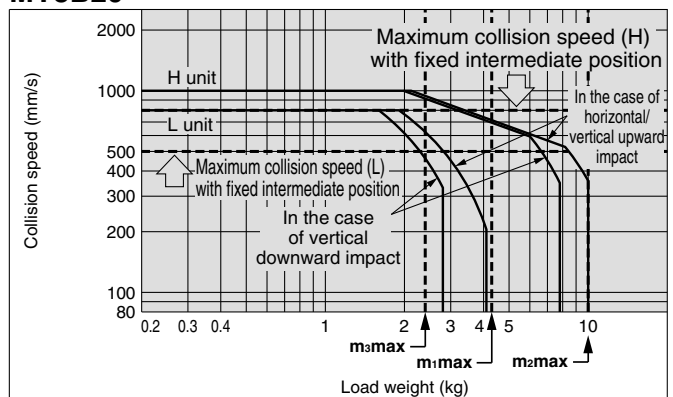

Series MY3 Made to Order Specifications 2



Please contact SMC for detailed dimensions, specifications and delivery lead times.

2 Shock Absorber Soft Type Series RJ Type

-XB22

Absorption Capacity of Stroke Adjustment Unit

MY3B25

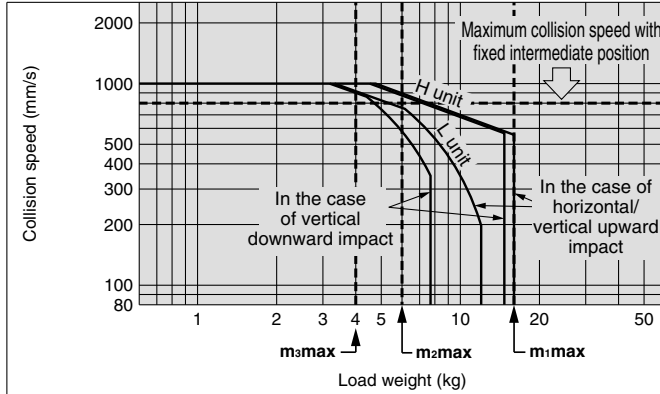

MY3B32

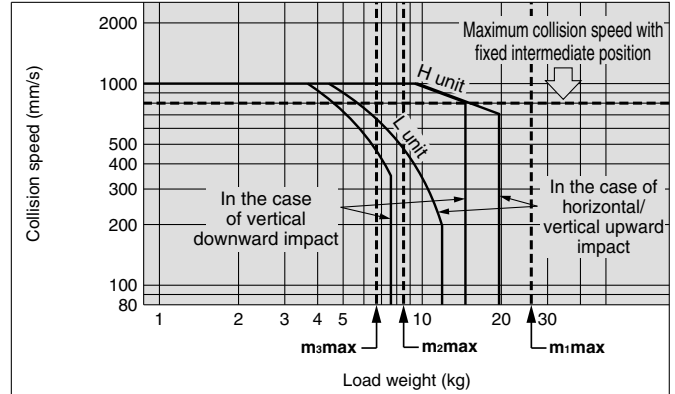

MY3B40

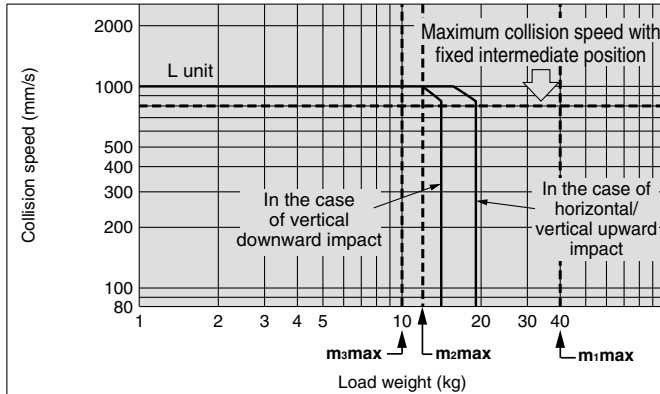

MY3B50

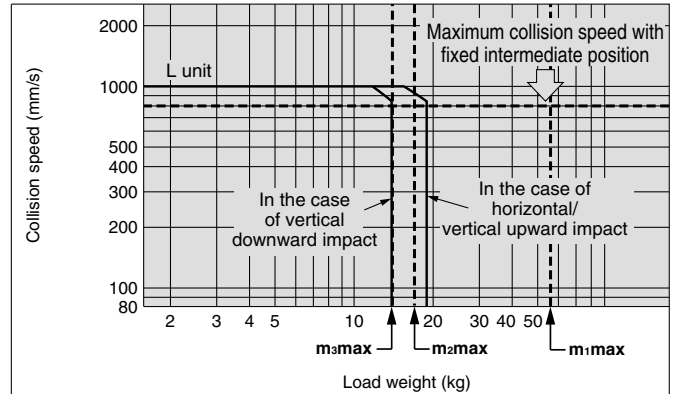

MY3M16

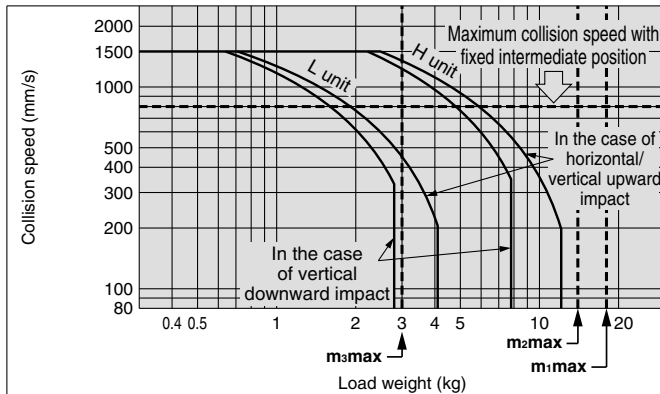

MY3M25

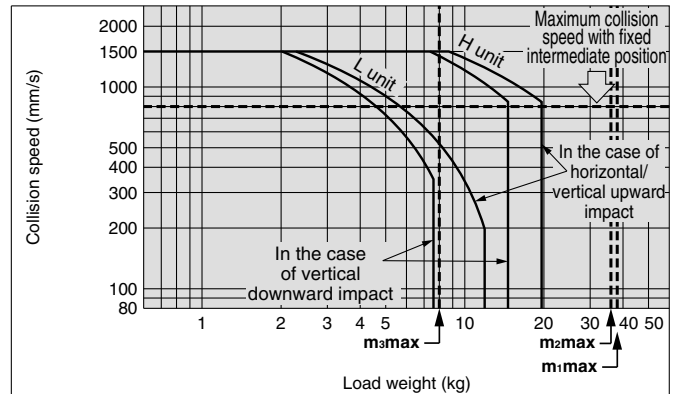

MY3M40

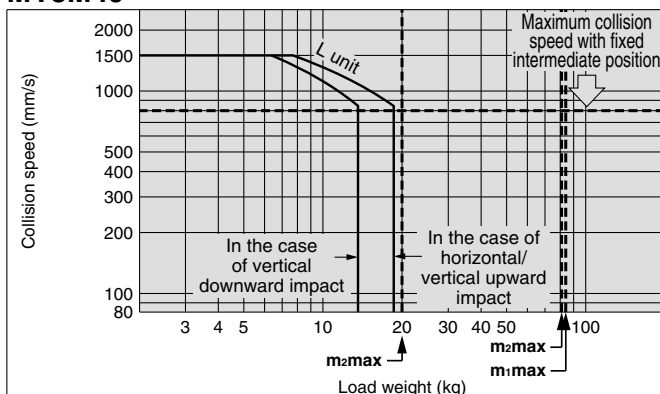

Series MY3 Made to Order Specification 3



Please contact SMC for detailed dimensions, specifications and delivery lead times.

3 Helical Insert Threads

-X168

The mounting threads of the slider are changed to helical insert threads.
The thread size is the same as standard.

MY3 **B** Bore size - Stroke - Auto switch Symbol - X168

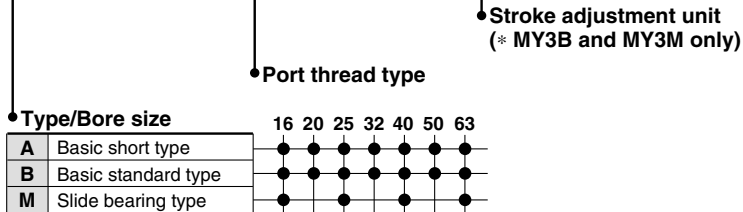

Example) MY3B16-300L-M9B-X168

4 Holder Mounting Bracket ①, ②

-X416/X417

Holder mounting brackets are used to fasten the stroke adjustment unit at an intermediate stroke position.

Holder mounting bracket ① -X416 Holder mounting bracket ② -X417

Fine Stroke Adjustment Range

(Treated as a special order when exceeding the adjustment ranges shown below.) Unit: mm

Bore size (mm)	-X416 (one side)		-X417 (one side)	
	Spacer	Adjustment range	Spacer	Adjustment range
	Length (ℓ)	MY3B/MY3M	Length (ℓ)	MY3B/MY3M
16, 20	10	-10 to -20	20	-20 to -30
25, 32	12	-12 to -24	24	-24 to -36
40, 50	16	-16 to -32	32	-32 to -48
63	24	-24 to -48	48	-48 to -72

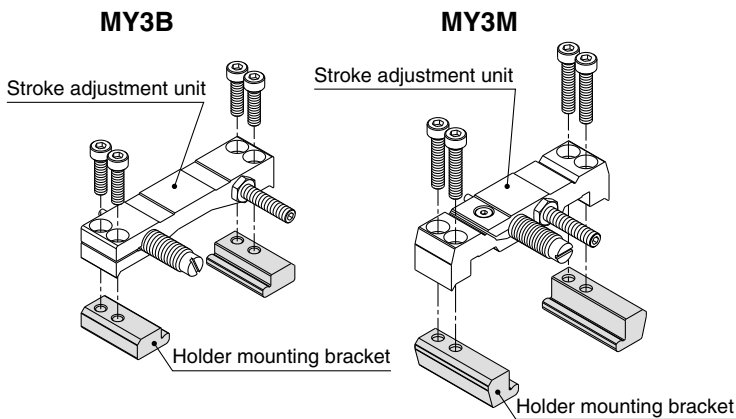
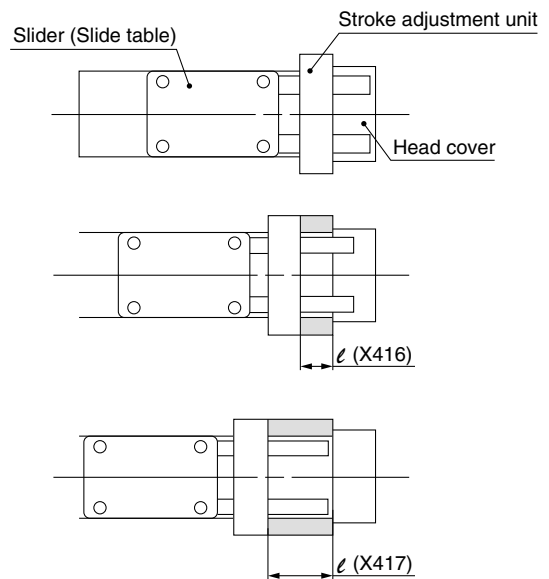

Series MY3 Made to Order Specification 4



Please contact SMC for detailed dimensions, specifications and delivery lead times.

4 Holder Mounting Bracket ①, ② -X416/X417

MY3 **B** Bore size - 300 **L** - **X416**

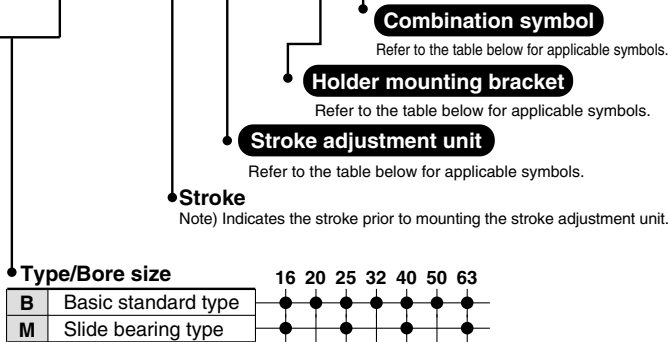

Stroke adjustment range

		0	-10	-20	-30	-40	-50	-60	-70	-80	
MY3□16	L unit	0 to 10 10 to 20 20 to 30									
	H unit	Standard	-X416	-X417							
MY3□25	L unit	0 to 12 12 to 24 24 to 36									
	H unit	Standard	-X416	-X417							
MY3□40	L unit	0 to 16 16 to 32 32 to 48									
	H unit	Standard	-X416	-X417							
MY3□50	L unit	0 to 16 16 to 32 32 to 48									
	H unit	Standard	-X416	-X417							
MY3□63	L unit	0 to 24 24 to 48 48 to 72									
	H unit	Standard	-X416	-X417							

Stroke adjustment unit	Holder mounting bracket	Suffix	Mounting pcs.		Combination description	
			X416	X417		
L, H, LS, SL, HS, SH	X416	Nil	1		X416 on one side * Note 2)	
		W	2		X416 on both sides	
		Z	1	1	X416 on left side, X417 on the other side * Note 2)	
L		1		X416 on L unit side		
H		1		X416 on H unit side		
LZ		1	1	X416 on L unit side, X417 on the other side		
L, H, LS, SL, HS, SH	X417	Nil		1	X417 on one side * Note 2)	
		W		2	X417 on both sides	
		L		1	X417 on L unit side	
H			1	X417 on H unit side		
LH, HL						
HZ		1	1	X416 on H unit side, X417 on the other side		

Note 1) For LS, SL, HS and SH, the stroke adjustment unit is mounted on one side only.

Note 2) The stroke adjustment unit is installed on the left side (or right side in case of SL and SH) at the time of shipment. It can however be moved to the right side (or left side).

Ordering Example

- L units with one each of X416 and X417

MY3B25-300L-X416Z

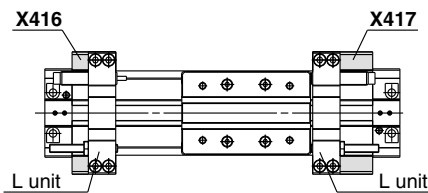

- L and H units, where X417 is mounted on L unit only and nothing on H unit

MY3B25-300LH-X417L

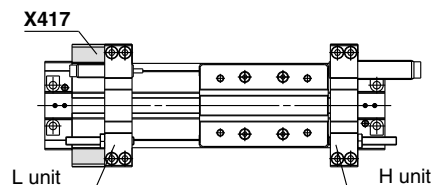

- How to order single pieces of stroke adjustment unit

MY3B-A16L1 - X417

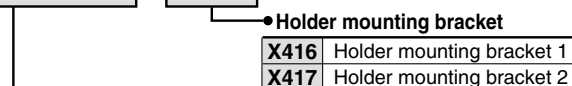

- Stroke adjustment unit model

Note) Refer to the options table of "How to Order" for each series.

MY3B → Page 15, MY3M → Page 33

Example) MY3B-A25L1-X416

(Left side L unit of MY3B25 and X416 bracket)

- How to order single pieces of holder mounting bracket

MY3 **B** - **A25** - **X417** **N**

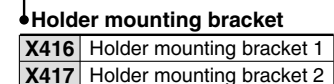

- Series/Nominal

Symbol	Nominal	16	25	40	63			
	Compatible bore size	16	20	25	32	40	50	63
B	Basic standard type	●	●	●	●	●	●	●
M	Slide bearing type	●	●	●	●	●	●	●

Note) The holder mounting bracket can be used on both the left and right side of the L and H units.

Example) MY3B-A25-X416N

(X416 bracket for L and H units of MY3B25, 32)

Series MY3 Made to Order Specification 5

Please contact SMC for detailed dimensions, specifications and delivery lead times.



5 Copper-free

20-

For copper-free applications

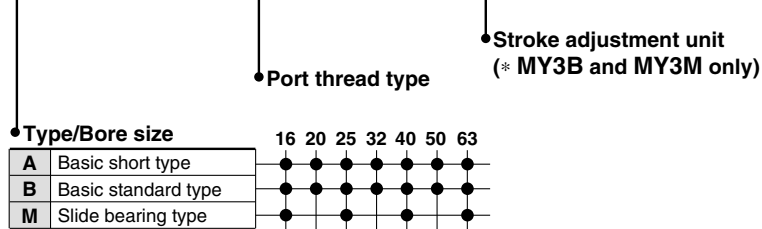

20-MY3 **M** **Bore size** **Stroke** **Auto switch** **Symbol**



Example) 20-MY3M25-300-M9B

Safety Instructions

These safety instructions are intended to prevent hazardous situations and/or equipment damage. These instructions indicate the level of potential hazard with the labels of “**Caution**,” “**Warning**” or “**Danger**.” They are all important notes for safety and must be followed in addition to International Standards (ISO/IEC)*1, and other safety regulations.

-  **Caution:** **Caution** indicates a hazard with a low level of risk which, if not avoided, could result in minor or moderate injury.
-  **Warning:** **Warning** indicates a hazard with a medium level of risk which, if not avoided, could result in death or serious injury.
-  **Danger:** **Danger** indicates a hazard with a high level of risk which, if not avoided, will result in death or serious injury.

- *1) ISO 4414: Pneumatic fluid power – General rules relating to systems.
ISO 4413: Hydraulic fluid power – General rules relating to systems.
IEC 60204-1: Safety of machinery – Electrical equipment of machines.
(Part 1: General requirements)
ISO 10218-1: Manipulating industrial robots - Safety.
etc.

Warning

- 1. The compatibility of the product is the responsibility of the person who designs the equipment or decides its specifications.**
Since the product specified here is used under various operating conditions, its compatibility with specific equipment must be decided by the person who designs the equipment or decides its specifications based on necessary analysis and test results. The expected performance and safety assurance of the equipment will be the responsibility of the person who has determined its compatibility with the product. This person should also continuously review all specifications of the product referring to its latest catalog information, with a view to giving due consideration to any possibility of equipment failure when configuring the equipment.
- 2. Only personnel with appropriate training should operate machinery and equipment.**
The product specified here may become unsafe if handled incorrectly. The assembly, operation and maintenance of machines or equipment including our products must be performed by an operator who is appropriately trained and experienced.
- 3. Do not service or attempt to remove product and machinery/equipment until safety is confirmed.**
 1. The inspection and maintenance of machinery/equipment should only be performed after measures to prevent falling or runaway of the driven objects have been confirmed.
 2. When the product is to be removed, confirm that the safety measures as mentioned above are implemented and the power from any appropriate source is cut, and read and understand the specific product precautions of all relevant products carefully.
 3. Before machinery/equipment is restarted, take measures to prevent unexpected operation and malfunction.
- 4. Contact SMC beforehand and take special consideration of safety measures if the product is to be used in any of the following conditions.**
 1. Conditions and environments outside of the given specifications, or use outdoors or in a place exposed to direct sunlight.
 2. Installation on equipment in conjunction with atomic energy, railways, air navigation, space, shipping, vehicles, military, medical treatment, combustion and recreation, or equipment in contact with food and beverages, emergency stop circuits, clutch and brake circuits in press applications, safety equipment or other applications unsuitable for the standard specifications described in the product catalog.
 3. An application which could have negative effects on people, property, or animals requiring special safety analysis.
 4. Use in an interlock circuit, which requires the provision of double interlock for possible failure by using a mechanical protective function, and periodical checks to confirm proper operation.

Caution

- 1. The product is provided for use in manufacturing industries.**
The product herein described is basically provided for peaceful use in manufacturing industries.
If considering using the product in other industries, consult SMC beforehand and exchange specifications or a contract if necessary.
If anything is unclear, contact your nearest sales branch.

Limited warranty and Disclaimer/ Compliance Requirements

The product used is subject to the following “Limited warranty and Disclaimer” and “Compliance Requirements”.
Read and accept them before using the product.

Limited warranty and Disclaimer

1. The warranty period of the product is 1 year in service or 1.5 years after the product is delivered.*2)
Also, the product may have specified durability, running distance or replacement parts. Please consult your nearest sales branch.
2. For any failure or damage reported within the warranty period which is clearly our responsibility, a replacement product or necessary parts will be provided.
This limited warranty applies only to our product independently, and not to any other damage incurred due to the failure of the product.
3. Prior to using SMC products, please read and understand the warranty terms and disclaimers noted in the specified catalog for the particular products.

*2) **Vacuum pads are excluded from this 1 year warranty.**
A vacuum pad is a consumable part, so it is warranted for a year after it is delivered.
Also, even within the warranty period, the wear of a product due to the use of the vacuum pad or failure due to the deterioration of rubber material are not covered by the limited warranty.

Compliance Requirements

1. The use of SMC products with production equipment for the manufacture of weapons of mass destruction (WMD) or any other weapon is strictly prohibited.
2. The exports of SMC products or technology from one country to another are governed by the relevant security laws and regulations of the countries involved in the transaction. Prior to the shipment of a SMC product to another country, assure that all local rules governing that export are known and followed.

Record of changes

Edition B	• Addition of mechanically jointed rodless cylinder slide bearing guide type Series MY3M. • Number of pages changed from 40 to 52	KO
Edition C	• Addition of Series MY3A bore sizes $\phi 20$, $\phi 32$ and $\phi 50$. • Addition of Series MY3B bore sizes $\phi 20$, $\phi 32$ and $\phi 50$. • Number of pages changed from 52 to 56	NZ

Safety Instructions

Be sure to read “Handling Precautions for SMC Products” (M-E03-3) before using.

SMC Corporation

Akihabara UDX 15F,
4-14-1, Sotokanda, Chiyoda-ku, Tokyo 101-0021, JAPAN
Phone: 03-5207-8249 Fax: 03-5298-5362
URL <http://www.smcworld.com>
© 2009 SMC Corporation All Rights Reserved

Specifications are subject to change without prior notice
and any obligation on the part of the manufacturer.

D-DN

1st printing LY printing NZ 6000SZ Printed in Japan.

This catalog is printed on recycled paper with concern for the global environment.