

2095362 HPVS-22-30-A Feed separator - Series: All

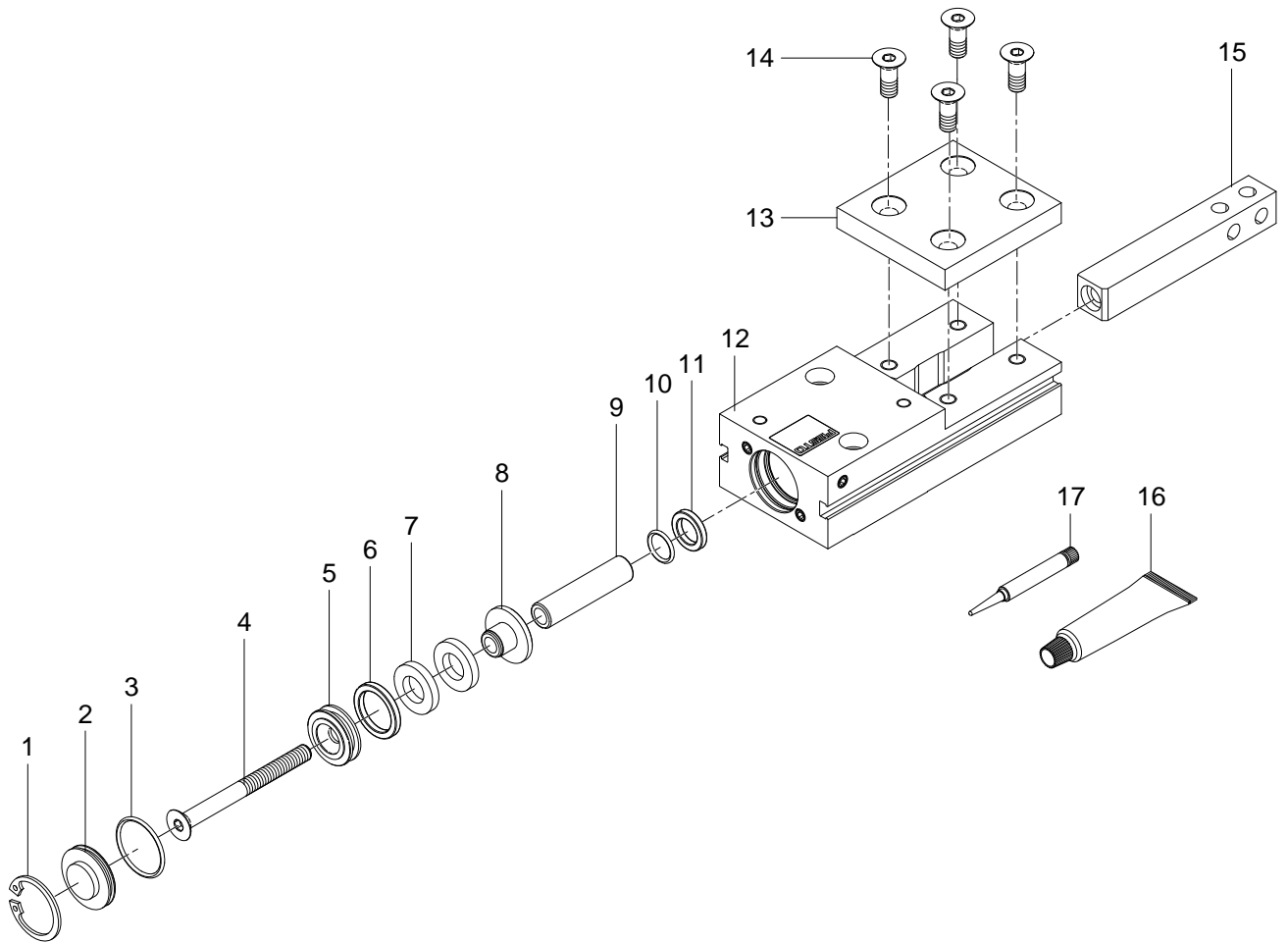

2095362 HPVS-22-30-A Feed separator - Series: All

Pos.	Part no.	Type	Note	Qty.	Unit
A	672866	HPV-22- Set of wearing parts	Spare parts: 1, 2, 3, 6, 10, 11, 16, 17	1	PC
1			Not available separately, see position A	1	PC
2			Not available separately, see position A	1	PC
3			Not available separately, see position A Grease using during assembly. See position 16	1	PC
4			Not available Use locking compound. See position 17	2	PC
5			Not available	1	PC
6			Not available separately, see position A Grease using during assembly. See position 16	1	PC
7			Not available	1	PC
8			Not available	1	PC
9			Not available	1	PC
10			Not available separately, see position A Grease using during assembly. See position 16	1	PC
11			Not available separately, see position A Grease using during assembly. See position 16	1	PC
12			Not available	1	PC
13			Not available	1	PC
14			Not available	1	PC
15			Not available	1	PC
16	665354	LUB-KB1-SILIKONFREI-20ML Lubricating grease		1	PC
17	8181256	CYBERBOND TM44 TB1ML Adhesive bonding agent		1	PC