

Mod. G7540 - Fittings Series 7000 - Automation

Product code: G7540 8-8-6

Datasheet creation date: 11/12/2025 09:41

Check the most updated document online [click here](#)



■ TECHNICAL DATA

Mod.	G7540 8-8-6
------	-------------

Mod. G7540 - Fittings Series 7000 - Automation

Product code: G7540 8-8-6

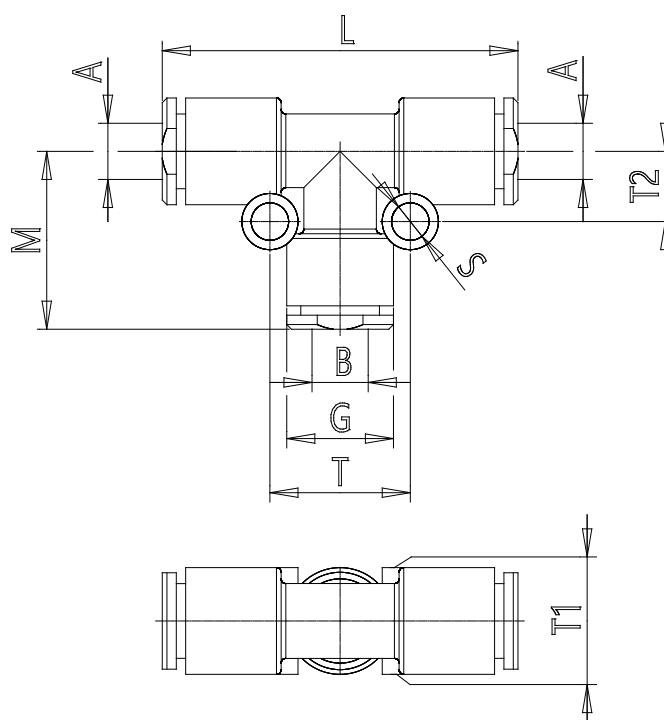

DIMENSIONS

A (mm)	8
B (mm)	6
G (mm)	13.7
L (mm)	43
M (mm)	21.0
S (mm)	4
T (mm)	17.0
T1 (mm)	13.7
T2 (mm)	8.5
Weight (g)	13