

AVX
NTC Thermistors

Contents



NTC Thermistors

NTC THERMISTORS

- General Characteristics 2
- Application Notes 6
- Selection Guide 8
- Ordering Code 9

NTC SMD Thermistors

- NC 12 - NC 20 10
- With Nickel Barrier Termination NB 12 - NB 20 12
- With Nickel Barrier Termination NB 21 - NB 23 14
- Packaging 16
- Surface Mounting Guide 18

NTC Accurate

- NJ 28 - NI 24 - NK 20 - NP 30 19

NTC Disc Thermistors

- ND 03/06/09 - NE 03/06/09 - NV 06/09 21
- Packaging 25

NTC Leadless Disc Thermistors

- NR Series for Consumer and Automotive Applications 27

NTC Inrush Current Limiters Thermistors

- NF 08 - 10 - 13 - 15 - 20 29
- Application Guide 31
- Voltage-Current and Resistance-Temperature Characteristics 32
- Packaging 35

Resistance

- Tables of Resistance vs Temperature 36

Identification – Traceability 41

- RoHS/ELV Compliance 42

As we are anxious that our customers should benefit from the latest developments in the technology and standards, AVX reserves the right to modify the characteristics published in this brochure.

NOTICE: Specifications are subject to change without notice. Contact your nearest AVX Sales Office for the latest specifications. All statements, information and data given herein are believed to be accurate and reliable, but are presented without guarantee, warranty, or responsibility of any kind, expressed or implied. Statements or suggestions concerning possible use of our products are made without representation or warranty that any such use is free of patent infringement and are not recommendations to infringe any patent. The user should not assume that all safety measures are indicated or that other measures may not be required. Specifications are typical and may not apply to all applications.



General Characteristics

1 – INTRODUCTION

NTC thermistors are thermally sensitive resistors made from a mixture of Mn, Ni, Co, Cu, Fe oxides. Sintered ceramic bodies of various sizes can be obtained. Strict conditions of mixing, pressing, sintering and metallization ensure an excellent batch-to-batch product characteristics.

This semi-conducting material reacts as an NTC resistor, whose resistance decreases with increasing temperature. This Negative Temperature Coefficient effect can result from an external change of the ambient temperature or an internal heating due to the Joule effect of a current flowing through the thermistor.

By varying the composition and the size of the thermistors, a wide range of resistance values (0.1Ω to 1MΩ) and temperature coefficients (-2 to -6% per °C) can be achieved.

RoHS (Restriction of Hazardous Substances - European Union directive 2002/95/EC).

ELV (End of Life-Vehicle - European Union directive 2000/53/EC).

All Thermistor Products have been fully RoHS/ELV since before 2006.

Chip Thermistor NB RoHS/ELV Status: external Plating 100% smooth semi-bright Sn as standard SnPb Termination available on request.

2 – MAIN CHARACTERISTICS

2.1 CHARACTERISTICS WITH NO DISSIPATION

2.1.1. Nominal Resistance (Rn)

The nominal resistance of an NTC thermistor is generally given at 25°C. It has to be measured at near zero power so that the resultant heating only produces a negligible measurement error.

The following table gives the maximum advised measurement voltage as a function of resistance values and thermal dissipation factors.

This voltage is such that the heating effect generated by the measurement current only causes a resistance change of 1% ΔRn/Rn.

Ranges of values (Ω)	Maximum measuring voltage (V)			
	δ = 2 mW/°C	δ = 5 mW/°C	δ = 10 mW/°C	δ = 20 mW/°C
R 10				0.10
10 < R 100		0.13	0.18	0.24
100 < R 1,000	0.25	0.38	0.53	0.24
1,000 < R 10,000	0.73	1.1	1.5	2.0
10,000 < R 100,000	2.1	3.2	4.6	
R < 100,000	6.4	9.7	14.5	

2.1.2. Temperature -

Resistance characteristics R (T)

This is the relation between the zero power resistance and the temperature. It can be determined by experimental measurements and may be described by the ratios R (T) /R (25°C) where:

R (T) is the resistance at any temperature T
R (25°C) is the resistance at 25°C.

These ratios are displayed on pages 36 to 40.

2.1.3. Temperature coefficient (α)

The temperature coefficient (α) which is the slope of the curve at a given point is defined by:

$$\alpha = \frac{100}{R} \cdot \frac{dR}{dT} \text{ and expressed in \% per } ^\circ\text{C}.$$

2.1.4. Sensitivity index (B)

The equation $R = A \exp (B/T)$ may be used as a rough approximation of the characteristic R (T).

B is called the sensitivity index or constant of the material used.

To calculate the B value, it is necessary to know the resistances R₁ and R₂ of the thermistor at the temperatures T₁ and T₂.

$$\text{The equation: } R_1 = R_2 \exp B \left(\frac{1}{T_1} - \frac{1}{T_2} \right)$$

$$\text{leads to: } B (K) = \frac{1}{\left(\frac{1}{T_1} - \frac{1}{T_2} \right)} \cdot \ln \left(\frac{R_1}{R_2} \right)$$

Conventionally, B will be most often calculated for temperatures T₁ = 25°C and T₂ = 85°C (298.16 K and 358.16 K).

In fact, as the equation $R = A \exp (B/T)$ is an approximation, the value of B depends on the temperatures T₁ and T₂ by which it is calculated.

For example, from the R (T) characteristic of material M (values given on page 36), it can be calculated:

$$\begin{aligned} B (25 - 85) &= 3950 \\ B (0 - 60) &= 3901 \\ B (50 - 110) &= 3983 \end{aligned}$$

When using the equation $R = A \exp (B/T)$ for this material, the error can vary by as much as 9% at 25°C, 0.6% at 55°C and 1.6% at 125°C.

Using the same equation, it is possible to relate the values of the index B and the coefficient α:

$$\alpha = \frac{1}{R} \cdot \frac{dR}{dT} = \frac{1}{A \exp (B/T)} \cdot A \exp (B/T) \cdot \frac{-B}{T^2}$$

$$\text{thus } \alpha = - \frac{B}{T^2} \text{ expressed in \% } ^\circ\text{C}$$

General Characteristics

2.1.5. Further approximation of R (T) curve

The description of the characteristic R (T) can be improved by using a greater number of experimental points, and by using the equation:

$$\frac{1}{T} = A + B (\ln R) + C (\ln R)^3$$

The parameters A, B and C are determined by solving the set of equations obtained by using the measured resistances at three temperatures.

The solution of the above equation gives the resistance at any temperature:

$$\ln R(T) = \frac{1}{3} \left[\sqrt[3]{-\frac{27(A-1/T)}{C} + \frac{3}{2} \sqrt{3 \left(\sqrt{27 \left(\frac{A-1/T}{C} \right)^2 + 4 \left(\frac{B}{C} \right)^3} \right)}} \right. \\ \left. - \frac{3}{2} \sqrt{27 \left(\frac{A-1/T}{C} \right)^2 + 4 \left(\frac{B}{C} \right)^3} \right]$$

The precision of this description is typically 0.2°C for the range -50 to +150°C (A, B, C being determined with experimental values at -20, +50 and 120°C) or even better if this temperature range is reduced. The ratios R(T)/R(25°C) for each of the different materials shown on pages 36 to 40 have been calculated using the above method.

2.1.6. Resistance tolerance and temperature precision

An important characteristic of a thermistor is the tolerance on the resistance value at a given temperature.

This uncertainty on the resistance ($\Delta R/R$) may be related to the corresponding uncertainty on the temperature (ΔT), using the relationship:

$$\Delta T = 100 \cdot \frac{\Delta R}{R} \cdot \frac{1}{\alpha}$$

Example: consider the thermistor ND06M00152J —

- R (25°C) = 1500 ohms
- Made from M material
- R (T) characteristic shown on page 23 gives:
 $\alpha = -4.4\%/^{\circ}\text{C}$ at 25°C
- Tolerance $\Delta R/R = \pm 5\%$ is equivalent to:
 $\Delta T = 5\%/4.4\%/^{\circ}\text{C} = \pm 1.14^{\circ}\text{C}$

2.1.7. Resistance tolerance at any temperature

Any material used for NTC manufacturing always displays a dispersion for the R (T) characteristic.

This dispersion depends on the type of material used and has been especially reduced for our accuracy series thermistors.

Thus, the tolerance on the resistance ($\Delta R_2/R_2$) at a temperature T_2 is the sum of two contributions as illustrated on Figure 1:

- the tolerance $\Delta R_1/R_1$ at a temperature T_1 used as a reference.
- an additional contribution due to the dispersion on the characteristic R (T) which may be called “Manufacturing tolerance” (Tf).

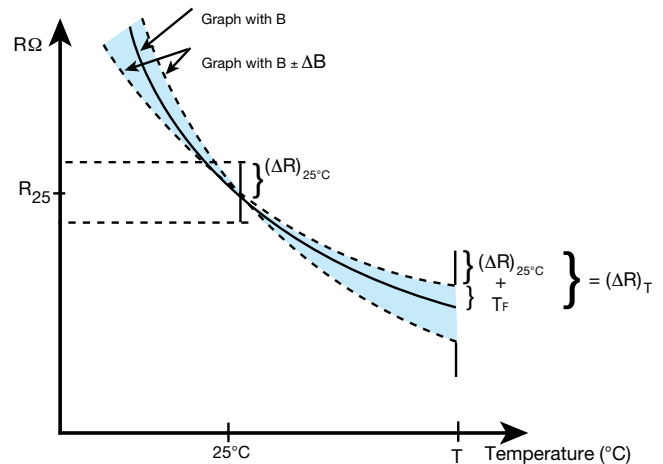

Figure 1

Differentiating the equation $R = A \exp(B/T)$, the two contributions on the tolerance at T can also be written:

$$\frac{\Delta R_2}{R_2} = \frac{\Delta R_1}{R_1} + \left| \frac{1}{T_1} - \frac{1}{T_2} \right| \cdot \Delta B$$

The T(f) values given with the resistance – temperature characteristics on pages 36 to 40 are based on a computer simulation using this equation and experimental values.

2.1.8. Designing the resistance tolerances

Using the fact that the coefficient α decreases with temperature ($\alpha = -B/T^2$), it is generally useful to define the closest tolerance of the thermistor at the maximum value of the temperature range where an accuracy in °C is required.

For example, let us compare the two designs 1 and 2 hereafter:

T (°C)	R (Ω)	α (%/°C)	Design 1		Design 2	
			ΔR/R(%)	ΔT(°C)	ΔR/R(%)	ΔT(°C)
0	3275	-5.2	3.5	0.7	5.0	1.0
25	1000	-4.4	3.0	0.7	4.5	1.1
55	300	-3.7	3.5	1.0	4.0	1.1
85	109	-3.1	4.1	1.3	3.4	1.1
100	69.4	-2.9	4.5	1.6	3.0	1.0

Only the Design 2 is able to meet the requirement $\Delta T \approx 1^{\circ}\text{C}$ from 25°C to 100°C.

General Characteristics

2.1.9. Shaping of the R (T) characteristic

By the use of a resistor network, it is possible to modify the R (T) characteristic of a thermistor so that it matches the required form, for example a linear response over a restricted temperature range.

A single fixed resistor R_p placed in parallel with a thermistor gives a S-shape resistance-temperature curve (see Figure 2) which is substantially more linear at the temperature range around the inflexion point (R_o , T_o).

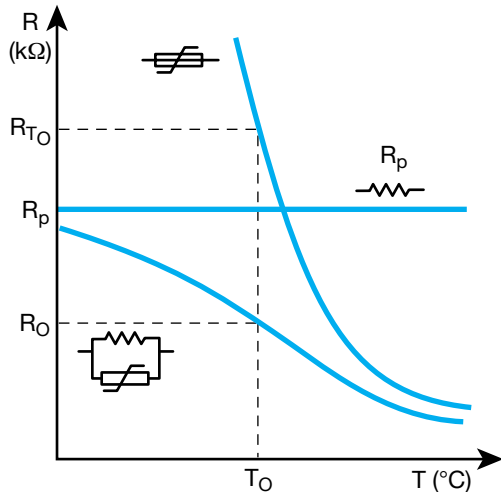

Figure 2 – Linearization of a thermistor

It can be calculated that better linearization is obtained when the fixed resistor value and the mid-range temperature are related by the formula:

$$R_p = R_{T_o} \times \frac{B - T_o}{B + 2T_o}$$

For example, with a thermistor ND03N00103J —

$$R_{25^\circ\text{C}} = 10\text{k}\Omega, B = 4080 \text{ K}$$

good linearization is obtained with a resistor in parallel where the value is:

$$R_p = 10,000 \Omega \times \frac{4080 - 298}{4080 + (2 \times 298)} = 8088 \Omega$$

2.1.10. Demonstration of the R (T) parameters calculation

To help our customers when designing thermistors for temperature measurement or temperature compensation, software developed by our engineering department is available upon request.

2.2 CHARACTERISTICS WITH ENERGY DISSIPATION

When a current is flowing through an NTC thermistor, the power due to the Joule effect raises the temperature of the NTC above ambient.

The thermistor reaches a state of equilibrium when the power supplied becomes equal to the power dissipated in the environment.

The thermal behavior of the thermistor is mainly dependent on the size, shape and mounting conditions.

Several parameters have been defined to characterize these properties:

2.2.1. Heat capacity (H)

The heat capacity is the amount of heat required to change the temperature of the thermistor by 1°C and is expressed in J/°C.

2.2.2. Dissipation factor (δ)

This is the ratio between the variation in dissipated power and the variation of temperature of the NTC. It is expressed in mW/°C and may be measured as:

$$\delta = \frac{U.I}{85 - 25}$$

where U.I is the power necessary to raise to 85°C the temperature of a thermistor maintained in still air at 25°C.

2.2.3. Maximum permissible temperature (T max)

This is the maximum ambient temperature at which the thermistor may be operated with zero dissipation. Above this temperature, the stability of the resistance and the leads attachment can no longer be guaranteed.

2.2.4. Maximum permissible power at 25°C (Pmax)

This is the power required by a thermistor maintained in still air at 25°C to reach the maximum temperature for which it is specified.

For higher ambient temperatures, the maximum permissible power is generally derated according to the Figure 3 hereafter and $T_L = T_{max} - 10^\circ\text{C}$.

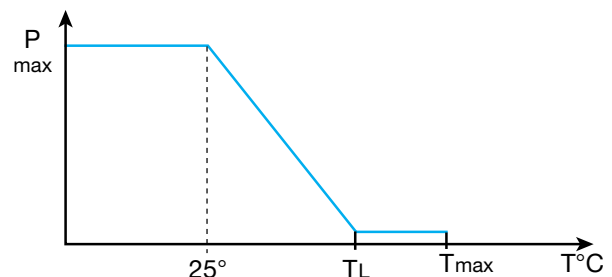

Figure 3 – Derating of maximum power

General Characteristics

2.2.5. Voltage – Current curves V (I)

These curves describe the behavior of the voltage drop V measured across the NTC as the current I through the NTC is increased.

They describe the state of equilibrium between power resulting from Joule effect and dissipated power in the surroundings. (Figure 4)

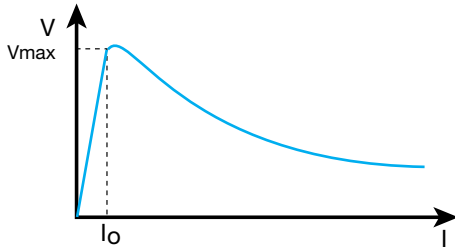

Figure 4 – Voltage – current curve V (I)

Several zones can be identified:

- low current zone
dissipated energy only produces negligible heating and the curve V (I) is almost linear.
- non-linear zone
the curve V (I) displays a maximum voltage Vmax for a current Io. This maximum voltage Vmax and the temperature Tmax reached by the NTC under these conditions can be determined by using the equations:

$$P = V^2/R = \delta (T - T_{amb}) \quad \text{and}$$

$$R = R_{amb} \cdot \exp B (1/T - 1/T_{amb})$$

therefore:

$$T_{max} = B/2 - \sqrt{B^2/4 - BT_{amb}} \approx T_{amb} \left(\frac{1+T_{amb}}{B} \right)$$

$$V_{max} = \sqrt{\delta (T_{max} - T_{amb}) \cdot R_{amb} \exp \left[B \left(\frac{1}{T_{max}} - \frac{1}{T_{amb}} \right) \right]}$$

where δ is the dissipation factor and T_{amb} is the ambient temperature.

- high current zone
for higher currents, an increase in temperature of the NTC decreases the resistance and the voltage more rapidly than the increase of the current. Above a certain dissipated power, the temperature of the NTC exceeds the permissible value.

2.2.6. Current – Time curves I(t)

When voltage is applied to a thermistor, a certain amount of time is necessary to reach the state of equilibrium described by the V(I) curves.

This is the heating up time of the thermistor which depends on the voltage and the resistance on one side and the heat capacity and dissipation on the other.

The curves I(t) are of particular interest in timing applications.

2.2.7. Thermal time constant

When a thermistor is self-heated to a temperature T above ambient temperature T_{amb} , and allowed to cool under zero power resistance, this will show a transient situation.

At any time interval dt, dissipation of the thermistor ($\delta(T - T_{amb})dt$) generates a temperature decrease $-HdT$, resulting in the equation:

$$\frac{1}{(T - T_{amb})} dT = - \frac{\delta}{H} dt$$

The solution to this equation for any value of t, measured from $t = 0$, is:

$$\ln \frac{(T - T_{amb})}{(T_0 - T_{amb})} = - \frac{\delta}{H} t$$

We can define a thermal time constant τ as:

$$\tau = H/\delta \quad \text{expressed in seconds.}$$

Where the time $t = \tau$:

$$(T - T_{amb}) / (T_0 - T_{amb}) = \exp - 1 = 0.368$$

expressing that for $t = \tau$, the thermistor cools to 63.2% of the temperature difference between the initial T_0 and T_{amb} (see Figure 5).

According to IEC 539 our technical data indicates τ measured with $T_0 = 85^\circ\text{C}$, $T_{amb} = 25^\circ\text{C}$ and consequently $T = 47.1^\circ\text{C}$.

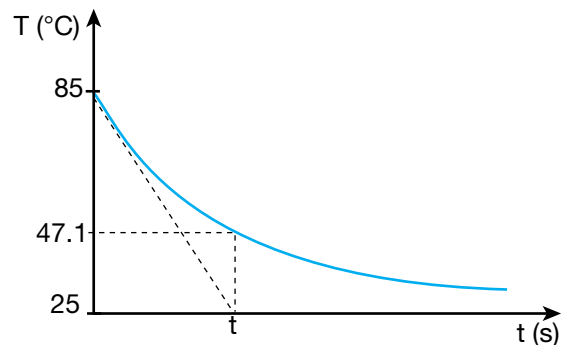

Figure 5 – Temperature – time curve T(t)

2.2.8. Response time

More generally, it is possible to define a response time as the time the thermistor needs to reach 63.2% of the total temperature difference when submitted to a change in the thermal equilibrium (for example from 60°C to 25°C in silicone oil 47V20 Rhodorsil).

NTC Thermistors

Application Notes

TEMPERATURE MEASUREMENT

High sensitivity and low cost make NTC thermistors the most common device used for temperature measurement.

Non-linearity of the R - T curve generally leads to the use of a resistor network to linearize the signal. An example is given in Figure 6.

More precise measurements and temperature display can also be achieved with simple electronic equipment as shown in Figure 7.

The choice of the model will particularly take into account the small size (better response time) and the resistance tolerance. Mounting conditions (dissipation), and input voltage (self-heating) will also be carefully defined to avoid serious errors in temperature measurement.

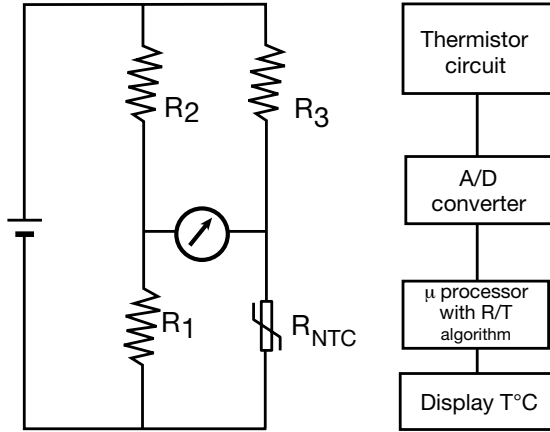

Figure 6

Figure 7

TEMPERATURE CONTROL AND ALARM

NTC thermistors can be used as a simple on-off control temperature system or temperature alarm system. Figure 8 gives an example of such a circuit.

When the temperature increases to a defined value, the resistance of the thermistor decreases and the current becomes sufficiently high to energize the relay and provide temperature alarm or heating system turn-off.

The high sensitivity of thermistors (about 4% resistance change for 1°C) allows the temperature to be controlled very precisely.

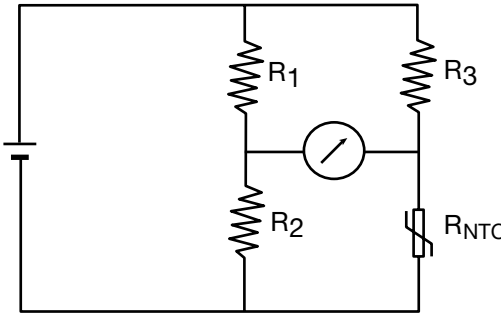

Figure 8

TEMPERATURE COMPENSATION

As many electronic components (integrated circuits, amplifiers,...) have a positive temperature coefficient of resistance, NTC thermistors represent a cheap and interesting solution to compensate for this effect and provide an improved temperature stability for electronic equipment.

It is necessary to include the thermistor in a resistor network (Figure 10) calculated in such a manner that the network coefficient compensates exactly for the positive temperature coefficient of the other component (Figure 9).

Common leaded discs or chip thermistors are well suited for this application.

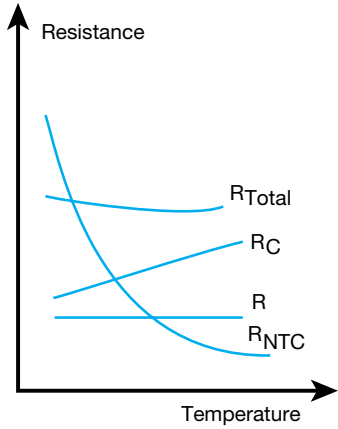

Figure 9

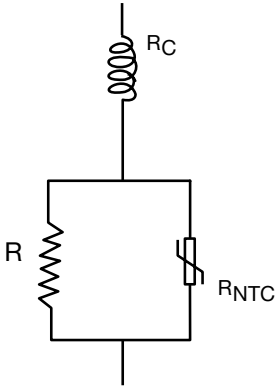

Figure 10

NTC Thermistors

Application Notes

LIQUID LEVEL OR FLOW DETECTION

The dissipation of a thermistor is significantly different in a liquid or in a gas, in a static fluid or in a stirred one. A liquid level detector or a gas-flow measurement can be designed using this property.

In Figure 11, the output voltage measured on the thermistor depends upon the dissipation factor of its environment, and can be illustrated by V-I curves (Figure 12).

This voltage can be used to detect the presence (V_2) or absence (V_1) of liquid around the thermistor or measure the flow speed.

A good design should define a precise operating temperature range, where dissipation in the high dissipating medium at highest ambient temperature remains higher than the dissipation in low dissipating medium at lowest ambient temperature.

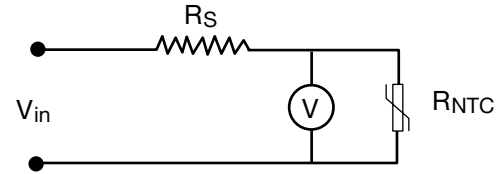

Figure 11

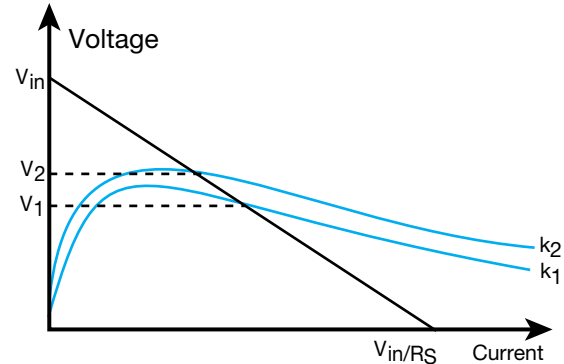

Figure 12

SURGE PROTECTION

A soft start of sensitive apparatus can be achieved by using NTC thermistors as described in Figures 13 and 14.

At turn-on, the NTC absorbs the surge current, limits the current across the equipment and protects it. Then, the thermistor heats, its resistance decreases and most of the power becomes applied to the apparatus.

In its design, the thermistor will be selected with a thermal capacity higher than the surge energy to absorb.

This property is useful when using NTC thermistor as inrush current limiter for switching power supplies (see on page 29).

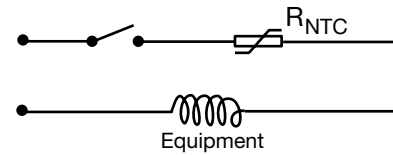

Figure 13

TIME DELAY

The current-time characteristic of a thermistor is used in time delay applications such as delaying energization of a relay after application of power to an electrical circuit.

The time delay, time necessary for the thermistor to heat up to the temperature where its resistance allows the current to reach the switching value of the relay, is mainly defined with the nominal resistance of the thermistor.

The time delay is also strongly dependent upon the ambient temperature, as shown in Figure 15.

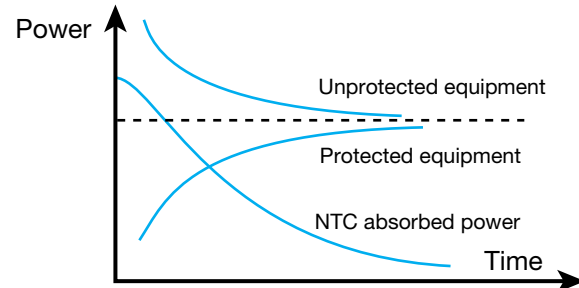

Figure 14

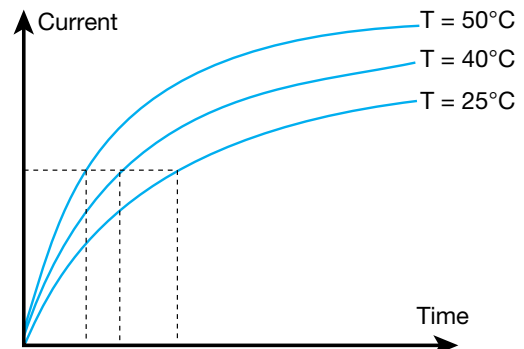

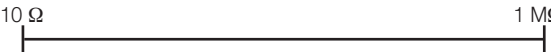



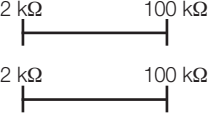



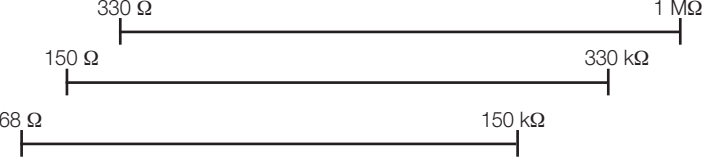

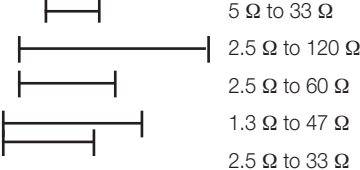

Figure 15

NTC Thermistors

Selection Guide



Types	Range of Values R at 25°C	Main Applications	Page
SMD NC 12/20 NB 12/20 NB 21/23 		- Hybrid circuit - Temperature Compensation	10 12 14
Accuracy Series NJ 28 NI 24 NP 30 NK 20    		- Temperature measurement	19
Leaded Discs N.03 N.06 N.09   		- Temperature measurement and regulation - Level detection - Compensation	21
Leadless Discs NR 	Custom designed products generally defined at two temperatures	- Automotive and industrial thermal control	27
Inrush Current Limiters NF 08 NF 10 NF 13 NF 15 NF 20 		- Current limitation - Delay circuit	29



Ordering Code

HOW TO ORDER

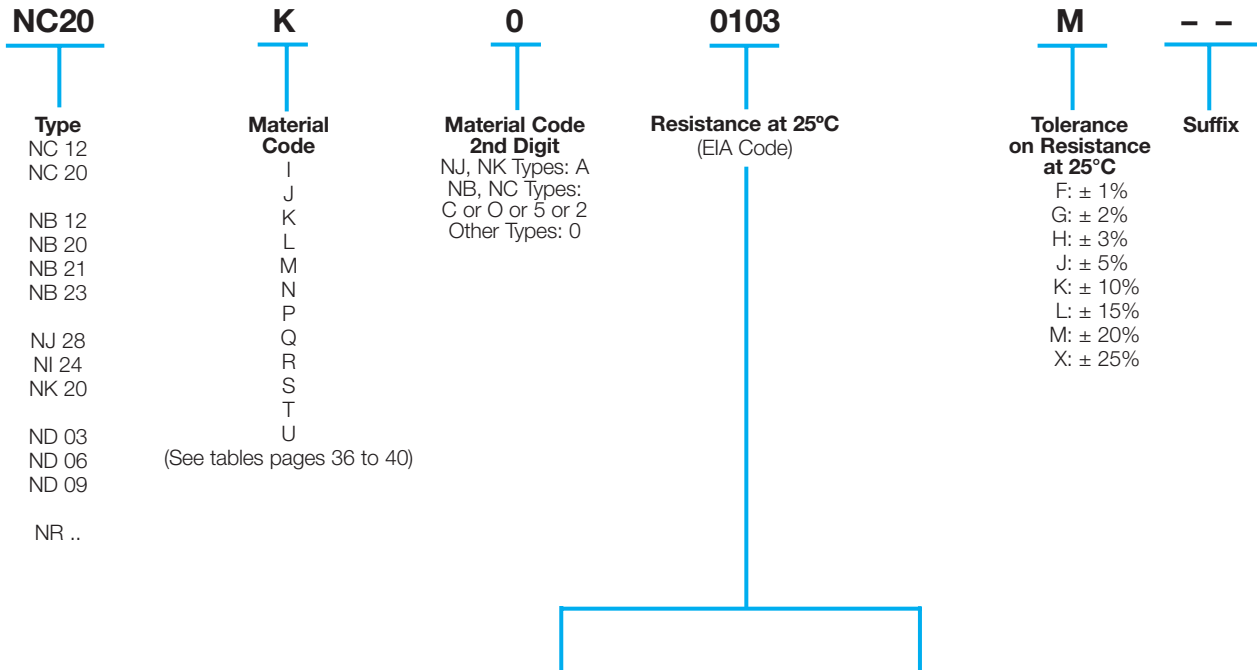

Type

NC 12
NC 20

NB 12
NB 20
NB 21
NB 23

NJ 28
NI 24
NK 20

ND 03
ND 06
ND 09

NR ..

Material Code

I
J
K
L
M
N
P
Q
R
S
T
U

(See tables pages 36 to 40)

Material Code 2nd Digit

NJ, NK Types: A
NB, NC Types: C or O or 5 or 2
Other Types: 0

Resistance at 25°C (EIA Code)

- Resistance expressed by two significant figures
1st digit: 0 (zero)
2nd and 3rd digits: the first two significant figures of the resistance value at 25°C.
4th digit:
– for values $\geq 10 \Omega$: the number of ZEROS to be added to the resistance value
– for values $\geq 1 \Omega$ and $\leq 9.9 \Omega$: the numerical 9 signifying that the resistance value is to be multiplied by 0.1
– for values $< 1 \Omega$: the numerical 8 signifying that the resistance value is to be multiplied by 0.01
Examples: 1000 Ω : 0102
8.2 Ω : 0829
0.47 Ω : 0478
- Resistance expressed by three significant figures
1st, 2nd and 3rd digits: the first three significant figures of the resistance value at 25°C.
4th digit:
– for values $> 100 \Omega$: the number of ZEROS to be added to the resistance value
– for values $> 10 \Omega$ and $< 100 \Omega$: the numerical 9 signifying that the resistance value is to be multiplied by 0.01
– for values $> 1 \Omega$ and $< 10 \Omega$: the numerical 8 signifying that the capacitance value is to be multiplied by 0.01
Examples : 196 Ω : 1960
47.2 Ω : 4729

For leadless discs (types NR) see specification and ordering code on pages 28 and 29.

NTC SMD Thermistors



NC 12 – NC 20

Chip thermistors are a high quality and low cost device especially developed for surface mounting applications. They are widely used for temperature compensation but can also achieve temperature control of printed circuits. Its silver -

palladium - platinum metallization provides a high degree of resistance to dewetting of the terminations during soldering (typically 260°C / 30 s).

Types	NC 12 IEC SIZE : 0805	NC 20 IEC SIZE : 1206
DIMENSIONS: millimeters (inches)		
Terminations	Silver – palladium – platinum metallization	
Marking	On packaging only	
Climatic category	40/125/56	
Operating temperature	-55°C to +150°C	
Tolerance on Rn (25°C)	±5%, ±10%, ±20%	
Maximum dissipation at 25°C	0.12 W	0.24 W
Thermal dissipation factor	2 mW/°C	4 mW/°C
Thermal time constant	5 s	7 s

Resistance - Temperature characteristics: pages 36 to 40.

APPLICATIONS

- LCD compensation
- Battery packs
- Mobile phones
- CD players
- Heating systems
- Air-conditioning systems
- Temperature control of Switch Mode Power Supplies
- Compensation of pressure sensors
- Protection of power transistors in various electronic circuits

HOW TO ORDER

NC 20

Type

K 0

Material Code

K
(See tables pages 11, 36-40)

0103

Resistance
10,000 Ω

M

Tolerance
M (±20%)
J (±5%)
K (±10%)

BA

Suffix: Packaging
--: Bulk
BA: Plastic tape
(180mm diam. reel)
BE: Plastic tape (1/2 reel)
BC: Plastic tape
(330mm diam. reel)
BB: Cardboard tape
(180mm diam. reel)
BF: Cardboard tape (1/2 reel)
BD: Cardboard tape
(330mm diam. reel)



NTC SMD Thermistors



NC 12 – NC 20

TABLE OF VALUES

NC 12 IEC SIZE : 0805				
Types	Rn at 25°C (Ω)	Material Code	B (K) ($\frac{\Delta B}{B}$ (1) ± 5% (2) ± 3%)	α at 25°C (%/°C)
NC 12 KC 0 180	18	KC	3470 ± 5%	- 3.9
NC 12 KC 0 220	22			
NC 12 KC 0 270	27			
NC 12 KC 0 330	33			
NC 12 KC 0 390	39			
NC 12 KC 0 470	47			
NC 12 KC 0 560	56			
NC 12 KC 0 680	68			
NC 12 KC 0 820	82			
NC 12 KC 0 101	100			
NC 12 MC 0 121	120	MC	3910 ± 3%	- 4.4
NC 12 MC 0 151	150			
NC 12 MC 0 181	180			
NC 12 MC 0 221	220			
NC 12 MC 0 271	270			
NC 12 MC 0 331	330			
NC 12 MC 0 391	390			
NC 12 MC 0 471	470			
NC 12 MC 0 561	560			
NC 12 MC 0 681	680			
NC 12 MC 0 821	820			
NC 12 MC 0 102	1,000			
NC 12 MC 0 122	1,200			
NC 12 MC 0 152	1,500			
NC 12 MC 0 182	1,800			
NC 12 MC 0 222	2,200			
NC 12 MC 0 272	2,700			
NC 12 MC 0 332	3,300			
NC 12 J 0 0332	3,300	J	3480 ± 3%	- 3.9
NC 12 J 0 0392	3,900			
NC 12 J 0 0472	4,700			
NC 12 J 0 0562	5,600			
NC 12 K 0 0682	6,800	K	3630 ± 3%	- 4.0
NC 12 K 0 0822	8,200			
NC 12 K 0 0103	10,000			
NC 12 K 0 0123	12,000			
NC 12 L 0 0153	15,000	L	3790 ± 3%	- 4.2
NC 12 L 0 0183	18,000			
NC 12 M 0 0223	22,000	M	3950 ± 3%	- 4.4
NC 12 M 0 0273	27,000			
NC 12 M 0 0333	33,000			
NC 12 M 0 0393	39,000			
NC 12 N 0 0473	47,000	N	4080 ± 3%	- 4.6
NC 12 N 0 0563	56,000			
NC 12 L 2 0683	68,000	L2	3805 ± 3%	- 4.1
NC 12 N 0 0823	82,000	N	4080 ± 3%	- 4.6
NC 12 P 0 0104	100,000	P	4220 ± 3%	- 4.7
NC 12 P 0 0124	120,000			
NC 12 P 0 0154	150,000			
NC 12 P 0 0184	180,000			
NC 12 Q 0 0224	220,000			

NC 20 IEC SIZE : 1206							
Types	Rn at 25°C (Ω)	Material Code	B (K) ($\frac{\Delta B}{B}$ (1) ± 5% (2) ± 3%)	α at 25°C (%/°C)			
NC 20 KC 0 100	10	KC	3470 ± 5%	- 3.9			
NC 20 KC 0 120	12						
NC 20 KC 0 150	15						
NC 20 KC 0 180	18						
NC 20 KC 0 220	22						
NC 20 KC 0 270	27						
NC 20 KC 0 330	33						
NC 20 KC 0 390	39						
NC 20 KC 0 470	47						
NC 20 KC 0 560	56						
NC 20 KC 0 680	68						
NC 20 KC 0 820	82						
NC 20 KC 0 101	100						
NC 20 MC 0 121	120	MC	3910 ± 3%	- 4.4			
NC 20 MC 0 151	150						
NC 20 MC 0 181	180						
NC 20 MC 0 221	220						
NC 20 MC 0 271	270						
NC 20 MC 0 331	330						
NC 20 MC 0 391	390						
NC 20 MC 0 471	470						
NC 20 MC 0 561	560						
NC 20 MC 0 681	680						
NC 20 MC 0 821	820						
NC 20 MC 0 102	1,000						
NC 20 MC 0 122	1,200						
NC 20 MC 0 152	1,500						
NC 20 I 0 0182	1,800				I	3250 ± 5%	- 3.7
NC 20 I 0 0222	2,200						
NC 20 I 0 0272	2,700						
NC 20 I 0 0332	3,300						
NC 20 J 0 0392	3,900	J	3480 ± 3%	- 3.9			
NC 20 J 0 0472	4,700						
NC 20 J 0 0562	5,600						
NC 20 J 0 0682	6,800						
NC 20 K 0 0822	8,200	K	3630 ± 3%	- 4.0			
NC 20 K 0 0103	10,000						
NC 20 K 0 0123	12,000						
NC 20 K 0 0153	15,000						
NC 20 L 0 0183	18,000	L	3790 ± 3%	- 4.2			
NC 20 L 0 0223	22,000						
NC 20 M 0 0273	27,000	M	3950 ± 3%	- 4.4			
NC 20 M 0 0333	33,000						
NC 20 M 0 0393	39,000						
NC 20 M 0 0473	47,000						
NC 20 N 0 0563	56,000	N	4080 ± 3%	- 4.6			
NC 20 N 0 0683	68,000						
NC 20 N 0 0823	82,000						
NC 20 N 0 0104	100,000						
NC 20 P 0 0124	120,000	P	4220 ± 3%	- 4.7			
NC 20 P 0 0154	150,000						
NC 20 P 0 0184	180,000						
NC 20 P 0 0224	220,000						
NC 20 Q 0 0274	270,000				Q	4300 ± 3%	- 4.7
NC 20 Q 0 0334	330,000						
NC 20 Q 0 0394	390,000						
NC 20 Q 0 0474	470,000						
NC 20 R 0 0564	560,000	R	4400 ± 3%	- 4.8			
NC 20 R 0 0684	680,000						
NC 20 R 0 0824	820,000						
NC 20 R 0 0105	1,000,000						

NTC SMD Thermistors



With Nickel Barrier Termination NB 12 - NB 20

Chip thermistors are high quality and low cost devices especially developed for surface mounting applications. They are widely used for temperature compensation but can also achieve temperature control of printed circuits.

A nickel barrier metallization provides outstanding qualities of solderability and enables this chip to meet the requirements of the most severe soldering processes.

Types	NB 12 IEC SIZE : 0805	NB 20 IEC SIZE : 1206
DIMENSIONS: millimeters (inches)		
Terminations	Nickel Barrier	
Marking	On packaging only	
Climatic category	40/125/56	
Operating temperature	-55°C to +150°C	
Tolerance on Rn (25°C)	±5%, ±10%, ±20%	
Maximum dissipation at 25°C	0.12 W	0.24 W
Thermal dissipation factor	2 mW/°C	4 mW/°C
Thermal time constant	5 s	7s

Resistance - Temperature characteristics: pages 36 to 40.

APPLICATIONS

- LCD compensation
- Battery packs
- Mobile phones
- CD players
- Heating systems
- Air-conditioning systems
- Temperature control of Switch Mode Power Supplies
- Compensation of pressure sensors
- Protection of power transistors in various electronic circuits

HOW TO ORDER

NB 20

Type

K 0

Material Code

K
(See tables page 13)

0103

Resistance
10,000 Ω

M

Tolerance
M (±20%)
J (±5%)
K (±10%)

BA

Suffix: Packaging
--: Bulk
BA: Plastic tape
(180mm diam. reel)
BE: Plastic tape (1/2 reel)
BC: Plastic tape
(330mm diam. reel)
BB: Cardboard tape
(180mm diam. reel)
BF: Cardboard tape (1/2 reel)
BD: Cardboard tape
(330mm diam. reel)



NTC SMD Thermistors



With Nickel Barrier Termination NB 12 – NB 20

TABLE OF VALUES

NB 12 IEC SIZE : 0805				
Types	Rn at 25°C (Ω)	Material Code	B (K) ($\Delta B/B$ (1) $\pm 5\%$ (2) $\pm 3\%$)	α at 25°C (%/°C)
NB 12 KC 0 180	18	KC	3470 \pm 5%	- 3.9
NB 12 KC 0 220	22			
NB 12 KC 0 270	27			
NB 12 KC 0 330	33			
NB 12 KC 0 390	39			
NB 12 KC 0 470	47			
NB 12 KC 0 560	56			
NB 12 KC 0 680	68			
NB 12 KC 0 820	82			
NB 12 KC 0 101	100			
NB 12 MC 0 121	120	MC	3910 \pm 3%	- 4.4
NB 12 MC 0 151	150			
NB 12 MC 0 181	180			
NB 12 MC 0 221	220			
NB 12 MC 0 271	270			
NB 12 MC 0 331	330			
NB 12 MC 0 391	390			
NB 12 MC 0 471	470			
NB 12 MC 0 561	560			
NB 12 MC 0 681	680			
NB 12 MC 0 821	820			
NB 12 MC 0 102	1,000			
NB 12 MC 0 122	1,200			
NB 12 MC 0 152	1,500			
NB 12 MC 0 182	1,800			
NB 12 MC 0 222	2,200			
NB 12 MC 0 272	2,700			
NB 12 MC 0 332	3,300			
NB 12 J 0 0332	3,300	J	3480 \pm 3%	- 3.9
NB 12 J 0 0392	3,900			
NB 12 J 0 0472	4,700			
NB 12 J 0 0562	5,600			
NB 12 K 0 0682	6,800	K	3630 \pm 3%	- 4.0
NB 12 K 0 0822	8,200			
NB 12 K 0 0103	10,000			
NB 12 L 0 0123	12,000	L	3790 \pm 3%	- 4.2
NB 12 L 0 0153	15,000			
NB 12 M 0 0183	18,000	M	3950 \pm 3%	- 4.4
NB 12 M 0 0223	22,000			
NB 12 M 0 0273	27,000			
NB 12 M 0 0333	33,000			
NB 12 N 0 0393	39,000	N	4080 \pm 3%	- 4.6
NB 12 N 0 0473	47,000			
NB 12 N 0 0563	56,000			
NB 12 L 2 0683	68,000	L2	3805 \pm 3%	- 4.1
NB 12 N 5 0683	68,000	N5	4160 \pm 3%	- 4.7
NB 12 N 5 0823	82,000			
NB 12 P 0 0104	100,000	P	4220 \pm 3%	- 4.7
NB 12 SC 0104	100,000	SC	4500 \pm 3%	- 4.8
NB 12 P 0 0124	120,000	P	4220 \pm 3%	- 4.7
NB 12 P 0 0154	150,000			
NB 12 P 0 0184	180,000			
NB 12 Q 0 0224	220,000	Q	4300 \pm 3%	- 4.7
NB 12 Q 0 0274	270,000			
NB 12 R 0 0105	1,000,000	R	4400 \pm 3%	- 4.8

NB 20 IEC SIZE : 1206				
Types	Rn at 25°C (Ω)	Material Code	B (K) ($\Delta B/B$ (1) $\pm 5\%$ (2) $\pm 3\%$)	α at 25°C (%/°C)
NB 20 MC 0 221	220	MC	3910 \pm 3%	- 4.4
NB 20 MC 0 102	1,000			
NB 20 J 0 0472	4,700	J	3480 \pm 3%	- 3.9
NB 20 J 0 0562	5,600			
NB 20 J 0 0682	6,800			
NB 20 J 5 0822	8,200	J5	3480 \pm 3%	- 3.9
NB 20 K 0 0103	10,000	K	3630 \pm 3%	- 4.0
NB 20 K 0 0123	12,000			
NB 20 L 0 0153	15,000	L	3790 \pm 3%	- 4.2
NB 20 L 0 0183	18,000			
NB 20 L 0 0223	22,000			
NB 20 M 0 0273	27,000	M	3950 \pm 3%	- 4.4
NB 20 M 0 0333	33,000			
NB 20 M 0 0393	39,000			
NB 20 M 0 0473	47,000			
NB 20 N 0 0563	56,000	N	4080 \pm 3%	- 4.6
NB 20 N 0 0683	68,000			
NB 20 N 0 0823	82,000			
NB 20 N 5 0104	100,000	N5	4160 \pm 3%	- 4.7
NB 20 P 0 0124	120,000	P	4220 \pm 3%	- 4.7
NB 20 P 0 0154	150,000			
NB 20 P 0 0184	180,000			
NB 20 P 0 0224	220,000			
NB 20 Q 0 0274	270,000	Q	4300 \pm 3%	- 4.7
NB 20 Q 0 0334	330,000			
NB 20 Q 0 0394	390,000			
NB 20 Q 0 0474	470,000			
NB 20 Q 0 0564	560,000			
NB 20 R 0 0684	680,000	R	4400 \pm 3%	- 4.8
NB 20 R 0 0824	820,000			
NB 20 R 0 0105	1,000,000			

NTC SMD Thermistors



With Nickel Barrier Termination NB 21 - NB 23

Chip thermistors are high quality and low cost devices especially developed for surface mounting applications. They are widely used for temperature compensation but can also achieve temperature control of printed circuits.

A nickel barrier metallization provides outstanding qualities of solderability and enables this chip to meet the requirements of the most severe soldering processes.

Types	NB 21 IEC SIZE : 0603	NB 23 IEC SIZE : 0402
DIMENSIONS: millimeters (inches)		
Terminations	Nickel Barrier	
Marking	On packaging only	
Climatic category	40/125/56	
Operating temperature	-55°C to +150°C	
Tolerance on Rn (25°C)	±5%, ±10%, ±20%	
Maximum dissipation at 25°C	0.07 W	0.06 W
Thermal dissipation factor	1 mW/°C	0.8 mW/°C
Thermal time constant	4 s	3 s

Resistance - Temperature characteristics: pages 36 to 40.

APPLICATIONS

- LCD compensation
- Battery packs
- Mobile phones
- CD players
- Heating systems
- Air-conditioning systems
- Temperature control of Switch Mode Power Supplies
- Compensation of pressure sensors
- Protection of power transistors in various electronic circuits

HOW TO ORDER

NB 21

Type

K 0

Material Code
K
(See tables page 15)

0103

Resistance
10,000 Ω

M

Tolerance
M (±20%)
J (±5%)
K (±10%)

BB

Suffix: Packaging
--: Bulk
BB: Cardboard tape
(180mm diam. reel)
BF: Cardboard tape (1/2 reel)
BD: Cardboard tape
(330mm diam. reel)

NTC SMD Thermistors



With Nickel Barrier Termination NB 21 - NB 23

TABLE OF VALUES

NB 21 IEC SIZE : 0603				
Types	Rn at 25°C (Ω)	Material Code	B (K) ($\frac{\Delta B}{B}$ ⁽¹⁾ ± 5% ₍₂₎ ± 3%)	α at 25°C (%/°C)
NB 21 KC 0 470 NB 21 KC 0 101 NB 21 KC 0 471	47 100 470	KC	3470 ± 5%	- 3.9
NB 21 MC 0 102	1,000	MC	3910 ± 3%	- 4.4
NB 21 J 0 0472	4,700	J	3480 ± 3%	- 3.9
NB 21 J 5 0682 NB 21 J 5 0103	6,800 10,000	J5	3480 ± 3% 3480 ± 3%	- 3.9 - 3.9
NB 21 K 0 0103 NB 21 K 0 0153	10,000 15,000	K	3630 ± 3%	- 4.0
NB 21 L 0 0223	22,000	L	3790 ± 3%	- 4.2
NB 21 M 0 0333 NB 21 M 0 0473	33,000 47,000	M	3950 ± 3%	- 4.4
NB 21 L 2 0683	68,000	L2	3805 ± 3%	- 4.1
NB 21 N 0 0683	68,000	N	4080 ± 3%	- 4.6
NB 21 N 5 0104	100,000	N5	4160 ± 3%	- 4.7
NB 21 P 0 0154	150,000	P	4220 ± 3%	- 4.7
NB 21 Q 0 0334 NB 21 Q 0 0474	330,000 470,000	Q	4300 ± 3%	- 4.7

NB 23 IEC SIZE : 0402				
Types	Rn at 25°C (Ω)	Material Code	B (K) ($\frac{\Delta B}{B}$ ⁽¹⁾ ± 5% ₍₂₎ ± 3%)	α at 25°C (%/°C)
NB 23 NC 0 103	10,000	NC	4080 ± 3%	- 4.6
NB 23 RC 0 103	10,000	RC	4340 ± 3%	- 4.7
NB 23 NC 0 153 NB 23 NC 0 223	15,000 22,000	NC	4080 ± 3%	- 4.6
NB 23 RC 0 223 NB 23 RC 0 333	22,000 33,000	RC	4340 ± 3%	- 4.7
NB 23 NE 0 473	47,000	NE	4100 ± 3%	- 4.6
NB 23 RC 0 473 NB 23 RC 0 683 NB 23 RC 0 104	47,000 68,000 100,000	RC	4340 ± 3%	- 4.7

Packaging for Automatic Insertion



NTC Chip Thermistors / NC/NB Series

AUTOMATIC INSERTION

Super 8 Plastic Tape Packaging:

The mechanical and dimensional reel characteristics are in accordance with the IEC publication 286-3.

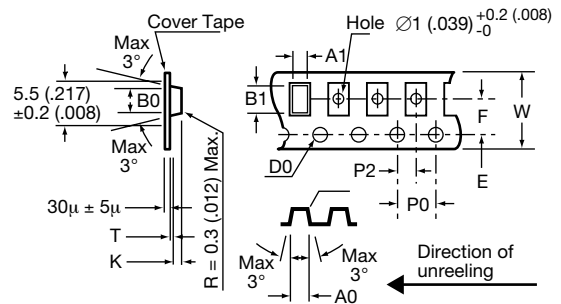

Designation	Symbol	Value	Tolerance
Tape width	W	8	±0.2
Tape thickness	T	0.4 max.	
Pitch of the sprocket holes	P0	4	±0.1
Diameter of the sprocket holes	D0	1.5 -0	±0.1
Distance	E	1.75	±0.1
Distance (center to center)	F	3.5	±0.05
Distance (center to center)	P2	2	±0.1
Sizes of the cavities	NC 12 (0805)	A0	1.5 ±0.1
		B0	2.4 ±0.1
		K	1.4 max. K ±0.1 (size is adjustable) (K = t1 +0.2)
NC 20 (1206)		A0	1.95 ±0.1
		B0	3.55 ±0.1
		K	1.5 max. K ±0.1 (size is adjustable) (K = t1 +0.2)

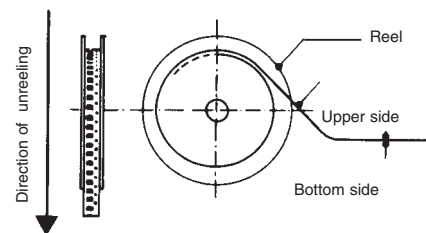
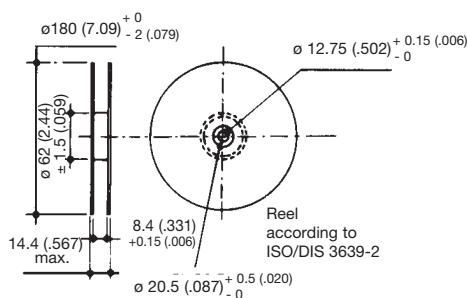

QUANTITY PER REEL

Type	Suffix	Qty Per Reel
NC - NB 12	BA	4000
	BE	2000
NC 20 - NB 20	BA	3000
	BE	1500

Packaging for Automatic Insertion



NTC Chip Thermistors / NC/NB Series

AUTOMATIC INSERTION

8mm Paper Tape Packaging:

The mechanical and dimensional reel characteristics are in accordance with the IEC publication 286-3.

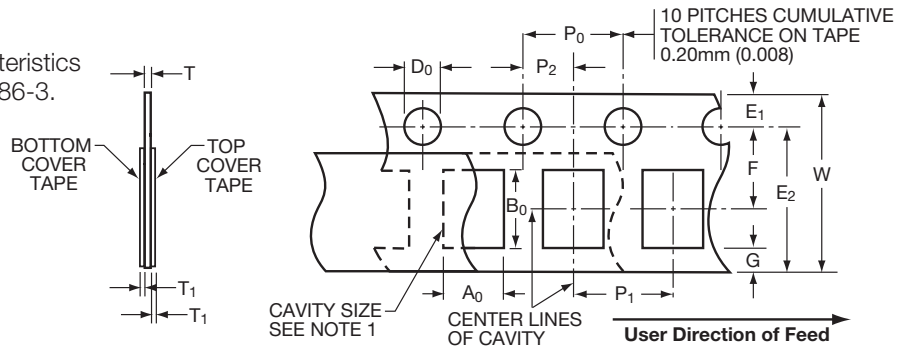

Designation	Symbol	Value	Tolerance
Tape width	W	8	-.0.1/+0.3
Tape thickness	T	1.1 max.	
Pitch of the sprocket holes	P ₀	4	±0.1
Diameter of the sprocket holes	D ₀	1.5 -0/+0.1	±0.1
Distance	E ₁	1.75	±0.1
Distance (center to center)	F	3.5	±0.05
Distance (center to center)	P ₂	2	±0.05
Cover tape thickness	T ₁	0.10 max.	
Distance	E ₂	6.25 min.	
Distance	G	0.75 min.	
Component pitch	P ₁	0805/0603 0402	±0.1
			±0.1

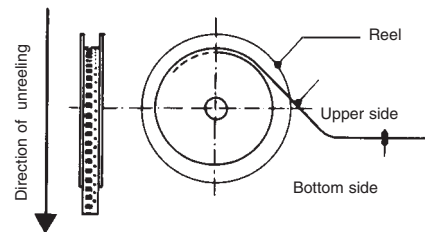
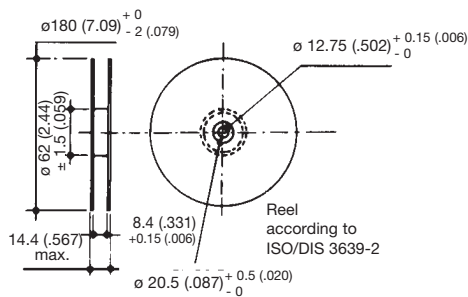

QUANTITY PER REEL

Type	Suffix	Qty Per Reel
NB - NC 12	BB	4000
NB 21	BF	2000
NB 23	BB	10000
	BF	5000



Surface Mounting Guide



Chip Thermistor – Application Notes

STORAGE

Good solderability is maintained for at least twelve months, provided the components are stored in their “as received” packaging at less than 40°C and 70% RH.

SOLDERABILITY / LEACHING

Terminations to be well soldered after immersion in a 60/40 tin/lead solder bath at $235 \pm 5^\circ\text{C}$ for 2 ± 1 seconds.

Terminations will resist leaching for at least the immersion times and conditions recommendations shown below.

P/N	Termination Type	Solder Tin/Lead	Solder Temp °C	Immersion Time Seconds
NC	AgPdPt	60/40	260 ± 5	15 max
NB	Nickel Barrier	60/40	260 ± 5	30 ± 1

NB products are compatible with a wide range of soldering conditions consistent with good manufacturing practice for surface mount components. This includes Pb free reflow processes with peak temperatures up to 270°C . Recommended profiles for reflow and wave soldering are shown below for reference.

NC products are recommended for lead soldering application or gluing techniques.

Wave

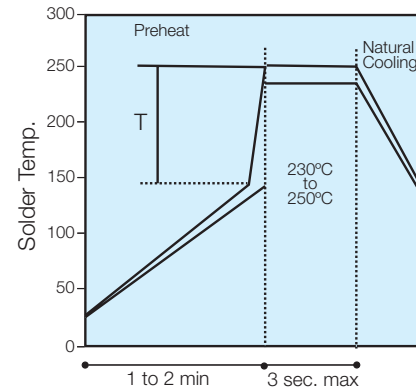

(Preheat chips before soldering)
T/maximum 150°C

- The visual standards used for evaluation of solder joints will need to be modified as lead free joints are not as bright as with tin-lead pastes and the fillet may not be as large.
- Resin color may darken slightly due to the increase in temperature required for the new pastes.
- Lead-free solder pastes do not allow the same self alignment as lead containing systems. Standard mounting pads are acceptable, but machine set up may need to be modified.

Reflow

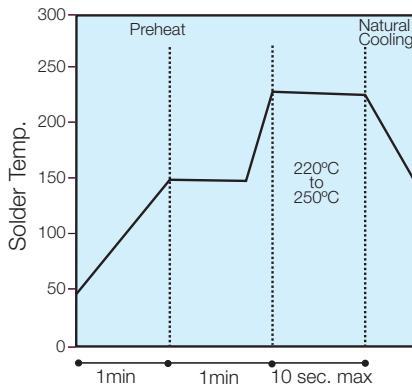

(Minimize soldering time)

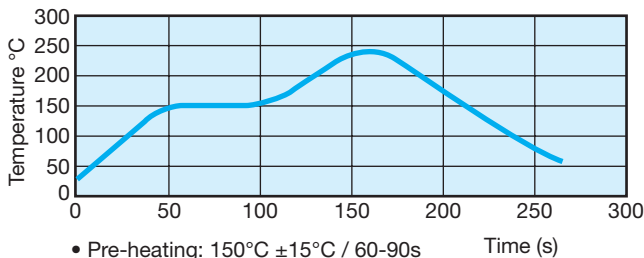

- Pre-heating: $150^\circ\text{C} \pm 15^\circ\text{C}$ / 60-90s
- Max. Peak Gradient: 2.5°C/s
- Peak Temperature: $245^\circ\text{C} \pm 5^\circ\text{C}$
- Time at $>230^\circ\text{C}$: 40s Max.

RECOMMENDED SOLDERING PAD LAYOUT

Dimensions in mm (inches)

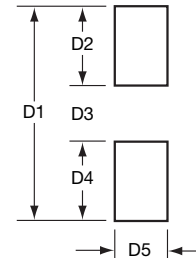

REFLOW SOLDERING

Case Size	P/N	D1	D2	D3	D4	D5
0402	NB23	1.70 (.067)	0.60 (.024)	0.50 (.020)	0.60 (.024)	0.50 (.020)
0603	NB21	2.30 (.091)	0.80 (.031)	0.70 (.028)	0.80 (.031)	0.75 (.030)
0805	NB12	3.00 (.118)	1.00 (.039)	1.00 (.039)	1.00 (.039)	1.25 (.049)
1206	NB20	4.00 (.157)	1.00 (.039)	2.00 (.079)	1.00 (.039)	2.50 (.098)

WAVE SOLDERING

Case Size	P/N	D1	D2	D3	D4	D5
0603	NB21	3.10 (.122)	1.20 (.047)	0.70 (.028)	1.20 (.047)	0.75 (.030)
0805	NB12	4.00 (.157)	1.50 (.059)	1.00 (.039)	1.50 (.059)	1.25 (.049)
1206	NB20	5.00 (.197)	1.50 (.059)	2.00 (.079)	1.50 (.059)	1.60 (.063)

NTC Accurate Thermistors



NJ 28 – NI 24 – NK 20

High precision resistance and an outstanding ability to reproduce the sensibility index B, make these ranges of products the types of thermistors ideal for temperature measurement applications.

Leaded or unleaded, these small size and rapid response time thermistors are able to meet the most accurate requirements.

Types	NJ 28	NP 30	NI 24	NK 20
Finish	Coated chip with phenolic resin + varnish + tinned copper wires	Coated chip with epoxy	Coated chip with epoxy AWG30 insulated leads + Silver plated nickel wires	Chip
DIMENSIONS: millimeters (inches)				
Marking	On packaging only			
Operating temperature	-55°C to +150°C			
Tolerance on R _n (25°C)	±1%, ±2%, ±3%			
Maximum dissipation at 25°C	0.16 W			
Thermal dissipation factor*	3 mW/°C		3 mW/°C	2 mW/°C
Thermal time constant	8 s		8 s	6 s
Response time	< 2 s			

TABLE OF VALUES

Types	R _n at 25°C (Ω)	Material Code	B (K)	α at 25°C (%/°C)
N_ _ _ KA 0202	2,000	KA	3625 ± 1%	- 4.1
N_ _ _ MA 0302	3,000	MA	3960 ± 0.5%	- 4.5
N_ _ _ MA 0502	5,000	MA	3960 ± 0.5%	- 4.5
N_ _ _ MA 0103	10,000	MA	3960 ± 0.5%	- 4.5
N_ _ _ NA 0103	10,000	NA	4100 ± 1%	- 4.6
N_ _ _ PA 0203	20,000	PA	4235 ± 1%	- 4.8
N_ _ _ QA 0503	50,000	QA	4250 ± 1%	- 4.8
N_ _ _ RA 0104	100,000	RA	4380 ± 1%	- 4.9

* -- = Add type as outlined above (Example NJ 28).

Resistance - Temperature characteristics: pages 36 to 40.

HOW TO ORDER

NJ28



Type

MA



Material Code
MA
(See table above)

0502



Resistance
5 kΩ

F--



Tolerance
F (±1%)



NTC Thermistors Manufacturing Process

NJ 28 – NI 24 – NK 20

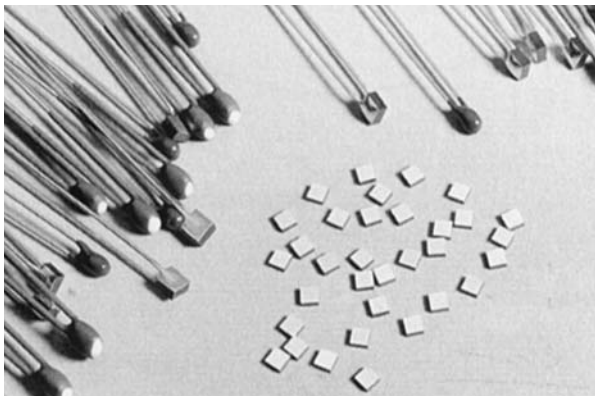
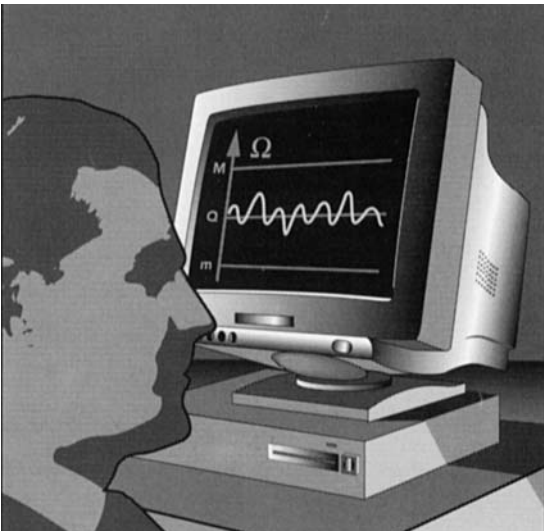
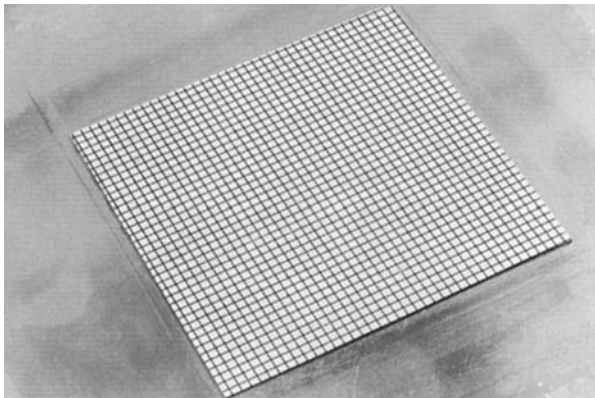
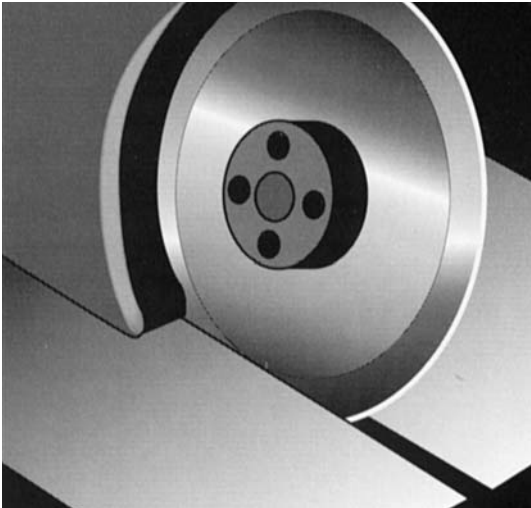
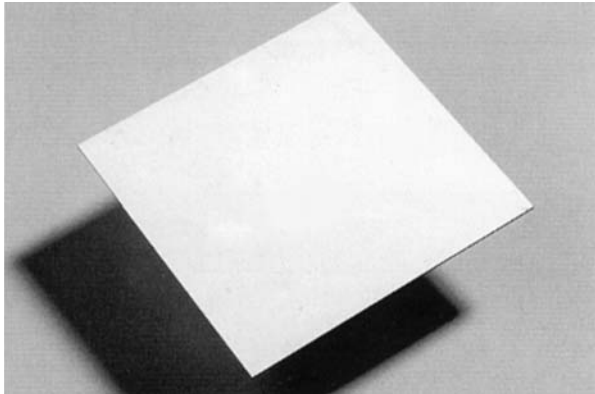
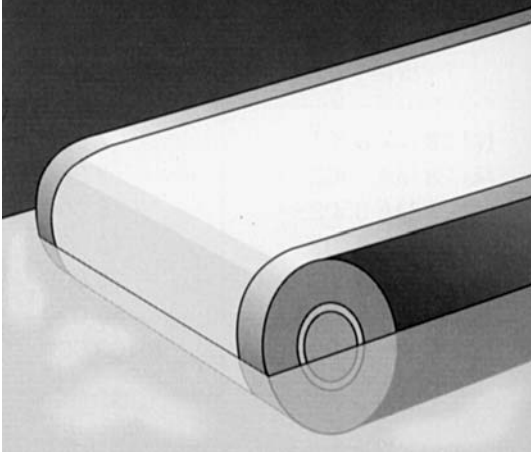

APPLICATIONS

- Commodity Product: 2 families
ND or NE : general purpose
NV : professional
- Alarm and temperature measurement application
- Temperature regulation application
- Level detection application
- Compensation application

TECHNOLOGY

- ND: epoxy-phenolic resin coating
NE: epoxy resin coating (recommended for severe mounting conditions)
NV: epoxy varnish coating
- Leads: Radial copper wire tinned
- Marking: on package only for ND03 & NE03
ND/NE 06/09: Nominal resistance and tolerance for $\pm 5\%$, $\pm 10\%$
NV06/09: Nominal resistance and tolerance
- Delivery Mode: Bulk, reeled or ammpacked

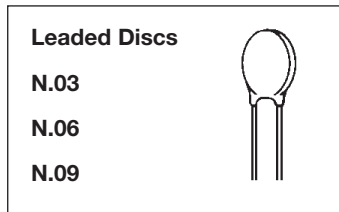
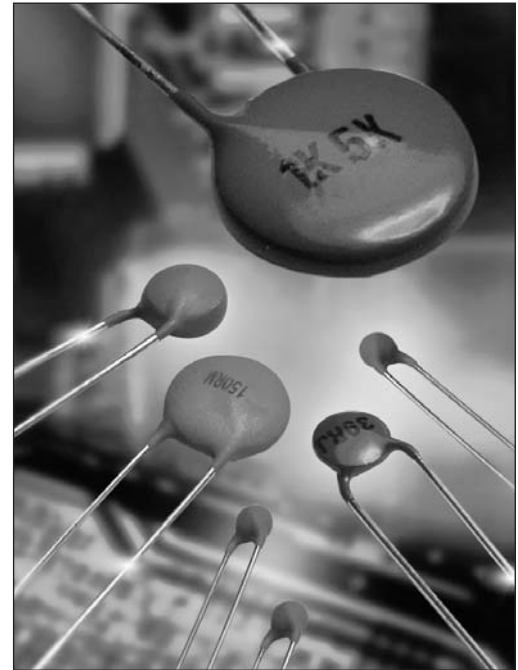

PERFORMANCE CHARACTERISTICS

Types	General purpose			Professional	
	ND03 or NE03	ND06 or NE06	ND09 or NE09	NV06	NV09
Climatic category				55/125/56-434	55/125/56-434
Operating Temperature	-55 to +150°C	-55 to +150°C	-55 to +150°C	-55 to +150°C	-55 to +150°C
Tolerance on Rn (25°C)	330Ω to 1MΩ : $\pm 5, 10, 20\%$ 1500Ω to 150 kΩ : $\pm 3\%$	$\pm 5\%, \pm 10\%, \pm 20\%$	$\pm 5\%, \pm 10\%, \pm 20\%$	$\pm 2\%, \pm 5\%, \pm 10\%$	$\pm 2\%, \pm 5\%, \pm 10\%$
Maximum dissipation at 25°C	0.25 W	0.71 W	0.9 W	0.69 W	0.85 W
Thermal dissipation factor	5 mW/°C	7.1 mW/°C	9 mW/°C	6.9 mW/°C	8.5 mW/°C
Thermal time constant	10 s	22 s	30 s	18 s	30 s
Response time	< 3s				

STANDARDIZATION

NV range : approved by NFC 93271
 Type: TN115 A for NV06
 TN116 for NV09
 List: GAM-T1
 List: LNZ

OPTIONS

Consult factory for availability of options:

- other nominal resistance values
- other tolerances
- alternative lead materials or lengths
- controlled dimensions

NTC Disc Thermistors

ND/NE 03



TABLE OF VALUES

ND03/NE03 TYPE

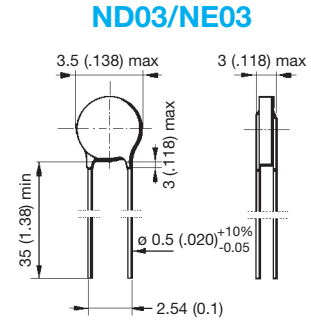

Part Number	Rn at 25°C (Ω)	Material Code	B (K) ($\Delta B/B$) (1) ± 5% (2) ± 3%	α at 25°C (%/°C)
N_03I00331 N_03I00471	330 470	I	3250 (1)	- 3.7
N_03J00681 N_03J00102	680 1,000	J	3480 (2)	- 3.9
N_03K00152 N_03K00222	1,500 2,200	K	3630 (2)	- 4.0
N_03L00272 N_03L00332	2,700 3,300	L	3790 (2)	- 4.2
N_03M00472 N_03M00682	4,700 6,800	M	3950 (2)	- 4.4
N_03N00103 N_03N00153	10,000 15,000	N	4080 (2)	- 4.6
N_03P00223 N_03P00333	22,000 33,000	P	4220 (2)	- 4.7
N_03Q00473 N_03Q00683	47,000 68,000	Q	4300 (2)	- 4.7
N_03R00104 N_03R00154	100,000 150,000	R	4400 (2)	- 4.8
N_03S00224	220,000	S	4520 (2)	- 5.0
N_03T00334 N_03T00474	330,000 470,000	T	4630 (2)	- 5.1
N_03U00105	1,000,000	U	4840 (2)	- 5.3

NTC Disc Thermistors

ND/NE/NV 06



TABLE OF VALUES

ND06/NE06/NV06

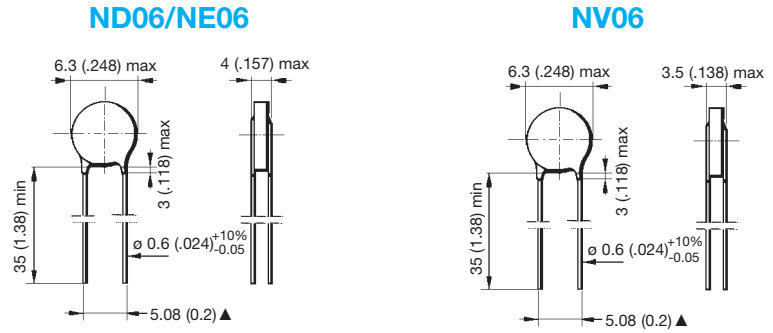

Part Number	Rn at 25°C (Ω)	Material Code	B (K) ($\frac{\Delta B}{B}$ (1) ± 5% (2) ± 3%)	α at 25°C (%/°C)
N_06J00151 N_06J00221	150 220	J	3480 (2)	- 3.9
N_06K00331 N_06K00471	330 470	K	3630 (2)	- 4.0
N_06L00681 N_06L00102	680 1,000	L	3790 (2)	- 4.2
N_06M00152	1,500	M	3950 (2)	- 4.4
N_06N00222 N_06N00332	2,200 3,300	N	4080 (2)	- 4.6
N_06P00472 N_06P00682 N_06P00103	4,700 6,800 10,000	P	4220 (2)	- 4.7
N_06Q00153 N_06Q00223	15,000 22,000	Q	4300 (2)	- 4.7
N_06R00333	33,000	R	4400 (2)	- 4.8
N_06S00473 N_06S00683	47,000 68,000	S	4520 (2)	- 5.0
N_06T00104	100,000	T	4630 (2)	- 5.1
N_06U00154 N_06U00224 N_06U00334	150,000 220,000 330,000	U	4840 (2)	- 5.3

For other resistance values, please consult us.

NTC Disc Thermistors

ND/NE/NV 09



TABLE OF VALUES

ND09/NE09/NV09

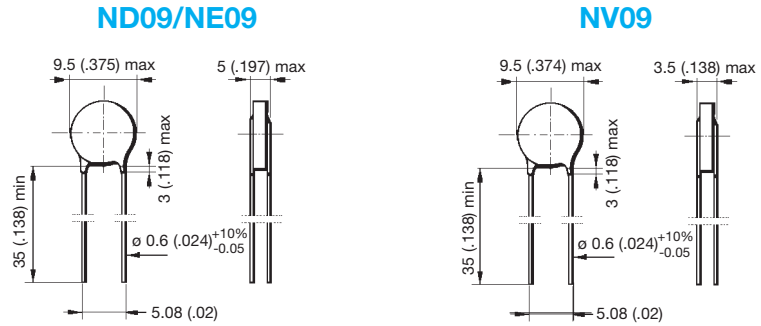

Part Number	Rn at 25°C (Ω)	Material Code	B (K) ($\Delta B/B$) (1) ± 5% (2) ± 3%	α at 25°C (%/°C)
N_09J00680 N_09J00101	68 100	J	3480 (2)	- 3.9
N_09K00151 N_09K00221	150 220	K	3630 (2)	- 4.0
N_09L00331	330	L	3790 (2)	- 4.2
N_09M00471 N_09M00681	470 680	M	3950 (2)	- 4.4
N_09N00102 N_09N00152	1,000 1,500	N	4080 (2)	- 4.6
N_09P00222 N_09P00332	2,200 3,300	P	4220 (2)	- 4.7
N_09Q00472 N_09Q00682	4,700 6,800	Q	4300 (2)	- 4.7
N_09R00103 N_09R00153	10,000 15,000	R	4400 (2)	- 4.8
N_09S00223	22,000	S	4520 (2)	- 5.0
N_09T00333 N_09T00473	33,000 47,000	T	4630 (2)	- 5.1
N_09U00683 N_09U00104 N_09U00154	68,000 100,000 150,000	U	4840 (2)	- 5.3

NTC Disc Thermistors

Packaging for Automatic Insertion



PACKAGING AND KINK SUFFIXES

Tables below indicate the suffixes to specify when ordering to get the required kink and packaging. For devices on tape, it is necessary to specify the height (H or Ho) which is the distance between the tape axis (sprocket holes axis) and the seating plane on the printed circuit board. The following types can be ordered on tape either in AMMOPACK (fan folder) or on REEL in accordance with IEC 286-2.

– Straight leads:

H represents the distance between the sprocket holes axis and the bottom plane of component body (base of resin or base of stand off).

– Kinked leads and flat leads:

Ho represents the distance between the sprocket holes axis and the base on the knee (kinked leads) or the bottom of the flat part (flat leads).

• Reel & Ammopack

millimeters (inches)

Types	Suffix	H or Ho	Leads	Quantity/Size	Packaging
ND/NE 03 & NJ28	CA	16 ± 0.5 (0.630 ± 0.020)	Straight	3000	AMMOPACK
	CB	16 ± 0.5 (0.630 ± 0.020)	Straight	3000	REEL
	CC	19.5 ± 0.5 (0.768 ± 0.020)	Straight	3000	AMMOPACK
	CD	19.5 ± 0.5 (0.768 ± 0.020)	Straight	3000	REEL
ND/NE/NV 06/09	DA	16 ± 0.5 (0.630 ± 0.020)	Straight	1500	AMMOPACK
	DB	16 ± 0.5 (0.630 ± 0.020)	Straight	1500	REEL
	DC	19.5 ± 0.5 (0.768 ± 0.020)	Straight	1500	AMMOPACK
	DD	19.5 ± 0.5 (0.768 ± 0.020)	Straight	1500	REEL
	DL	16 ± 0.5 (0.630 ± 0.020)	Kinked	1500	AMMOPACK
	DM	16 ± 0.5 (0.630 ± 0.020)	Kinked	1500	REEL
	DN	19.5 ± 0.5 (0.768 ± 0.020)	Kinked	1500	AMMOPACK
	DP	19.5 ± 0.5 (0.768 ± 0.020)	Kinked	1500	REEL

NTC

Type
ND03
NE03
NJ28

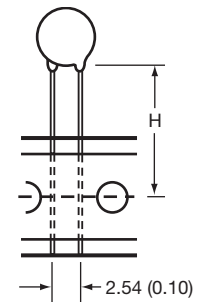

NTC

Types
ND/NE/NV
06/09

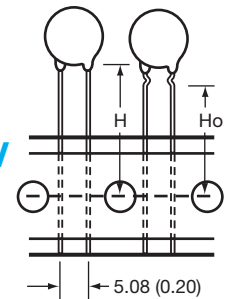

• Bulk

Type	Quantity/box
ND/NE03	3000
ND/NE06	1500
ND/NE09	1500
NV06	100
NV09	100
NI24 NJ28 NK20	1000

HOW TO ORDER

ND06

Type

P0

Material Code
P

0103

Resistance
10 kΩ

K

Tolerance
K (±10%)

--

Packaging
Bulk



NTC Disc Thermistors

TAPING CHARACTERISTICS

Missing components

A maximum of 3 consecutive components may be missing from the bandolier, surrounded by at least 6 filled positions. The number of missing components may not exceed 0.5% of the total per packing module.

The beginning and the end of tape exhibit 8 or 9 blank positions.

DIMENSIONS: millimeters (inches)

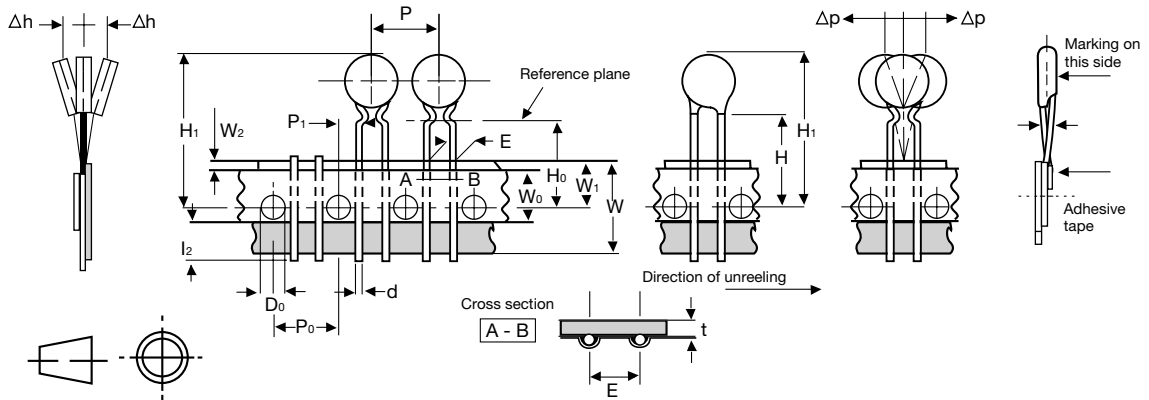
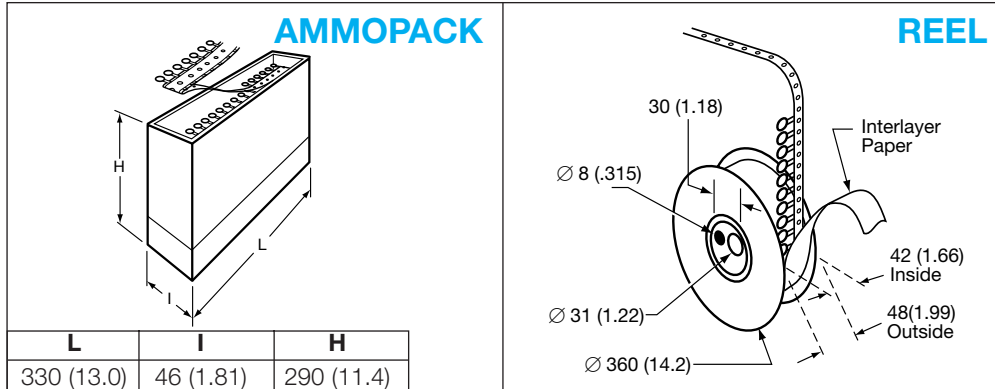

Value	Tolerance	Dimensions Characteristics	
18	+1 / -0.5	W	Leading tape width
6	±0.3	W ₀	Adhesive tape width
9	+0.75 / -0.5	W ₁	Sprocket hole position
3 max.		W ₂	Distance between the top of the tape and the adhesive
4	±0.2	D ₀	Diameter of sprocket hole
16/19.5	±0.5	H ₀	Distance between the tape axis and the seating plane of the component
		H ₁	Distance between the tape axis and the top of component body

Value	Tolerance	Dimensions Characteristics	
12.7	±0.2	P ₀	Sprocket holes pitch
254	±1	-	Distance between 21 consecutive holes 20 pitches
0.7	±0.2	t	Total thickness of tape
2.54	+0.6 / -0.1	E	Lead spacing
5.08	± 0.7	P ₁	Distance between the sprocket hole axis and the lead axis
12.7	±1.0	P	Spacing of components
0.5	±5%	d	Lead diameter
0	±1.3	°P	Verticality of components
0	±2	°h	Alignment of components

This type of product is widely used in automotive and consumer applications.

They are assembled in custom-probes for sensing the temperature of liquids (water, oil, ...), gases or surface of any other component.

The metallization covers completely the surfaces of the thermistor.

The particularly flat and smooth surfaces ensure an excellent electrical and thermal contact under pressure.

Types	NR
Physical data (dim. in mm)	
Marking	On package only / On parts upon request
Operating temperature	-40°C to +200°C
Values and tolerances	Custom - designed products defined with: $D \pm \Delta D$ $R_1 \pm \Delta R_1 / R_1$ at T_1 $E \pm \Delta E$ $R_2 \pm \Delta R_2 / R_2$ at T_2, \dots

DESIGN OF THE THERMISTOR

Choice of the resistances

If the application is to measure the temperature around a defined point, a unique nominal resistance can be chosen (for example, among standard values of the ND range products presented on pages 20 to 24).

When it is required to measure the temperature over selected ranges $T_1 - T_2$, $T_2 - T_3$, ..., the corresponding resistance R_1 , R_2 , R_3 , ..., must be such that they can be located on the R (T) characteristic of an existing NTC material (for example among standard materials whose R (T) are displayed on pages 36 to 40).

The resistances must also be compatible with the resistivity of the material and the dimensions of the thermistor.

Choice of the tolerances

The precision of the temperature measurement determines the calculation of the tolerance on the resistance:

$$\Delta R/R = \alpha (\%/^{\circ}\text{C}) \cdot \Delta T (^{\circ}\text{C})$$

For example, the NTC NR55--3049-99, using "N5" material (R (T) characteristic displayed on page 38), requires a precision of 1°C over the temperature range 110°C - 120°C.

The tolerances can be calculated:

$$\Delta R_{110^{\circ}\text{C}} / R_{110^{\circ}\text{C}} = 1^{\circ}\text{C} \cdot 2.91\%/^{\circ}\text{C} = 2.91\%$$

$$\Delta R_{120^{\circ}\text{C}} / R_{120^{\circ}\text{C}} = 1^{\circ}\text{C} \cdot 2.76\%/^{\circ}\text{C} = 2.76\%$$

*For your specific requirements, please consult us.

HOW TO ORDER



NTC Leadless Disc Thermistors



We present below some examples of our custom - designed products as an illustration of the different ways to define products.

DIMENSIONS: millimeters (inches)

Types	D	E	Material Code	B (k)	$R_1 \pm \Delta R_1$ at T_1	T_1 (°C)	$R_2 \pm \Delta R_2$ at T_2	T_2 (°C)	$R_3 \pm \Delta R_3$ at T_3	T_3 (°C)
NR 55 -- 3002 - 99	5.5 (.217) ± 0.5 (.020)	1.1 (.043) ± 0.4 (.016)	N5	4160	1230 Ω ± 7.5%	40	160 Ω ± 5%	96.5	-	-
NR 67 -- 3068 - 99	6.7 (.264) ± 0.5 (.020)	1.7 (.067) ± 0.3 (.012)	N	4080	150 Ω ± 3.3%	100	51 Ω ± 5.3%	140	-	-
NR 55 -- 3049 - 99	5.5 (.217) ± 0.5 (.020)	1.0 (.040) ± 0.2 (.008)	N5	4160	107 Ω ± 2.9%	110	80.6 Ω ± 2.8%	120	-	-
NR 55 -- 3046 - 99	5.5 (.217) ± 0.5 (.020)	1.3 (.051) ± 0.4 (.016)	S	4520	48600 Ω ± 7.5%	25	3210 Ω ± 5%	90	-	-
NR 49 -- 3119 - 99	4.9 (.193) ± 0.3 (.012)	1.5 (.060) ± 0.4 (.016)	M	3950	840 Ω ± 10%	37.8	84 Ω ± 5%	104.4	-	-
NR 55 -- 3114 - 99	5.5 (.217) ± 0.4 (.016)	1.0 (.040) ± 0.2 (.008)	P	4220	5000 Ω ± 10%	25	-	-	-	-
NR 70 -- 3121 - 99	7.0 (.275) ± 0.3 (.012)	1.2 (.047) ± 0.2 (.008)	L	3790	210 Ω ± 10%	40	40 Ω ± 7.5%	90	30 Ω ± 6.7%	100
NR 29 -- 3107 - 99	2.9 (.014) ± 0.3 (.012)	1.7 (.067) ± 0.3 (.012)	K	3630	2050 Ω ± 6%	25	193 Ω ± 5.4%	96.5	-	-
NR 55 -- 3122 - 99	5.5 (.217) ± 0.5 (.020)	1.5 (.060) ± 0.4 (.016)	J	3480	210 Ω ± 5%	25	-	-	-	-
NR 55 -- 3126 - 99	5.5 (.217) ± 0.5 (.020)	1.0 (.040) ± 0.2 (.008)	P	4220	3340 Ω ± 10%	25	264 Ω ± 7%	90	107 Ω ± 7%	120
NR 47 -- 3116 - 99	4.7 (.185) ± 0.4 (.016)	1.2 (.047) ± 0.2 (.008)	R	4400	33000 Ω ± 2%	25	-	-	-	-
NR 49 -- 3113 - 99	4.9 (.193) ± 0.3 (.012)	1.2 (.047) ± 0.2 (.008)	N	4080	1680 Ω ± 10%	40	382 Ω ± 6.7%	80	176 Ω ± 5%	105
NR 47 -- 3101 - 99	4.6 (.181) ± 0.3 (.012)	1.4 (.055) ± 0.3 (.012)	J	3480	146 Ω ± 13%	40	22 Ω ± 10%	100	-	-
NR 55 -- 3071 - 99	5.8 (.228) ± 0.3 (.012)	1.0 (.040) ± 0.2 (.008)	L	3790	262 Ω ± 8.7%	40	120 Ω ± 10%	60	35.5 Ω ± 7.8%	100
NR 61 -- 3063 - 99	6.1 (.240) ± 0.3 (.012)	1.5 (.060) ± 0.3 (.012)	N	4080	760 Ω ± 9.2%	50	130 Ω ± 8.5%	100	56.6 Ω ± 8.5%	130
NR 67 -- 3053 - 99	6.7 (.264) ± 0.4 (.016)	1.7 (.067) ± 0.3 (.012)	N	4080	540 Ω ± 11%	60	144 Ω ± 7%	100	-	-
NR 50 -- 3048 - 99	5.0 (.197) ± 0.5 (.020)	1.5 (.060) ± 0.5 (.020)	J	3480	233 Ω ± 10%	25	13.3 Ω ± 7%	121	-	-
NR 60 -- 3021 - 99	6.0 (.236) ± 0.5 (.020)	3.2 (.125) ± 0.3 (.012)	P	4220	3640 Ω ± 3%	40	457 Ω ± 3%	96.5	-	-
NR 55 -- 3016 - 99	5.5 (.217) ± 0.5 (.020)	1.1 (.043) ± 0.4 (.016)	Q	4300	5500 Ω ± 9%	40	650 Ω ± 7.7%	96.5	-	-

Resistance - Temperature characteristics: pages 36 to 40.

NTC Inrush Current Limiters Thermistors



NF 08 - 10 - 13 - 15 - 20

(For more details see also the catalog dedicated to this range)

OUTLINE DRAWINGS

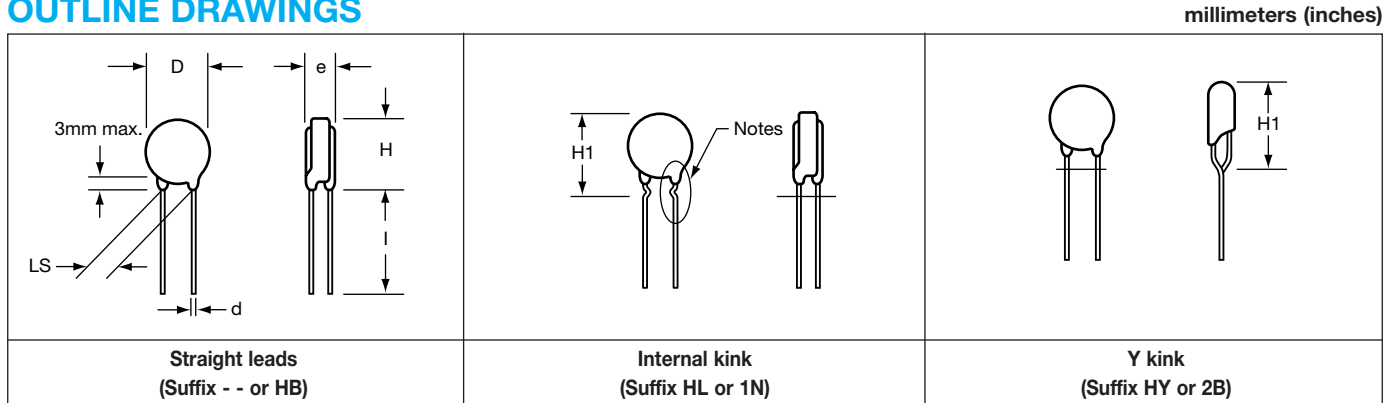

Notes: In case of adding strength to the lead wire from the side, it may occur crack and fragment at a part of pant leg.
* 0.6 mm copper wire and 5.08 mm leads spacing for those two types.

DIMENSIONS millimeters (inches)

Type	D max mm	e max mm	H max mm	H1 max mm	l min mm	d ±0.02 mm (±0.008)	LS ±0.8 mm (±0.030)
NF08*	9.5 (.374)	5.0 (.197)	13.0 (.512)	16.0 (.630)	30 (1.181)	0.6 (.024)	5.08 (.20)
NF08	9.5 (.374)	5.0 (.197)	13.0 (.512)	16.0 (.630)	30 (1.181)	0.8 (.031)	7.62 (.03)
NF10*	11.5 (.453)	5.0 (.197)	15.0 (.591)	18.0 (.709)	30 (1.181)	0.6 (.024)	5.08 (.20)
NF10	11.5 (.453)	5.0 (.197)	15.0 (.591)	18.0 (.709)	30 (1.181)	0.8 (.031)	7.62 (.30)
NF13	15.0 (.591)	6.0 (.236)	18.0 (.709)	22.0 (.866)	30 (1.181)	0.8 (.031)	7.62 (.30)
NF15	17.0 (.669)	6.0 (.236)	20.0 (.787)	24.0 (.945)	30 (1.181)	1.0 (.039)	7.62 (.30)
NF20	22.0 (.866)	6.0 (.236)	25.0 (.984)	29.0 (1.142)	30 (1.181)	1.0 (.039)	7.62 (.30)

GENERAL CHARACTERISTICS

Type	Standard tolerance** %	Maximum operating T°C	Max power 25°C Watts	Thermal dissipation δ _{th} (mW/K)	Thermal time constant τ _C (s)	Heat capacity H (mJ/K)	Packing bulk	Packing tape
NF08*	20	-40 / +200	1.6	8	60	480	✓	✓
NF08	20	-40 / +200	2.2	11	60	660	✓	✓
NF10*	20	-40 / +200	2.0	10	75	750	✓	-
NF10	20	-40 / +200	2.6	13	75	975	✓	✓
NF13	20	-40 / +200	3.2	16	100	1600	✓	✓
NF15	20	-40 / +200	4.1	20	115	2300	✓	-
NF20	20	-40 / +200	5.0	25	160	4000	✓	-

* 0.6 mm copper wire and 5.08 mm leads spacing for those two types.

** Other tolerances available: L: ±15, X: ±25%

SUFFIXES FOR BULK PACKING (Suffixes for taping: see page 35)

- - straight leads 0.8 or 1 mm wire diameter and 7.62 lead spacing
- HB straight leads 0.6 mm wire diameter and 5.08 lead spacing
- HL internal kink 0.8 mm or 1 mm wire diameter and 7.62 lead spacing
- 1N internal kink 0.6 mm wire diameter and 5.08 lead spacing
- HY Y kink 0.8 or 1 mm wire diameter and 7.62 lead spacing
- 2B Y kink 0.6 mm wire diameter and 5.08 lead spacing

HOW TO ORDER

NF13

Type

AA

Inrush Current Limiters

0509

Resistance
5 kΩ

M

Tolerance
M (±20%)

--

Suffix
Bulk, Straight Leads
(See illustration above)



Table of Values



NF 08 - 10 - 13 - 15 - 20

cUL	Ceramic Disc ø (mm)	Part number reference T _{ype}	Zero power resistance R _{25°C} (Ω)	Max steady state current I _{SS} max 25°C (A)	Resistance at max current R _{ISS} max (Ω)
*	08	NF08AA0509MHB	5.0	2.9	0.20
*		NF08AA0809MHB	8.0	2.3	0.30
*		NF08AA0100MHB	10.0	2.1	0.37
*		NF08AA0150MHB	15.0	1.8	0.50
*		NF08AA0330MHB	33.0	1.3	0.97
*	08	NF08AA0509M --	5.0	3.4	0.20
*		NF08AA0809M --	8.0	2.7	0.30
*		NF08AA0100M --	10.0	2.5	0.37
*		NF08AA0150M --	15.0	2.1	0.50
*		NF08AA0330M --	33.0	1.5	0.97
*	10	NF10AA0259MHB	2.5	4.5	0.10
*		NF10AA0409MHB	4.0	3.6	0.16
*		NF10AA0509MHB	5.0	3.3	0.19
*		NF10AA0809MHB	8.0	2.6	0.30
*		NF10AA0100MHB	10.0	2.5	0.34
*		NF10AA0160MHB	16.0	2.0	0.50
*		NF10AA0200MHB	20.0	1.9	0.59
*		NF10AA0250MHB	25.0	1.7	0.69
*		NF10AA0500MHB	50.0	1.4	1.07
*		NF10AA0800MHB	80.0	1.1	1.60
*		NF10AA0121MHB	120.0	1.0	1.90
*		10	NF10AA0259M --	2.5	5.2
*	NF10AA0409M --		4.0	4.1	0.16
*	NF10AA0509M --		5.0	3.8	0.19
*	NF10AA0809M --		8.0	3.0	0.30
*	NF10AA0100M --		10.0	2.8	0.34
*	NF10AA0160M --		16.0	2.3	0.50
*	NF10AA0200M --		20.0	2.1	0.59
*	NF10AA0250M --		25.0	2.0	0.69
*	NF10AA0500M --		50.0	1.6	1.07
*	NF10AA0800M --		80.0	1.3	1.60
*	NF10AA0121M --		120.0	1.2	1.90
*	13		NF13AA0259M --	2.5	5.7
*		NF13AA0509M --	5.0	4.2	0.19
*		NF13AA0709M --	7.0	3.7	0.24
*		NF13AA0809M --	8.0	3.6	0.25
*		NF13AA0100M --	10.0	3.3	0.30
*		NF13AA0150M --	15.0	2.8	0.41
*		NF13AA0220M --	22.0	2.3	0.61
*		NF13AA0330M --	33.0	2.2	0.70
*		NF13AA0400M --	40.0	2.0	0.80
*		NF13AA0600M --	60.0	1.9	0.95
*		15	NF15AA0139M --	1.3	8.9
*	NF15AA0159M --		1.5	8.3	0.06
*	NF15AA0259M --		2.5	6.6	0.09
*	NF15AA0309M --		3.0	6.1	0.11
*	NF15AA0409M --		4.0	5.5	0.13
*	NF15AA0509M --		5.0	4.9	0.17
*	NF15AA0609M --		6.0	4.7	0.19
*	NF15AA0709M --		7.0	4.3	0.22
*	NF15AA0809M --		8.0	4.2	0.24
*	NF15AA0100M --		10.0	3.7	0.30
*	NF15AA0120M --		12.0	3.5	0.33
*	NF15AA0160M --		16.0	3.0	0.44
*	NF15AA0200M --		20.0	3.1	0.43
*	NF15AA0250M --		25.0	2.8	0.53
*	NF15AA0330M --		33.0	2.5	0.66
*	NF15AA0400M --	40.0	2.3	0.80	
*	NF15AA0470M --	47.0	2.3	0.74	
*	20	NF20AA0259M --	2.5	7.8	0.08
*		NF20AA0409M --	4.0	6.4	0.13
*		NF20AA0509M --	5.0	5.9	0.15
*		NF20AA0100M --	10.0	4.3	0.28
*		NF20AA0150M --	15.0	4.0	0.32
*		NF20AA0330M --	33.0	3.1	0.52

* c/L/L approval (File E167822)

- Electrical performances for suffixes HL and HY are identical to the suffix --.
- Electrical performances for suffixes 1N and 2B are identical to the suffix HB



NTC Inrush Current Limiters Thermistors

Application Guide

1 – HOW TO DETERMINE THE MAXIMUM STEADY STATE CURRENT OF NF THERMISTORS?

- If the ambient temperature is 25°C: the current is given in table page 30.
- If the ambient temperature is different from 25°C: the current at 25°C must be derated as specified in the graph below.

Example: maximum steady state current of NF13AA0100M at 60°C ambient:

$$I_{SS_{max25}} \times 0.9 = 3.0 \text{ A.}$$

Derating of maximum steady state current with ambient temperature

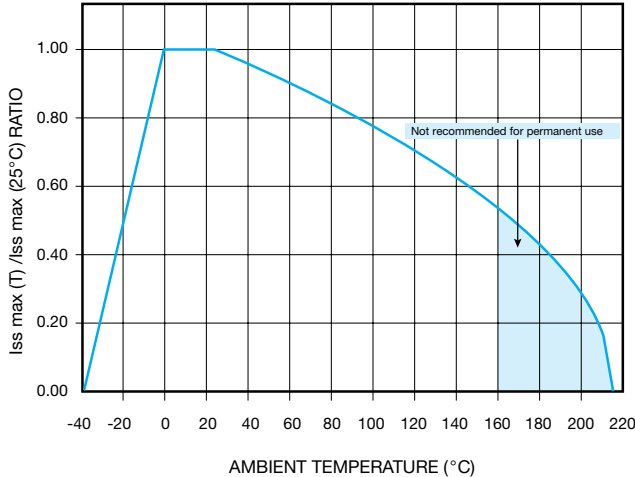

2 – HOW TO CALCULATE THE WORKING TEMPERATURE OF NF THERMISTOR?

Example: NF08AA0330M

$$I_{SS} = 0.2 \text{ A, } T_{\text{ambient}} = 25^\circ\text{C}$$

- From the graph V (I) page 32, we find $V_{SS} = 2.2 \text{ V}$ therefore, $R_{SS} = 11 \Omega$
- From the graph R(T), page 32, at $R = 11 \Omega$, we find $T \pm 65^\circ\text{C}$

3 – HOW TO CALCULATE THE WORKING POINT OF NF THERMISTOR AT A DIFFERENT AMBIENT TEMPERATURE THAN 25°C?

Example: NF13AA0100M

$$I_{SS} = 3 \text{ A, } T_{\text{ambient}} = T_A = 60^\circ\text{C}$$

$$R_T I_{SS}^2 = \delta (T - T_A) \text{ and thus}$$

$$T = \frac{R_T I_{SS}^2}{\delta} + T_A$$

- As R_T depends on T , this equation is quite complex to be solved by an algebraic way. The quickest manner to solve it is to operate by iterations:

for NF13, $\delta = 16 \text{ mW/K}$ (see page 29)

therefore, the equation becomes:

$$T = 562.5 R_T + 60$$

from the R_T curve page 33 we find R_T starting from T :

T (°C)	$R_T (\Omega)$	\Rightarrow	$562.5 R_T + 60$ (°C)
185	0.28		217
190	0.26		206
195	0.24		195
200	0.22		184

The working temperature of this NF thermistor is about 195°C when operating under $I_{SS} = 3 \text{ A}$ and $T_A = 60^\circ\text{C}$ (this temperature is the one for which we have $T = 562.5 R_T + 60$).

Important: A discrepancy may exist between practice and theory due to the tolerance of the thermistor ($\pm 20\%$ usually).

NTC Inrush Current Limiters Thermistors



Voltage-Current and Resistance-Temperature Characteristics

TYPICAL VOLTAGE/CURRENT CHARACTERISTICS FOR TYPE NF08

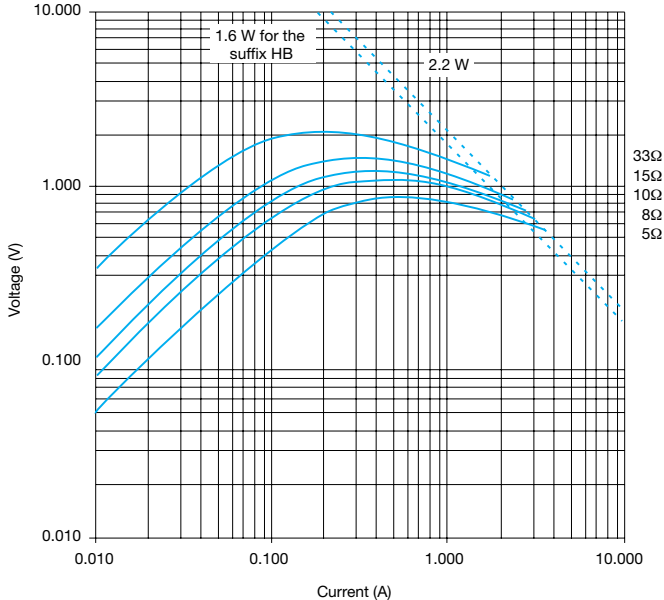

TYPICAL RESISTANCE/TEMPERATURE CHARACTERISTICS FOR TYPE NF08

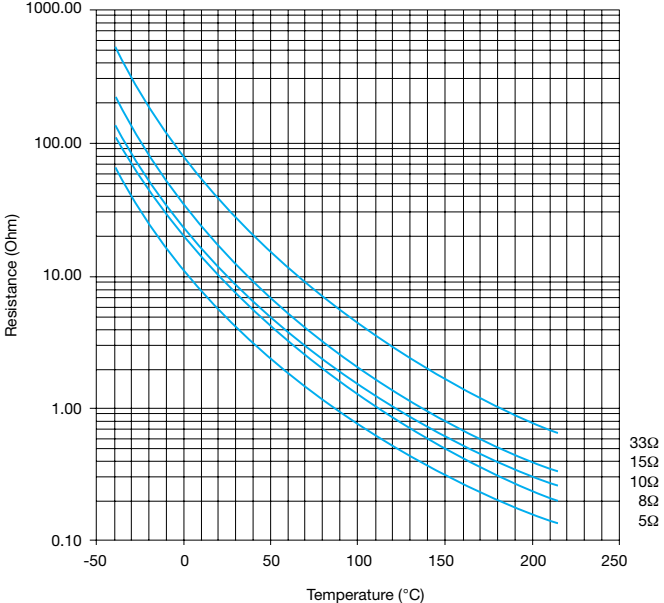

NTC Inrush Current Limiters Thermistors



Voltage-Current and Resistance-Temperature Characteristics

TYPICAL VOLTAGE/CURRENT CHARACTERISTICS FOR TYPE NF10

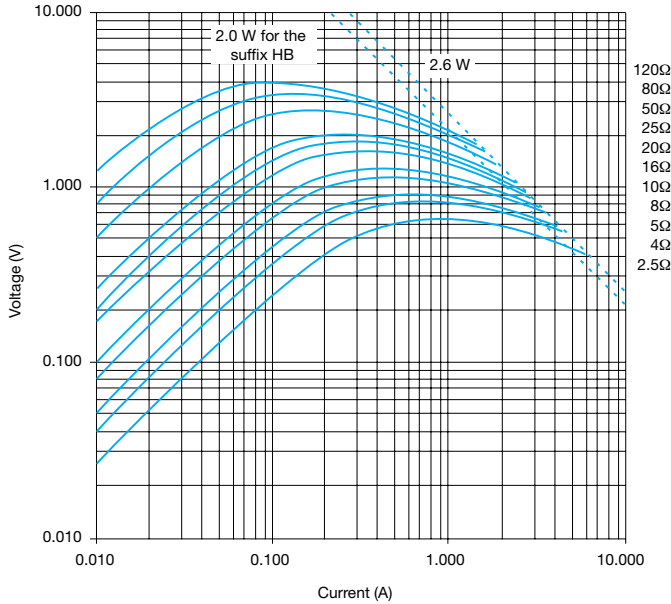

TYPICAL VOLTAGE/CURRENT CHARACTERISTICS FOR TYPE NF13

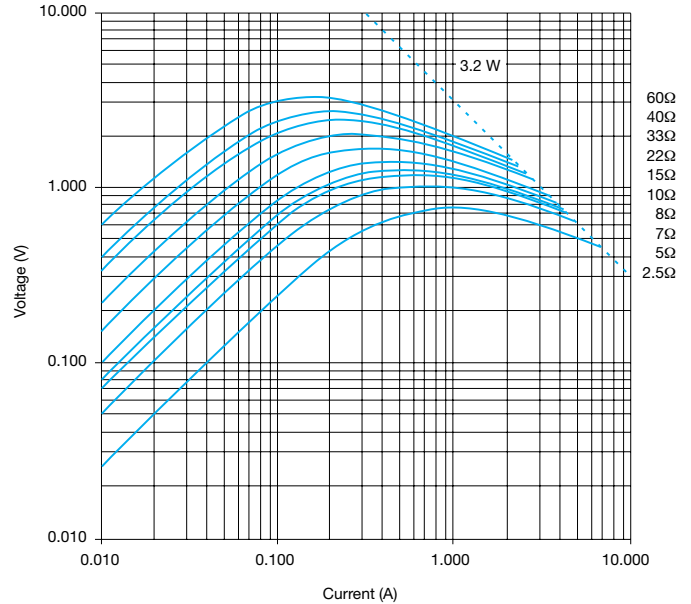

TYPICAL RESISTANCE/TEMPERATURE CHARACTERISTICS FOR TYPE NF10

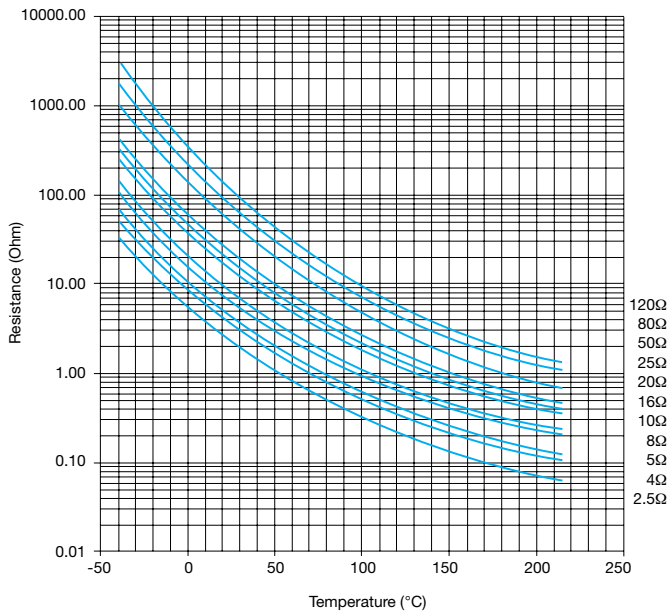

TYPICAL RESISTANCE/TEMPERATURE CHARACTERISTICS FOR TYPE NF13

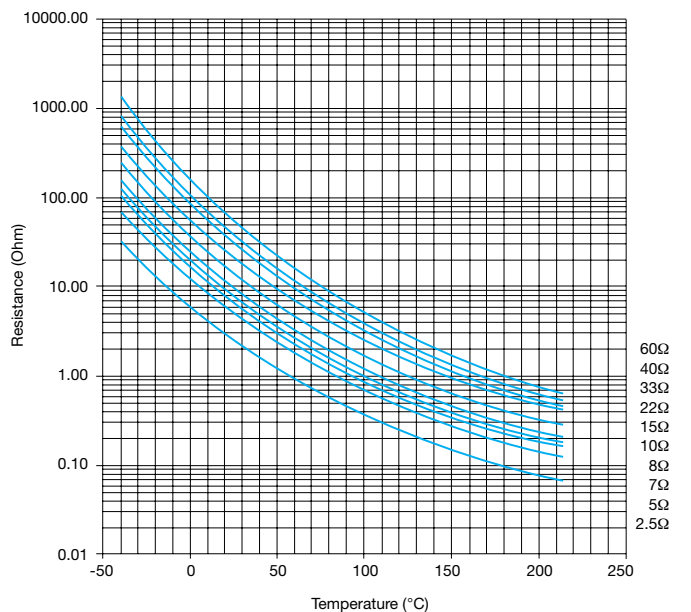

NTC Inrush Current Limiters Thermistors



Voltage-Current and Resistance-Temperature Characteristics

TYPICAL VOLTAGE/CURRENT CHARACTERISTICS FOR TYPE NF15

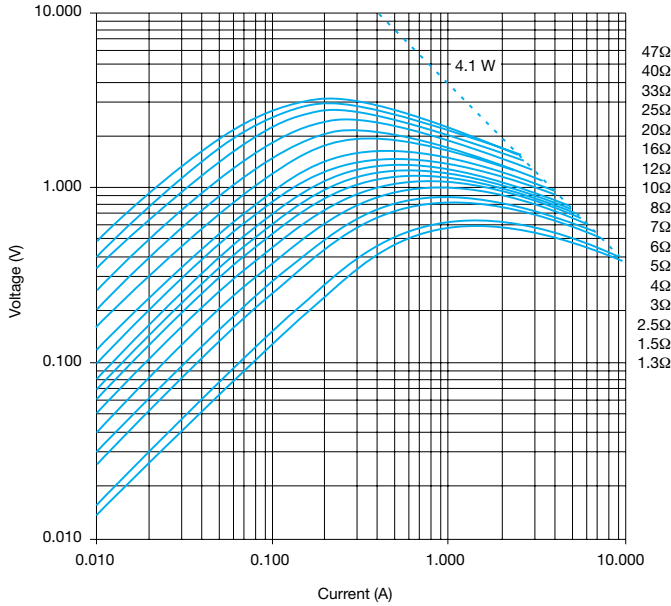

TYPICAL VOLTAGE/CURRENT CHARACTERISTICS FOR TYPE NF20

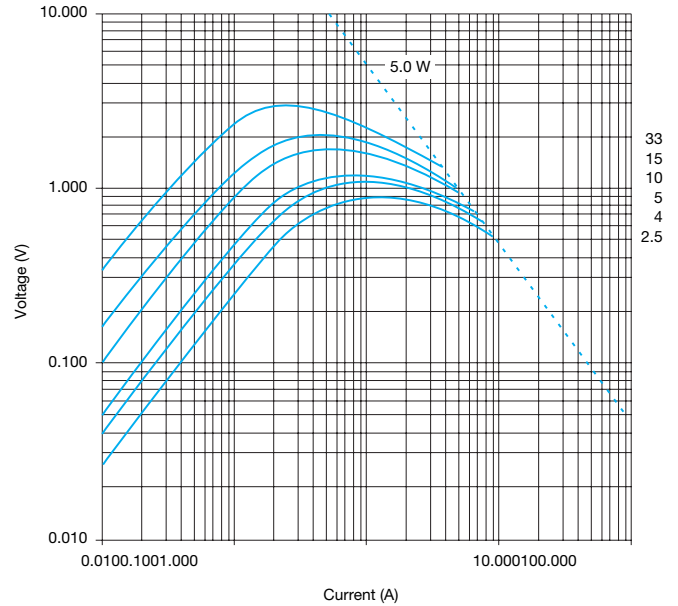

TYPICAL RESISTANCE/TEMPERATURE CHARACTERISTICS FOR TYPE NF15

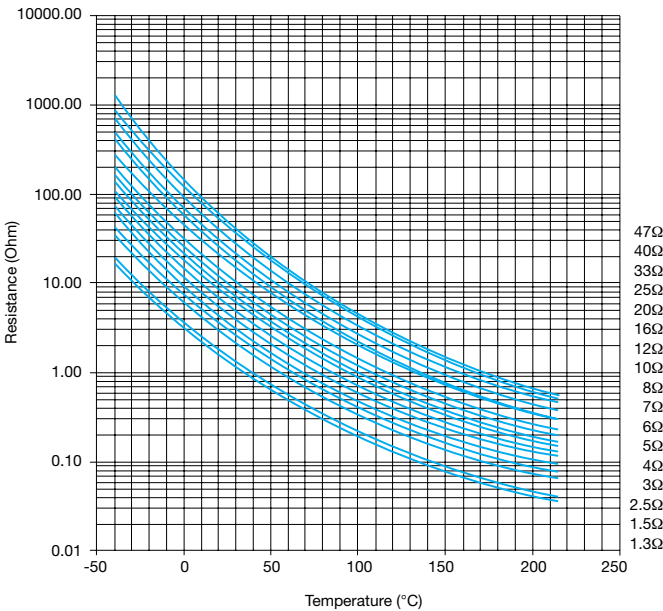

TYPICAL RESISTANCE/TEMPERATURE CHARACTERISTICS FOR TYPE NF20

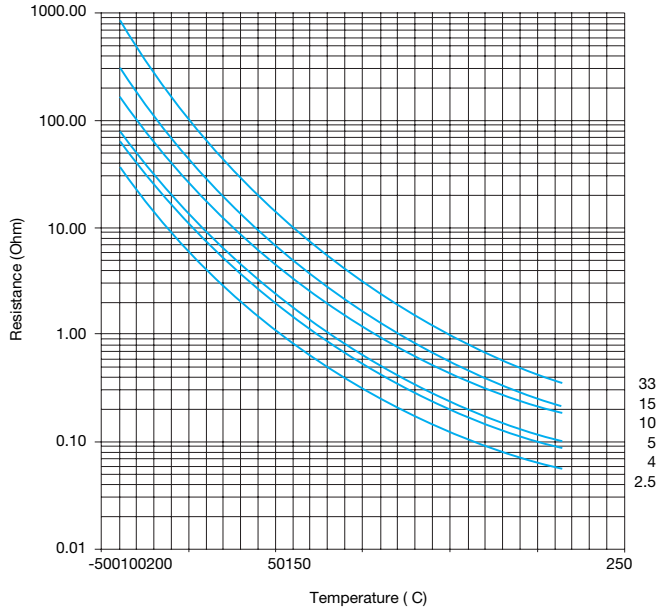

Packaging for Automatic Insertion



NTC Disc Thermistors / NF Series

PACKAGING AND KINK SUFFIXES

The following types can be ordered on tape either in AMMOPACK (fan folder) or on REEL in accordance with IEC 286-2.

Types	Straight		NF08 Internal Kink		"Y" Kink	
Leads	Straight		Internal Kink		"Y" Kink	
DIMENSIONS: millimeters (inches)						
Packaging	AMMOPACK	REEL	AMMOPACK	REEL	AMMOPACK	REEL
Ho = 16	DA	DB	DQ	DR	D7	D5
Ho = 19.5	DC	DD	DS	DT	D8	D6

Types	Straight		NF08 / 10 / 13 Internal Kink		"Y" Kink	
Leads	Straight		Internal Kink		"Y" Kink	
DIMENSIONS: millimeters (inches)						
Packaging	AMMOPACK	REEL	AMMOPACK	REEL	AMMOPACK	REEL
Ho = 16	EA	EN	EC	EF	EQ	ER
Ho = 19.5	EB	ED				

PACKAGING QUANTITIES

Type	AMMOPACK	REEL	BULK
NF08* (5.08)	1000	1000	450
NF08 (7.62)	750	750	
NF10* (5.08)			450
NF10 (7.62)	750	750	
NF13 (7.62)	750	750	400
NF15 (7.62)	–	–	250
NF20 (7.62)	–	–	150

Tables of Resistance vs Temperature



T (°C)	Material code B (K)									T (°C)
	I 3250			J-J5 3480			K 3630			
	R (T) / R25	TF (%)	α (%/°C)	R (T) / R25	TF (%)	α (%/°C)	R (T) / R25	TF (%)	α (%/°C)	
-55	42.35	21.9	-5.98	51.74	20.5	-6.43	56.26	21.4	-6.46	-55
-50	31.48	20.0	-5.78	37.97	17.7	-6.21	41.21	18.5	-6.26	-50
-45	23.63	18.1	-5.59	28.15	15.2	-6.01	30.47	15.9	-6.06	-45
-40	17.91	16.3	-5.41	21.07	13.0	-5.81	22.73	13.6	-5.88	-40
-35	13.70	14.6	-5.23	15.91	11.0	-5.62	17.11	11.5	-5.70	-35
-30	10.58	13.1	-5.06	12.13	9.3	-5.44	12.98	9.7	-5.53	-30
-25	8.232	11.6	-4.90	9.320	7.8	-5.26	9.930	8.1	-5.36	-25
-20	6.460	10.1	-4.74	7.221	6.4	-5.10	7.654	6.7	-5.21	-20
-15	5.110	8.8	-4.59	5.640	5.2	-4.94	5.945	5.4	-5.05	-15
-10	4.072	7.5	-4.45	4.438	4.2	-4.78	4.650	4.4	-4.91	-10
-5	3.268	6.3	-4.31	3.517	3.3	-4.64	3.663	3.4	-4.76	-5
0	2.641	5.1	-4.18	2.807	2.5	-4.50	2.905	2.6	-4.63	0
5	2.148	4.0	-4.05	2.255	1.8	-4.36	2.319	1.9	-4.50	5
10	1.759	2.9	-3.92	1.824	1.2	-4.23	1.862	1.3	-4.37	10
15	1.449	1.9	-3.81	1.484	0.7	-4.10	1.505	0.8	-4.25	15
20	1.200	0.9	-3.69	1.215	0.3	-3.98	1.223	0.3	-4.13	20
25	1.000	0.0	-3.58	1.0000	0.0	-3.87	1.0000	0.0	-4.01	25
30	.8377	0.9	-3.48	.8278	0.3	-3.76	.8219	0.3	-3.90	30
35	.7054	1.8	-3.38	.6889	0.7	-3.65	.6792	0.7	-3.80	35
40	.5969	2.6	-3.28	.5763	1.1	-3.55	.5641	1.1	-3.69	40
45	.5076	3.5	-3.19	.4845	1.5	-3.45	.4708	1.6	-3.59	45
50	.4336	4.3	-3.10	.4092	2.0	-3.35	.3949	2.1	-3.50	50
55	.3720	5.1	-3.01	.3473	2.5	-3.26	.3327	2.6	-3.41	55
60	.3206	5.9	-2.93	.2960	3.0	-3.17	.2816	3.1	-3.32	60
65	.2774	6.6	-2.85	.2534	3.5	-3.09	.2393	3.7	-3.23	65
70	.2410	7.4	-2.77	.2178	4.1	-3.01	.2043	4.3	-3.14	70
75	.2102	8.1	-2.70	.1879	4.7	-2.93	.1751	4.9	-3.06	75
80	.1839	8.8	-2.63	.1628	5.3	-2.85	.1507	5.5	-2.99	80
85	.1616	9.5	-2.56	.1415	5.9	-2.78	.1301	6.1	-2.91	85
90	.1424	10.2	-2.49	.1235	6.5	-2.70	.1128	6.8	-2.84	90
95	.1259	10.9	-2.43	.1081	7.1	-2.64	.09812	7.4	-2.77	95
100	.1117	11.5	-2.36	.09500	7.7	-2.57	.08565	8.1	-2.70	100
105	.09938	12.2	-2.30	.08373	8.4	-2.50	.07502	8.7	-2.63	105
110	.08869	12.8	-2.25	.07403	9.0	-2.44	.06592	9.4	-2.57	110
115	.07938	13.4	-2.19	.06565	9.7	-2.38	.05810	10.1	-2.50	115
120	.07124	14.0	-2.14	.05838	10.3	-2.33	.05137	10.8	-2.44	120
125	.06410	14.6	-2.08	.05207	11.0	-2.27	.04555	11.5	-2.39	125
130	.05783	15.2	-2.03	.04567	11.6	-2.22	.04050	12.2	-2.33	130
135	.05230	15.7	-1.98	.04175	12.3	-2.16	.03611	12.8	-2.27	135
140	.04741	16.3	-1.94	.03753	13.0	-2.11	.03229	13.5	-2.22	140
145	.04308	16.8	-1.89	.03382	13.6	-2.06	.02894	14.2	-2.17	145
150	.03924	17.4	-1.85	.03055	14.3	-2.02	.02600	14.9	-2.12	150

T (°C)	Material code B (K)									T (°C)
	KA 3625			KC 3470			L 3790			
	R (T) / R25	TF (%)	α (%/°C)	R (T) / R25	TF (%)	α (%/°C)	R (T) / R25	TF (%)	α (%/°C)	
-55	61.21	7.1	-6.77	60.08	34.0	-7.00	82.52	22.3	-7.38	-55
-50	44.24	6.1	-6.53	43.19	29.4	-6.71	58.01	19.3	-7.11	-50
-45	32.33	5.3	-6.30	31.42	25.3	-6.44	41.30	16.6	-6.84	-45
-40	23.88	4.5	-6.08	23.13	21.6	-6.18	29.75	14.2	-6.60	-40
-35	17.81	3.8	-5.88	17.22	18.4	-5.94	21.67	12.0	-6.36	-35
-30	13.41	3.2	-5.68	12.95	15.5	-5.71	15.96	10.1	-6.13	-30
-25	10.19	2.7	-5.49	9.842	12.9	-5.49	11.88	8.5	-5.92	-25
-20	7.814	2.2	-5.31	7.550	10.7	-5.29	8.930	7.0	-5.72	-20
-15	6.040	1.8	-5.14	5.845	8.7	-5.10	6.776	5.7	-5.32	-15
-10	4.707	1.5	-4.98	4.564	6.9	-4.91	5.188	4.5	-5.34	-10
-5	3.696	1.1	-4.83	3.594	5.4	-4.74	4.007	3.6	-5.16	-5
0	2.923	.9	-4.68	2.853	4.1	-4.58	3.120	2.7	-4.99	0
5	2.329	.6	-4.53	2.281	3.0	-4.42	2.449	2.0	-4.83	5
10	1.867	.4	-4.40	1.838	2.0	-4.27	1.937	1.3	-4.68	10
15	1.507	.3	-4.27	1.491	1.2	-4.13	1.543	.8	-4.53	15
20	1.224	.1	-4.14	1.217	0.5	-4.00	1.238	.4	-4.39	20
25	1.0000	0.0	-4.02	1.0000	0.0	-3.90	1.0000	0.0	-4.25	25
30	.8217	.1	-3.91	.8267	0.5	-3.74	.8129	.3	-4.12	30
35	.6788	.2	-3.80	.6873	1.1	-3.63	.6648	.7	-4.00	35
40	.5638	.4	-3.69	.5747	1.8	-3.52	.5409	1.2	-3.88	40
45	.4707	.5	-3.59	.4830	2.5	-3.41	.4525	1.6	-3.77	45
50	.3948	.7	-3.49	.4081	3.3	-3.31	.3765	2.2	-3.66	50
55	.3328	.9	-3.40	.3465	4.1	-3.21	.3148	2.7	-3.55	55
60	.2818	1.0	-3.31	.2955	5.0	-3.12	.2646	3.3	-3.45	60
65	.2396	1.2	-3.22	.2532	5.9	-3.03	.2235	3.8	-3.36	65
70	.2046	1.4	-3.14	.2179	6.8	-2.94	.1896	4.5	-3.26	70
75	.1754	1.6	-3.06	.1883	7.8	-2.86	.1616	5.1	-3.17	75
80	.1510	1.8	-2.98	.1634	8.7	-2.78	.1383	5.7	-3.09	80
85	.1305	2.0	-2.90	.1423	9.7	-2.71	.1189	6.4	-3.00	85
90	.1131	2.3	-2.83	.12441	10.8	-2.63	.1026	7.1	-2.92	90
95	.09846	2.5	-2.76	.10915	11.8	-2.56	.08889	7.7	-2.85	95
100	.08597	2.7	-2.69	.09608	12.9	-2.50	.07729	8.4	-2.77	100
105	.07531	2.9	-2.63	.08486	13.9	-2.43	.06745	9.1	-2.70	105
110	.06618	3.1	-2.56	.07519	15.0	-2.37	.05906	9.8	-2.63	110
115	.05834	3.4	-2.50	.06683	16.1	-2.31	.05189	10.5	-2.57	115
120	.05158	3.6	-2.44	.05957	17.2	-2.25	.04573	11.3	-2.50	120
125	.04573	3.8	-2.39	.05325	18.3	-2.20	.04043	12.0	-2.44	125
130	.04066	4.0	-2.33	.04774	19.4	-2.14	.03585	12.7	-2.38	130
135	.03625	4.3	-2.28	.04290	20.5	-2.09	.03188	13.4	-2.33	135
140	.03240	4.5	-2.23	.03866	21.6	-2.04	.02843	14.1	-2.27	140
145	.02903	4.7	-2.18	.03492	22.7	-1.99	.02543	14.8	-2.22	145
150	.02608	5.0	-2.13	.03162	23.8	-1.95	.02279	15.6	-2.17	150



Tables of Resistance vs Temperature



T (°C)	Material code B (K)									T (°C)
	L2 3805			M 3950			MA 3960			
	R (T) / R25	TF (%)	α (%/°C)	R (T) / R25	TF (%)	α (%/°C)	R (T) / R25	TF (%)	α (%/°C)	
-55	62.45	22.4	-6.4	99.56	23.2	-7.71	104.2	3.9	-7.89	-55
-50	45.40	19.3	-6.2	68.95	20.1	-7.42	71.63	3.4	-7.57	-50
-45	33.33	16.6	-6.0	48.38	17.3	-7.15	49.94	2.9	-7.28	-45
-40	24.70	14.2	-5.9	34.37	14.8	-6.89	35.28	2.5	-7.00	-40
-35	18.47	12.1	-5.7	24.71	12.5	-6.64	25.25	2.1	-6.73	-35
-30	13.92	10.2	-5.5	17.96	10.6	-6.41	18.28	1.8	-6.48	-30
-25	10.58	8.5	-5.4	13.20	8.8	-6.18	13.39	1.5	-6.25	-25
-20	8.110	7.0	-5.2	9.803	7.3	-5.97	9.917	1.2	-6.02	-20
-15	6.260	5.7	-5.1	7.351	5.9	-5.77	7.419	1.0	-5.81	-15
-10	4.867	4.6	-4.9	5.585	4.7	-5.57	5.605	.8	-5.61	-10
-5	3.810	3.6	-4.8	4.251	3.7	-5.39	4.275	.6	-5.42	-5
0	3.003	2.7	-4.7	3.275	2.8	-5.21	3.289	.5	-5.24	0
5	2.382	2.0	-4.5	2.544	2.0	-5.04	2.552	.3	-5.06	5
10	1.901	1.3	-4.4	1.992	1.4	-4.88	1.997	.2	-4.90	10
15	1.526	0.8	-4.3	1.572	.8	-4.73	1.574	.1	-4.74	15
20	1.232	0.4	-4.2	1.249	.4	-4.58	1.250	.1	-4.59	20
25	1.0000	0.0	-4.1	1.0000	0.0	-4.44	1.0000	0.0	-4.45	25
30	.8161	0.3	-4.0	.8057	.4	-4.30	.8053	.1	-4.31	30
35	.6694	0.7	-3.9	.6534	.8	-4.17	.6527	.1	-4.18	35
40	.5518	1.2	-3.8	.5331	1.2	-4.05	.5323	.2	-4.06	40
45	.4570	1.7	-3.7	.4376	1.7	-3.93	.4367	.3	-3.94	45
50	.3802	2.2	-3.6	.3612	2.2	-3.81	.3604	.4	-3.82	50
55	.3178	2.7	-3.5	.2998	2.8	-3.71	.2990	.5	-3.71	55
60	.2667	3.3	-3.5	.2501	3.4	-3.60	.2493	.6	-3.61	60
65	.2248	3.9	-3.4	.2097	4.0	-3.50	.2090	.7	-3.51	65
70	.1902	4.5	-3.3	.1767	4.6	-3.40	.1760	.8	-3.41	70
75	.1615	5.1	-3.2	.1496	5.3	-3.31	.1489	.9	-3.32	75
80	.1377	5.8	-3.1	.1272	6.0	-3.22	.1266	1.0	-3.23	80
85	.1179	6.4	-3.1	.1087	6.7	-3.13	.1081	1.1	-3.14	85
90	.1012	7.1	-3.0	.09321	7.4	-3.05	.09262	1.2	-3.06	90
95	.08721	7.8	-2.9	.08027	8.1	-2.97	.07970	1.3	-2.98	95
100	.07539	8.5	-2.9	.06939	8.8	-2.89	.06885	1.5	-2.91	100
105	.06538	9.2	-2.8	.06020	9.5	-2.82	.05969	1.6	-2.83	105
110	.05688	9.9	-2.8	.05243	10.2	-2.75	.05194	1.7	-2.76	110
115	.04963	10.6	-2.7	.04581	11.0	-2.68	.04535	1.8	-2.69	115
120	.04343	11.3	-2.6	.04017	11.7	-2.61	.03973	2.0	-2.63	120
125	.03812	12.0	-2.6	.03533	12.5	-2.55	.03491	2.1	-2.56	125
130	.03354	12.7	-2.5	.03117	13.2	-2.48	.03077	2.2	-2.50	130
135	.02960	13.5	-2.5	.02759	14.0	-2.42	.02721	2.3	-2.44	135
140	.02618	14.2	-2.4	.02449	14.7	-2.37	.02412	2.5	-2.39	140
145	.02322	14.9	-2.4	.02180	15.5	-2.31	.02145	2.6	-2.33	145
150	.02064	15.6	-2.3	.01945	16.2	-2.26	.01912	2.7	-2.28	150

T (°C)	Material code B (K)									T (°C)
	MC 3910			N 4080			NA 4100			
	R (T) / R25	TF (%)	α (%/°C)	R (T) / R25	TF (%)	α (%/°C)	R (T) / R25	TF (%)	α (%/°C)	
-55	100.6	23.0	-7.88	110.1	24.0	-7.81	109.5	8.0	-7.83	-55
-50	69.29	19.9	-7.55	75.90	20.7	-7.53	75.42	6.9	-7.54	-50
-45	48.41	17.1	-7.24	52.98	17.8	-7.26	52.63	6.0	-7.27	-45
-40	34.27	14.6	-6.96	37.43	15.2	-7.01	37.18	5.1	-7.01	-40
-35	24.57	12.4	-6.68	26.75	12.9	-6.77	26.58	4.3	-6.76	-35
-30	17.83	10.5	-6.42	19.33	10.9	-6.54	19.22	3.7	-6.52	-30
-25	13.09	8.7	-6.18	14.12	9.1	-6.32	14.04	3.1	-6.30	-25
-20	9.714	7.2	-5.95	10.41	7.5	-6.10	10.37	2.5	-6.09	-20
-15	7.283	5.9	-5.73	7.758	6.1	-5.90	7.730	2.1	-5.89	-15
-10	5.515	4.7	-5.53	5.834	4.9	-5.71	5.817	1.6	-5.70	-10
-5	4.215	3.7	-5.33	4.426	3.8	-5.53	4.416	1.3	-5.51	-5
0	3.251	2.8	-5.15	3.387	2.9	-5.35	3.382	1.0	-5.34	0
5	2.528	2.0	-4.97	2.614	2.1	-5.18	2.611	.7	-5.17	5
10	1.983	1.4	-4.80	2.033	1.4	-5.02	2.032	.5	-5.01	10
15	1.567	0.8	-4.65	1.593	.9	-4.87	1.593	.3	-4.86	15
20	1.247	0.4	-4.49	1.258	.4	-4.72	1.258	.1	-4.71	20
25	1.0000	0.0	-4.40	1.0000	0.0	-4.57	1.0000	0.0	-4.57	25
30	.8072	0.4	-4.21	.8004	.4	-4.44	.8004	.1	-4.44	30
35	.6558	0.8	-4.08	.6448	.8	-4.31	.6446	.3	-4.31	35
40	.5361	1.2	-3.96	.5228	1.3	-4.18	.5224	.4	-4.19	40
45	.4409	1.7	-3.84	.4264	1.8	-4.06	.4258	.6	-4.07	45
50	.3647	2.2	-3.72	.3497	2.3	-3.94	.3491	.8	-3.96	50
55	.3033	2.8	-3.61	.2885	2.9	-3.83	.2877	1.0	-3.85	55
60	.2535	3.4	-3.51	.2392	3.5	-3.72	.2383	1.2	-3.74	60
65	.2130	4.0	-3.41	.1994	4.1	-3.62	.1984	1.4	-3.64	65
70	.1798	4.6	-3.31	.1671	4.8	-3.52	.1660	1.6	-3.55	70
75	.1525	5.2	-3.22	.1406	5.5	-3.42	.1396	1.8	-3.45	75
80	.1299	5.9	-3.13	.1189	6.2	-3.33	.1178	2.1	-3.36	80
85	.1112	6.6	-3.05	.1010	6.9	-3.24	.09991	2.3	-3.28	85
90	.09551	7.3	-2.97	.08617	7.6	-3.16	.08507	2.5	-3.20	90
95	.08238	8.0	-2.89	.07381	8.3	-3.07	.07273	2.8	-3.12	95
100	.07132	8.7	-2.81	.06347	9.1	-2.99	.06241	3.0	-3.04	100
105	.06198	9.4	-2.74	.05480	9.8	-2.92	.05376	3.3	-2.96	105
110	.05405	10.1	-2.67	.04148	10.6	-2.84	.04648	3.5	-2.89	110
115	.04730	10.9	-2.60	.04129	11.3	-2.77	.04032	3.8	-2.82	115
120	.04153	11.6	-2.54	.03603	12.1	-2.70	.03510	4.1	-2.76	120
125	.03657	12.3	-2.48	.03155	12.9	-2.64	.03065	4.3	-2.69	125
130	.03231	13.1	-2.42	.02771	13.7	-2.57	.02685	4.6	-2.63	130
135	.02863	13.8	-2.36	.02442	14.4	-2.51	.02359	4.8	-2.57	135
140	.02544	14.6	-2.30	.02158	15.2	-2.45	.02079	5.1	-2.51	140
145	.02267	15.3	-2.25	.01913	16.0	-2.39	.01838	5.4	-2.45	145
150	.02025	16.1	-2.20	.01700	16.8	-2.34	.01629	5.6	-2.40	150



Tables of Resistance vs Temperature



T (°C)	Material code B (K)									T (°C)
	NC 4080			NE 4100			N5			
	R (T) / R25	TF (%)	α (%/°C)	R (T) / R25	TF (%)	α (%/°C)	R (T) / R25	TF (%)	α (%/°C)	
-55	105.44	24.0	-7.5	97.27	24.1	-7.2	115.8	16.3	-7.83	-55
-50	72.89	20.7	-7.2	67.99	20.8	-7.0	79.70	14.1	-7.56	-50
-45	51.04	17.8	-7.0	48.08	17.9	-6.8	55.53	12.1	-7.30	-45
-40	36.18	15.2	-6.7	34.39	15.3	-6.5	39.14	10.4	-7.06	-40
-35	25.94	12.9	-6.5	24.85	13.0	-6.3	27.90	8.8	-6.82	-35
-30	18.81	10.9	-6.3	18.15	11.0	-6.1	20.11	7.4	-6.60	-30
-25	13.78	9.1	-6.1	13.38	9.2	-6.0	14.64	6.2	-6.38	-25
-20	10.20	7.5	-5.9	9.96	7.6	-5.8	10.77	5.1	-6.17	-20
-15	7.621	6.1	-5.7	7.479	6.2	-5.6	7.995	4.2	-5.97	-15
-10	5.748	4.9	-5.5	5.664	4.9	-5.4	5.991	3.3	-5.78	-10
-5	4.373	3.8	-5.4	4.325	3.8	-5.3	4.529	2.6	-5.60	-5
0	3.355	2.9	-5.2	3.328	2.9	-5.1	3.453	2.0	-5.43	0
5	2.595	2.1	-5.0	2.581	2.1	-5.0	2.655	1.4	-5.26	5
10	2.023	1.4	-4.9	2.016	1.4	-4.9	2.057	1.0	-5.10	10
15	1.588	0.9	-4.7	1.585	0.9	-4.7	1.606	.6	-4.95	15
20	1.256	0.4	-4.6	1.255	0.4	-4.6	1.263	.3	-4.80	20
25	1.0000	0.0	-4.5	1.0000	0.0	-4.5	1.0000	0.0	-4.65	25
30	.8014	0.4	-4.4	.8017	0.4	-4.3	.7973	.3	-4.52	30
35	.6463	0.8	-4.2	.6466	0.8	-4.2	.6398	.5	-4.39	35
40	.5243	1.3	-4.1	.5245	1.3	-4.1	.5167	.9	-4.26	40
45	.4278	1.8	-4.0	.4278	1.8	-4.0	.4198	1.2	-4.14	45
50	.3510	2.3	-3.9	.3508	2.3	-3.9	.3430	1.6	-4.02	50
55	.2896	2.9	-3.8	.2891	2.9	-3.8	.2819	2.0	-3.91	55
60	.2401	3.5	-3.7	.2394	3.5	-3.7	.2329	2.4	-3.80	60
65	.2001	4.1	-3.6	.1992	4.2	-3.6	.1934	2.8	-3.69	65
70	.1675	4.8	-3.5	.1666	4.8	-3.5	.1615	3.3	-3.59	70
75	.1409	5.5	-3.4	.1399	5.5	-3.4	.1354	3.7	-3.50	75
80	.1190	6.2	-3.3	.11794	6.2	-3.4	.1141	4.2	-3.40	80
85	.1010	6.9	-3.2	.09987	6.9	-3.3	.09660	4.7	-3.31	85
90	.08605	7.6	-3.2	.08491	7.6	-3.2	.08212	5.2	-3.23	90
95	.07360	8.3	-3.1	.07246	8.4	-3.1	.07011	5.7	-3.14	95
100	.06319	9.1	-3.0	.06207	9.1	-3.1	.06010	6.2	-3.06	100
105	.05446	9.8	-2.9	.05336	9.9	-3.0	.05172	6.7	-2.98	105
110	.04710	10.6	-2.9	.04604	10.6	-2.9	.04467	7.2	-2.91	110
115	.04087	11.3	-2.8	.03985	11.4	-2.8	.03873	7.7	-2.83	115
120	.03559	12.1	-2.7	.03461	12.2	-2.8	.03370	8.2	-2.76	120
125	.03109	12.9	-2.7	.03015	12.9	-2.7	.02942	8.8	-2.70	125
130	.02724	13.7	-2.6	.02635	13.7	-2.7	.02576	9.3	-2.63	130
135	.02394	14.4	-2.5	.02309	14.5	-2.6	.02264	9.8	-2.57	135
140	.02111	15.2	-2.5	.02030	15.3	-2.5	.01995	10.3	-2.51	140
145	.01866	16.0	-2.4	.01789	16.1	-2.5	.01764	10.9	-2.45	145
150	.01654	16.8	-2.4	.01581	16.8	-2.4	.01564	11.4	-2.39	150

T (°C)	Material code B (K)									T (°C)
	P 4220			PA 4235			Q 4300			
	R (T) / R25	TF (%)	α (%/°C)	R (T) / R25	TF (%)	α (%/°C)	R (T) / R25	TF (%)	α (%/°C)	
-55	121.3	24.8	-7.88	23.3	8.3	-8.00	98.02	25.5	-7.14	-55
-50	83.32	21.4	-7.61	84.31	7.2	-7.71	69.51	22.0	-6.95	-50
-45	57.91	18.4	-7.36	58.37	6.2	-7.43	49.72	18.9	-6.77	-45
-40	40.71	15.8	-7.11	40.92	5.3	-7.17	35.86	16.2	-6.59	-40
-35	28.95	13.4	-6.88	29.03	4.5	-6.92	26.08	13.7	-6.42	-35
-30	20.80	11.3	-6.66	20.83	3.8	-6.69	19.12	11.6	-6.26	-30
-25	15.10	9.4	-6.44	15.10	3.2	-6.46	14.12	9.7	-6.10	-25
-20	11.07	7.8	-6.24	11.07	2.6	-6.25	10.51	8.0	-5.94	-20
-15	8.196	6.3	-6.04	8.189	2.1	-6.05	7.876	6.5	-5.79	-15
-10	6.123	5.1	-5.85	6.117	1.7	-5.85	5.946	5.2	-5.64	-10
-5	4.615	4.0	-5.67	4.610	1.3	-5.67	4.520	4.1	-5.50	-5
0	3.507	3.0	-5.49	3.504	1.0	-5.49	3.460	3.1	-5.36	0
5	2.688	2.2	-5.33	2.686	.7	-5.32	2.666	2.2	-5.23	5
10	2.078	1.5	-5.16	2.075	.5	-5.16	2.067	1.5	-5.09	10
15	1.616	.9	-5.01	1.615	.3	-5.01	1.613	.9	-4.96	15
20	1.267	.4	-4.86	1.266	.1	-4.86	1.266	.4	-4.84	20
25	1.0000	0.0	-4.72	1.0000	0.0	-4.72	1.0000	0.0	-4.72	25
30	.7949	.4	-4.58	.7949	.1	-4.58	.7944	.4	-4.60	30
35	.6360	.8	-4.45	.6359	.3	-4.45	.6347	.8	-4.48	35
40	.5120	1.3	-4.32	.5119	.4	-4.32	.5099	1.3	-4.37	40
45	.4148	1.8	-4.20	.4145	.6	-4.20	.4119	1.9	-4.26	45
50	.3380	2.4	-4.06	.3376	.8	-4.09	.3345	2.5	-4.15	50
55	.2769	3.0	-3.96	.2765	1.0	-3.98	.2730	3.1	-4.05	55
60	.2282	3.6	-3.86	.2276	1.2	-3.87	.2239	3.7	-3.95	60
65	.1890	4.3	-3.75	.1883	1.4	-3.77	.1846	4.4	-3.85	65
70	.1573	5.0	-3.65	.1566	1.7	-3.67	.1529	5.1	-3.75	70
75	.1316	5.7	-3.55	.1308	1.9	-3.58	.1272	5.8	-3.66	75
80	.1106	6.4	-3.45	.1098	2.1	-3.48	.1063	6.5	-3.57	80
85	.09338	7.1	-3.36	.09258	2.4	-3.40	.08928	7.3	-3.48	85
90	.07919	7.9	-3.28	.07838	2.6	-3.31	.07527	8.1	-3.39	90
95	.06744	8.6	-3.19	.06662	2.9	-3.23	.06373	8.8	-3.31	95
100	.05767	9.4	-3.11	.05686	3.1	-3.15	.05417	9.6	-3.23	100
105	.04951	10.2	-3.03	.04871	3.4	-3.07	.04623	10.4	-3.15	105
110	.04267	10.9	-2.95	.04189	3.7	-3.00	.03961	11.2	-3.07	110
115	.03691	11.7	-2.88	.03614	3.9	-2.93	.03405	12.0	-3.00	115
120	.03204	12.5	-2.81	.03130	4.2	-2.86	.02939	12.9	-2.93	120
125	.02791	13.3	-2.74	.02719	4.5	-2.79	.02545	13.7	-2.86	125
130	.02440	14.1	-2.67	.02370	4.7	-2.73	.02211	14.5	-2.79	130
135	.02139	14.9	-2.61	.02072	5.0	-2.67	.01928	15.3	-2.72	135
140	.01882	15.7	-2.55	.01817	5.3	-2.61	.01686	16.1	-2.66	140
145	.01660	16.5	-2.49	.01598	5.5	-2.55	.01479	17.0	-2.60	145
150	.01469	17.3	-2.43	.01410	5.8	-2.49	.01302	17.8	-2.54	150



Tables of Resistance vs Temperature



T (°C)	Material code B (K)									T (°C)
	QA 4250			R 4400			RA 4380			
	R (T) / R25	TF (%)	α (%/°C)	R (T) / R25	TF (%)	α (%/°C)	R (T) / R25	TF (%)	α (%/°C)	
-55	1101.8	8.3	-7.36	113.9	25.9	-7.42	110.7	8.6	-7.53	-55
-50	71.33	7.2	-7.13	79.69	22.4	-7.22	77.22	7.4	-7.29	-50
-45	50.51	6.2	-6.91	56.29	19.2	-7.03	54.43	6.4	-7.07	-45
-40	36.14	5.3	-6.70	40.12	16.4	-6.84	38.76	5.5	-6.85	-40
-35	26.11	4.5	-6.50	28.85	14.0	-6.66	27.86	4.6	-6.65	-35
-30	19.05	3.8	-6.31	20.92	11.8	-6.48	20.22	3.9	-6.46	-30
-25	14.02	3.2	-6.12	15.29	9.8	-6.31	14.81	3.3	-6.27	-25
-20	10.41	2.6	-5.85	11.27	8.1	-6.14	10.94	2.7	-6.09	-20
-15	7.791	2.1	-5.78	8.367	6.6	-5.98	8.143	2.2	-5.92	-15
-10	5.879	1.7	-5.62	6.260	5.3	-5.83	6.112	1.8	-5.76	-10
-5	4.470	1.3	-5.46	4.719	4.1	-5.67	4.622	1.4	-5.60	-5
0	3.424	1.0	-5.31	3.583	3.1	-5.53	3.522	1.0	-5.45	0
5	2.642	.7	-5.17	2.739	2.3	-5.38	2.702	.8	-5.31	5
10	2.052	.5	-5.03	2.108	1.5	-5.24	2.087	.5	-5.17	10
15	1.605	.3	-4.90	1.634	.9	-5.11	1.623	.3	-5.03	15
20	1.263	.1	-4.77	1.274	.4	-4.97	1.270	.1	-4.91	20
25	1.0000	0.0	-4.65	1.0000	0.0	-4.84	1.0000	0.0	-4.78	25
30	.7965	.1	-4.53	.7897	.4	-4.72	.7920	.1	-4.66	30
35	.6380	.3	-4.42	.6273	.9	-4.60	.6308	.3	-4.55	35
40	.5139	.4	-4.31	.5012	1.4	-4.48	.5052	.5	-4.43	40
45	.4162	.6	-4.20	.4026	1.9	-4.36	.4068	.6	-4.33	45
50	.3388	.8	-4.10	.3255	2.5	-4.25	.3292	.8	-4.22	50
55	.2771	1.0	-4.00	.2644	3.1	-4.14	.2678	1.0	-4.12	55
60	.2278	1.2	-3.90	.2159	3.8	-4.04	.2189	1.3	-4.02	60
65	.1881	1.4	-3.81	.1772	4.5	-3.93	.1797	1.5	-3.93	65
70	.1560	1.7	-3.72	.1462	5.2	-3.83	.1483	1.7	-3.84	70
75	.1300	1.9	-3.63	.1212	5.9	-3.74	.1228	2.0	-3.75	75
80	.1088	2.1	-3.55	.1009	6.7	-3.64	.1022	2.2	-3.67	80
85	.0914	2.4	-3.47	.08441	7.4	-3.55	.08537	2.5	-3.58	85
90	.07708	2.6	-3.39	.07093	8.2	-3.46	.07160	2.7	-3.50	90
95	.06527	2.9	-3.31	.05985	9.0	-3.38	.06029	3.0	-3.42	95
100	.05547	3.2	-3.24	.05072	9.8	-3.29	.05095	3.2	-3.35	100
105	.04731	3.4	-3.17	.04315	10.6	-3.21	.04322	3.5	-3.28	105
110	.04049	3.7	-3.10	.03686	11.4	-3.13	.03679	3.8	-3.21	110
115	.03160	12.2	-3.06	.03478	3.9	-3.03	.03143	4.1	-3.14	115
120	.02996	4.2	-2.96	.02720	13.1	-2.98	.02693	4.3	-3.07	120
125	.02590	4.5	-2.90	.02349	13.9	-2.91	.02316	4.6	-3.01	125
130	.02246	4.7	-2.84	.02036	14.7	-2.84	.01997	4.9	-2.94	130
135	.01953	5.0	-2.78	.01771	15.6	-2.77	.01728	5.2	-2.88	135
140	.01704	5.3	-2.72	.01545	16.4	-2.71	.01499	5.4	-2.82	140
145	.01490	5.5	-2.67	.01353	17.2	-2.64	.01305	5.7	-2.77	145
150	.01307	5.8	-2.61	.01188	18.1	-2.58	.01138	6.0	-2.71	150

T (°C)	Material code B (K)									T (°C)
	RC 4340			S 4520			SC 4500			
	R (T) / R25	TF (%)	α (%/°C)	R (T) / R25	TF (%)	α (%/°C)	R (T) / R25	TF (%)	α (%/°C)	
-55	105.68	25.5	-7.2	126.1	26.6	-7.55	129.77	26.5	-7.5	-55
-50	74.01	22.1	-6.9	87.73	23.0	-7.35	89.31	22.9	-7.3	-50
-45	52.37	19.0	-6.7	61.59	19.8	-7.16	62.15	19.7	-7.1	-45
-40	37.43	16.2	-6.6	43.62	16.9	-6.97	43.72	16.8	-6.9	-40
-35	27.01	13.8	-6.4	31.17	14.3	-6.79	31.07	14.3	-6.7	-35
-30	19.66	11.6	-6.2	22.45	12.1	-6.62	22.29	12.0	-6.5	-30
-25	14.44	9.7	-6.0	16.31	10.1	-6.45	16.15	10.0	-6.3	-25
-20	10.70	8.0	-5.9	11.94	8.3	-6.28	11.80	8.3	-6.1	-20
-15	7.990	6.5	-5.7	8.808	6.8	-6.12	8.703	6.8	-6.0	-15
-10	6.013	5.2	-5.6	6.548	5.4	-5.96	6.470	5.4	-5.8	-10
-5	4.559	4.1	-5.4	4.904	4.2	-5.81	4.849	4.2	-5.7	-5
0	3.482	3.1	-5.3	3.699	3.2	-5.66	3.662	3.2	-5.5	0
5	2.678	2.2	-5.2	2.810	2.3	-5.52	2.786	2.3	-5.4	5
10	2.074	1.5	-5.0	2.149	1.6	-5.38	2.135	1.6	-5.2	10
15	1.616	0.9	-4.9	1.654	1.0	-5.24	1.647	0.9	-5.1	15
20	1.267	0.4	-4.8	1.282	.4	-5.10	1.279	0.4	-5.0	20
25	1.0000	0.0	-4.7	1.0000	0.0	-4.97	1.0000	0.0	-4.8	25
30	.7936	0.4	-4.5	.7848	.4	-4.85	.7865	0.4	-4.7	30
35	.6334	0.8	-4.4	.6196	.9	-4.72	.6223	0.9	-4.6	35
40	.5083	1.3	-4.3	.4922	1.4	-4.60	.4953	1.4	-4.5	40
45	.4100	1.9	-4.2	.3932	2.0	-4.48	.3963	2.0	-4.4	45
50	.3325	2.5	-4.1	.3158	2.6	-4.37	.3189	2.6	-4.3	50
55	.2709	3.1	-4.0	.2551	3.2	-4.26	.2579	3.2	-4.2	55
60	.2218	3.7	-3.9	.2072	3.9	-4.15	.2096	3.9	-4.1	60
65	.1825	4.4	-3.8	.1691	4.6	-4.05	.1712	4.6	-4.0	65
70	.1508	5.1	-3.8	.1387	5.3	-3.94	.1405	5.3	-3.9	70
75	.1251	5.8	-3.7	.1144	6.1	-3.84	.1159	6.0	-3.8	75
80	.1043	6.6	-3.6	.09477	6.8	-3.75	.09595	6.8	-3.7	80
85	.08727	7.3	-3.5	.07888	7.6	-3.65	.07980	7.6	-3.6	85
90	.07332	8.1	-3.4	.06595	8.4	-3.56	.06664	8.4	-3.6	90
95	.06184	8.9	-3.4	.05539	9.2	-3.47	.05588	9.2	-3.5	95
100	.05235	9.7	-3.3	.04671	10.1	-3.39	.04704	10.0	-3.4	100
105	.04448	10.5	-3.2	.03956	10.9	-3.30	.03975	10.8	-3.3	105
110	.03793	11.3	-3.1	.03364	11.7	-3.22	.03371	11.7	-3.3	110
115	.03245	12.1	-3.1	.02872	12.6	-3.14	.02869	12.5	-3.2	115
120	.02785	12.9	-3.0	.02461	13.4	-3.07	.02450	13.4	-3.1	120
125	.02399	13.7	-3.0	.02117	14.3	-2.99	.02100	14.2	-3.0	125
130	.02072	14.5	-2.9	.01828	15.1	-2.92	.01805	15.1	-3.0	130
135	.01796	15.4	-2.8	.01584	16.0	-2.85	.01557	15.9	-2.9	135
140	.01561	16.2	-2.8	.01376	16.8	-2.78	.01347	16.8	-2.9	140
145	.01360	17.0	-2.7	.01201	17.7	-2.72	.01169	17.6	-2.8	145
150	.01189	17.8	-2.7	.01050	18.6	-2.65	.01017	18.5	-2.7	150



Tables of Resistance vs Temperature

T (°C)	Material code B (K)						T (°C)
	T 4630			U 4840			
	R (T) / R25	TF (%)	α (%/°C)	R (T) / R25	TF (%)	α (%/°C)	
-55	137.0	27.2	-7.64	173.7	28.5	-8.04	-55
-50	94.92	23.5	-7.45	118.2	24.6	-7.83	-50
-45	66.34	20.2	-7.26	81.16	21.2	-7.63	-45
-40	46.77	17.3	-7.09	56.25	18.1	-7.44	-40
-35	33.25	14.7	-6.90	39.33	15.4	-7.25	-35
-30	23.83	12.4	-6.72	27.74	12.9	-7.07	-30
-25	17.22	10.3	-6.56	19.73	10.8	-6.89	-25
-20	12.54	8.5	-6.39	14.15	8.9	-6.71	-20
-15	9.205	6.9	-6.23	10.23	7.3	-6.54	-15
-10	6.806	5.6	-6.08	7.456	5.8	-6.38	-10
-5	5.069	4.3	-5.92	5.475	4.5	-6.22	-5
0	3.803	3.3	-5.78	4.051	3.4	-6.06	0
5	2.873	2.4	-5.63	3.019	2.5	-5.91	5
10	2.185	1.6	-5.49	2.267	1.7	-5.76	10
15	1.673	1.0	-5.35	1.714	1.0	-5.61	15
20	1.289	.4	-5.22	1.305	.5	-5.47	20
25	1.0000	0.0	-5.09	1.0000	0.0	-5.33	25
30	.7805	.4	-4.96	.7715	.4	-5.20	30
35	.6129	.9	-4.83	.5991	.9	-5.06	35
40	.4842	1.4	-4.71	.4681	1.5	-4.94	40
45	.3847	2.0	-4.59	.3681	2.1	-4.81	45
50	.3074	2.6	-4.48	.2911	2.8	-4.69	50
55	.2470	3.3	-4.37	.2316	3.4	-4.57	55
60	.1996	4.0	-4.26	.1853	4.2	-4.45	60
65	.1621	4.7	-4.15	.1491	4.9	-4.34	65
70	.1323	5.4	-4.04	.1207	5.7	-4.23	70
75	.1086	6.2	-3.94	.09813	6.5	-4.12	75
80	.08953	7.0	-3.84	.08023	7.3	-4.02	80
85	.07417	7.8	-3.75	.06592	8.2	-3.91	85
90	.06173	8.6	-3.65	.05443	9.0	-3.82	90
95	.05161	9.5	-3.56	.04515	9.9	-3.72	95
100	.04334	10.3	-3.47	.03763	10.8	-3.63	100
105	.03655	11.2	-3.39	.03151	11.7	-3.54	105
110	.03095	12.0	-3.31	.02650	12.6	-3.45	110
115	.02632	12.9	-3.22	.02237	13.5	-3.38	115
120	.02247	13.7	-3.15	.01897	14.4	-3.28	120
125	.01925	14.6	-3.07	.01615	15.3	-3.20	125
130	.01656	15.5	-2.99	.01381	16.2	-3.12	130
135	.01429	16.4	-2.92	.01185	17.1	-3.04	135
140	.01238	17.3	-2.85	.01020	18.0	-2.97	140
145	.01076	18.1	-2.78	.00882	19.0	-2.90	145
150	.00938	19.0	-2.72	.00765	19.9	-2.83	150

Identification – Traceability



On the packaging of all shipped thermistors, you will find a bar code label. This label gives systematic information on the type of product, part number, lot number, manufacturing date and quantity. An example is given below:

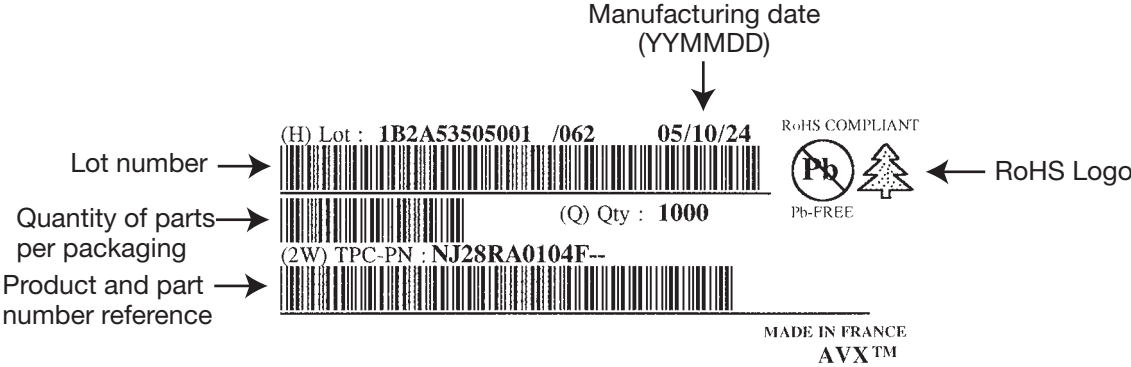

This information allows complete traceability of the entire manufacturing process, from raw materials to final inspection. This is extremely useful for any information request, customer complaint or product return.

RoHS/ELV Compliance



By Product Family

RoHS (Restriction of Hazardous Substances - European Union directive 2002/95/EC).

ELV (End of Life-Vehicle - European Union directive 2000/53/EC).

All Thermistor Products have been fully RoHS/ELV since before 2006.

Chip Thermistor NB RoHS/ELV Status: external Plating 100% smooth semi-bright Sn as standard SnPb Termination available on request.

Products that are supplied AS STANDARD in RoHS/ELV compliant form for listed

Industrial Product Family		RoHS Compliant for Material Listed					
Group	Series	Cadmium	Hexavalent Chromium	Lead	Mercury	PBBs	PBDEs
Leaded NTC Thermistors	Thermistors NF NI	✓	✓	✓	✓	✓	✓
	Thermistors ND NJ NP	✓	✓	✓	✓	✓	✓
SMD Thermistors	Thermistors NC	✓	✓	✓	✓	✓	✓
	Thermistors NB	✓	✓	✓	✓	✓	✓



Circuit Protection Portfolio



Application Guide

	AVX PRODUCTS																	
	Fast Blow SMT Fuse (Surface Mount Fuse)	SMT Broadband LCT Filter (Feedthru)	SMT Broadband LCT Filter Array (Feedthru Array)	SMT Bidirectional Transient Voltage Suppressors & EMI Filters (TransGuard)	SMT Bidirectional Transient Voltage Suppressors & EMI Filters (MultiGuard)	Low Capacitance SMT Bidirectional Transient Voltage Suppressors & EMI Filters (StaticGuard)	Low Capacitance Bidirectional Transient Voltage Suppressors (AntennaGuard)	Bidirectional Transient Voltage Suppressors for Low Speed CAN Networks (CAN BUS Series)	Bidirectional Transient Voltage Suppressors for USB Applications (USB Series)	Bidirectional Transient Voltage Suppressors for Low Leakage CMOS Applications (UltraGuard)	Bidirectional Transient Voltage Suppressors for High Energy Transients (Medium Power MLY)	Bidirectional Transient Voltage Suppressors for Jump Start Auto Applications (Medium Power Automotive Series)	Leaded Negative Temperature Coefficient Thermistors	SMT Negative Temperature Coefficient Thermistors	General Purpose Radial Leaded Power MOV (Metal Oxide Varistors)			
APPLICATIONS																		
ESD						X		X	X	X								
In Rush Current Limit																X	X	
Long Wave Transient				X	X		X				X	X	X					X
EMI Filtering	X	X	X															
EMI Filtering + Transient				X	X	X	X	X	X	X	X	X	X					
Load Dump				X								X						
Automotive	X		X	X	X	X	X	X	X			X			X	X		
Mil Std 461-E				X														
ISO 7637				X									X					
IEC 61000				X	X	X	X	X	X	X	X							X
Telecom Protection				X									X					
Over Current Protection	X																	
Diode Replacement				X	X	X			X	X	X	X						
Zener Replacement				X	X	X			X	X	X	X						
Military A-A-55682				X														
Radiation Resistance				X	X													
Industrial	X		X	X	X	X	X		X	X		X			X			X
UL 1449																		X
UL 1414																		X
Medical (EN 60601)	X			X														
High Speed Data Line Protection									X		X							
Optic Transceiver Protection									X		X							
Temperature Sensing															X	X		
Low Leakage Circuit												X						
DATA																		
Data Sheet	X	X	X	X	X	X	X	X	X	X	X	X	X	X	X	X	X	X
Application Notes		X	X	X	X	X		X	X	X		X			X	X	X	X
Reliability Data		X			X													
Distributed Element Model				X	X	X	X	X	X	X	X	X						
Frequency Response		X	X	X	X	X	X	X	X	X		X						



Terminology Guide

Fast Blow SMT Fuse (Surface Mount Fuse)

High accuracy, fast blow, surface mount fuses. Case sizes: 0402, 0603, 0805, 1206, 0612. Current ratings 250 mA to 5 Amps.

SMT Broadband LCT Filter (Feedthru)

Miniature surface mount broadband LC T configuration EMI filters. FeedThru current ratings to 300 mA.

SMT Broadband LCT Filter Array (Feedthru Array)

Miniature surface mount broadband 4 element LC T configuration EMI filter arrays. FeedThru current ratings of 300 mA.

SMT High Current Broadband LCT Filter (High Current Feedthru)

High current, surface mount, broadband LC T configuration filters. Feedthru currents up to 5 Amps.

SMT Bidirectional Transient Voltage Suppressors & EMI Filters (TransGuard)

Miniature surface mount, bidirectional transient voltage suppressor. Steady state operating voltages of 3.3 volts to 60 volts. Case sizes: 0402, 0603, 0805, 1206, 1210, 1812, 2220.

SMT Bidirectional Transient Voltage Suppressors & EMI Filter Arrays (MultiGuard)

Miniature surface mount bidirectional transient voltage suppressor 2 or 4 element arrays. Steady state operating voltages of 5.6 volts to 18 volts. Case sizes: 0405, 0508, 0612.

Low Capacitance SMT Bidirectional Transient Voltage Suppressors & EMI Filters (StaticGuard)

Bidirectional transient voltage suppressor intended for low leakage CMOS based IC protection. Can be operated at voltages up to 18V. Case sizes: 0402, 0405, 0508, 0603, 0612, 0805, 1206.

SMT Bidirectional LCT Transient Voltage Suppressor Filters (TransFeed)

Miniature bidirectional transient voltage suppressor filter LC T configuration. Relatively narrow band, high attenuation filter. Discrete filter in 0508 package, 4 element array filter in 0612 package.

Low Capacitance Bidirectional Transient Voltage Suppressors (AntennaGuard)

Low capacitance, bidirectional transient voltage suppressor intended for high speed or high frequency applications. Available in 0402 and 0603 case sizes. Capacitance values of 3 pF and 12 pF available.

Bidirectional Transient Voltage Suppressors for Low, Medium & High Speed CAN Networks (CAN BUS Series)

Bidirectional transient voltage suppressor intended for high speed and slow speed CAN circuitry. Available configurations: 0603 discrete, 0405 two element array, 0612 four element array.

Bidirectional Transient Voltage Suppressors for USB Applications (USB Series)

Bidirectional transient voltage suppressor intended for Universal Serial Bus applications. Available configurations: 0402 and 0603 discrete; 0405 two element array; 0508 three element array; 0612 four element array.

Bidirectional Transient Voltage Suppressors for Low Leakage CMOS Applications (UltraGuard)

Low leakage, bidirectional transient voltage suppressor intended for CMOS battery powered designs. Steady state operating voltages of 3, 5, 7, 10 and 15 volts (DC). Available configurations: 0402, 0603 and 0805 discrete; 0405 two element array; 0508 and 0612 four element array.

Bidirectional Transient Voltage Suppressors for High Energy Transients (Medium Power MLV)

Medium power, bidirectional transient voltage suppressor. Available in operating voltages of: 18, 26, 30, 48, 60 volts (DC). Case sizes: 1206, 1210, 1812, 2220. Energy ratings 0.9 to 1.5 joules.

Bidirectional Transient Voltage Suppressors for Load Dump & Jump Start Auto Applications (Medium Power Automotive Series)

Medium power, bidirectional transient voltage suppressor. Available in operating voltages of: 16 and 34 volts (DC). Case sizes: 1206, 1210, 1812, 2220. Energy ratings 0.6 to 12 joules. Load dump and jump start rated.

Bidirectional Transient Voltage Suppressors for Telecom Applications (Medium Power MLV for Telecom)

Medium power, bidirectional transient voltage suppressor. Available in operating voltages of: 60 and 90 Vrms in 1812 case size. Energy ratings of 5 and 6 joules. CCITT 10x700µs 2kV capable.

Leaded Negative Temperature Coefficient Thermistors

Negative temperature coefficient thermistors high accuracy NTCs from 2k ohm to 100k ohm, general purpose NTCs from 10 ohms to 1 meg ohm, inrush current limiters from 1 ohm to 120 ohms. Stud mounted NTCs from 10 ohms to 330 k ohms.

SMT Negative Temperature Coefficient Thermistors

Surface mount negative temperature coefficient thermistor in 0402, 0603, 0805 and 1206 case sizes.

General Purpose Radial Leaded Power MOV (Metal Oxide Varistors)

Radial Metal Oxide varistors 11 Vrms to 625 Vrms. Energy ratings to >500 J. Peak current ratings to 10,000 A.

AMERICAS

**AVX Myrtle Beach, SC
Corporate Offices**
Tel: 843-448-9411
FAX: 843-448-1943

AVX Northwest, WA
Tel: 360-699-8746
FAX: 360-699-8751

AVX North Central, IN
Tel: 317-848-7153
FAX: 317-844-9314

AVX Midwest, MN
Tel: 952-974-9155
FAX: 952-974-9179

AVX Mid/Pacific, CA
Tel: 510-661-4100
FAX: 510-661-4101

AVX Southwest, AZ
Tel: 602-678-0384
FAX: 602-678-0385

AVX South Central, TX
Tel: 972-669-1223
FAX: 972-669-2090

AVX Southeast, GA
Tel: 404-608-8151
FAX: 770-972-0766

AVX Canada

Tel: 905-238-3151
FAX: 905-238-0319

AVX South America
Tel: ++55-11-2193-7200
FAX: ++55-11-2193-7210

EUROPE

**AVX Limited, England
European Headquarters**
Tel: ++44 (0) 1252-770000
FAX: ++44 (0) 1252-770001

AVX/ELCO, England
Tel: ++44 (0) 1638-675000
FAX: ++44 (0) 1638-675002

AVX S.A., France
Tel: ++33 (1) 69-18-46-00
FAX: ++33 (1) 69-28-73-87

AVX GmbH, Germany
Tel: ++49 (0) 8131-9004-0
FAX: ++49 (0) 8131-9004-44

AVX srl, Italy

Tel: ++390 (0)2 614-571
FAX: ++390 (0)2 614-2576

AVX Czech Republic
Tel: ++420 465-358-111
FAX: ++420 465-323-010

ASIA-PACIFIC

**AVX/Kyocera, Singapore
Asia-Pacific Headquarters**
Tel: (65) 6286-7555
FAX: (65) 6488-9880

AVX/Kyocera, Hong Kong
Tel: (852) 2-363-3303
FAX: (852) 2-765-8185

AVX/Kyocera, Korea
Tel: (82) 2-785-6504
FAX: (82) 2-784-5411

AVX/Kyocera, Taiwan
Tel: (886) 2-2698-8778
FAX: (886) 2-2698-8777

AVX/Kyocera, Malaysia

Tel: (60) 4-228-1190
FAX: (60) 4-228-1196

Elco, Japan

Tel: 045-943-2906/7
FAX: 045-943-2910

Kyocera, Japan - AVX

Tel: (81) 75-604-3426
FAX: (81) 75-604-3425

Kyocera, Japan - KDP

Tel: (81) 75-604-3424
FAX: (81) 75-604-3425

AVX/Kyocera, Shanghai, China

Tel: 86-21 6341 0300
FAX: 86-21 6341 0330

AVX/Kyocera, Beijing, China

Tel: 86-10 8458 3385
Fax: 86-10 8458 3382

ASIA-KED

KED, Hong Kong
Tel: (852) 2305 1080
FAX: (852) 2305 1405

KED, Shanghai
Tel: (86) 21 6859 9898
FAX: (86) 21 5887 2542

KED, Beijing
Tel: (86) 10 5869 4655
FAX: (86) 10 5869 4677

KED, South Korea
Tel: (82) 2 783 3288
FAX: (82) 2 783 3207

KED, Taiwan
Tel: (886) 2 2950 0268
FAX: (886) 2 2950 0520

KED, Singapore
Tel: (65) 6255 3122
FAX: (65) 6255 5092

Contact:

