

BASE AND TRANSPORT PLATE 30X60 M10 CONDUCTIVE

Article Nr. 21.2115/6

[See the product on the website](#) →

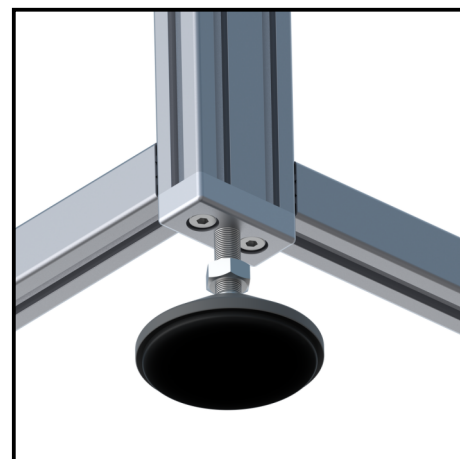
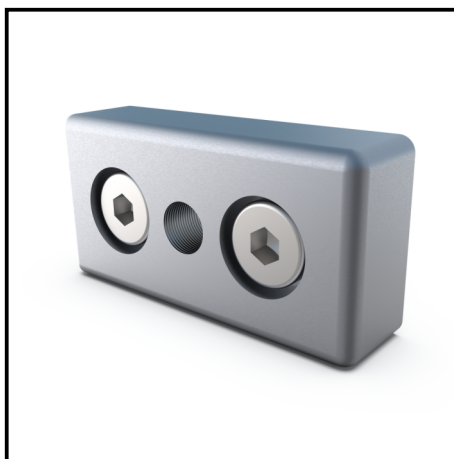
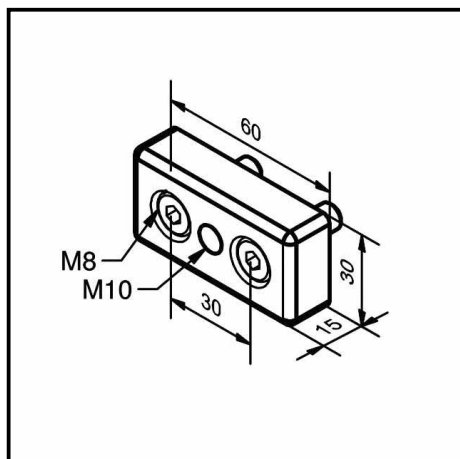

TECHN. DATA / ITEMS SUPPLIED

- Aluminium, Pressure die-casting, blasted
- Fastening kit
- Weight = 0.082 kg/piece

APPLICATIONS

- Fixing of hinged feet and castors
- Appropriate for ESD implementations

ASSEMBLY

- Use fixing material supplied to fix to the end face of the profile