



Brand of NTN Group

Technical data

SUCFL204N

Bearing units



Stainless steel cast housing, stainless steel insert ball bearing with socket set screws, seal with slinger, food grease

KIT CONTENT

SUC204, SFL204N

VISUAL (S)

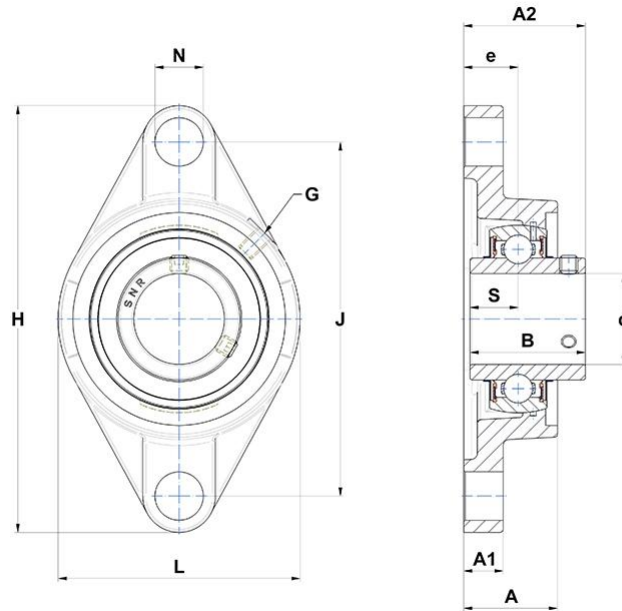

PRODUCT DEFINITION

Brand	SNR
A - Housing height	25,5 mm
A1 - Housing foot height / flange height	12 mm
A2 - Total height from mounting surface	33,3 mm
B - Width of Inner Ring	31 mm



NTN Europe

1 rue des Usines · BP 2017 · 74010 Annecy Cedex · France · Tel. +33 (0)4 50 65 30 00
S.A. au capital de 322 639 919 € · RCS ANNECY B 325 821 072 · Id. Fiscale : FR 48 325 821 072
SIRET 325 821 072 00015 · Code APE 2815 Z · Code NACE 28.15

PRODUCT DEFINITION

d - Shaft diameter	20 mm
e - Distance mounting surface to bearing center	15 mm
G - Grease fitting	M6x1
H - Housing length, width or diameter	112 mm
J - Mounting holes distance	90 mm
L - Housing width / diameter	58,5 mm
N - Mounting hole dimension	12 mm
S - Distance front side/bearing centre	12,7 mm

PRODUCT PERFORMANCE

C - Dynamic load rating	12800000 mN
C0 - Static load rating	6600000 mN
Operating temperature min.	253,15 °K
Operating temperature max.	373,15 °K

OTHER FEATURES

Mass	0,45 kg
Recommended tightening torque for set screw	3.9 N-m

