

**Bourdon tube pressure gauges, liquid filled,**

**Modelcode type: 213.53.0XX**

**Item number: 82500630**

**Description**

Design according	EN 837-1
Accuracy class	class 1.6
Scale range	0...6 bar
2nd Scale or Special Scale	2nd scale MPa

**Constructional design**

Process connection	G 1/4 B
Connector location	lower mount
Pressure element	Copper alloy
Movement	Copper alloy
Case	Crimp ring case (version 53)
Nominal size	050 mm
Case filling fluid	prepared for filling
Pointer	plastic, black
Window	plastic, clear
Dial	Aluminum, white, with stop-pin

**Operating conditions**

Pressure limitation	Steady: 3/4 x full scale value Fluctuating: 2/3 x full scale value Short time: Full scale value
---------------------	---

Permissible ambient temperature -20 ... +60 °C

Permissible medium temperature +60°C maximum

Temperature effect when the temperature deviates from the reference temperature (+20°C) Max. +/-0.4 %/10 K of the span

Ingress protection IP 65

**Dial description:**

Pressure Gauge Standard	China
color for 1.scale (outside)	black

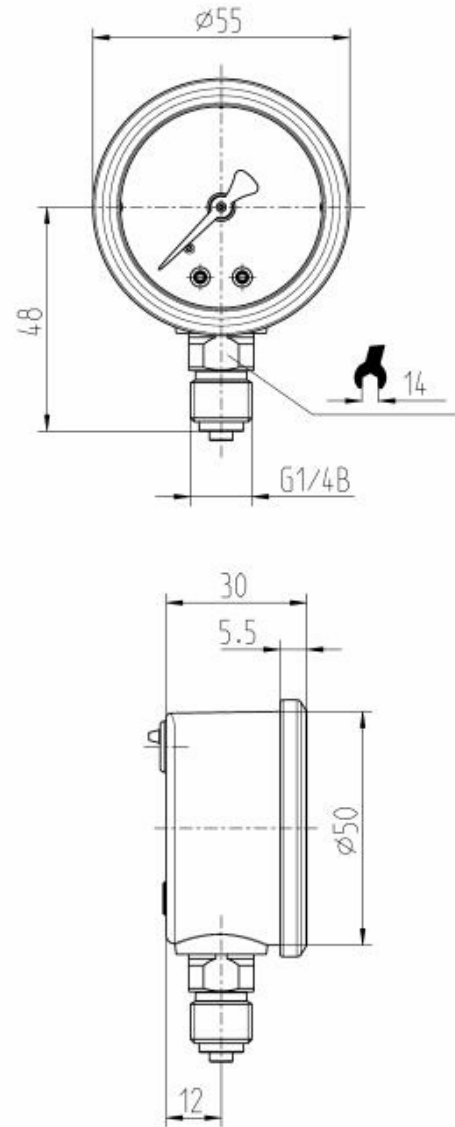

**Bourdon tube pressure gauges, liquid filled,**

**Modelcode type: 213.53.0XX**

**Item number: 82500630**

color for 2.scale (inside)	red RAL 3020
dial background	White
Manufacturer logo	*WIKA*
stop pin on dial	at zero
norm-mark on dial	*EN 837-1*
safetymark on dial	*S*
accuracy class on dial	*Cl.1.6*

Labelcode	
Label	WIKA standard
language of the label	German