



Brand of NTN Group

Technical data

UCF203

Bearing units



Grey cast housing, radial insert ball bearing with socket set screws, seal with slinger

KIT CONTENT

UC203G2, F204

VISUAL (S)

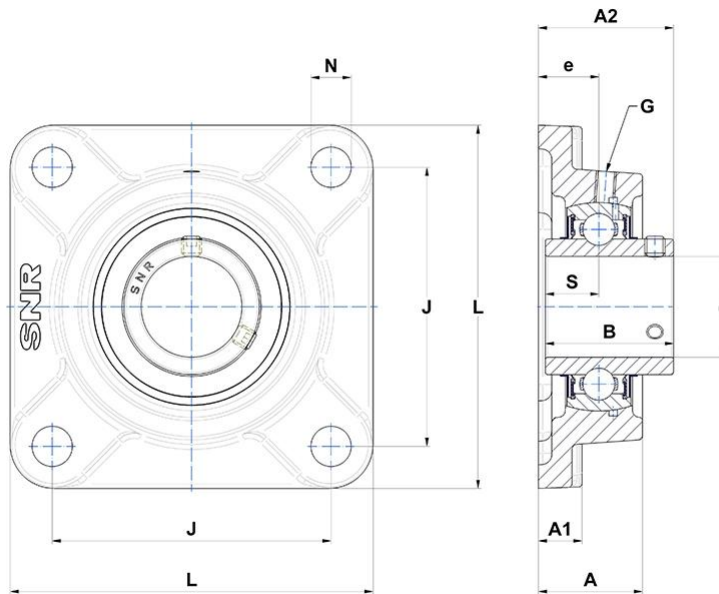

PRODUCT DEFINITION

Brand	SNR
A - Housing height	25,5 mm
A1 - Housing foot height / flange height	11 mm
A2 - Total height from mounting surface	33,3 mm
B - Width of Inner Ring	31 mm
d - Shaft diameter	17 mm



NTN Europe

1 rue des Usines · BP 2017 · 74010 Annecy Cedex · France · Tel. +33 (0)4 50 65 30 00
S.A. au capital de 322 639 919 € · RCS ANNECY B 325 821 072 · Id. Fiscale : FR 48 325 821 072
SIRET 325 821 072 00015 · Code APE 2815 Z · Code NACE 28.15

PRODUCT DEFINITION

e - Distance mounting surface to bearing center	15 mm
G - Grease fitting	M6x1
J - Mounting holes distance	64 mm
L - Housing width / diameter	86 mm
N - Mounting hole dimension	12 mm
S - Distance front side/bearing centre	12,7 mm

PRODUCT PERFORMANCE

C - Dynamic load rating	12800000 mN
C0 - Static load rating	6650000 mN
Operating temperature min.	253,15 °K
Operating temperature max.	373,15 °K

OTHER FEATURES

Mass	0,6 kg
Recommended tightening torque for set screw	5.5 N-m

