

MICRO SWITCH

FREEPORT, ILLINOIS, U.S.A.
A DIVISION OF HONEYWELL

FED. MFG. CODE 91929

SWITCH - TOGGLE

CATALOG LISTING
4TL1 SERIES
CHART 2

THIS DRAWING COVERS A PROPRIETARY ITEM AND IS THE PROPERTY OF MICRO SWITCH, A DIVISION OF HONEYWELL. THIS DRAWING IS NOT TO BE COPIED OR USED WITHOUT THE APPROVAL OF MICRO SWITCH.

CATALOG LISTING
4TL1 SERIES
CHART 2

PAGE 1 OF 1
RELEASE NO. PR-9364

ISSUE
M
31

REVISIONS

A	CO-81150
	J A K 20 JUN 95
B	C092162
	J A K 5 MAR 98
C	CO 94440
	G R T 23 NOV 99

CHECK

CHECK

CHECK

CHECK

CHECK

CHECK

CHECK

CHECK

CHECK

CHECK

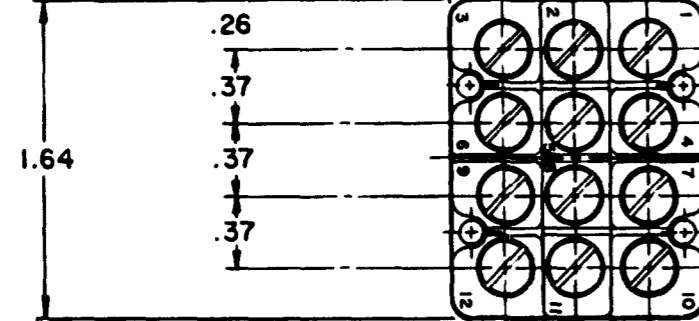
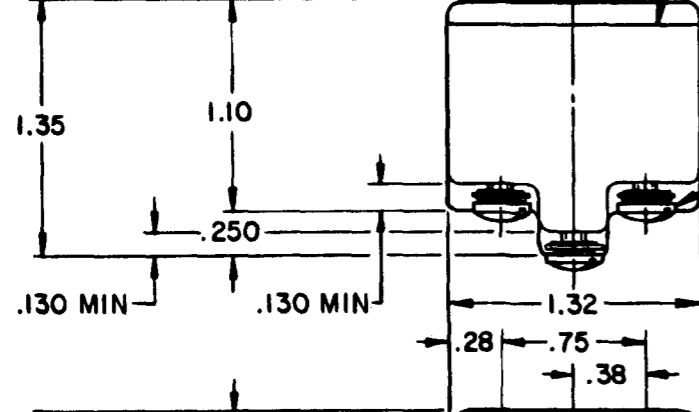
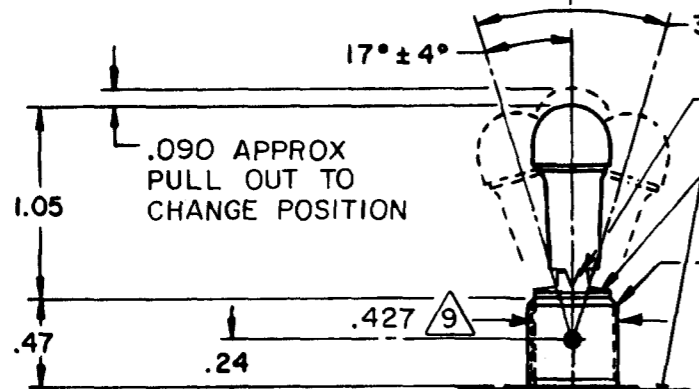
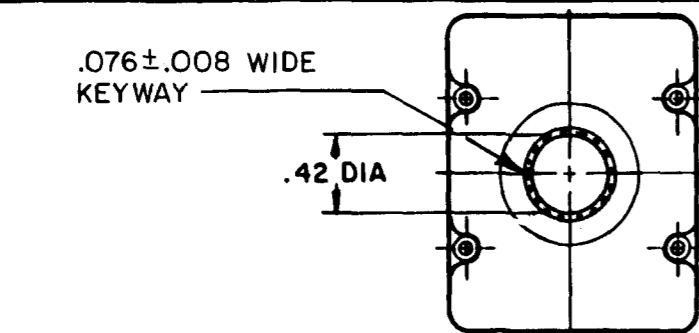

15A-125, 250 OR 277 VAC 1/2HP-125VAC; 1HP-250, 277VAC 5A-125VAC "L" CODE L191		
10A-125, 250, 277 VAC 1/4HP-125VAC; 1/2HP-250, 277VAC 3A-125VAC "L" CODE 192		

MS NUMBER	CATALOG LISTING	AVAILABLE LOCKING COMBINATIONS FOR CONFIGURATION SEE LETTERING DETAILS	CIRCUIT MADE WITH TOGGLE LEVER IN			MILITARY RATING (AMPS)								
			KEYWAY SIDE (1-2, 4-5) (7-8, 10-11)	CENTER (1-2, 4-5) (7-8, 10-11)	OPPOSITE KEYWAY (2-3, 5-6) (8-9, 11-12)	RESISTIVE LOAD DC VOLTS		LAMP LOAD IAC VOLTS		IND. LOAD				
7	7					28	125	250	125	250	28	125	28	125
24660-21	4TL1-1	AB,DE,F,G,H,J,K,L,M,NP	ON	OFF	ON									
24660-22	4TL1-2	D, F, G	OFF	NONE	ON									
24660-23	4TL1-3	D, F, G	ON	NONE	ON	20	.75	.5	15	6	5	4	12	15
24660-24	4TL1-21	E, F, K, M	NONE	OFF	ON	(REFER TO L191 FOR UL RATING)								
24660-33	4TL1-31	E, F, K, M	NONE	ON	ON									
24660-29	4TL1-4	F	MOM OFF	NONE	ON									
24660-31	4TL1-5	E, F, K, L, M, N	MOM ON	OFF	ON									
24660-30	4TL1-6	F	MOM ON	NONE	OFF									
24660-27	4TL1-7	E, L, N	MOM ON	OFF	MOM ON	18	.75	.5	11	6	4	2	10	8
24660-26	4TL1-8	F	MOM ON	NONE	ON	(REFER TO L192 FOR UL RATING)								
24660-32	4TL1-51	E	NONE	ON	MOM ON									
24660-28	4TL1-61	E	MOM ON	OFF	NONE									

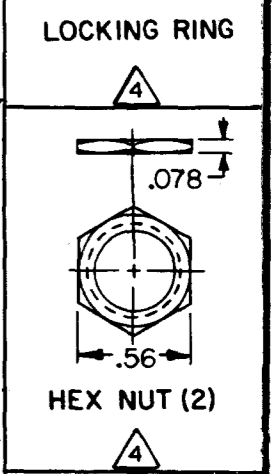
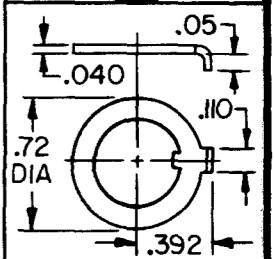
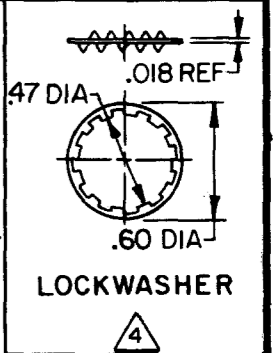
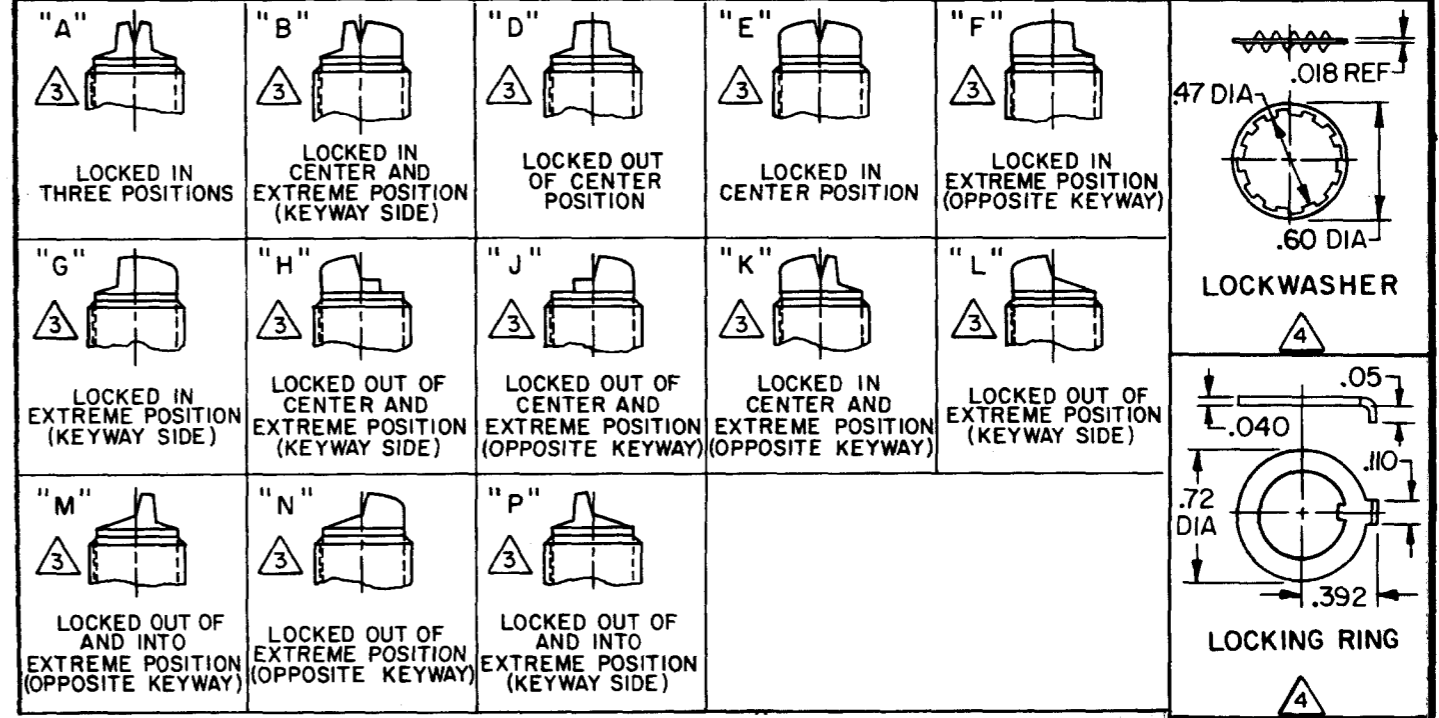

NOTES

- SWITCHES ARE CAPABLE OF WITHSTANDING TEMPERATURE OF 160°F CONTINUOUSLY AT FULL RATED LOAD
- CIRCUIT DESIGNATION, MICRO SWITCH CATALOG LISTING AND MS NUMBER MARKED ON SIDE OF SWITCH
- KEYWAY SHOWN ON LEFT SIDE
- FURNISHED UNASSEMBLED
- THESE SWITCHES ARE QUALIFIED UNDER MIL-S-3950
- FOR TERMINAL COVER SEE MICRO SWITCH CATALOG LISTING 5PA9
- SUFFIX LETTER MUST BE ADDED FOR DESIRED TYPE TOGGLE LOCKING SEE CHART FOR AVAILABLE LOCKING COMBINATIONS
- APPLIES ONLY TO "ON" AND "MOM ON" POSITIONS
- FROM BOTTOM OF KEYWAY TO MAJOR DIAMETER OF 15/32 THREAD

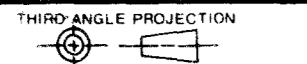

SCALE FULL

DO NOT SCALE PRINT

TOLERANCES

APPLY TO DESIGN UNITS. CONVERSIONS ARE ONLY FOR REFERENCE. UNLESS NOTED, TOLERANCES ARE ±

	DIM.	TOL.	DIM.	TOL.
	mm	mm/in	in	mm/in
NO PLACES	X	17/04	X, X	0.8/03
TWO PLACES	X, X	0.4/015	X, X	0.38/015
THREE PLACES	X, X, X	0.15/006	X, X, X	0.13/005
ANGLES				

DESIGN UNITS SI METRIC US CUSTOMARY

WEIGHT

FORMTEK

DRAWN WJM

7 DEC 82

CHECK

CHECK

CHECK

CHECK

CHECK

CHECK

CHECK

CHECK

CHECK