

Product Highlights

Ultra-Fast Wi-Fi 7 Performance

Wi-Fi 7 delivers up to 9.5 Gbps tri-band performance, while the 10G port ensures high-bandwidth links for devices, servers, and storage.

Flexible Connectivity & Power

Featuring a 10G PoE and 2.5G port, it simplifies cabling and lowers deployment costs for enterprise environments.

Enterprise Design

Ideal for offices, campuses, and high-density areas, with support for multiple SSIDs, VLANs, and advanced security.



DAP-E9560

BE9500 Ceiling Mount Access Point

Key Features

Wi-Fi 7 Technology

- Wi-Fi 7 2x2+2x2+2x2 Tri-Band BE9500 solution
- Double the bandwidth from 160 MHz to 320 MHz
- 4096-QAM modulation boosts data transmission by 20%
- Multi-Link Operation (MLO)

Customisable Captive Portal

- Each SSID have a distinct captive portal page design
- Set up their own login pages for advertising and promotions
- Searchable and auditable event and audit logs
- Front desk ticket management

Central Management

- Nuclias Network Controller helps admins to analyse, automate, configure, optimise, scale, and secure the network
- WI-FI Planner PRO assists in AP deployment for high-performance connectivity across the entire area

Advanced Security

- Latest WPA3 Personal/Enterprise encryption
- Supports 802.1x and MAC/IP ACL
- Establish complete security protection for wireless network

VLAN Per SSID

- Each SSID can have different VLAN tag
- One EAP can serve different group for Users and access control for each group

The DAP-E9560 BE9500 Ceiling Mount Access Point is designed for Small to Medium-sized Businesses (SMBs), enterprises, and educational or hospitality environments that require high-speed, reliable wireless connectivity. It delivers exceptional wireless performance, advanced security, and centralised management features to ensure high availability and efficiency in demanding network environments. Whether serving as part of an enterprise-grade wireless infrastructure or extending coverage in public spaces, the DAP-E9560 delivers the performance, security, and scalability modern networks demand.

Wi-Fi 7 Connectivity

The DAP-E9560 leverages cutting-edge technologies such as Multi-Link Operation (MLO), 320 MHz channel bandwidth, and 4KQAM modulation to enable data transmission across multiple frequency bands simultaneously. These advancements deliver faster speeds, lower latency, and greater network capacity, making Wi-Fi 7 ideal for high-performance, future-ready networks. Whether supporting bandwidth-intensive applications like cloud gaming, real-time collaboration, or AR/VR experiences, Wi-Fi 7 provides the speed, efficiency, and reliability required in today's high-density, device-rich environments—while laying the groundwork for next-generation connectivity.

10-Gigabit Ethernet Port

The DAP-E9560 also deliver ultra-fast wired connectivity, significantly reducing network latency and ensuring high throughput for bandwidth-intensive applications. With support for 10 GbE speeds, the network infrastructure is future-ready, providing the scalability and performance needed to meet growing demands and support upcoming upgrades without bottlenecks.

DAP-E9560 BE9500 Ceiling Mount Access Point

Powered by PoE

The DAP-E9560 can be powered directly via a PoE switch, enabling flexible installation without the need for additional power outlets. This simplifies deployment and reduces overall installation costs, making network expansion more efficient and cost-effective.

SSID-VLAN Mapping

The DAP-E9560 supports SSID-VLAN Mapping, allowing administrators to assign different SSIDs to specific VLAN tags. This capability effectively segregates user group access without compromising network security, ensuring traffic isolation and enhancing overall network management.

Customisable Captive Portal

The DAP-E9560 offers a customisable Captive Portal, enabling network administrators to create personalised login pages. This not only enhances network security through proper user authentication but also strengthens user engagement with tailored branding and messaging.

Advanced Security

The DAP-E9560 delivers Advanced Security features, including the latest WPA3™ Personal and Enterprise encryption and MAC/IP Access Control Lists (ACLs). These robust security measures ensure networks with higher security requirements are well protected against unauthorised access and potential threats.

Multiple Operational Modes

The DAP-E9560 offers Multiple Operational Modes to accommodate diverse deployment scenarios. In addition to standard AP mode, it supports WDS and WDS+AP modes, providing flexible options for extending network coverage and integrating with existing infrastructure.

Centralised Management

The DAP-E9560 supports the Nuclias Network Controller, enabling users to easily automate, monitor, and scale their network operations. This centralised management platform offers an intuitive interface and real-time data insights, simplifying network administration and allowing seamless expansion as the network grows. With centralised management, maintaining optimal performance and security becomes more efficient and less time-consuming.

Connection Diagram

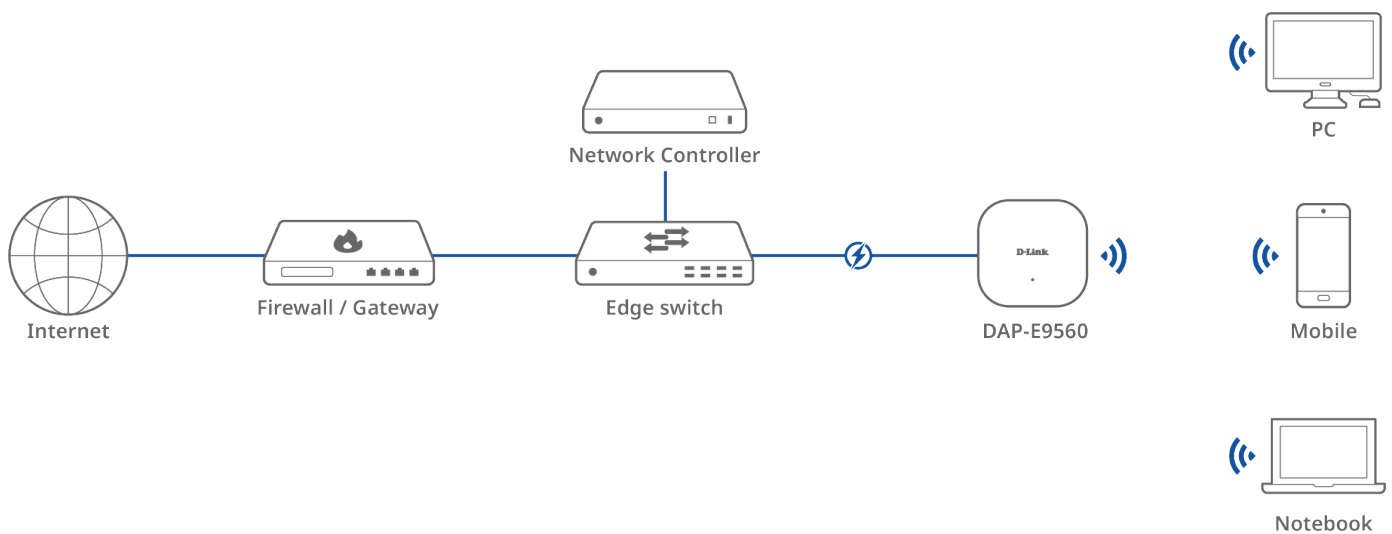

DAP-E9560 BE9500 Ceiling Mount Access Point

Antenna Pattern

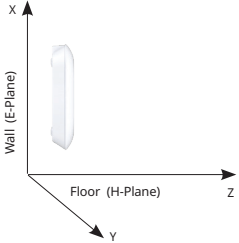
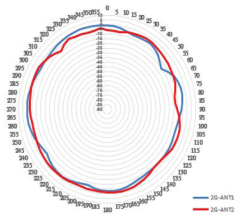
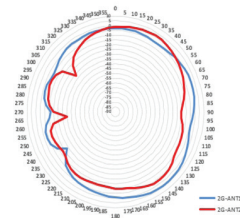
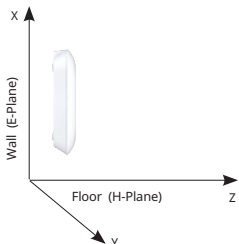
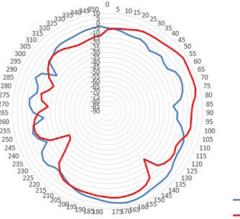
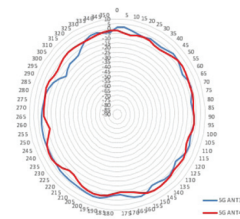
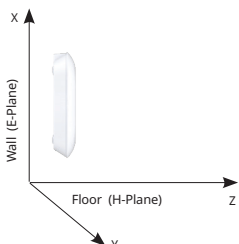
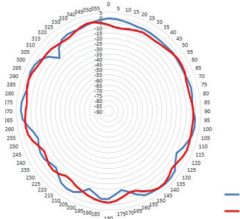
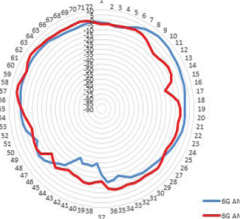
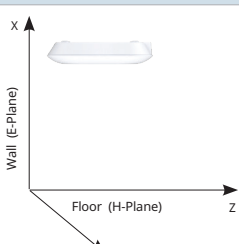
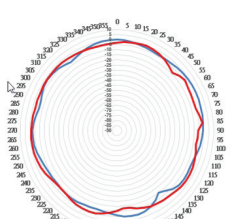
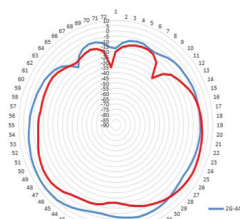
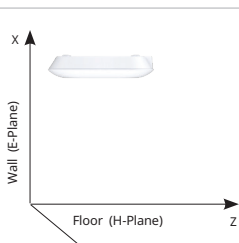
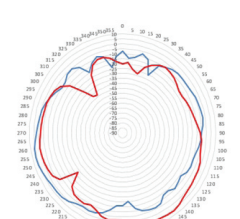
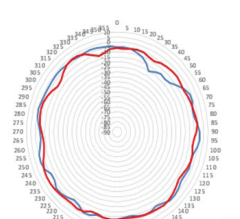
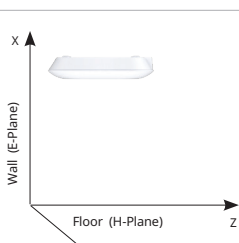
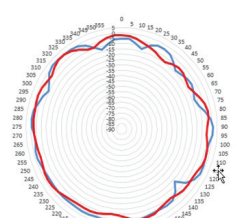
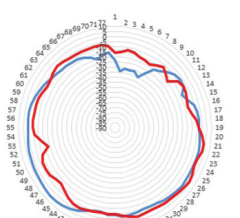
Wall Mount				
Orientation			H-Plane	E-Plane
2.4 GHz Wall Mount				
5 GHz Wall Mount				
6 GHz Wall Mount				
Ceiling Mount				
Orientation			H-Plane	E-Plane
2.4 GHz Ceiling Mount				
5 GHz Ceiling Mount				
6 GHz Ceiling Mount				

DAP-E9560 BE9500 Ceiling Mount Access Point

Specifications

General
Device Interfaces
<ul style="list-style-type: none">• 1 x 10 Gigabit Ethernet PoE LAN port• 1 x 2.5 Gigabit Ethernet LAN port• 1 x RJ45 console port• 1 x Reset button• 1 x USB Type C power connector
LED
Power/Status
Antenna
<ul style="list-style-type: none">• 2 x 3.3 dBi @ 2.4 GHz• 2 x 4.8 dBi @ 5 GHz• 2 x 4.6 dBi @ 6 GHz
Wi-Fi Data Rate^{2,3}
<ul style="list-style-type: none">• 2.4 GHz up to 688 Mbps• 5 GHz up to 2882 Mbps• 6 GHz up to 5764 Mbps
IEEE Standard³
<ul style="list-style-type: none">• IEEE 802.11be/ax/ac/n/g/b/a• IEEE 802.3bt PoE• IEEE 802.3u/ab/an/bz• IEEE 802.3az Energy-Efficient Ethernet (EEE)
Maximum Output Power¹
<ul style="list-style-type: none">• 23 dBm (2.4 GHz)• 25 dBm (5 GHz)• 24 dBm (6 GHz)
Functionality
Security Protocol
<ul style="list-style-type: none">• WPA/WPA2/WPA3™ Personal/Enterprise• SSID broadcast disable• MAC address access control• WEP 64/128-bit• Enhanced Open• Internal RADIUS server
Operating Frequency²
<ul style="list-style-type: none">• 2.4 - 2.483 GHz• 5.15 - 5.35 GHz• 5.925 - 7.125 GHz
Software
Device Management
<ul style="list-style-type: none">• Web (HTTP/HTTPS)• Nuclias Network Controller• Telnet/SSH• SNMP

Physical
Dimensions
223.04 x 223.04 x 46.7 mm
Weight
1167 g
Power Input⁵
802.3bt or 20V/2.25A (USB Type C)
Max Power Consumption
27.756W
Operating Temperature
0 to 40 °C
Storage Temperature
-20 to 65 °C
Operating Humidity
10% to 90% non-condensing
Storage Humidity
5% to 95% non-condensing
Certifications⁴
<ul style="list-style-type: none">• CE• IC• FCC• LVD
Package Content
DAP-E9560
<ul style="list-style-type: none">• DAP-E9560• Ceiling Brackets• Mounting Plate• Quick Start Guide

1. The maximum output power is the board limit value, the actual output power will depend on regulatory requirements.

2. Maximum wireless signal rate derived from IEEE standard 802.11 specifications. Actual data throughput will vary. Network conditions and environmental factors, including volume of network traffic, building materials, construction, and network overhead may lower actual data throughput rate. Environmental factors will adversely affect wireless signal range.

3. Please note that operating frequency ranges vary depending on the regulations of individual countries and jurisdictions. The DAP-E9560 may not support the 5.25 - 5.35 GHz and 5.47 - 5.725 GHz frequency ranges in certain regions.

4. For the EU region, this product is compliant with CE regulations and operates within the following frequency ranges: 2.4 - 2.4835 GHz, 5.150 - 5.250 GHz, 5.250 - 5.350 GHz, and 5.470 - 5.750 GHz

5. Supports 802.3at power input. In this mode, the DAP-E9560 will disable the 2.5G Ethernet port and limit the 10G Ethernet port speed to 2.5G. However, it does not accept 802.3af power input mode.

Actual performances may vary due to settings, cabling, temperature, network configuration, interface, device compatibility, environmental and on-site conditions, and other similar factors. References to power capability, signal or processing speed, signal range or distance, data encryption, storage capacity, display properties, or other performance metrics are based on optimal conditions derived from industry standards and provided for informational purposes only. Specifications may be subject to change without prior notice.

DAP-E9560 BE9500 Ceiling Mount Access Point

Installation and Mounting

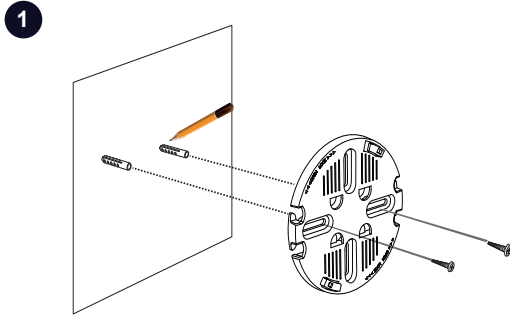

OR

