



APPLICATION SPECIFICATION



MX150 System Sealed Product Line

REVISION: D5	ECR/ECN INFORMATION: EC No: 673355 08/12/2021	TITLE: MX150 Application Guide	SHEET No. 1 of 76
DOCUMENT NUMBER: AS-33472-100	CREATED / REVISED BY: Jone Zheng	CHECKED BY: Elvis Song	APPROVED BY: Mike Vanslambrouck



Table of Contents

- **Section 1: Product Introduction**
- **Section 2: Product Summary**
- **Section 3: Connector Assembly**
- **Section 4: Connector Mating**
- **Section 5: Service Instructions**
- **Section 6: Electrical Continuity Checking**
- **Section 7: Crimping**
- **Section 8: Hybrid Connector**
- **Section 9: Troubleshooting Guide**
- **Section 10: Packaging**

REVISION: D5	ECR/ECN INFORMATION: EC No: 673355 08/12/2021	TITLE: MX150 Application Guide	SHEET No. 2 of 76
DOCUMENT NUMBER: AS-33472-100	CREATED / REVISED BY: Jone Zheng	CHECKED BY: Elvis Song	APPROVED BY: Mike Vanslambrouck



APPLICATION SPECIFICATION

Section 1: Product Introduction MX150 System

This instructions manual contains supplemental information pertaining to the Molex 1.50 mm sealed Product Line. Additional information, keyway and knockout patterns can be found on the sales drawings.

- SD-33471-**** (multiple documents)
- SD-33472-**** (multiple documents)
- SD-33481-**** (multiple documents)
- SD-33482-**** (multiple documents)
- SD-160008-**** (multiple documents)
- SD-160011-**** (multiple documents)
- SD-34986-**** (multiple documents)
- SD-34985-**** (multiple documents)

REVISION: D5	ECR/ECN INFORMATION: EC No: 673355 08/12/2021	TITLE: MX150 Application Guide	SHEET No. 3 of 76
DOCUMENT NUMBER: AS-33472-100	CREATED / REVISED BY: Jone Zheng	CHECKED BY: Elvis Song	APPROVED BY: Mike Vanslambrouck



Section 1: Product Introduction MX150 System

Features and Benefits:

- Pre-assembled connector housings, seals and TPA components
- Simple crimp, poke and plug application
- Integral Terminal Position Assurance (TPA)
- Integral two-way, mat and interface seals designed and tested to IP 67 and SAE USCAR-2, Rev 3 standards
- Easy terminal extraction and insertion
- Compatible with a wide range of UL (22 to 14 AWG), SAE Automotive (22 to 14) and ISO (0.35 to 1.5mm²) style wires
- Integral locking latch with secondary connector position assurance (CPA) option
- Applied cost savings
- No need to crimp individual wire seals
- Locks terminals into housings and prevents terminals from backing out
- More than just waterproof, a true sealed connector system tested under submersed conditions
- Quick, low cost field repairs
- Supports a wide range of power and signal applications
- Assures positive mating of connector and prevents accidental disengagement during high vibration and severe shock application

REVISION: D5	ECR/ECN INFORMATION: EC No: 673355 08/12/2021	TITLE: MX150 Application Guide	SHEET No. 4 of 76
DOCUMENT NUMBER: AS-33472-100	CREATED / REVISED BY: Jone Zheng	CHECKED BY: Elvis Song	APPROVED BY: Mike Vanslambrouck



APPLICATION SPECIFICATION

Section 1: Product Introduction MX150 System

MX150 Applications:

- Passenger Automobiles (Exclusively for MX150 family)
- Off Highway Construction Equipment
- Agriculture Equipment
- Trucks, Busses and RVs
- Commercial and Recreational Marine Equipment
- Material Handling Equipment
- Lawn and Garden Equipment
- Outdoor Lighting
- Industrial Control

This User Manual can be found at www.molex.com/ind/mx150.html
To order, please contact your Molex Sales Representative or check www.molex.com

REVISION: D5	ECR/ECN INFORMATION: EC No: 673355 08/12/2021	TITLE: MX150 Application Guide	SHEET No. 5 of 76
DOCUMENT NUMBER: AS-33472-100	CREATED / REVISED BY: Jone Zheng	CHECKED BY: Elvis Song	APPROVED BY: Mike Vanslambrouck



Section 2: Product Summary A. Connector Assemblies

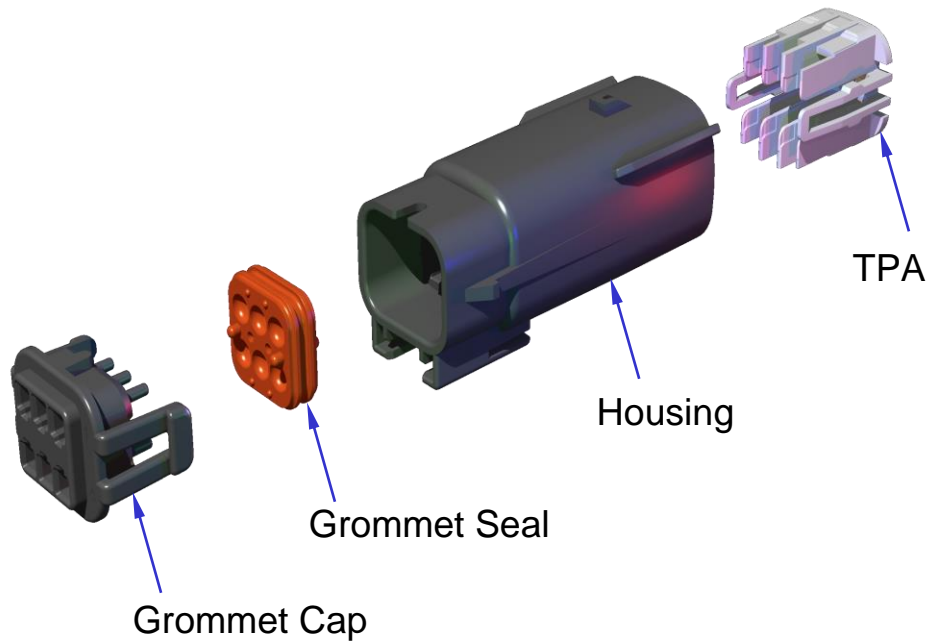

6 Way 2X3 Blade Connector

REVISION: D5	ECR/ECN INFORMATION: EC No: 673355 08/12/2021	TITLE: MX150 Application Guide	SHEET No. 6 of 76
DOCUMENT NUMBER: AS-33472-100	CREATED / REVISED BY: Jone Zheng	CHECKED BY: Elvis Song	APPROVED BY: Mike Vanslambrouck



APPLICATION SPECIFICATION

Section 2: Product Summary B. Connector Assemblies (continued)

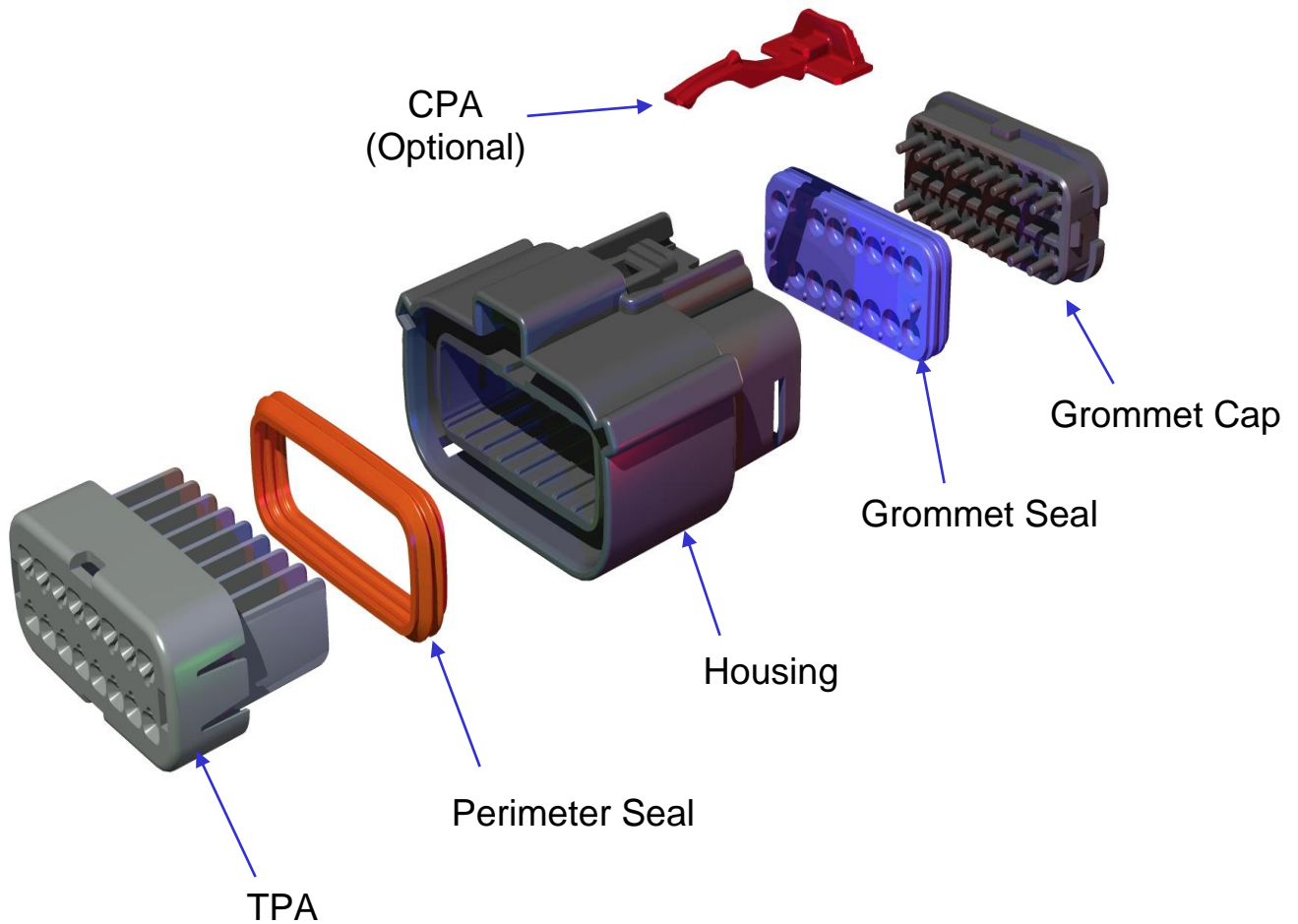

16 Way 2X8 Standard Receptacle Connector

REVISION: D5	ECR/ECN INFORMATION: EC No: 673355 08/12/2021	TITLE: MX150 Application Guide	SHEET No. 7 of 76
DOCUMENT NUMBER: AS-33472-100	CREATED / REVISED BY: Jone Zheng	CHECKED BY: Elvis Song	APPROVED BY: Mike Vanslambrouck



APPLICATION SPECIFICATION

Section 2: Product Summary C. Connector Assemblies (continued)

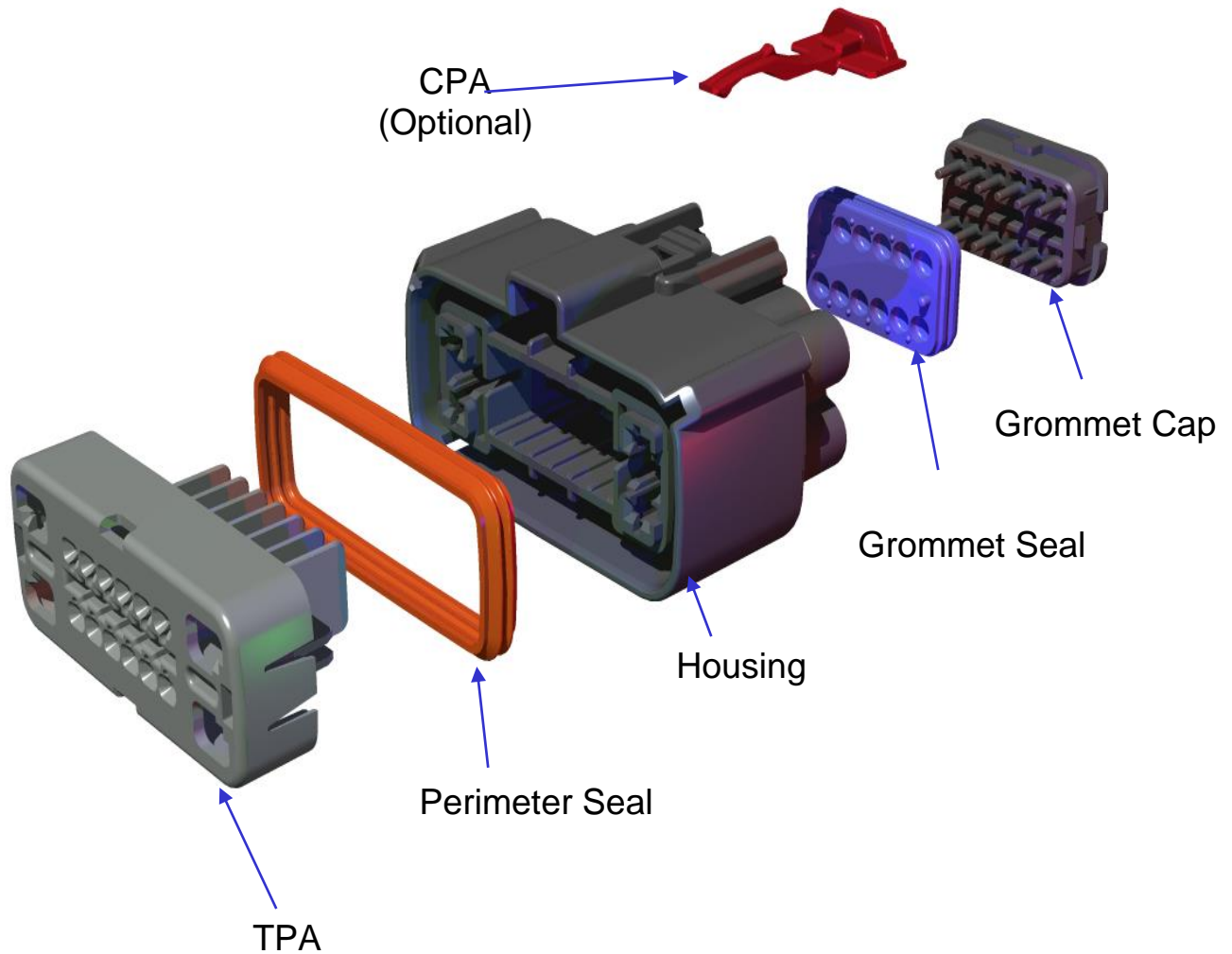

16 Way Hybrid Receptacle Connector

REVISION: D5	ECR/ECN INFORMATION: EC No: 673355 08/12/2021	TITLE: MX150 Application Guide	SHEET No. 8 of 76
DOCUMENT NUMBER: AS-33472-100	CREATED / REVISED BY: Jones Zheng	CHECKED BY: Elvis Song	APPROVED BY: Mike Vanslambrouck



APPLICATION SPECIFICATION

Section 2: Product Summary C. Connector Assemblies (continued)

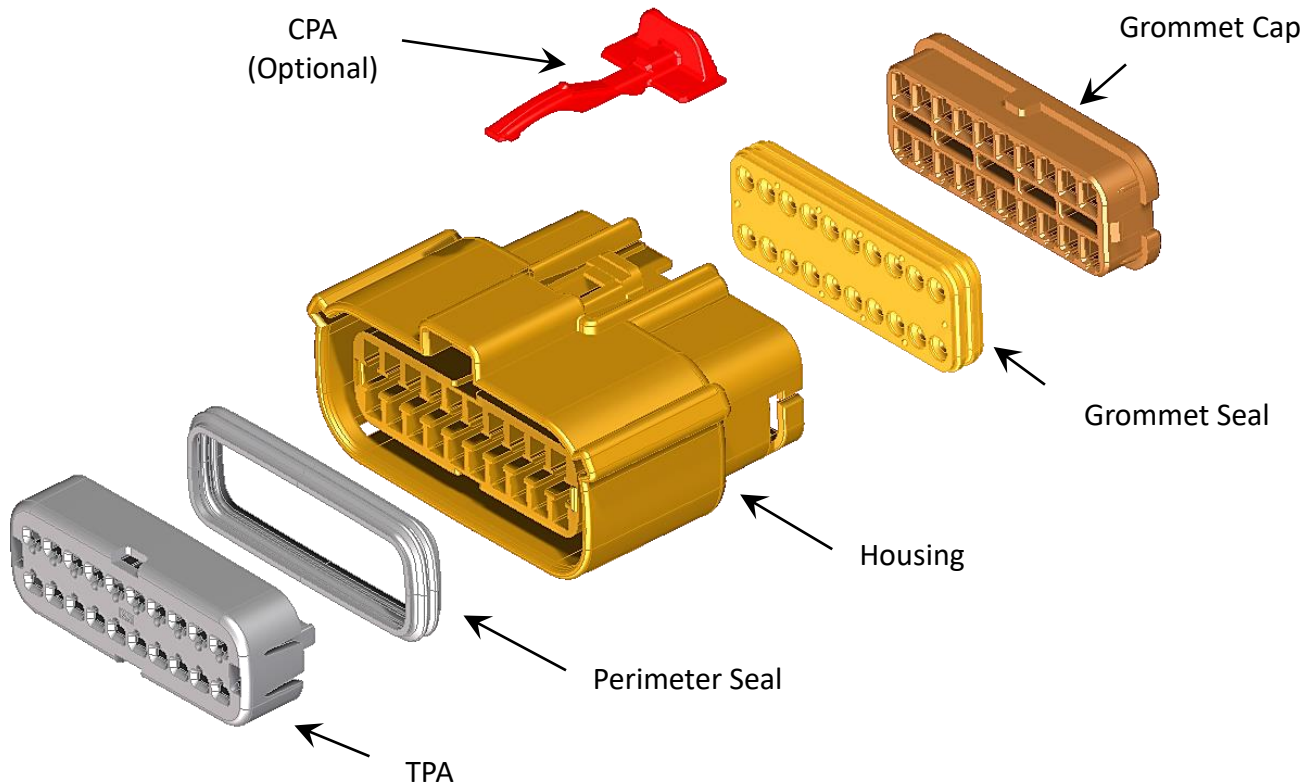

20 Way 2X10 Receptacle Connector

REVISION: D5	ECR/ECN INFORMATION: EC No: 673355 08/12/2021	TITLE: MX150 Application Guide	SHEET No. 9 of 76
DOCUMENT NUMBER: AS-33472-100	CREATED / REVISED BY: Jone Zheng	CHECKED BY: Elvis Song	APPROVED BY: Mike Vanslambrouck



APPLICATION SPECIFICATION

Section 2: Product Summary C. Connector Assemblies (continued)

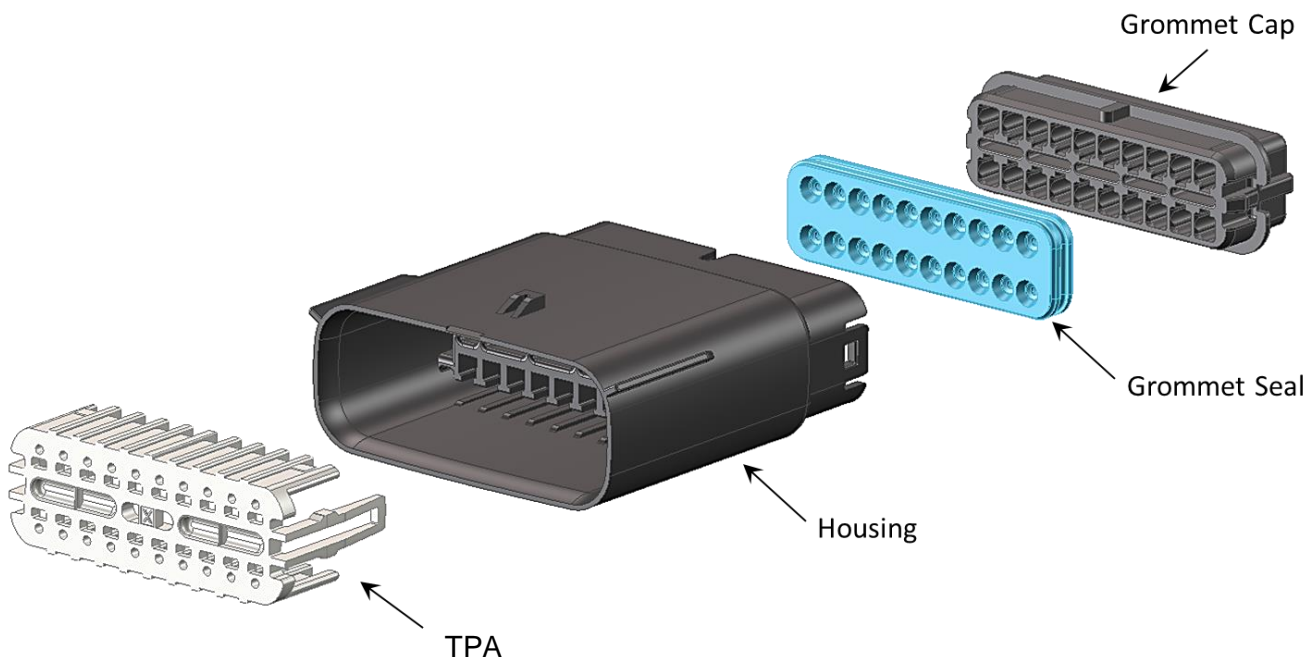

20 Way 2X10 Blade Connector

REVISION: D5	ECR/ECN INFORMATION: EC No: 673355 08/12/2021	TITLE: MX150 Application Guide	SHEET No. 10 of 76
DOCUMENT NUMBER: AS-33472-100	CREATED / REVISED BY: Jone Zheng	CHECKED BY: Elvis Song	APPROVED BY: Mike Vanslambrouck



APPLICATION SPECIFICATION

Section 2: Product Summary

D. Receptacle/Blade Terminal

Terminal Features

Base Material - Copper Alloy

Plating Options - Tin, Gold, Silver

Wire Sizes: 14,16,18,20,22 AWG

1.5, 1.0, 0.8, 0.75, 0.5, 0.35 mm²

Refer to Section 7 for crimping details.

Orientation Feature

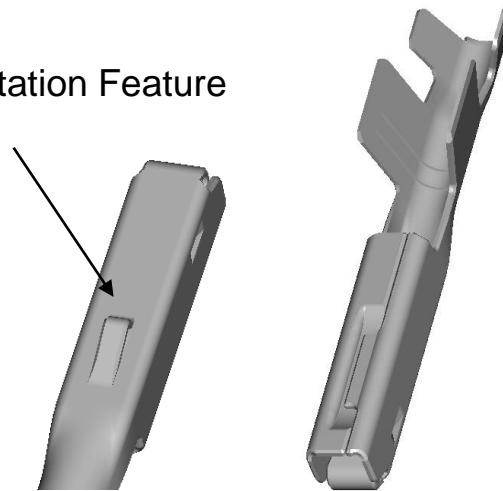

Receptacle Terminal

Orientation Feature

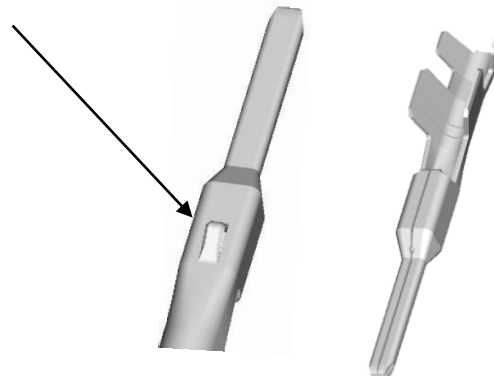

Blade Terminal

REVISION: D5	ECR/ECN INFORMATION: EC No: 673355 08/12/2021	TITLE: MX150 Application Guide	SHEET No. 11 of 76
DOCUMENT NUMBER: AS-33472-100	CREATED / REVISED BY: Jone Zheng	CHECKED BY: Elvis Song	APPROVED BY: Mike Vanslambrouck



APPLICATION SPECIFICATION

Section 2: Product Summary

E. Product Identification

- All parts are laser etched with:
 1. Molex Part Number
 2. Date Code (YYDDD)
 - YY = Last Digit of Year
 - DDD = Day of Year

Note – Presence of laser marking for MX 150 16 way Hybrid depends on the manufacturing place.

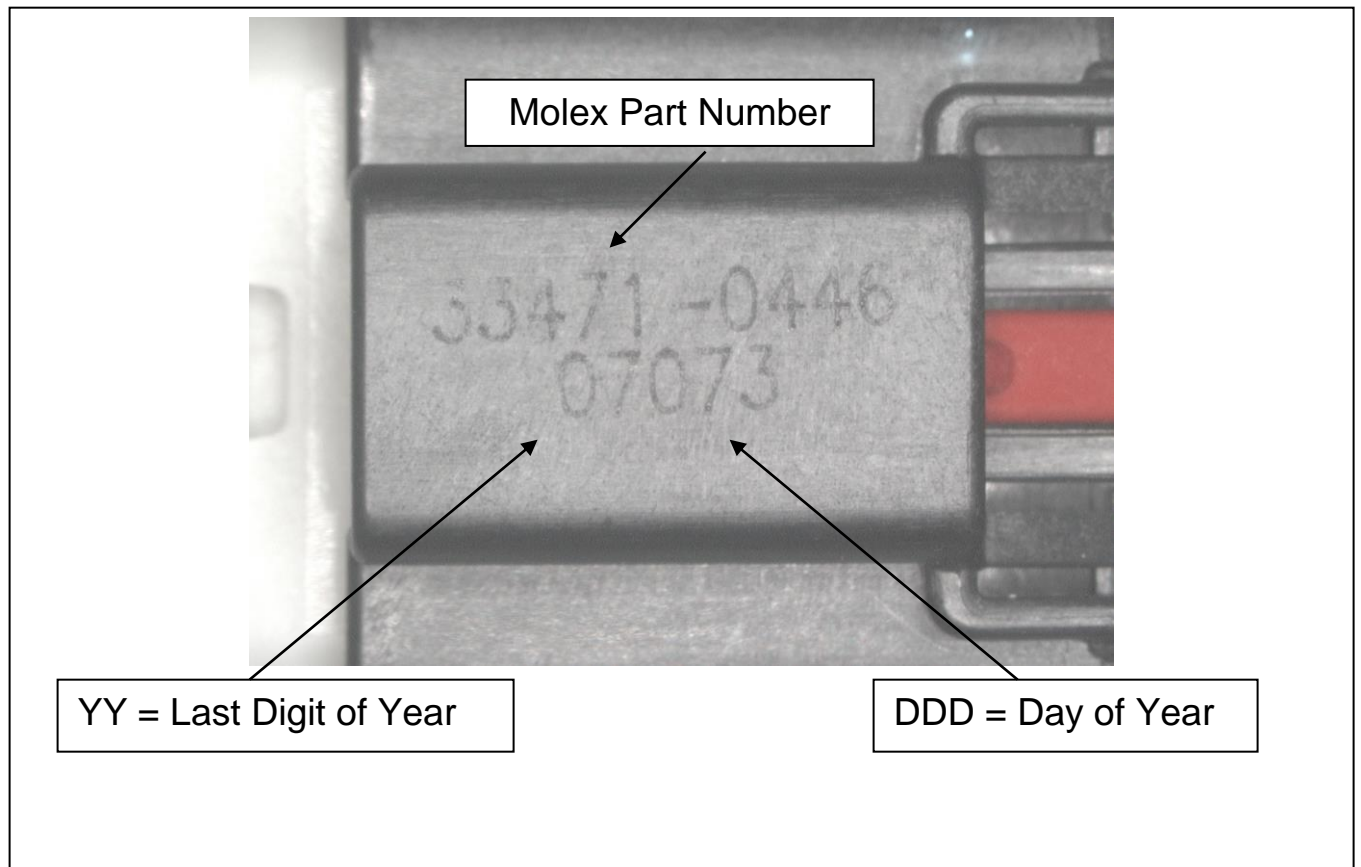

REVISION: D5	ECR/ECN INFORMATION: EC No: 673355 08/12/2021	TITLE: MX150 Application Guide	SHEET No. 12 of 76
DOCUMENT NUMBER: AS-33472-100	CREATED / REVISED BY: Jone Zheng	CHECKED BY: Elvis Song	APPROVED BY: Mike Vanslambrouck



APPLICATION SPECIFICATION

Section 3: Connector Assembly

A. "As Shipped" connector positions

TPA's shown in "As Shipped" condition.

The TPA should remain in the pre-lock position until all circuits are loaded.

TPA movement distance from pre-lock to final lock = 5.0 mm in both Blade and Receptacle connectors.

The TPA should never be removed from the connector!

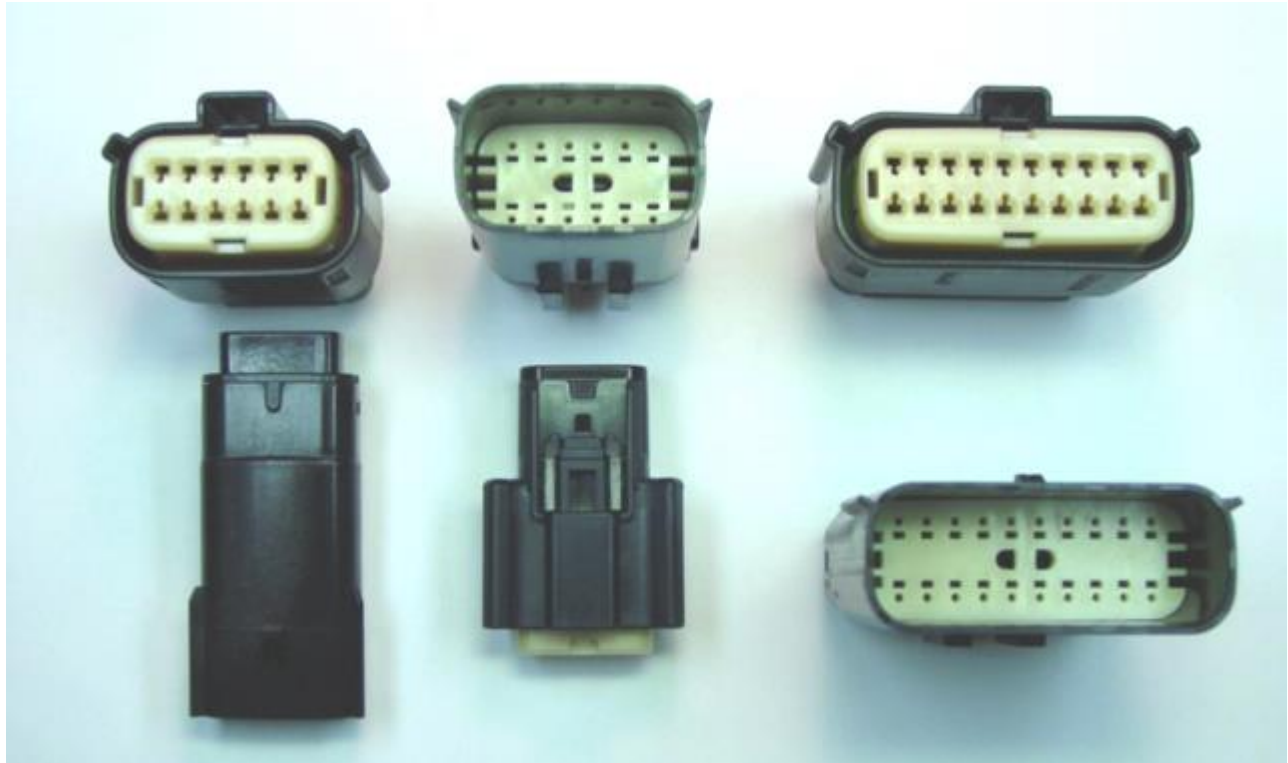

REVISION: D5	ECR/ECN INFORMATION: EC No: 673355 08/12/2021	TITLE: MX150 Application Guide	SHEET No. 13 of 76
DOCUMENT NUMBER: AS-33472-100	CREATED / REVISED BY: Jone Zheng	CHECKED BY: Elvis Song	APPROVED BY: Mike Vanslambrouck



APPLICATION SPECIFICATION

TPA's shown in pre-lock

CPA is shown in "as shipped" pre-lock condition:



CPA's shown in pre-lock



CPA's shown in final-lock

If CPA gets moved from pre-lock to final lock position during shipping, pull CPA to bring it back to the pre-lock position.



REVISION: D5	ECR/ECN INFORMATION: EC No: 673355 08/12/2021	TITLE: MX150 Application Guide	SHEET No. 14 of 76
DOCUMENT NUMBER: AS-33472-100	CREATED / REVISED BY: Jones Zheng	CHECKED BY: Elvis Song	APPROVED BY: Mike Vanslambrouck



APPLICATION SPECIFICATION

Section 3: Connector Assembly B. TPA in Pre-lock and Lock

TPA shown in "Pre-lock" position.(Fig.10-a)

TPA shown in "lock" position. (Fig 10-b)

The TPA should never be removed from the connector!

Fig. 10-a

Pre-lock

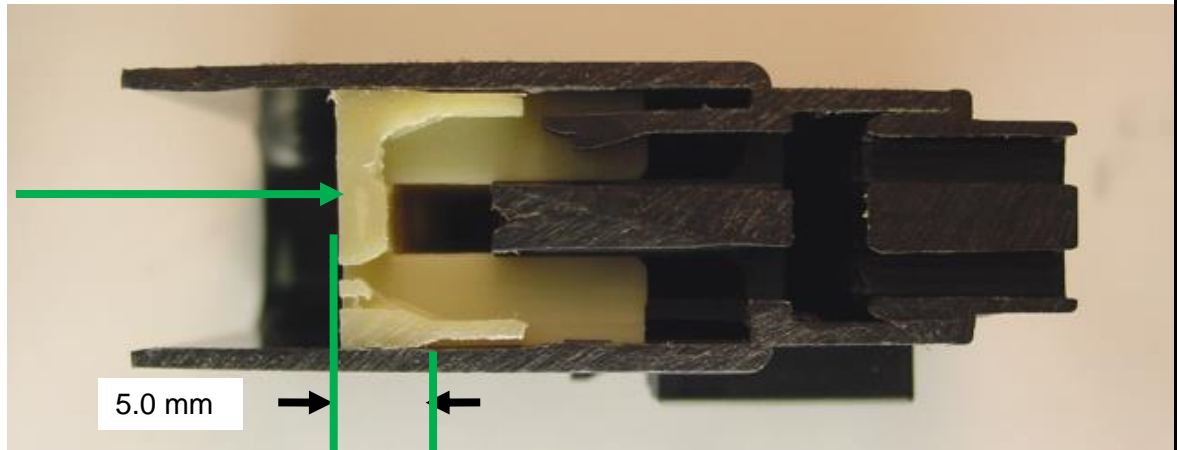
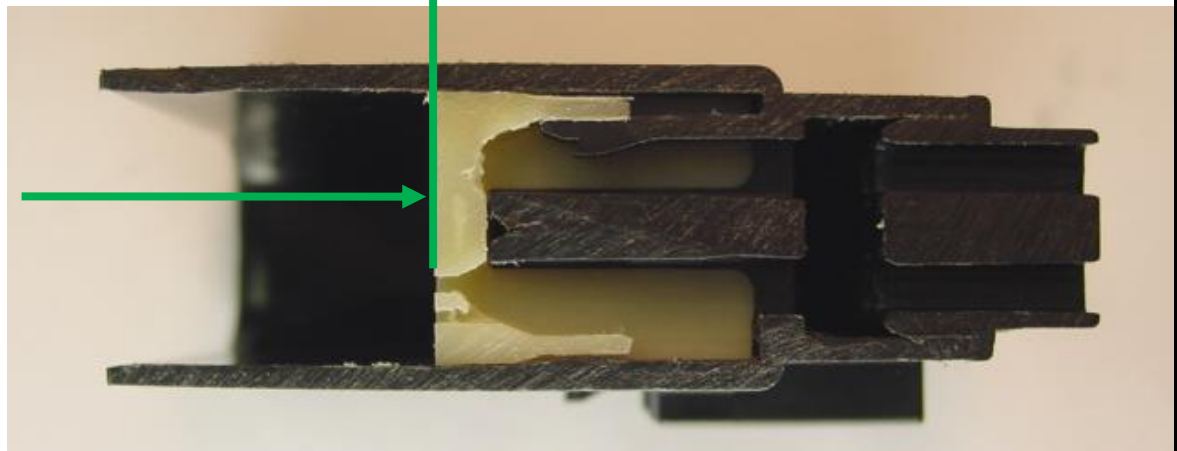

Fig. 10-b

Lock



Cross section of TPA in pre-lock / lock

REVISION: D5	ECR/ECN INFORMATION: EC No: 673355 08/12/2021	TITLE: MX150 Application Guide	SHEET No. 15 of 76
DOCUMENT NUMBER: AS-33472-100	CREATED / REVISED BY: Jone Zheng	CHECKED BY: Elvis Song	APPROVED BY: Mike Vanslambrouck



APPLICATION SPECIFICATION

Section 3: Connector Assembly C. Seal Plug Installation - Receptacle

With TPA still in pre-lock position, orient seal plug to rear of connector. Align the orientation feature and insert through appropriate circuit opening. If resistance is encountered, retract the plug, and adjust the angle of insertion. Continue inserting the plug until it stops and locks up on the lock finger with an audible click.

Seal plug 34345-4001 can be used with the Gen 1 and Gen 2 Receptacle connectors.

Caution: Once fully seated, the seal plug is not a serviceable item.

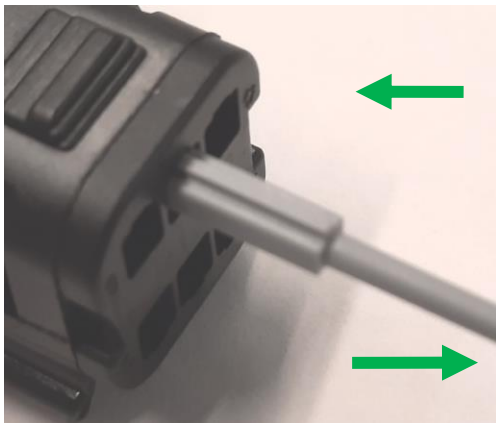

PUSH

CLICK

PULL

Orientation Feature

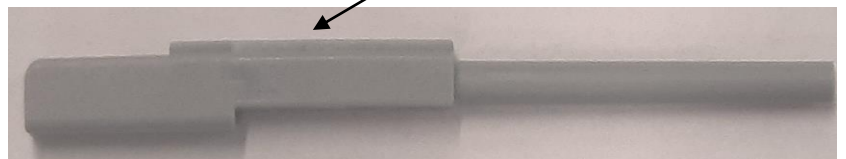

Molex Part Number 34345-4001



Seal plug cannot be used in shorting bar circuits!

REVISION: D5	ECR/ECN INFORMATION: EC No: 673355 08/12/2021	TITLE: MX150 Application Guide	SHEET No. 16 of 76
DOCUMENT NUMBER: AS-33472-100	CREATED / REVISED BY: Jone Zheng	CHECKED BY: Elvis Song	APPROVED BY: Mike Vanslambrouck



APPLICATION SPECIFICATION

Section 3: Connector Assembly

C. Seal Plug Installation continued - Receptacle



**YES!
CORRECT!**

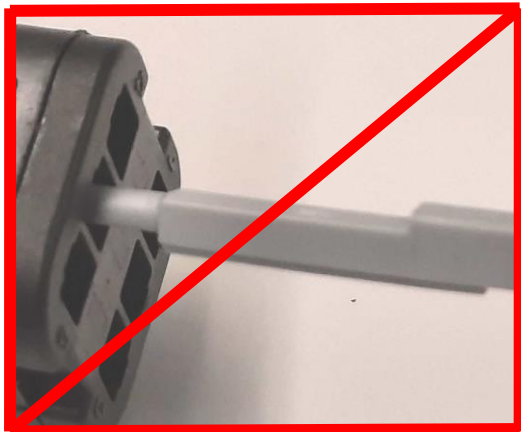

Backwards

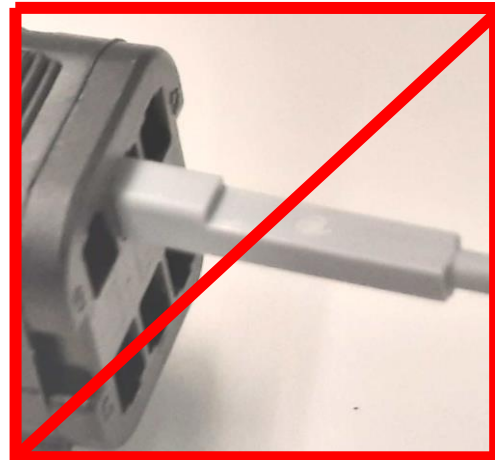

180° out of alignment!

**NO!
WRONG!**

REVISION: D5	ECR/ECN INFORMATION: EC No: 673355 08/12/2021	TITLE: MX150 Application Guide	SHEET No. 17 of 76
DOCUMENT NUMBER: AS-33472-100	CREATED / REVISED BY: Jone Zheng	CHECKED BY: Elvis Song	APPROVED BY: Mike Vanslambrouck



APPLICATION SPECIFICATION

Section 3: Connector Assembly

C. Seal Plug Installation continued - Receptacle

Molex Does Not Recommend Trimming the Receptacle Cavity Plugs



Molex does not recommend trimming the receptacle cavity plug. However, the Cavity plugs can be trimmed flush to avoid wire chafing and avoid cavity plug dislocation / push through. The decision to trim is the discretion of the harness supplier. Cavity plugs must be installed and trimmed before wires are installed.

Never trim cavity plugs with wires installed!



The side cutters used to cut the plugs should be sharp

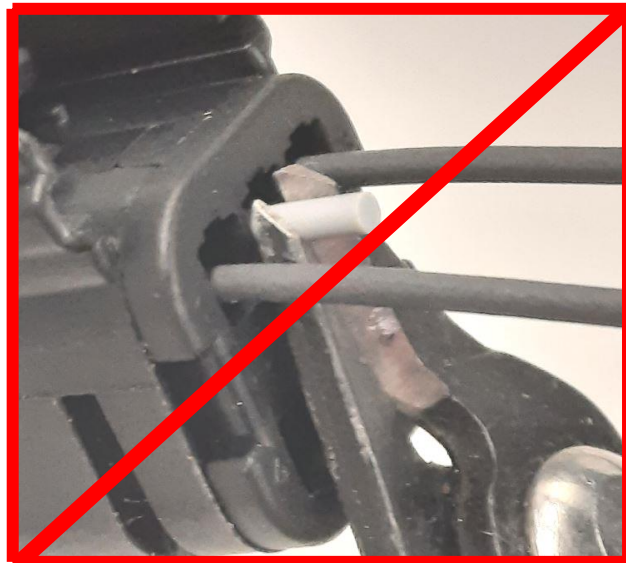

REVISION: D5	ECR/ECN INFORMATION: EC No: 673355 08/12/2021	TITLE: MX150 Application Guide	SHEET No. 18 of 76
DOCUMENT NUMBER: AS-33472-100	CREATED / REVISED BY: Jone Zheng	CHECKED BY: Elvis Song	APPROVED BY: Mike Vanslambrouck



APPLICATION SPECIFICATION

Section 3: Connector Assembly

C. Seal Plug Installation - Blade (Gen 1 Series 33481 & 33482)

With TPA still in pre-lock position, orient seal plug to rear of connector. Align the orientation feature and insert through appropriate circuit opening. If resistance is encountered, retract the plug, and adjust the angle of insertion. Continue inserting the plug until it stops and locks up on the lock finger with an audible click.

Seal plug 34345-0001 can only be used with the Gen 1 Blade connectors.

Caution: Once fully seated, the seal plug is not a serviceable item.

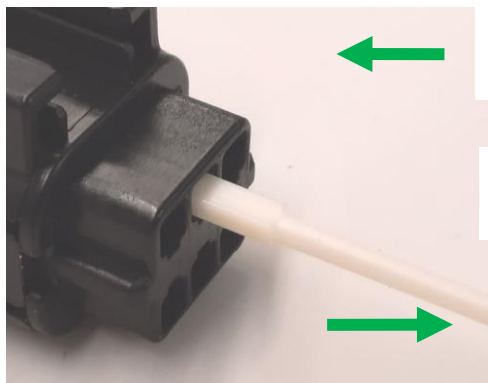

PUSH

CLICK

PULL

Orientation Feature



Molex Part Number 34345-0001



Seal plug cannot be used in shorting bar circuits!

REVISION: D5	ECR/ECN INFORMATION: EC No: 673355 08/12/2021	TITLE: MX150 Application Guide	SHEET No. 19 of 76
DOCUMENT NUMBER: AS-33472-100	CREATED / REVISED BY: Jone Zheng	CHECKED BY: Elvis Song	APPROVED BY: Mike Vanslambrouck



APPLICATION SPECIFICATION

Section 3: Connector Assembly

C. Seal Plug Installation - Blade (Gen 2 Series 160011 & 160012)

With TPA still in pre-lock position, orient seal plug to rear of connector. Align the orientation feature and insert through appropriate circuit opening. If resistance is encountered, retract the plug, and adjust the angle of insertion. Continue inserting the plug until it stops and locks up on the lock finger with an audible click.

Seal plug 34345-0003 can only be used with the Gen 2 Blade connectors.

Caution: Once fully seated, the seal plug is not a serviceable item.

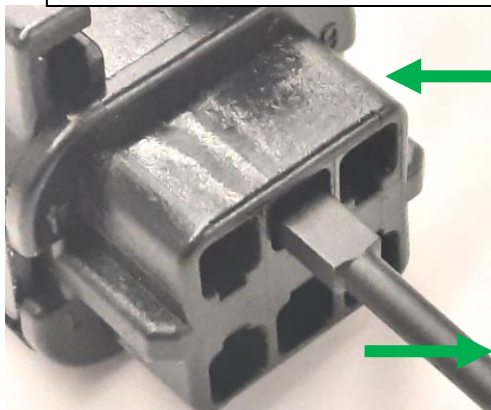

PUSH

CLICK

PULL

Orientation Feature



Molex Part Number 34345-0003

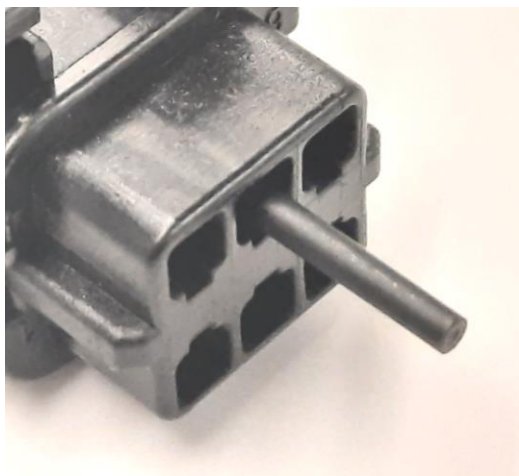

Seal plug cannot be used in shorting bar circuits!

REVISION: D5	ECR/ECN INFORMATION: EC No: 673355 08/12/2021	TITLE: MX150 Application Guide	SHEET No. 20 of 76
DOCUMENT NUMBER: AS-33472-100	CREATED / REVISED BY: Jone Zheng	CHECKED BY: Elvis Song	APPROVED BY: Mike Vanslambrouck



APPLICATION SPECIFICATION

Section 3: Connector Assembly

C. Seal Plug Installation continued – Blade

This is for both Gen 1 and Gen 2 connectors

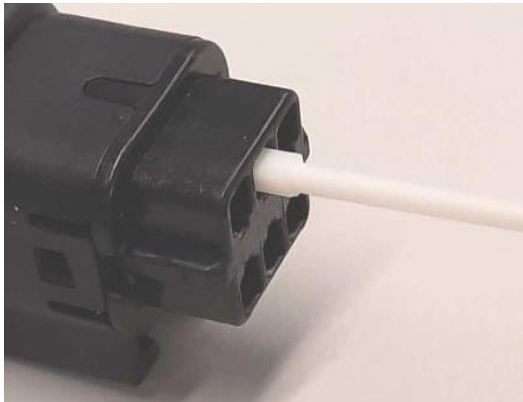

YES!
CORRECT!

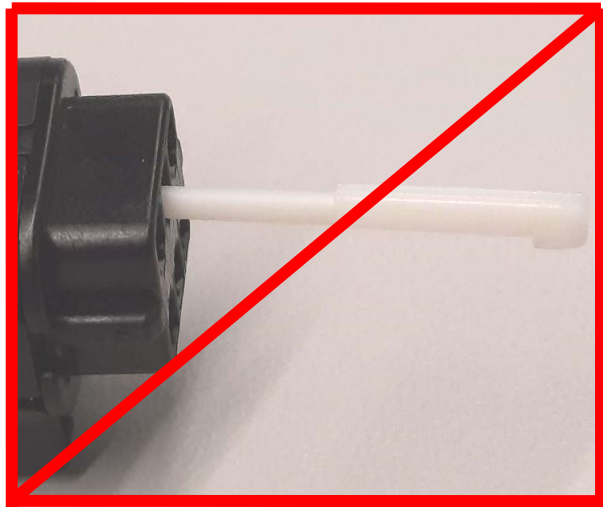

Backwards

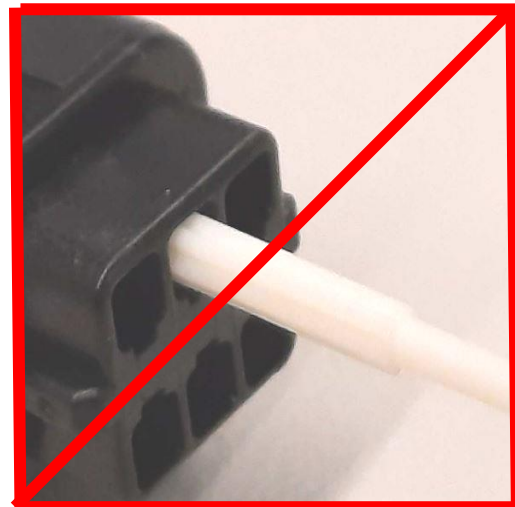

90° out of alignment!

**NO!
WRONG!**

REVISION: D5	ECR/ECN INFORMATION: EC No: 673355 08/12/2021	TITLE: MX150 Application Guide	SHEET No. 21 of 76
DOCUMENT NUMBER: AS-33472-100	CREATED / REVISED BY: Jone Zheng	CHECKED BY: Elvis Song	APPROVED BY: Mike Vanslambrouck



APPLICATION SPECIFICATION

Section 3: Connector Assembly

C. Seal Plug Installation continued – Blade

This is for both Gen 1 and Gen 2 connectors

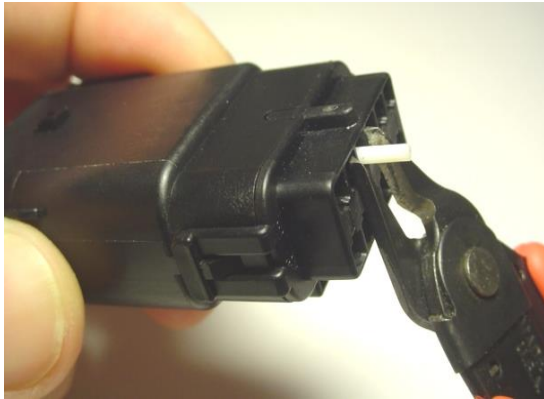

Blade Cavity plugs can be trimmed flush to avoid wire chafing and avoid cavity plug dislocation/push through, the decision to trim is the discretion of the harness supplier. Cavity plugs must be installed, and trimmed before wires are installed.

Never trim cavity plugs with wires installed!

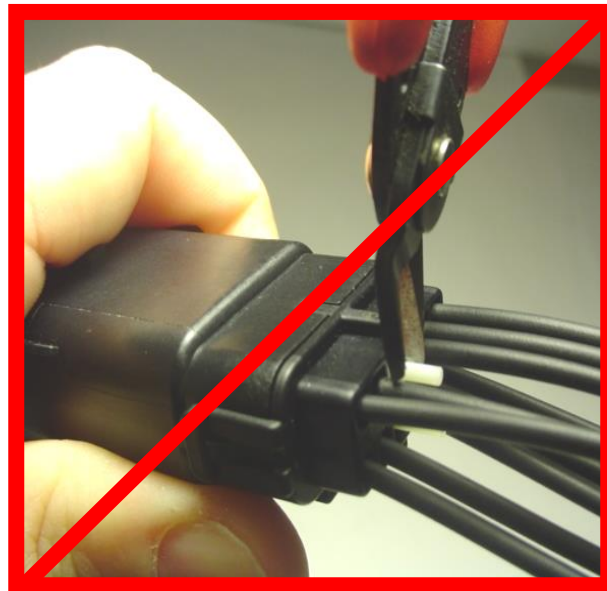

Caution: Once fully seated, the seal plug is not a serviceable item.

REVISION: D5	ECR/ECN INFORMATION: EC No: 673355 08/12/2021	TITLE: MX150 Application Guide	SHEET No. 22 of 76
DOCUMENT NUMBER: AS-33472-100	CREATED / REVISED BY: Jone Zheng	CHECKED BY: Elvis Song	APPROVED BY: Mike Vanslambrouck



APPLICATION SPECIFICATION

Section 3: Connector Assembly C. Seal Plug Installation continued

2.8 cavity plug step by step installation is shown in the illustrations below. The cavity plug must be fully installed with all 3 seal glands engaged in the seal cavity. **Never use a screwdriver or an object with sharp edge to push in the plug as it will damage seal. If a tool will be used to seat the plug, only use a rounded blunt end to push in the plug.**



For seal plug information see
Product Specification PS-33476-000

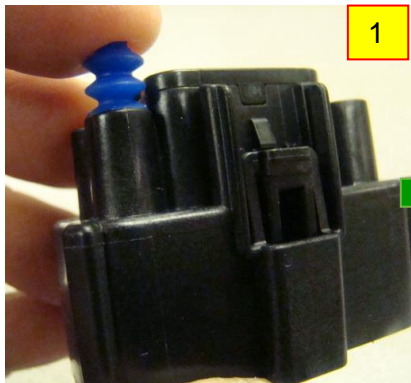

1



2

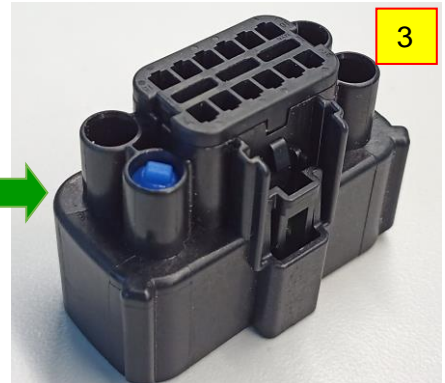

3

Receptacle Connector



1



2



3

Blade Connector

REVISION: D5	ECR/ECN INFORMATION: EC No: 673355 08/12/2021	TITLE: MX150 Application Guide	SHEET No. 23 of 76
DOCUMENT NUMBER: AS-33472-100	CREATED / REVISED BY: Jone Zheng	CHECKED BY: Elvis Song	APPROVED BY: Mike Vanslambrouck



APPLICATION SPECIFICATION

WRONG



The cavity plug must be fully installed with all 3 seal glands engaged in the seal cavity



CORRECT

WRONG



Never use a screwdriver or an object with sharp edge to push in the plug as it will damage seal
If a tool will be used to seat the plug, only use a rounded blunt end to push in the plug

REVISION: D5	ECR/ECN INFORMATION: EC No: 673355 08/12/2021	TITLE: MX150 Application Guide	SHEET No. 24 of 76
DOCUMENT NUMBER: AS-33472-100	CREATED / REVISED BY: Jone Zheng	CHECKED BY: Elvis Song	APPROVED BY: Mike Vanslambrouck



APPLICATION SPECIFICATION

Section 3: Connector Assembly

D. Terminal Installation

With TPA still in pre-lock position, orient terminal to rear of connector. For the receptacle terminal, grip the wire no less than 20 mm from the terminal insulation crimp, align the orientation feature, and insert through appropriate circuit opening. For the blade terminal, grip the wire no less than 25 mm from the terminal insulation crimp, align the orientation feature, and insert through appropriate circuit opening. If resistance is encountered, retract the terminal and adjust the angle of insertion. Continue inserting the terminal until it stops and locks up on the lock finger with an audible click.

MX150 Receptacle Installation

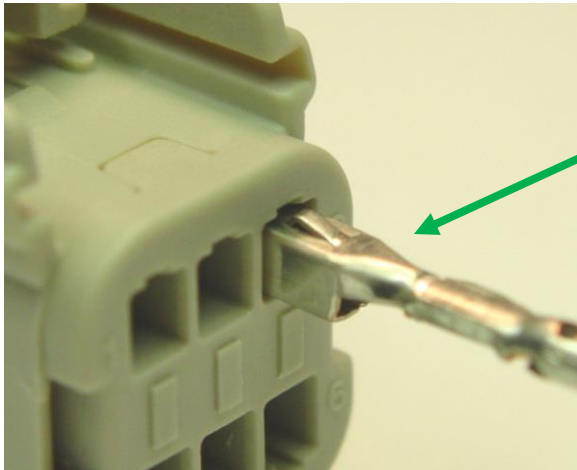

Correct Orientation

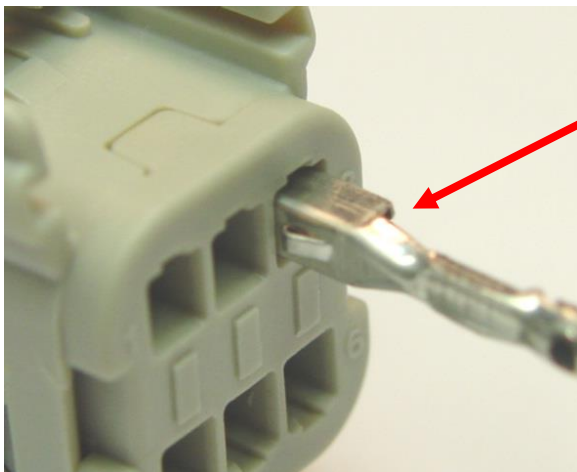

90° Mis-orientation

REVISION: D5	ECR/ECN INFORMATION: EC No: 673355 08/12/2021	TITLE: MX150 Application Guide	SHEET No. 25 of 76
DOCUMENT NUMBER: AS-33472-100	CREATED / REVISED BY: Jone Zheng	CHECKED BY: Elvis Song	APPROVED BY: Mike Vanslambrouck



APPLICATION SPECIFICATION

Dual Row MX150 Blade Installation

Do not install the blade terminal away from the grommet cap orientation feature

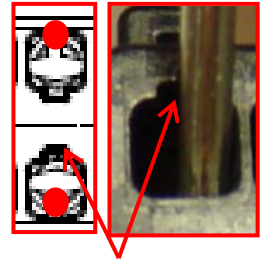
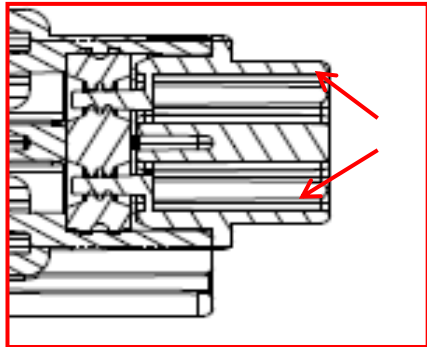
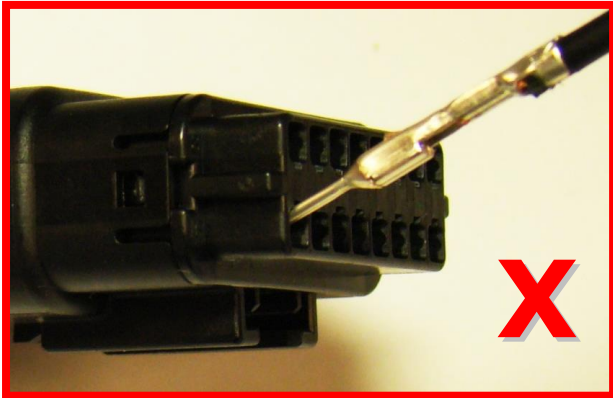

Orientation Feature

Install blade terminal straight or slightly angled towards the grommet cap orientation feature

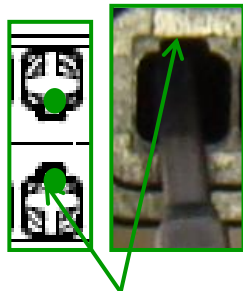
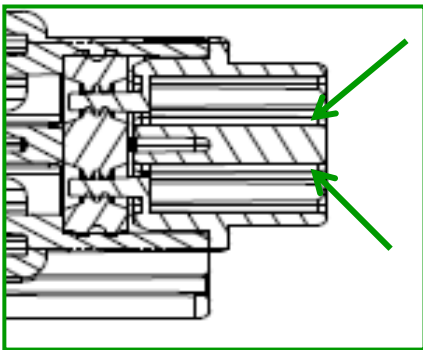

Orientation Feature

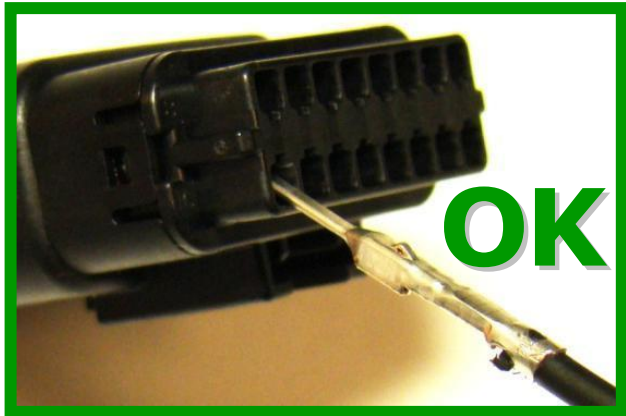

REVISION: D5	ECR/ECN INFORMATION: EC No: 673355 08/12/2021	TITLE: MX150 Application Guide	SHEET No. 26 of 76
DOCUMENT NUMBER: AS-33472-100	CREATED / REVISED BY: Jone Zheng	CHECKED BY: Elvis Song	APPROVED BY: Mike Vanslambrouck



APPLICATION SPECIFICATION

Single Row MX150 Blade Installation

Do not install the blade terminal away from the grommet cap orientation feature

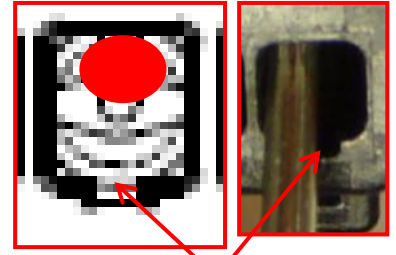
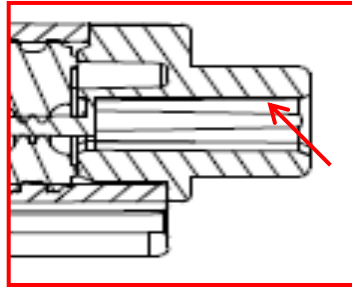

Orientation Feature

Install blade terminal straight or slightly angled towards the grommet cap orientation feature

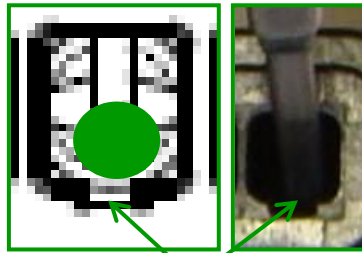
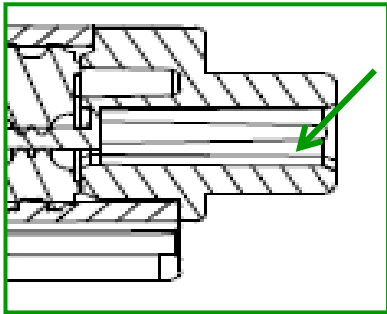

Orientation Feature



REVISION: D5	ECR/ECN INFORMATION: EC No: 673355 08/12/2021	TITLE: MX150 Application Guide	SHEET No. 27 of 76
DOCUMENT NUMBER: AS-33472-100	CREATED / REVISED BY: Jone Zheng	CHECKED BY: Elvis Song	APPROVED BY: Mike Vanslambrouck



APPLICATION SPECIFICATION

Hybrid MX150 Blade Installation

Do not install the blade terminal away from the grommet cap orientation feature

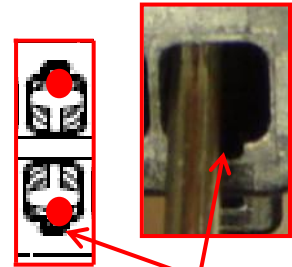
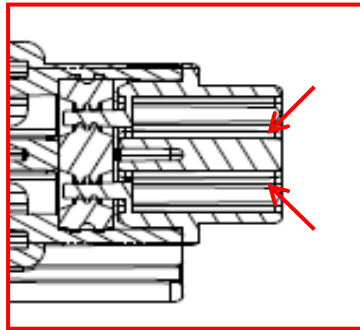
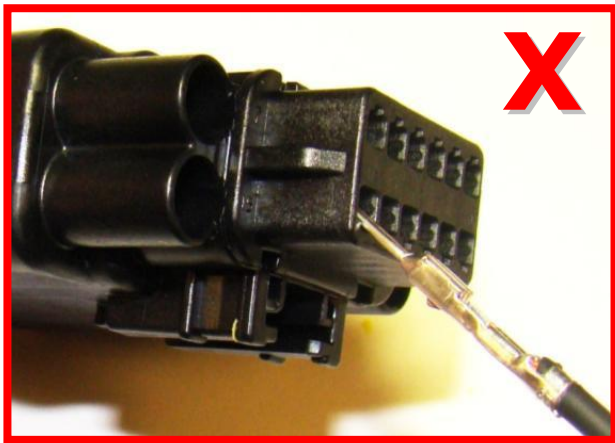

Orientation Feature

Install blade terminal straight or slightly angled towards the grommet cap orientation feature

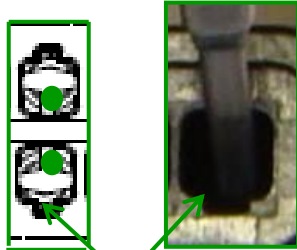
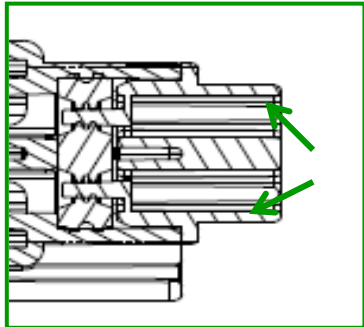

Orientation Feature

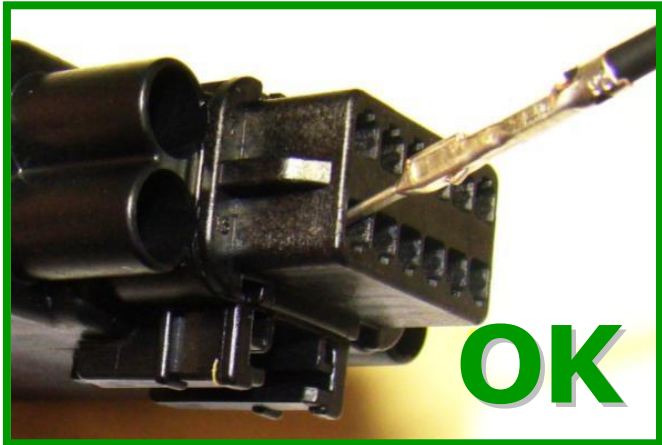

Warning: Hold the wire at least 25mm away from crimp location while installing terminals to avoid terminal rotation during installation. Installation should be completed in one push, click pull operation.

REVISION: D5	ECR/ECN INFORMATION: EC No: 673355 08/12/2021	TITLE: MX150 Application Guide	SHEET No. 28 of 76
DOCUMENT NUMBER: AS-33472-100	CREATED / REVISED BY: Jone Zheng	CHECKED BY: Elvis Song	APPROVED BY: Mike Vanslambrouck



APPLICATION SPECIFICATION

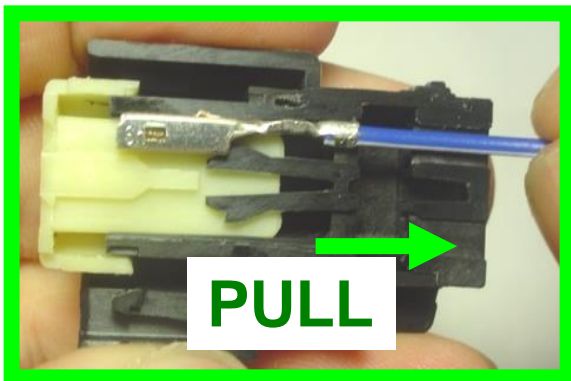
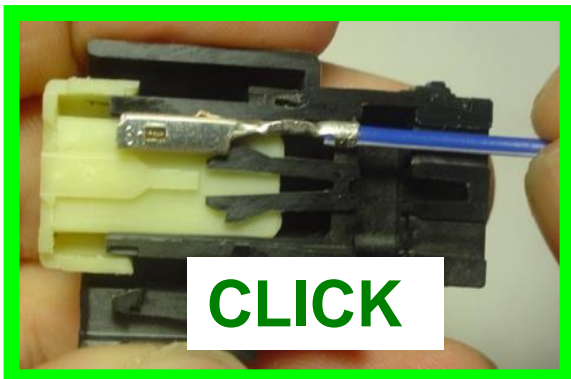
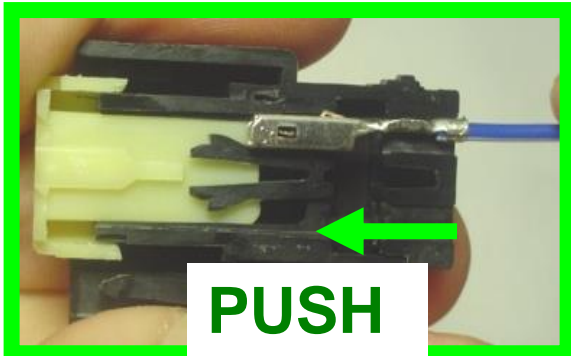

With TPA still in pre-lock position, orient terminal to rear of connector. Align the orientation feature and insert through appropriate circuit opening. If resistance is encountered, retract the terminal and adjust the angle of insertion. Continue inserting the terminal until it stops and locks up on the lock finger with an audible click. Once the audible click is heard, stop inserting the terminal.

Follow Push, Click, Pull method of terminal installation.

NO!!!

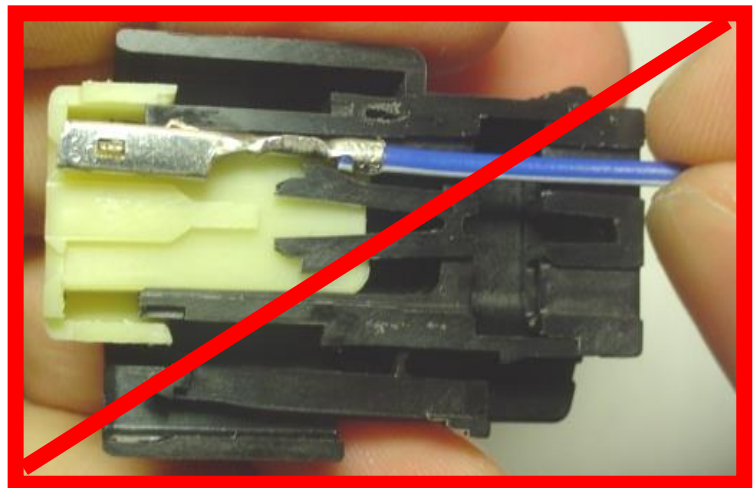

WRONG!!

REVISION: D5	ECR/ECN INFORMATION: EC No: 673355 08/12/2021	TITLE: MX150 Application Guide	SHEET No. 29 of 76
DOCUMENT NUMBER: AS-33472-100	CREATED / REVISED BY: Jone Zheng	CHECKED BY: Elvis Song	APPROVED BY: Mike Vanslambrouck



APPLICATION SPECIFICATION

Section 3: Connector Assembly E. Seating the TPA Receptacle side

With the Receptacle terminals fully installed, the TPA can be seated into its final lock position by applying an even force to both ends until it comes to a stop, with an audible click. TPA movement distance from pre-lock to final lock is 5.0 mm.

The TPA should never be fully removed!

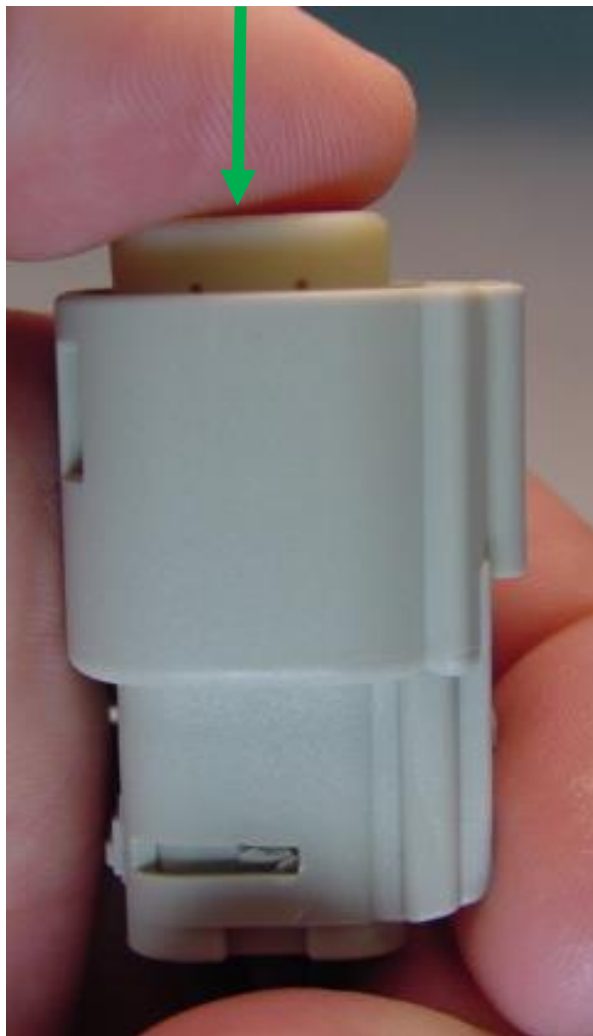

REVISION: D5	ECR/ECN INFORMATION: EC No: 673355 08/12/2021	TITLE: MX150 Application Guide	SHEET No. 30 of 76
DOCUMENT NUMBER: AS-33472-100	CREATED / REVISED BY: Jone Zheng	CHECKED BY: Elvis Song	APPROVED BY: Mike Vanslambrouck



Section 3: Connector Assembly

F. Seating the TPA Blade side

A modified process can be used for the Blade terminal. Using a pair on needle nose pliers, apply even pressure to the TPA. If the TPA resists it may be detecting a partially installed terminal. Pull the TPA back into its pre-lock position and make sure all terminals are fully installed. Upon completion, the TPA can be seated. TPA movement distance from pre-lock to final lock is 5.0mm.

The TPA should never be fully removed!

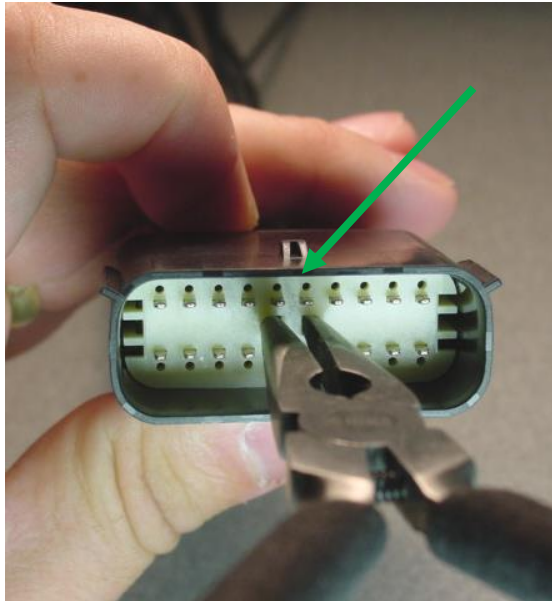

REVISION: D5	ECR/ECN INFORMATION: EC No: 673355 08/12/2021	TITLE: MX150 Application Guide	SHEET No. 31 of 76
DOCUMENT NUMBER: AS-33472-100	CREATED / REVISED BY: Jone Zheng	CHECKED BY: Elvis Song	APPROVED BY: Mike Vanslambrouck



APPLICATION SPECIFICATION

Section 3: Connector Assembly G. Harness taping recommendations

Industry standard for harness taping: Molex recommends tape should be a minimum of 30mm from the back of connector housing.

TPA must be seated before any tape is applied to the harness!
Tape must not contact the back of connector housing!

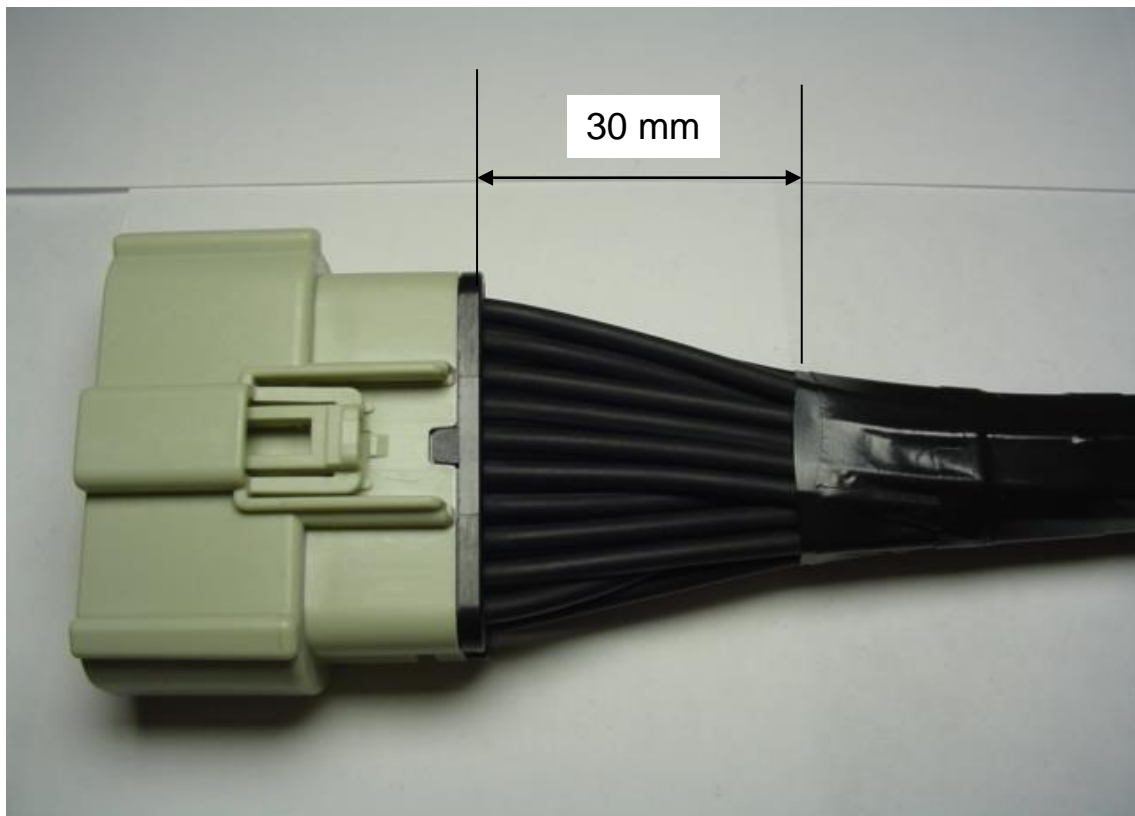

REVISION: D5	ECR/ECN INFORMATION: EC No: 673355 08/12/2021	TITLE: MX150 Application Guide	SHEET No. 32 of 76
DOCUMENT NUMBER: AS-33472-100	CREATED / REVISED BY: Jone Zheng	CHECKED BY: Elvis Song	APPROVED BY: Mike Vanslambrouck



APPLICATION SPECIFICATION

Industry standard for harness routing: Molex recommends gradual bends in wire harnesses.

**Sharp 90-degree bends in the harness should be avoided!
Excessive force, or severe bending of the wire harness may damage the harness.**

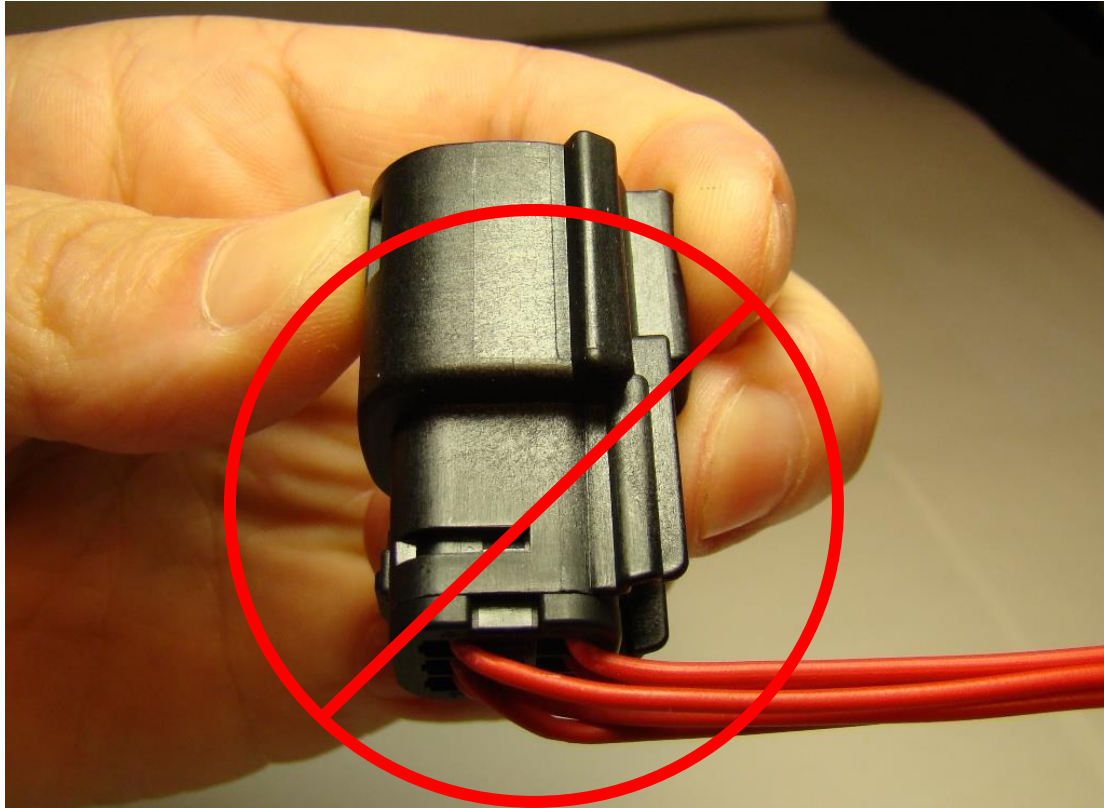

WRONG!

TO PREVENT DAMAGE TO THE CONNECTOR ASSEMBLY ANY ASSEMBLY FIXTURE OR TEST FIXTURE THAT INTERFACES WITH THE INTERIOR OF THE CONNECTOR MUST COMPLY WITH EITHER THE USCAR INTERFACE OR THE MOLEX DEFINED INTERFACE. SEE MOLEX DRAWING FOR INTERFACE DEFINITION

REVISION: D5	ECR/ECN INFORMATION: EC No: 673355 08/12/2021	TITLE: MX150 Application Guide	SHEET No. 33 of 76
DOCUMENT NUMBER: AS-33472-100	CREATED / REVISED BY: Jone Zheng	CHECKED BY: Elvis Song	APPROVED BY: Mike Vanslambrouck



APPLICATION SPECIFICATION

Section 4: Connector Mating

A. Connector mating

Note and align connector keying features, from connector to connector. Begin mating procedure by sliding the two connectors together, press firmly until you hear an audible click from the primary latch.



Keying features

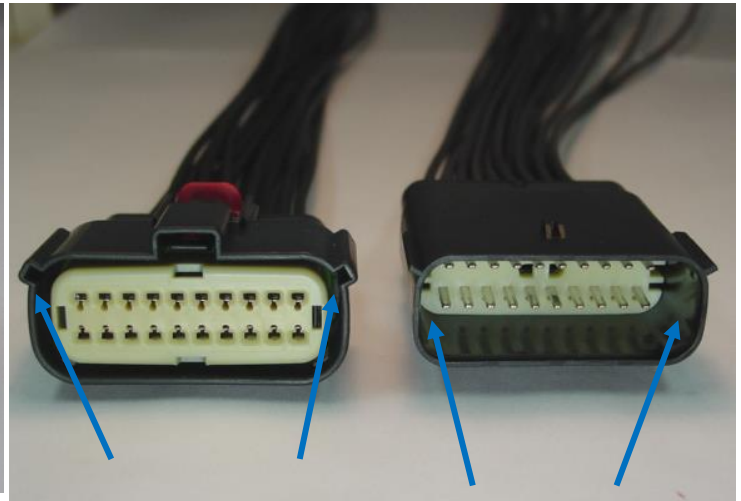

Keying Features

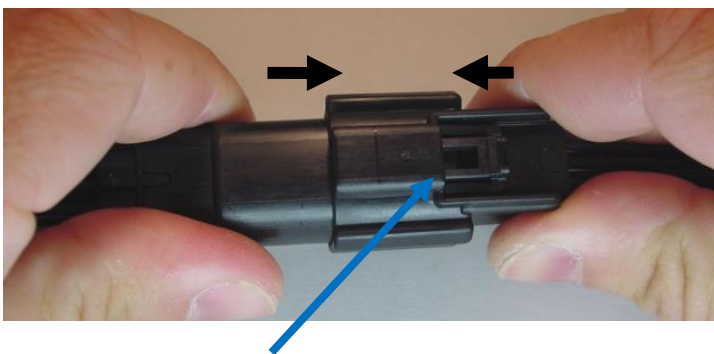

Primary Latch

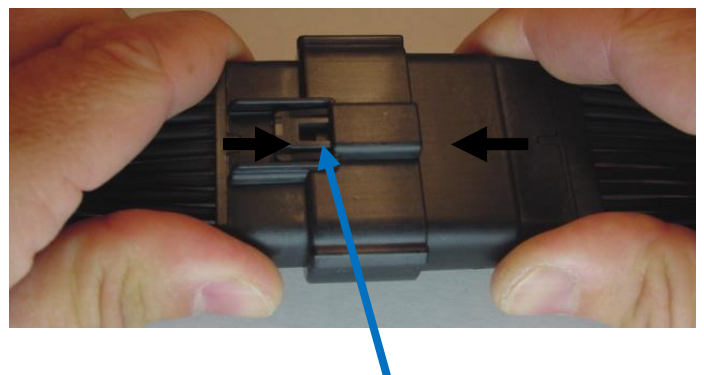

Primary Latch

REVISION: D5	ECR/ECN INFORMATION: EC No: 673355 08/12/2021	TITLE: MX150 Application Guide	SHEET No. 34 of 76
DOCUMENT NUMBER: AS-33472-100	CREATED / REVISED BY: Jone Zheng	CHECKED BY: Elvis Song	APPROVED BY: Mike Vanslambrouck



APPLICATION SPECIFICATION

Section 4: Connector Mating B. Connector mating (continued)

Once together the final step will be locking the CPA. Simply press in to the center of the connector, until you see/feel positive engagement.

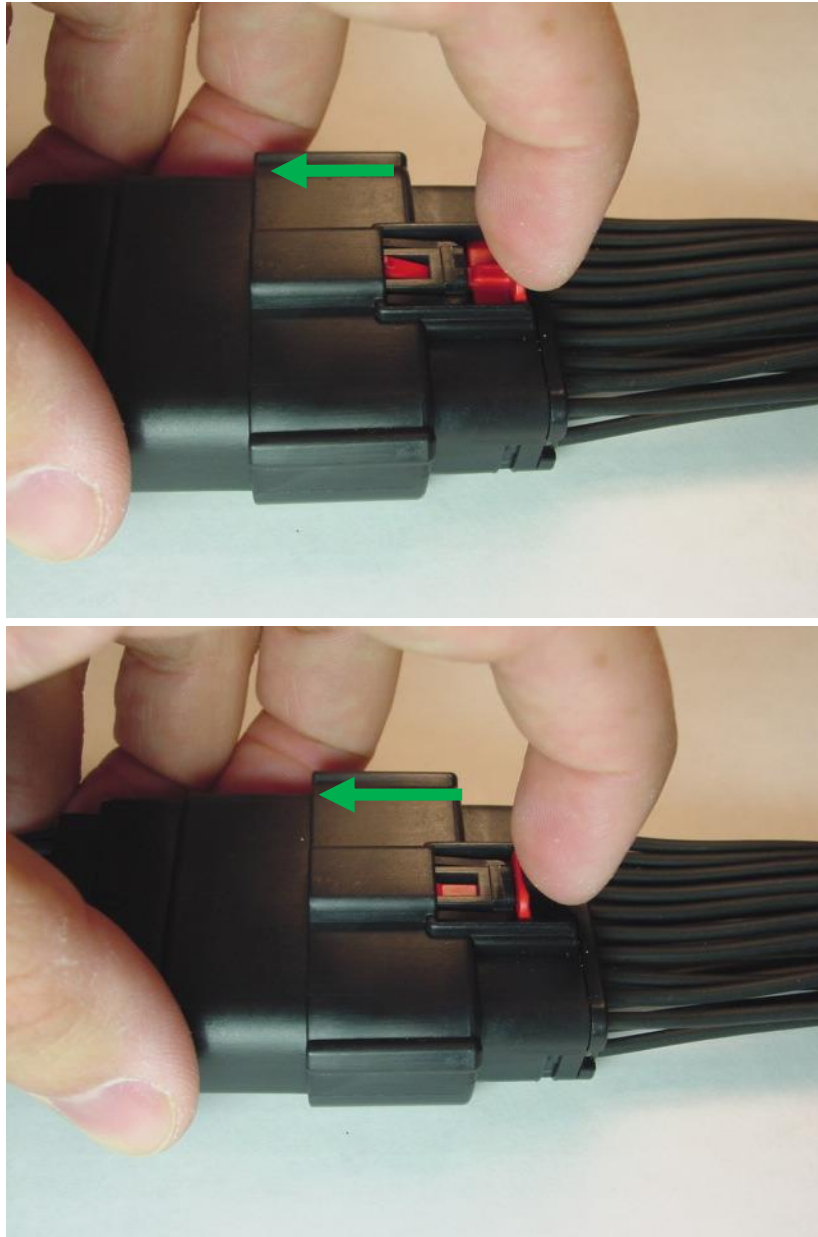

REVISION: D5	ECR/ECN INFORMATION: EC No: 673355 08/12/2021	TITLE: MX150 Application Guide	SHEET No. 35 of 76
DOCUMENT NUMBER: AS-33472-100	CREATED / REVISED BY: Jone Zheng	CHECKED BY: Elvis Song	APPROVED BY: Mike Vanslambrouck



APPLICATION SPECIFICATION

Section 5: Service Instructions

A. Un-mate procedure

To un-mate the connectors, pull back on the CPA (step 1, and step 2). Push connector together to unload the latch system. Then depress the latch with your thumb (step 3). Continue to depress the latch, and gently pull apart connector assemblies (step 4).

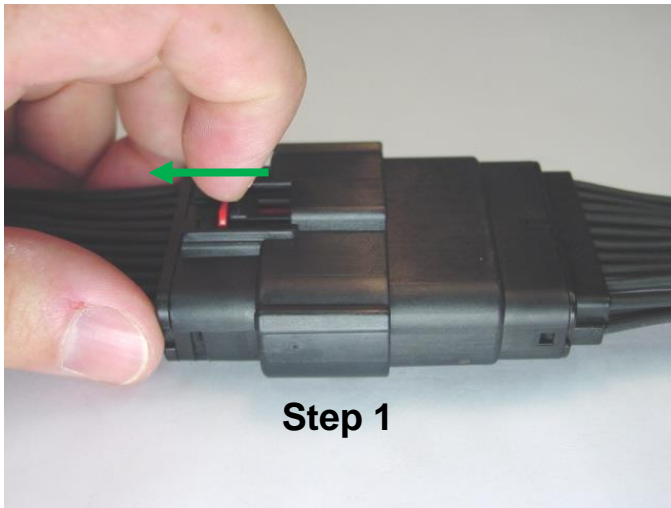

Step 1

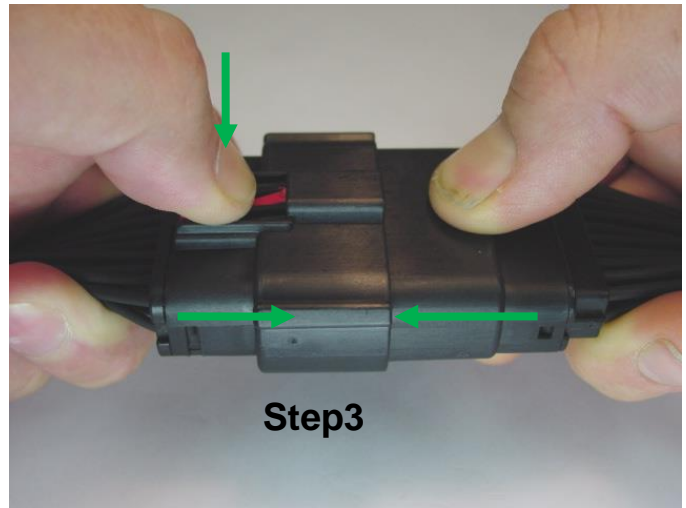

Step 3

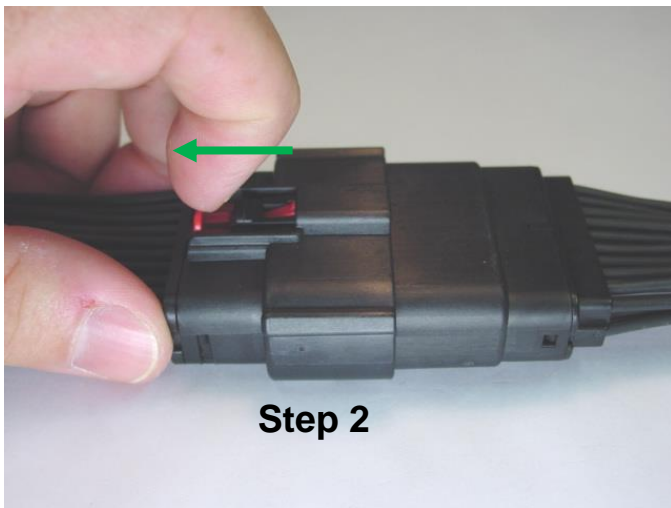

Step 2

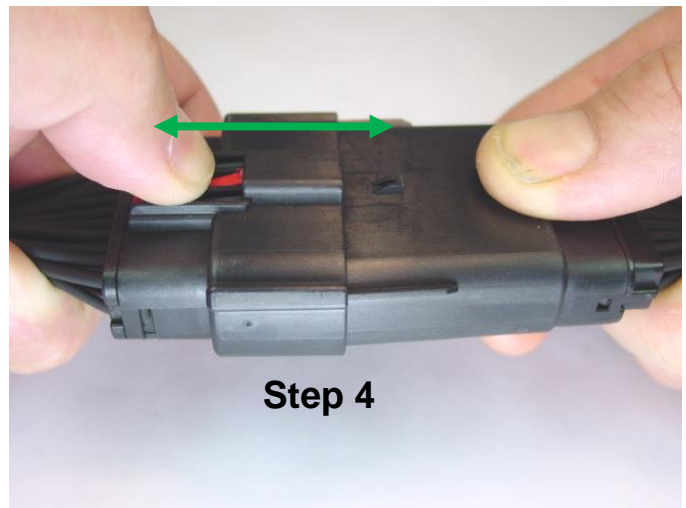

Step 4

REVISION: D5	ECR/ECN INFORMATION: EC No: 673355 08/12/2021	TITLE: MX150 Application Guide	SHEET No. 36 of 76
DOCUMENT NUMBER: AS-33472-100	CREATED / REVISED BY: Jone Zheng	CHECKED BY: Elvis Song	APPROVED BY: Mike Vanslambrouck



APPLICATION SPECIFICATION

Section 5: Service Instructions

B. TPA servicing Blade side

***The TPA should never be fully removed from the connector housing!
Excessive force may damage the TPA!***

Step 1: Insert a small pair of needle nose pliers to the designated grab point

Step 2: Pull back 5.0 mm, gently, until the TPA reaches pre-lock position.

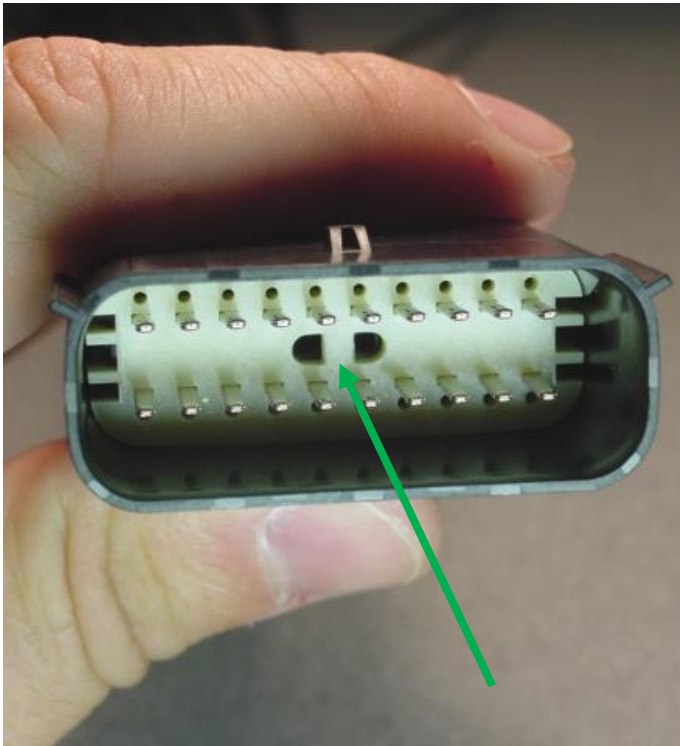

Grab point

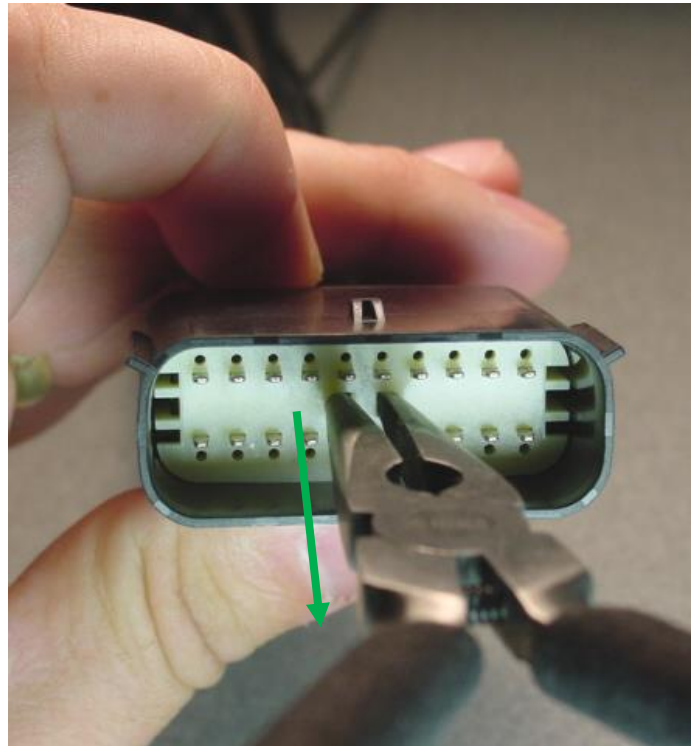

**Pull back gently
Approximately 5.0mm**

REVISION: D5	ECR/ECN INFORMATION: EC No: 673355 08/12/2021	TITLE: MX150 Application Guide	SHEET No. 37 of 76
DOCUMENT NUMBER: AS-33472-100	CREATED / REVISED BY: Jone Zheng	CHECKED BY: Elvis Song	APPROVED BY: Mike Vanslambrouck



APPLICATION SPECIFICATION

Section 5: Service Instructions

C. TPA servicing Receptacle side

Step 1: Insert a small screwdriver (2.4 mm – 3.5 mm) into the designated pry point
 Step 2: Using the housing as a pivot point gently pry out on the TPA, until it reaches pre-lock position (5.0 mm, travel)

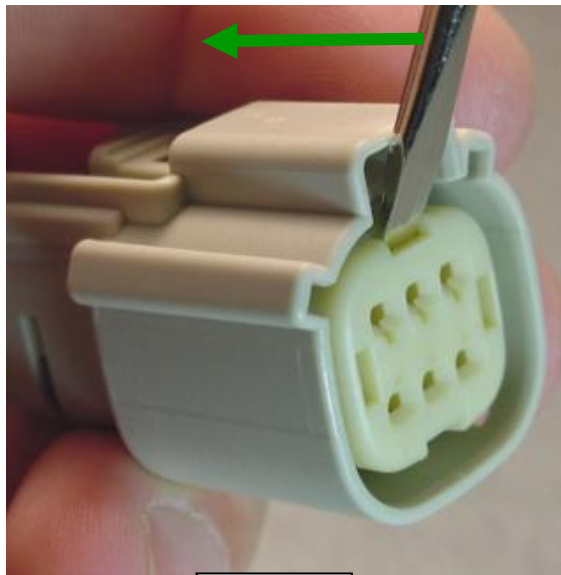
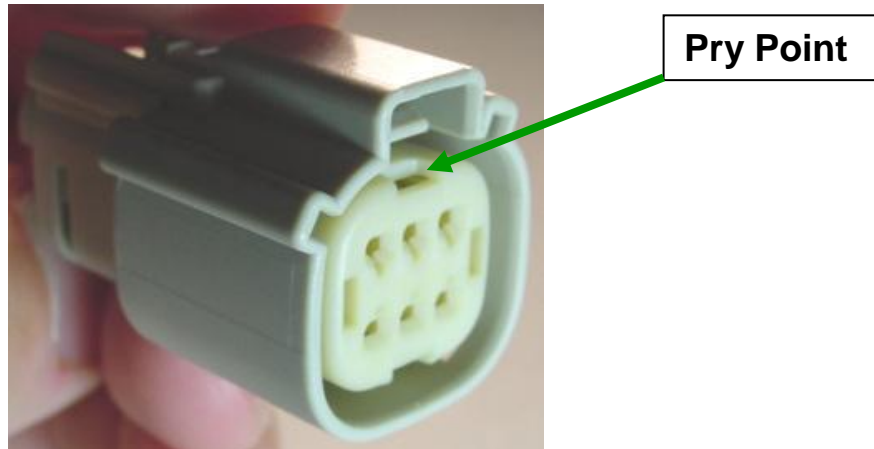

Step 1

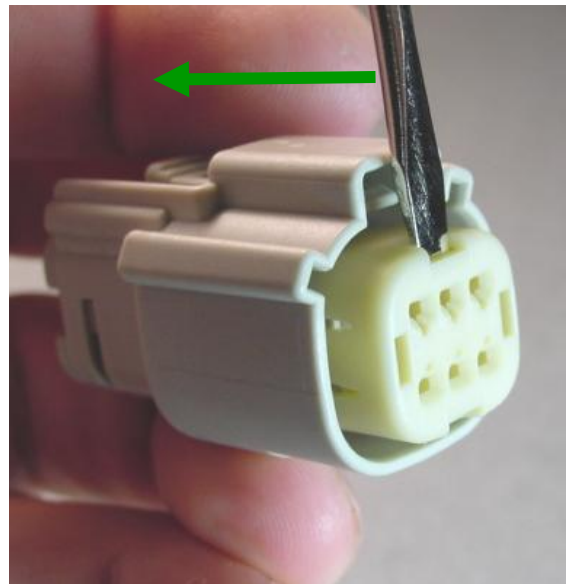

Step 2

The TPA should never be fully removed from the connector housing! Excessive force may damage

REVISION: D5	ECR/ECN INFORMATION: EC No: 673355 08/12/2021	TITLE: MX150 Application Guide	SHEET No. 38 of 76
DOCUMENT NUMBER: AS-33472-100	CREATED / REVISED BY: Jone Zheng	CHECKED BY: Elvis Song	APPROVED BY: Mike Vanslambrouck



APPLICATION SPECIFICATION

Section 5: Service Instructions

D. 1.50 mm terminal removal

Step 1: Using the 1.50 mm service tool #63813-1500, insert the tip into the terminal service hole adjacent to the terminal to be serviced.

Step 2: Push straight down gently and apply pressure to release locking finger. This motion will release the locking finger, "picking" is not required. Cavity plugs are removed in the same manner.

Do not apply any lateral force, this may damage the tool, or the locking finger!
Do not use excessive force, excessive force can damage the lock finger!
Do not insert the service tool at an angle, this may cause damage to the terminal!

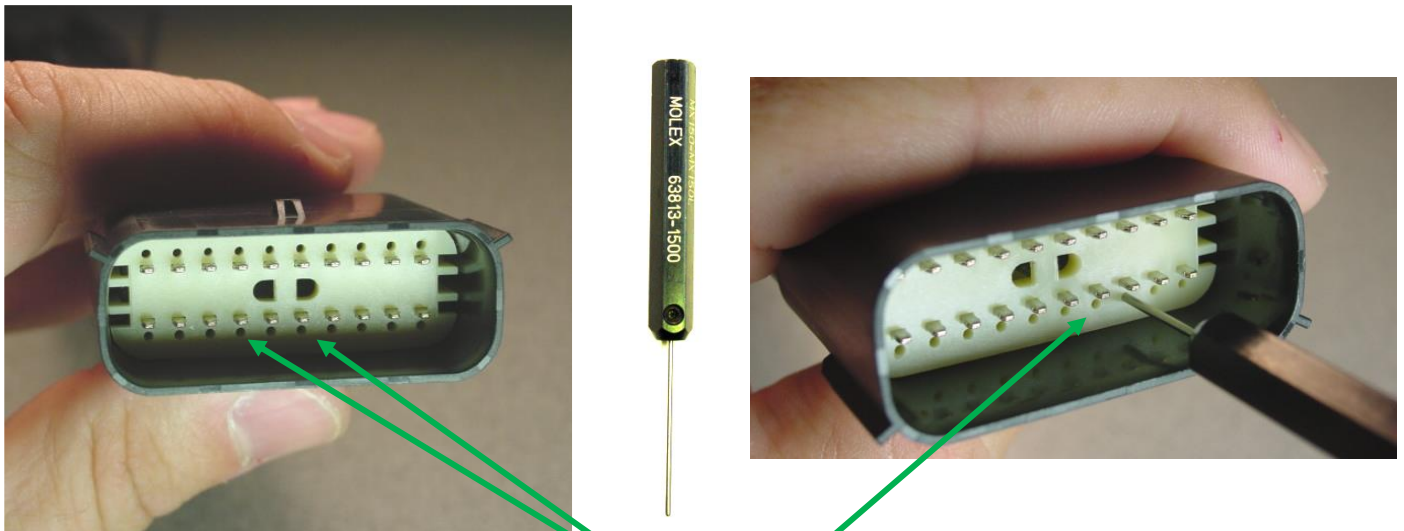

Service Ports

Service tool must be 90° to the connector face!

REVISION: D5	ECR/ECN INFORMATION: EC No: 673355 08/12/2021	TITLE: MX150 Application Guide	SHEET No. 39 of 76
DOCUMENT NUMBER: AS-33472-100	CREATED / REVISED BY: Jone Zheng	CHECKED BY: Elvis Song	APPROVED BY: Mike Vanslambrouck



APPLICATION SPECIFICATION

Section 5: Service Instructions E. Terminal removal (continued)

Step 3: Once the Lock finger is disengaged, gently pull on the wire to release the terminal.

If the terminal resists, the service tool may not be fully engaged. Push the service tool straight into the service opening to ensure that it has fully disengaged the locking finger.

Do not insert the service tool into the terminal opening!

Do not use excessive force, excessive force can damage the lock finger!

Do not insert the service tool at an angle, this may cause damage to the terminal!

Do not apply any lateral force, this may damage the terminal or lock finger!

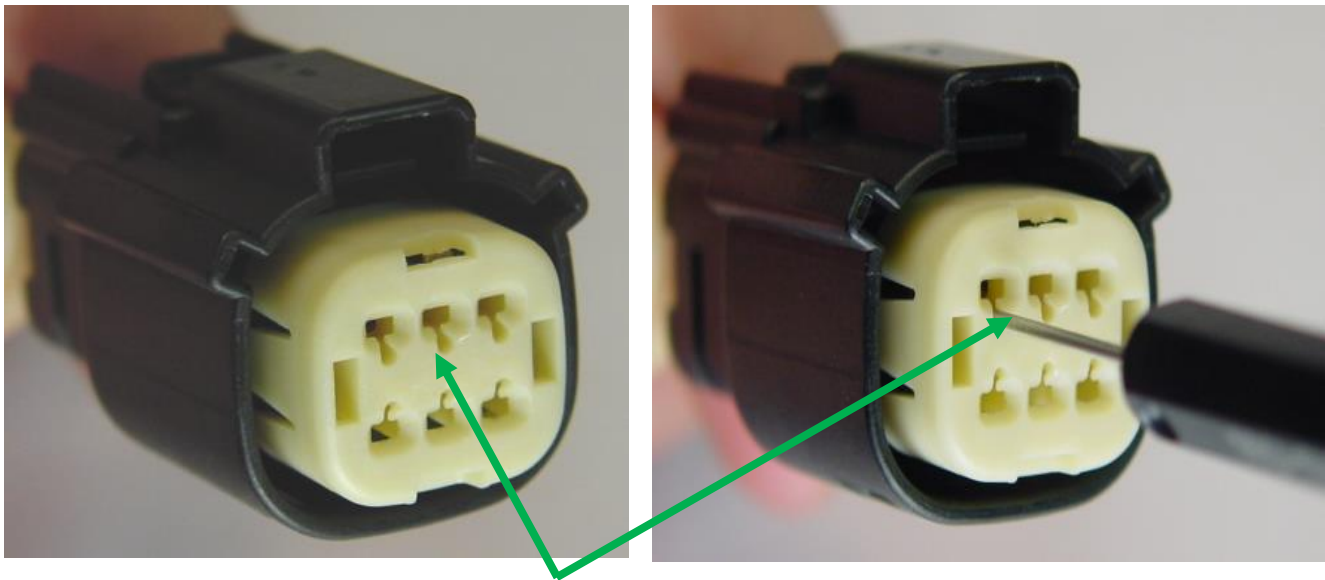

Service Ports

Service tool must be 90° to the connector face!

REVISION: D5	ECR/ECN INFORMATION: EC No: 673355 08/12/2021	TITLE: MX150 Application Guide	SHEET No. 40 of 76
DOCUMENT NUMBER: AS-33472-100	CREATED / REVISED BY: Jone Zheng	CHECKED BY: Elvis Song	APPROVED BY: Mike Vanslambrouck



APPLICATION SPECIFICATION

Section 5: Service Instructions

Service tool must be 90° to the connector face!



**CORRECT!
YES!**

**WRONG!
NO!**

REVISION: D5	ECR/ECN INFORMATION: EC No: 673355 08/12/2021	TITLE: MX150 Application Guide	SHEET No. 41 of 76
DOCUMENT NUMBER: AS-33472-100	CREATED / REVISED BY: Jone Zheng	CHECKED BY: Elvis Song	APPROVED BY: Mike Vanslambrouck



APPLICATION SPECIFICATION

Section 5: Service Instructions F. Terminal removal (continued)

1

2

3

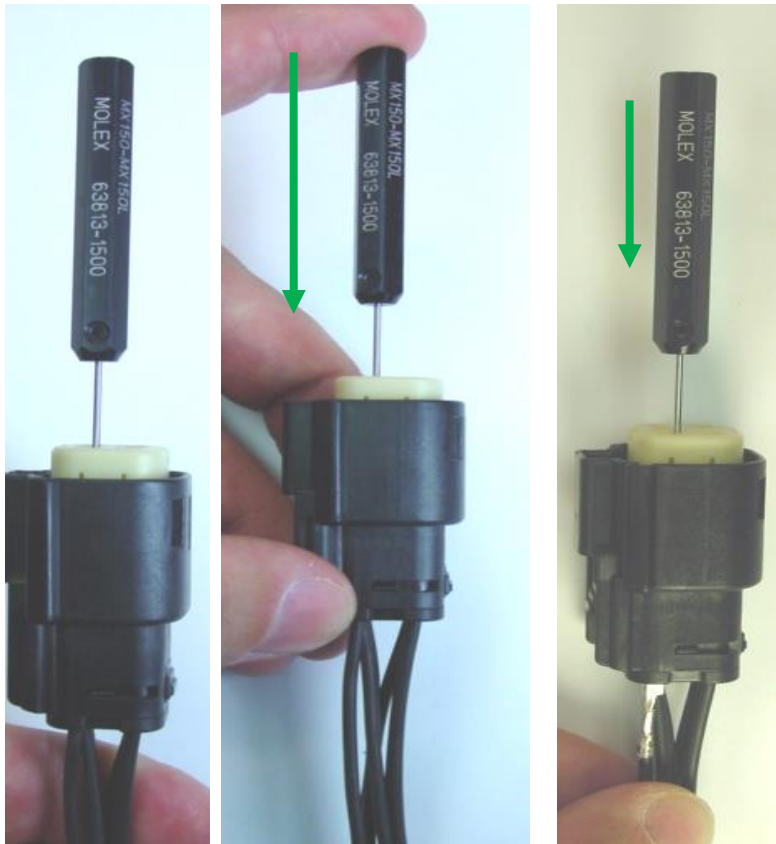

Service tool must be 90° to the connector face!

REVISION: D5	ECR/ECN INFORMATION: EC No: 673355 08/12/2021	TITLE: MX150 Application Guide	SHEET No. 42 of 76
DOCUMENT NUMBER: AS-33472-100	CREATED / REVISED BY: Jone Zheng	CHECKED BY: Elvis Song	APPROVED BY: Mike Vanslambrouck



APPLICATION SPECIFICATION

Section 5: Service Instructions

G. Service tools

If the 1.50 mm terminal needs to be replaced, a new one can be hand crimped using the Molex Crimp tool # 63811-5900(Female)16,14 AWG – 1.3-2.00mm², and # 63811-2600 (Male)22,20,18AWG – 0.35, 0.50, 0.75mm² Shown in (Fig.22a) #63811-2400(Male)16,14AWG – 1.5, 2.00mm² #63811-6000(Female)22,20,18AWG – 0.35, 0.50, 0.75mm².
Also shown Molex Terminal removal tool # 63813-1500

Fig. 22a



REVISION: D5	ECR/ECN INFORMATION: EC No: 673355 08/12/2021	TITLE: MX150 Application Guide	SHEET No. 43 of 76
DOCUMENT NUMBER: AS-33472-100	CREATED / REVISED BY: Jone Zheng	CHECKED BY: Elvis Song	APPROVED BY: Mike Vanslambrouck



APPLICATION SPECIFICATION

Section 6: Electrical Continuity Checking

Fixtures that may come in contact with the perimeter seal must have the interface lead-in geometry as defined on the USCAR and/or Molex interface drawing

Fixtures used for continuity testing must meet the row and pitch dimensions as identified in Section 6.

Fixtures outside these requirements could result in damage to the connector and/or terminal.

Probe pin recommendations:

1. When testing the connector for continuity it is imperative that you do not damage the terminals!
2. Pogo pins should be checked for damage or sticking several times a shift. This should assure containment if an issue is found.
3. First a visual inspection of all the pins for damage should be performed.
4. Next a testing block should be used to depress all the pogo pins up into the barrel. If there is a bent or sticking pin, it should remain stuck in the barrel of the pogo pin. A damaged or stuck pin should be replaced before any additional testing is performed.

Probing damage can occur:

1. If a sharp ended probe is inserted into the contact of the terminal it may damage the plating and increase contact resistance
2. If an oversized diameter probe is inserted into the terminal, this will overstress the beam in the terminal. This will create an environment for intermittent connections, and increased contact resistance.
3. If a probe is inserted into the connector on an angle or off center it may damage the terminal, and or the connector.

REVISION: D5	ECR/ECN INFORMATION: EC No: 673355 08/12/2021	TITLE: MX150 Application Guide	SHEET No. 44 of 76
DOCUMENT NUMBER: AS-33472-100	CREATED / REVISED BY: Jone Zheng	CHECKED BY: Elvis Song	APPROVED BY: Mike Vanslambrouck



APPLICATION SPECIFICATION

Section 6: Electrical Continuity Checking

Preferred method of probing receptacle

Fixtures used for continuity testing must meet the row and pitch dimensions as identified in Section 6. Fixtures outside these requirements could result in damage to the connector and/or terminal.

When TPA allows access to the box, probe using this method. Check electrical continuity on the terminal by inserting probe pin between terminal access hole and terminal opening with a 0.50 mm probe. Shown below are pictures of MX150 Sealed connector. Unsealed connectors must be probed at the same location (between access hole and terminal opening)

Molex Receptacle connector

View of probe pin female terminal

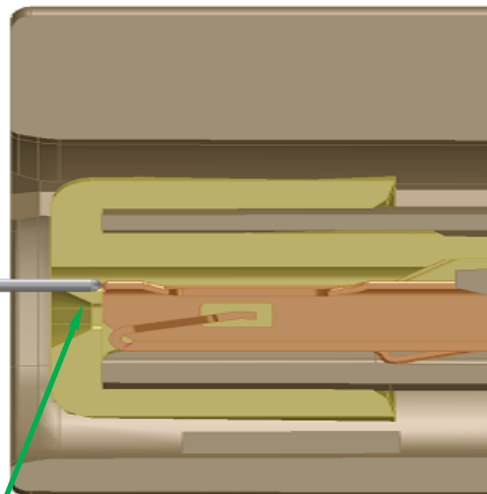
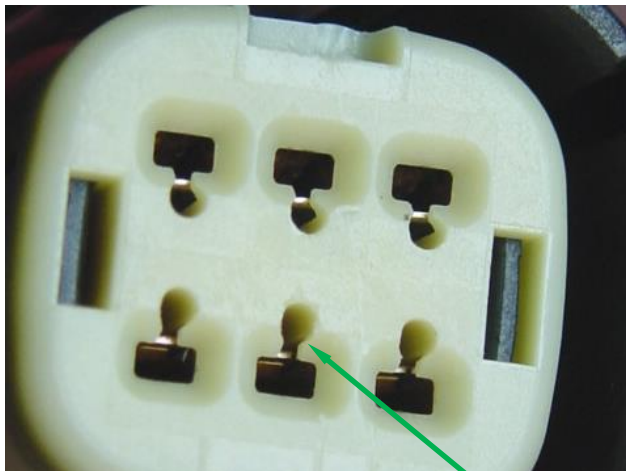

**Must use this pin
or damage will
occur!**

(0.50) mm probe

REVISION: D5	ECR/ECN INFORMATION: EC No: 673355 08/12/2021	TITLE: MX150 Application Guide	SHEET No. 45 of 76
DOCUMENT NUMBER: AS-33472-100	CREATED / REVISED BY: Jone Zheng	CHECKED BY: Elvis Song	APPROVED BY: Mike Vanslambrouck



APPLICATION SPECIFICATION

Section 6: Electrical Continuity Checking

Preferred method of probing receptacle

Probe pin details

Manufacturer: Everett Charles technologies

Preferred probe number: POGO-72J-4

Pin length 0.330" (8.38 mm)

Pin diameter: (0.50 mm)

Tip shape: Spherical

Must use this pin or damage will occur!

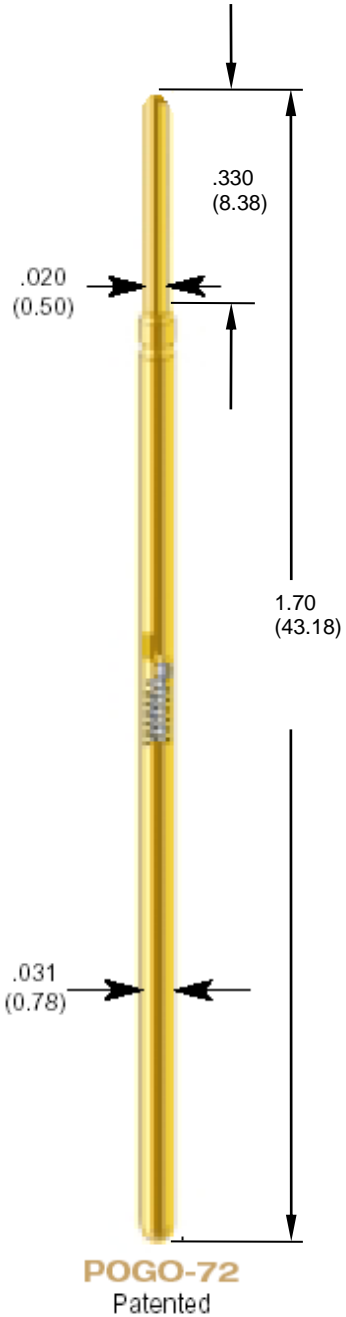

POGO-72J
POGO-72J-S

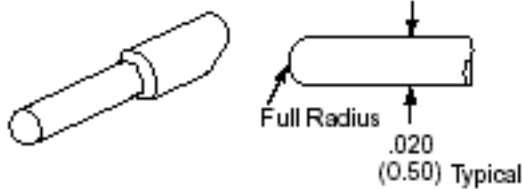

Dimensions shown are in (mm)

REVISION: D5	ECR/ECN INFORMATION: EC No: 673355 08/12/2021	TITLE: MX150 Application Guide	SHEET No. 46 of 76
DOCUMENT NUMBER: AS-33472-100	CREATED / REVISED BY: Jone Zheng	CHECKED BY: Elvis Song	APPROVED BY: Mike Vanslambrouck



APPLICATION SPECIFICATION

Section 6: Electrical Continuity Checking

B. Alternative method of probing receptacle

Fixtures used for continuity testing must meet the row and pitch dimensions as identified in Section 6. Fixtures outside these requirements could result in damage to the connector and/or terminal.

When TPA does not allow access to the box you must probe down the throat using this method.

Shown below are pictures of MX150 Sealed connector. Unsealed connectors must be probed at the same location (center of receptacle TPA opening)

Check electrical continuity on the terminal by inserting probe pin down the center of receptacle TPA opening

Molex Receptacle connector

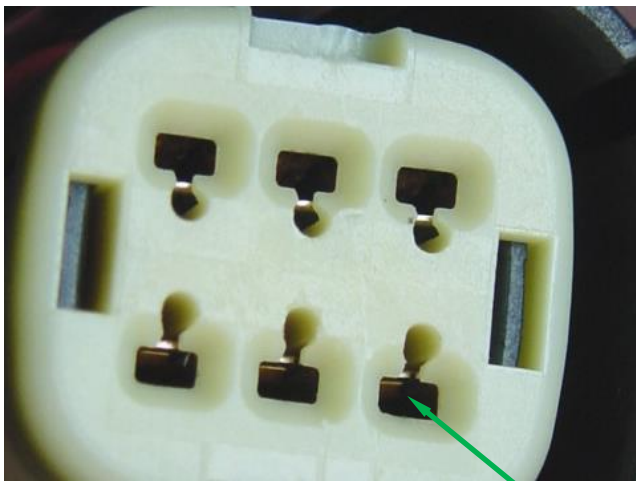

View of probe pin female terminal

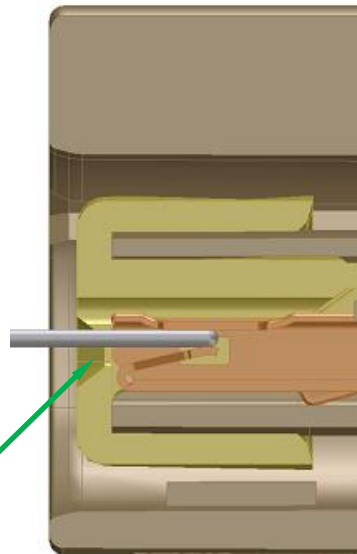

(0.64) mm probe

Must use this pin or damage will occur!

REVISION: D5	ECR/ECN INFORMATION: EC No: 673355 08/12/2021	TITLE: MX150 Application Guide	SHEET No. 47 of 76
DOCUMENT NUMBER: AS-33472-100	CREATED / REVISED BY: Jone Zheng	CHECKED BY: Elvis Song	APPROVED BY: Mike Vanslambrouck



APPLICATION SPECIFICATION

Section 6: Electrical Continuity Checking Alternative

Probe pin details

Manufacturer: Everett Charles Technologies

Alternative probe number: POGO-1-J-4

Pin length 0.330" (8.38mm)

Pin diameter: (0.64 mm)

Tip shape: Spherical

Must use this pin or damage will occur!



POGO-1J
POGO-1J-S

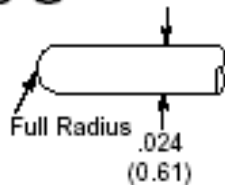

Dimensions shown are in (mm)

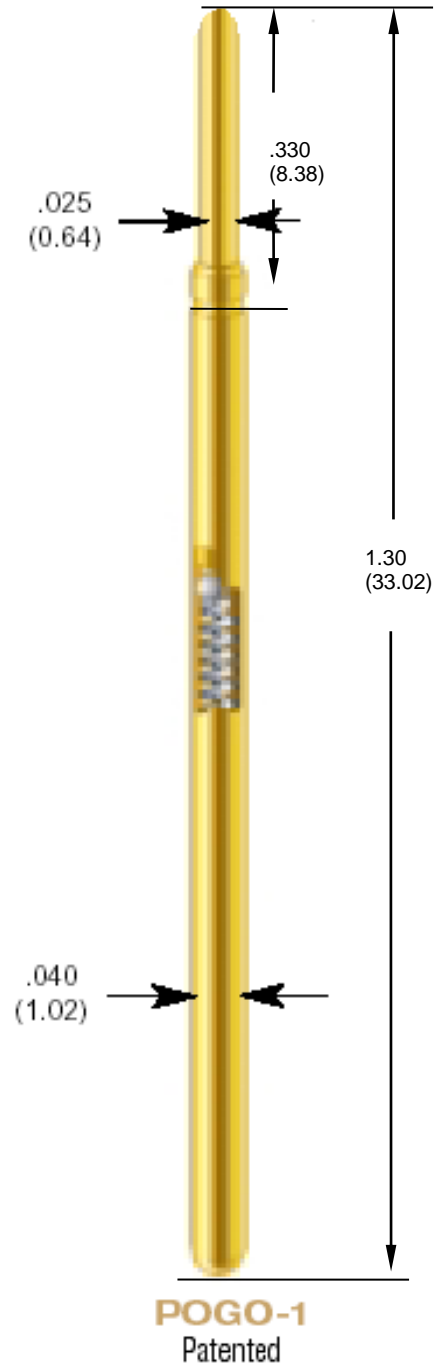

REVISION: D5	ECR/ECN INFORMATION: EC No: 673355 08/12/2021	TITLE: MX150 Application Guide	SHEET No. 48 of 76
DOCUMENT NUMBER: AS-33472-100	CREATED / REVISED BY: Jone Zheng	CHECKED BY: Elvis Song	APPROVED BY: Mike Vanslambrouck



APPLICATION SPECIFICATION

Section 6: Electrical Continuity Checking - Blade

Probe pin details

Manufacturer: Lone Star Industrial
 Recommended Probe number: LS054MR-849-4.6
 Alternative Probe Number: LS054MR-846-4.6
 Pin length .335" (8.51mm)
 Pin diameter: .060" (1.52 mm)
 Recommended Tip shape: Serrated
 Alternative Tip shape: Large Concave

Recommended Pin Tip



Alternative Pin Tip



Dimensions shown are in (mm)

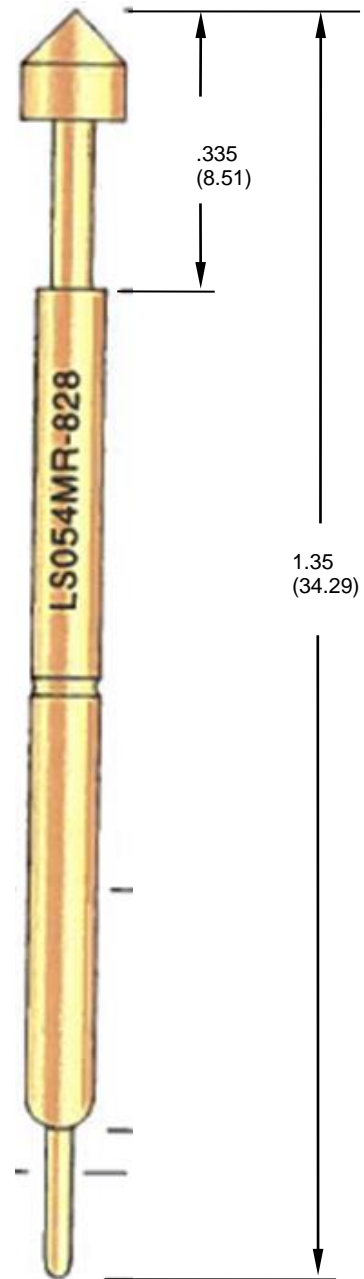

REVISION: D5	ECR/ECN INFORMATION: EC No: 673355 08/12/2021	TITLE: MX150 Application Guide	SHEET No. 49 of 76
DOCUMENT NUMBER: AS-33472-100	CREATED / REVISED BY: Jone Zheng	CHECKED BY: Elvis Song	APPROVED BY: Mike Vanslambrouck



APPLICATION SPECIFICATION

Section 6: Electrical Continuity Checking

MX150 16 WAY HYBRID RECEPTACLE PREFERRED PROBING

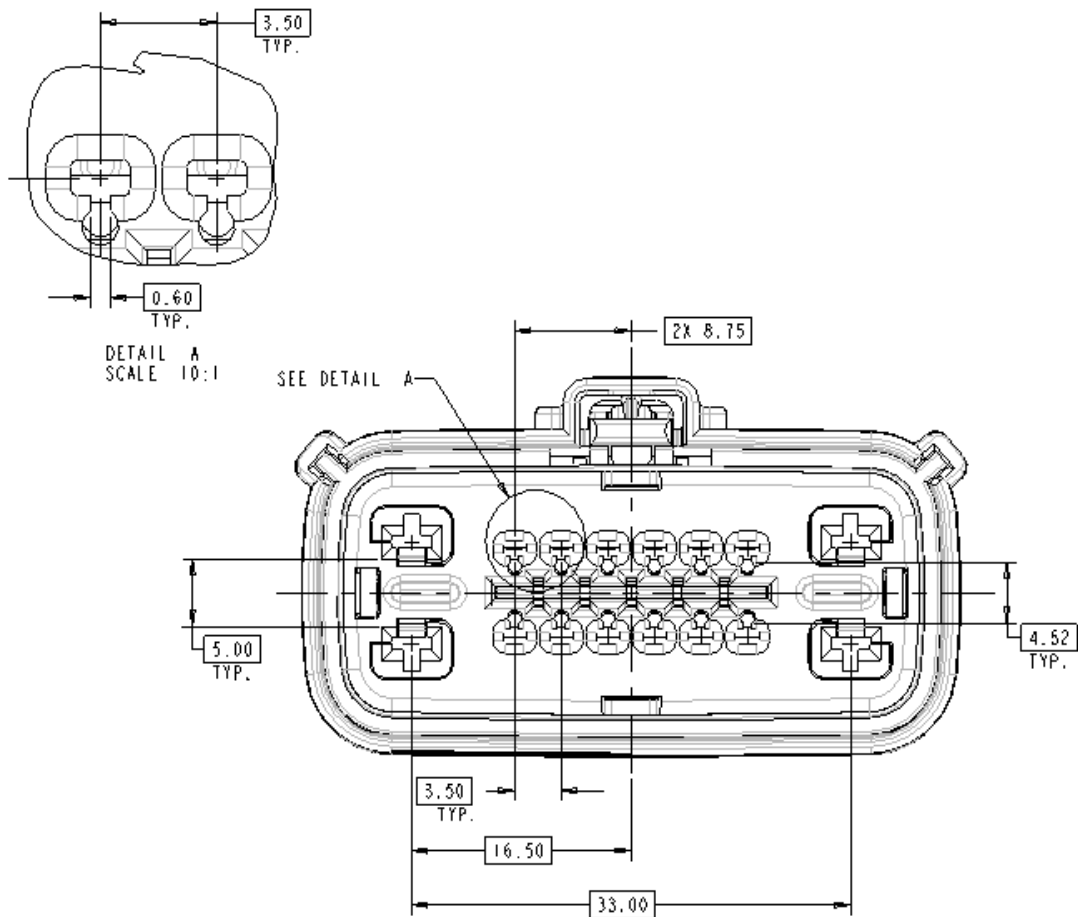

REVISION: D5	ECR/ECN INFORMATION: EC No: 673355 08/12/2021	TITLE: MX150 Application Guide	SHEET No. 50 of 76
DOCUMENT NUMBER: AS-33472-100	CREATED / REVISED BY: Jone Zheng	CHECKED BY: Elvis Song	APPROVED BY: Mike Vanslambrouck



APPLICATION SPECIFICATION

Section 6: Electrical Continuity Checking

MX150 16 WAY RECEPTACLE PREFERRED PROBING

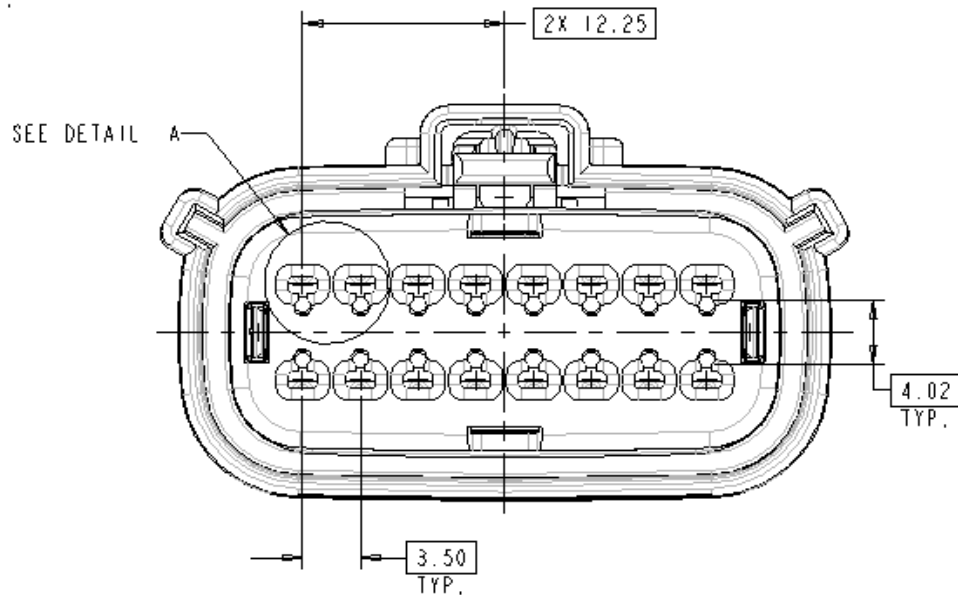
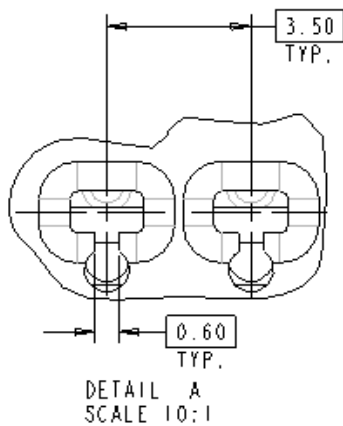

REVISION: D5	ECR/ECN INFORMATION: EC No: 673355 08/12/2021	TITLE: MX150 Application Guide	SHEET No. 51 of 76
DOCUMENT NUMBER: AS-33472-100	CREATED / REVISED BY: Jone Zheng	CHECKED BY: Elvis Song	APPROVED BY: Mike Vanslambrouck



APPLICATION SPECIFICATION

Section 6: Electrical Continuity Checking

MX150 6 WAY RECEPTACLE PREFERRED PROBING

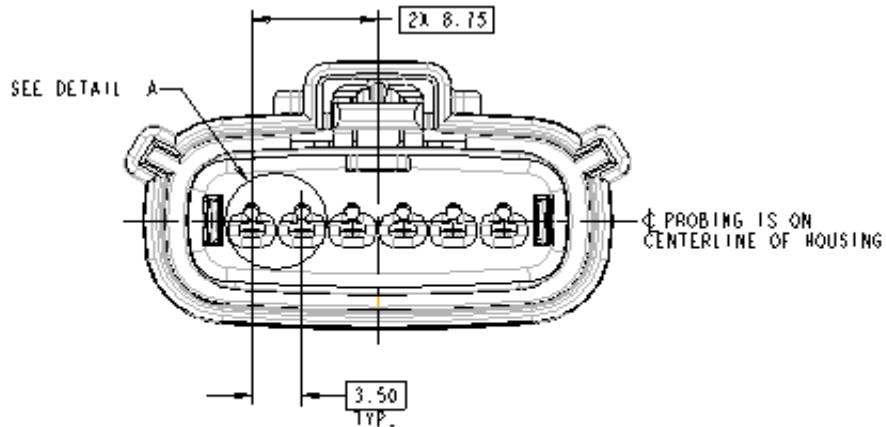
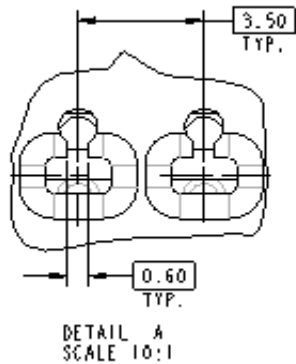

REVISION: D5	ECR/ECN INFORMATION: EC No: 673355 08/12/2021	TITLE: MX150 Application Guide	SHEET No. 52 of 76
DOCUMENT NUMBER: AS-33472-100	CREATED / REVISED BY: Jone Zheng	CHECKED BY: Elvis Song	APPROVED BY: Mike Vanslambrouck



APPLICATION SPECIFICATION

Section 6: Electrical Continuity Checking

MX150 16 WAY RECEPTACLE ALTERNATE PROBING

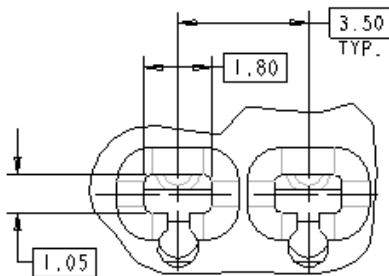

DETAIL A
SCALE 10:1

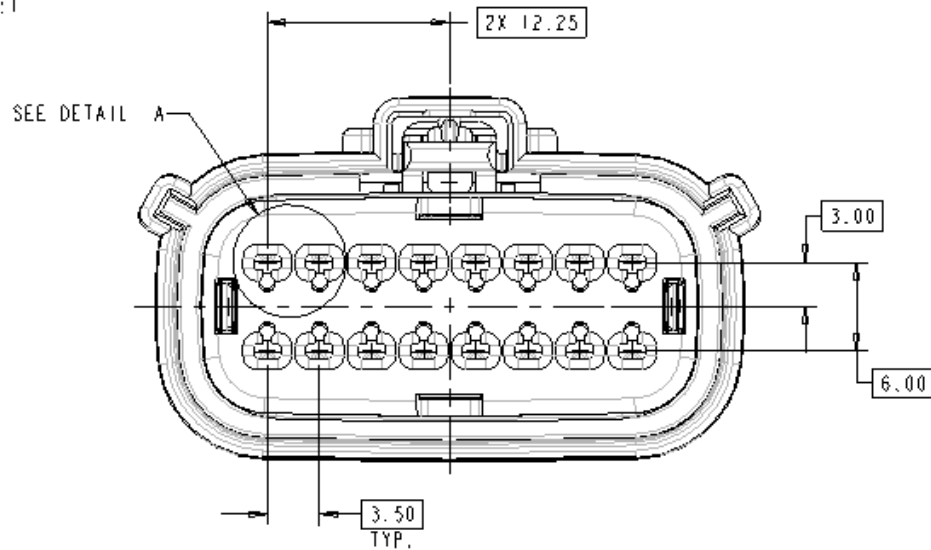

REVISION: D5	ECR/ECN INFORMATION: EC No: 673355 08/12/2021	TITLE: MX150 Application Guide	SHEET No. 53 of 76
DOCUMENT NUMBER: AS-33472-100	CREATED / REVISED BY: Jone Zheng	CHECKED BY: Elvis Song	APPROVED BY: Mike Vanslambrouck



APPLICATION SPECIFICATION

Section 6: Electrical Continuity Checking

MX150 16 WAY HYBRID RECEPTACLE ALTERNATE PROBING

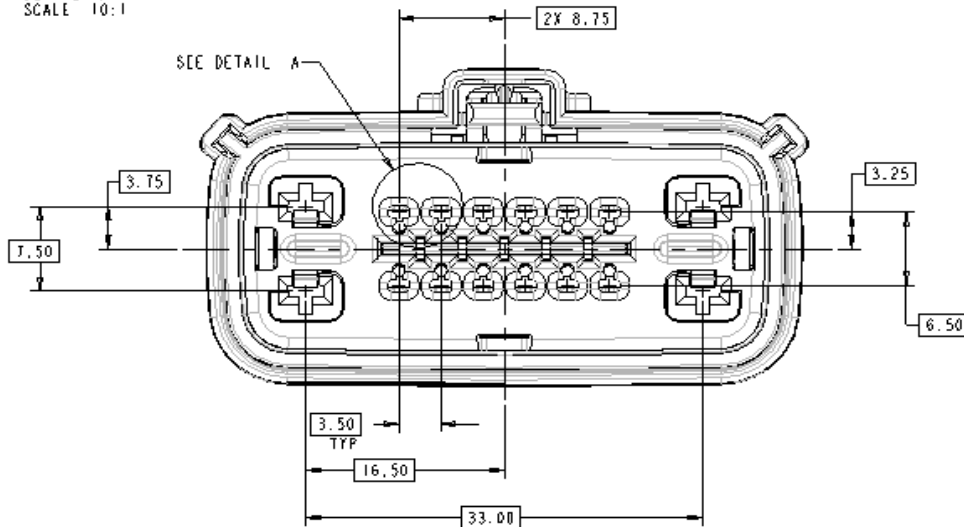
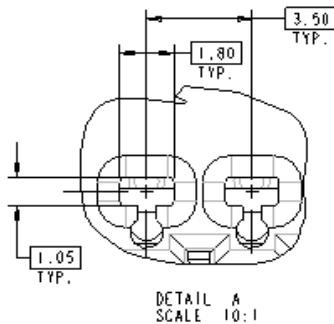

REVISION: D5	ECR/ECN INFORMATION: EC No: 673355 08/12/2021	TITLE: MX150 Application Guide	SHEET No. 54 of 76
DOCUMENT NUMBER: AS-33472-100	CREATED / REVISED BY: Jone Zheng	CHECKED BY: Elvis Song	APPROVED BY: Mike Vanslambrouck



APPLICATION SPECIFICATION

Section 6: Electrical Continuity Checking

MX150 6 WAY RECEPTACLE ALTERNATE PROBING

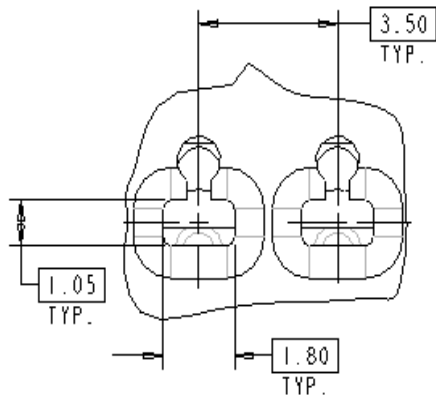

DETAIL A
SCALE 10:1

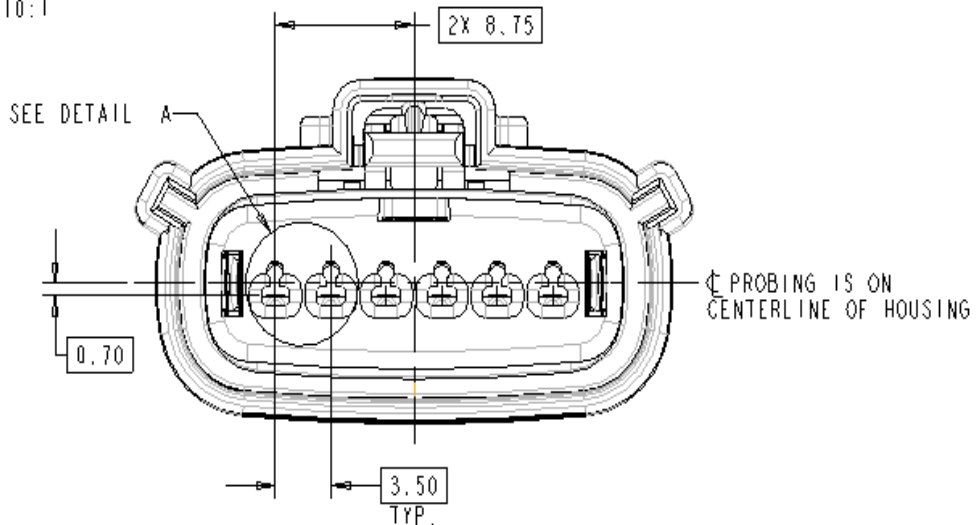

REVISION: D5	ECR/ECN INFORMATION: EC No: 673355 08/12/2021	TITLE: MX150 Application Guide	SHEET No. 55 of 76
DOCUMENT NUMBER: AS-33472-100	CREATED / REVISED BY: Jone Zheng	CHECKED BY: Elvis Song	APPROVED BY: Mike Vanslambrouck



APPLICATION SPECIFICATION

Section 6: Electrical Continuity Checking

MX150 16 WAY HYBRID BLADE

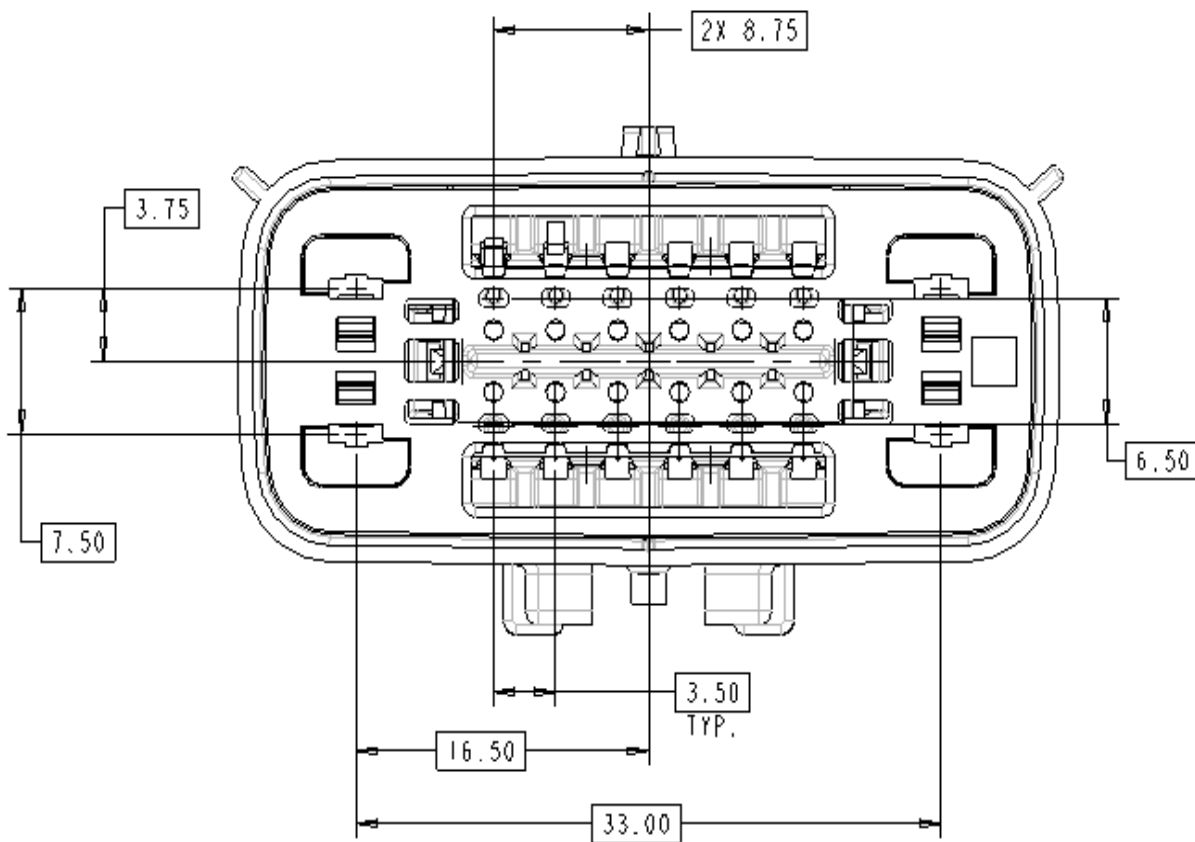

REVISION: D5	ECR/ECN INFORMATION: EC No: 673355 08/12/2021	TITLE: MX150 Application Guide	SHEET No. 56 of 76
DOCUMENT NUMBER: AS-33472-100	CREATED / REVISED BY: Jone Zheng	CHECKED BY: Elvis Song	APPROVED BY: Mike Vanslambrouck



APPLICATION SPECIFICATION

Section 6: Electrical Continuity Checking

MX150 16 WAY BLADE

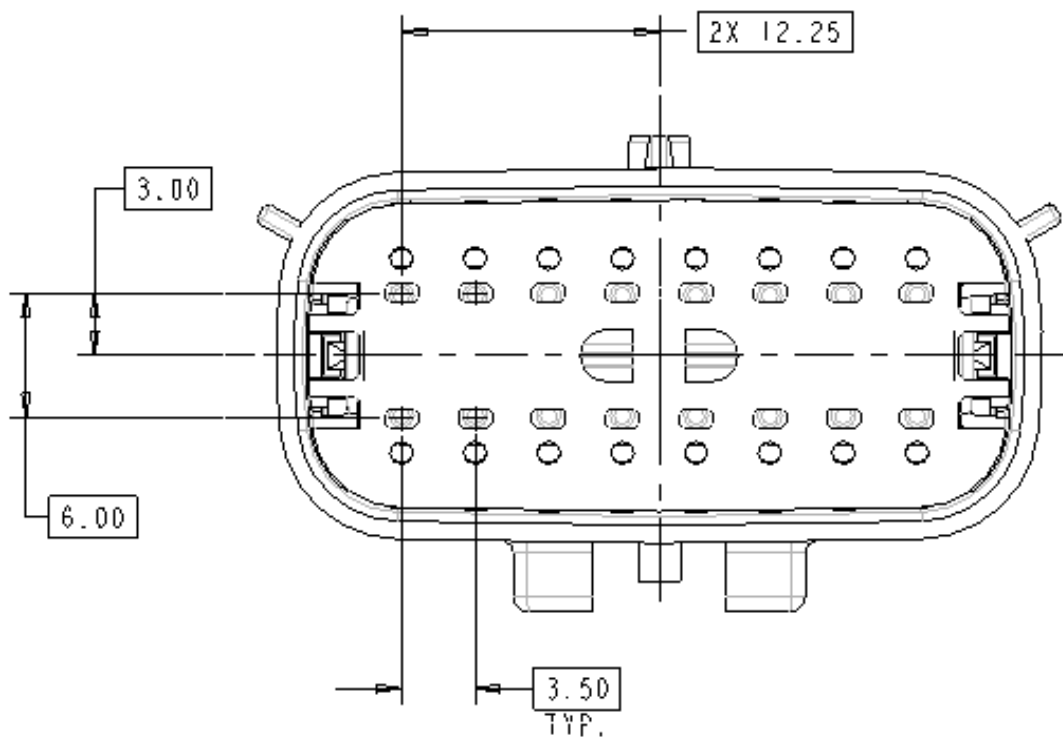

REVISION: D5	ECR/ECN INFORMATION: EC No: 673355 08/12/2021	TITLE: MX150 Application Guide	SHEET No. 57 of 76
DOCUMENT NUMBER: AS-33472-100	CREATED / REVISED BY: Jone Zheng	CHECKED BY: Elvis Song	APPROVED BY: Mike Vanslambrouck



APPLICATION SPECIFICATION

Section 6: Electrical Continuity Checking

MX150 6 WAY BLADE

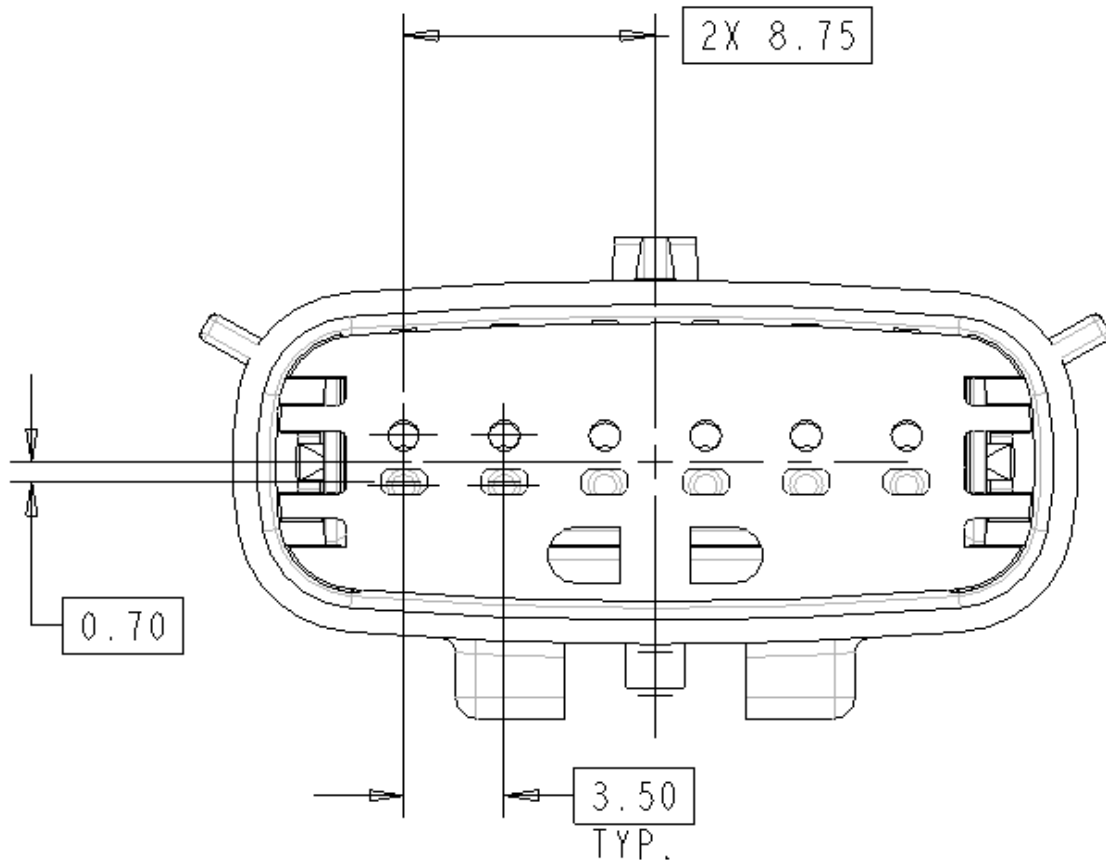

REVISION: D5	ECR/ECN INFORMATION: EC No: 673355 08/12/2021	TITLE: MX150 Application Guide	SHEET No. 58 of 76
DOCUMENT NUMBER: AS-33472-100	CREATED / REVISED BY: Jone Zheng	CHECKED BY: Elvis Song	APPROVED BY: Mike Vanslambrouck



APPLICATION SPECIFICATION

Section 6: Electrical Continuity Checking

MX150 20 WAY BLADE

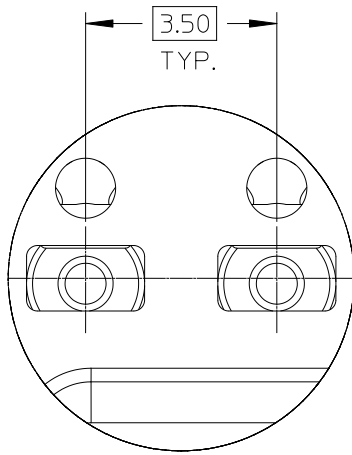

DETAIL A
SCAI F 10:1

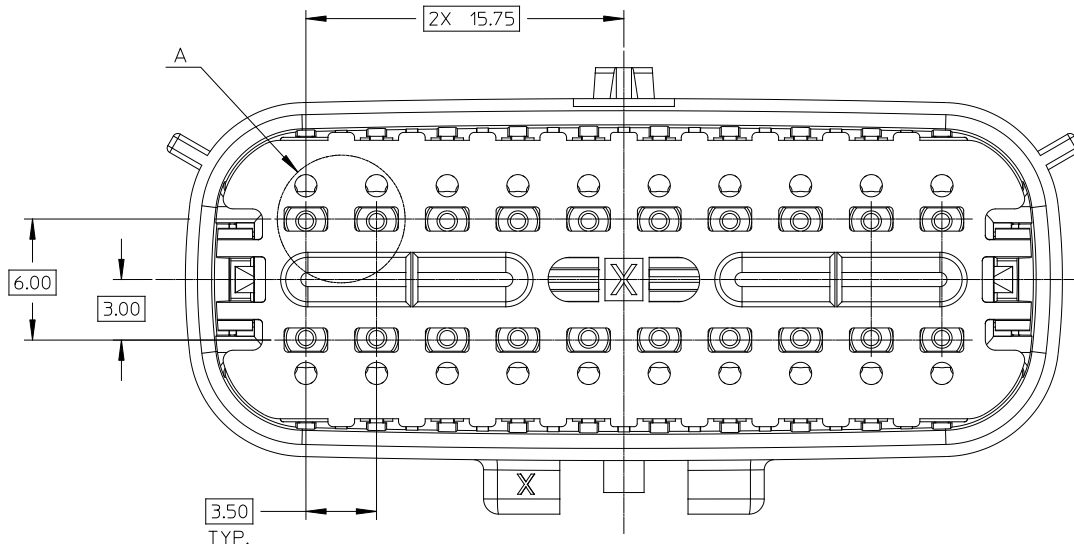

REVISION: D5	ECR/ECN INFORMATION: EC No: 673355 08/12/2021	TITLE: MX150 Application Guide	SHEET No. 59 of 76
DOCUMENT NUMBER: AS-33472-100	CREATED / REVISED BY: Jone Zheng	CHECKED BY: Elvis Song	APPROVED BY: Mike Vanslambrouck



APPLICATION SPECIFICATION

Section 7: Crimping

This MX150 crimping information can be found at:
www.molex.com/ind/mx150.html
MX150 Terminal Sales drawing

MX150 Female Terminal Sales Drawing: SD-33012-002
MX150 Female Terminal Crimping Specification: AS-33012-002

MX150 Male Blade Terminal Sales Drawing: SD-33000-001
MX150 Male Blade Terminal Crimping Specification: AS-33000-001

REVISION: D5	ECR/ECN INFORMATION: EC No: 673355 08/12/2021	TITLE: MX150 Application Guide	SHEET No. 60 of 76
DOCUMENT NUMBER: AS-33472-100	CREATED / REVISED BY: Jone Zheng	CHECKED BY: Elvis Song	APPROVED BY: Mike Vanslambrouck



APPLICATION SPECIFICATION

Section 7: Crimping

Issue: No Insulation grip step allowed on 22 gage - 0.35-0.5mm² MX150 Female terminal

Part Numbers:

33012-2003 & 33012-3003
33001-2005 & 33001-3005
33001-4003 & 33001-5003

Tin Plated Terminals
Gold Plated Terminals
Silver Plated Terminals

Original 22 gage crimped terminal with Insulation Grip Step:

0.3mm offset from
back of terminal

0.785mm to
CL of wire

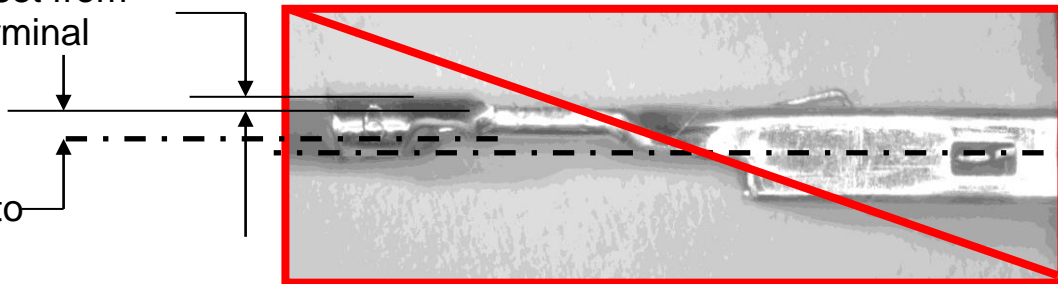

REVISION: D5	ECR/ECN INFORMATION: EC No: 673355 08/12/2021	TITLE: MX150 Application Guide	SHEET No. 61 of 76
DOCUMENT NUMBER: AS-33472-100	CREATED / REVISED BY: Jone Zheng	CHECKED BY: Elvis Song	APPROVED BY: Mike Vanslambrouck



APPLICATION SPECIFICATION

Modified Tool Set Up 22 gage crimped terminal without Insulation Grip Step:

0.0mm offset from
back of terminal

1.085mm to
CL of wire

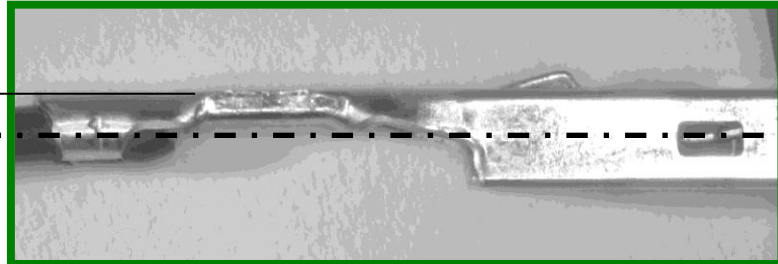

REVISION: D5	ECR/ECN INFORMATION: EC No: 673355 08/12/2021	TITLE: MX150 Application Guide	SHEET No. 62 of 76
DOCUMENT NUMBER: AS-33472-100	CREATED / REVISED BY: Jone Zheng	CHECKED BY: Elvis Song	APPROVED BY: Mike Vanslambrouck



APPLICATION SPECIFICATION

Section 7: Crimping

2.8 Male Blade

Used in MX150 16 way hybrid

Issue: 2.8 terminals, and excessive wire brush



Excessive wire brush

This failure can limit the ability to seat the TPA



Proper wire brush

REVISION: D5	ECR/ECN INFORMATION: EC No: 673355 08/12/2021	TITLE: MX150 Application Guide	SHEET No. 63 of 76
DOCUMENT NUMBER: AS-33472-100	CREATED / REVISED BY: Jone Zheng	CHECKED BY: Elvis Song	APPROVED BY: Mike Vanslambrouck



APPLICATION SPECIFICATION

Section 8: Hybrid Connector

A. Un-populated shorting bar connector (TPA in pre-lock)

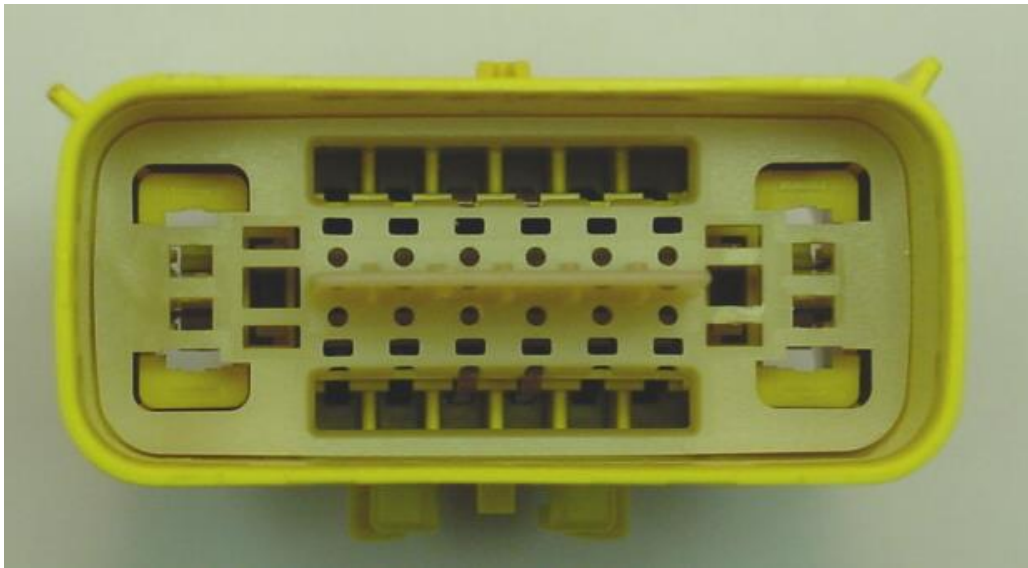

REVISION: D5	ECR/ECN INFORMATION: EC No: 673355 08/12/2021	TITLE: MX150 Application Guide	SHEET No. 64 of 76
DOCUMENT NUMBER: AS-33472-100	CREATED / REVISED BY: Jone Zheng	CHECKED BY: Elvis Song	APPROVED BY: Mike Vanslambrouck



APPLICATION SPECIFICATION

Section 8: Hybrid Connector

B. Shorting Bar Blade Terminal (gold plating only)

Crimp information can be found on the corresponding terminal drawing.

Wire insulation grip is critical to prevent the rotation of the terminal during installation into the connector.

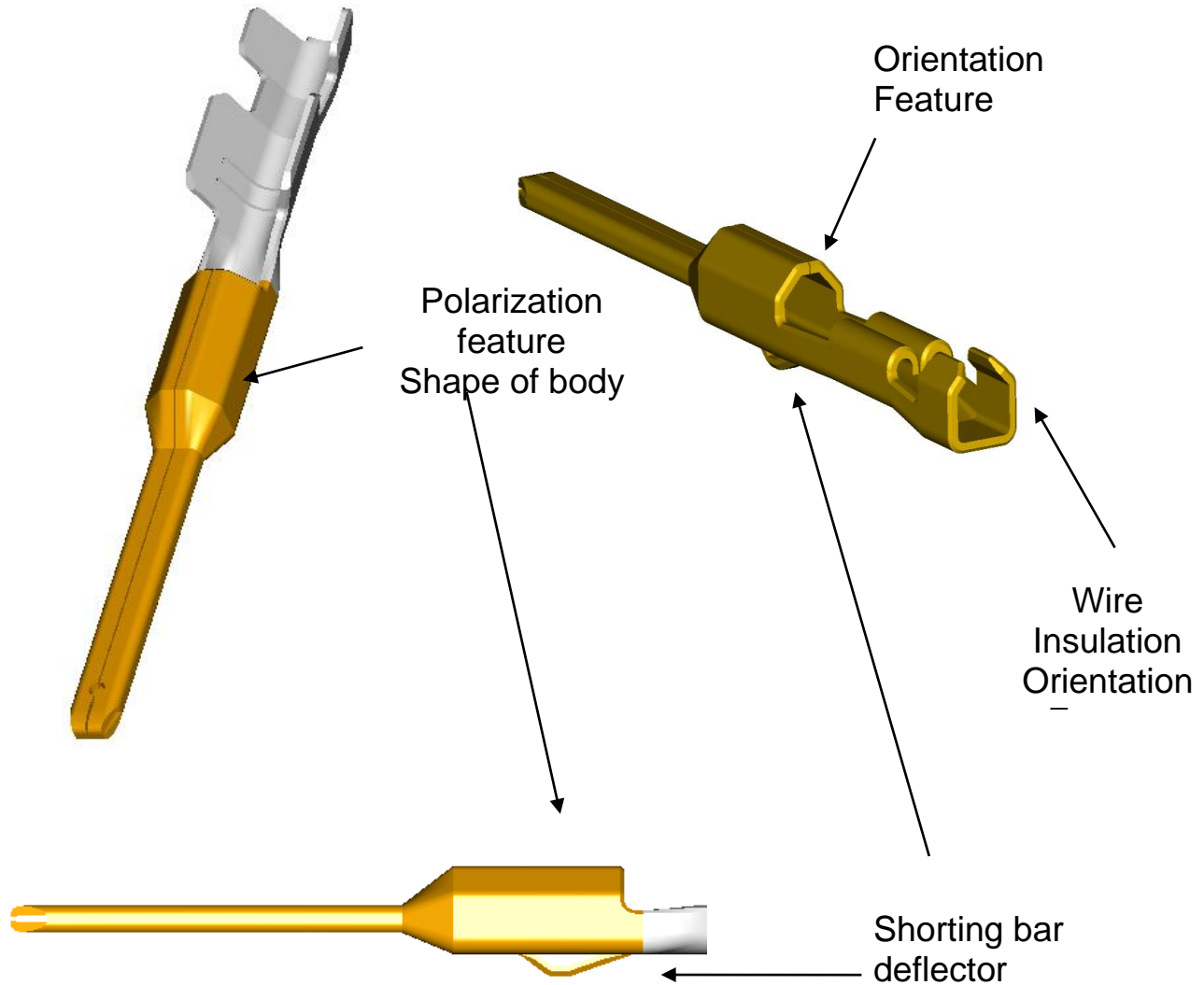

REVISION: D5	ECR/ECN INFORMATION: EC No: 673355 08/12/2021	TITLE: MX150 Application Guide	SHEET No. 65 of 76
DOCUMENT NUMBER: AS-33472-100	CREATED / REVISED BY: Jone Zheng	CHECKED BY: Elvis Song	APPROVED BY: Mike Vanslambrouck



APPLICATION SPECIFICATION

Section 8: Hybrid Connector

C. Single cavity populated shorting bar connector (TPA in Lock)

NOTE! Lifted shorting bar

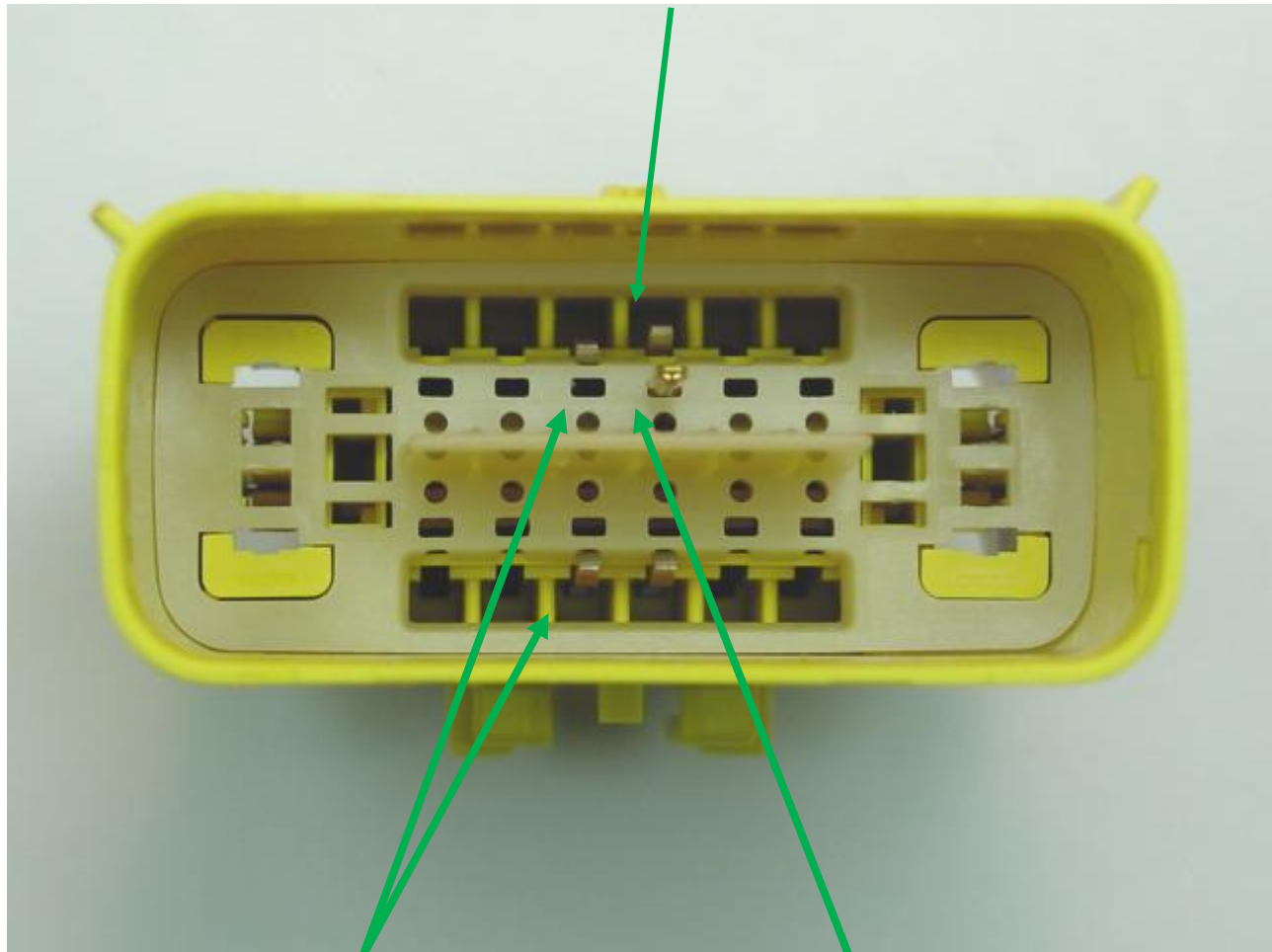

Shorting Bars

Blade Terminal

REVISION: D5	ECR/ECN INFORMATION: EC No: 673355 08/12/2021	TITLE: MX150 Application Guide	SHEET No. 66 of 76
DOCUMENT NUMBER: AS-33472-100	CREATED / REVISED BY: Jone Zheng	CHECKED BY: Elvis Song	APPROVED BY: Mike Vanslambrouck



APPLICATION SPECIFICATION

Section 8: Connector Assembly D. 1.5 mm Shorting Bar Terminal Installation

With TPA still in pre-lock position, orient terminal to rear of connector. Grip the wire no less than 30 mm from the terminal insulation crimp and insert through appropriate circuit opening. If resistance is encountered, retract the terminal and adjust the angle of insertion. Continue inserting the terminal until it stops and locks up on the lock finger with an audible click.

Correct Orientation

180° Mis-orientation

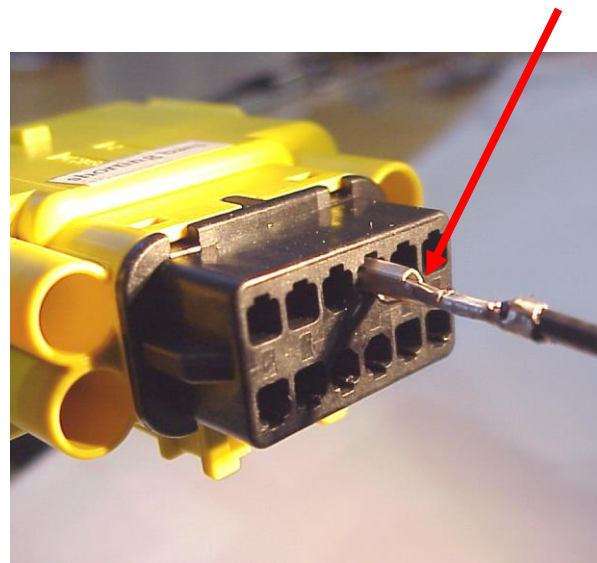
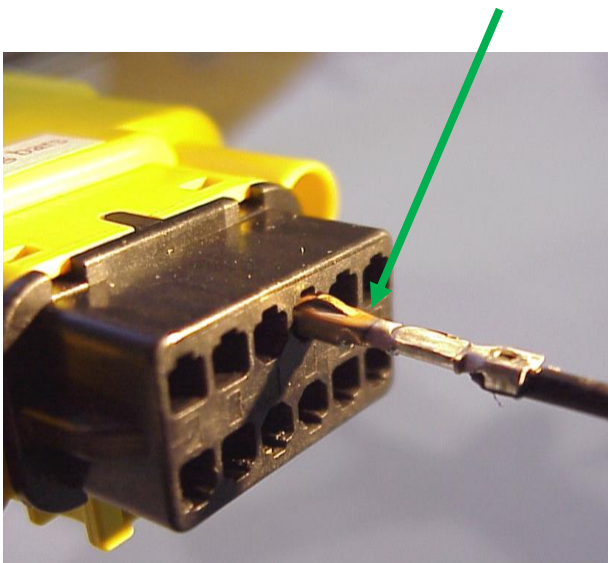

Do not apply excessive force, this may damage the terminal orientation feature!

REVISION: D5	ECR/ECN INFORMATION: EC No: 673355 08/12/2021	TITLE: MX150 Application Guide	SHEET No. 67 of 76
DOCUMENT NUMBER: AS-33472-100	CREATED / REVISED BY: Jone Zheng	CHECKED BY: Elvis Song	APPROVED BY: Mike Vanslambrouck



APPLICATION SPECIFICATION

Section 8: Connector Assembly E. Populating the 2.8 mm Terminal



Note alignment tabs on Blade terminal

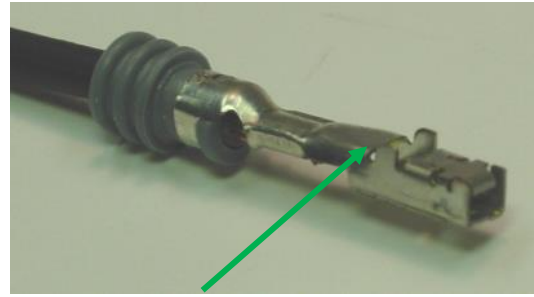

Note alignment tabs on Receptacle terminal

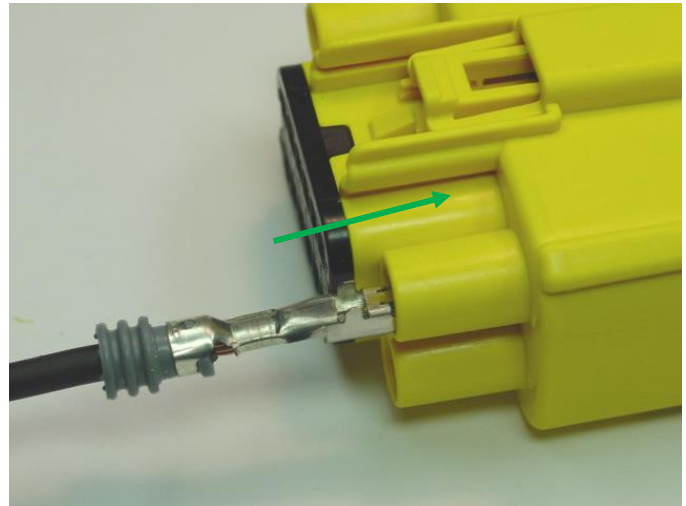
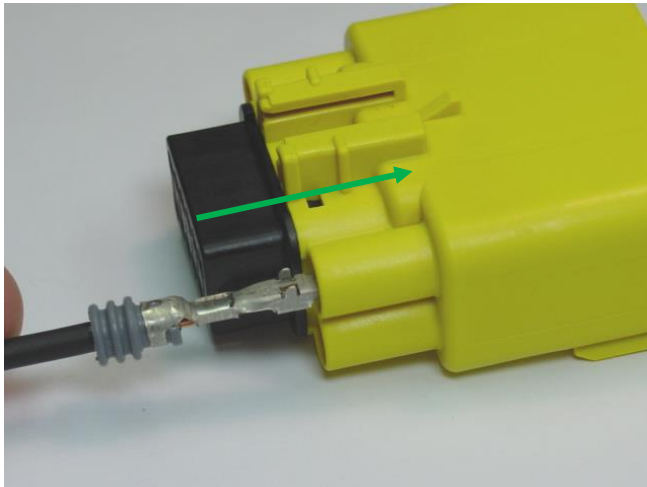

Align tabs and insert until you hear/feel positive engagement with an audible click

REVISION: D5	ECR/ECN INFORMATION: EC No: 673355 08/12/2021	TITLE: MX150 Application Guide	SHEET No. 68 of 76
DOCUMENT NUMBER: AS-33472-100	CREATED / REVISED BY: Jone Zheng	CHECKED BY: Elvis Song	APPROVED BY: Mike Vanslambrouck



APPLICATION SPECIFICATION

Section 8: Service Instructions

F. 2.8 mm Terminal Servicing

Step 1: Using the 2.8 mm service tool #63813-1500, insert the tip into the terminal service hole adjacent to the terminal to be serviced.

Step 2: Push down gently to release locking finger.

Do not apply any lateral force, this may damage the tool, or the locking finger!

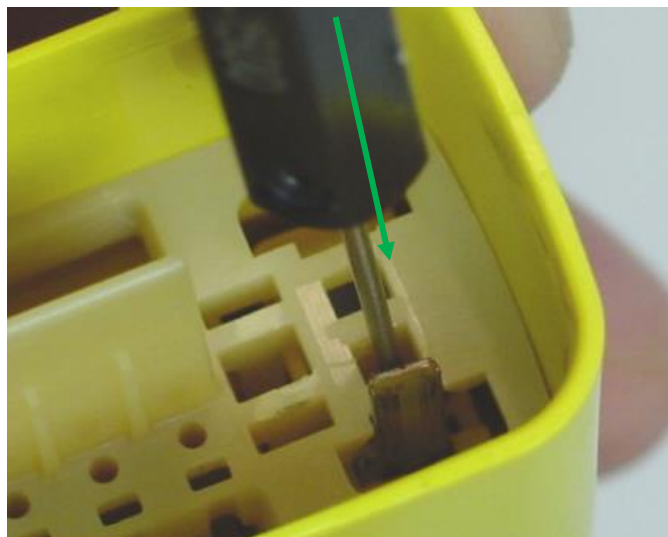
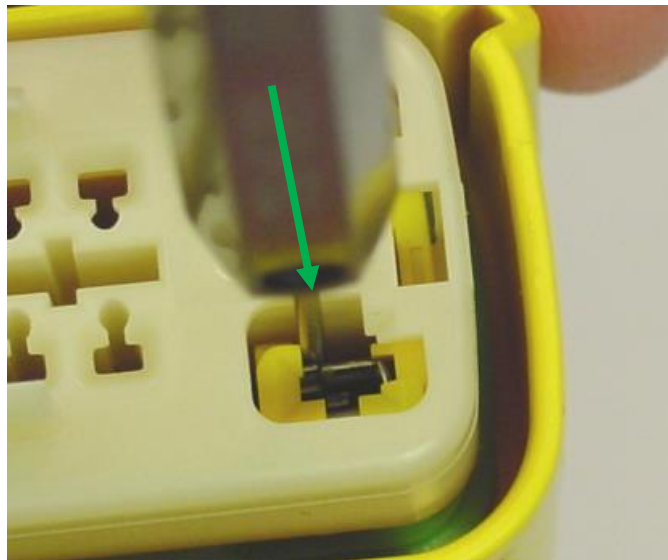

REVISION: D5	ECR/ECN INFORMATION: EC No: 673355 08/12/2021	TITLE: MX150 Application Guide	SHEET No. 69 of 76
DOCUMENT NUMBER: AS-33472-100	CREATED / REVISED BY: Jone Zheng	CHECKED BY: Elvis Song	APPROVED BY: Mike Vanslambrouck



APPLICATION SPECIFICATION

Section 9: Troubleshooting A. MX150 16 Way Male Hybrid

Issue: Damage on Shorting Bar Terminal



OK

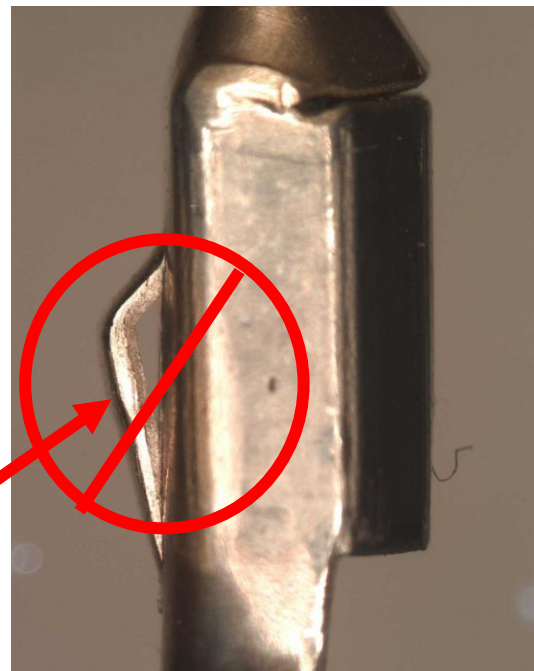

Damage to Shorting Bar Terminal Orientation feature from being put into the grommet cap the wrong way.

REVISION: D5	ECR/ECN INFORMATION: EC No: 673355 08/12/2021	TITLE: MX150 Application Guide	SHEET No. 70 of 76
DOCUMENT NUMBER: AS-33472-100	CREATED / REVISED BY: Jone Zheng	CHECKED BY: Elvis Song	APPROVED BY: Mike Vanslambrouck



APPLICATION SPECIFICATION

Section 9: Troubleshooting B. MX150 16 Way Male Hybrid

Issue: Damage to Orientation Feature Shorting Bar Terminal

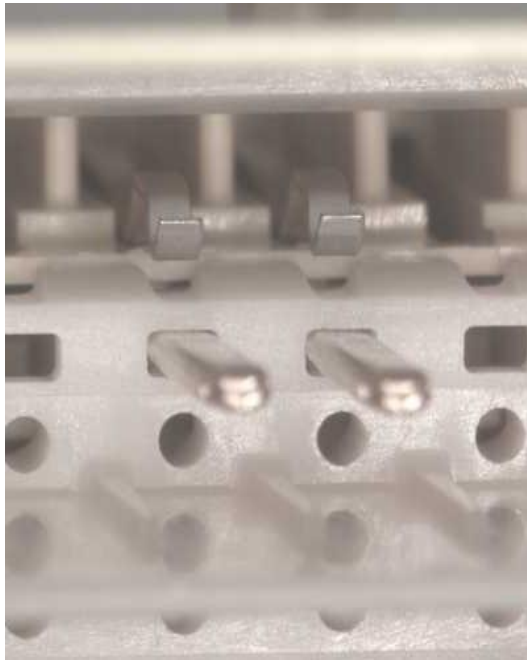

Proper Alignment of Shorting Bar Orientation Feature Un-damaged

OK

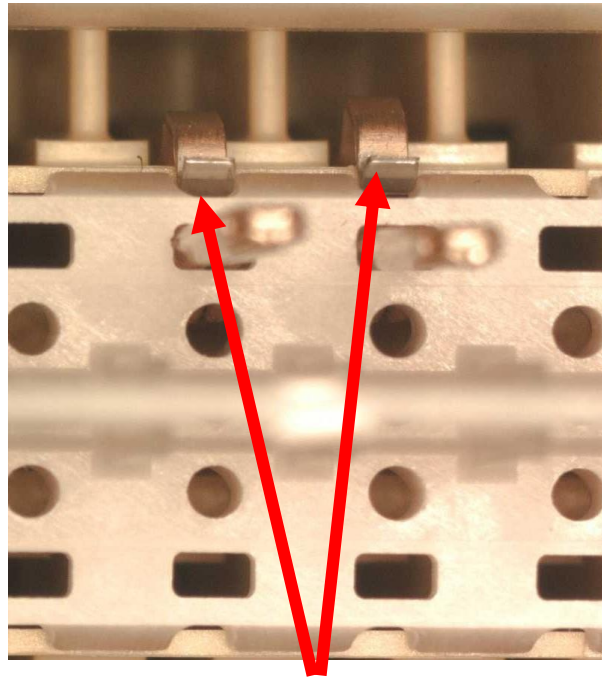

Damaged Terminal Orientation Feature Shorting bars not lifted

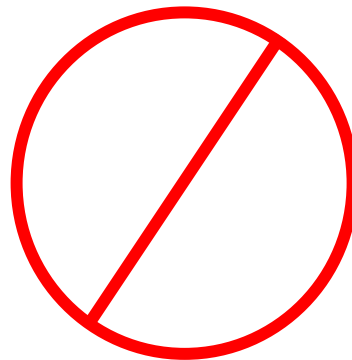

REVISION: D5	ECR/ECN INFORMATION: EC No: 673355 08/12/2021	TITLE: MX150 Application Guide	SHEET No. 71 of 76
DOCUMENT NUMBER: AS-33472-100	CREATED / REVISED BY: Jone Zheng	CHECKED BY: Elvis Song	APPROVED BY: Mike Vanslambrouck



APPLICATION SPECIFICATION

Section 9: Troubleshooting D. MX150 16 Way Male Hybrid

Issue: TPA should never be fully removed from connector for any reason. If the TPA has been removed, replace entire connector.



REVISION: D5	ECR/ECN INFORMATION: EC No: 673355 08/12/2021	TITLE: MX150 Application Guide	SHEET No. 72 of 76
DOCUMENT NUMBER: AS-33472-100	CREATED / REVISED BY: Jone Zheng	CHECKED BY: Elvis Song	APPROVED BY: Mike Vanslambrouck



APPLICATION SPECIFICATION

Section 9: Troubleshooting E. MX150 16 Way Male Hybrid

Issue: Terminal inserted rotated 180 degrees out



1.5mm Terminal is turned upside-down

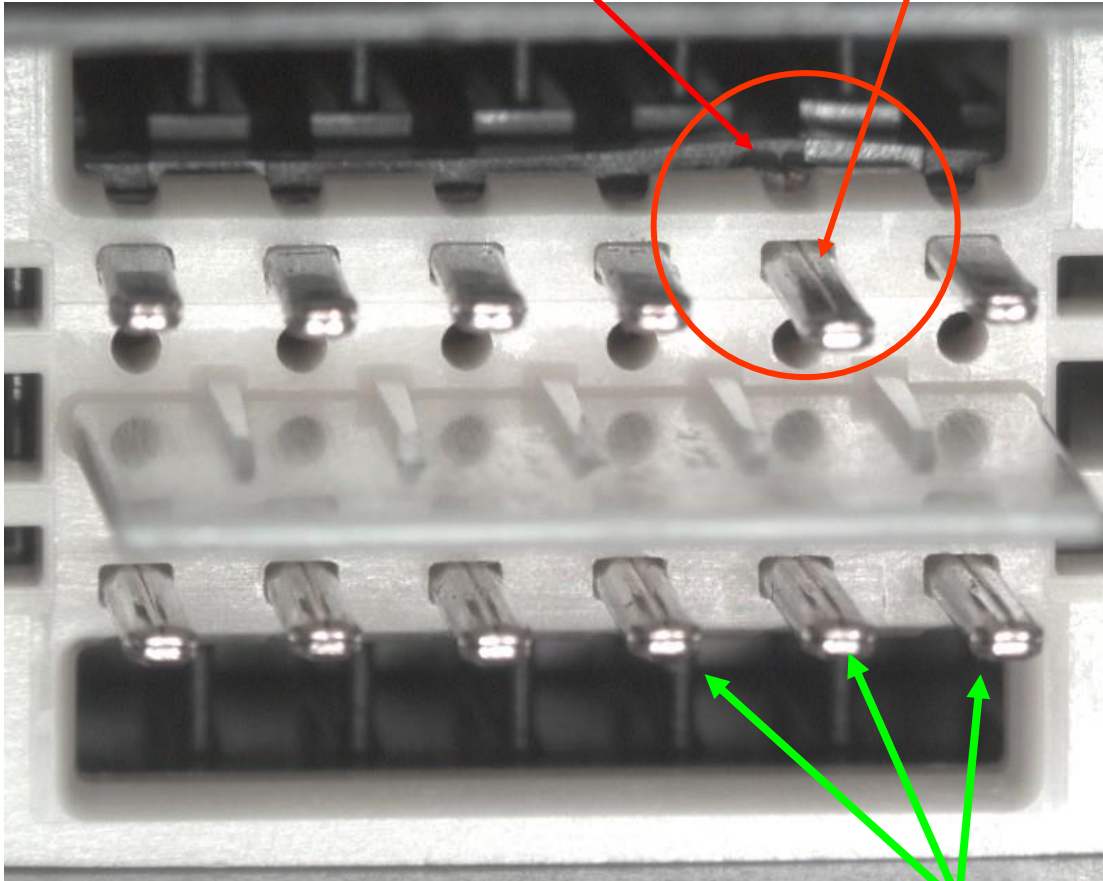

OK

1.5mm Terminals proper orientation

REVISION: D5	ECR/ECN INFORMATION: EC No: 673355 08/12/2021	TITLE: MX150 Application Guide	SHEET No. 73 of 76
DOCUMENT NUMBER: AS-33472-100	CREATED / REVISED BY: Jone Zheng	CHECKED BY: Elvis Song	APPROVED BY: Mike Vanslambrouck



APPLICATION SPECIFICATION

Section 10: Packaging

Assembly at Tier 1(Wire Harness Assembly Plant)

Unpacking:

TPA as received, The TPA are locked in place in the pre-lock position. If the TPA is in final lock follow the service section in section 5.

Handling in Plant:

Harness build board/fixture: Molex recommends moving the box to the line, this will insure against damage. Parts should remain in box until assembled placed on a harness assembly build board.

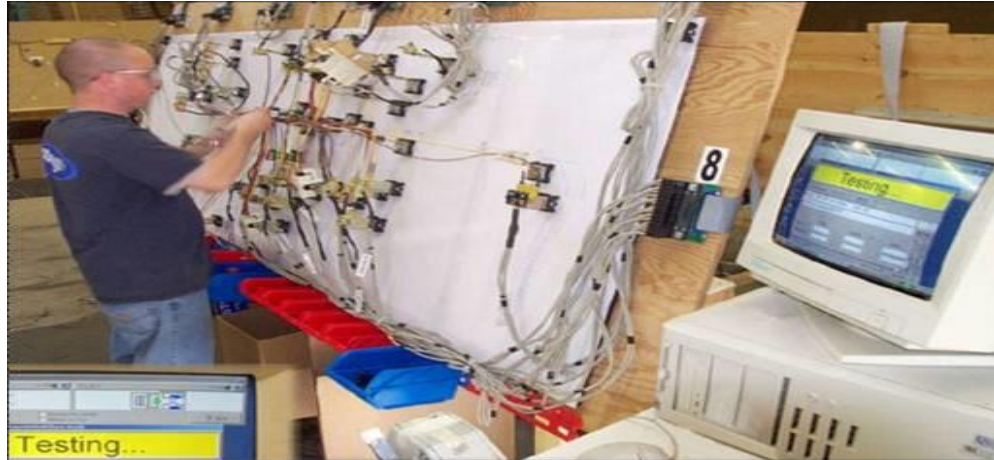

REVISION: D5	ECR/ECN INFORMATION: EC No: 673355 08/12/2021	TITLE: MX150 Application Guide	SHEET No. 74 of 76
DOCUMENT NUMBER: AS-33472-100	CREATED / REVISED BY: Jone Zheng	CHECKED BY: Elvis Song	APPROVED BY: Mike Vanslambrouck



APPLICATION SPECIFICATION

Section 10: Packaging

Bulk Pack (TYPE 1)

MX150 Seal Plug
Male 1x2 through 1x6
Male 2x2 through 2x10
Female 2x2, 1x2, 1x3



Bulk Pack (TYPE 2)

Male 16 way Hybrid



Bulk Pack (TYPE 3)

Female 1x4 through 1x6
Female 2x3 through 2x10



Bulk Pack (TYPE 4)

Female 16 way Hybrid



REVISION: D5	ECR/ECN INFORMATION: EC No: 673355 08/12/2021	TITLE: MX150 Application Guide	SHEET No. 75 of 76
DOCUMENT NUMBER: AS-33472-100	CREATED / REVISED BY: Jone Zheng	CHECKED BY: Elvis Song	APPROVED BY: Mike Vanslambrouck



APPLICATION SPECIFICATION

Section 11: Appendix A

- Document Change History:**

Revision	Date	Description
A	12/6/16	Added 2.8mm cavity seal plug installation procedure: section 3 – Pages: 20, 21
B	03/15/17	Added “and avoid cavity plug dislocation/push through” to cavity plug trimming note on pages 18 & 19
C	1/10/18	Removed change history information for revisions 1-7 Section 3.D – Terminal installation revised. Changed the distance to grip the receptacle terminal lead from 30 to 20mm, changes the distance to grip the blade terminal lead from 30 to 25mm
D	04/04/2018	General revision
D1	03/12/2020	Revised Typo’s on pages 49, 53, 55 &57 Updated 2.8 cavity plug images & notes.
D2	04/21/2021	Update rcpt cavity plug trimming recommendation
D3	05/10/2021	Update cavity plug instructions
D4	05/25/2021	Update cavity plug to gen2
D5	08/13/2021	Update package method

REVISION: D5	ECR/ECN INFORMATION: EC No: 673355 08/12/2021	TITLE: MX150 Application Guide	SHEET No. 76 of 76
DOCUMENT NUMBER: AS-33472-100	CREATED / REVISED BY: Jone Zheng	CHECKED BY: Elvis Song	APPROVED BY: Mike Vanslambrouck