

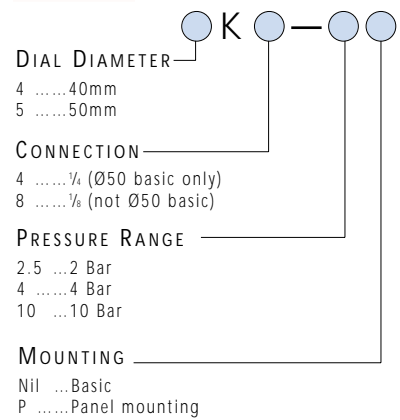

PRESSURE GAUGES

- ✓ 3 pressure ranges
- ✓ Centre back or panel mount
- ✓ 1/8" or 1/4" connection
- ✓ 40 or 50mm diameter face

HOW TO ORDER PRESSURE GAUGES



NOTE

For Air Preparation series AR/AW1000, use SMC gauge part number:

G27-10-R1 1/8" connection

STOCKED PRODUCTS
 FOR A LIST OF STOCKED PRODUCTS,
 PLEASE SEE THE CURRENT SMC PRICE LIST

DIMENSIONS 4K8-10/4/2.5

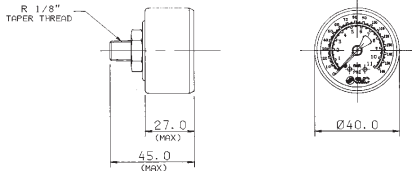

NOTE: TAPER THREADS TO I

DIMENSIONS 5K4-10/4/2.5

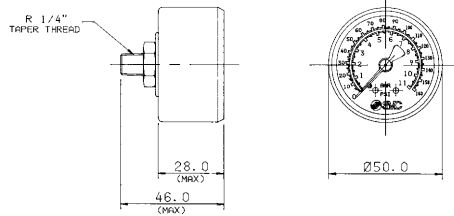

NOTE: TAPER THREADS TO I

DIMENSIONS 5K8-10P/4P/2.5P

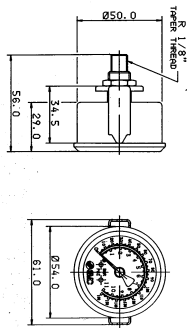

DIMENSIONS 4K8-10P/4P/2.5P

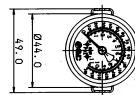

DIMENSIONS G27-10-R1

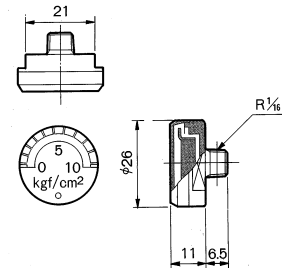

SEE INSIDE FRONT COVER FOR
 DETAILS OF YOUR LOCAL SALES OFFICE



FOR FURTHER TECHNICAL
 DETAILS ON THIS
 PRODUCT REQUEST
 CATALOGUE REFERENCE
 E5G

HIGH NOISE REDUCTION TYPE SILENCER SERIES ANA1/ANB1

- ✓ Standardised thread and one-touch connection
- ✓ Choice of two orifice sizes
- ✓ Compact, robust construction
- ✓ Minimum flow restriction for low back pressure
- ✓ Wide range of options
- ✓ High noise reduction (40dB(A) for ANA1)
- ✓ Higher flow rate from ANB1: ideal for use on common exhaust ports of valve manifolds

Note:

- avoid outdoor operation
- avoid lateral loading
- whilst compressor oil will not clog these silencers, grease and other poor flowing oils in the exhaust will clog and cause deterioration



TECHNICAL SPECIFICATIONS

Series	A1	B1
Max. operating pressure	1.0MPa(10.2kgf/cm ²)	1.0MPa(10.2kgf/cm ²)
Noise reduction effect	40dB(A)	38dB(A)
Ambient and fluid temperature	5-60°C	5-60°C
Thread	R(PT)	R(PT)



HOW TO ORDER ANA1/ANB1 SERIES



PORT SIZE (SCREW-IN)

01 ...1/8	One Touch
02 ...1/4	C06 ...Ø6 (B1 only)
03 ...3/8	C08 ...Ø8
04 ...1/2	C10 ...Ø10
06 ...3/4	C12 ...Ø12 (A1 only)
10 ...1	
12 ...1 1/4	
14 ...1 1/2	
20 ...2 (A1 only)	

STOCKED PRODUCTS

FOR A LIST OF STOCKED PRODUCTS, PLEASE SEE THE CURRENT SMC PRICE LIST

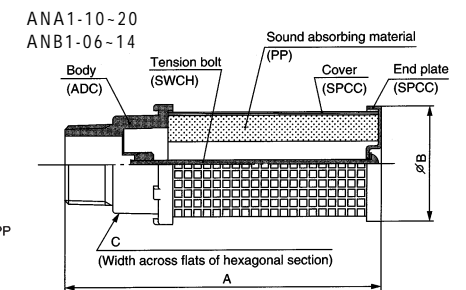

DIMENSIONS

MODEL (THREAD CONNECTION)

	orifice (mm ²)	(g)	A	B	C
ANA1-01	1/4	10	4	37	16
ANA1-02	1/4	15	14	64	22
ANA1-03	3/8	35	22	84	25
ANA1-04	1/2	60	36	98	30
ANA1-06	3/4	90	110	111	46
ANA1-10	1	160	180	132	50
ANA1-12	1 1/4	280	544	200	74
ANA1-14	1 1/2	450	612	230	74
ANA1-20	2	610	873	271	86
ANB1-01	1/4	15	10	51	22
ANB1-02	1/4	35	22	81	25
ANB1-03	3/8	60	35	93	30
ANB1-04	1/2	90	94	107	46
ANB1-06	3/4	160	175	133	50
ANB1-10	1	280	462	190	74
ANB1-12	1 1/4	450	612	230	74
ANB1-14	1 1/2	610	871	271	86

DIMENSIONS

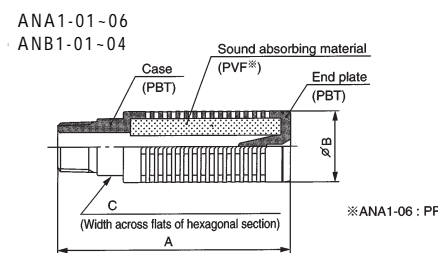

DIMENSIONS

MODEL (ONE TOUCH FITTINGS CONNECTION)

Model	Applicable one touch fittings size	Effective orifice (mm ²)	Weight (g)	Dimensions (mm)
ANA1-C08	Ø8	11	5	58 16
ANA1-C10	Ø10	15	13	76 22
ANA1-C12	Ø12	33	19	95 25
ANB1-C06	Ø6	8	5	52 16
ANB1-C08	Ø8	13	12	73 22
ANB1-C10	Ø10	28	18	94 25

Notes:

- To install threaded versions screw in hand tight then spanner tighten 1/4 turn only.
- Avoid contact with solvents or corrosive gases.

DIMENSIONS

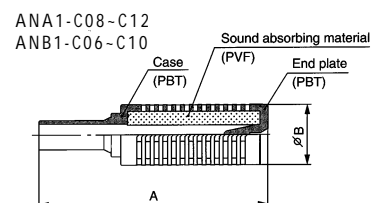

OTHER SILENCERS AVAILABLE ARE SERIES AN, EBKX SEE ALSO AVAILABLE SECTION



FOR FURTHER TECHNICAL
DETAILS ON THIS
PRODUCT REQUEST
CATALOGUE REFERENCE
E134-A

SERIES AMC EXHAUST CLEANER

TECHNICAL SPECIFICATIONS

Max operating temperature	60°C
Noise reduction	35dB or more
Oil mist removal	99.9% or more
Exhaust of oil mist	Drain cock
Option	Bracket*
*Bracket not available on AMC810 and 910	

- ✓ Ensures clean plant air and noise reduction of distributing noise contamination
- ✓ Over 35 dB noise reduction
- ✓ Over 99.9% oil mist removal
- ✓ Male or female inlet



SYMBOLS



DIMENSIONS SERIES AMC EXHAUST CLEANER FEMALE TYPE

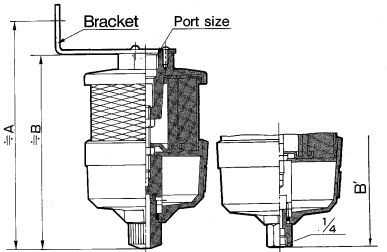
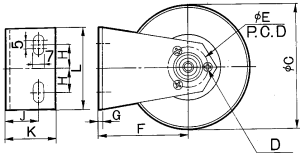

Threaded Drain Port(Female)

DIMENSIONS SERIES AMC EXHAUST CLEANER MALE TYPE

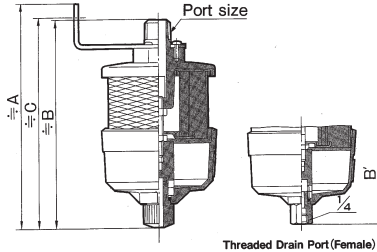
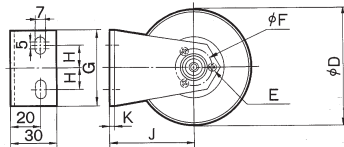

Threaded Drain Port(Female)

ACCESSORIES SERIES AMC EXHAUST CLEANER

ElementSee "How To Order"
BracketSee "How To Order"

STOCKED PRODUCTS
FOR A LIST OF STOCKED PRODUCTS,
PLEASE SEE THE CURRENT SMC PRICE LIST

Model	Port size	A	B	øD	Bracket							
					D	øE	F	G	H	J	K	L
AMC220	1/4"	100	88	56	M3x0.5 Depth-8	22	40	2.3	15	12	20	50
AMC320	3/8"	140.5	120.5	75	M3x0.5 Depth-8	24	55	2.3	15	20	30	50
AMC520	1/2"	193.5	173.5	102	M4x0.7 Depth-8	40	70	3.2	20	20	30	70

*A 1/4 fitting can be mounted when removed drain cock on AMC220

Model	Port size	A	B	C	øD	Bracket					
						E	øF	G	H	J	K
AMC310	3/8"	150.5	138.5	140.5	75	M3x0.6 Depth-8	24	50	15	55	2.3
AMC510	1/2"	203.5	196.5	193.5	102	M4x0.7 Depth-8	40	70	20	70	3.2
AMC610	1	229.5	224.5	219.5	118	M4x0.7 Depth-10	48	70	20	80	3.2
AMC810	1 1/2	-	270	-	135	-	-	-	-	-	-
AMC910	2	-	327	-	153	-	-	-	-	-	-

HOW TO ORDER AMC SERIES

Model	Male					Female		
	AMC310	AMC510	AMC610	AMC810	AMC910	AMC220	AMC320	AMC520
Port size	3/8"	1/2"	1	1 1/2	2	1/4"	3/8"	1/2"
Max air flow (Nl/min)	300	1,000	3,000	6,000	10,000	200	300	1,000
Effective orifice mm ² (Cv)	16 (0.88)	55 (3.1)	165 (9.2)	330 (18.3)	550 (31)	12 (0.66)	16 (0.88)	55 (3.1)
Element model no.	635321	635521	635619	635812P	635917P	635322	635321	635521
Bracket model no.	BE30	BE50	BE60	-	-	BE20	BE30	BE50

STOCKED PRODUCTS
FOR A LIST OF STOCKED PRODUCTS,
PLEASE SEE THE CURRENT SMC PRICE LIST

HOW TO ORDER SERIES AMC

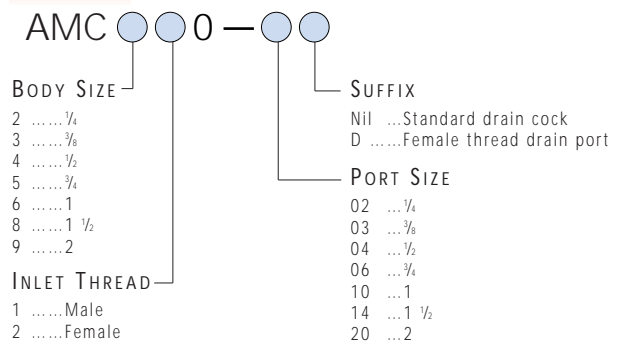

SEE INSIDE FRONT COVER FOR
DETAILS OF YOUR LOCAL SALES OFFICE



FOR FURTHER TECHNICAL
DETAILS ON THIS
PRODUCT REQUEST
CATALOGUE REFERENCE
E5G