

Datasheet

RS Pro HSS Counterbores

RS Stock No: 131-886

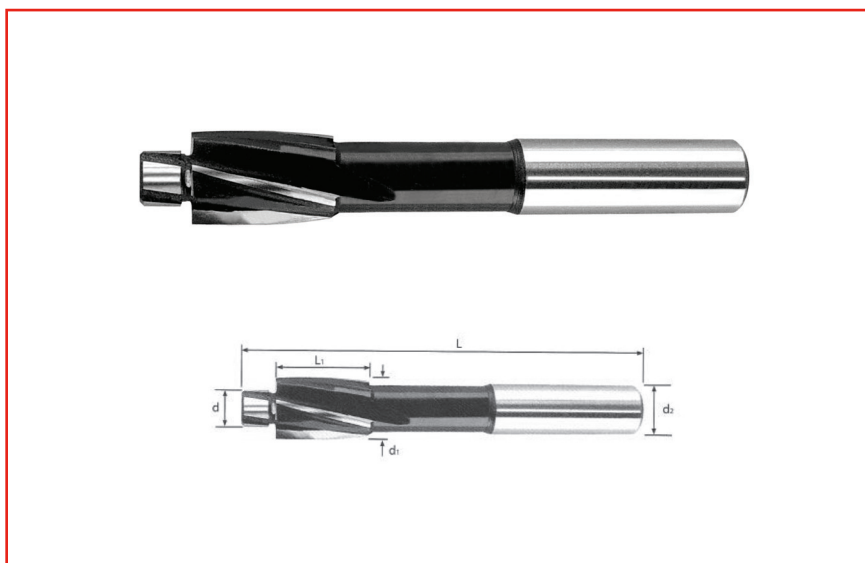

Specifications:

4 Flute Straight Shank Counterbores

Used to produce recessed holes for cap head screws

Material: High Speed Steel

DIN 373

Screw Size	d1 (mm)	d2 (mm)	d (mm)	L	L1
M3	6	5	3.4	71	14

Order Code	Manufacturers Code	Description
131-886	28-650-003	HSS Counterbore M3