



UM30-215113

UM30

ULTRASONIC SENSORS

SICK
Sensor Intelligence.



Ordering information

Type	Part no.
UM30-215113	6036920

Other models and accessories → www.sick.com/UM30



Detailed technical data

Performance

Operating range, limiting range	600 mm ... 6,000 mm, 8,000 mm
Target	Natural objects
Resolution	≥ 0.18 mm
Repeatability	± 0.15 % ¹⁾
Accuracy	± 1 % ^{1) 2)}
Temperature compensation	✓
Response time	240 ms
Output time	60 ms
Ultrasonic frequency (typical)	80 kHz
Detection area (typical)	See diagrams
Additional function	Teach-in of analog output, scaling of analog outputs, Invertable analog output, automatic selection of analog current or voltage output, temperature compensation, synchronization of up to 10 sensors, multiplexing: no cross talk of up to 10 sensors, set measurement filters: value filter, filter strength, adjustable sensitivity, foreground suppression and detection area, switch-off display, reset to factory default ³⁾

¹⁾ Referring to current measurement value.

²⁾ Temperature compensation can be switched off, without temperature compensation: 0.17 % / K.

³⁾ Functions may vary depending on sensor type.

Interfaces

Analog output	1 x 0 V ... 10 V (≥ 100 kΩ) 1 x 4 mA ... 20 mA (≤ 500 Ω) ^{1) 1) 2) 3)}
Resolution analog output	12 bit
Multifunctional input (MF)	1 x MF

¹⁾ Automatic selection of analog current or voltage output dependent on load.

²⁾ For 4 mA ... 20 mA and $V_s \leq 20$ V max. load ≤ 100 Ω.

³⁾ Subsequent smoothing of the analog output, depending on the application, may increase the response time by up to 200 %.

Mechanics/electronics

Supply voltage V_s	DC 9 V ... 30 V ^{1) 2)}
Power consumption	$\leq 2.4 \text{ W}$ ³⁾
Initialization time	< 300 ms
Design	Cylindrical
Housing material	Nickel-plated brass, PBT Display: TPU Ultrasonic transducer: polyurethane foam, glass epoxy resin
Connection type	Male connector, M12, 5-pin
Indication	LED display, 2 x LED
Weight	270 g
Sending axis	Straight
Enclosure rating	IP67
Protection class	III

¹⁾ Limit values, reverse-polarity protected Operation in short-circuit protected network: max. 8 A, class 2.

²⁾ 15 V ... 30 V when using the analog voltage output.

³⁾ Without load.

Ambient data

Ambient temperature operation	-25 °C ... +70 °C
Ambient storage temperature	-40 °C ... +85 °C

Classifications

ECl@ss 5.0	27270804
ECl@ss 5.1.4	27270804
ECl@ss 6.0	27270804
ECl@ss 6.2	27270804
ECl@ss 7.0	27270804
ECl@ss 8.0	27270804
ECl@ss 8.1	27270804
ECl@ss 9.0	27270804
ETIM 5.0	EC001846
ETIM 6.0	EC001846
UNSPSC 16.0901	41111960

Dimensional drawing (Dimensions in mm (inch))

UM30-215

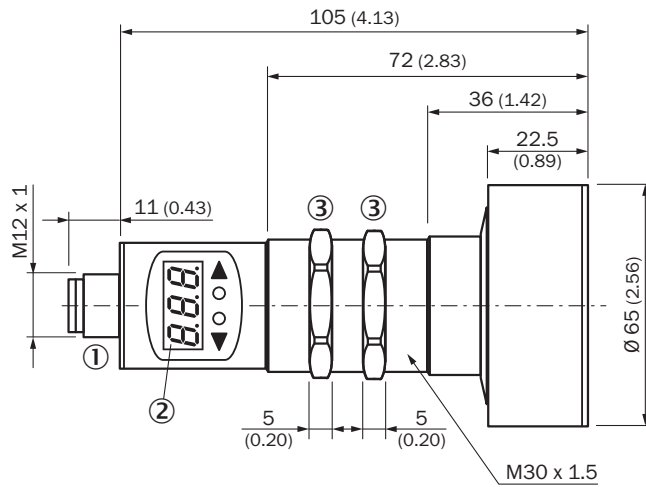

- ① Connection
- ② Display
- ③ Mounting nuts, SW 36 mm

Connection type

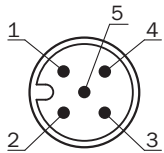

Connection diagram

UM30-21x113 Connector M12, 5-pin

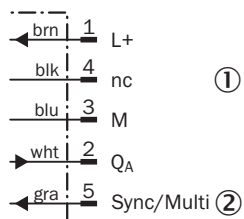

- ① Not assigned
- ② Synchronization and multiplex operation/communication Connect+

Adjustment possible

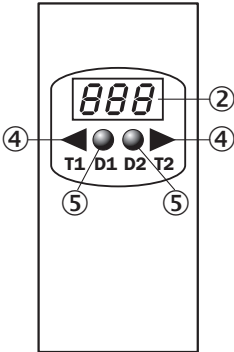

- ② Display
- ④ Operating elements
- ⑤ Status indicators

Detection area



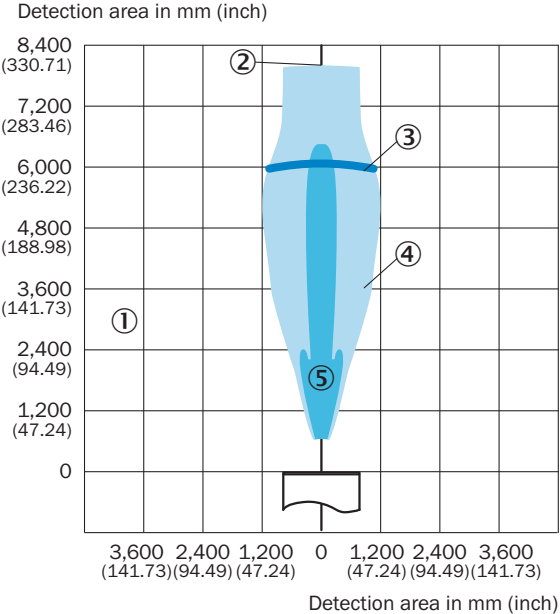

UM30-215, UC30-215

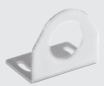

- ① Detection range dependent on reflection properties, size, and alignment of the object
- ② Limiting range
- ③ Operating range
- ④ Example object: aligned plate 500 mm x 500 mm
- ⑤ Example object: pipe with 27 mm diameter

Recommended accessories

Other models and accessories → www.sick.com/UM30

	Brief description	Type	Part no.
Mounting brackets and plates			
	Mounting plate for M30 sensors, steel, zinc coated, without mounting hardware	BEF-WG-M30	5321871
	Mounting bracket for M30 sensors, steel, zinc coated, without mounting hardware	BEF-WN-M30	5308445
Terminal and alignment brackets			
	Mounting bracket, M30, axial rotation possible, with threaded mounting hole M6, without mounting hardware	BEF-HA-M30A	5311527
Plug connectors and cables			
	Head A: female connector, M12, 5-pin, straight, A-coded Head B: Flying leads Cable: Sensor/actuator cable, PVC, unshielded, 2 m	YF2A15-020VB5XLEAX	2096239
	Head A: female connector, M12, 5-pin, angled, A-coded Head B: Flying leads Cable: Sensor/actuator cable, PVC, unshielded, 2 m	YG2A15-020VB5XLEAX	2096215
Programming and configuration tools			
	Tool for visualization, configuration and cloning, 3-digit LED display, supply voltage: DV 9 V ... 30 V	Connect+ adapter (CPA)	6037782

SICK AT A GLANCE

SICK is one of the leading manufacturers of intelligent sensors and sensor solutions for industrial applications. A unique range of products and services creates the perfect basis for controlling processes securely and efficiently, protecting individuals from accidents and preventing damage to the environment.

We have extensive experience in a wide range of industries and understand their processes and requirements. With intelligent sensors, we can deliver exactly what our customers need. In application centers in Europe, Asia and North America, system solutions are tested and optimized in accordance with customer specifications. All this makes us a reliable supplier and development partner.

Comprehensive services complete our offering: SICK LifeTime Services provide support throughout the machine life cycle and ensure safety and productivity.

For us, that is “Sensor Intelligence.”

WORLDWIDE PRESENCE:

Contacts and other locations –www.sick.com