

# DC pumps **ecocirc**<sup>®</sup> vario

The new pump generation with minimal energy consumption, shaftless spherical motor and permanent magnet technology

- economic and powerful
- stepless speed control
- wide control range
- high efficiency
- long life, maintenance-free
- long term quiet operation



**LAING**

simply the best · by design

# DC pumps

# ecocirc® vario

## Application

The Ecocirc vario pumps can be used wherever a highly efficient circulation pump is needed without a direct connection to AC power. They are characterised by their small size, high efficiency and very low power consumption. The shaftless spherical motor technology enables a long, maintenance free and quiet service life. Areas of application are circulating systems in industrial or medical applications, computer and laser cooling, hot water heating in a mobile home, weekend home or boat with battery or solar powered pump, ponds and aquariums, domestic hot water systems and car heaters.

## Design

The principle of the spherical motor, which was invented by Laing, is fundamentally different from conventional canned motor pumps. The single moving part in a spherical motor is a hemispherical rotor/impeller unit, which sits on an ultra-hard, wear-resistant ceramic sphere. There are no conventional shaft bearings or seals. This rules out, in effect, the possibility of play in the bearings and the increase in noise associated with it. These pumps are particularly robust and give exceptionally long service. The new Ecocirc vario uses sine wave commutation, which works completely silently even at high output levels. The self-realigning bearing is lubricated and cooled by the media. Maintenance is not necessary under normal conditions and even after lengthy shutdown periods a reliable start-up is virtually guaranteed. The parts exposed to the fluid are completely corrosion resistant and ensure safe application even with aggressive media. All Ecocirc vario have a wide adjustable range of control for individual applications and needs which can be set at the integrated speed controller in the end cap.

## Speed controller

The pump can be adjusted over a wide range of control by the integrated speed controller. It can be used either for the adjustment of the desired hydraulic performance or for the limitation of the electric power consumption. Regardless of the setting, the pump is always starting with maximum torque. This ensures a safe start even at the lowest speed. In 24 Volt operation, at highest setting the maximum speed is maintained over the whole performance curve. At smaller voltages the pump either cannot keep the adjusted speed over the whole performance curve and slows down at higher flow rates, or the pump cannot reach the adjusted speed at all. For example, if the pump is powered with 8 Volts, only the pump curves up to the speed setting 3 can be obtained. If the voltage is varied during operation (for example when connected to a solar panel), the pump will keep the adjusted speed as long as the voltage makes this possible. In this case the current draw is altered accordingly. This is advantageous in applications where a certain pump performance is required despite a varying voltage supply.

## Integrated overtemperature protection

The pump comes with an integrated overtemperature safety device, which shuts the pump electronics off when reaching overtemperature. Normally the temperature of the pumped media during operation at the highest speed setting is 95° C at this point.

A complete shutdown after reaching overtemperature condition can result in adverse effects on the circulating system. Since the temperature of the electronic components is influenced by the temperature of the pumped media as well as by the speed setting, the pump will lower its speed automatically after reaching a critical temperature level in order to avoid a total shutdown. However, if the temperature continues to rise (caused e.g. by too hot pumped media), the pump will eventually shut down completely. After cooling down, the pump will restart automatically.

## Technical Data

Motor design	Electronically commutated spherical motor with permanent magnet rotor/impeller
Voltage	8 - 24 Volt
Power consumption	see pump curves
Current draw	at 12 Volt: 0,25 - 1,9 A at 24 Volt: 0,25 - 1,5 A
Acceptable media	domestic hot water, heating water, water/glycol mixtures, other media on request* . IP 42 / Class F
Insulation class	
Max. system pressure	1 MPa (10 bar) for pumps with brass housing 0,15 MPa (1,5 bar) for pumps with plastic housing
Max. system temperature	-10 to + 95°C for pumps with brass housing (non-freezing) +/- 0 to + 60°C for pumps with plastic housing (non-freezing)
Weight	0,7 kg for pumps with brass housing 0,35 kg for pumps with plastic housing

\*please check pump performance with more than 20 % glycol

## Model names

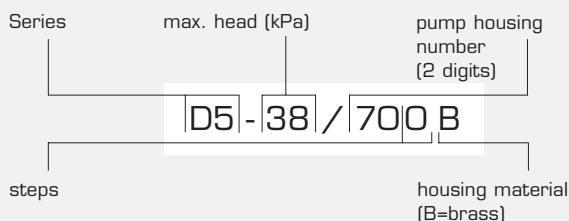

# Design

## DC pumps Ecocirc vario



Stator / Pump motor with red speed controller in the end cap

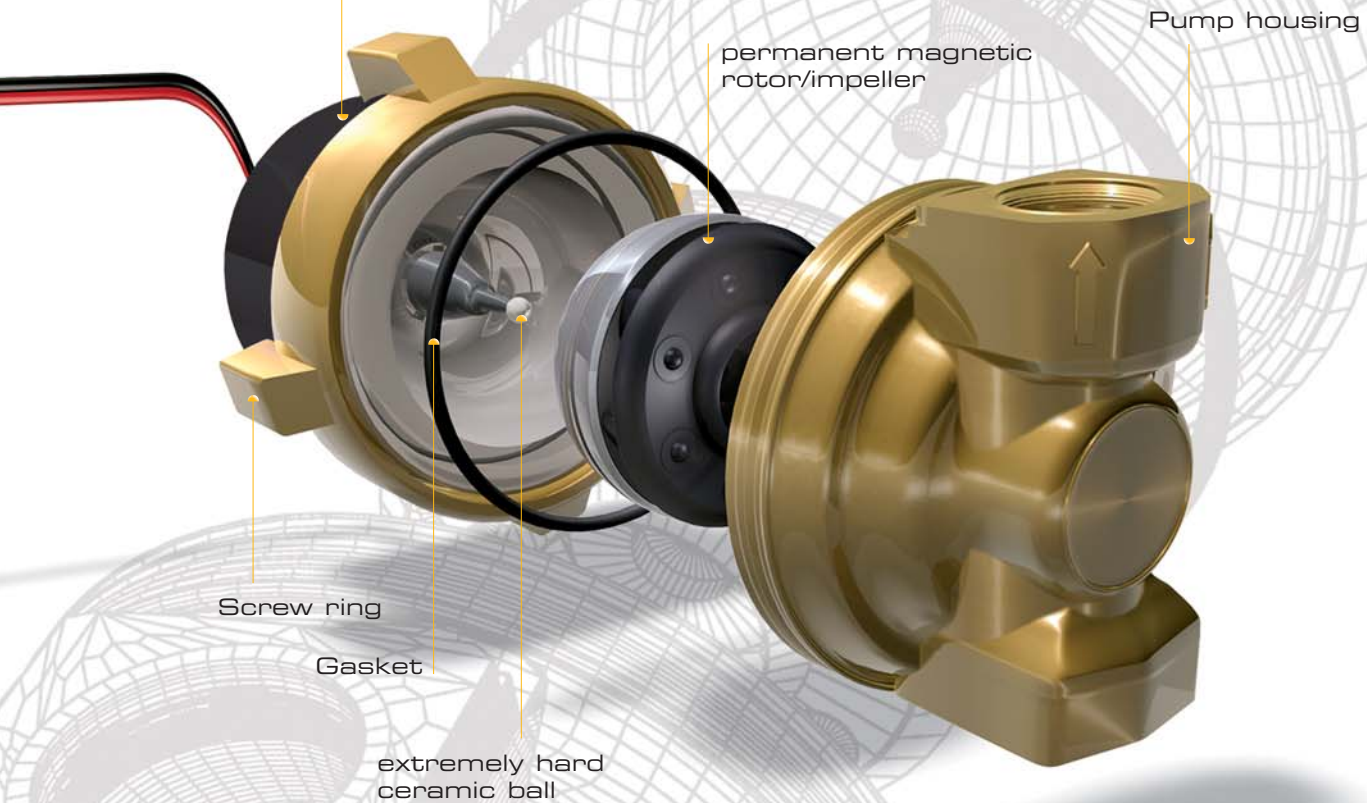

D5-38/700 B



D5-35/100 B



D5-38/830 N



D5-38/810 N



D5-38/790 N

### ecocirc® vario DC pumps

Model	Part number	Rated Input capacity	Pump housing material	Housing design / Length Others	Connection	Product category
D5-38/700 B	60 00 500	see pump curves	Brass	Inline / 65mm	1/2" female thread	H
D5-35/100 B	60 00 501		Brass	Inline / 110mm / RV+KV*	1 1/4" male thread**	
D5-38/830 N	60 00 502		Noryl	Angled housing	1/2" male thread	
D5-38/810 N	60 00 503		Noryl	Angled housing	1/2" hosebarb thread	
D5-38/790 N	60 00 504		Noryl	Angled housing	3/4" hosebarb thread	

\* integrated check valve and ball valve

\*\* for connection to 3/4" union components. Housing has additionally a 1/2" female connection

### ecocirc® vario Accessories, components and spare parts

Model	Part number	Description	Product category
F 72	95 00 732	Rotor/Impeller incl. gasket for Ecocirc vario D5	C
MW C	95 00 041	Mounting plate for Ecocirc vario D5	

# Dimensional drawings Ecocirc® vario

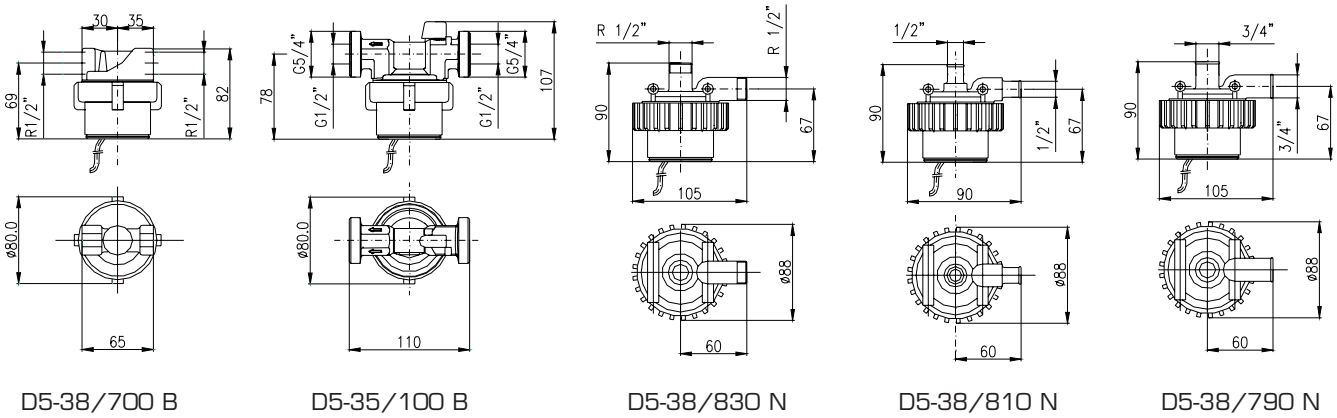

## Pump curves

Please note that the pump curves depend on the pump housing, the speed control setting and the supply voltage. We will be glad to give you more detailed information on request. All pump curves shown here are at 12 Volt and at different speed controller settings.



Speed control settings / RPM:  
 P1: 1.800 RPM      P2: 2.550 RPM      P3: 3.300 RPM  
 P4: 4.050 RPM      P5: 4.800 RPM

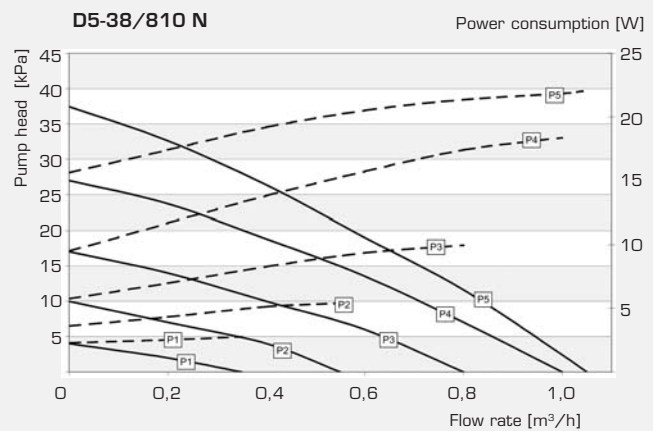
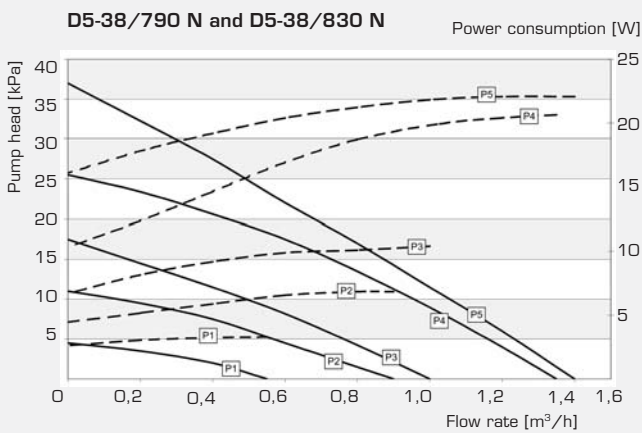
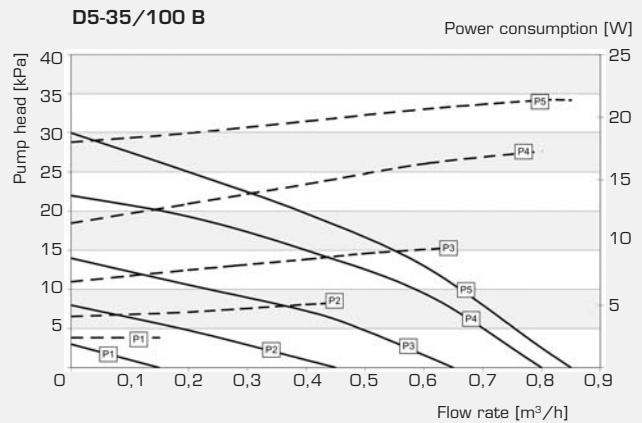
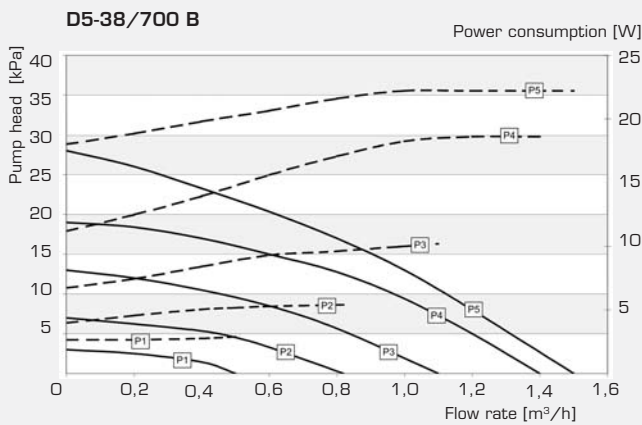

221206 Subject to change without notice

