

Solid State Sensors

Applying Linear Output Hall Effect Transducers

INTRODUCTION

The SS9 Series Linear Output Hall Effect Transducer (LOHET™) provides mechanical and electrical designers with significant position and current sensing capabilities. Sensor characteristics and applications are discussed in this section.

SENSOR DESCRIPTION

Physical dimensions, magnetic characteristics and electrical parameters are covered on page 19.

Figure 2 shows the block diagram of the SS9. The elements which make up these transducers are: a Hall effect element, temperature compensating amplifier and output transistor. Three thick film resistors are incorporated in the design. Sensitivity adjustment and temperature compensation is provided, and one resistor is trimmed for the offset voltage.

Figure 1
Linear Output Hall Effect Transducer (LOHET™)

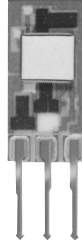
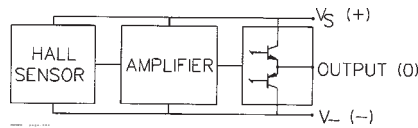

Figure 2
Block Diagram



Solid State Sensors

Applying Linear Output Hall Effect Transducers

MAGNETICS

The SS9 is magnetically actuated. **Figure 3** through **Figure 6** represent a few of the ways a magnetic system can be presented to the LOHET™ for position measurement. The method of actuation will be determined based upon cost, performance, accuracy and other requirements for a given application.

Head-on sensing

A simple method of position sensing is shown in **Figure 3**. One pole of a magnet is moved directly to or away from the sensor. This is a unipolar head-on position sensor. When the magnet is farthest away from the sensor, the magnetic field at the sensing face is near zero gauss. In this condition, the sensor's nominal output voltage will be six volts with a 12 volt supply. As the south pole of the magnet

approaches the sensor, the magnetic field at the sensing surface becomes more and more positive. The output voltage will increase linearly with the magnetic field until a +400 gauss level or nominal output of 9 volts is reached. The output as a function of distance is nonlinear, but over a small range may be considered linear.

Figure 3
Unipolar Head-On Position Sensor

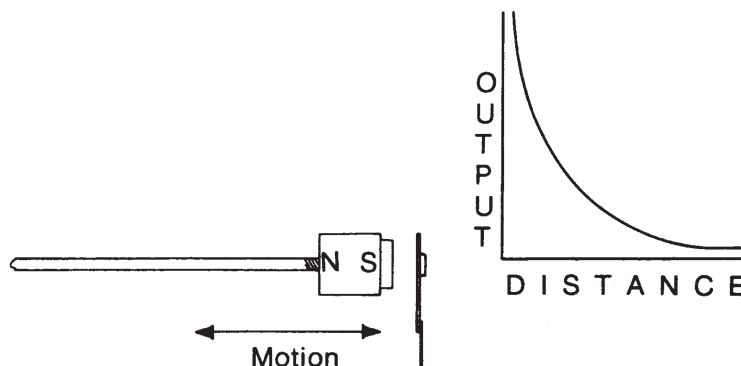

Bipolar head-on sensing

Bipolar head-on sensing is shown in **Figure 4**. When the magnets are moved to the extreme left, the SS9 is subjected to a strong negative magnetic field by magnet #2, forcing the output of the sensor to a nominal 3.0 volts. As magnet #1 moves toward the sensor, the magnetic field becomes less negative, until the fields of magnet #1 and magnet #2 cancel each other, at the midpoint between

the two magnets. The sensor output will be a nominal 6.0 volts. As magnet #1 continues toward the sensor, the field will become more and more positive until the sensor output reaches 9.0 volts. This approach offers high accuracy and good resolution as the full span of the sensor is utilized. The output from this sensor is linear over a range centered around the null point.

Figure 4
Bipolar Head-On Position Sensor

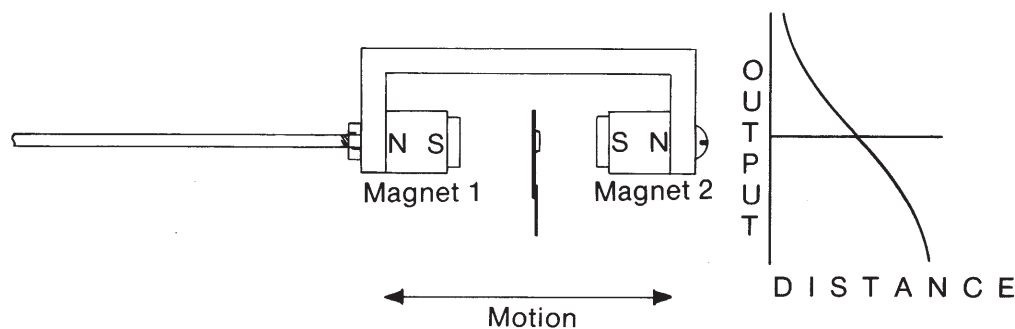

Solid State Sensors

Applying Linear Output Hall Effect Transducers

Biased head-on sensing

Biased head-on sensing, a modified form of bipolar sensing, is shown in **Figure 5**. When the moveable magnet is fully retracted, the SS9 is subjected to a negative magnetic field by the fixed bias magnet. As the moveable magnet approaches the

sensor, the fields of the two magnets combine. When the moveable magnet is close enough to SS9, the sensor will "see" a strong positive field. This approach features mechanical simplicity, and utilizes the full span of the SS9.

Figure 5
Biased Head-On Position Sensor

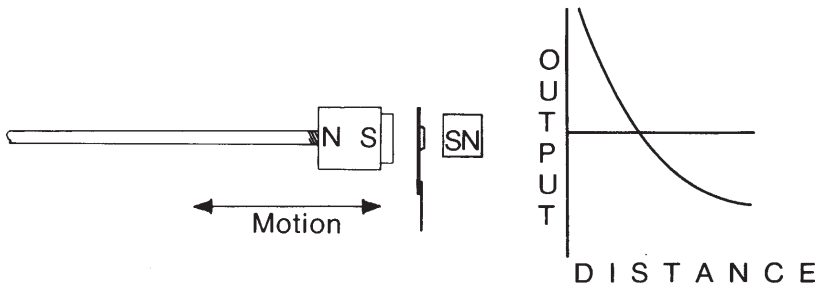

Slide-by sensing

Slide-by actuation is shown in **Figure 6**. A tightly controlled gap is maintained between the magnet and the SS9. As the magnet moves back and forth at that fixed gap, the field seen by the sensor becomes negative as it approaches the north pole, and positive as it approaches the south pole. This type of position sensor features mechanical simplicity and when used with a long enough magnet,

can detect position over a long magnet travel. The output characteristic of a bipolar slide-by configuration is the most linear of all systems illustrated, especially when used with a pole piece at each pole face. However, tight control must be maintained over both vertical position and gap to take advantage of this system's characteristics.

Figure 6
Slide-By Position Sensor

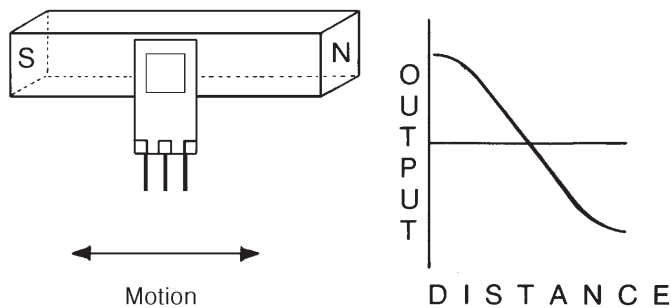

LINEARIZING OUTPUT

The output of the sensor as a function of magnetic field is linear, while the output as a function of distance may be quite nonlinear as shown in **Figure 3**. Several methods of converting sensor output to one which compensates for the non-linearities of magnetics as a function of distance are possible. One involves converting the analog output of the SS9 to digital form. The digital data is fed to a microprocessor which linearizes the output through a ROM look-up table, or transfer function computation techniques. A second method involves implementing an analog circuit which has the necessary transfer function to linearize the sensor's output. **Figure 7A** diagrams the microprocessor approach, and **Figure 7B** diagrams the analog circuit approach.

Figure 7A
Microprocessor Linearization

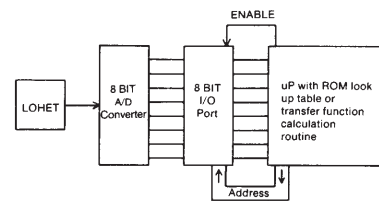
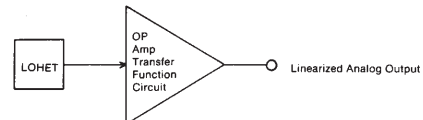

Figure 7B
Analog Linearization



A third method for linearizing the SS9 output can be realized through magnetic design by altering the geometry and position of the magnets used. These types of magnetic assemblies are not normally designed using theoretical approaches. In most instances, it is easier to design magnetics empirically by measuring the magnetic curve of the particular assembly. By substituting a calibrated Hall element for the variety of magnetic systems available, the designer can develop systems which perform a wide variety of sensing functions.

Solid State Sensors

Applying Linear Output Hall Effect Transducers

SENSOR APPLICATIONS

Liquid level measurement

Determining the height of a float is one method of measuring the level of liquid in a tank. **Figure 8** illustrates an arrangement of a LOHET and a float in a tank made of non-ferrous material (aluminum). As the liquid level goes down, the magnet moves closer to the sensor, causing an increase in output voltage. This system allows liquid level measurement without any electrical connections inside the tank.

Figure 8
LOHET™ Float Height Detector

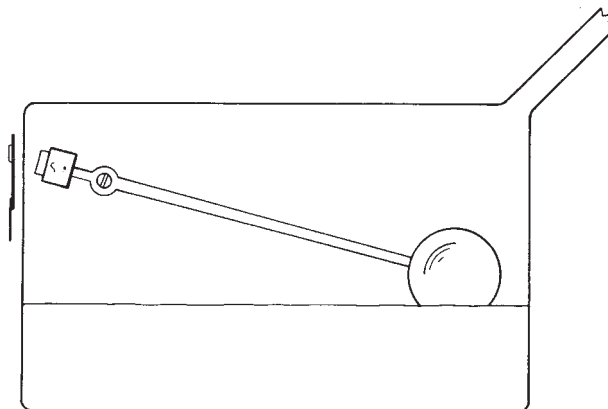

Flow meter

Figure 9 shows how LOHET could be used to make a flow meter. As the flow rate through the chamber increases, a spring loaded paddle turns a threaded shaft. As the threaded shaft turns, it raises a magnetic assembly that actuates the sensor. When flow rate decreases, the coil spring causes the assembly to lower, reducing the output. The magnetic and screw assemblies of the flow meter are designed to provide a linear relationship between the measured quantity, flow rate, and the output voltage of the sensor.

Figure 9
LOHET™ Float Meter

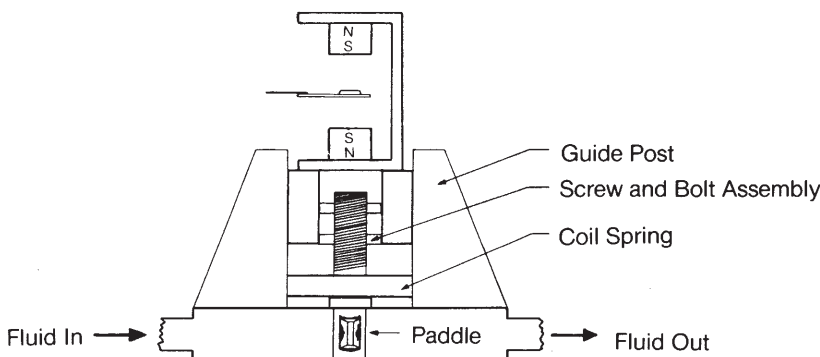

Current sensing

LOHET sensors need not be used exclusively with permanent magnets. Since the magnetic field in an unsaturated electromagnet varies linearly with current, a LOHET may be used to sense current. **Figure 10** illustrates a simple current sensor. The coil around the toroid is placed in series with the line and the sensor is placed in the gap. The magnetic field in this gap varies linearly with current, thus producing a voltage output proportional to the current. This type of sensor could be used in applications such as a motor control with current feedback.

Figure 10
LOHET™ Current Sensor

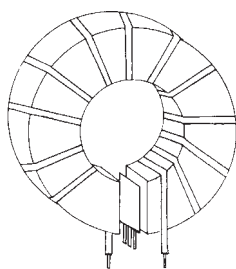
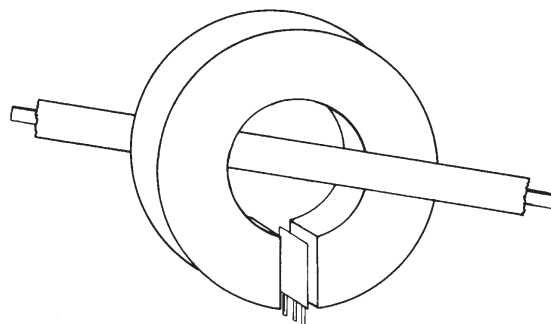

Figure 11
LOHET™ High Current Sensor



The magnetic field in an electromagnet is not only a function of current, but also of the number of turns on the core. If the current to be measured is greater than 30 amperes, a single turn design can be used, such as shown in **Figure 11**. This type of sensor is particularly useful in high current systems where broad dynamic range, low series resistance, and a linear current measurement are required.

Solid State Sensors

Applying Linear Output Hall Effect Transducers

Magnetics

Figure 12 is a semi-logarithmic graph of gauss versus distance for various bar magnets. Each curve is from a single magnet in the head-on mode of operation. The most stable operation at any given distance is obtained by using the magnet that provides the greatest rate of change in gauss at that distance. The best accuracy for any give magnet in the head-on mode of operation is at 400 gauss (40.0 mT).

Although the output is linear as a function of magnetic field, it is not linear as a function of distance. Therefore, the head-on mode of operation does not provide a linear output voltage versus distance. In an application requiring use of the head-on mode of operation, a microcomputer with a look-up table can be used to convert the LOHET™ output to a linear voltage.

Gauss patterns for typical ring magnets are shown in **Figures 13A and 13B**. There is an angular distance around zero gauss level where the gauss versus degrees of rotation approaches linearity. The number of poles on the magnet determines the number of degrees of rotation where this relationship holds true. The spacing between the magnet and the sensor determines the gauss level at which the relationship between gauss and degrees is most linear.

Figure 12

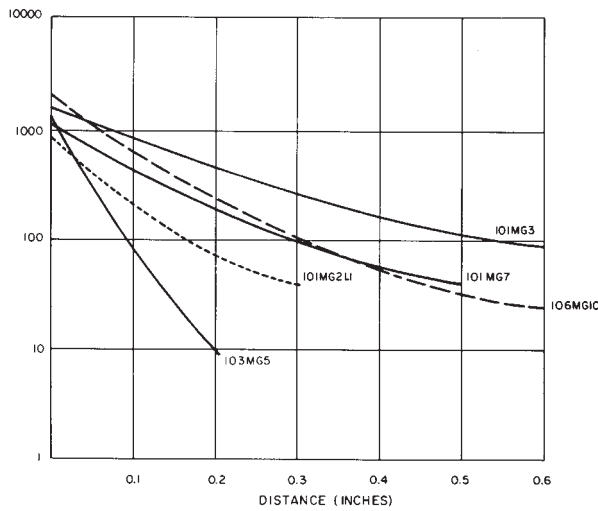

Figure 13A

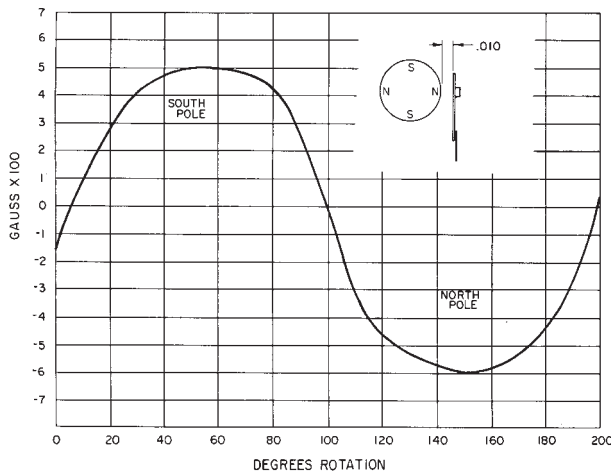
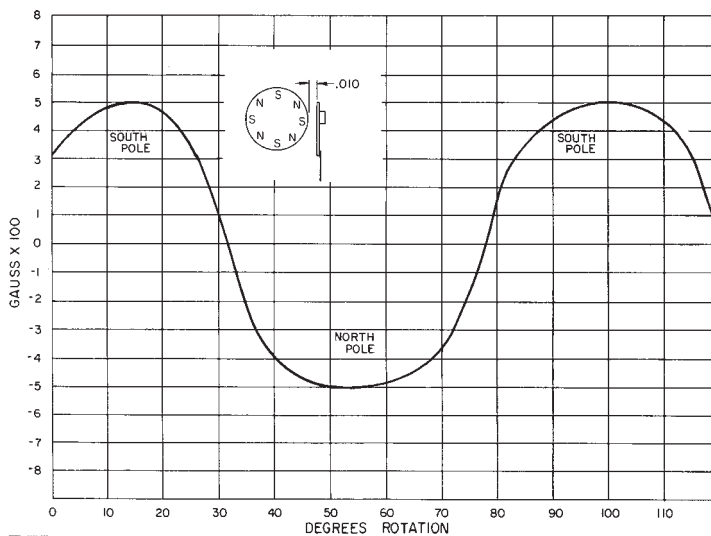

Figure 13B



Solid State Sensors

Applying Linear Output Hall Effect Transducers

Figure 14 illustrates the use of two magnets to obtain a linear relationship between distance and gauss. The distance over which the relationship is most nearly linear depends on the magnets used, and the gap length between the magnets. The assembly in **Figure 14** moves perpendicularly to the LOHET™. If travel is limited to prevent the magnets from touching the LOHET™, the assembly can be used in angular measurements. Non-magnetic material such as aluminum or brass should be used for the magnet mounting bracket.

Two-magnet arrangements are also shown in **Figure 15A and 15B**. The spacing between the magnets and the LOHET™ must be held constant for repeatable operation. Curves are shown for several gap spacings between the magnets and the LOHET™. These assemblies are most useful when a high rate of change in gauss over a short travel is required.

Figure 14

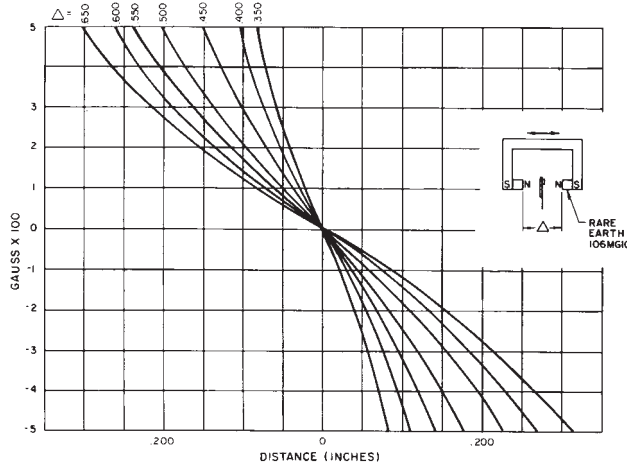

Figure 15A

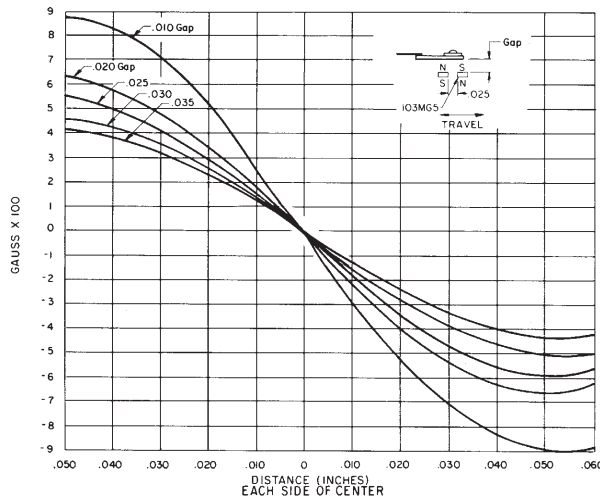
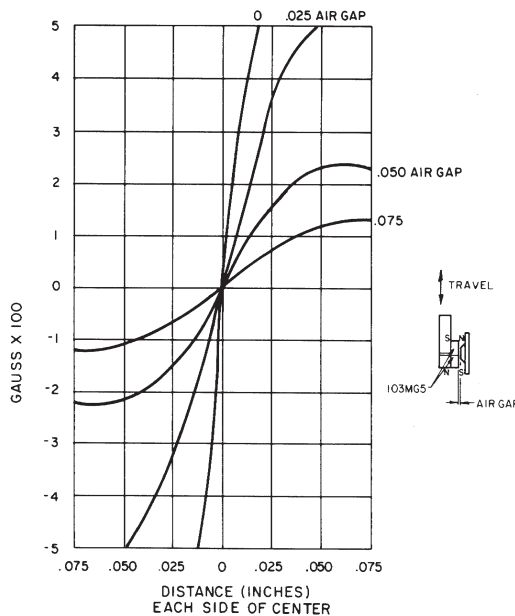

Figure 15B



Solid State Sensors

Applying Linear Output Hall Effect Transducers

Relatively long distances with a linear relationship can be realized with the arrangement shown in **Figures 16A and 16B**. The pole piece (flux concentrator) mounted behind the LOHET™ should be equal to or greater than twice the length of the magnet. The pole pieces at each end of the magnet extend above the magnet. The area of extension is approximately 35% of the cross sectional area of the magnet. The magnet is usually 50% longer than the distance over which the linear relationship is desired. The relative sizes of the parts are shown in **Figure 16A and 16B**.

By using precisely placed magnets, the arrangements shown in **Figures 15 and 16** allow accurate measurement over a short distance when total travel is large, as shown in **Figure 17**.

Figure 16A

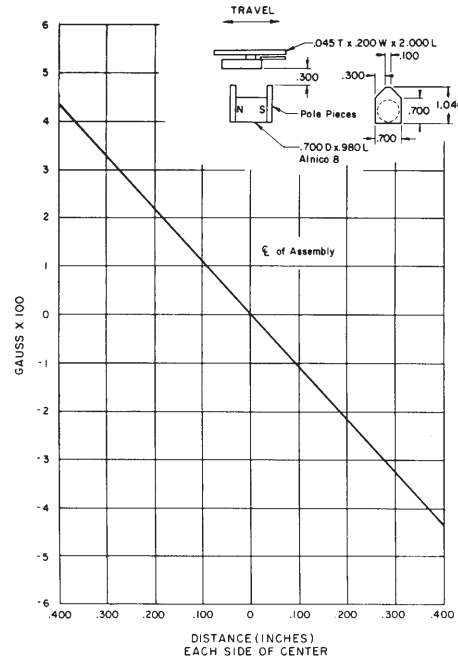

Figure 16B

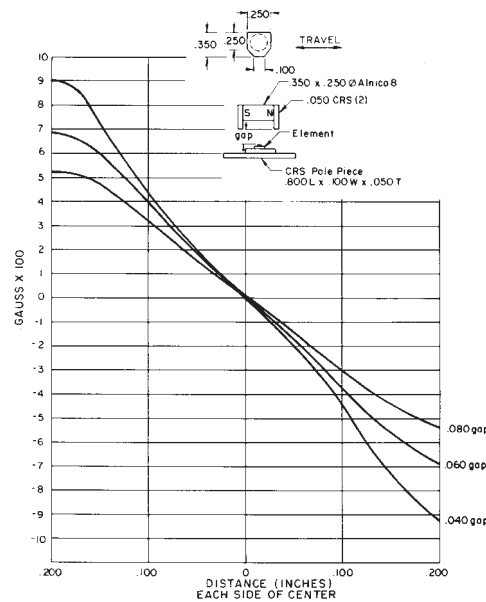
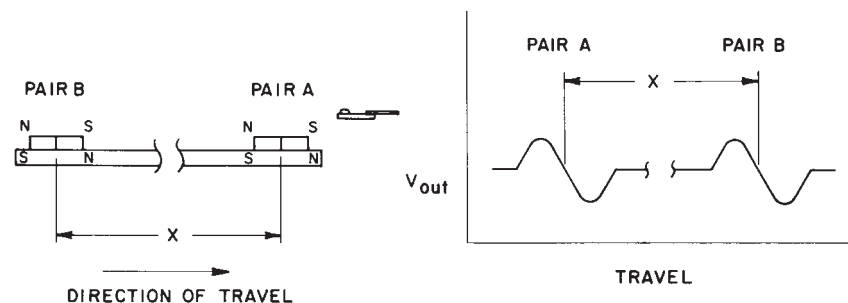

Figure 17



Solid State Sensors

Applying Linear Output Hall Effect Transducers

APPLICATION

An arm is rigidly attached to a shaft that rotates 90° (Figure 18). The movement of the arm is rapid until it approaches the final position. Then it is to move slowly to the exact position required. A microcomputer based control system is used.

Solution

At zero gauss (center point of the magnet), the variations of I_g due to setup will not change the gauss level. When the arm rotates the full 90° , the gauss level at the LOHET™ will be zero.

1. At some time during the machine cycle, when the magnet is away from the LOHET™, read the voltage through an A/D converter (either on board the computer, or a separate device). This reading serves as the reference for this cycle.
2. Monitor the output voltage during the cycle or generate an interrupt as the zero degree point is approached.
3. When the linear region is reached, the output voltage can be converted by the microcomputer to degrees rotation or distance, as desired.
4. When the LOHET™ output voltage matches the reference from step 1, the arm is at the desired point.

This method provides continuous calibration so that any changes due to temperature variations of the A/D conversion or of the LOHET™, do not influence the measurement. An electromagnet driven by the microcomputer can be used in place of the permanent magnet.

Figure 18

