

Features

Regulated Converters

- SMD Constant Current LED Driver
- Built-in Class A or Class B EMC Filter
- Wide Input and Output Voltage Range
- Digital PWM and Analogue Voltage Dimming
- Short Circuit and Overtemperature Protected
- Low Cost
- EN/RAILWAYS Certified
- 5 Year Warranty

Description

The RCD-24-xxx/PL series is a step-down constant current source designed for driving high power LEDs. The converter uses a pinless SMD open frame design to reduce cost and size. Output currents available are 300mA, 350mA, 500mA, 600mA, 700mA and 1000mA with either Class A (Suffix /A) or Class B (suffix /B) built-in EMC filtering. Despite its compact size, the RCD-PL series is fully featured with very high efficiency, wide input voltage range, high ambient operating temperature and two means of LED dimming: PWM/digital control and analogue voltage dimming. Both dimming controls are independent and can be combined. The driver is also designed to be as reliable as the LEDs it is driving, even at the full ambient operating temperature and is designed for strip lighting, wall washers and fluorescent tube replacement designs, where a low profile and narrow width are demanded.

Selection Guide

Part Number	Input Range (VDC)	Output Current (mA)	Output Voltage (Vmin-Vmax)	Dimming Control	Mounting Style
RCD-24-0.30/PL*	4.5-36V	0-300	2-35	Digital + Analogue	Pinless SMD
RCD-24-0.35/PL*	4.5-36V	0-350	2-35	Digital + Analogue	Pinless SMD
RCD-24-0.50/PL*	4.5-36V	0-500	2-35	Digital + Analogue	Pinless SMD
RCD-24-0.60/PL*	4.5-36V	0-600	2-35	Digital + Analogue	Pinless SMD
RCD-24-0.70/PL*	4.5-36V	0-700	2-35	Digital + Analogue	Pinless SMD
RCD-24-1.00/PL/A	6-36V	0-1000	2-32	Digital + Analogue	Pinless SMD

* /A for EMC Class A input Filter add -R for Tape and Reel Packaging e.g. RCD-24-0.35/PL/B-R

* /B for EMC Class B input Filter

Note: RCD-24-1.00/PL/A only available with Class A Filter

Specifications (typical at 25°C, nominal input voltage, rated output current unless otherwise specified)

Input Voltage (absolute maximum)	40VDC max	
Recommended Input Voltage	6V min. / 24V typ. / 36VDC max	
Input Filter	Suffix /A Suffix /B RCD-24-1.00/PL/A	Capacitor Class B with Pi Filter Class A with Pi Filter
Output Current Accuracy (Vin=24V)	300-700mA 1000mA	±2% typ, ±3% max ±3% typ, ±5% max
Internal Power Dissipation	Worst case load of 5 LEDs (300-700mA) Worst case load of 8 LEDs (1000mA), Vin=36V	700mW max. 1.6W typ.
Output Current Stability	Vin = 36V, Vout = 1-9 LEDs (300-700mA) Vin = 36V, Vout = 1-8 LEDs (1000mA)	±1% max ± 1.5% max.
Output Ripple and Noise (20MHz BW)	Vin=36V, Vout = 1-9 LEDs (300-700mA) Vin=36V, Vout = 1-8 LEDs (1000mA)	300mVp-p max
Temperature Coefficient	-40°C to +85°C ambient ±0.015%/°C max	
Maximum Capacitive Load	100µF	
Operating Frequency	300-1000mA	212kHz min/ 250kHz typ/ 280kHz max
Efficiency at Full Load	300-700mA Vin=36V, Vout=8 LEDs (1000mA)	96% typ. 94% typ.
Short Circuit Protection	Regulated at rated output current	
Operating Temperature Range	300/350mA 500mA 600/700mA 1000mA	-40°C to +85°C -40°C to +80°C -40°C to +75°C -40°C to +65°C
Storage Temperature Range	-55°C to +125°C	
Relative Humidity	5% to 95% RH, non-condensing	

continued on next page

LIGHTLINE

DC/DC-Converter

with 5 year Warranty

RECOM

Constant Current LED Driver



E358085

EN-50121-3-2 Certified

EN-60950-1 Certified

UL-60950-1 Certified

RCD-24-PL

Derating Graph

(Ambient Temperature)

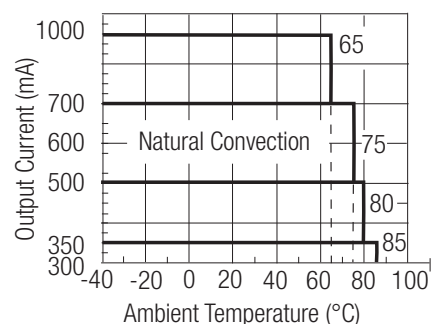

Refer to Application Notes

Specifications (typical at 25°C, nominal input voltage, rated output current unless otherwise specified)

Dimensions	31.0 x 11.4 x 6.6mm	
Weight	1.9g	
Packing Quantity	12 pcs per Tube / 400 pcs per Reel	
Reflow Soldering Profile	265°C/10 sec max	
MTBF	25°C	>600 khours
(using MIL HDBK 217F)		

PWM Dimming and ON/OFF Control (Leave open if not used)

Remote ON/OFF	DC/DC ON	Open or $0V < V_r < 0.6V$
Threshold Voltages	DC/DC OFF (Standby)	$0.6 < V_r < 2.9V$
	DC/DC OFF (Full Shutdown)	$2.9V < V_r < 6V$
Remote Pin Drive Current	$V_r = 5V$	1mA max
Quiescent Input Current in Shutdown Mode	$V_{in} = 36V$	200µA max
Recommended PWM Frequency (measured 10%~90% Dimming)	For Linear Operation	200Hz
	Maximum Frequency	1000Hz

Analogue Dimming Control (leave open if not used)

Input Voltage Range	300-1000mA	-0.3V - 15V
Control Voltage Range Limits (see Graph)	300-1000mA / Full On	$0.13V \pm 50mV$
	300-700mA / Full Off	$4.2V \pm 150mV$
	1000mA / Full Off	$4.35V \pm 100mV$
Analogue Pin Drive Current	300-1000mA / $V_c = 5V$	0.2mA max.

Environmental

Shock / Vibration	EN61373	
EMC Railways	EN50121-3-2:2006	
Conducted Emissions	300-1000mA (/A Suffix)	EN55022 Class A
	300-700mA (/B Suffix)	EN55022 Class B
Radiated Emissions	EN55022 Class B	
ESD	EN61000-4-2 Class A	
Radiated Immunity	EN61000-4-3 Class A	
Fast Transient	EN61000-4-4 Class A	
Conducted Immunity	EN61000-4-6 Class A	

Note:

- All LED Drivers may not be used without a load. They must be switched on the primary side only. Noncompliance may damage the LED or reduce its lifetime.
- It is not possible to parallel the drivers to increase the current.

Digital Dimming

PWM Digital Control Signal

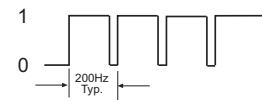

Output Current (LED appears dim)



PWM Digital Control Signal

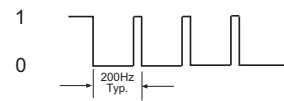

Output Current (LED appears bright)



Analogue Dimming

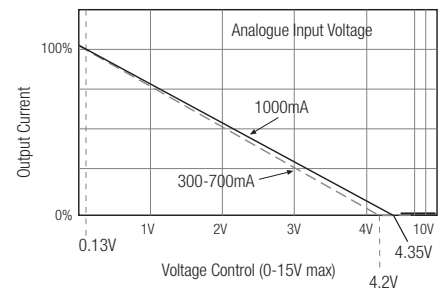

Typical Characteristics

$V_{in} = 24V, I_{out} = 300\sim 1000mA$

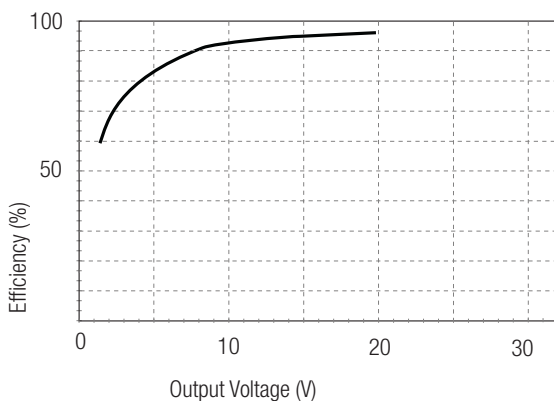

$V_{in} = 32V, I_{out} = 300\sim 1000mA$

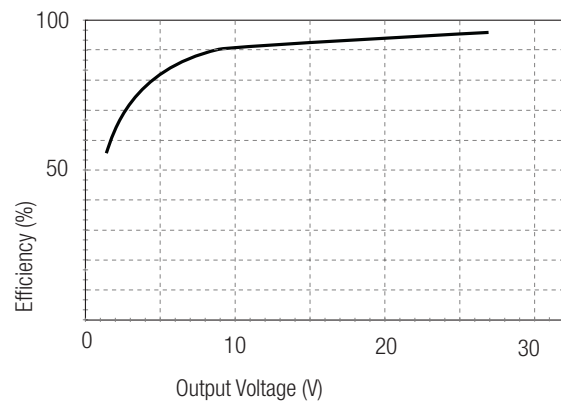

Package Style and Pinning

Class A Version

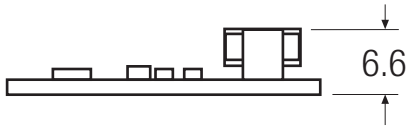

Class A (1.00A-Version)
Class B Version

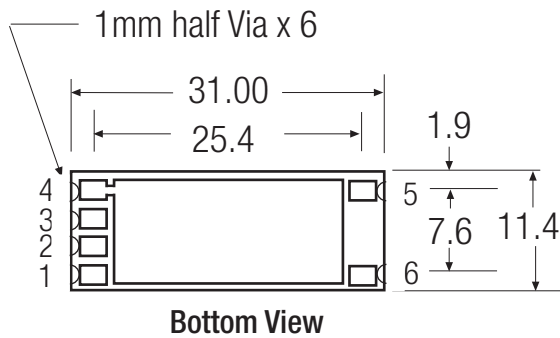

PCB Layout Top View

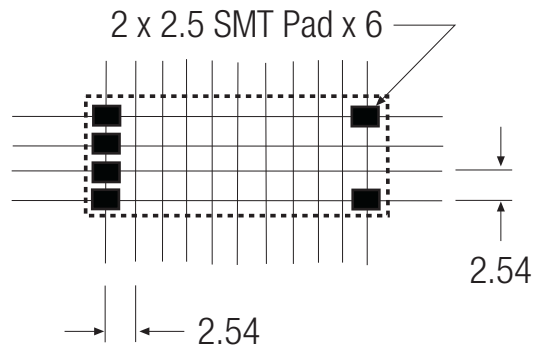

Pad Connections	RCD-24-PL Series	
Pad #	Out	Comments
1	+Vin	DC Supply
2	Analogue Dimming	Leave open if not used
3	PWM/ON/OFF	Leave open if not used
4	GND	Do not connect to -Vout
5	-Vout	LED Cathode Connection
6	+Vout	LED Anode Connection

XX.X ± 0.5 mm
XX.XX ± 0.25 mm