



Description

- Panel Mount:
Screw-on mounting from front side
- 2 Functions:
Appliance Inlet Protection class I, Line-filter in standard version
- Quick connect terminals 6.3 x 0.8 mm

Approvals

- VDE Certificate Number: 40004665 (FGS)
- UL File Number: E72928 (FGS)

Characteristics

- Compact design with optimal shielding
- All single elements are already wired
- Universal line filter for standard applications
- Suitable for use in equipment according to IEC/UL 60950

Weblinks

[pdf-datasheet](#), [html-datasheet](#), [General Product Information](#), [RoHS](#), [CHINA-RoHS](#), [REACH](#), [Mating Connectors](#), [e-Shop](#), [SCHURTER-Stock-Check](#), [Distributor-Stock-Check](#), [Accessories](#)

Newly available variants corresponding to V-Lock mating cordset. The connector is equipped with a notch intended for use with the latching cordset. The cord latching system prevents against accidental removal of the cordset.

Technical Data

Ratings IEC	1 - 10A @ Ta 40 °C / 250VAC; 50Hz
Ratings UL/CSA	1 - 10A @ Ta 40 °C / 125VAC; 60Hz
Leakage Current	standard < 0.5mA (250V / 60Hz)
Dielectric Strength	> 1.7kVDC between L-N > 2.7kVDC between L/N-PE Test voltage (2 sec)
Impulse Withstand Voltage	> 2.5kV between L-N (CX2) > 5kV between L/N-PE
Allowable Operation Temp.	-25 °C to 85 °C
Climatic Category	25/085/21 acc. to IEC 60068-1
Degree of Protection	from front side IP 40 acc. to IEC 60529
Protection Class	Suitable for appliances with protection class I acc. to IEC 61140
Terminal	Quick connect terminals 6.3 x 0.8 mm
Panel Thickness s	Screw: max 8 mm Mounting screw torque max 0.5Nm
Material: Housing	Thermoplastic, black, UL 94V-0

Appliance-Inlet/-Outlet	C14 acc. to IEC 60320, UL 498, CSA C22.2 no. 42 (for cold conditions) pin-temperature 70 °C, 10A, Protection Class I
Line Filter	Standard Version, IEC 60939, UL 1283, CSA C22.2 no. 8 Technical Details
MTBF	> 3'100'000h acc. to MIL-HB-217 F

Dimension

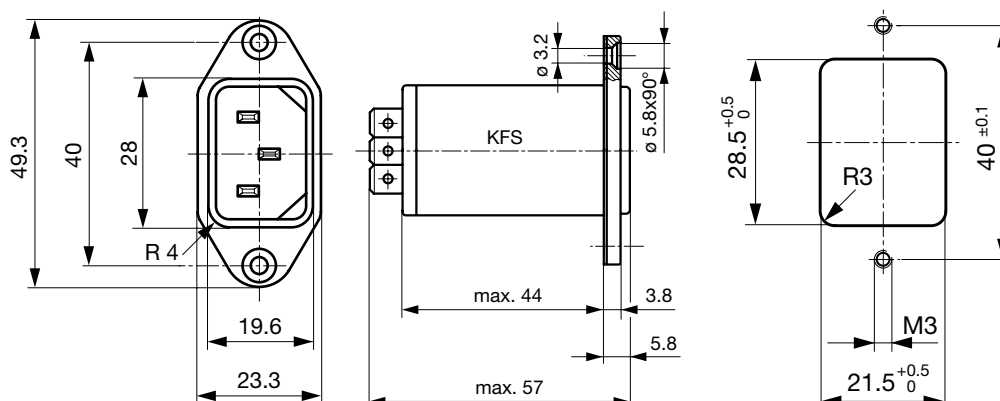

Technical Data of Filter-Components

Rated Current [A]	Filter-Type	Inductances L [mH]	Capacitance CX [nF]	Capacitance CY [nF]
1	Medical Version (M80)	2 x 10	47	0.47
1	Medical Version (M5)	2 x 10	47	-
2	Medical Version (M5)	2 x 4	47	-
4	Medical Version (M5)	2 x 1.5	47	-
6	Medical Version (M5)	2 x 0.8	47	-
10	Medical Version (M5)	2 x 0.3	47	-
1	Standard Version	2 x 10	47	2.2
2	Standard Version	2 x 4	47	2.2
4	Standard Version	2 x 1.5	47	2.2
6	Standard Version	2 x 0.8	47	2.2
10	Standard Version	2 x 0.3	47	2.2

Diagrams

Standard version

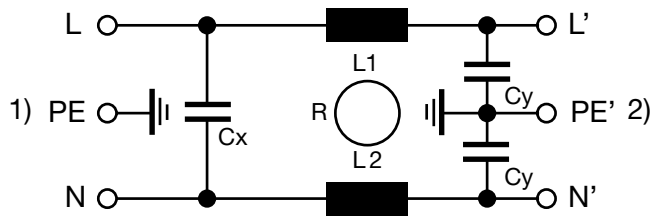

- 1) Line
- 2) Load

Attenuation Loss

- - - differential mode ____ common mode

Standard version

1 A

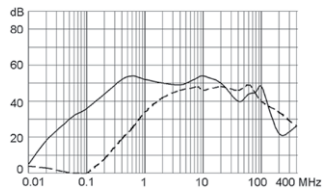

2 A

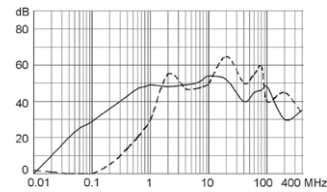

4 A

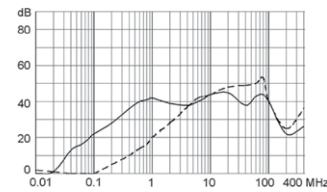

6 A

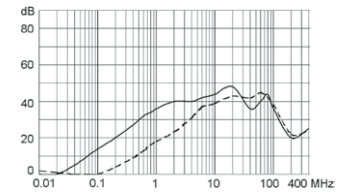

10 A

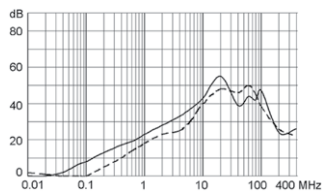

All Variants

Type	Rated Current [A]	Filter-Type	CX Class	Order Number
KFS	1	Standard Version	X2	4300.5051
KFS	2	Standard Version	X2	4300.5052
KFS	4	Standard Version	X2	4300.5053
KFS	6	Standard Version	X2	4300.5054
KFS	10	Standard Version	X2	4300.5055
KFS	1	Medical Version (M5)	X2	4300.5021
KFS	2	Medical Version (M5)	X2	4300.5022
KFS	4	Medical Version (M5)	X2	4300.5023
KFS	6	Medical Version (M5)	X2	4300.5024
KFS	10	Medical Version (M5)	X2	4300.5025
KFS	1	Medical Version (M80)	X2	4300.5031

Most Popular.

Availability for all products can be searched real-time: <http://www.schurter.com/en/Stock-Check/Stock-Check-SCHURTER>

Suffix ".21" corresponds to the version with V-Lock mating cordset. The connector is equipped with a notch intended for use with the latching cordset. The cord latching system prevents against accidental removal of the cordset.

Packaging unit 10 Pcs

Accessories

Description

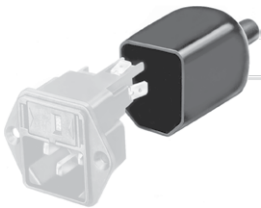

Assorted Covers
Rear Cover



Cord retaining kits
Cord retaining strain relief

Mating Outlets/Connectors

Category / Description



Appliance Outlet Overview complete

IEC Appliance Outlet F, Screw-on Mounting, Front Side, Solder Terminal	4787
IEC Appliance Outlet F, Snap-in Mounting, Front Side, Solder or Quick-connect Terminal	4788
IEC Appliance Outlet F or H, Screw-on Mounting, Front Side, Solder, PCB or Quick-connect Terminal	5091

Appliance Outlet further types to KFS



Connector Overview complete

IEC Connector C13, Rewireable, Straight	4782
IEC Connector C13, Rewireable, Straight	4022
IEC Connector C13, Rewireable, Angled	4785
IEC Connector C13, Rewireable, Angled	4300-06
IEC Connector C13, Rewireable, Angled	4012
Connector further types to KFS	...

Mating Outlets/Connectors shuttered



Power Cord Overview complete

Overview Power Supply Cord with IEC Connector C13, V-Lock, straight	VAC13KS
Power Cord further types to KFS	