

# RUGGED/POWER

INTERCONNECT SOLUTIONS GUIDE

# RUGGED/POWER INTERCONNECT SOLUTIONS

Ultra rugged systems, flexible power interconnects and rugged contact systems combined with rugged signal integrity offerings, create the foundation of Samtec's rugged/power solutions for high cycle, high power and high speed applications.

Additional testing for severe environments ensures products are more than suitable for military, space, automotive, industrial and other extreme applications. Samtec's rugged/power products are offered in conjunction with full engineering support, online tools and a service attitude that is unmatched in the connector industry.

## ULTRA RUGGED

Extreme High Mating Cycles

Rugged MIL-DTL Materials

Testing for Extreme/Harsh Applications

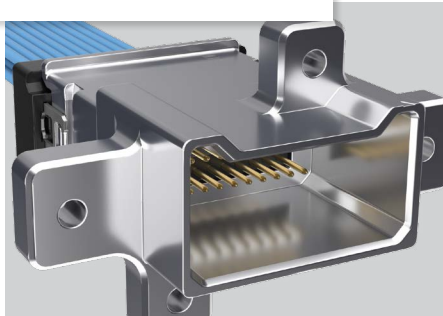

## FLEX POWER

3 to 60 Amps

Configurability of Power & Signal

Space-saving Form Factor

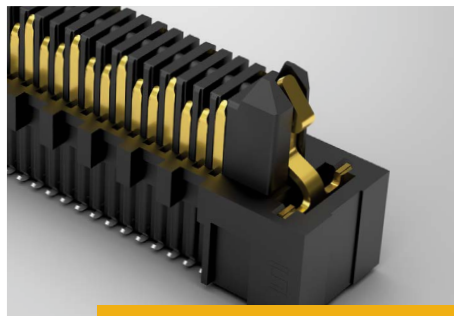
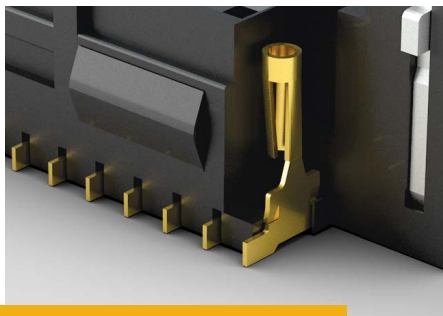
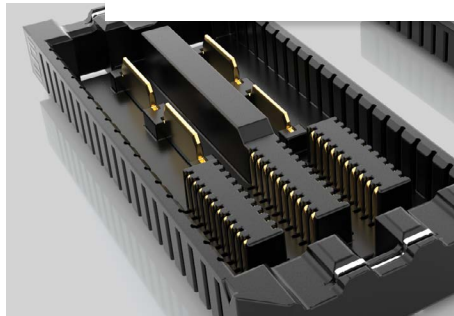

## RUGGED CONTACT SYSTEM

1,000+ Mating Cycles

Tiger Eye™ Heat-treated BeCu Contacts

Multiple Points of Contact  
for High-reliability

## RUGGED SIGNAL INTEGRITY

High Speeds to 56 Gbps PAM4

Edge Rate® Contact Design  
Increases Wear Life

Expertise in Signal Integrity  
Design & Analysis

**ULTRA RUGGED SOLUTIONS ..... 6-11**

- Rugged I/O Systems
- Rugged Optics
- VITA 90 VNX+ Solutions
- Hardware & Plating
- Ultra Rugged Testing (SET, E.L.P.™ & DQT)

**POWER SYSTEMS, TOOLS & SERVICE ..... 12-17**

- mPOWER® Ultra Micro Power Systems
- AcceleRate® mP Power/Signal Combination
- Mini Mate® & Power Mate® Isolated Power
- PowerStrip™ Extreme Power
- Power Integrity Services & Simulation Tool

**RUGGED I/O SYSTEMS..... 18-21**

- URSA™ I/O Rugged Power
- 38999 NovaRay® I/O Systems
- FireFly™ Extreme Environment Optics
- FireFly™ Extended Temp Optics
- AccliMate™ Flexible Sealed Systems

**RUGGED BOARD-TO-BOARD SYSTEMS ..... 22-25**

- Tiger Eye™ Rugged Contact System
- Mini Mate® & Power Mate® Individually Shrouded Power
- mPOWER® Ultra Micro Power Systems
- Razor Beam™ Hermaphroditic
- Floating and One-Piece Interfaces

**RUGGED HIGH-SPEED SYSTEMS..... 26-29**

- Edge Rate® Rugged, High-Speed Contact System
- High-Speed, High-Density & Micro Edge Cards
- AcceleRate® mP Signal/Power Arrays
- Q Series® Integral Ground Plane Connectors
- Razor Beam™ Hermaphroditic Interfaces

**DISCRETE WIRE CABLE ASSEMBLIES ..... 30-33**

- Micro Mate™ 1.00 mm Pitch Systems
- Rugged Tiger Eye™ Systems
- Mini Mate® & Power Mate® Isolated Power
- mPOWER® Ultra Micro Power
- PowerStrip™ Extreme Power

- Rugged Features & Custom Solutions ..... 34-35
- Sudden Service® & Online Tools ..... 36-37
- Integration Leads to Innovation & Silicon-to-Silicon™ Solutions ..... 38-39



# RUGGED/POWER

## PRODUCT OVERVIEW

6-11



### ULTRA RUGGED SOLUTIONS

RUGGED & 38999 I/O | VITA 90 VNX+ | EXTREME ENVIRONMENT OPTICS | RUGGED HARDWARE  
HIGH-RELIABILITY PLATING | SEVERE ENVIRONMENT TESTING

22-25

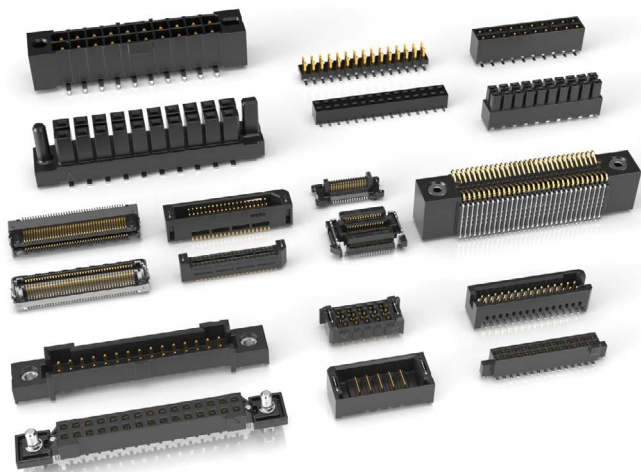

### RUGGED BOARD-TO-BOARD

HIGH CYCLE CONTACTS | ISOLATED POWER  
ULTRA MICRO POWER | HERMAPHRODITIC | ONE-PIECE

26-29

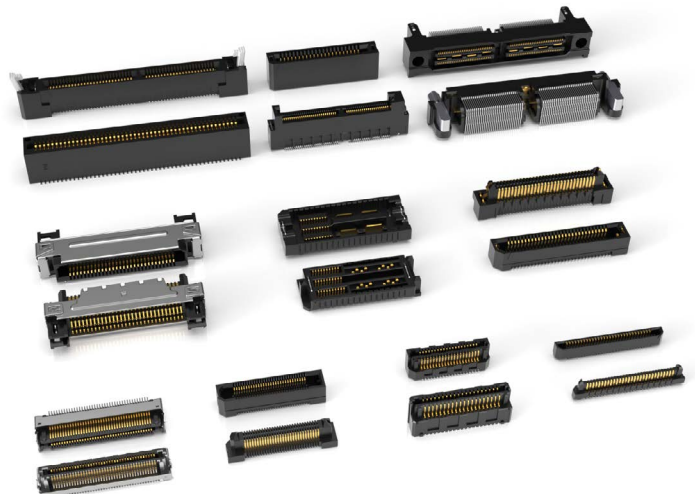

### RUGGED HIGH-SPEED

RUGGED SIGNAL INTEGRITY CONTACTS | EDGE CARDS  
SIGNAL/POWER COMBOS | GROUND/POWER PLANE | SELF-MATING



12-17

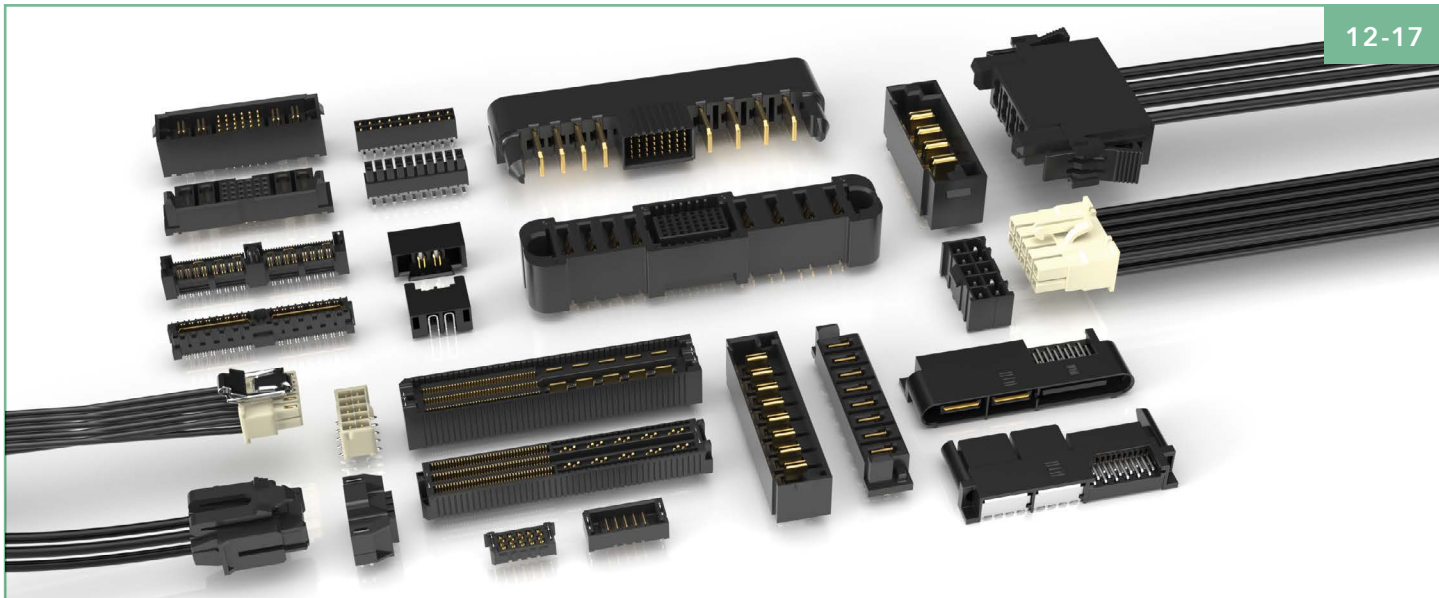

## POWER SYSTEMS

ULTRA MICRO POWER | POWER/SIGNAL COMBINATIONS | INDIVIDUALLY SHROUDED POWER  
60 AMP EXTREME POWER | FLEXIBLE POWER STACKING | INTEGRAL GROUND/POWER PLANE

30-33



## DISCRETE WIRE CABLE

MICRO PITCH | HIGH CYCLE CONTACTS  
ISOLATED POWER | ULTRA MICRO POWER | HIGH POWER

18-21



## RUGGED I/O SYSTEMS

POWER I/O | 38999 | EXTREME ENVIRONMENT OPTICS  
EXTENDED TEMP OPTICS | FLEXIBLE SEALED

# ULTRA RUGGED SOLUTIONS

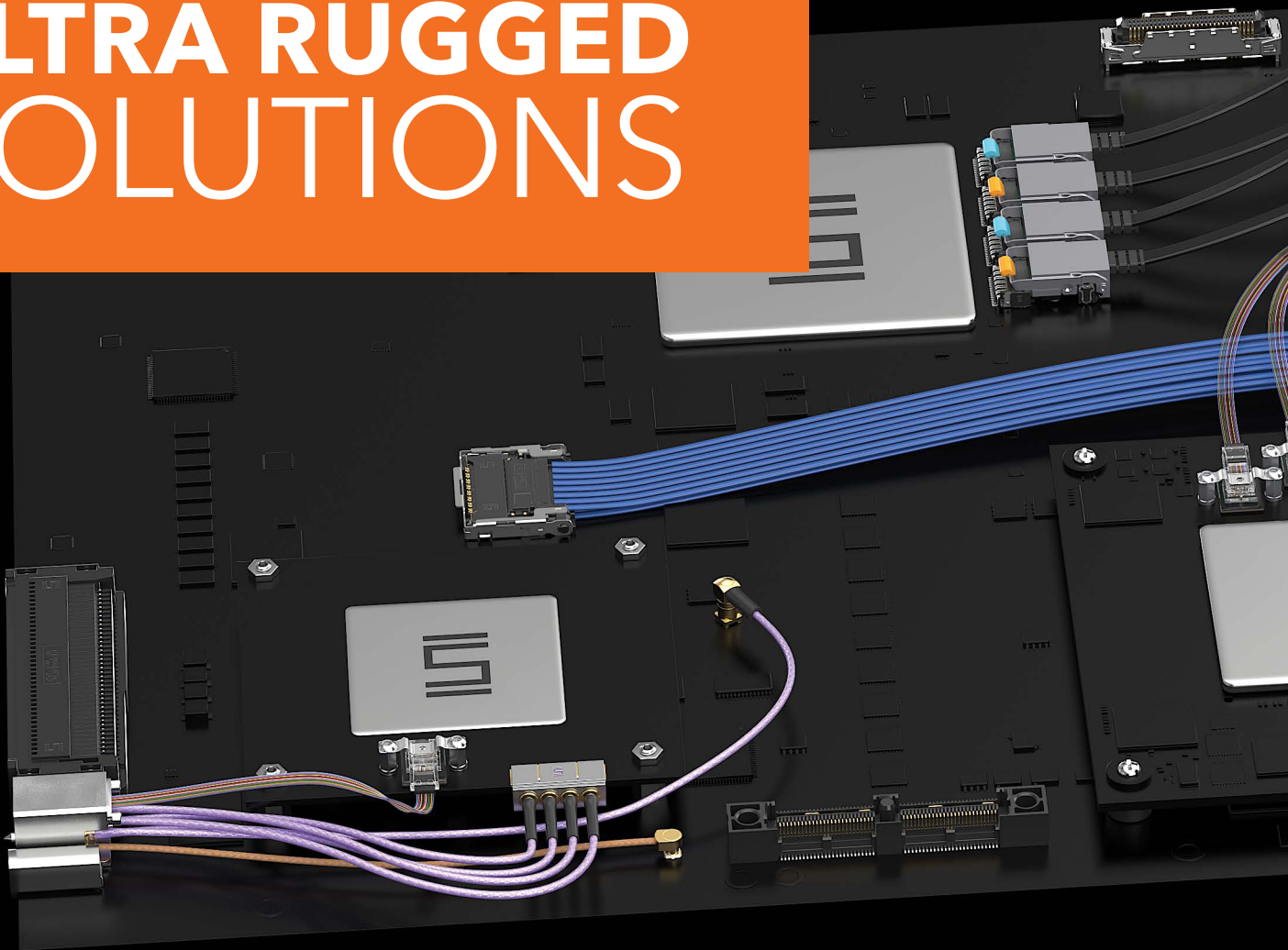

Samtec's ultra rugged solutions provide reliability and flexibility in small form factors for extreme/harsh environments. From rugged I/O cable assemblies, sealed & compact optics, and VITA 90 VNX+ modules to ultra rugged hardware and high-temp coatings, these solutions are ideal for military, aerospace, submersible and other harsh environment applications. Many Ultra Rugged offerings are available now with a robust roadmap to meet or exceed requirements for harsh environment applications and industries.

For design flexibility and cost optimization, Samtec's Severe Environment Testing (SET) qualified products are Commercial-Off-the-Shelf (COTS) and modified COTS to get solutions to market faster. See page 10-11 or visit [samtec.com/set](http://samtec.com/set) for more information.

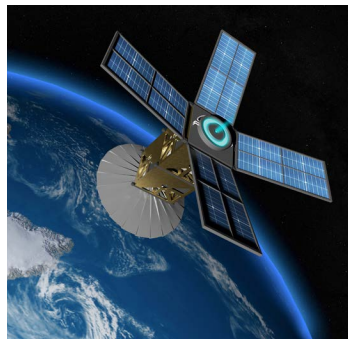

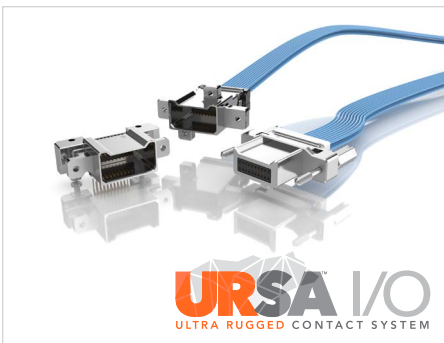
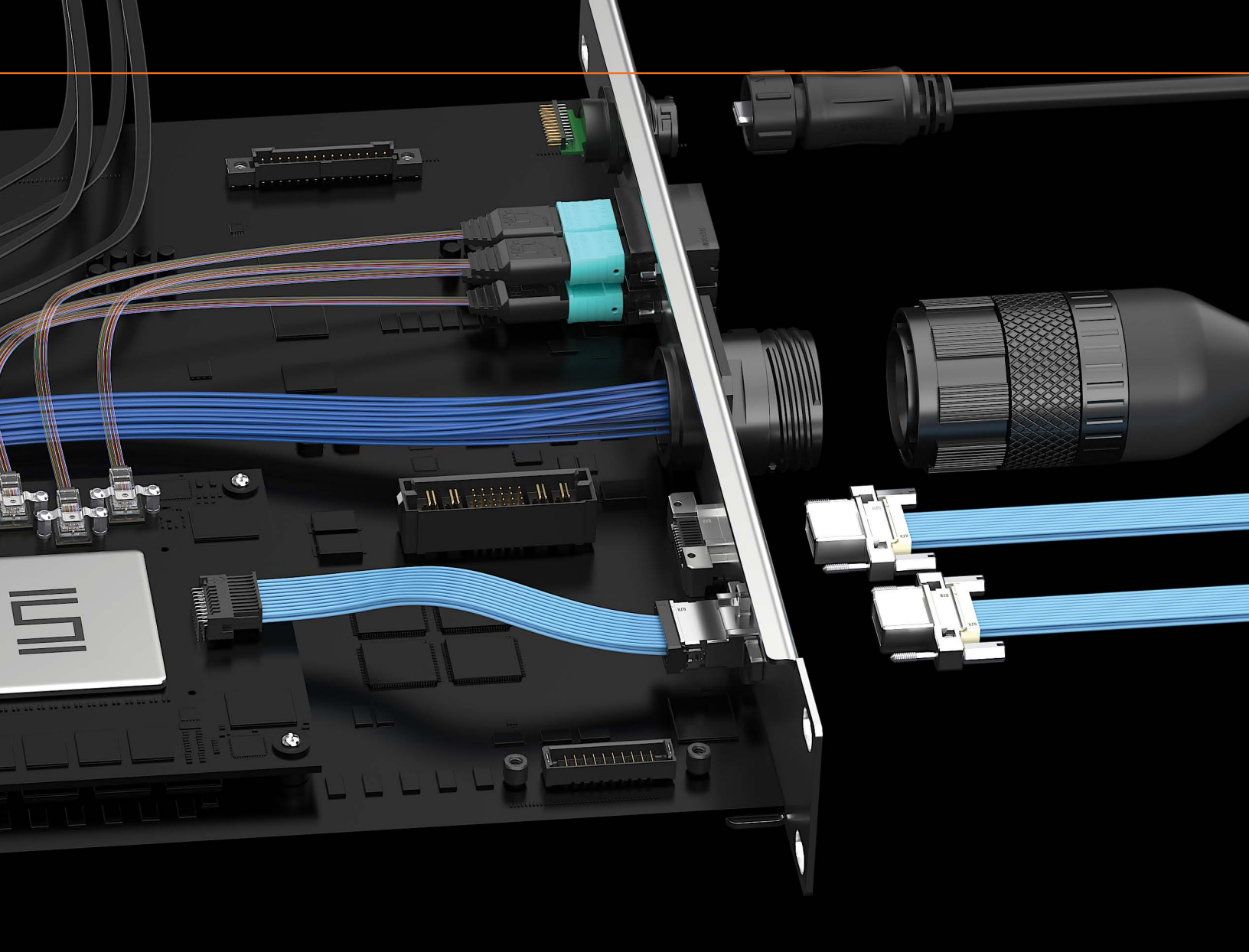

### RUGGED POWER I/O SYSTEMS

- Four points of contact for a reliable connection and high mating cycles
- Extreme density with up to 1,450 I/Os in a 1RU panel
- EMI shielding limits signal degradation and optimizes performance
- Series: B1SD(T)/P1PD(T)/P1M
- See page 18-19 for more information
- [samtec.com/ursa](http://samtec.com/ursa)



### 38999 RUGGED I/O SYSTEMS

- High data rate cable system in a rugged 38999 shell
- Salt fog resistant to 48 hours
- IP67 for dust and waterproof sealing
- Threaded cable-to-panel design
- High-density 16 pair; 32 on roadmap
- Series: NVA3E/NVA3P
- [samtec.com/novaray-io](http://samtec.com/novaray-io)





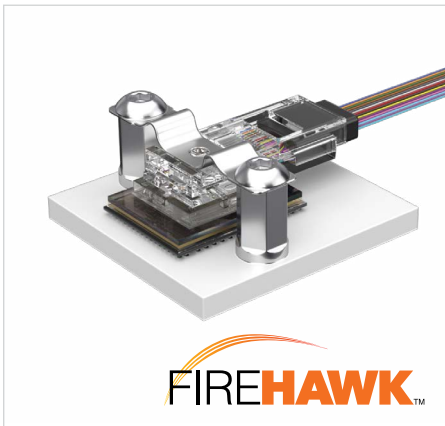

### ULTRA RUGGED/COMPACT OPTICS

- FireHawk™ is the smallest optical transceiver in the industry - 10 x 7.7 x 2.5 mm
- Extreme performance up to 40 Gbps transfer rates
- Rugged BGA attach withstands high shock and vibration
- Radiation tolerant design
- Series: CSPO, CSSO
- [samtec.com/firehawk](http://samtec.com/firehawk)



### VITA 90 VNX+ SOLUTIONS

- RF backplane system to support 110 GHz with high-density size 20 cable; size 16 on roadmap
- Rugged blind mate solution
- Configured with SEARAY™ right-angle array and rugged optics
- SWaP-C reductions make this ideal for military and aerospace applications
- COTS or modified COTS solution for cost and time flexibility
- [samtec.com/vnx](http://samtec.com/vnx)



### EXTREME ENVIRONMENT OPTICAL SYSTEM

- Sealed and parylene-coated for exposed military, aerospace and submersible applications
- Ruggedized for tin whisker mitigation and fungal resistance; operates in harsh environments including salt fog, blowing sand and dust, jet fuel exposure, altitudes up to 65,000 feet
- Extended temp range of -40 °C to +85 °C
- Series: ETMO/UEC5/UCC8
- [samtec.com/firefly](http://samtec.com/firefly)

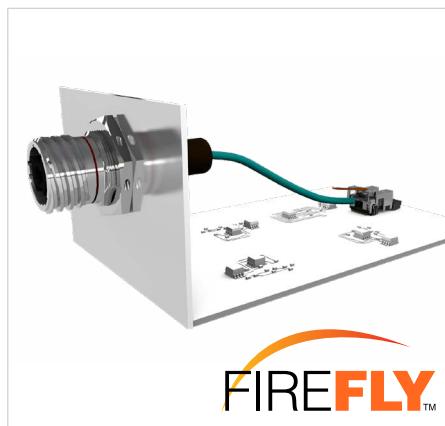

### EXTENDED TEMP OPTICAL SYSTEMS

- Extended temperature range from -40 °C to +85 °C
- x4 and x12 designs to 25 Gbps per lane performance
- Samtec's Extended Temp FireFly™ optical with Amphenol® Aerospace bulkhead interconnects
- Micro footprint allows for increased density
- Series: ETUO/UEC5/UCC8
- [samtec.com/firefly](http://samtec.com/firefly)





**ULTRA RUGGED HARDWARE**

- Guide post standoffs (GPSO) allow for .035" of initial misalignment
- Assists with "blind mate" for ultra micro, fine pitch mezzanine connectors
- 5 to 30 mm stack heights
- 303 stainless steel with MIL-C-13924 black oxide finish
- Jack screw precision standoffs (JSO) reduce the risk of component damage
- Standoffs (SO) with precision machined tolerances (+/- .002" (0.05 mm))
- [samtec.com/hardware](http://samtec.com/hardware)

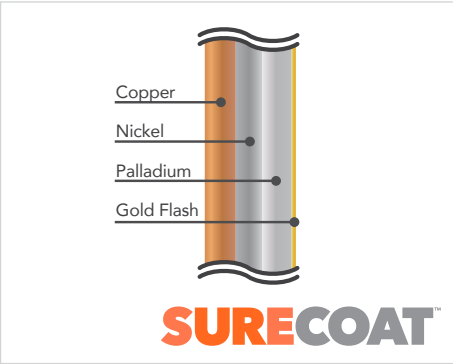

**HIGH RELIABILITY PLATING**

- 40 to 50 μ" palladium nickel plating with gold flash for high-temp, high cycle applications
- Qualified up to 150 °C ambient; 200 °C on roadmap
- Available on SEARAY™ 1.27 mm pitch high-density arrays to 3,000 cycles (SEAF/SEAM)
- Product Roadmap includes SEARAY™ 0.80 mm, AcceleRate® HP, LP Array™ and Generate™ 0.80 mm
- Ideal for ATE applications

**ROADMAP**



High-cycle "super lube" for extreme mating cycles

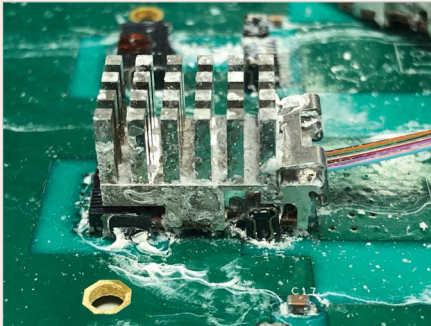

Expanded testing to MIL-DTL-55302 including salt spray and enhanced shock & vibration



URSA™ I/O configurations of power, signal, RF coax and high-speed contacts for high-reliability in harsh environments



Rugged blind mate solution with RF and optical connectivity for backplane applications



Size 16 and 20 high-frequency coax 38999 contacts for high-density, multi-position housings



Phase & insertion loss stable microwave/millimeter wave cable assemblies - Orange is the new cable!

# ULTRA RUGGED TESTING

## SEVERE ENVIRONMENT TESTING (SET)

Severe Environment Testing (SET) is a Samtec initiative to test products beyond typical industry standards and specifications for performance confidence in rugged/harsh environment industries. These products undergo additional testing, inspired by military standards, to ensure they are more than suitable for military, space, automotive, industrial and other extreme applications.

SET qualified products are Commercial Off-the-Shelf (COTS) and modified COTS for incredible design flexibility to get solutions to market faster. Visit [samtec.com/SET](http://samtec.com/SET) or contact [SET@samtec.com](mailto:SET@samtec.com) for additional information and current available test results.



### MEETS OR EXCEEDS:

- VITA 47.1 Module Insertions
- VITA 47.3 Humidity
- VITA 47.1 Operating Shock Class OS2
- VITA 47.1 Vibration Class VS3
- Exceeds VITA 47.1 Temperature Cycling Class C4
- Exceeds VITA 47.1 Non-Operating Temperature Class C4
- VITA 47.1 Electrostatic Discharge Resistance
- Exceeds VITA 47.1 Altitude for DWV

### LOT SCREEN SAMPLE TESTING

Lot screen sample testing available to ensure product meets required specifications. Military/Aerospace Product (MAP) required; contact [map@samtec.com](mailto:map@samtec.com)

**TIGER  
EYE**  
SYSTEM

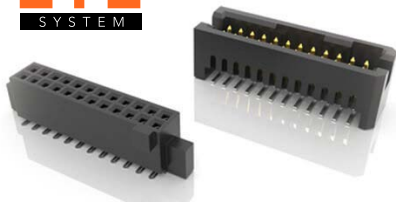

**SEARAY**

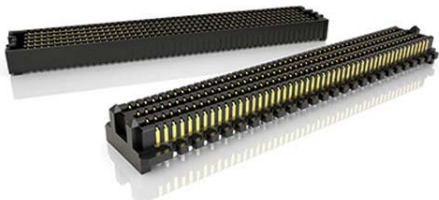

**mPOWER**



### SET QUALIFIED PRODUCTS

**SFM / TFM** Tiger Eye™ 1.27 mm Pitch Micro Rugged System

**SEAF / SEAM** SEARAY™ High-Density Arrays

**LSHM** Razor Beam™ Hermaphroditic Strips

**SSM / TSM** .100" Pitch Square Post Header & Socket

**FTSH / CLP** .050" Pitch Header & Socket

**ERF8 / ERM8** Edge Rate® Rugged High-Speed Strips

**S2M / T2M** Tiger Eye™ 2.00 mm Pitch Micro Rugged System

**UMPS / UMPT** mPOWER® Ultra Micro Power Connectors

**SEAF8 / SEAM8** SEARAY™ Ultra-High Density Arrays

### NASA

Samtec's SET products are approved for NASA Class D missions that require high-reliability, quick-turn and cost-effective solutions for LEO satellites, SmallSats, CubeSats and other space exploration applications.

Samtec also utilizes NASA outgassing data to determine if certain products meet NASA's ASTM E595-77/84/90 test requirements. Visit [outgassing.nasa.gov](http://outgassing.nasa.gov) for data.



## EXTENDED LIFE PRODUCT™

E.L.P.™ products are tested to rigorous standards, which evaluate contact resistance in simulated storage and field conditions.

- 10 year Mixed Flowing Gas (MFG)
- High Mating Cycles (250 to 2,500)
- Certain plating and/or contact options will apply

For complete details about Samtec's E.L.P.™ program, a list of qualifying products and test results, please visit [samtec.com/ELP](http://samtec.com/ELP) or email the Customer Engineering Support Group at [ASG@samtec.com](mailto:ASG@samtec.com)



## DESIGN QUALIFICATION TESTING

All Samtec series undergo Design Qualification Testing (DQT), which includes:

- Gas Tight
- Normal Force
- Thermal Aging
- Mating/Unmating/Durability
- IR/DWV
- Current Carrying Capacity (CCC)
- Mechanical Shock/Random Vibration/LLCR
- Mechanical Shock/Random Vibration/Event Detection



## TESTING REFERENCE CHART

TEST	SET	E.L.P.™	DQT
Gas Tight	X*	X*	N/A
Normal Force	X*	X*	X
Thermal Aging	X*	X*	X
Mating / Unmating / Durability (240 Hrs)	X (100% RH, 250 Cycles)	X* (90-98% RH, 100 Cycles)	X (90-98% RH, 100 Cycles)
IR / DWV	X (At Altitude of 70,000 Feet)	X*	X
CCC	X*	X*	X
Mechanical Shock / Random Vibration / LLCR & Nanosecond Event Detection	X (40 G Peak, 11 ms, Half Sine & 12gRMS, 5 - 2,000 Hz, 1 Hr / Axis)	X* (100 G Peak, 6 ms, Half Sine & 7.56gRMS Avg, 2 Hr / Axis)	X (100 G Peak, 6 ms, Half Sine & 7.56gRMS Avg, 2 Hr / Axis)
Temperature Cycling (500 Cycles)	X	N/A	N/A
Non-Operating Class Temperature	X	N/A	N/A
Electrostatic Discharge (ESD)	X	N/A	N/A
10 Year MFG (Mixed Flowing Gas)	N/A	X	N/A
Mating Cycles (250 to 2,500)	N/A	X	N/A

\* Completed as part of initial Design Qualification Testing (DQT). E.L.P.™ and SET testing are performed in addition to DQT.

# POWER SYSTEMS

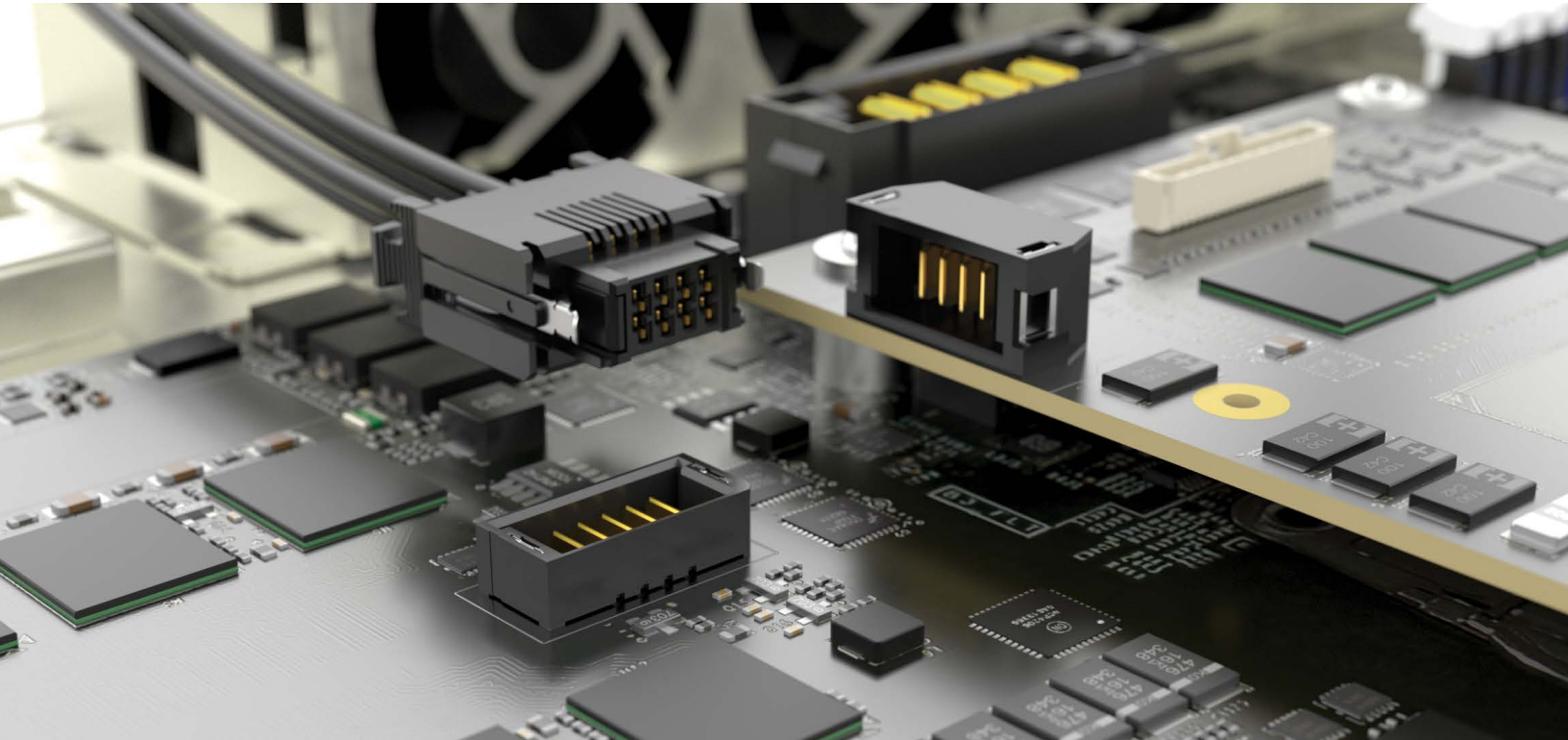

## 2.00 mm PITCH ULTRA MICRO POWER

- Board-to-board, cable-to-board and cable-to-cable
- Tin or 10  $\mu$ m Gold plated power blades; 30  $\mu$ m Gold plating available to meet specific regulations
- 2-10 total power blades
- 5-20 mm stack heights; vertical and right-angle
- Optional weld tabs
- Mating cable assemblies with plastic top or metal side latching
- Components (IMPC/IMPCC/CC489, IMPE/TC146) and tooling also available (see page 33)

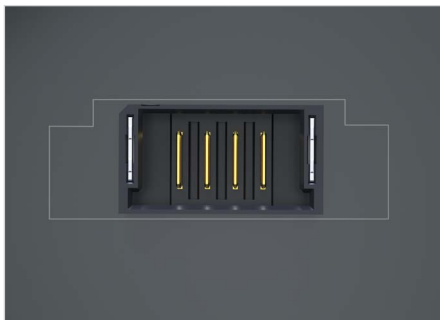

40% space savings compared to traditional power interconnects

mPOWER®

MAX  
18  
A m p s

UMPC/UMPT-RA

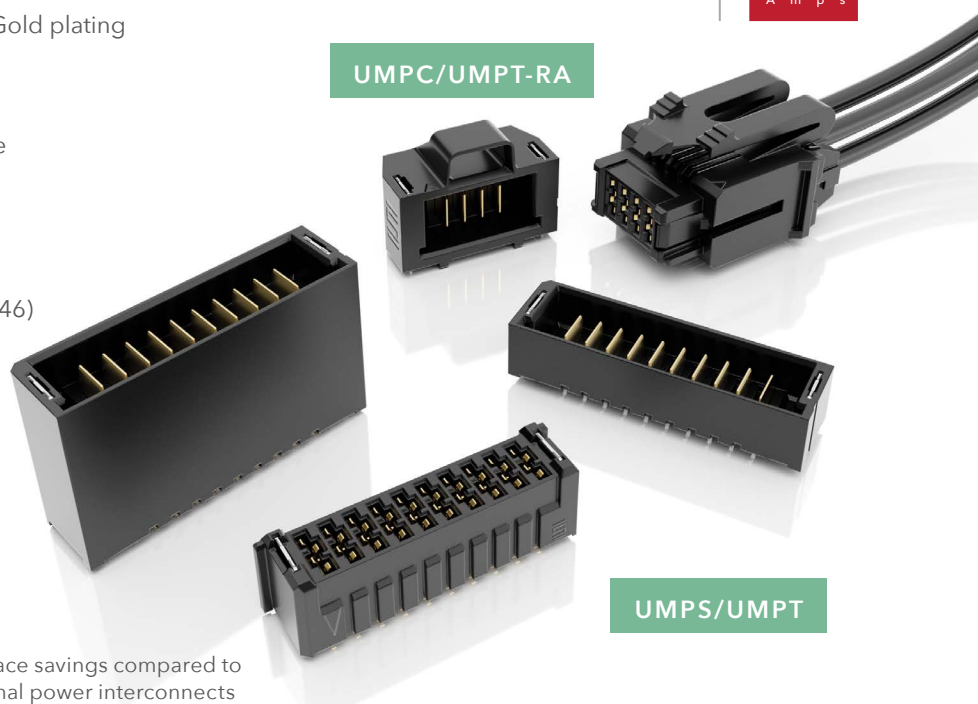

UMPS/UMPT

## ULTRA MICRO POWER (continued)



SureWare™ guide post standoffs available for misalignment and "blind mate"



Cable-to-cable solutions available with rugged side latching (see page 33)



Severe Environment Testing (SET) qualified (UMPS/UMPT); visit [samtec.com/set](http://samtec.com/set)

## CURRENT SPECIFICATIONS

CURRENT RATING (PER CONTACT)		
PINS	Tin	Gold
1	17.8 A	17.5A
2	15.5 A	16.3 A
3	13.5 A	13.9 A
4	12.9 A	13.2 A
10	9.8 A	8.9 A

Ratings are derated 20% with 30 °C rise to the maximum allowable temperature

## CREEPAGE & CLEARANCE

	CREEPAGE	CLEARANCE
UMPT/UMPS	2.20 mm	1.65 mm

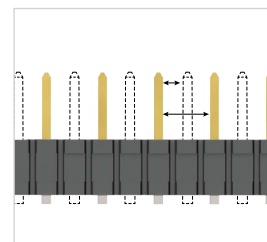

Selectively loading contacts achieves customer specific creepage and clearance requirements. Contact [asp@samtc.com](mailto:asp@samtc.com)

## ACCELERATE® mP POWER/SIGNAL ARRAYS

- Best in class density for power and signal
- Rotated power blades for improved performance and simplified breakout region (BOR)
- Open-pin-field design for routing and grounding flexibility
- Low profile 5 mm stack height; up to 16 mm in development
- 4 power and 60 signal positions; up to 10 power and 240 signal positions in development

ACCELERATE® mP

MAX	PAM 4
22 A m p s	56 G b p s

UDF6/UDM6

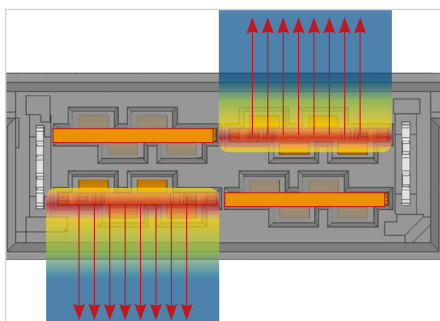
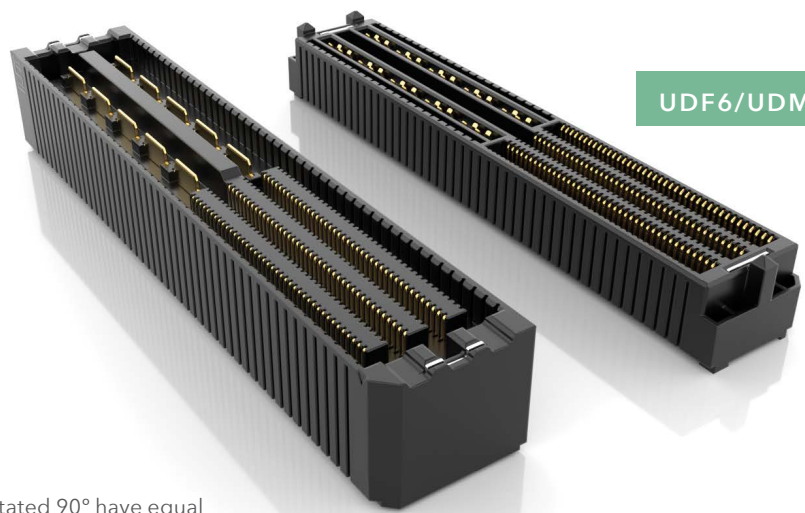

Blades rotated 90° have equal access to heat escape for uniform cooling, increased current capacity and reduced crowding



## MINI MATE® & POWER MATE®

- Individually shrouded contacts for electrical and mechanical protection
- .100" (2.54 mm) and .165" (4.19 mm) pitch
- Surface mount or through-hole
- Vertical and right-angle for parallel, perpendicular and coplanar applications
- Locking clip, key polarization and guide post options
- Discrete wire assemblies with 16-30 AWG PVC or Teflon™ fluoropolymer wire; components and tooling available (see page 32)
- Metal or plastic rugged latching system

	CREEPAGE	CLEARANCE
IPT1/IPS1 MMSS(T)/MMSD(T)	2.54 mm	1.91 mm
IPBT/IPBS PMSS(T)/PMSD(T)	4.27 mm	3.05 mm

Selectively loading contacts achieves customer specific creepage and clearance requirements; contact [asp@samtec.com](mailto:asp@samtec.com)

\*Teflon™ is a trademark of The Chemours Company FC, LLC used under license by Samtec

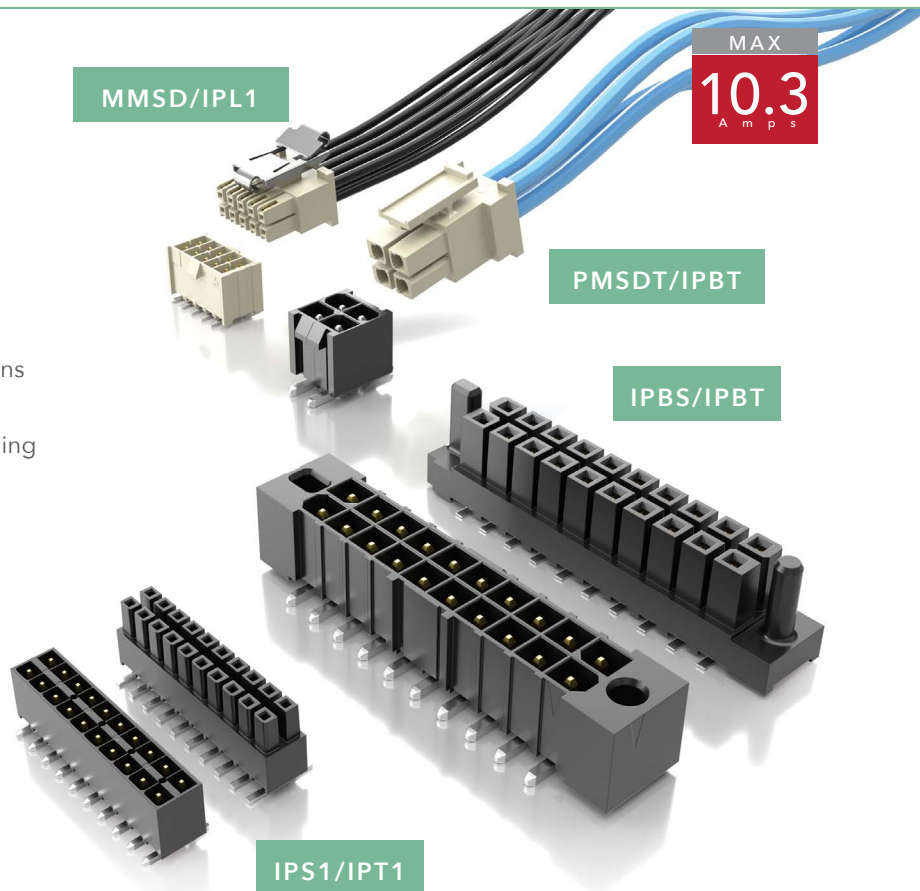

## EXTREME POWER

- AC or DC power, AC-DC combos, split power and hotswap options (ET60S/ET60T)
- 3 or 5 signal rows in the same form factor
- Top guide post option for board space savings
- High-density, double stacked power blades in a low 7.5 mm profile (LPHS/LPHT)
- Rugged guide posts for blind mating assistance
- Vertical or right-angle socket mates with terminal or .062" (1.60 mm) PCB card

	CREEPAGE	CLEARANCE
LPHT/LPHS	5.63 mm	2.69 mm
ET60T/ET60S	3.02 mm	1.87 mm

Selectively loading contacts achieves customer specific creepage and clearance requirements; contact [asp@samtec.com](mailto:asp@samtec.com)

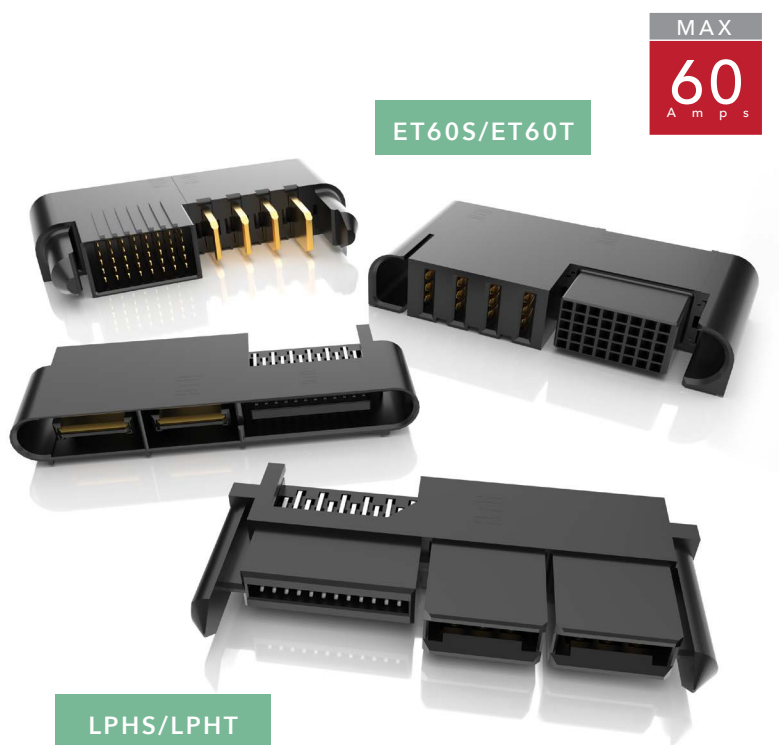

# POWERSTRIP™ SYSTEM

MAX  
**60**  
A m p s

- 24.8 A/blade to 58.7 A/blade (1 blade powered)
- 3.81 mm, 5.00 mm and 6.35 mm pitch
- Up to 10 dual blade contacts
- Power only or power/signal combinations available
- Vertical and right-angle orientations
- Rugged latching, guide posts, locking clips and screw downs
- Discrete wire assemblies with 10-16 AWG wire; components and tooling available (see page 33)

	CREEPAGE	CLEARANCE
PET/PES/PETC/ PESC/PESS	3.66 mm	3.31 mm
MPT/MPS/MPTC/ MPSC/MPSS/MPPT	2.95 mm	2.71 mm
UPT/UPS/UPPT	5.50 mm	1.51 mm

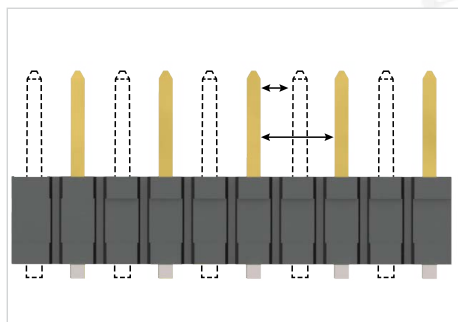
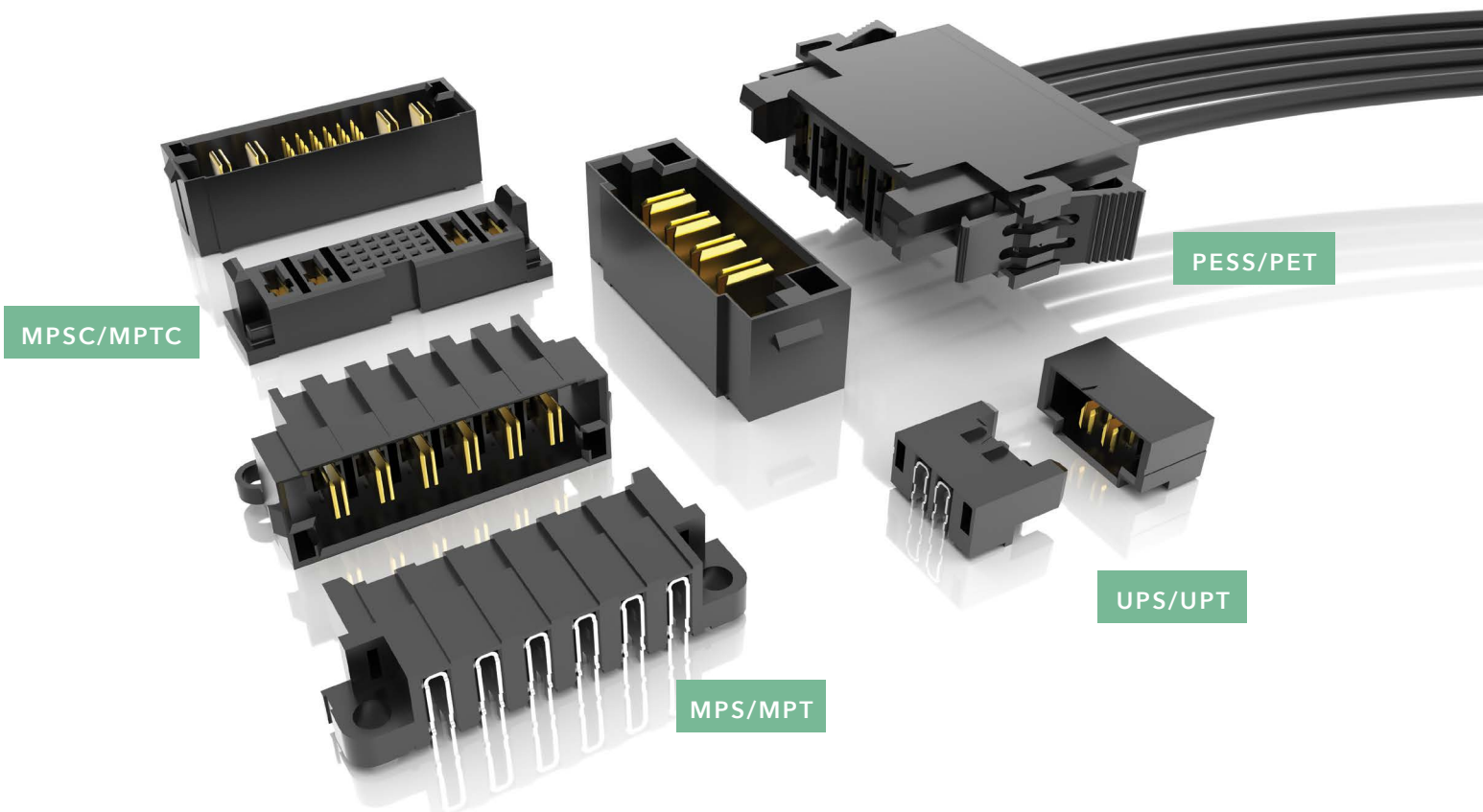

Selectively loading contacts achieves specific creepage and clearance requirements.  
Contact [asp@samtec.com](mailto:asp@samtec.com)

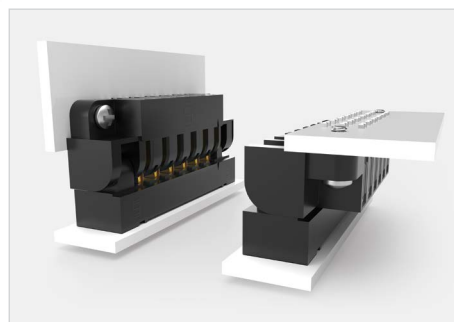

"Hinging" for 90° mating radius, ideal for blind mating (FMPT/FMPS)



Hermaphroditic power system with rugged screw downs (MPPT, UPPT)

## FLEXIBLE POWER STACKING SYSTEMS

- Standard and high-power connector strips
- Power Eye three-finger BeCu contacts for a reliable connection
- .156" (3.96 mm) and .200" (5.08 mm) pitch
- 1 to 24 total positions
- Flexible stack heights from .350" (8.89 mm) to 1.02" (25.91 mm)
- Surface mount and through-hole
- Vertical and right-angle for parallel and perpendicular applications
- Rugged locking clip option

FHP/FWJ

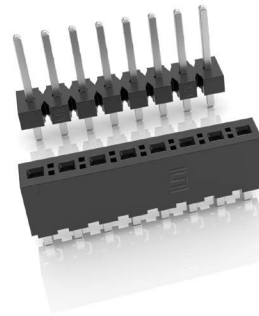

HPF/HPM

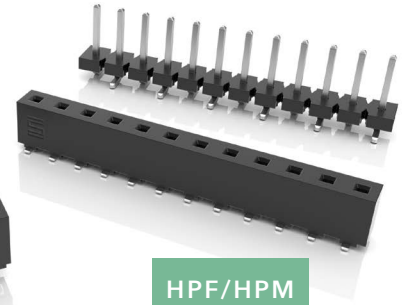

MAX  
16.1  
A m p s

## HIGH-SPEED GROUND PLANE SYSTEMS

- Integral ground/power plane improves electrical performance
- Q2™ rugged connectors rated to 15.7 Amps
- Q Strip® low profile connectors rated to 25 Amps
- Q Rate® slim connectors rated to 8.5 Amps
- 0.50 mm, 0.635 mm and 0.80 mm pitch
- 5 mm to 25 mm stack heights

QSE/QTE



QSERIES®

MAX  
25  
A m p s

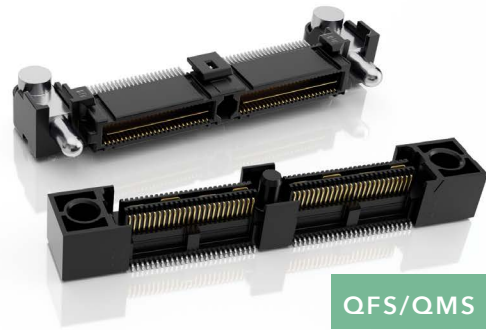

QFS/QMS

## HIGH-SPEED BACKPLANE SYSTEMS

- Backplane power modules for design flexibility
- ExaMAX® modules rated to 17.3 Amps
- XCede® HD modules rated to 12.3 Amps; integrated power in development
- 12 to 72 pair designs
- Integrated guidance and keying

XCede HD

MAX  
17.3  
A m p s



BSP, HDTM/HPTS

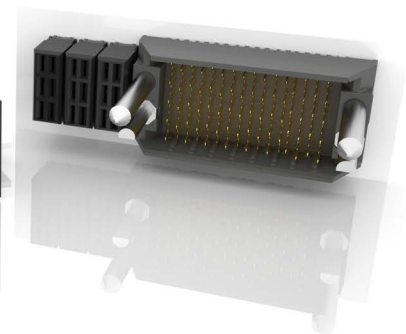

# POWER SERVICES

## POWER INTEGRITY SERVICES

- Standard power test data, including current carrying capacity, working voltage, voltage drop and resistance, creepage and clearance, is available for select power systems
- Current Cycling Test Data, which demonstrates connector performance in realistic and common applications, is available for select series
- Power Integrity Guidelines are based on test data and proven design parameters, designed to help in connector selection and PCB design maximization
- Power Integrity Certified products undergo testing and additional requirements unique to Samtec. Products must pass Current Cycling Test EIA 365-55, have current carrying capacity, resistance vs. number of contacts data available and Power Integrity Guidelines developed

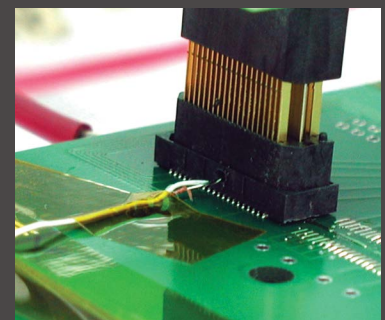
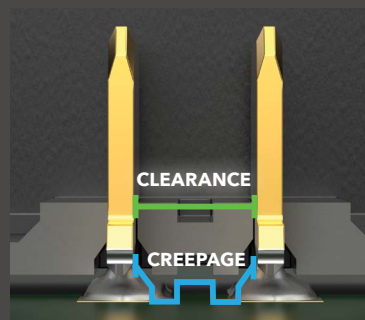
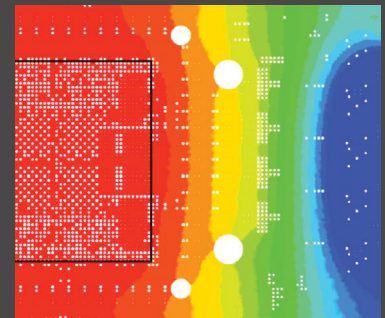

Visit [samtec.com/powerintegrity](http://samtec.com/powerintegrity) to learn more.

## POWER ARCHITECTURE, SYSTEM DESIGN & ROUTING SERVICES

Samtec provides complete support and strategies for the optimization of system power architectures.

Visit [samtec.com/sig](http://samtec.com/sig) for more information.

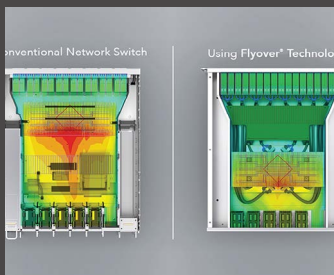

System Power Architectures & Design Solutions

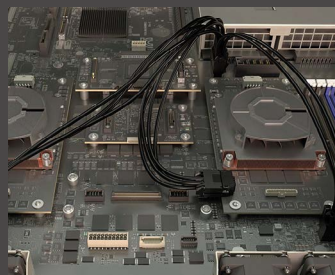

Reference Routing Development for Application-Specific Solutions

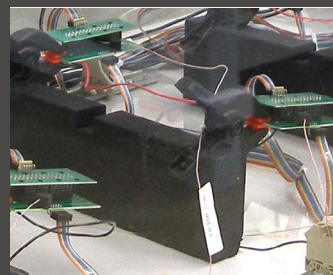

Safety and Reliability Design Assurance



Recommendations for Customer-Specific Requirements

## POWER SIMULATION TOOL

Samtec offers power simulation that can calculate temperature increase in the connector area, in real time. Find this tool on [samtec.com](http://samtec.com) when searching a product for your specific application. Contact [MicroRuggedGroup@samtec.com](mailto:MicroRuggedGroup@samtec.com) for assistance.

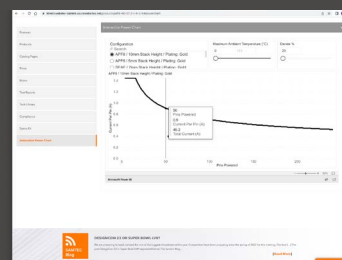



# RUGGED I/O SYSTEMS

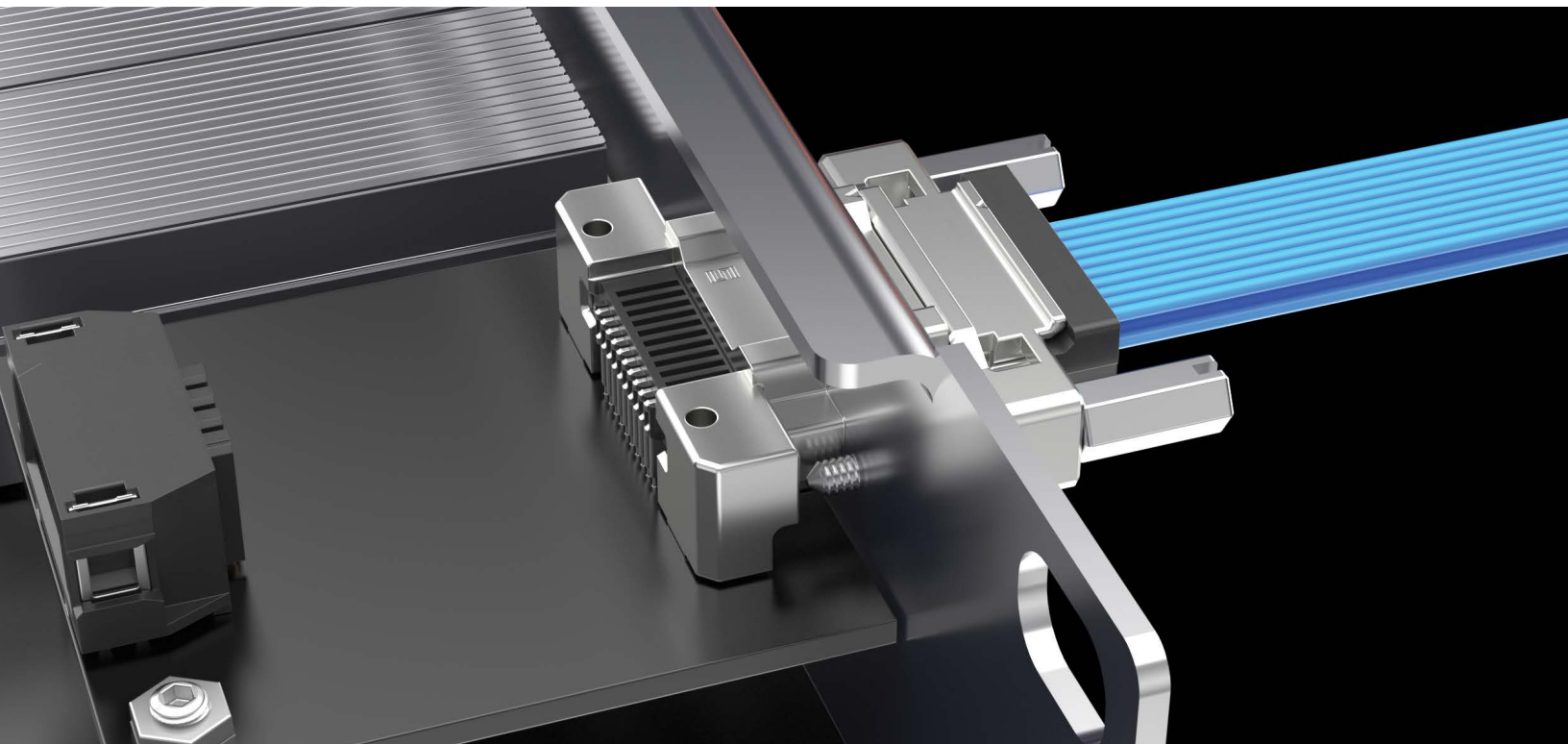

## RUGGED POWER I/O SYSTEMS

- Four points of contact for an extremely reliable connection
- Micro 1.00 mm pitch
- Up to 40 positions per row
- Cable-to-cable and cable-to-board solutions
- Rugged captive panel screws and strain relief
- EMI shielding to limit signal degradation and optimize performance
- Through-hole or surface mount
- 28 and 30 AWG PVC or Teflon™ fluoropolymer wire; color coded available
- Components available (B1SDS/IBT1/CC508, P1PDS/IPP1/TC145)



MAX  
2.9  
A m p s



Extreme density with up to 1,450 total I/Os in a 1RU panel (29 cables at 50 total I/Os each)

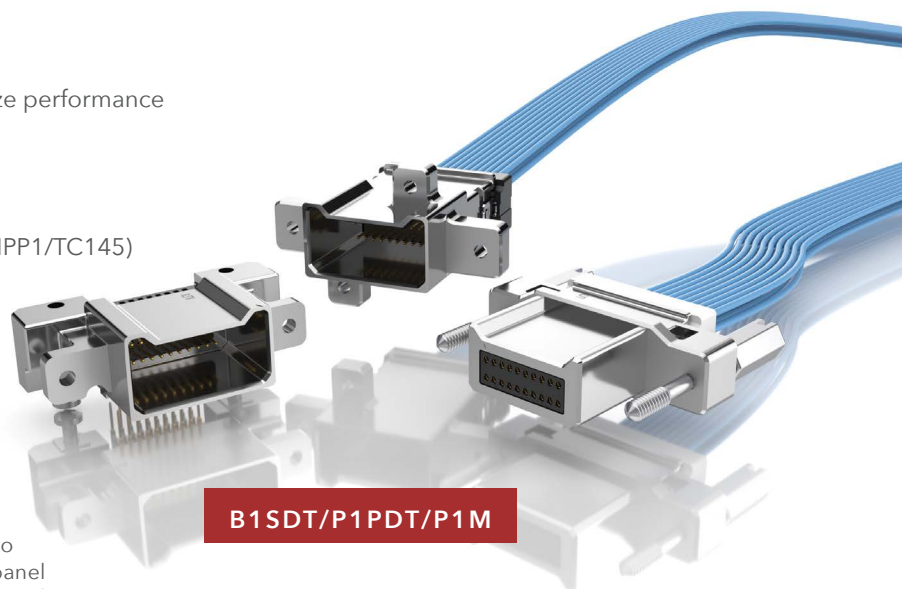

B1SDT/P1PDT/P1M

## MICRO-HYPERBOLOID CONTACT SYSTEM

- High-reliability
- Four points of contact
- Extreme mating cycles
- Designed for rugged power I/O systems



## ROADMAP



AcceleRate® Mini combo assembly for extreme performance to 112 Gbps PAM4



SMPM combo assembly for high frequency to 65 GHz

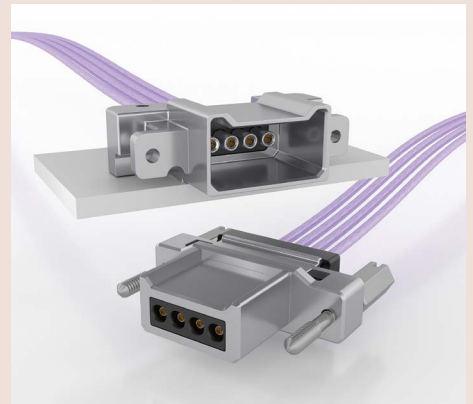

Magnum RF™ micro-miniature SMPM combo assembly for greater density to 65 GHz

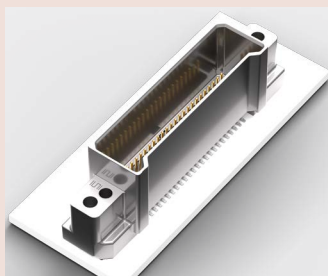

Shielded vertical mating header for design flexibility



Rugged cable shielding for EMI protection

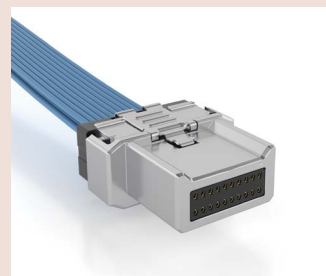

Slim, rugged latching for a secure connection



Size 20 high-frequency coax 38999 contacts

## 38999 RUGGED I/O SYSTEMS

- Samtec's NovaRay® I/O high data rate cable system in a rugged 38999 shell
- Salt fog resistant to 48 hours
- IP67 sealed option
- High-density 16 pair; 32 pair on roadmap
- Threaded cable-to-panel design using Flyover® cable technology
- 28, 30 or 34 AWG (external); 34 AWG (internal) ultra low skew twinax
- Up to 3,548 Gbps PAM4 aggregate data rate from the IC package to the panel and beyond



## EXTREME ENVIRONMENT OPTICAL SYSTEM

- Sealed and parylene-coated for exposed military, aerospace and submersible applications
- Ruggedized for tin whisker mitigation and fungal resistance; operates in harsh environments including salt fog, blowing sand and dust, jet fuel exposure, altitudes up to 65,000 feet
- Extended temp range of -40 °C to +85 °C
- x4 bidirectional design to 25 Gbps per lane performance
- Dual power mode for interoperability with legacy optical modules
- Customizable optical end 2 connectors including MT Elite®, MTP Elite® and low loss MXC®

\*MT Elite®, MTP Elite® and MXC® are registered trademarks of US Conec Ltd.



## EXTENDED TEMP OPTICAL SYSTEM

- Extended temperature range from -40 °C to +85 °C
- x4 and x12 designs to 25 Gbps per lane performance
- Extended Temperature FireFly™ with Amphenol® Aerospace bulkhead interconnects (MT38999)
- Developed for military, aerospace and industrial applications
- Micro rugged connector set with positive latching, weld tabs and loading guides for secure connection
- Variety of rugged end 2 options

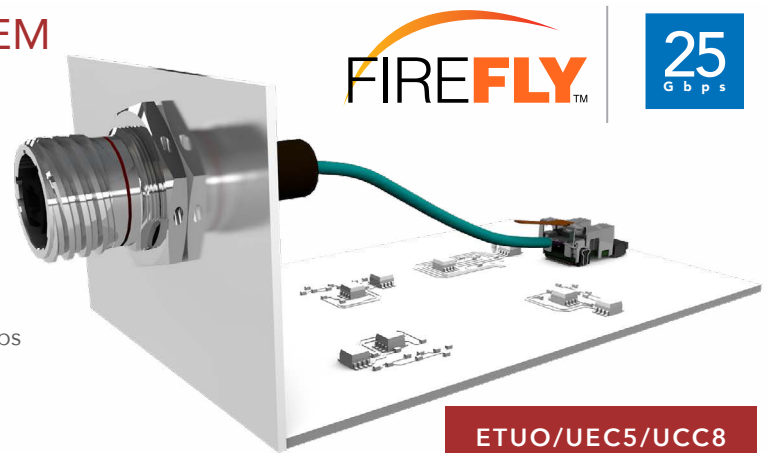



## ACCLIMATE™ FLEXIBLE SEALED SYSTEMS

- IP67 miniature push-pull latching system with lightweight plastic shell
- IP68 bayonet-style latching circulars with metal or plastic shells and flexible configurations
- 12 mm, 16 mm and 22 mm shell size options
- IP67 sealed USB type-C system capable of USB 3.1 speeds; metal shell on roadmap
- Rectangular design for maximum panel area savings
- IP68 threaded circulars with rugged overmold design
- USB & Ethernet options ideal for data uploads/downloads

ACCLIMATE™



ACP/ACR

MCP/MCR

RCU/RPBU

SCRES/SCPE

BCU/BPCU/BRU

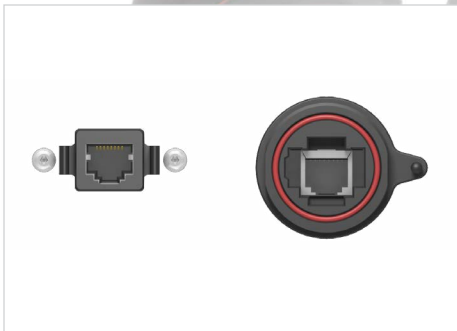

Rectangular design for 25-45% panel area savings

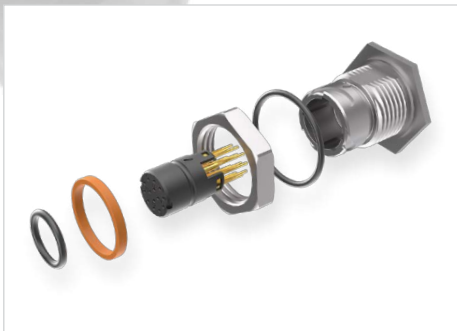

Kitted components for efficient field assembly (ACPK/ACRK)



Rugged dust caps available

# RUGGED BOARD-TO-BOARD SYSTEMS

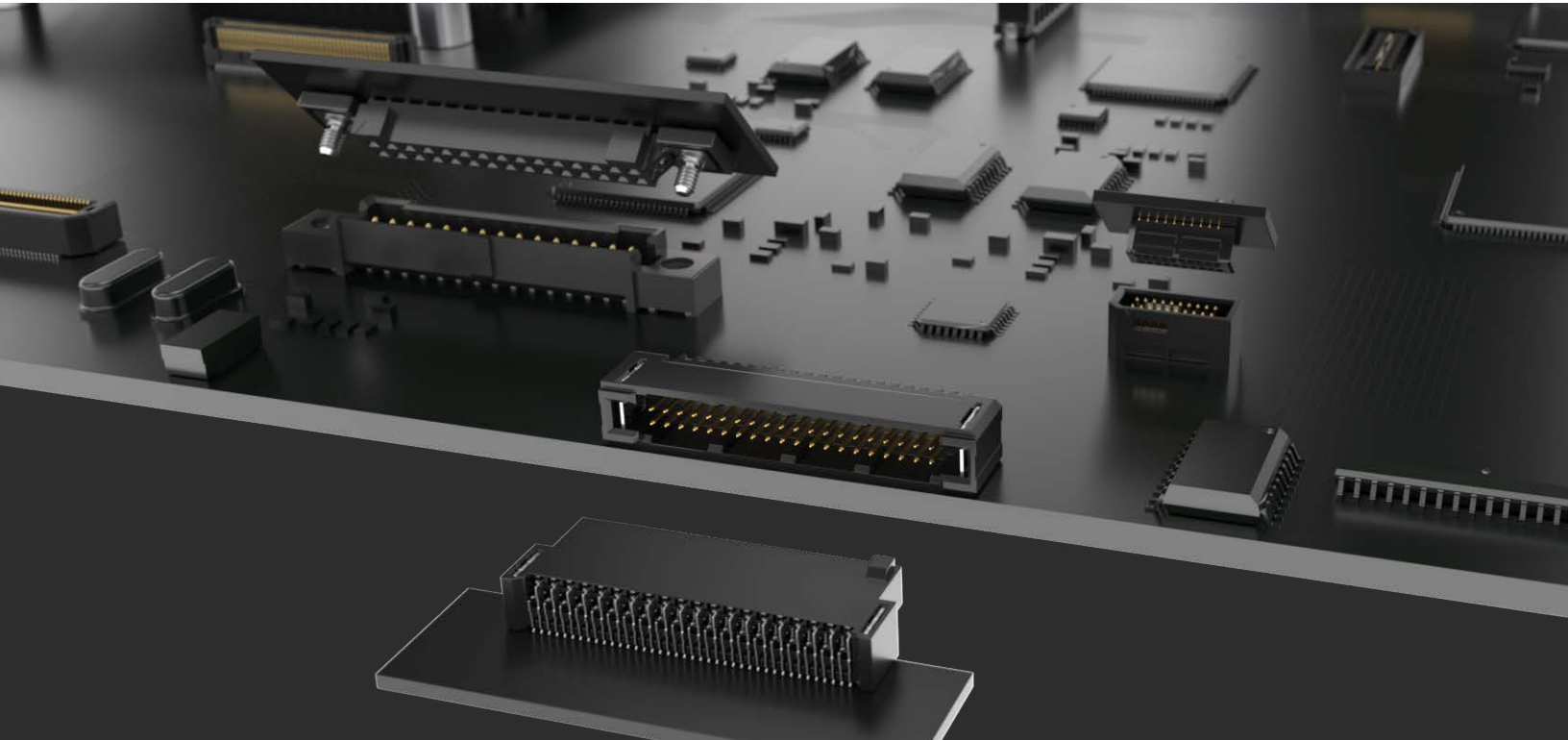

## 1.27 mm TIGER EYE™ SYSTEMS

- Tiger Eye™ is Samtec's most rugged contact system rated to 1,000+ mating cycles
- Screw down, locking clip, and weld tab ruggedizing options
- Shrouded, polarized and keyed
- Surface mount or through-hole tails
- 6 -12 mm stack heights; right-angle available
- Severe Environment Testing (SET) qualified (SFM/TFM); visit [samtec.com/set](http://samtec.com/set) for test reports
- Discrete wire and IDC cable assemblies available (see page 31)

MAX  
3.2  
A m p s

8  
G b p s

SFM/TFM

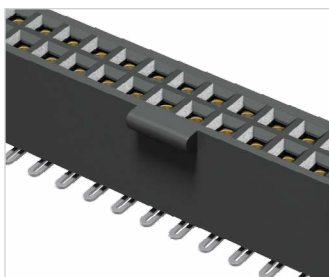

Locking for increased unmating force (SFML/TFML)

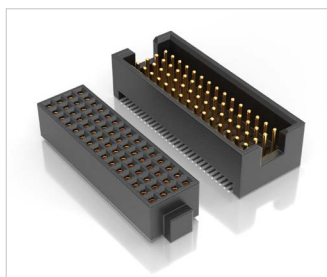

Four row design for higher density (MOLC/FOLC)



## 2.00 mm TIGER EYE™ SYSTEMS

- Optional metal latching, screw downs, weld tabs and locking clips
- Double row with up to 80 total pins
- Surface mount or through-hole tails
- Right-angle mating headers available
- Severe Environment Testing (SET) qualified (S2M/T2M); visit [samtec.com/set](http://samtec.com/set) for test reports
- Discrete wire cable assemblies available (see page 31)

MAX  
3.8  
A m p s

8  
G b p s

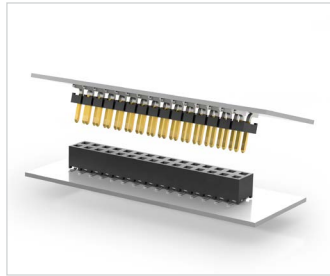
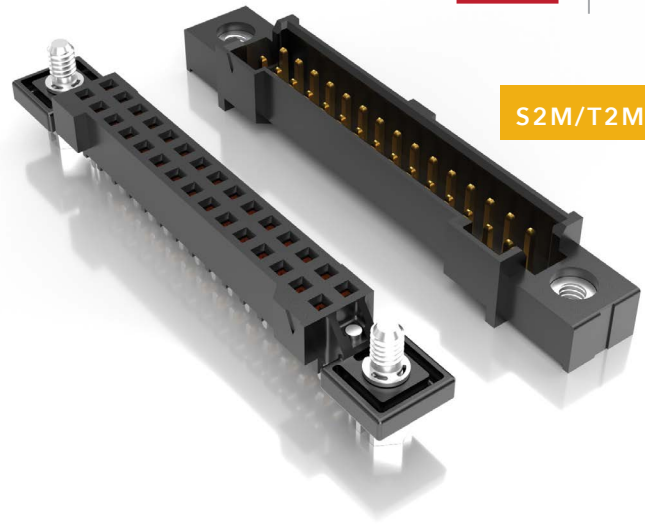

Wide range of stack heights (SMM/TMM)

## 0.80 mm TIGER EYE™ SYSTEMS

- Micro 0.80 mm pitch and slim body for space savings
- Locking clip and weld tab ruggedizing features
- Double row with up to 100 total pins
- Locking for increased unmating force (SEML)
- Extended Life Product™ high mating cycle connectors (SEM/TEM); test reports available at [samtec.com/elp](http://samtec.com/elp)
- Discrete wire cable assemblies available (see page 31)

MAX  
2.9  
A m p s

8  
G b p s



Slim version available for a smaller footprint (SEMS/TEMS)

SEM/TEM shown at 40 total positions

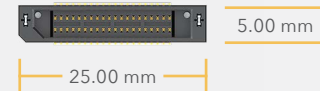

**TIGER EYE™**  
**CONTACT**



### TIGER EYE™ CONTACT SYSTEM

- Multi-finger design with several points of contact for high-reliability
- Smooth, flat mating area increases mating cycles and lowers contact resistance
- Heat-treated BeCu for the best combination of mechanical and electrical properties
- Surface mount, micro slot tail increases solder surface area for higher joint strength



# Rugged Board-to-Board Systems (continued)

## MINI MATE® SHROUDED POWER SYSTEMS

- High retention Tiger Buy™ contacts
- .100" (2.54 mm) pitch
- Up to 50 total individually shrouded contacts
- Elevated stack heights from 11 mm to 35 mm
- Optional polarization, alignment pin and locking clip
- Vertical and right-angle for parallel, perpendicular and coplanar applications
- Discrete wire cable assemblies available (see page 32)

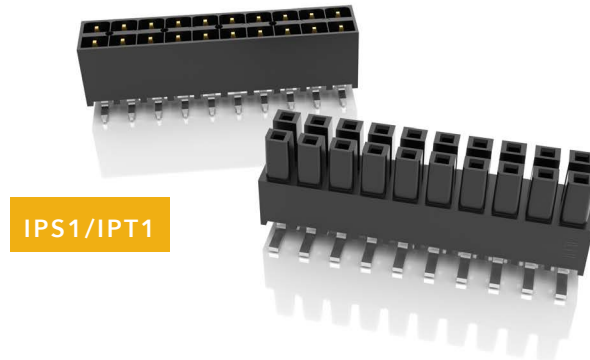

MAX  
5.9  
A m p s

## POWER MATE® ISOLATED POWER SYSTEMS

- .165" (4.19 mm) pitch
- Up to 30 total individually shrouded contacts
- Single or double row option
- Keyed polarization and polarized guide post options
- Vertical and right-angle for parallel and perpendicular applications
- Discrete wire cable assemblies available (see page 32)

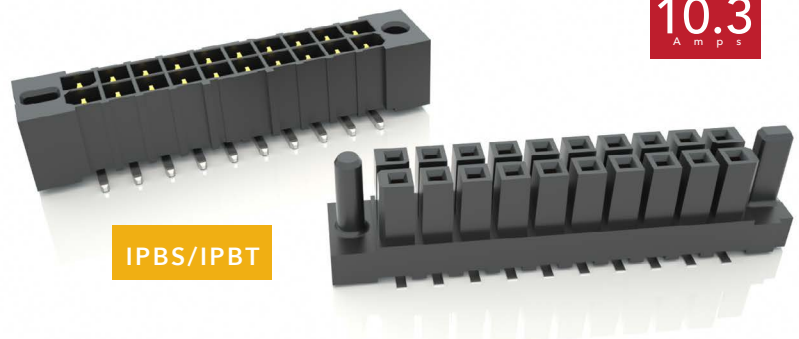

MAX  
10.3  
A m p s

## ULTRA MICRO POWER SYSTEMS

- Micro 2.00 mm (.0787") pitch
- Board-to-board, cable-to-board and cable-to-cable
- Choice of 2 to 10 positions
- 5 mm to 16 mm, 18 mm and 20 mm stack heights
- SureWare™ guide post standoffs (GPSO) assist with misalignment and "blind mate"
- Cable assemblies available (see page 33)
- Severe Environment Testing (SET) qualified (UMPS/UMPT); visit [samtec.com/set](http://samtec.com/set) for test reports

mPOWER®

MAX  
18  
A m p s



## HERMAPHRODITIC CONNECTORS

- 0.50 mm, 0.635 mm and 0.80 mm pitch
- Razor Beam™ contacts for high-speed and fine-pitch systems
- Optional lubricated contacts and shielding for EMI protection
- 4-6x greater mating/unmating forces vs. typical micro pitch connectors
- Audible click when mated
- Severe Environment Testing (SET) qualified (LSHM); visit [samtec.com/set](http://samtec.com/set) for test reports

RAZOR  
BEAM  
SYSTEM

25  
Gbps

### Slim Body Designs (40 total positions each)

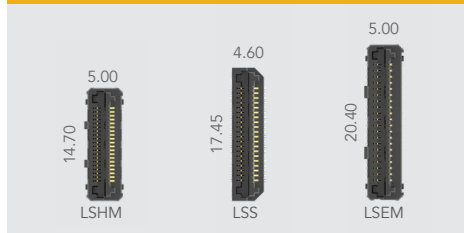

## FLOATING CONNECTORS

- Provides 0.50 mm contact float in the X and Y axes to compensate for misalignment
- Ideal for multiple connectors on a board
- 5 mm and 7 mm stack heights
- Micro 0.50 mm pitch
- Up to 60 total positions
- Vertical and right-angle

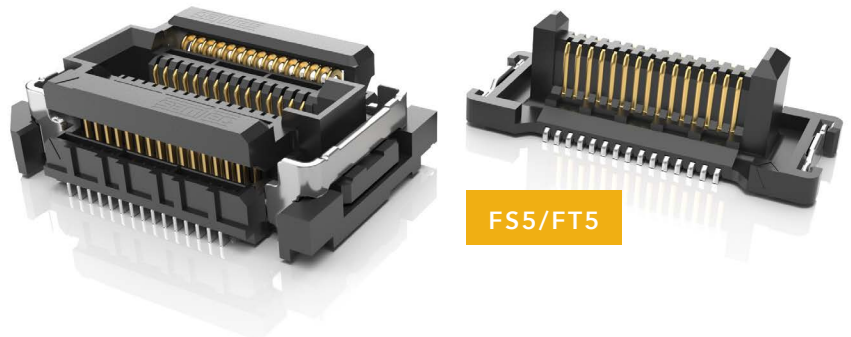

## ONE-PIECE INTERFACES

- Robust design and mechanical hold-downs for high-shock and vibration applications
- Optional rugged weld tabs, screw downs and locking clips
- 1.00 mm, 1.27 mm and 2.54 mm pitch designs
- Up to 100 total positions

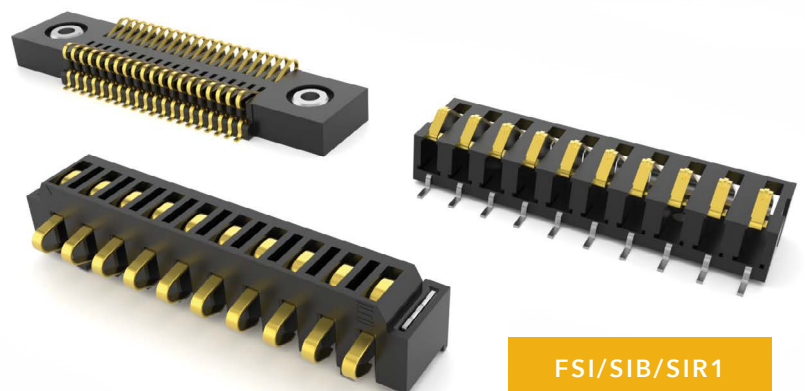

# RUGGED HIGH-SPEED SYSTEMS

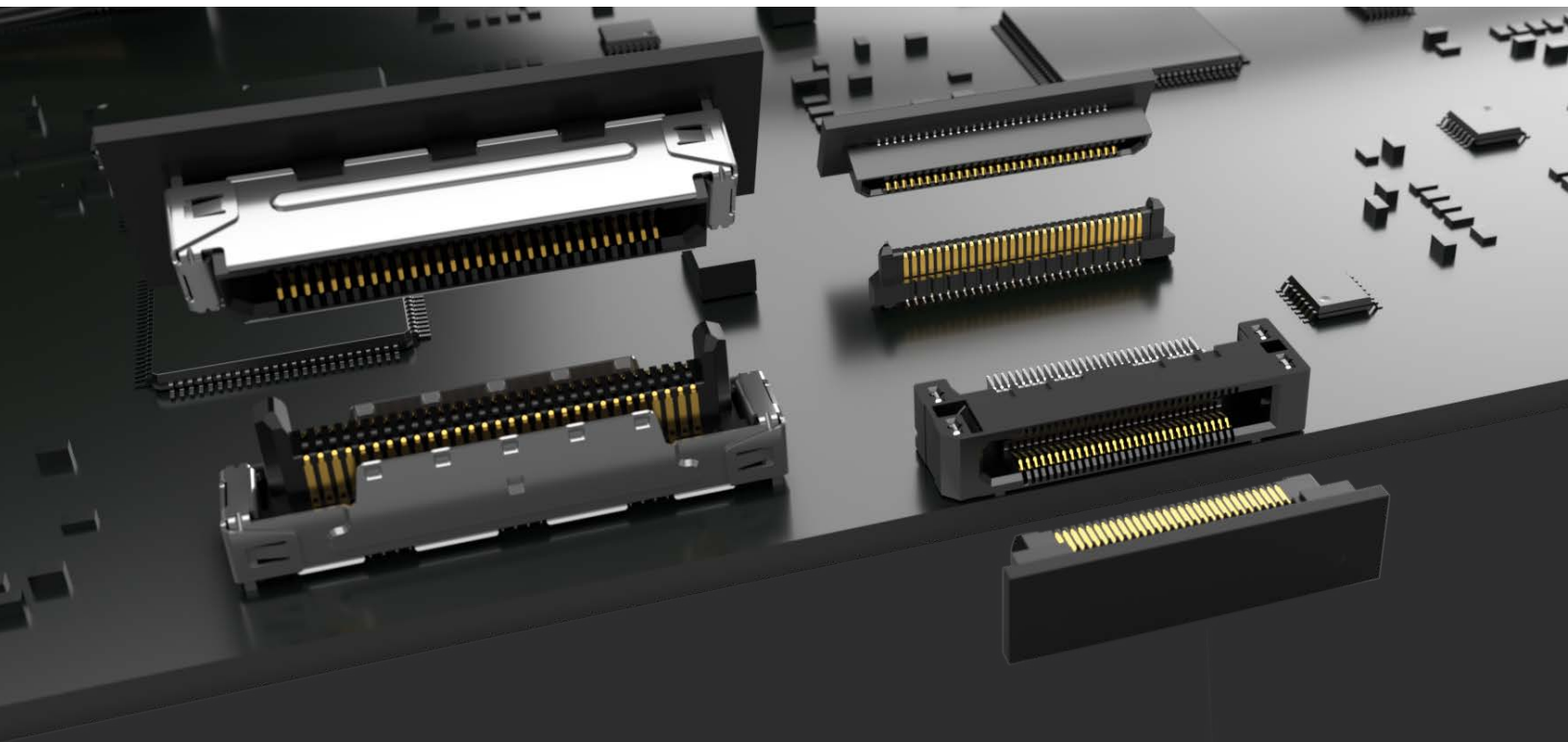

## 0.80 mm PITCH EDGE RATE®

- 1.50 mm extended contact wipe
- Optional extended guide post and rugged metal latching
- 360° shielding option reduces EMI
- Up to 200 total pins
- Single-ended or differential pair signaling
- Vertical, right-angle and edge mount available
- Severe Environment Testing (SET) qualified (ERF8/ERM8); visit [samtec.com/set](http://samtec.com/set) for test reports

**EDGE  
RATE**  
SYSTEM

PAM4  
**56**  
Gbps

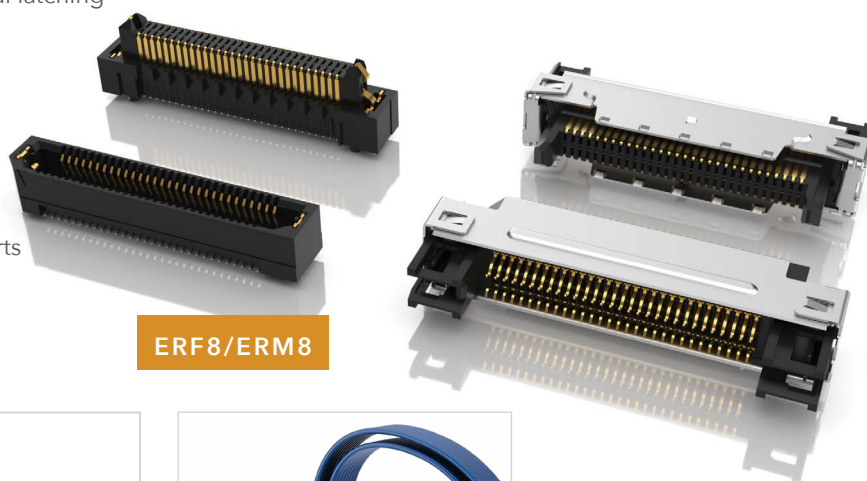

ERF8/ERM8

Stack Height Flexibility  
(in mm)

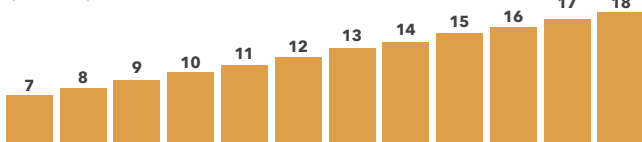

Mating Cable Assemblies  
(ERCD/ERDP Series)



## 0.50 mm PITCH EDGE RATE®

- 1.00 mm contact wipe for a reliable connection
- Rugged friction locks and weld tabs available
- Up to 40% PCB savings vs. 0.80 mm pitch
- Up to 150 total pins
- Vertical and right-angle available

**EDGE  
RATE**  
SYSTEM

**28**  
Gbps

**ERF5/ERM5**

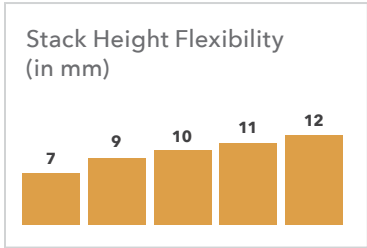
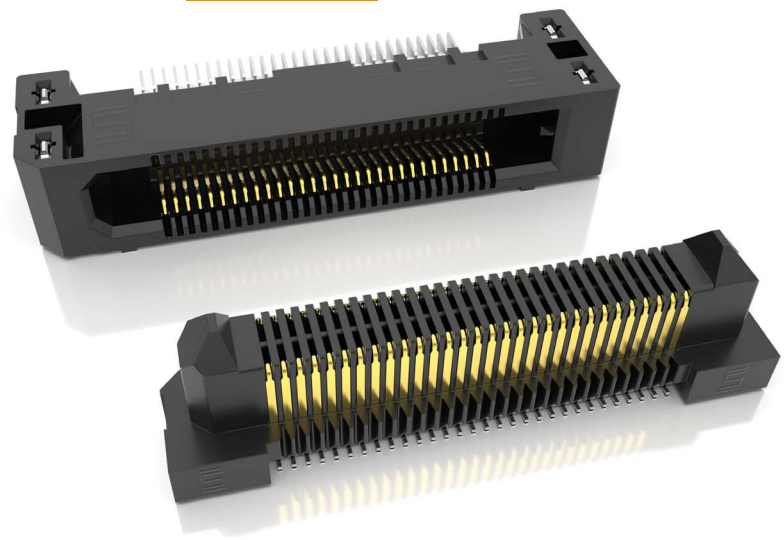

## 0.635 mm PITCH SLIM BODY EDGE RATE®

- Extremely slim 2.5 mm body width
- 1.00 mm contact wipe
- Up to 120 total positions in a 2-row design
- 5 mm stack height with others in development
- Optional weld tabs
- J lead for ease of processing

**EDGE  
RATE**  
SYSTEM

PAM4  
**56**  
Gbps

**ERF6/ERM6**

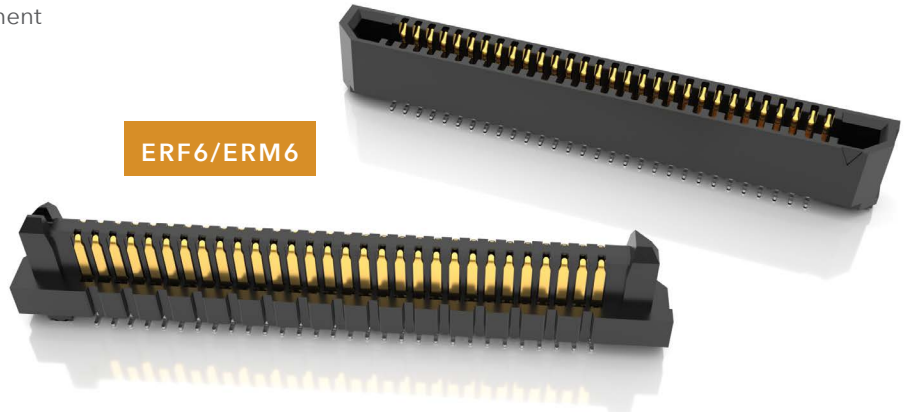

**ERF6 shown at 40 total positions**

17.46 mm

2.50 mm



### EDGE RATE® CONTACT SYSTEM

- Smooth milled mating surface reduces wear and increases durability
- Lower insertion and withdrawal forces
- Robust when "zippered" during unmating
- Minimized parallel surface area reduces broadside coupling and crosstalk
- Designed, simulated and optimized for 50 Ω and 100 Ω systems



# Rugged High-Speed Systems (continued)

## 0.60 mm, 0.80 mm & 1.00 mm PITCH SYSTEMS

- High-speed Edge Rate® contact system
- Vertical, right-angle, edge mount and pass-through
- Power/signal combo to 60 A per power bank (HSEC8-PV)
- PCIe® 3.0, 4.0 and 5.0 capable
- Misalignment mitigation (HSEC1-DV)
- Press-fit tails, weld tabs, locks and latches

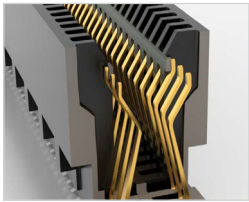

Rugged tucked beam technology (HTEC8)

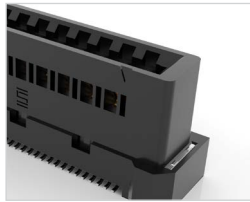

Compliant to SFF-TA-1002 specifications (HSEC6)



HSEC8-DV/HSEC8-PV/HSEC1

GENERATE™

PAM4

56  
Gbps

## HIGH-DENSITY EDGE CARD

- Justification beam enables use of standard PCB tolerance
- 0.50 mm ultra-fine pitch with up to 300 total I/Os
- Surface mount or through-hole with rugged weld tabs
- PCIe® 4.0 capable

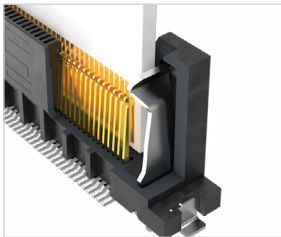

Beam ensures card and body are flush



MEC5-DV/MEC5-RA

PAM4

56  
Gbps

PCI-SIG®, PCI Express® and the PCIe® design marks are registered trademarks and/or service marks of PCI-SIG.

## MICRO EDGE CARDS

- 0.635 mm, 0.80 mm, 1.00 mm, 1.27 mm and 2.00 mm pitch
- Optional rugged weld tabs and polarization
- Solutions for 1.60 mm (.062") and 2.36 mm (.093") thick card
- Vertical, right-angle and edge mount

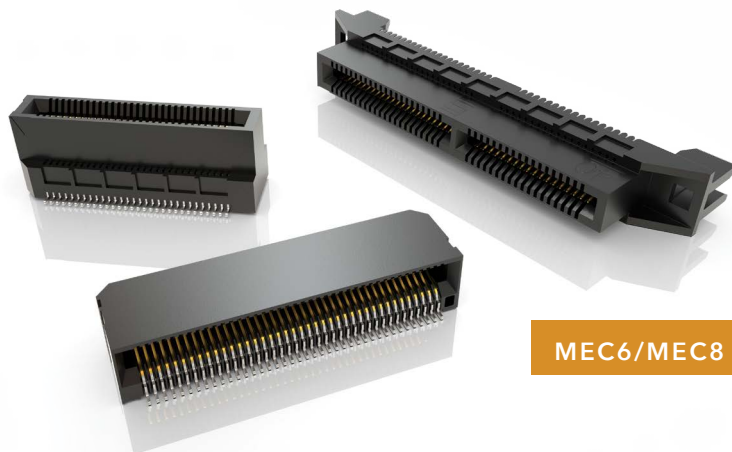

MEC6/MEC8

25  
Gbps

## ACCELERATE® mP POWER/SIGNAL ARRAYS

- Best in class density for power and signal
- Rotated power blades for improved performance
- Open-pin-field design for routing and grounding flexibility
- Low profile 5 mm stack height; up to 16 mm in development
- 4 power and 60 signal positions; up to 10 power and 240 signal positions in development

### ACCELERATE® mP



## Q SERIES® GROUND PLANE CONNECTORS

- Integral ground/power plane for reliable signal integrity and power to 25 Amps
- 0.50 mm, 0.635 mm and 0.80 mm pitch
- Low profile Q Strip® from 5 mm to 25 mm stack heights
- Q Rate® with signal integrity-optimized Edge Rate® contacts
- Q2™ with optional shielding and increased insertion depth

### QSERIES®

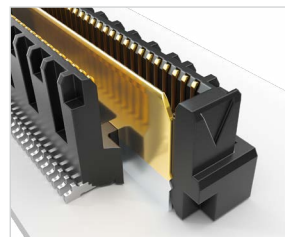

Surface mount ground plane improves electrical performance



## HERMAPHRODITIC RAZOR BEAM™ INTERFACES

- High-retention, high-speed Razor Beam™ contacts
- 0.50 mm, 0.635 mm and 0.80 mm pitch
- Slim body design
- 4-6x greater mating/unmating forces vs. typical micro pitch connectors
- Self-mating system reduces inventory costs
- Shield option for EMI protection

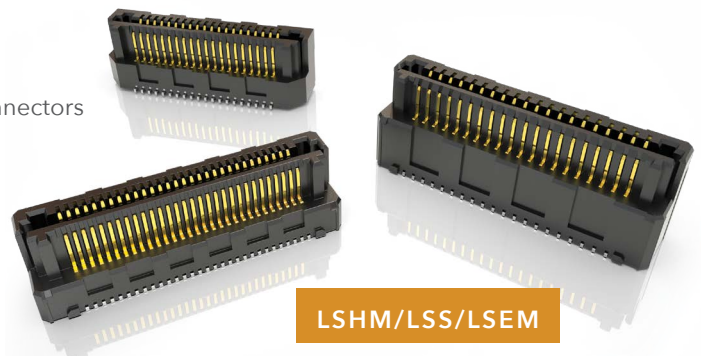

LSHM shown at 40 total positions

5.00 mm

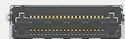

14.70 mm

# DISCRETE WIRE SYSTEMS

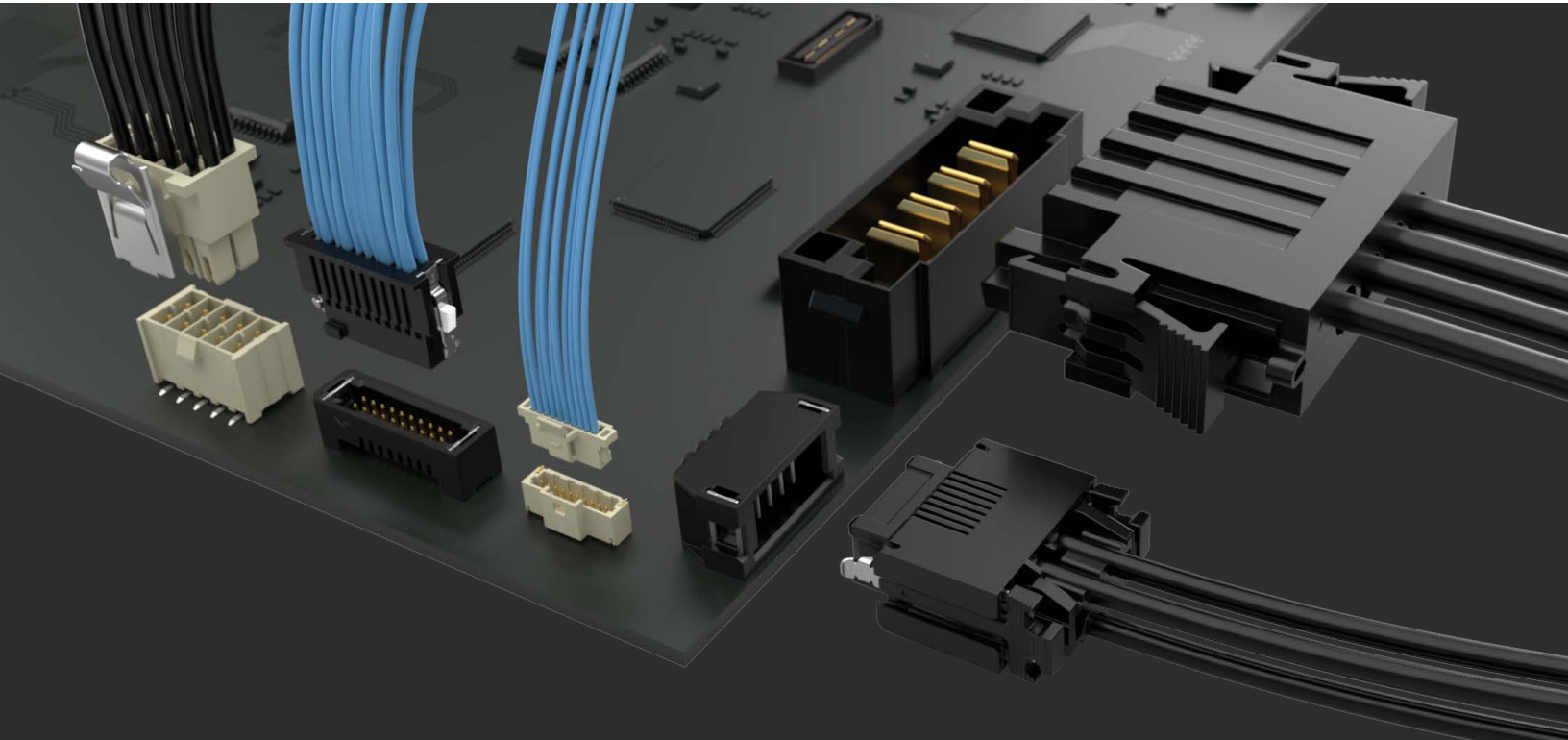

## MICRO MATE™ 1.00 mm PITCH SYSTEMS

- Cable-to-board, cable-to-cable and cable-to-panel
- Low profile design down to 3.2 mm
- 28 and 30 AWG wire options in PVC or Teflon™ fluoropolymer wire
- Up to 40 total crimp-style dual leaf contacts
- Socket or terminal, single or double row
- Rugged positive latching for increased retention
- Vertical and right-angle mating headers

MICROMATE™

MAX  
2.7  
A m p s



Components (ISS1, ISD1/CC09; IST1, IDT1, ISP1, IDP1/TC37) and tooling available: visit [samtec.com/tooling](http://samtec.com/tooling)

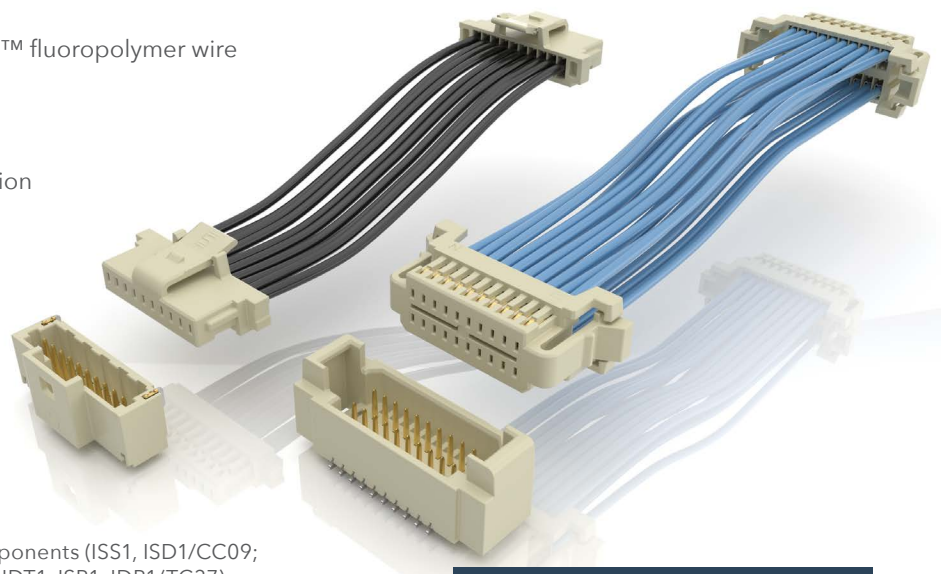

S1SS/T1M, S1SDT/T1M



# TIGER EYE™ DISCRETE WIRE SYSTEMS



- 0.80 mm, 1.27 mm and 2.00 mm pitch
- 24 to 32 AWG in PVC or Teflon™ fluoropolymer wire; color coded wire available
- Single or double ended assemblies
- Up to 100 total positions
- Shrouded, polarized and keyed for more rugged applications
- Retention latching option for higher withdrawal forces
- Optional screw downs
- Crimp for automotive applications in development for 1.27 mm pitch (SFSD/FFSD) assemblies; contact [AutoSalesGroup@samtec.com](mailto:AutoSalesGroup@samtec.com)

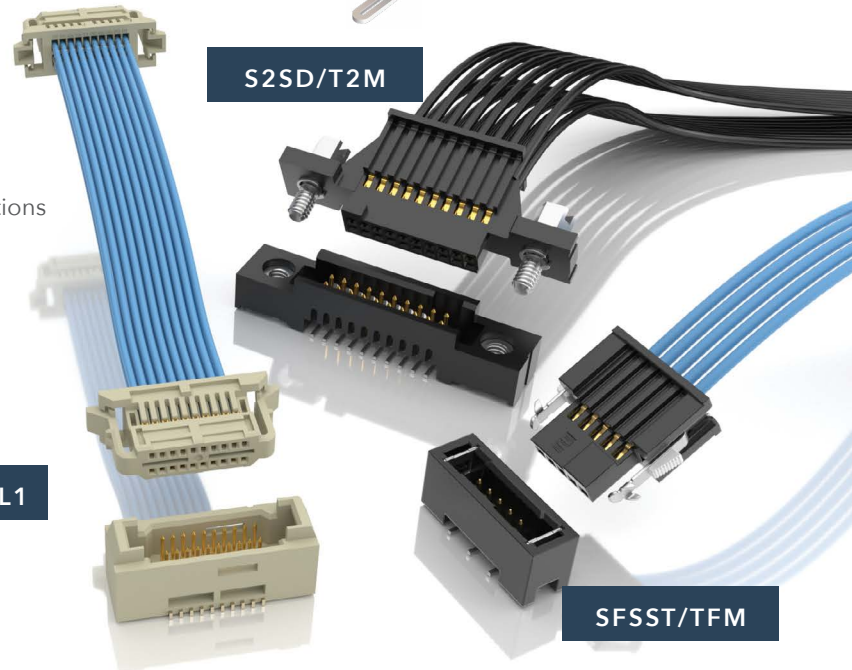

	0.80 mm Pitch	1.27 mm Pitch	2.00 mm Pitch
Series	SESDT	SFSS, SFSST, SFSD, SFSDT	S2SD, S2SDT
Cable AWG	32	28 and 30	24, 26, 28, 30
Cable Type	Teflon™ fluoropolymer	PVC or Teflon™ fluoropolymer; color coded available	PVC or Teflon™ fluoropolymer; color coded available
No. of Rows	2	1 or 2	2
Total No. of Positions	10, 20, 30, 40	3 - 100	10 - 60
Mates - Terminal Cables	--	TFSS, TFSST, TFSD, TFSDT	T2SD, T2SDT
Mates - Board Connectors	TEM-L1	TFM/SFM, TFC/SFC	T2M/S2M
Component - Body	ISDE	ISDF, TSDF	ISD2, ITD2
Component - Contact	CC396	CC03R, CC03M, T1M44-M, T1M44-R	CC81L, CC81R, T1M82-L, T1M82-R



Components available for build-it-yourself design and application flexibility; please see chart above



Hand tools available for low volume and semi-automatic mini applicators for self assembly; visit [samtec.com/tooling](http://samtec.com/tooling)



IDC cable assemblies with rugged strain relief and mating shrouded headers; visit [samtec.com/idc](http://samtec.com/idc)

# Discrete Wire Systems (continued)

## MINI MATE® DISCRETE WIRE SYSTEMS

- .100" (2.54 mm) pitch
- Individually shrouded contacts
- 2 to 50 total positions
- Single and double row
- 20 to 30 AWG PVC or Teflon™ fluoropolymer wire; color coded available
- Keyed polarization
- Rugged metal or plastic latching
- Vertical or right-angle mating header
- Sealed version on roadmap for harsh environments

MAX  
**4.8**  
A m p s

**MMSDT/IPL1**

**MMSS/IPL1-RA**



Components (IPD1/CC79L/CC79R) and tooling available for application flexibility; visit [samtec.com/tooling](http://samtec.com/tooling)

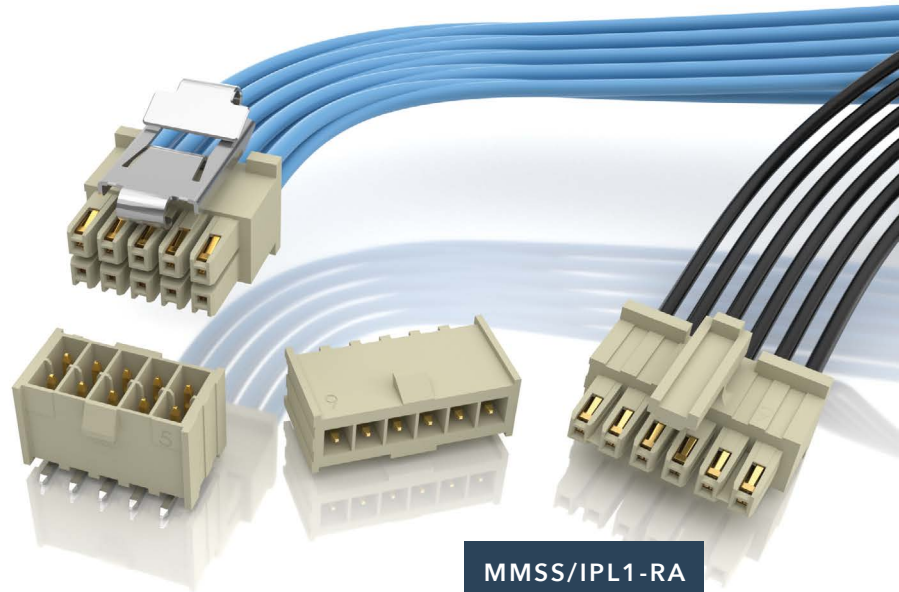

## POWER MATE® DISCRETE WIRE SYSTEMS

- .165" (4.19 mm) pitch
- Individually shrouded contacts
- 2 to 30 total positions
- Single and double row
- 16 to 24 AWG PVC or Teflon™ fluoropolymer wire
- Keyed polarization
- Rugged plastic latching
- Single or double ended
- Vertical or right-angle mating header

MAX  
**10.4**  
A m p s

**PMSD/IPBT**

**PMSST/IPBT-RA**



Components (IPBD/CC69L/CC69R) and tooling available; visit [samtec.com/tooling](http://samtec.com/tooling)

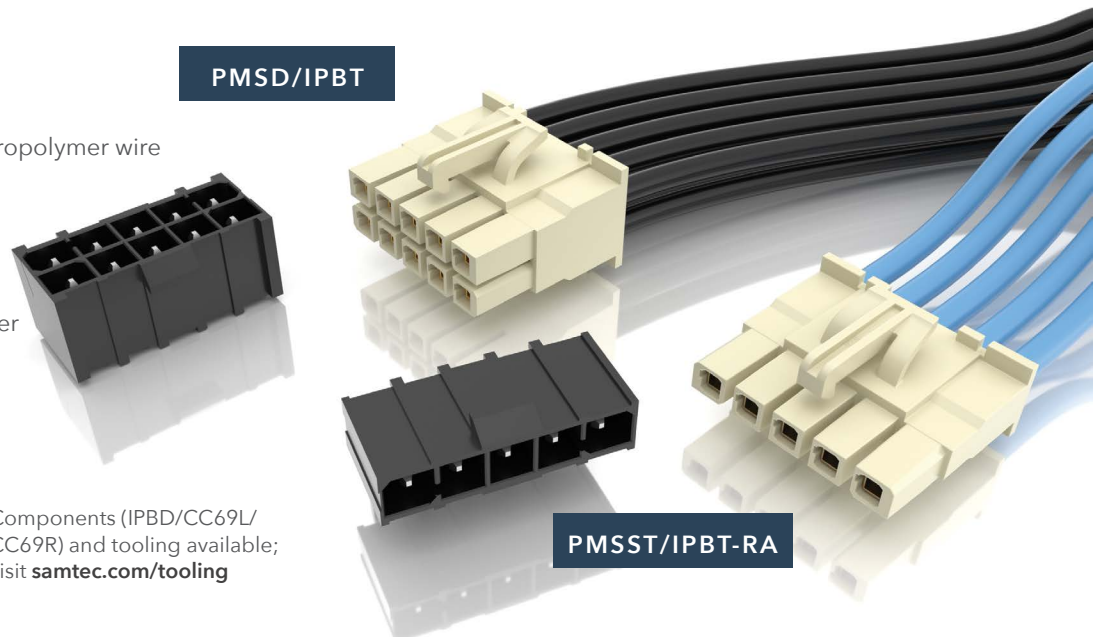

## mPOWER® ULTRA MICRO POWER SYSTEMS

mPOWER®

MAX  
18  
A m p s

- Micro 2.00 mm pitch cable-to-board and cable-to-cable solutions
- Simplifies board layout and delivers power directly to active components
- 2 - 10 total power blades
- 16 and 18 AWG wire; color coded available
- Plastic top latching or metal side latching options
- Tin or 10 μ" Gold plated power blades; 30 μ" Gold plating available to meet specific regulations
- PVC or high-temp Teflon™ fluoropolymer wire
- Vertical and right-angle mating headers with optional weld tabs

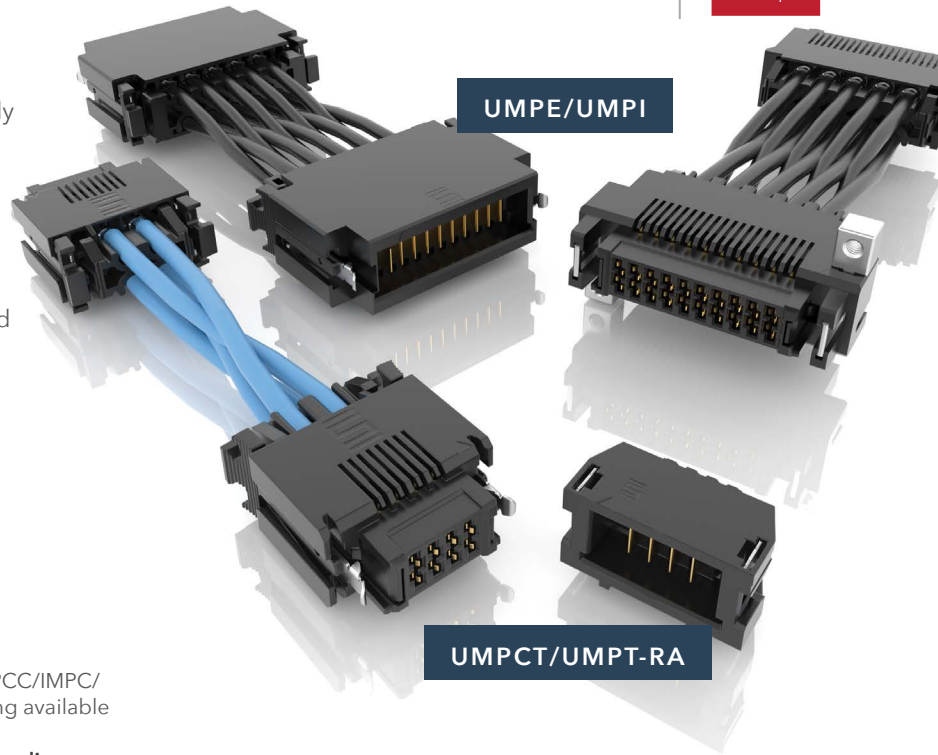

Components (IMPCC/IMPC/CC489) and tooling available for self assembly; visit [samtec.com/tooling](http://samtec.com/tooling)

## POWERSTRIP™ HIGH-POWER SYSTEMS

- 5.00 mm and 6.35 mm pitch
- 2 to 8 total dual blade contacts
- 30 Amp signal/power combo with 4 total power, and 16 or 24 Tiger Eye™ signal positions
- 10 - 16 AWG wire
- Polarized with a rugged latching system
- Single or double ended
- Vertical and right-angle mating headers

MAX  
40  
A m p s

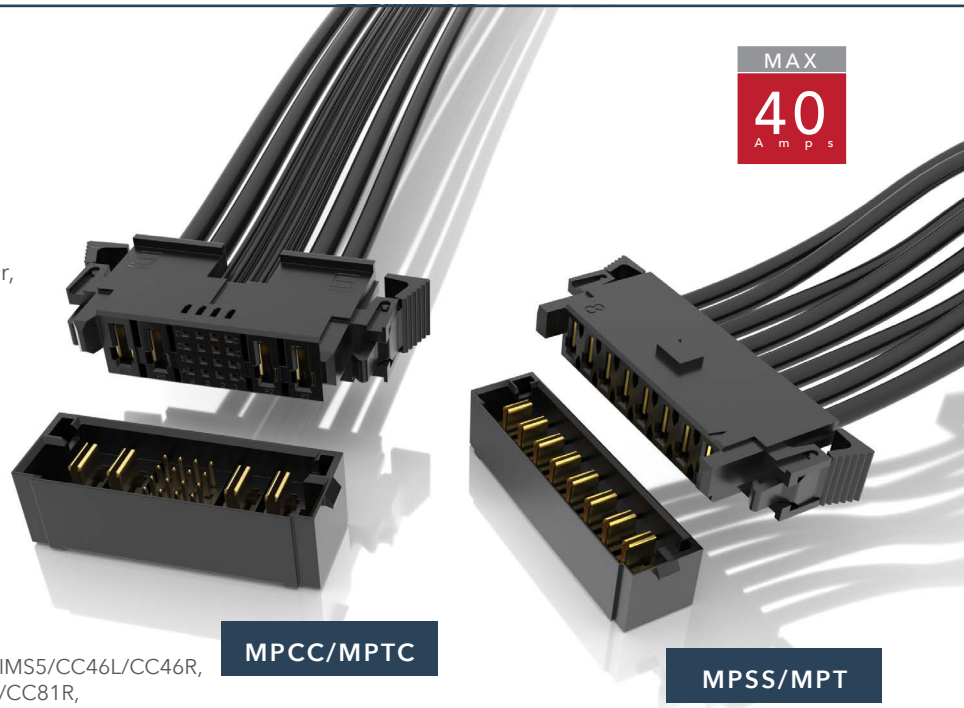

Components (IMS5/CC46L/CC46R, IMSC5/CC81L/CC81R, IPS6/CC10L/CC10R) and tooling available for flexible applications; visit [samtec.com/tooling](http://samtec.com/tooling)

# RUGGED FEATURES & CUSTOM SOLUTIONS

## RUGGEDIZING OPTIONS

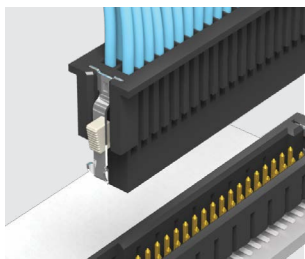

### POSITIVE LATCHING

Manually activated latches increase unmating force by up to 200%

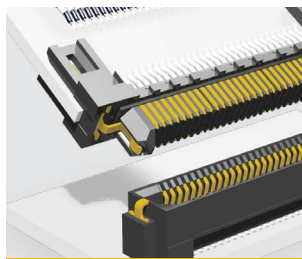

### FRICTION LOCKS

Metal or plastic friction locks increase retention/withdrawal force



### RETENTION PINS

Increase unmating force by up to 50%

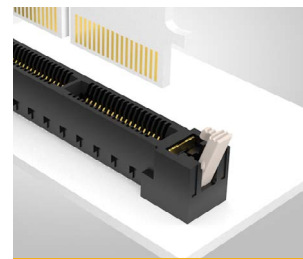

### BOARD LOCKS

Boards are mechanically locked together

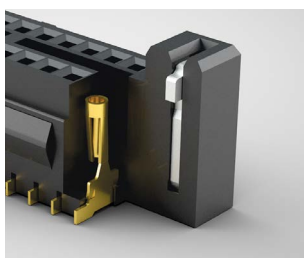

### WELD TABS

Significantly increase shear resistance of connector to PCB

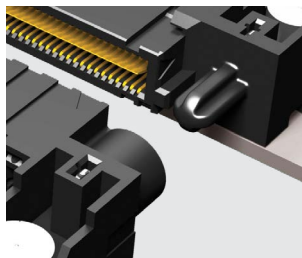

### GUIDE POSTS

Easy and secure mating



### SHIELDING

360° shielding reduces EMI

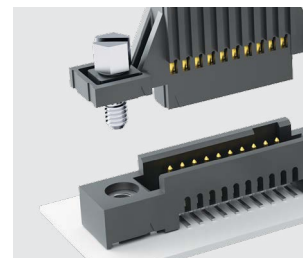

### SCREW DOWNS

Secure mechanical attachment to the board

## CONTACT SYSTEMS

**TIGER EYE™**  
CONTACT



- High-reliability
- High Mating Cycles
- Multi-finger Contact

**TIGER CLAW™**  
CONTACT

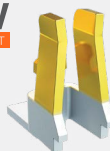

- Dual Wipe Contact
- Pass-through Applications
- Ultra-low Profile

**BLADE & BEAM™**  
CONTACT



- Mating/Alignment "Friendly"
- Cost-effective
- Micro Pitch

**TIGER BEAM™**  
CONTACT



- Best Cost
- Reliable Performance
- Post & Beam Contact

**EDGE RATE®**  
CONTACT



- Designed for Signal Integrity
- Superior Impedance Control
- Reduced Broadside Coupling

**MICRO-HYPERBOLOID™**



- High-reliability
- Four Points of Contact
- Extreme Mating Cycles



# WILLINGNESS, SUPPORT AND EXPERTISE

## Industry-Leading Customer Service

- Quotes and samples in 24 hours
- Prototype and processing assistance
- Dedicated Application Specific Product engineers and technicians

## Flexible, In-House Manufacturing

- Global Operations, including multiple cable fabrication & assembly facilities
- Quick-turn samples and prototypes
- Custom & modified product support

## Signal Integrity Expertise

- Industry-leading engineering support for high-performance system design
- Full system optimization assistance, including simulation, testing, analysis and evaluation

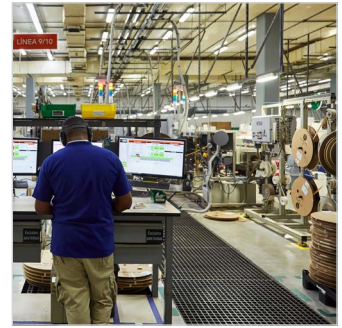
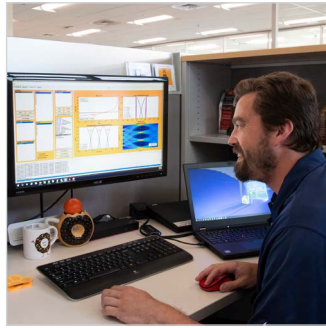

# CUSTOMS & EXPRESS MODIFICATIONS

## FLEXIBLE RUGGED SOLUTIONS

- Contacts and bodies
- Stamping, plating and molding
- Wiring
- Strain relief
- Screw downs
- Latches & locks
- Shielding modifications
- Polarization

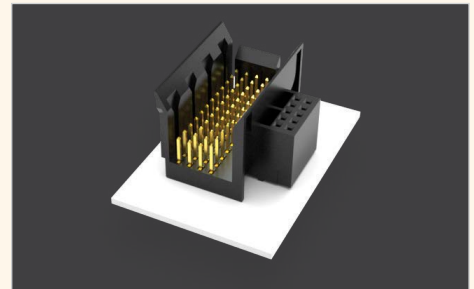

## FLEXIBLE DISCRETE WIRE SOLUTIONS

- Variety of end 2 options
- Nylon woven sleeves
- Twisted pairs, color coding
- Heat shrink
- Selectively populated
- Barrel or harness crimp
- Ring/spade lug terminal
- Sealed

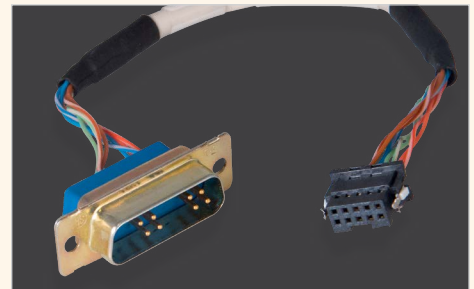

## OPTICS FOR EXTREME ENVIRONMENTS

- Parylene coating
- Salt-fog impenetrable
- Mitigation for tin whiskers
- Fungal resistant
- Extreme shock and vibration
- Full support for liquid immersion cooling

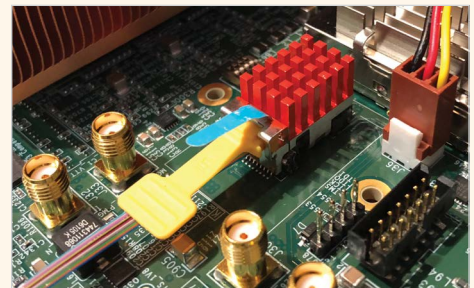

# SUDDEN SERVICE®

UNMATCHED LEAD-TIMES | Innovative Programs & Systems Enable Deliveries in Days, Not Weeks.



This designation allows customers to quickly and easily identify availability of over 200,000 of Samtec's most popular connectors and cables - guaranteed to ship in 1-day.

Look for the Reserve badge throughout samtec.com to quickly determine if your part number is eligible, along with current availability, quantity breaks and pricing. Hundreds of part numbers are being added daily!

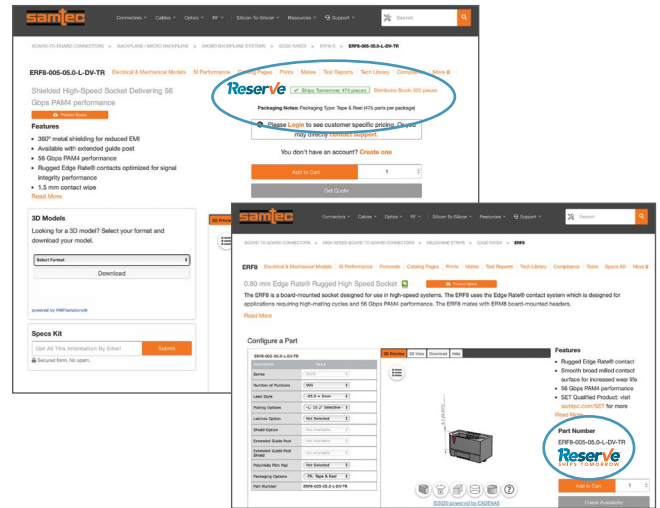

Free product samples, shipped in 24-hours or less have been a cornerstone of Samtec Sudden Service® since the company was founded. Visit samtec.com to quickly request your sample.



An innovative shipping program that bridges the gap between manufacturing facilities and customers, allowing for manufacturing flexibility without increased costs, and with even faster lead-times. Contact [ecustomerservice@samtec.com](mailto:ecustomerservice@samtec.com) to learn more.

24/7 WORLDWIDE ACCESS | Samtec is the Electronics Industry's Service & Technology Leader.

## Technical Support

Signal Integrity Group: [sig@samtec.com](mailto:sig@samtec.com)

Application Support Group: [asg@samtec.com](mailto:asg@samtec.com)

Interconnect Processing Group: [ipg@samtec.com](mailto:ipg@samtec.com)

## Supply Chain Support

MySamtec™ Real-Time Account Access: [account.samtec.com](http://account.samtec.com)

Personal Account Managers & CSRs: [ecustomerservice@samtec.com](mailto:ecustomerservice@samtec.com)

Upfront, Aggressive 24-Hour Quotes: [pricing@samtec.com](mailto:pricing@samtec.com)

MYSAMTEC™ | A Personalized Web Experience for Easy Ordering.

Samtec's user-friendly eCommerce platform allows you to quickly and easily check product availability and pricing, as well as place and manage your orders online.



# ONLINE TOOLS

FIND, DESIGN & VALIDATE YOUR SOLUTION

## PICTURE SEARCH

Browse through a highlight reel of Samtec's most popular products to find the ideal solution for your application, view specifications, check availability, order samples and more. To find your solution, visit [samtec.com/picturesearch](http://samtec.com/picturesearch).



## DOWNLOADS

Samtec offers immediate and unlimited access to all the documentation you need to select the right solution for your application from 3D models, prints and footprints to test reports, white papers and so much more. Visit [samtec.com](http://samtec.com) to start exploring.

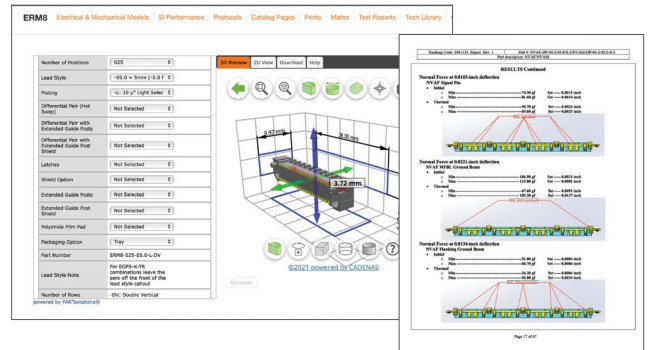

## SOLUTIONATOR®

Quickly build mated connector sets or design full cable assemblies using a wide variety of user-defined search parameters and filters, view specs and order samples in Samtec's online design tools.

### Solutionator **HS** CABLE

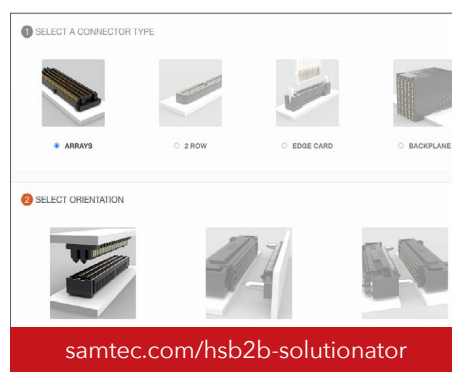

### Solutionator **HS** CABLE

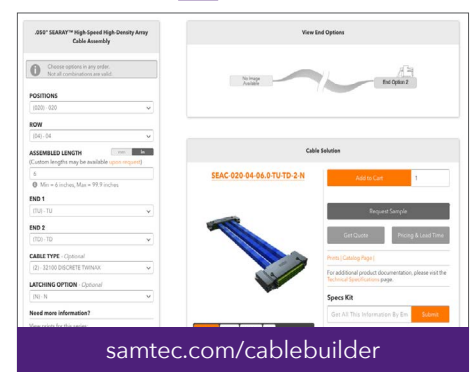

### Solutionator **RF** CABLE

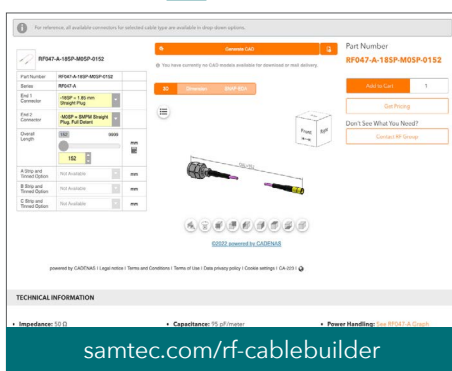

### Solutionator **FLEX** STACKING



### Solutionator **ACTIVE OPTICS**





# INTEGRATION LEADS TO INNOVATION

Samtec's integrated approach provides high-level design and development of advanced interconnect systems and **TECHNOLOGIES**, along with industry-leading expertise that allows us to offer effective strategies and support for **optimizing the entire signal channel of high-performance systems.**

Samtec is structured like no other company in the interconnect industry. We work in a fully integrated capacity that enables true collaboration and results in uniquely innovative **PRODUCTS** because **our technology teams are not limited by the boundaries of traditional business units.**

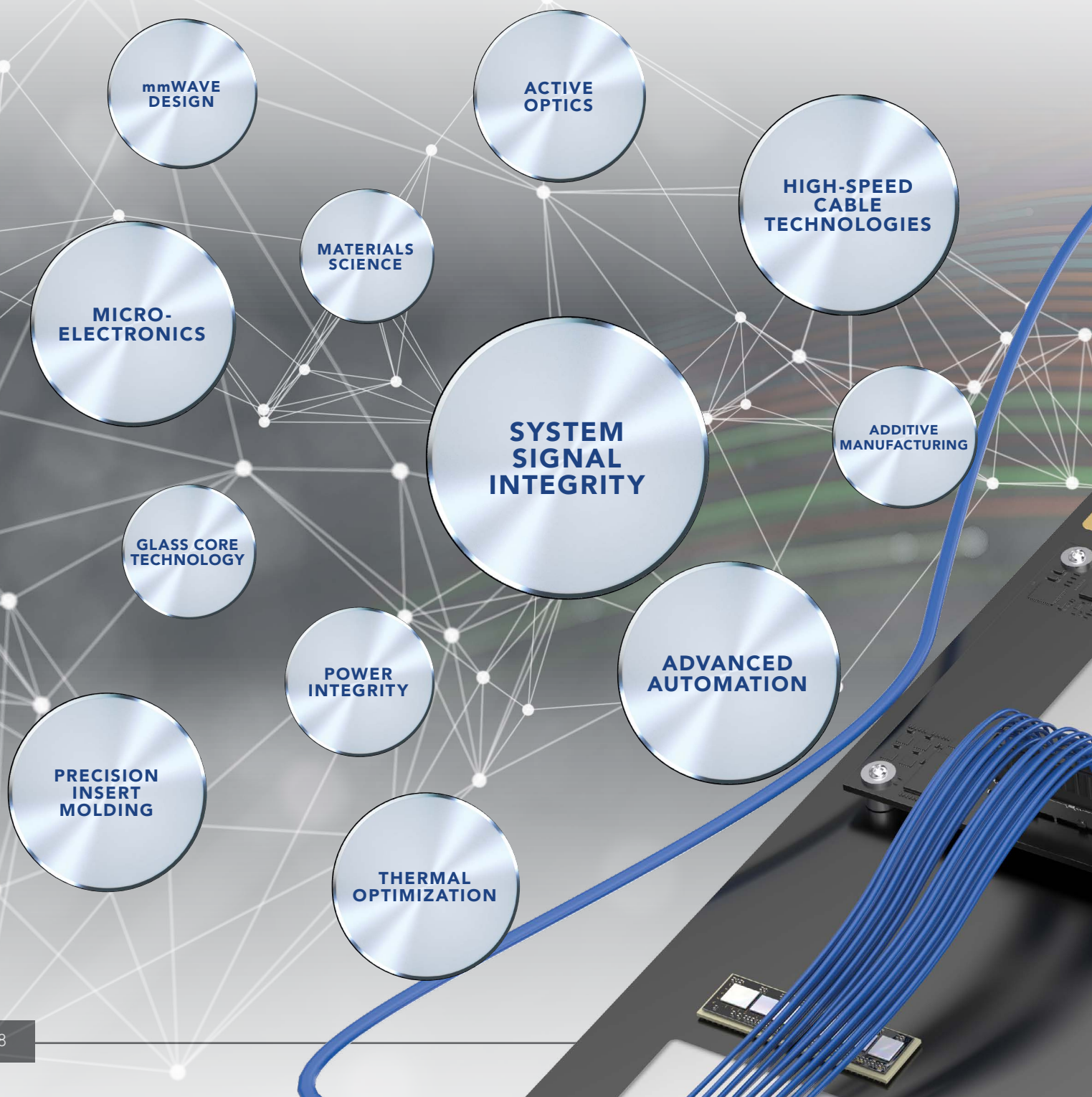



# SILICON-TO-SILICON™ SOLUTIONS

As bandwidth, scale and power requirements continue to challenge conventional engineering methods, we want to help **optimize the landscape of your entire system** - and develop solutions, together.

**Samtec's industry-leading signal integrity expertise**, full system optimization strategies and, innovative products and technologies help address the challenges of next gen data transmission for **a path to 224 Gbps and beyond**.

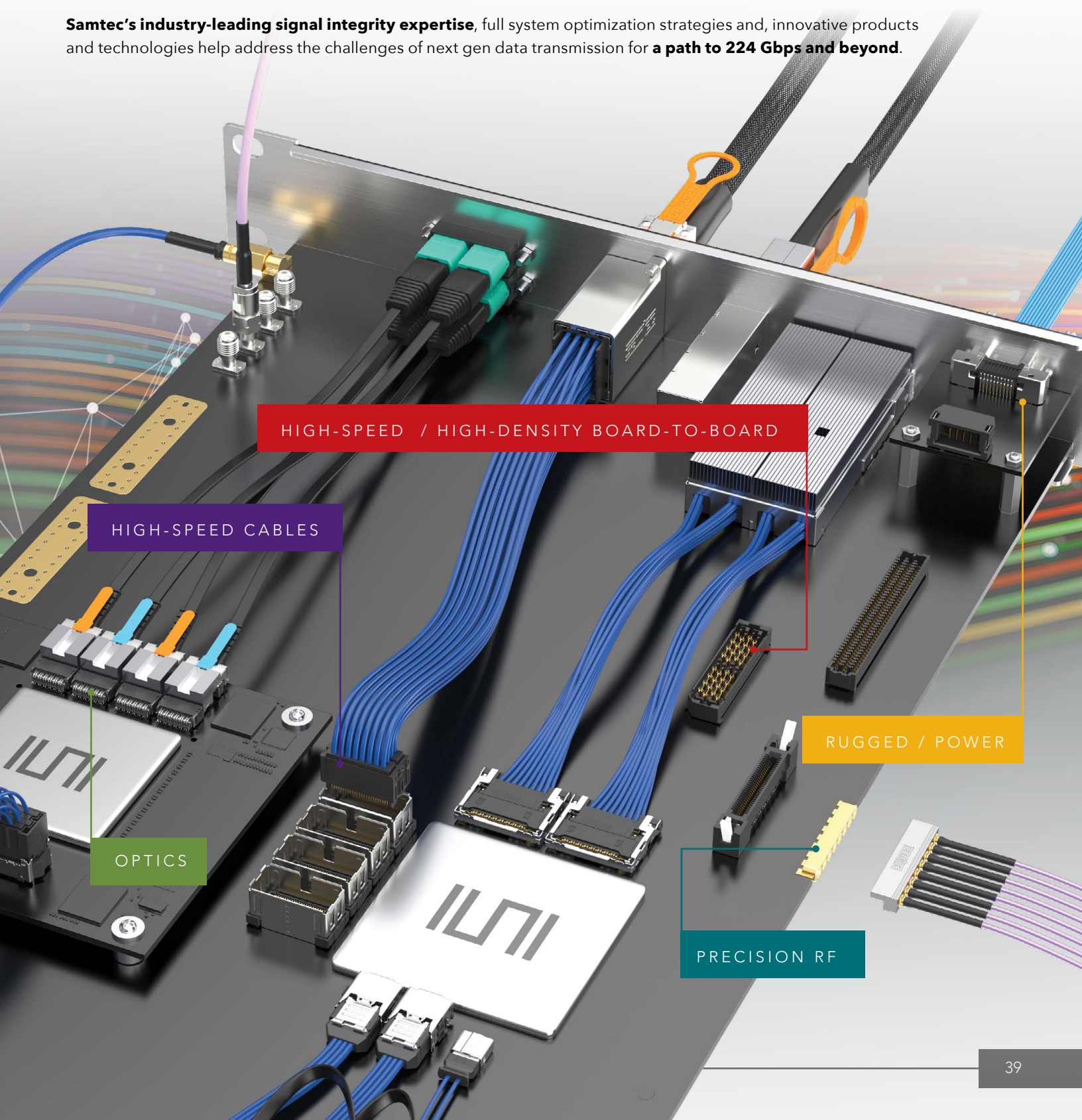

HIGH-SPEED / HIGH-DENSITY BOARD-TO-BOARD

HIGH-SPEED CABLES

OPTICS

RUGGED / POWER

PRECISION RF

# GLOBAL SUPPORT NETWORK

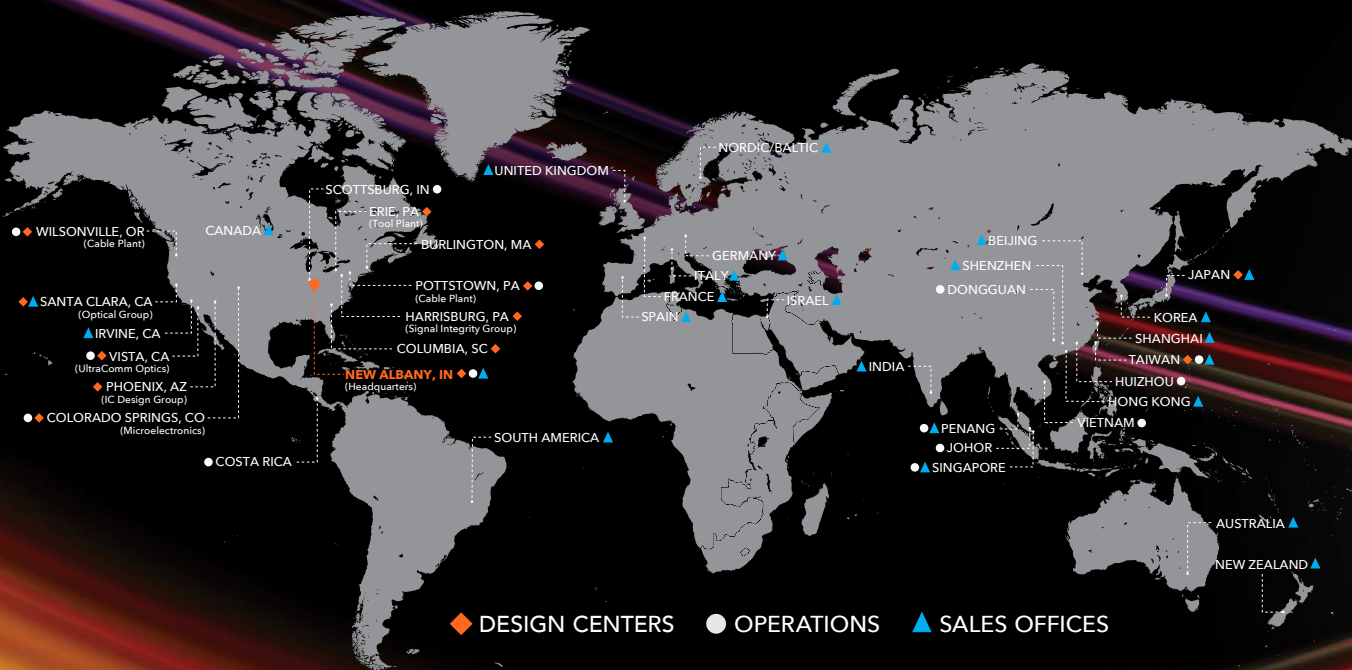

**samtec**  
SUDDEN SERVICE®

[www.samtec.com](http://www.samtec.com)

ISO-9001 and/or IATF 16949 Certified  
© MAY 2023, SAMTEC INC.